

# LM49370 Boomer® Audio Power Amplifier Series Audio Sub-System with an Ultra Low EMI, Spread Spectrum, Class D Loudspeaker Amplifier, a Dual-Mode Stereo Headphone Amplifier, and a Dedicated PCM Interface for Bluetooth Transceivers

 Check for Samples: [LM49370](#)

## FEATURES

- Spread Spectrum Class D Architecture Reduces EMI
- Mono Class D 8Ω Amplifier, 490 mW at 3.3V
- OCL or AC-Coupled Headphone Operation
- 33mW Stereo Headphone Amplifier at 3.3V
- 115 mW Earpiece Amplifier at 3.3V
- 18-bit Stereo DAC
- 16-bit Mono ADC
- 8 kHz to 192 kHz Stereo Audio Playback
- 8 kHz to 48 kHz Mono Recording
- Bidirectional I<sup>2</sup>S Compatible Audio Interface
- Bidirectional PCM Compatible Audio Interface for Bluetooth Transceivers
- I<sup>2</sup>S-PCM Bridge with Sample Rate Conversion
- Sigma-Delta PLL for Operation from Any Clock at Any Sample Rate
- Digital 3D Stereo Enhancement
- FIR Filter Programmability for Simple Tone Control
- Low Power Clock Network Operation if a 12 MHz or 13 MHz System Clock is Available
- Read/Write I<sup>2</sup>C or SPI Compatible Control Interface
- Automatic Headphone & Microphone Detection
- Support for Internal and External Microphones
- Automatic Gain Control for Microphone Input
- Differential Audio I/O for External Cellphone Module
- Mono Differential Auxiliary Output
- Stereo Auxiliary Inputs
- Differential Microphone Input for Internal Microphone
- Flexible Audio Routing from Input to Output
- 32 Step Volume Control for Mixers in 1.5 dB Steps
- 16 Step Volume Control for Microphone in 2 dB Steps
- Programmable Sidetone Attenuation in 3 dB Steps
- Two Configurable GPIO Ports
- Multi-Function IRQ Output
- Micro-Power Shutdown Mode
- Available in the 4 x 4 mm 49 Bump DSBGA Package
- Key Specifications
  - P<sub>HP (AC-COUP)</sub> (A<sub>VDD</sub> = 3.3V, 32Ω, 1% THD) 33 mW
  - P<sub>HP (OCL)</sub> (A<sub>VDD</sub> = 3.3V, 32Ω, 1% THD) 31 mW
  - P<sub>LS</sub> (LS<sub>VDD</sub> = 5V, 8Ω, 1% THD) 1.2 W
  - P<sub>LS</sub> (LS<sub>VDD</sub> = 4.2V, 8Ω, 1% THD) 900 mW
  - P<sub>LS</sub> (LS<sub>VDD</sub> = 3.3V, 8Ω, 1% THD) 490 mW
  - Shutdown Current 0.8 μA
  - PSRR<sub>LS</sub> (217 Hz, LS<sub>VDD</sub> = 3.3V) 70 dB
  - SNR<sub>LS</sub> (AUX IN to Loudspeaker) 90 dB (typ)
  - SNR<sub>DAC</sub> (Stereo DAC to AUXOUT) 85 dB (typ)
  - SNR<sub>ADC</sub> (Mono ADC from Cell Phone In) 90 dB (typ)
  - SNR<sub>HP</sub> (Aux In to Headphones) 98 dB (typ)

## APPLICATIONS

- Smart Phones
- Mobile Phones and Multimedia Terminals
- PDAs, Internet Appliances and Portable Gaming
- Portable DVD/CD/AAC/MP3 Players
- Digital Cameras/Camcorders



Please be aware that an important notice concerning availability, standard warranty, and use in critical applications of Texas Instruments semiconductor products and disclaimers thereto appears at the end of this data sheet.

All trademarks are the property of their respective owners.

## DESCRIPTION

The LM49370 is an integrated audio subsystem that supports both analog and digital audio functions. The LM49370 includes a high quality stereo DAC, a mono ADC, a stereo headphone amplifier, which supports output cap-less (OCL) or AC-coupled (SE) modes of operation, a mono earpiece amplifier, and an ultra-low EMI spread spectrum Class D loudspeaker amplifier. It is designed for demanding applications in mobile phones and other portable devices.

The LM49370 features a bi-directional I<sup>2</sup>S interface and a bi-directional PCM interface for full range audio on either interface. The LM49370 utilizes an I<sup>2</sup>C or SPI compatible interface for control. The stereo DAC path features an SNR of 85 dB with an 18-bit 48 kHz input. In SE mode the headphone amplifier delivers at least 33 mW<sub>RMS</sub> to a 32Ω single-ended stereo load with less than 1% distortion (THD+N) when A\_V<sub>DD</sub> = 3.3V. The mono earpiece amplifier delivers at least 115mW<sub>RMS</sub> to a 32Ω bridged-tied load with less than 1% distortion (THD+N) when A\_V<sub>DD</sub> = 3.3V. The mono speaker amplifier delivers up to 490mW into an 8Ω load with less than 1% distortion when LS\_V<sub>DD</sub> = 3.3V and up to 1.2W when LS\_V<sub>DD</sub> = 5.0V.

The LM49370 employs advanced techniques to reduce power consumption, to reduce controller overhead, to speed development time, and to eliminate click and pop. Boomer audio power amplifiers were designed specifically to provide high quality output power with a minimal amount of external components. It is therefore ideally suited for mobile phone and other low voltage applications where minimal power consumption, PCB area and cost are primary requirements.

## LM49370 Overview

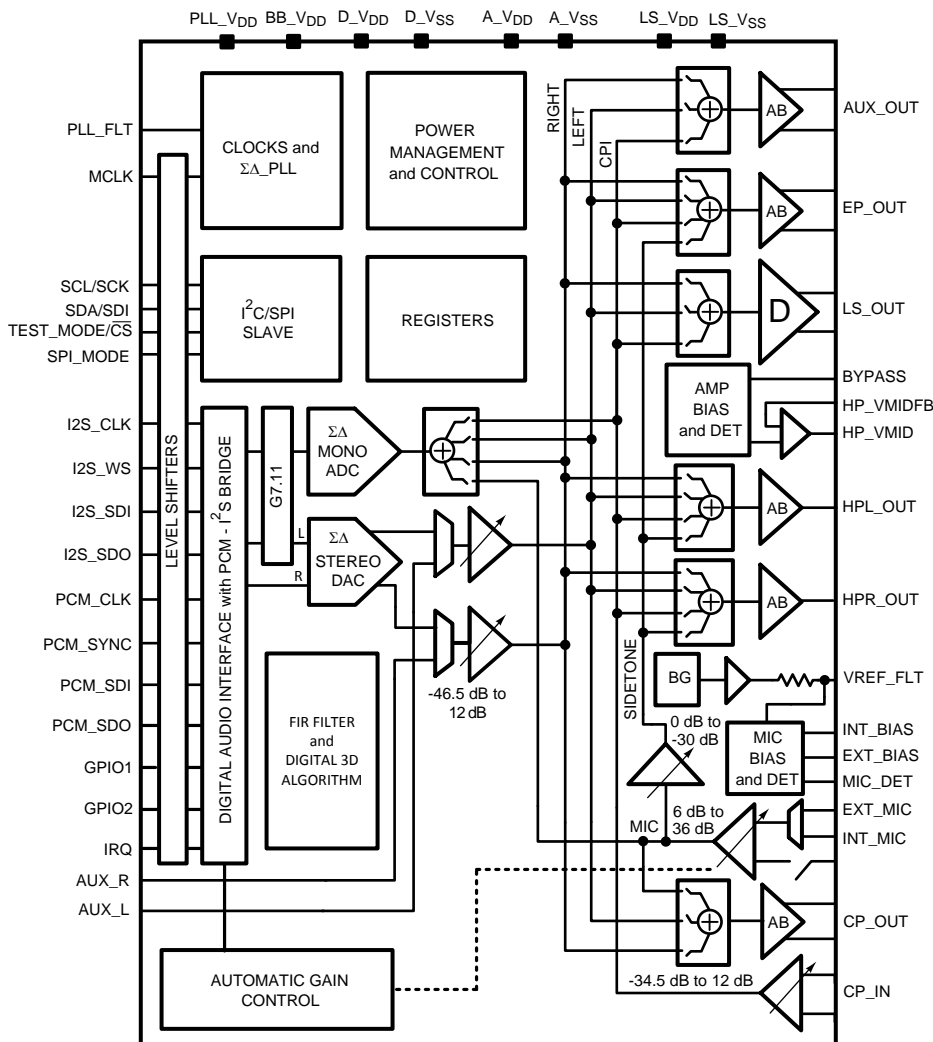

Figure 1. Conceptual Schematic

Typical Application

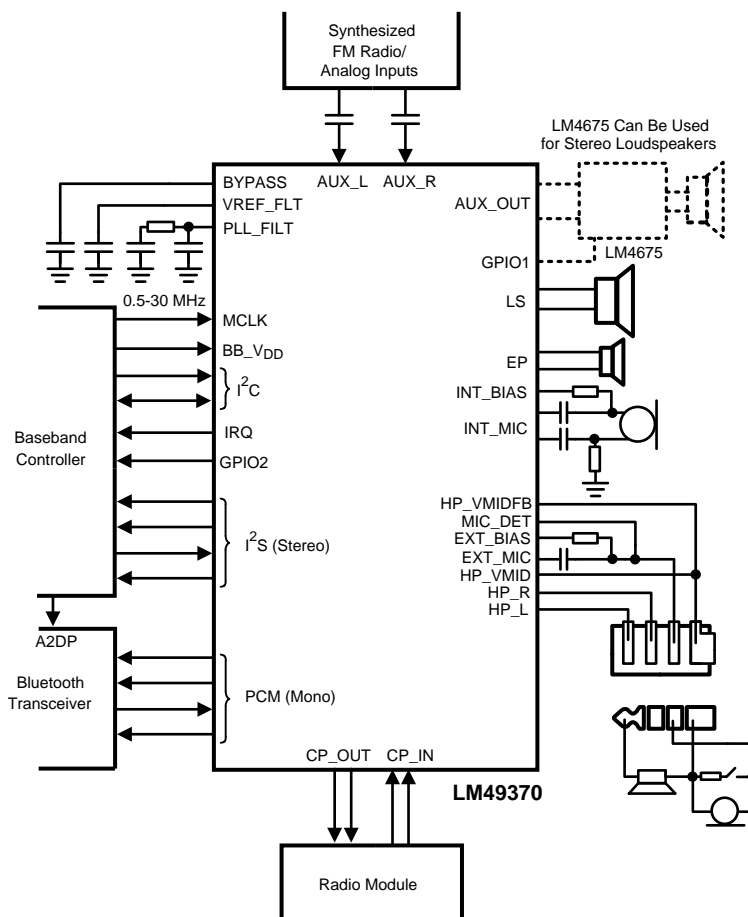

Figure 2. Example Application in Multimedia Mobile Phone

Connection Diagrams

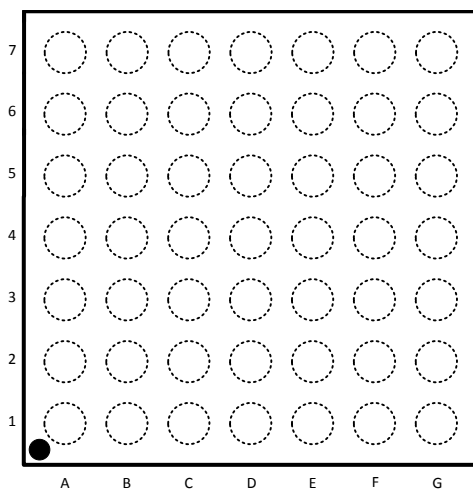

Figure 3. 49 Bump DSBGA  
Top View (Bump Side Down)  
See Package Number YPG0049JUA

## Pin Descriptions

Pin	Pin Name	Type	Direction	Description
A1	EP_NEG	Analog	Output	Earpiece negative output
A2	A_V <sub>DD</sub>	Supply	Input	Headphone and mixer V <sub>DD</sub>
A3	INT_MIC_POS	Analog	Input	Internal microphone positive input
A4	PCM_SDO	Digital	Output	PCM Serial Data Output
A5	PCM_CLK	Digital	Inout	PCM clock signal
A6	PCM_SYNC	Digital	Inout	PCM sync signal
A7	PCM_SDI	Digital	Input	PCM Serial Data Input
B1	A_V <sub>SS</sub>	Supply	Input	Headphone and mixer ground
B2	EP_POS	Analog	Output	Earpiece positive output
B3	INT_MIC_NEG	Analog	Input	Internal microphone negative input
B4	BYPASS	Analog	Input	A_V <sub>DD</sub> /2 filter point
B5	TEST_MODE/ $\overline{\text{CS}}$	Digital	Input	If SPI_MODE = 1, then this pin becomes $\overline{\text{CS}}$ .
B6	PLL_FILT	Analog	Input	Filter point for PLL VCO input
B7	PLL_V <sub>DD</sub>	Supply	Input	PLL V <sub>DD</sub>
C1	HP_R	Analog	Output	Headphone Right Output
C2	EXT_BIAS	Analog	Output	External microphone supply (2.0/2.5/2.8/3.3V)
C3	INT_BIAS	Analog	Output	Internal microphone supply (2.0/2.5/2.8/3.3V)
C4	AUX_R	Analog	Input	Right Analog Input
C5	GPIO_2	Digital	Inout	General Purpose I/O 2
C6	SDA	Digital	Inout	Control Data, I2C_SDA or SPI_SDA
C7	SCL	Digital	Input	Control Clock, I2C_SCL or SPI_SCL
D1	HP_L	Analog	Output	Headphone Left Output
D2	VREF_FLT	Analog	Inout	Filter point for the microphone power supply
D3	EXT_MIC	Analog	Input	External microphone input
D4	SPI_MODE	Digital	Input	Control mode select 1 = SPI, 0 = I2C
D5	GPIO_1	Digital	Inout	General Purpose I/O 1
D6	BB_V <sub>DD</sub>	Supply	Input	Baseband V <sub>DD</sub> for the digital I/Os
D7	D_V <sub>DD</sub>	Supply	Input	Digital V <sub>DD</sub>
E1	HP_VMID	Analog	Inout	Virtual Ground for Headphones in OCL mode, otherwise 1st headset detection input
E2	MIC_DET	Analog	Input	Headset insertion/removal and microphone presence detection input.
E3	AUX_L	Analog	Input	Left Analog Input
E4	CPI_NEG	Analog	Input	Cell Phone analog input negative
E5	IRQ	Digital	Output	Interrupt request signal (NOT open drain)
E6	I2S_SDO	Digital	Output	I2S Serial Data Out

**Pin Descriptions (continued)**

Pin	Pin Name	Type	Direction	Description
E7	I2S_SDI	Digital	Input	I2S Serial Data Input
F1	HP_VMID_FB	Analog	Input	VMID Feedback in OCL mode, otherwise a 2nd headset detection input
F2	LS_V <sub>DD</sub>	Supply	Input	Loudspeaker V <sub>DD</sub>
F3	CPI_POS	Analog	Input	Cell Phone analog input positive
F4	CPO_NEG	Analog	Output	Cell Phone analog output negative
F5	AUX_OUT_NEG	Analog	Output	Auxiliary analog output negative
F6	I2S_WS	Digital	Inout	I2S Word Select Signal (can be master or slave)
F7	I2S_CLK	Digital	Inout	I2S Clock Signal (can be master or slave)
G1	LS_NEG	Analog	Output	Loudspeaker negative output
G2	LS_V <sub>SS</sub>	Supply	Input	Loudspeaker ground
G3	LS_POS	Analog	Output	Loudspeaker positive output
G4	CPO_POS	Analog	Output	Cell Phone analog output positive
G5	AUX_OUT_POS	Analog	Output	Auxiliary analog output positive
G6	D_V <sub>SS</sub>	Supply	Input	Digital ground
G7	MCLK	Digital	Input	Input clock from 0.5 MHz to 30 MHz

**PIN TYPE DEFINITIONS**

**Analog Input**—A pin that is used by the analog and is never driven by the device. Supplies are part of this classification.

**Analog Output**—A pin that is driven by the device and should not be driven by external sources.

**Analog Inout**—A pin that is typically used for filtering a DC signal within the device, Passive components can be connected to these pins.

**Digital Input**—A pin that is used by the digital but is never driven.

**Digital Output**—A pin that is driven by the device and should not be driven by another device to avoid contention.

**Digital Inout**—A pin that is either open drain (I2C\_SDA) or a bidirectional CMOS in/out. In the later case the direction is selected by a control register within the LM49370.



These devices have limited built-in ESD protection. The leads should be shorted together or the device placed in conductive foam during storage or handling to prevent electrostatic damage to the MOS gates.

## Absolute Maximum Ratings <sup>(1)(2)</sup>

Analog Supply Voltage (A_V <sub>DD</sub> & LS_V <sub>DD</sub> )		6.0V
Digital Supply Voltage (BB_V <sub>DD</sub> & D_V <sub>DD</sub> & PLL_V <sub>DD</sub> )		6.0V
Storage Temperature		-65°C to +150°C
Power Dissipation <sup>(3)</sup>		Internally Limited
ESD Susceptibility	Human Body Model <sup>(4)</sup>	2500V
	Machine Model <sup>(5)</sup>	200V
Junction Temperature		150°C
Thermal Resistance θ <sub>JA</sub> – YPG49 (soldered down to PCB with 2in <sup>2</sup> 1oz. copper plane)		60°C/W
Soldering Information		

- All voltages are measured with respect to the relevant V<sub>SS</sub> pin unless otherwise specified. All grounds should be coupled as close as possible to the device.
- Absolute Maximum Ratings indicate limits beyond which damage to the device may occur. Operating Ratings indicate conditions for which the device is functional but do not ensure specific performance limits. Characteristics state DC and AC electrical specifications under particular test conditions which ensure specific performance limits. This assumes that the device is within the Operating Ratings. Specifications are not ensured for parameters where no limit is given, however, the typical value is a good indication of device performance.
- The maximum power dissipation must be de-rated at elevated temperatures and is dictated by T<sub>JMAX</sub>, θ<sub>JA</sub>, and the ambient temperature, T<sub>A</sub>. The maximum allowable power dissipation is P<sub>DMAX</sub> = (T<sub>JMAX</sub> - T<sub>A</sub>) / θ<sub>JA</sub> or the number given in Absolute Maximum Ratings, whichever is lower.
- Human body model: 100pF discharged through a 1.5kΩ resistor.
- Machine model: 220pF – 240pF discharged through all pins.

## Operating Ratings

Temperature Range		-40°C to +85°C
Supply Voltage	D_V <sub>DD</sub> /PLL_V <sub>DD</sub>	2.5V to 4.5V
	BB_V <sub>DD</sub>	1.8V to 4.5V
	LS_V <sub>DD</sub> = A_V <sub>DD</sub> <sup>(1)</sup>	2.5V to 5.5V

- LS\_V<sub>DD</sub> must be equal to A\_V<sub>DD</sub> due to intend ESD diode structure. For proper operation, LS\_V<sub>DD</sub> and A\_V<sub>DD</sub> need to be the highest voltage than BB\_V<sub>DD</sub>, D\_V<sub>DD</sub>, and PLL\_V<sub>DD</sub> and must be applied first.

## Electrical Characteristics <sup>(1)(2)</sup>

Unless otherwise stated **PLL\_V<sub>DD</sub> = 3.3V, D\_V<sub>DD</sub> = 3.3V, BB\_V<sub>DD</sub> = 1.8V, A\_V<sub>DD</sub> = 3.3V, LS\_V<sub>DD</sub> = 3.3V**. The following specifications apply for the circuit shown in [Figure 2](#) unless otherwise stated. Limits apply for 25°C.

Symbol	Parameter	Conditions	LM49370		Units
			Typical <sup>(3)</sup>	Limit <sup>(4)(5)</sup>	
<b>POWER</b>					
DI <sub>SD</sub>	Digital Shutdown Current <sup>(6)</sup>	Chip Mode '00', f <sub>MCLK</sub> = 13MHz	0.7	2.2	μA (max)
DI <sub>ST</sub>	Digital Standby Current	Chip Mode '01', f <sub>MCLK</sub> = 13MHz	0.9	1.8	mA(max)
AI <sub>SD</sub>	Analog Shutdown Current	Chip Mode '00'	0.1	1.2	μA(max)
AI <sub>ST</sub>	Analog Standby Current	Chip Mode '01'	0.1	1.2	μA (max)

- Absolute Maximum Ratings indicate limits beyond which damage to the device may occur. Operating Ratings indicate conditions for which the device is functional but do not ensure specific performance limits. Characteristics state DC and AC electrical specifications under particular test conditions which ensure specific performance limits. This assumes that the device is within the Operating Ratings. Specifications are not ensured for parameters where no limit is given, however, the typical value is a good indication of device performance.
- All voltages are measured with respect to the relevant V<sub>SS</sub> pin unless otherwise specified. All grounds should be coupled as close as possible to the device.
- Typical values are measured at 25°C and represent the parametric norm.
- Limits are specified to TI's AOQL (Average Outgoing Quality Level).
- Datasheet min/max specification limits are specified by design, test, or statistical analysis.
- Digital shutdown current is measured with system clock set for PLL output while the PLL is disabled.

**Electrical Characteristics <sup>(1)(2)</sup> (continued)**

Unless otherwise stated **PLL\_V<sub>DD</sub> = 3.3V, D\_V<sub>DD</sub> = 3.3V, BB\_V<sub>DD</sub> = 1.8V, A\_V<sub>DD</sub> = 3.3V, LS\_V<sub>DD</sub> = 3.3V**. The following specifications apply for the circuit shown in [Figure 2](#) unless otherwise stated. Limits apply for 25°C.

Symbol	Parameter	Conditions	LM49370		Units
			Typical <sup>(3)</sup>	Limit <sup>(4)</sup> (5)	
	Digital Playback Mode Digital Active Current	Chip Mode '10', f <sub>MCLK</sub> = 12MHz, f <sub>S</sub> = 48kHz, DAC on; PLL off	7.9		mA
		Chip Mode '10', f <sub>MCLK</sub> = 13MHz, f <sub>PLLOUT</sub> = 12MHz, f <sub>S</sub> = 48kHz; DAC + PLL on	12.5	14.5	mA(max)
	Digital Playback Mode Analog Active Current	Chip Mode '10', HP On, SE mode, DAC inputs selected	9.0	13.5	mA(max)
		Chip Mode '10', HP On, OCL mode, DAC inputs selected	9.4	13.5	mA(max)
		Chip Mode '10', LS On, DAC inputs selected	11.5	15.5	mA(max)
	Analog Playback Mode Digital Active Current	Chip Mode '10', f <sub>MCLK</sub> = 13MHz, DAC +ADC + PLL off	0.9	1.8	mA(max)
	Analog Playback Mode Analog Active Current	Chip Mode '10', HP On, SE mode, AUX inputs selected	5.9	9.5	mA(max)
		Chip Mode '10', HP On, OCL mode, AUX inputs selected	6.3	9.7	mA(max)
		Chip Mode '10', LS On, AUX inputs selected	8.4	12	mA(max)
	CODEC Mode Digital Active Current	Chip Mode '10', f <sub>MCLK</sub> = 13MHz, f <sub>S</sub> = 8kHz, DAC +ADC on; PLL Off	2.7	3.5	mA(max)
	CODEC Mode Analog Active Current	Chip Mode '10', EP On, DAC inputs selected	11.2	15.5	mA(max)
	Voice Module Mode Digital Active Current	Chip Mode '10', f <sub>MCLK</sub> = 13MHz, DAC +ADC + PLL off	0.9	1.8	mA(max)
	Voice Module Mode Analog Active Current	Chip Mode '10', EP + CPOUT on, CPIN input selected	7.4	11	mA(max)
<b>LOUDSPEAKER AMPLIFIER</b>					
P <sub>LS</sub>	Max Loudspeaker Power	8Ω load, LS_V <sub>DD</sub> = 5V	1.2		W
		8Ω load, LS_V <sub>DD</sub> = 4.2V	0.9		W
		8Ω load, LS_V <sub>DD</sub> = 3.3V	0.5	0.43	W (min)
LS <sub>THD+N</sub>	Loudspeaker Harmonic Distortion	8Ω load, LS_V <sub>DD</sub> = 3.3V, P <sub>O</sub> = 400mW	0.04		%
LS <sub>EFF</sub>	Efficiency	0 dB Input MCLK = 12.000 MHz	84		%
PSRR <sub>LS</sub>	Power Supply Rejection Ration (Loudspeaker)	AUX inputs terminated C <sub>BYPASS</sub> = 1.0 μF V <sub>RIPPLE</sub> = 200 mV <sub>P-P</sub> f <sub>RIPPLE</sub> = 217 Hz	70		dB
SNR <sub>LS</sub>	Signal to Noise Ratio	From 0 dB Analog AUX input, A-weighted	90	80	dB(min)
e <sub>N</sub>	Output Noise <sup>(7)</sup>	A-weighted	62		μV
V <sub>OS</sub>	Loudspeaker Offset Voltage		12		mV

(7) Disabling or bypassing the PLL will usually result in an improvement in noise measurements.

**Electrical Characteristics** <sup>(1)(2)</sup> (continued)

Unless otherwise stated **PLL\_V<sub>DD</sub> = 3.3V, D\_V<sub>DD</sub> = 3.3V, BB\_V<sub>DD</sub> = 1.8V, A\_V<sub>DD</sub> = 3.3V, LS\_V<sub>DD</sub> = 3.3V**. The following specifications apply for the circuit shown in [Figure 2](#) unless otherwise stated. Limits apply for 25°C.

Symbol	Parameter	Conditions	LM49370		Units
			Typical <sup>(3)</sup>	Limit <sup>(4)</sup> <sup>(5)</sup>	
<b>HEADPHONE AMPLIFIER</b>					
P <sub>HP</sub>	Headphone Power	32Ω load, 3.3V, SE	33	25	mW (min)
		16Ω load, 3.3V, SE	52		mW
		32Ω load, 3.3V, OCL, VCM = 1.5V	31		mW
		32Ω load, 3.3V, OCL, VCM = 1.2V	20		mW
		16Ω load, 3.3V, OCL, VCM = 1.5V	50		mW
		16Ω load, 3.3V, OCL, VCM = 1.2V	32		mW
PSRR <sub>HP</sub>	Power Supply Rejection Ratio (Headphones)	AUX inputs terminated C <sub>BYPASS</sub> = 1.0 μF V <sub>RIPPLE</sub> = 200 mV <sub>P-P</sub> f <sub>RIPPLE</sub> = 217 Hz			
		SE Mode	60		dB
		OCL Mode VCM = 1.2V	68	55	dB(min)
SNR <sub>HP</sub>	Signal to Noise Ratio	From 0dB Analog AUX input A-weighted			
		SE Mode	98		dB
		OCL Mode VCM = 1.2V	97		dB
HP <sub>THD+N</sub>	Headphone Harmonic Distortion	OCL Mode VCM = 1.5V	96		dB
		32Ω load, 3.3V, P <sub>O</sub> = 7.5mW	0.05		%
e <sub>N</sub>	Output Noise	A-weighted	12		μV
ΔA <sub>CH-CH</sub>	Stereo Channel-to-Channel Gain Mismatch		0.3		dB
X <sub>TALK</sub>	Stereo Crosstalk	SE Mode	61		dB
		OCL Mode	71		dB
V <sub>OS</sub>	Offset Voltage		8		mV
<b>EARPIECE AMPLIFIER</b>					
P <sub>EP</sub>	Earpiece Power	32Ω load, 3.3V	115	100	mW (min)
		16Ω load, 3.3V	150		mW
PSRR <sub>EP</sub>	Power Supply Rejection Ratio (Earpiece)	CP_IN terminated C <sub>BYPASS</sub> = 1.0 μF V <sub>RIPPLE</sub> = 200 mV <sub>P-P</sub> f <sub>RIPPLE</sub> = 217 Hz	76		dB
SNR <sub>EP</sub>	Signal to Noise Ratio	From 0dB Analog AUX input, A-weighted	93		dB
EP <sub>THD+N</sub>	Earpiece Harmonic Distortion	32Ω load, 3.3V, P <sub>O</sub> = 50mW	0.04		%
e <sub>N</sub>	Output Noise	A-weighted	41		μV
V <sub>OS</sub>	Offset Voltage		8		mV
<b>AUXOUT AMPLIFIER</b>					
THD+N	Total Harmonic Distortion + Noise	V <sub>O</sub> = 1V <sub>RMS</sub> , 5kΩ load	0.02		%
PSRR	Power Supply Rejection Ratio	CP_IN terminated C <sub>BYPASS</sub> = 1.0μF V <sub>RIPPLE</sub> = 200mVPP f <sub>RIPPLE</sub> = 217Hz	86		dB



**Electrical Characteristics <sup>(1)(2)</sup> (continued)**

Unless otherwise stated **PLL\_V<sub>DD</sub> = 3.3V, D\_V<sub>DD</sub> = 3.3V, BB\_V<sub>DD</sub> = 1.8V, A\_V<sub>DD</sub> = 3.3V, LS\_V<sub>DD</sub> = 3.3V**. The following specifications apply for the circuit shown in [Figure 2](#) unless otherwise stated. Limits apply for 25°C.

Symbol	Parameter	Conditions	LM49370		Units
			Typical <sup>(3)</sup>	Limit <sup>(4)</sup> <sub>(5)</sub>	
<b>CP_OUT AMPLIFIER</b>					
THD+N	Total Harmonic Distortion + Noise	V <sub>O</sub> = 1V <sub>RMS</sub> , 5kΩ load	0.02		%
PSRR	Power Supply Rejection Ratio	C <sub>BYPASS</sub> = 1.0μF V <sub>RIPPLE</sub> = 200mVPP f <sub>RIPPLE</sub> = 217Hz	86		dB
<b>MONO ADC</b>					
R <sub>ADC</sub>	ADC Ripple		±0.25		dB
PB <sub>ADC</sub>	ADC Passband	Lower (HPF Mode 1), f <sub>S</sub> = 8 kHz	300		Hz
		Upper	3470		Hz
SBA <sub>ADC</sub>	ADC Stopband Attenuation	Above Passband	60		dB
		HPF Notch, 50 Hz/60 Hz (worst case)	58		dB
SNR <sub>ADC</sub>	ADC Signal to Noise Ratio	From CPI, A-weighted	90		dB
ADC <sub>LEVEL</sub>	ADC Full Scale Input Level		1		V <sub>RMS</sub>
<b>STEREO DAC</b>					
R <sub>DAC</sub>	DAC Ripple		0.1		dB
PB <sub>DAC</sub>	DAC Passband		20		kHz
SBA <sub>DAC</sub>	DAC Stopband Attenuation		70		dB
SNR <sub>DAC</sub>	DAC Signal to Noise Ratio	A-weighted, AUXOUT	85		dB
DR <sub>DAC</sub>	DAC Dynamic Range		96		dB
DAC <sub>LEVEL</sub>	DAC Full Scale Output Level		1		V <sub>RMS</sub>
<b>PLL <sup>(8)</sup></b>					
F <sub>IN</sub>	Input Frequency Range	Min		0.5	MHz
		Max		30	MHz
<b>I2S/PCM</b>					
f <sub>I2SCLK</sub>	I2S CLK Frequency	f <sub>S</sub> = 48kHz; 16 bit mode	1.536		MHz
		f <sub>S</sub> = 48kHz; 25 bit mode	2.4		MHz
		f <sub>S</sub> = 8kHz; 16 bit mode	0.256		MHz
		f <sub>S</sub> = 8kHz; 25 bit mode	0.4		MHz
f <sub>PCMCLK</sub>	PCM CLK Frequency	f <sub>S</sub> = 48kHz; 16 bit mode	0.768		MHz
		f <sub>S</sub> = 48kHz; 25 bit mode	1.2		MHz
		f <sub>S</sub> = 8kHz; 16 bit mode	0.128		MHz
		f <sub>S</sub> = 8kHz; 25 bit mode	0.2		MHz
DC <sub>I2S_CLK</sub>	I2S_CLK Duty Cycle	Min		40	% (min)
		Max		60	% (max)
DC <sub>I2S_WS</sub>	I2S_WS Duty Cycle		50		%
<b>I2C</b>					
T <sub>I2CSET</sub>	I2C Data Setup Time	Refer to <a href="#">TRANSFERRING DATA</a> for more details		100	ns (min)
T <sub>I2CHOLD</sub>	I2C Data Hold Time	Refer to <a href="#">TRANSFERRING DATA</a> for more details		300	ns (min)
<b>SPI</b>					
T <sub>SPISETENB</sub>	Enable Setup Time			100	ns (min)
T <sub>SPIHOLD-ENB</sub>	Enable Hold Time			100	ns (min)
T <sub>SPISETD</sub>	Data Setup Time			100	ns (min)

(8) Disabling or bypassing the PLL will usually result in an improvement in noise measurements.

## Electrical Characteristics <sup>(1)(2)</sup> (continued)

Unless otherwise stated **PLL\_V<sub>DD</sub> = 3.3V, D\_V<sub>DD</sub> = 3.3V, BB\_V<sub>DD</sub> = 1.8V, A\_V<sub>DD</sub> = 3.3V, LS\_V<sub>DD</sub> = 3.3V**. The following specifications apply for the circuit shown in [Figure 2](#) unless otherwise stated. Limits apply for 25°C.

Symbol	Parameter	Conditions	LM49370		Units
			Typical <sup>(3)</sup>	Limit <sup>(4)(5)</sup>	
T <sub>SPIHOLDD</sub>	Data Hold Time			100	ns (min)
T <sub>SPICL</sub>	Clock Low Time			500	ns (min)
T <sub>SPICH</sub>	Clock High Time			500	ns (min)
<b>VOLUME CONTROL</b>					
VCR <sub>AUX</sub>	AUX Volume Control Range	Minimum Gain w/ AUX_BOOST OFF	-46.5		dB
		Maximum Gain w/ AUX_BOOST OFF	0		dB
		Minimum Gain w/ AUX_BOOST ON	-34.5		dB
		Maximum Gain w/ AUX_BOOST ON	12		dB
VCR <sub>DAC</sub>	DAC Volume Control Range	Minimum Gain w/ DAC_BOOST OFF	-46.5		dB
		Maximum Gain w/ DAC_BOOST OFF	0		dB
		Minimum Gain w/ DAC_BOOST ON	-34.5		dB
		Maximum Gain w/ DAC_BOOST ON	12		dB
VCR <sub>CPIN</sub>	CPIN Volume Control Range	Minimum Gain	-34.5		dB
		Maximum Gain	12		dB
VCR <sub>MIC</sub>	MIC Volume Control Range	Minimum Gain	6		dB
		Maximum Gain	36		dB
VCR <sub>SIDE</sub>	SIDETONE Volume Control Range	Minimum Gain	-30		dB
		Maximum Gain	0		dB
SS <sub>AUX</sub>	AUX VCR Stepsize		1.5		dB
SS <sub>DAC</sub>	DAC VCR Stepsize		1.5		dB
SS <sub>CPIN</sub>	CPIN VCR Stepsize		1.5		dB
SS <sub>MIC</sub>	MIC VCR Stepsize		2		dB
SS <sub>SIDE</sub>	SIDETONE VCR Stepsize		3		dB
<b>AUDIO PATH GAIN W/ STEREO (bit 6 of 0x00h) ENABLED (AUX_L &amp; AUX_R signals identical and selected onto mixer)</b>					
	Loudspeaker Audio Path Gain	Minimum Gain from AUX input, BOOST OFF	-34.5		dB
		Maximum Gain from AUX input, BOOST OFF	12		dB
		Minimum Gain from CPI input	-22.5		dB
		Maximum Gain from CPI input	24		dB
	Headphone Audio Path Gain	Minimum Gain from AUX input, BOOST OFF	-52.5		dB
		Maximum Gain from AUX input, BOOST OFF	-6		dB
		Minimum Gain from CPI input	-40.5		dB
		Maximum Gain from CPI input	6		dB
		Minimum Gain from MIC input using SIDETONE path w/ VCR <sub>MIC</sub> gain = 6dB	-30		dB
		Maximum Gain from MIC input using SIDETONE path w/ VCR <sub>MIC</sub> gain = 6dB	0		dB

**Electrical Characteristics <sup>(1)(2)</sup> (continued)**

Unless otherwise stated **PLL\_V<sub>DD</sub> = 3.3V, D\_V<sub>DD</sub> = 3.3V, BB\_V<sub>DD</sub> = 1.8V, A\_V<sub>DD</sub> = 3.3V, LS\_V<sub>DD</sub> = 3.3V**. The following specifications apply for the circuit shown in [Figure 2](#) unless otherwise stated. Limits apply for 25°C.

Symbol	Parameter	Conditions	LM49370		Units
			Typical <sup>(3)</sup>	Limit <sup>(4)</sup> (5)	
	Earpiece Audio Path Gain	Minimum Gain from AUX input, BOOST OFF	-40.5		dB
		Maximum Gain from AUX input, BOOST OFF	6		dB
		Minimum Gain from CPI input	-28.5		dB
		Maximum Gain from CPI input	18		dB
		Minimum Gain from MIC input using SIDETONE path w/ VCR <sub>MIC</sub> gain = 6dB	-18		dB
		Maximum Gain from MIC input using SIDETONE path w/ VCR <sub>MIC</sub> gain = 6dB	12		dB
	AUXOUT Audio Path Gain	Minimum Gain from AUX input, BOOST OFF	-46.5		dB
		Maximum Gain from AUX input, BOOST OFF	0		dB
		Minimum Gain from CPI input	-34.5		dB
		Maximum Gain from CPI input	12		dB
	CPOUT Audio Path Gain	Minimum Gain from AUX input, BOOST OFF	-46.5		dB
		Maximum Gain from AUX input, BOOST OFF	0		dB
		Minimum Gain from MIC input	6		dB
		Maximum Gain from MIC input	36		dB
<b>Total DC Power Dissipation</b>					
	Digital Playback Mode Power Dissipation	DAC (f <sub>S</sub> = 48kHz) and HP ON			
		f <sub>MCLK</sub> = 12MHz, PLL OFF	56		mW
		f <sub>MCLK</sub> = 13MHz, PLL ON f <sub>PLLOUT</sub> = 12MHz	71		mW
	Analog Playback Mode Power Dissipation	AUX Inputs selected and HP ON			
		f <sub>MCLK</sub> = 13MHz, PLL OFF	22		mW
	VOICE CODEC Mode Power Dissipation	PCM DAC (f <sub>S</sub> = 8kHz) + ADC (f <sub>S</sub> = 8kHz) and EP ON			
		f <sub>MCLK</sub> = 13MHz, PLL OFF	46		mW
	VOICE Module Mode Power Dissipation	CP IN selected. EP and CPOUT ON			
		f <sub>MCLK</sub> = 13MHz, PLL OFF	27		mW

## System Control

### Method 1. I<sup>2</sup>C Compatible Interface

#### I<sup>2</sup>C SIGNALS

In I<sup>2</sup>C mode the LM49370 pin SCL is used for the I<sup>2</sup>C clock SCL and the pin SDA is used for the I<sup>2</sup>C data signal SDA. Both these signals need a pull-up resistor according to I<sup>2</sup>C specification. The I<sup>2</sup>C slave address for LM49370 is **0011010<sub>2</sub>**.

#### I<sup>2</sup>C DATA VALIDITY

The data on SDA line must be stable during the HIGH period of the clock signal (SCL). In other words, state of the data line can only be changed when SCL is LOW.

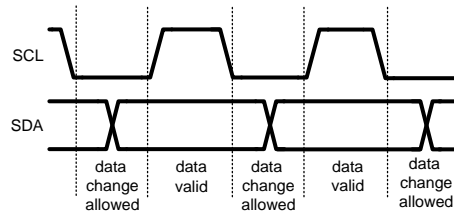
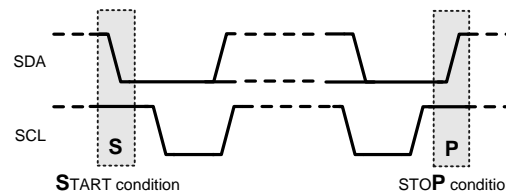

Figure 4. I<sup>2</sup>C Signals: Data Validity

#### I<sup>2</sup>C START AND STOP CONDITIONS

START and STOP bits classify the beginning and the end of the I<sup>2</sup>C session. START condition is defined as SDA signal transitioning from HIGH to LOW while SCL line is HIGH. STOP condition is defined as the SDA transitioning from LOW to HIGH while SCL is HIGH. The I<sup>2</sup>C master always generates START and STOP bits. The I<sup>2</sup>C bus is considered to be busy after START condition and free after STOP condition. During data transmission, I<sup>2</sup>C master can generate repeated START conditions. First START and repeated START conditions are equivalent, function-wise.



#### TRANSFERRING DATA

Every byte put on the SDA line must be eight bits long, with the most significant bit (MSB) being transferred first. Each byte of data has to be followed by an acknowledge bit. The acknowledge related clock pulse is generated by the master. The transmitter releases the SDA line (HIGH) during the acknowledge clock pulse. The receiver must pull down the SDA line during the 9<sup>th</sup> clock pulse, signifying an acknowledge. A receiver which has been addressed must generate an acknowledge after each byte has been received.

After the START condition, the I<sup>2</sup>C master sends a chip address. This address is seven bits long followed by an eight bit which is a data direction bit (R/W). The LM49370 address is **0011010<sub>2</sub>**. For the eighth bit, a "0" indicates a WRITE and a "1" indicates a READ. The second byte selects the register to which the data will be written. The third byte contains data to write to the selected register.

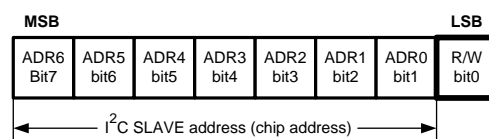
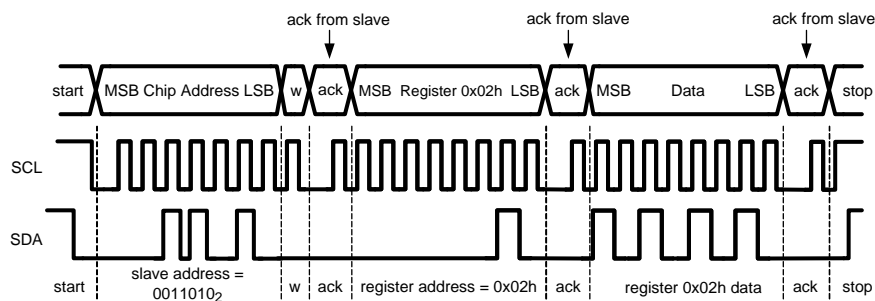

Figure 5. I<sup>2</sup>C Chip Address

Register changes take an effect at the SCL rising edge during the last ACK from slave.



w = write (SDA = "0")  
r = read (SDA = "1")  
ack = acknowledge (SDA pulled down by slave)  
rs = repeated start

Figure 6. Example I<sup>2</sup>C Write Cycle

When a READ function is to be accomplished, a WRITE function must precede the READ function, as shown in the Read Cycle waveform.

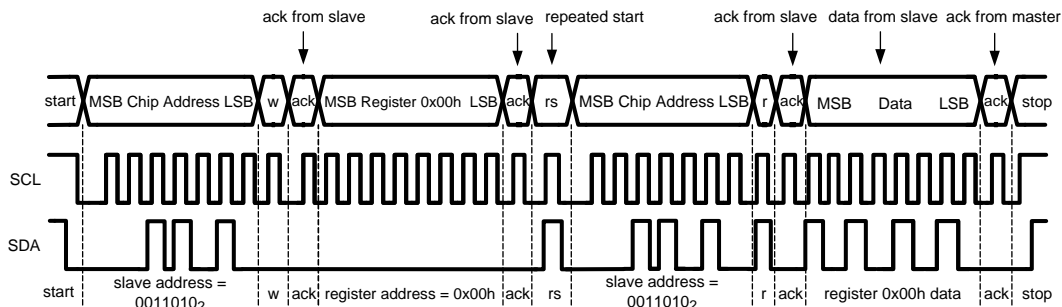

Figure 7. Example I<sup>2</sup>C Read Cycle

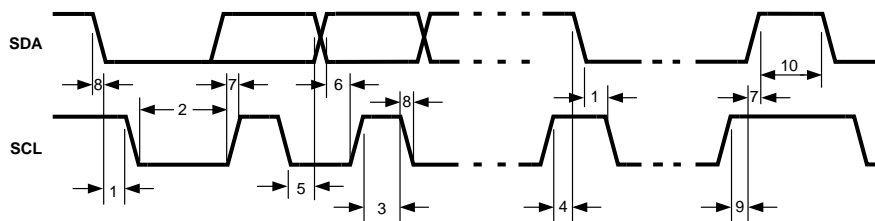

Figure 8. I<sup>2</sup>C Timing Diagram

### I<sup>2</sup>C TIMING PARAMETERS

Symbol	Parameter <sup>(1)</sup>	Limit		Units
		Min	Max	
1	Hold Time (repeated) START Condition	0.6		μs
2	Clock Low Time	1.3		μs
3	Clock High Time	600		ns
4	Setup Time for a Repeated START Condition	600		ns

(1) Data specified by design

5	Data Hold Time (Output direction, delay generated by LM49370)	300	900	ns
5	Data Hold Time (Input direction, delay generated by the Master)	0	900	ns
6	Data Setup Time	100		ns
7	Rise Time of SDA and SCL	$20+0.1C_b$	300	ns
8	Fall Time of SDA and SCL	$15+0.1C_b$	300	ns
9	Set-up Time for STOP condition	600		ns
10	Bus Free Time between a STOP and a START Condition	1.3		$\mu$ s
$C_b$	Capacitive Load for Each Bus Line	10	200	pF

**Method 2. SPI/Microwire Control/3-wire Control**

The LM49370 can be controlled via a three wire interface consisting of a clock, data and an active low chip\_select. To use this control method connect SPI\_MODE to BB\_V<sub>DD</sub> and use TEST\_MODE/CS as the chip\_select as follows:

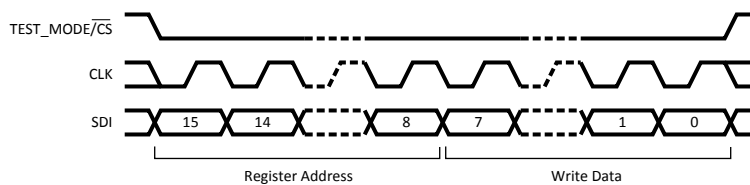

**Figure 9. SPI Write Transaction**

If the application requires read access to the register set; for example to determine the cause of an interrupt request, the GPIO2 pin can be configured as an SPI format serial data output by setting the GPIO\_SEL in the GPIO configuration register (0x1Ah) to SPI\_SDO. To perform a read rather than a write to a particular address the MSB of the register address field is set to a 1, this effectively mirrors the contents of the register field to read-only locations above 0x80h:

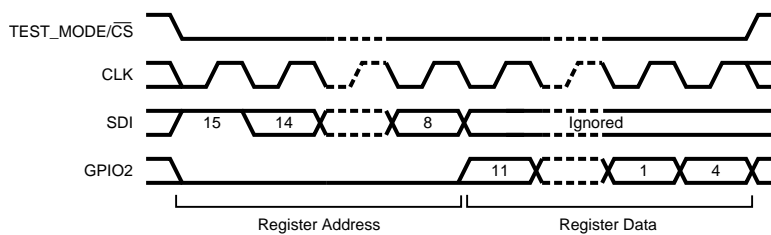

**Figure 10. SPI Read Transaction**

**Figure 11. Three Wire Mode Write Bus Timing**

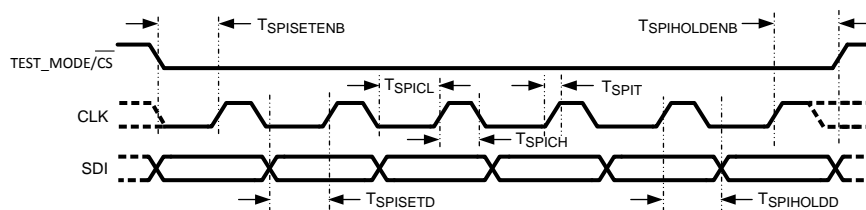

**Figure 12. SPI Timing**

**Status & Control Registers**
**Table 1. Register Map<sup>(1)</sup>**

Address	Register	7	6	5	4	3	2	1	0	
0x00h	Table 2 BASIC	DAC_MODE		CAP_SIZE		OSC_ENB	PLL_ENB	CHP_MODE		
0x01h	Table 3 CLOCKS	R_DIV						DAC_CLK_SEL		
0x02h		FORCERQ	PLL_M							
0x03h	PLL_N	PLL_N								
0x04h	PLL_P	VCOFATS	Q_DIV			PLL_P				
0x05h	PLL_MOD	PLLTEST	PLL_CLK_SEL		PLL_N_MOD					
0x06h	ADC_1	HPF_MODE		SAMPLE_RATE		RIGHT	LEFT	CPI	MIC	
0x07h	ADC_2	NGZXDD	ADC_CLK_SEL		PEAKTIME			ADC MUTE	ADC_MODE	
0x08h	AGC_1	NOISE_GATE_THRESHOLD			NG_ENB	AGC_TARGET			AGC_ENB	
0x09h	AGC_2	AGC_TIGHT	AGC_DECAY			AGC_MAX_GAIN				
0x0Ah	AGC_3	AGC_ATTACK			AGC_HOLD_TIME					
0x0Bh	MIC_1		INT_EXT	SE_DIFF	MUTE	PREAMP_GAIN				
0x0Ch	MIC_2			BTN_DEBOUNCE_TIME		BTNTYPE	MIC_BIAS_VOLTAGE		VCMVOLT	
0x0Dh	SIDETONE					SIDETONE_ATTEN				
0x0Eh	CP_INPUT			MUTE	CPI_LEVEL					
0x0Fh	AUX_LEFT	AUX_DAC	MUTE	BOOST	AUX_LEFT_LEVEL					
0x10h	AUX_RIGHT	AUX_DAC	MUTE	BOOST	AUX_RIGHT_LEVEL					
0x11h	DAC	USAXLVL	DACMUTE	BOOST	DAC_LEVEL					
0x12h	CP_OUTPUT				MICGATE	MUTE	LEFT	RIGHT	MIC	
0x13h	AUX_OUTPUT					MUTE	LEFT	RIGHT	CPI	
0x14h	LS_OUTPUT					MUTE	LEFT	RIGHT	CPI	
0x15h	HP_OUTPUT		OCL	STEREO	MUTE	LEFT	RIGHT	CPI	SIDE	
0x16h	EP_OUTPUT				MUTE	LEFT	RIGHT	CPI	SIDE	
0x17h	DETECT		HS_DBNC_TIME				TEMP_INT	BTN_INT	DET_INT	
0x18h	STATUS		GPIN1	GPIN2	TEMP	BTN	MIC	STEREO	HEADSET	
0x19h	3D	CUST_COMP	ATTENUATE	FREQ		LEVEL		MODE	3DENB	
0x1Ah	I2SMODE	WORD_ORDER	I2S_WS_GEN_MODE		WS_MS	STEREO REVERSE	I2S_MODE	INENB	OUTENB	
0x1Bh	I2SCLOCK	PCM_SYNC_WIDTH		I2S_CLOCK_GEN_MODE				CLKSCE	CLK_MS	
0x1Ch	PCMMODE	ALAW/ $\mu$ LAW	COMPAND	SDO_LSB_HZ	SYNC_MS	CLKSRCE	CLK_MS	INENB	OUTENB	
0x1Dh	PCMCLOCK	PCM_SYNC_GEN_MODE				PCM_CLOCKGEN MODE				
0x1Eh	BRIDGE	MONO_SUM_MODE		MONO_SUM_SEL	DAC_TX_SEL		I2S_TX_SEL		PCM_TX_SEL	
0x1Fh	GPIO	DAC_SRC_MODE	ADC_SRC_MODE	GPIO_2_SEL			GPIO_1_SEL			
0x20h	CMP_0_LSB	CMP_0_LSB								
0x21h	CMP_0_MSB	CMP_0_MSB								
0x22h	CMP_1_LSB	CMP_1_LSB								
0x23h	CMP_1_MSB	CMP_1_MSB								
0x24h	CMP_2_LSB	CMP_2_LSB								
0x25h	CMP_2_MSB	CMP_2_MSB								

(1) The default value of all I2C registers is 0x00h.

## BASIC CONFIGURATION REGISTER

This register is used to control the basic function of the chip.

**Table 2. BASIC (0x00h)**

Bits	Field	Description		
1:0	CHIP_MODE	The LM49370 can be placed in one of four modes which dictate its basic operation. When a new mode is selected the LM49370 will change operation silently and will re-configure the power management profile automatically. The modes are described as follows:		
		CHIP MODE	Audio System	Typical Application
		00 <sub>2</sub>	Off	Power-down Mode
		01 <sub>2</sub>	Off	Stand-by mode with headset event detection
		10 <sub>2</sub>	On	Active without headset event detection
11 <sub>2</sub>	On	Active with headset event detection		
2	PLL_ENABLE	This enables the PLL.		
3	USE_OSC	If set the power management and control circuits will assume that no external clock is available and will resort to using an on-chip oscillator for headset detection and analog power management functions such as click and pop. The PLL, ADC, and DAC are not wired to use this low quality clock. This bit must be cleared for the part to be fully turned off power-down mode.		
5:4	CAP_SIZE	This programs the extra delays required to stabilize once charge/discharge is complete, based on the size of the bypass capacitor.		
		CAP_SIZE	Bypass Capacitor Size	Turn-off/on time
		00 <sub>2</sub>	0.1 $\mu$ F	45 ms/75 ms
		01 <sub>2</sub>	1 $\mu$ F	45 ms/140 ms
		10 <sub>2</sub>	2.2 $\mu$ F	45 ms/260 ms
11 <sub>2</sub>	4.7 $\mu$ F	45 ms/500 ms		
7:6	DAC_MODE	The DAC can operate in one of four modes. If an "fs*2 <sup>N</sup> " audio clock is available, then the DAC can be run in a slightly lower power mode. If such a clock is not available, the PLL can be used to generate a suitable clock.		
		DAC MODE	DAC OSR	Typical Application
		00 <sub>2</sub>	125	48kHz Playback from 12.000MHz
		01 <sub>2</sub>	128	48kHz Playback from 12.288MHz
		10 <sub>2</sub>	64	96kHz Playback from 12.288MHz
11 <sub>2</sub>	32	192kHz Playback from 24.576MHz		

For reliable headset / push button detection the following bits should be defined before enabling the headset detection system by setting bit 0 of CHIP\_MODE:

The OCL-bit (Cap / Capless headphone interface; bit 6 of HP\_OUTPUT (0x15h))

The headset insert/removal debounce settings (bits 6:3 of DETECT (0x17h))

The BTN\_TYPE-bit (Parallel / Series push button type; bit 3 MIC\_2 register (0x0Ch))

The parallel push button debounce settings (bits 5:4 of MIC\_2 register (0x0Ch))

All register fields controlling the audio system should be defined before setting bit 1 of CHIP\_MODE and should not be altered while the audio sub-system is active.

If the analog or digital levels are below -12dB then it is not necessary to set the stereo bit allowing greater output levels to be obtained for such signals.

## CLOCKS CONFIGURATION REGISTER

This register is used to control the clocks throughout the chip.



**Table 3. CLOCKS (0x01h)**

Bits	Field	Description	
1:0	DAC_CLK	This selects the clock to be used by the audio DAC system.	
		DAC_CLK	DAC Input Source
		00 <sub>2</sub>	MCLK
		01 <sub>2</sub>	PLL_OUTPUT
		10 <sub>2</sub>	I2S_CLK_IN
	11 <sub>2</sub>	PCM_CLK_IN	
7:2	R_DIV	This programs the R divider.	
		R_DIV	Divide Value
		0	Bypass
		1	Bypass
		2	1.5
		3	2
		4	2.5
		5	3
		6	3.5
		7	4
		8	4.5
		9	5
		10	5.5
		11	6
		12	6.5
	13 to 61	7 to 31	
	62	31.5	
	63	32	

### LM49370 CLOCK NETWORK

The audio ADC operates at 125\*fs ( or 128\*fs), so it requires a 1.000 MHz (or 1.024MHz) clock to sample at 8 kHz (at point **C** as marked on the following diagram). If the stereo DAC is running at 125\*fs (or 128\*fs), it requires a 12.000MHz (or 12.288MHz) clock (at point **B**) for 48 kHz data. It is expected that the PLL is used to drive the audio system operating at 125\*fs unless a 12.000 MHz master clock is supplied or the sample rate is always a multiple of 8 kHz. In this case the PLL can be bypassed to reduce power, with clock division being performed by the Q and R dividers instead. The PLL can also be bypassed if the system is running at 128\*fs and a 12.288MHz master clock is supplied and the sample rate is a multiple of 8kHz. The PLL can also use the I<sup>2</sup>S clock input as a source. In this case, the audio DAC uses the clock from the output of the PLL and the audio ADC either uses the PLL output divided by  $2 \cdot F_{S(DAC)} / F_{S(ADC)}$  or a system clock divided by Q, this allows n\*8 kHz recording and 44.1 kHz playback.

MCLK must be less than or equal to 30 MHz. I2S\_CLK and PCM\_CLK should be below 6.144MHz.

When operating at 125\*fs, the LM49370 is designed to work from a 12.000 MHz or 11.025 MHz clock at point **A**. When operating at 128\*fs, the LM49370 is designed to work from a 12.288MHz or 11.2896 MHz clock at point A. This is used to drive the power management and control logic. Performance may not meet the electrical specifications if the frequency at this point deviates significantly beyond this range.

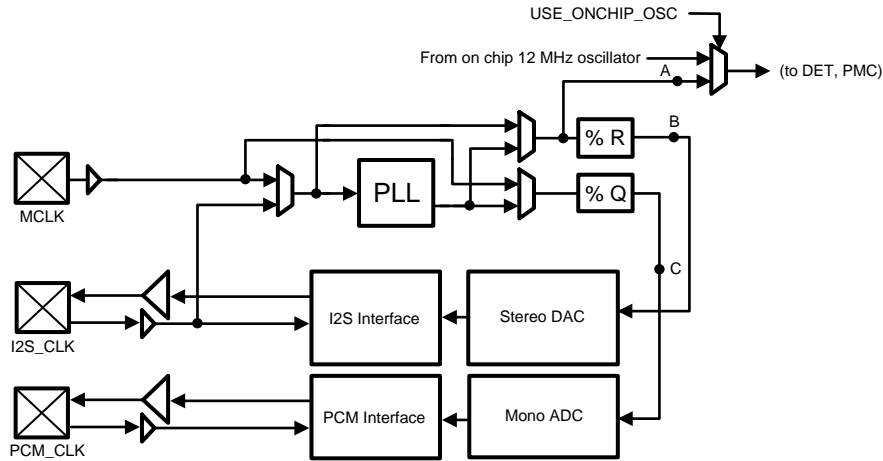

Figure 13. LM49370 Clock Network

**COMMON CLOCK SETTINGS FOR THE DAC & ADC**

When DAC\_MODE = '00' (bits 7:6 of (0x00h)), the DAC has an over sampling ratio of 125 but requires a 250\*fs clock at point **B**. This allows a simple clocking solution as it will work from 12.000 MHz (common in most systems with Bluetooth or USB) at 48 kHz exactly, the following table describes the clock required at point **B** for various clock sample rates in the different DAC modes:

**Table 4. Common DAC Clock Frequencies**

DAC Sample Rate (kHz)	Clock Required at B (OSR = 125)	Clock Required at B (OSR = 128)
8	2 MHz	2.048 MHz
11.025	2.75625 MHz	2.8224 MHz
12	3 MHz	3.072 MHz
16	4 MHz	4.096 MHz
22.05	5.5125 MHz	5.6448 MHz
24	6 MHz	6.144 MHz
32	8 MHz	8.192 MHz
44.1	11.025 MHz	11.2896 MHz
48	12 MHz	12.288 MHz

**NOTE**

When DAC\_MODE = '01' with the I<sup>2</sup>S or PCM interface operating as master, the stereo DAC operates at half the frequency of the clock at point B. This divided by two DAC clock is used as the source clock for the audio port.

The over sampling ratio of the ADC is set by ADC MODE (bit 0 of 0x07h)). The table below shows the required clock frequency at point **C** for the different ADC modes.

**Table 5. Common ADC Clock Frequencies**

ADC Sample Rate (kHz)	Clock Required at C (OSR = 125)	Clock Required at C (OSR = 128)
8	1 MHz	1.024 MHz
11.025	1.378125 MHz	1.4112 MHz
12	1.5 MHz	1.536 MHz
16	2 MHz	2.048 MHz
22.05	2.75625 MHz	2.8224 MHz
24	3 MHz	3.072 MHz

Methods for producing these clock frequencies are described in the [PLL](#) Section.

### PLL M DIVIDER CONFIGURATION REGISTER

This register is used to control the input section of the PLL.

**Table 6. PLL\_M (0x02h)<sup>(1)</sup>**

Bits	Field	Description	
0	RSVD	RESERVED	
6:0	PLL_M	PLL_M	Input Divider Value
		0	No Divided Clock
		1	1
		2	1.5
		3	2
		4	2.5
		...	3 to 63
		126	63.5
		127	64
7	FORCERQ	If set, the R and Q divider are enabled and the DAC and ADC clocks are propagated. This allows operation of the I <sup>2</sup> S and PCM interfaces without the ADC or DAC being enabled, for example to act as a bridge or a clock master.	

(1) See [Further Notes on PLL Programming](#) for more detail.

The M divider should be set such that the output of the divider is between 0.5 MHz and 5 MHz.

The division of the M divider is derived from PLL\_M such that:

$$M = (\text{PLL\_M} + 1) / 2$$

### PLL N DIVIDER CONFIGURATION REGISTER

This register is used to control the feedback divider of the PLL.

**Table 7. PLL\_N (0x03h)<sup>(1)</sup>**

Bits	Field	Description	
7:0	PLL_N	This programs the PLL feedback divider as follows:	
		PLL_N	Feedback Divider Value
		0 to 10	10
		11	11
		12	12
		13	13
		14	14
		...	...
		249	249
		250 to 255	250

(1) See [Further Notes on PLL Programming](#) for further details.

The N divider should be set such that the output of the divider is between 0.5 MHz and 5 MHz.  $(F_{in}/M)*N$  will be the target resting VCO frequency,  $F_{VCO}$ . The N divider should be set such that  $40 \text{ MHz} < (F_{in}/M)*N < 60 \text{ MHz}$ .  $F_{in}/M$  is often referred to as  $F_{comp}$  (comparison frequency) or  $F_{ref}$  (reference frequency), in this document  $F_{comp}$  is used.

The integer division of the N divider is derived from PLL\_N such that:

$$\text{For } 9 < \text{PLL\_N} < 251: N = \text{PLL\_N}$$

### PLL P DIVIDER CONFIGURATION REGISTER

This register is used to control the output divider of the PLL.

**Table 8. PLL\_P (0x04h)<sup>(1)</sup>**

Bits	Field	Description	
3:0	PLL_P	This programs the PLL output divider as follows:	
		PLL_P	Output Divider Value
		0	No Divided Clock
		1	1
		2	1.5
		3	2
		4	2.5
		...	3 to 7
		14	7.5
15	8		
6:4	Q_DIV	This programs the Q Divider	
		Q_DIV	Divide Value
		000 <sub>2</sub>	2
		001 <sub>2</sub>	3
		010 <sub>2</sub>	4
		011 <sub>2</sub>	6
		100 <sub>2</sub>	8
		101 <sub>2</sub>	10
		110 <sub>2</sub>	12
111 <sub>2</sub>	13		
7	FAST_VCO	This programs the PLL VCO range:	
		FAST_VCO	PLL VCO Range
		0	40 to 60MHz
		1	60 to 80MHz

(1) See [Further Notes on PLL Programming](#) for more details.

The division of the P divider is derived from PLL\_P such that:

$$P = (\text{PLL\_P} + 1) / 2$$

### PLL N MODULUS CONFIGURATION REGISTER

This register is used to control the modulation applied to the feedback divider of the PLL.

**Table 9. PLL\_N\_MOD (0x05h)<sup>(1)</sup>**

Bits	Field	Description	
4:0	PLL_N_MOD	This programs the PLL N divider's fractional component:	
		PLL_N_MOD	Fractional Addition
		0	0/32
		1	1/32
		2 to 30	2/32 to 30/32
		31	31/32
6:5	PLL_CLK_SEL	This selects the clock to be used as input for the audio PLL.	
		PLL_INPUT_CLK	
		00 <sub>2</sub>	MCLK
		01 <sub>2</sub>	I2S_CLK_IN
		10 <sub>2</sub>	PCM_CLK_IN
		11 <sub>2</sub>	—
7	RSVD	Reserved.	

(1) See [Further Notes on PLL Programming](#) for more details.

The complete N divider is a fractional divider as such:

$$N = PLL\_N + PLL\_N\_MOD/32$$

If the modulus input is zero then the N divider is simply an integer N divider. The output from the PLL is determined by the following formula:

$$F_{out} = (F_{in} * N) / (M * P)$$

**FURTHER NOTES ON PLL PROGRAMMING**

The sigma-delta PLL is designed to drive audio circuits requiring accurate clock frequencies of up to 30MHz with frequency errors noise-shaped away from the audio band. The 5 bits of modulus control provide exact synchronization of 48kHz and 44.1kHz sample rates from any common system clock. In systems where an isochronous I<sup>2</sup>S data stream is the source of data to the DAC a clock synchronous to the sample rate should be used as input to the PLL (typically the I<sup>2</sup>S clock). If no isochronous source is available, then the PLL can be used to obtain a clock that is accurate to within 1Hz of the correct sample rate although this is highly unlikely to be a problem.

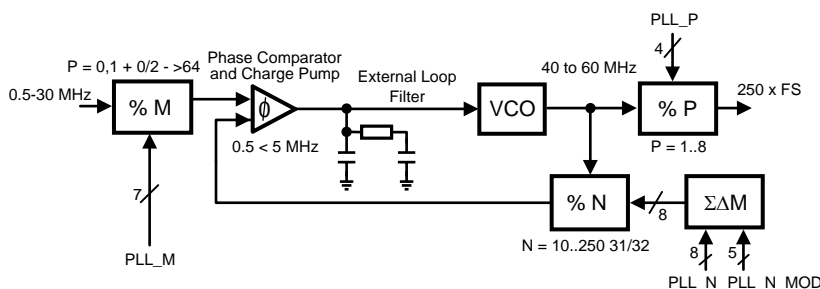

Figure 14. PLL Overview

Table 10. Example PLL Settings for 48 kHz and 44.1 kHz Sample Rates in DAC MODE 00

F <sub>in</sub> (MHz)	F <sub>s</sub> (kHz)	M	N	P	PLL_M	PLL_N	PLL_N_MO D	PLL_P	F <sub>out</sub> (MHz)
11	48	11	60	5	21	60	0	9	12
12.288	48	4	19.53125	5	7	19	17	9	12
13	48	13	60	5	25	60	0	9	12
14.4	48	9	37.5	5	17	37	16	9	12
16.2	48	27	100	5	53	100	0	9	12
16.8	48	14	50	5	27	50	0	9	12
19.2	48	13	40.625	5	25	40	20	9	12
19.44	48	27	100	6	53	100	0	11	12
19.68	48	20.5	62.5	5	40	62	16	9	12
19.8	48	16.5	50	5	32	50	0	9	12
11	44.1	11	55.125	5	21	55	4	9	11.025
11.2896	44.1	8	39.0625	5	15	39	2	9	11.025
12	44.1	5	22.96875	5	9	22	31	9	11.025
13	44.1	13	55.125	5	25	55	4	9	11.025
14.4	44.1	12	45.9375	5	23	45	30	9	11.025
16.2	44.1	9	30.625	5	17	9	20	9	11.025
16.8	44.1	17	55.78125	5	33	30	25	9	11.025
19.2	44.1	16	45.9375	5	31	45	30	9	11.025
19.44	44.1	13.5	38.28125	5	26	38	9	9	11.025
19.68	44.1	20.5	45.9375	4	40	45	30	7	11.025
19.8	44.1	11	30.625	5	21	30	20	9	11.025

**Table 11. Example PLL Settings for 48 kHz and 44.1 kHz Sample Rates in DAC MODE 01**

F <sub>in</sub> (MHz)	F <sub>s</sub> (kHz)	M	N	P	PLL_M	PLL_N	PLL_N_MOD	PLL_P	F <sub>out</sub> (MHz)
12	48	12.5	64	5	24	64	0	9	12.288
13	48	26.5	112.71875	4.5	52	112	23	8	12.288
14.4	48	37.5	128	4	74	128	0	7	12.288
16.2	48	37.5	128	4.5	74	128	0	8	12.288
16.8	48	12.53	32	3.5	24	32	0	6	12.288
19.2	48	12.5	32	4	24	32	0	7	12.288
19.44	48	40.5	128	58	80	128	0	9	12.288
19.68	48	20.5	64	5	40	64	0	9	12.288
19.8	48	37.5	128	5.5	74	128	0	10	12.288
12	44.1	35.5	133.59375	4	70	133	19	7	11.2896
13	44.1	37	144.59375	4.5	73	144	19	8	11.2896
14.4	44.1	37.5	147	5	74	147	0	9	11.2896
16.2	44.1	47.5	182.0625	5.5	94	182	2	10	11.2896
16.8	44.1	12.5	42	5	24	42	0	9	11.2896
19.2	44.1	12.5	36.75	5	24	36	24	9	11.2896
19.44	44.1	37.5	98	4.5	74	98	0	9	11.2896
19.68	44.1	44.5	114.875	4.5	88	114	28	8	11.2896
19.8	44.1	48	136.84375	5	95	136	27	9	11.2896

These tables cover the most common applications, obtaining clocks for derivative sample rates such as 22.05 kHz should be done by increasing the P divider value or using the R/Q dividers.

An example of obtaining 12.000 MHz from 1.536 MHz is shown below (this is typical for deriving DAC clocks from I2S datastreams).

Choose a small range of P so that the VCO frequency is swept between 40 MHz and 60 MHz (or 60–80 MHz if VCOFAST is used). Remembering that the P divider can divide by half integers, for a 12 MHz output, this gives possible P values of 3, 3.5, 4, 4.5, or 5. The M divider should be set such that the comparison frequency (F<sub>comp</sub>) is between 0.5 and 5 MHz. This gives possible M values of 1, 1.5, 2, 2.5, or 3. The most accurate N and N<sub>MOD</sub> can be calculated by sweeping the P and M inputs of the following formulas:

$$N = \text{FLOOR}\{[(F_{out}/F_{in}) * (P * M)], 1\}$$

$$N\_MOD = \text{ROUND}\{32 * [(F_{out}/F_{in}) * (P * M) - N], 0\}$$

This shows that setting M = 1, N = 39+1/16, P = 5 (i.e. PLL\_M = 0, PLL\_N = 39, PLL\_N\_MOD = 2, & PLL\_P = 4) gives a comparison frequency of 1.536MHz, a VCO frequency of 60 MHz and an output frequency of 12.000 MHz. The same settings can be used to get 11.025 from 1.4112 MHz for 44.1 kHz sample rates.

Care must be taken when synchronization of isochronous data is not possible, i.e. when the PLL has to be used but an exact frequency match cannot be found. The I2S should be master on the LM49370 so that the data source can support appropriate SRC as required. This method should only be used with data being read on demand to eliminate sample rate mismatch problems.

Where a system clock exists at an integer multiple of the required ADC or DAC clock rate it is preferable to use this rather than the PLL. The LM49370 is designed to work in 8, 12, 16, 24, 48 kHz modes from a 12 MHz clock and 8 kHz modes from a 13 MHz clock without the use of the PLL. This saves power and reduces clock jitter which can affect SNR.

### PLL Loop Filter

LM49370 requires a second or third order loop filter on PLL\_FILT pin. LM49370 demoboard schematic has the recommended values to use for the second order filter. Please refer to the LM49370 demoboard schematic.

**ADC\_1 CONFIGURATION REGISTER**

This register is used to control the LM49370's audio ADC.

**Table 12. ADC\_1 (0x06h)**

Bits	Field	Description	
0	MIC_SELECT	If set the microphone preamp output is added to the ADC input signal.	
1	CPI_SELECT	If set the cell phone input is added to the ADC input signal.	
2	LEFT_SELECT	If set the left stereo bus is added to the ADC input signal.	
3	RIGHT_SELECT	If set the right stereo bus is added to the ADC input signal.	
5:4	ADC_SAMPLE_RATE	This programs the closest expected sample rate of the mono ADC, which is a variable required by the AGC algorithm whenever the AGC is in use. This does not set the sample rate of the mono ADC.	
		ADC_SAMPLE_RATE	Sample Rate
		00 <sub>2</sub>	8 kHz
		01 <sub>2</sub>	12 kHz
		10 <sub>2</sub>	16 kHz
7:6	HPF_MODE	This sets the HPF of the ADC	
		HPF-MODE	HPF Response
		00 <sub>2</sub>	No HPF
		01 <sub>2</sub>	F <sub>S</sub> = 8 kHz, -0.5 dB @ 300 Hz, Notch @ 55 Hz F <sub>S</sub> = 12 kHz, -0.5 dB @ 450 Hz, Notch @ 82 Hz F <sub>S</sub> = 16 kHz, -0.5 dB @ 600 Hz, Notch @ 110 Hz
		10 <sub>2</sub>	F <sub>S</sub> = 8 kHz, -0.5 dB @ 150 Hz, Notch @ 27 Hz F <sub>S</sub> = 12 kHz, -0.5 dB @ 225 Hz, Notch @ 41 Hz F <sub>S</sub> = 16 kHz, -0.5 dB @ 300 Hz, Notch @ 55 Hz
11 <sub>2</sub>	No HPF		

**ADC\_2 CONFIGURATION REGISTER**

This register is used to control the LM49370's audio ADC.

**Table 13. ADC\_2 (0x07h)**

Bits	Field	Description	
0	ADC_MODE	This sets the oversampling ratio of the ADC	
		MODE	ADC OSR
		0	125fs
		1	128fs
1	ADC_MUTE	If set, the analog inputs to the ADC are muted.	

**Table 13. ADC\_2 (0x07h) (continued)**

Bits	Field	Description	
4:2	AGC_FRAME_TIME	This sets the frame time to be used by the AGC algorithm. In a given frame, the AGC's peak detector determines the peak value of the incoming microphone audio signal and compares this value to the target value of the AGC defined by AGC_TARGET (bits [3:1] of register (0x08h)) in order to adjust the microphone preamplifier's gain accordingly. AGC_FRAME_TIME basically sets the sample rate of the AGC to adjust for a wide variety of speech patterns. <sup>(1)</sup>	
		AGC_FRAME_TIME	Time (ms)
		000 <sub>2</sub>	96
		001 <sub>2</sub>	128
		010 <sub>2</sub>	192
		011 <sub>2</sub>	256
		100 <sub>2</sub>	384
		101 <sub>2</sub>	512
		110 <sub>2</sub>	768
111 <sub>2</sub>	1000		
6:5	ADC_CLK	This selects the clock to be used by the audio ADC system.	
		ADC_CLK	Source
		00 <sub>2</sub>	MCLK
		01 <sub>2</sub>	PLL_OUTPUT
		10 <sub>2</sub>	I2S_CLK_IN
11 <sub>2</sub>	PCM_CLK_IN		
7	NGZXDD	If set, the noise gate will not wait for a zero crossing before mute/unmuting. This bit should be set if the ADC's HPF is disabled and if there is a large DC or low frequency component at the ADC input.	
		NGZXDD	Result
		0	Noise Gate operates on ZXD events
1	Noise Gate operates on frame boundaries		

(1) Refer to the [AGC Overview](#) for further detail.

### AGC\_1 CONFIGURATION REGISTER

This register is used to control the LM49370's Automatic Gain Control. <sup>(2)</sup>

**Table 14. AGC\_1 (0x08h)**

Bits	Field	Description	
0	AGC_ENABLE	If set, the AGC controls the analog microphone preamplifier gain into the system. This feature is useful for microphone signals that are routed to the ADC.	
3:1	AGC_TARGET	This programs the target level of the AGC. This will depend on the expected transients and desired headroom. Refer to AGC_TIGHT (bit 7 of 0x09h) for more detail.	
		AGC_TARGET	Target Level
		000 <sub>2</sub>	-6 dB
		001 <sub>2</sub>	-8 dB
		010 <sub>2</sub>	-10 dB
		011 <sub>2</sub>	-12 dB
		100 <sub>2</sub>	-14 dB
		101 <sub>2</sub>	-16 dB
110 <sub>2</sub>	-18 dB		
111 <sub>2</sub>	-20 dB		
4	NOISE_GATE_ON	If set, signals below the noise gate threshold are muted. The noise gate is only activated after a set period of signal absence.	

(2) See the [AGC Overview](#).



**Table 14. AGC\_1 (0x08h) (continued)**

Bits	Field	Description	
7:5	NOISE_GATE_THRES	This field sets the expected background noise level relative to the peak signal level. The sole presence of signals below this level will not result in an AGC gain change of the input and will be gated from the ADC output if the NOISE_GATE_ON is set. This level must be set even if the noise gate is not in use as it is required by the AGC algorithm.	
		NOISE_GATE_THRES	Level
		000 <sub>2</sub>	-72 dB
		001 <sub>2</sub>	-66 dB
		010 <sub>2</sub>	-60 dB
		011 <sub>2</sub>	-54 dB
		100 <sub>2</sub>	-48 dB
		101 <sub>2</sub>	-42 dB
		110 <sub>2</sub>	-36 dB
111 <sub>2</sub>	-30 dB		

**AGC\_2 CONFIGURATION REGISTER**

This register is used to control the LM49370's Automatic Gain Control.

**Table 15. AGC\_2 (0x09h)**

Bits	Field	Description	
3:0	AGC_MAX_GAIN	This programs the maximum gain that the AGC algorithm can apply to the microphone preamplifier.	
		AGC_MAX_GAIN	Max Preamplifier Gain
		0000 <sub>2</sub>	6 dB
		0001 <sub>2</sub>	8 dB
		0010 <sub>2</sub>	10 dB
		0011 <sub>2</sub>	12 dB
		0100 <sub>2</sub> to 1100 <sub>2</sub>	14 dB to 30 dB
		1101 <sub>2</sub>	32 dB
		1110 <sub>2</sub>	34 dB
1111 <sub>2</sub>	36 dB		
6:4	AGC_DECAY	This programs the speed at which the AGC will increase gains if it detects the input level is a quiet signal.	
		AGC_DECAY	Step Time (ms)
		000 <sub>2</sub>	32
		001 <sub>2</sub>	64
		010 <sub>2</sub>	128
		011 <sub>2</sub>	256
		100 <sub>2</sub>	512
		101 <sub>2</sub>	1024
		110 <sub>2</sub>	2048
111 <sub>2</sub>	4096		

**Table 15. AGC\_2 (0x09h) (continued)**

Bits	Field	Description		
7	AGC_TIGHT	If set, the AGC algorithm controls the microphone preamplifier more exactly. <sup>(1)</sup>		
	AGC_TIGHT = 0	AGC_TARGET	Min Level	Max Level
		000 <sub>2</sub>	-6 dB	-3 dB
		001 <sub>2</sub>	-8 dB	-4 dB
		010 <sub>2</sub>	-10 dB	-5 dB
		011 <sub>2</sub>	-12 dB	-6 dB
		100 <sub>2</sub>	-14 dB	-7 dB
		101 <sub>2</sub>	-16 dB	-8 dB
		110 <sub>2</sub>	-18 dB	-9 dB
		111 <sub>2</sub>	-20 dB	-10 dB
	AGC_TIGHT = 1	000 <sub>2</sub>	-6 dB	-3 dB
		001 <sub>2</sub>	-8 dB	-5 dB
		010 <sub>2</sub>	-10 dB	-7 dB
		011 <sub>2</sub>	-12 dB	-9 dB
		100 <sub>2</sub>	-14 dB	-11 dB
		101 <sub>2</sub>	-16 dB	-13 dB
		110 <sub>2</sub>	-18 dB	-15 dB
		111 <sub>2</sub>	-20 dB	-17 dB

(1) The AGC can be used to control the analog path of the microphone to the output stages or to optimize the microphone path for recording on the ADC. When the analog path is used this bit should be set to ensure the target is tightly adhered to. If the ADC is the only destination of the microphone or the desired analog mixer level is line level then AGC\_TIGHT should be cleared, allowing greater dynamic range of the recorded signal. For further details see the [AGC Overview](#).

### AGC\_3 CONFIGURATION REGISTER

This register is used to control the LM49370's Automatic Gain Control. <sup>(2)</sup>

**Table 16. AGC\_3 (0x0Ah)**

Bits	Field	Description	
4:0	AGC_HOLDTIME	This programs the amount of delay before the AGC algorithm begins to adjust the gain of the microphone preamplifier.	
		AGC_HOLDTIME	No. of speech segments
		00000 <sub>2</sub>	0
		00001 <sub>2</sub>	1
		00010 <sub>2</sub>	2
		00011 <sub>2</sub>	3
		00100 <sub>2</sub> to 11100 <sub>2</sub>	4 to 28
		11101 <sub>2</sub>	29
		11110 <sub>2</sub>	30
		11111 <sub>2</sub>	31

(2) See the [AGC Overview](#).



The AGC algorithm should not be used where very large background noise is present. If the type of input data, application and microphone is known then the AGC will typically not be required for good performance, it is intended for use with inputs with a large dynamic range or unknown nominal level. When setting *NOISE\_GATE\_THRESHOLD* be aware that in some mobile phone scenarios the ADC SNR will be dictated by the microphone performance rather than the ADC or the signal. Gain changes to the microphone are performed on zero crossings. To eliminate DC offsets, wind noise, and pop sounds from the output of the ADC, the ADC's HPF should always be enabled.

### MIC\_1 CONFIGURATION REGISTER

This register is used to control the microphone configuration.

**Table 17. MIC\_1 (0x0Bh)**

Bits	Field	Description	
3:0	PREAMP_GAIN	This programs the gain applied to the microphone preamplifier if the AGC is not in use.	
		PREAMP_GAIN	Gain
		0000 <sub>2</sub>	6 dB
		0001 <sub>2</sub>	8 dB
		0010 <sub>2</sub>	10 dB
		0011 <sub>2</sub>	12 dB
		0100 <sub>2</sub> to 1100 <sub>2</sub>	14 dB to 30 dB
		1101 <sub>2</sub>	32 dB
		1110 <sub>2</sub>	34 dB
1111 <sub>2</sub>	36 dB		
4	MIC_MUTE	If set, the microphone preamplifier is muted.	
5	INT_SE_DIFF	If set, the internal microphone is assumed to be single ended and the negative connection is connected to the ADC common mode point internally. This allows a single-ended internal microphone to be used.	
6	INT_EXT	If set, the single ended external microphone is used and the negative microphone input is grounded internally, otherwise internal microphone operation is assumed. <sup>(1)</sup>	

- (1) On changing INT\_EXT from internal to external note that the dc blocking cap will not be charged so some time should be taken (300ms for a 1µF cap) between the detection of an external headset and the switching of the output stages and ADC to that input to allow the DC points on either side of this cap to stabilize. This can be accomplished by deselecting the microphone input from the audio outputs and ADC until the DC points stabilize. An active MIC path to CPOUT or the ADC may result in the microphone DC blocking caps causing audio pops under the following situations:1) Switching between internal and external microphone operation while in chip modes '10' or '11'.2) Toggling in and out of powerdown/standby modes.3) Toggling between chip modes '10' and '11' whenever external microphone operation is selected.4) The insertion/removal of a headset while in chip modes '10' or '11' whenever external microphone operation is selected. To avoid these potential pop issues, it is recommended to deselect the microphone input from CPOUT and ADC until the DC points stabilize.

### MIC\_2 CONFIGURATION REGISTER

This register is used to control the microphone configuration.

**Table 18. MIC\_2 (0x0Ch)**

Bits	Field	Description	
0	OCL_VCM_VOLTAGE	This selects the voltage used as virtual ground (HP_VMID pin) in OCL mode. This will depend on the available supply and the power output requirements of the headphone amplifiers.	
		OCL_VCM_VOLTAGE	Voltage
		0	1.2V
		1	1.5V

**Table 18. MIC\_2 (0x0Ch) (continued)**

Bits	Field	Description	
2:1	MIC_BIAS_VOLTAGE	This selects the voltage as a reference to the internal and external microphones. Only one bias pin is driven at once depending on the INT_EXT bit setting found in the MIC_1 (0x0Bh) register. MIC_BIAS_VOLTAGE should be set to '11' only if $A_{VDD} > 3.4V$ . In OCL mode, MIC_BIAS_VOLTAGE = '00' (EXT_BIAS = 2.0V) should not be used to generate the EXT_BIAS supply for a cellular headset external microphone. Please refer to <a href="#">Table 19</a> for more detail.	
		MIC_BIAS_VOLTAGE	EXT_BIAS/INT_BIAS
		00 <sub>2</sub>	2.0V
		01 <sub>2</sub>	2.5V
		10 <sub>2</sub>	2.8V
11 <sub>2</sub>	3.3V		
3	BUTTON_TYPE	If set, the LM49370 assumes that the button (if used) in the headset is in series (series push button) with the microphone, opening the circuit when pressed. The default is for the button to be in parallel (parallel push button), shorting out the microphone when pressed.	
5:4	BUTTON_DEBOUNCE_TIME	This sets the time used for debouncing the pushing of the button on a headset with a parallel push button.	
		BUTTON_DEBOUNCE_TIME	Time (ms)
		00 <sub>2</sub>	0
		01 <sub>2</sub>	8
		10 <sub>2</sub>	16
11 <sub>2</sub>	32		

In OCL mode there is a trade-off between the external microphone supply voltage (EXT\_MIC\_BIAS - OCL\_VCM\_VOLTAGE) and the maximum output power possible from the headphones. A lower OCL\_VCM\_VOLTAGE gives a higher microphone supply voltage but a lower maximum output power from the headphone amplifiers due to the lower OCL\_VCM\_VOLTAGE -  $A_{VSS}$ .

**Table 19. External MIC Supply Voltages in OCL Mode**

Available $A_{VDD}$	Recommended EXT_MIC_BIAS	Supply to Microphone	
		OCL_VCM_VOLT = 1.5V	OCL_VCM_VOLT = 1.2V
> 3.4V	3.3V	1.8V	2.1V
2.9V to 3.4V	2.8V	1.3V	1.6V
2.8V to 2.9V	2.5V	1.0V	1.3V
2.7V to 2.8V	2.5V	-	1.3V

## SIDETONE ATTENUATION REGISTER

This register is used to control the analog sidetone attenuation. <sup>(1)</sup>

**Table 20. SIDETONE (0x0Dh)**

Bits	Field	Description	
3:0	SIDETONE_ATTEN	This programs the attenuation applied to the microphone preamp output to produce a sidetone signal.	
		SIDETONE_ATTEN	Attenuation
		0000 <sub>2</sub>	-Inf
		0001 <sub>2</sub>	-30 dB
		0010 <sub>2</sub>	-27 dB
		0011 <sub>2</sub>	-24 dB
		0100 <sub>2</sub>	-21 dB
		0101 <sub>2</sub> to 1010 <sub>2</sub>	-18 dB to -3 dB
1011 <sub>2</sub> to 1111 <sub>2</sub>	0 dB		

(1) An active SIDETONE path to an audio output may result in the microphone DC blocking caps causing audio pops under the following situations: 1) Switching between internal and external microphone operation while in chip modes '10' or '11'. 2) Toggling in and out of powerdown/standby modes. 3) Toggling between chip modes '10' and '11' whenever external microphone operation is selected. 4) The insertion/removal of a headset while in chip modes '10' or '11' whenever external microphone operation is selected. To avoid potential pop noises, it is recommended to set SIDETONE\_ATTEN to '0000' until DC points have stabilized whenever the SIDETONE path is used.

## CP\_INPUT CONFIGURATION REGISTER

This register is used to control the differential cell phone input.

**Table 21. CP\_INPUT (0x0Eh)**

Bits	Field	Description	
4:0	CPI_LEVEL	This programs the gain/attenuation applied to the cell phone input.	
		CPI_LEVEL	Level
		00000 <sub>2</sub>	-34.5 dB
		00001 <sub>2</sub>	-33 dB
		00010 <sub>2</sub>	-31.5 dB
		00011 <sub>2</sub>	-30 dB
		00100 to 11100 <sub>2</sub>	-28.5 dB to +7.5 dB
		11101 <sub>2</sub>	+9 dB
11110 <sub>2</sub>	+10.5 dB		
11111 <sub>2</sub>	+12 dB		
5	CPI_MUTE	If set, the CPI input is muted at source.	

## AUX\_LEFT CONFIGURATION REGISTER

This register is used to control the left aux analog input.

**Table 22. AUX\_LEFT (0x0Fh)**

Bits	Field	Description		
4:0	AUX_LEFT_LEVEL	This programs the gain/attenuation applied to the AUX LEFT analog input to the mixer. <sup>(1)</sup>		
		AUX_LEFT_LEVEL	Level (With Boost)	Level (Without Boost)
		0000 <sub>2</sub>	-34.5 dB	-46.5 dB
		0000 <sub>1</sub> <sub>2</sub>	-33 dB	-45 dB
		0001 <sub>0</sub> <sub>2</sub>	-31.5 dB	-43.5 dB
		0001 <sub>1</sub> <sub>2</sub>	-30 dB	-42 dB
		0010 <sub>0</sub> to 1110 <sub>0</sub> <sub>2</sub>	-28.5 dB to +7.5 dB	-40.5 dB to -4.5 dB
		1110 <sub>1</sub> <sub>2</sub>	+9 dB	-3 dB
		1111 <sub>0</sub> <sub>2</sub>	+10.5 dB	-1.5 dB
1111 <sub>1</sub> <sub>2</sub>	+12 dB	0 dB		
5	AUX_LEFT_BOOST	If set, the gain of the AUX_LEFT input to the mixer is increased by 12 dB (see above).		
6	AUX_L_MUTE	If set, the AUX LEFT input is muted.		
7	AUX_OR_DAC_L	If set, the AUX LEFT input is passed to the mixer, the default is for the DAC LEFT output to be passed to the mixer.		

(1) The recommended mixer level is 1V RMS. The auxiliary analog inputs can be boosted by 12 dB if enough headroom is available. Clipping may occur if the analog power supply is insufficient to cater for the required gain.

## AUX\_RIGHT CONFIGURATION REGISTER

This register is used to control the right aux analog input.

**Table 23. AUX\_RIGHT (0x10h)**

Bits	Field	Description		
4:0	AUX_RIGHT_LEVEL	This programs the gain/attenuation applied to the AUX RIGHT analog input to the mixer. <sup>(1)</sup>		
		AUX_RIGHT_LEVEL	Level (With Boost)	Level (Without Boost)
		0000 <sub>2</sub>	-34.5 dB	-46.5 dB
		0000 <sub>1</sub> <sub>2</sub>	-33 dB	-45 dB
		0001 <sub>0</sub> <sub>2</sub>	-31.5 dB	-43.5 dB
		0001 <sub>1</sub> <sub>2</sub>	-30 dB	-42 dB
		0010 <sub>0</sub> to 1110 <sub>0</sub> <sub>2</sub>	-28.5 dB to +7.5 dB	-40.5 dB to -4.5 dB
		1110 <sub>1</sub> <sub>2</sub>	+9 dB	-3 dB
		1111 <sub>0</sub> <sub>2</sub>	+10.5 dB	-1.5 dB
1111 <sub>1</sub> <sub>2</sub>	+12 dB	0 dB		
5	AUX_RIGHT_BOOST	If set, the gain of the AUX_RIGHT input to the mixer is increased by 12 dB (see above).		
6	AUX_R_MUTE	If set, the AUX RIGHT input is muted.		
7	AUX_OR_DAC_R	If set, the AUX RIGHT input is passed to the mixer, the default is for the DAC RIGHT output to be passed to the mixer.		

(1) The recommended mixer level is 1V RMS. The auxiliary analog inputs can be boosted by 12 dB if enough headroom is available. Clipping may occur if the analog power supply is insufficient to cater for the required gain.

## DAC CONFIGURATION REGISTER

This register is used to control the DAC levels to the mixer.

**Table 24. DAC (0x11h)**

Bits	Field	Description		
4:0	DAC_LEVEL	This programs the gain/attenuation applied to the DAC input to the mixer. <sup>(1)</sup>		
		DAC_LEVEL	Level (With Boost)	Level (Without Boost)
		0000 <sub>2</sub>	-34.5 dB	-46.5 dB
		0000 <sub>1</sub> <sub>2</sub>	-33 dB	-45 dB
		0001 <sub>0</sub> <sub>2</sub>	-31.5 dB	-43.5 dB
		0001 <sub>1</sub> <sub>2</sub>	-30 dB	-42 dB
		0010 <sub>0</sub> to 1110 <sub>0</sub> <sub>2</sub>	-28.5 dB to +7.5 dB	-40.5 dB to -4.5 dB
		1110 <sub>1</sub> <sub>2</sub>	+9 dB	-3 dB
		1111 <sub>0</sub> <sub>2</sub>	+10.5 dB	-1.5 dB
1111 <sub>1</sub> <sub>2</sub>	+12 dB	0 dB		
5	DAC_BOOST	If set, the gain of the DAC inputs to the mixer is increased by 12dB (see above).		
6	DAC_MUTE	If set, the stereo DAC input is muted on the next zero crossing.		
7	USE_AUX_LEVELS	If set, the gain of the DAC inputs is controlled by the AUX_LEFT and AUX_RIGHT registers, allowing a stereo balance to be applied.		

(1) The output from the DAC is 1V RMS for a full scale digital input. This can be boosted by 12 dB if enough headroom is available. Clipping may occur if the analog power supply is insufficient to cater for the required gain.

## CP\_OUTPUT CONFIGURATION REGISTER

This register is used to control the differential cell phone output. <sup>(2)</sup>

**Table 25. CP\_OUTPUT (0x12h)**

Bit s	Field	Description
0	MIC_SELECT	If set, the microphone channel of the mixer is added to the CP_OUT output signal.
1	RIGHT_SELECT	If set, the right channel of the mixer is added to the CP_OUT output signal.
2	LEFT_SELECT	If set, the left channel of the mixer is added to the CP_OUT output signal.
3	CPO_MUTE	If set, the CPOUT output is muted.
4	MIC_NOISE_GATE	If this is set and NOISE_GATE_ON (register 0x08h) is enabled, the MIC to CPO path will be gated if the signal is determined to be noise by the AGC (that is, if the signal is below the set noise threshold).

(2) The gain of cell phone output amplifier is 0 dB.

## AUX\_OUTPUT CONFIGURATION REGISTER

This register is used to control the differential auxiliary output. <sup>(1)</sup>

**Table 26. AUX\_OUTPUT (0x13h)**

Bits	Field	Description
0	CPI_SELECT	If set, the cell phone input channel of the mixer is added to the AUX_OUT output signal.
1	RIGHT_SELECT	If set, the right channel of the mixer is added to the AUX_OUT output signal.
2	LEFT_SELECT	If set, the left channel of the mixer is added to the AUX_OUT output signal.
3	AUX_MUTE	If set, the AUX_OUT output is muted.

(1) The gain of the auxiliary output amplifier is 0 dB. If a second (external) loudspeaker amplifier is to be used its gain should be set to 12 dB to match the onboard loudspeaker amplifier gain.



## LS\_OUTPUT CONFIGURATION REGISTER

This register is used to control the loudspeaker output.<sup>(1)</sup>

**Table 27. LS\_OUTPUT (0x14h)**

Bits	Field	Description
0	CPI_SELECT	If set, the cell phone input channel of the mixer is added to the loudspeaker output signal.
1	RIGHT_SELECT	If set, the right channel of the mixer is added to the loudspeaker output signal.
2	LEFT_SELECT	If set, the left channel of the mixer is added to the loudspeaker output signal.
3	LS_MUTE	If set, the loudspeaker output is muted.
4	RSVD	Reserved.

(1) The gain of the loudspeaker output amplifier is 12 dB.

## HP\_OUTPUT CONFIGURATION REGISTER

This register is used to control the stereo headphone output.<sup>(1)</sup>

**Table 28. HP\_OUTPUT (0x15h)**

Bits	Field	Description
0	SIDETONE_SELECT	If set, the sidetone channel of the mixer is added to both of the headphone output signals.
1	CPI_SELECT	If set, the cell phone input channel of the mixer is added to both of the headphone output signals.
2	RIGHT_SELECT	If set, the right channel of the mixer is added to the headphone output. If the STEREO bit (0x00h) is set, the right channel is added to the right headphone output signal only. If the STEREO bit (0x00h) is cleared, it is added to both the right and left headphone output signals.
3	LEFT_SELECT	If set, the left channel of the mixer is added to the headphone output. If the STEREO bit (0x00h) is set, the left channel is added to the left headphone output signal only. If the STEREO bit (0x00h) is cleared, it is added to both the right and left headphone output signals.
4	HP_MUTE	If set, the headphone output is muted.
5	STEREO	If set, the mixers assume that the signals on the left and right internal busses are highly correlated and when these signals are combined their levels are reduced by 6dB to allow enough headroom for them to be summed.
6	OCL	If set, the part is placed in OCL (Output Capacitor Less) mode.

(1) The gain of the headphone output amplifier is –6 dB for the cell phone input channel and sidetone channel of the mixer. When the STEREO bit (0x00h) is set, headphone output amplifier gain is –6 dB for the left and right channel. When the STEREO bit (0x00h) is cleared, the headphone output amplifier gain is –12 dB for the left and right channel (to allow enough headroom for adding them and routing them to both headphone amplifiers).

## EP\_OUTPUT CONFIGURATION REGISTER

This register is used to control the mono earpiece output.<sup>(1)</sup>

**Table 29. EP\_OUTPUT (0x16h)**

Bits	Field	Description
0	SIDETONE_SELECT	If set, the sidetone channel of the mixer is added to the earpiece output signal.
1	CPI_SELECT	If set, the cell phone input channel of the mixer is added to the earpiece output signal.
2	RIGHT_SELECT	If set, the right channel of the mixer is added to the earpiece output signal.
3	LEFT_SELECT	If set, the left channel of the mixer is added to the earpiece output signal.
4	EP_MUTE	If set, the earpiece output is muted.

(1) The gain of the earpiece output amplifier is 6 dB.

## DETECT CONFIGURATION REGISTER

This register is used to control the headset detection system.

**Table 30. DETECT (0x17h)**

Bits	Field	Description																																		
0	DET_INT	If set, an IRQ is raised when a change is detected in the headset status. Clearing this bit will clear an IRQ that has been triggered by the headset detect.																																		
1	BTN_INT	If set, an IRQ is raised when the headset button is pressed. Clearing this bit will clear an IRQ that has been triggered by a button event.																																		
2	TEMP_INT	If set, an IRQ is raised during a temperature event. The LM49370 will still automatically cycle the class AB power amplifiers off if the internal temperature is too high. This bit should not be set whenever the class D amplifier is turned on. Clearing this bit will clear an IRQ that has been triggered by a temperature event.																																		
6:3	HS_DBNC_TIME	This sets the time used for debouncing the analog signals from the detection inputs used to sense the insertion/removal of a headset.																																		
		<table border="1"> <thead> <tr> <th>HS_DBNC_TIME</th> <th>Time (ms)</th> </tr> </thead> <tbody> <tr><td>0000<sub>2</sub></td><td>0</td></tr> <tr><td>0001<sub>2</sub></td><td>8</td></tr> <tr><td>0010<sub>2</sub></td><td>16</td></tr> <tr><td>0011<sub>2</sub></td><td>32</td></tr> <tr><td>0100<sub>2</sub></td><td>48</td></tr> <tr><td>0101<sub>2</sub></td><td>64</td></tr> <tr><td>0110<sub>2</sub></td><td>96</td></tr> <tr><td>0111<sub>2</sub></td><td>128</td></tr> <tr><td>1000<sub>2</sub></td><td>192</td></tr> <tr><td>1001<sub>2</sub></td><td>256</td></tr> <tr><td>1010<sub>2</sub></td><td>384</td></tr> <tr><td>1011<sub>2</sub></td><td>512</td></tr> <tr><td>1100<sub>2</sub></td><td>768</td></tr> <tr><td>1101<sub>2</sub></td><td>1024</td></tr> <tr><td>1110<sub>2</sub></td><td>1536</td></tr> <tr><td>1111<sub>2</sub></td><td>2048</td></tr> </tbody> </table>	HS_DBNC_TIME	Time (ms)	0000 <sub>2</sub>	0	0001 <sub>2</sub>	8	0010 <sub>2</sub>	16	0011 <sub>2</sub>	32	0100 <sub>2</sub>	48	0101 <sub>2</sub>	64	0110 <sub>2</sub>	96	0111 <sub>2</sub>	128	1000 <sub>2</sub>	192	1001 <sub>2</sub>	256	1010 <sub>2</sub>	384	1011 <sub>2</sub>	512	1100 <sub>2</sub>	768	1101 <sub>2</sub>	1024	1110 <sub>2</sub>	1536	1111 <sub>2</sub>	2048
HS_DBNC_TIME	Time (ms)																																			
0000 <sub>2</sub>	0																																			
0001 <sub>2</sub>	8																																			
0010 <sub>2</sub>	16																																			
0011 <sub>2</sub>	32																																			
0100 <sub>2</sub>	48																																			
0101 <sub>2</sub>	64																																			
0110 <sub>2</sub>	96																																			
0111 <sub>2</sub>	128																																			
1000 <sub>2</sub>	192																																			
1001 <sub>2</sub>	256																																			
1010 <sub>2</sub>	384																																			
1011 <sub>2</sub>	512																																			
1100 <sub>2</sub>	768																																			
1101 <sub>2</sub>	1024																																			
1110 <sub>2</sub>	1536																																			
1111 <sub>2</sub>	2048																																			

## HEADSET DETECT OVERVIEW

The LM49370 has built in monitors to automatically detect headset insertion or removal. The detection scheme can differentiate between mono, stereo, mono-cellular and stereo-cellular headsets. Upon detection of headset insertion or removal, the LM49370 updates read-only bit 0 - headset absence/presence, bit 1- mono/stereo headset and bit 2 - headset without mic / with mic, of the STATUS register (0x18h). Headset insertion/removal and headset type can also be detected in standby mode; this consumes no analog supply current when the headset is absent.

The LM49370 can be programmed to raise an interrupt (set the IRQ pin high) when headset insert/removal is sensed by setting bit 0 of DETECT (0x17h). When headset detection is enabled in active mode and a headset is not detected, the HPL\_OUT and HPR\_OUT amplifiers will be disabled (switched off for capless mode and muted for AC-coupled mode) and the EXT\_BIAS pin will be disconnected from the MIC\_BIAS amplifier, irrespective of control register settings.

The LM49370 also has the capability to detect button press, when a button is present on the headset microphone. Both parallel button-type (in parallel with the headset microphone, default value) and series button-type (in series with the headset microphone) can be detected; the button type used needs to be defined in bit 3 of MIC\_2 (0x0Ch). Button press can also be detected in stand-by mode; this consumes 10  $\mu$ A of analog supply current for a series type push button and 100  $\mu$ A for a parallel type push button. Upon button press, the LM49370 updates bit 3 of STATUS (0x18h). In active OCL mode, with internal microphone selected (INT\_EXT = 0; reg 0x0Bh), if a parallel pushbutton headset is inserted into the system, INT\_EXT must be set high before BTN (bit 3 of STATUS (0x18h)) can be read. The LM49370 can also be programmed to raise an interrupt on the IRQ pin when button press is sensed by setting bit 1 of DETECT (0x17h).

The LM49370 provides debounce programmability for headset and button detect. Debounce programmability can be used to reject glitches generated, and hence avoid false detection, while inserting/removing a headset or pressing a button.

Headset insert/removal debounce time is defined by HS\_DBNC\_TIME; bits 6:3 of DETECT (0x17h). Parallel button press debounce time is defined by BTN\_DBNC\_TIME; bits 5:4 of MIC\_2 (0x0Ch).

Note that since the first effect of a series button press (microphone disconnected) is indistinguishable from headset removal, the debounce time for series button press is defined by HS\_DBNC\_TIME.

Headset and push button detection can be enabled by setting CHIP\_MODE 0; bit 0 of BASIC (0x00h). For reliable headset / push button detection all following bits should be defined before enabling the headset detection system:

1. the OCL-bit (AC-Coupled / Capless headphone interface (bit 6 of HP\_OUTPUT (0x15h))
2. the headset insert/removal debounce settings (bit 6:3 of DETECT (0x17h))
3. the BTN\_TYPE-bit (Parallel / Series push button type (bit 3 of MIC\_2 (0x0Ch))
4. the parallel push button debounce settings (bit 5:4 of MIC\_2 (0x0Ch))

Figure 16 shows terminal connections and jack configuration for various headsets. Care should be taken to avoid any DC path from the MIC\_DET pin to ground when a headset is not inserted.

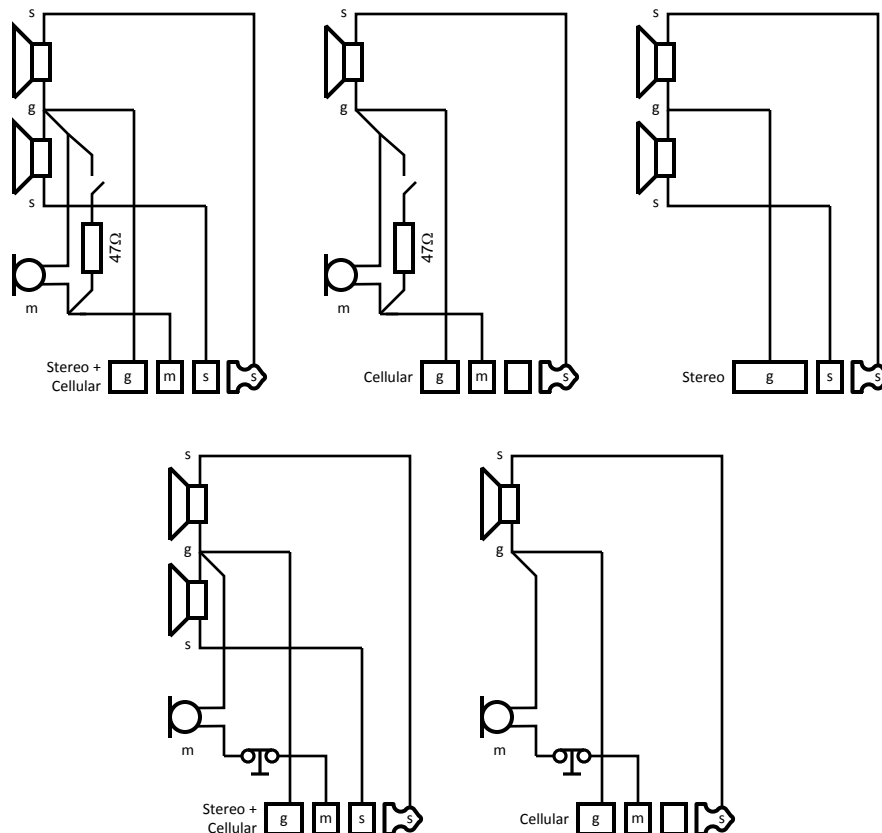
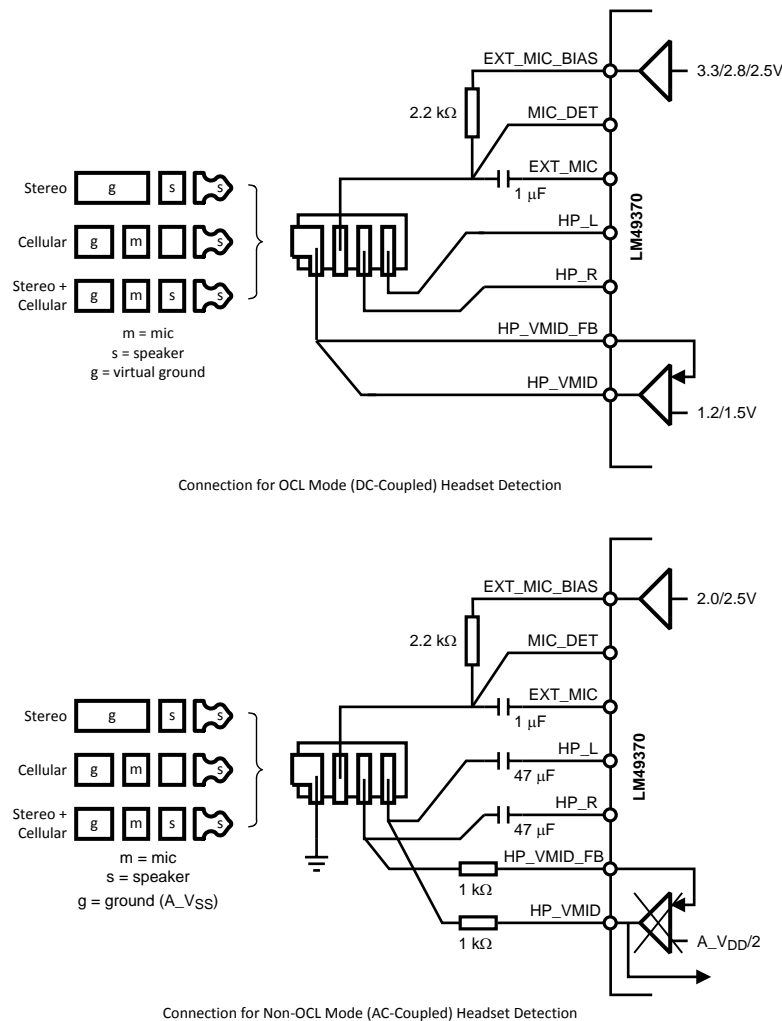

Figure 16. Headset Configurations Supported by the LM49370

The wiring of the headset jack to the LM49370 will depend on the intended mode of the headphone amplifier:



**Figure 17. Connection of Headset Jack to LM49370 Depends on the Mode of the Headphone Amplifier.**

In non-OCL mode, two 1kΩ resistors are optional and not needed if chip is active without headset event detection in Basic Register (0x00h) bits 1:0. If chip is active with headset event detection, these two resistors set an internal threshold voltage for a comparator that produces the headphone detect pulse. The value of these should be 1kΩ with tolerance of ±10% or better.

## STATUS REGISTER

This register is used to report the status of the device.

**Table 31. STATUS (0x18h)<sup>(1)(2)</sup>**

Bits	Field	Description
0	HEADSET	This field is high when headset presence is detected (only valid if the detection system is enabled). <sup>(1)</sup>
1	STEREO_HEADSET	This field is high when a headset with stereo speakers is detected (only valid if the detection system is enabled). <sup>(1)</sup>
2	MIC	This field is high when a headset with a microphone is detected (only valid if the detection system is enabled). <sup>(1)</sup>

(1) The detection IRQ is cleared when this register has been written to.

(2) This field is cleared whenever the STATUS (0x18h) register has been written to.

**Table 31. STATUS (0x18h)<sup>(1)(2)</sup> (continued)**

Bits	Field	Description
3	BTN	This field is high when the button on the headset is pressed (only valid if the detection system is enabled). IRQ is cleared when the button has been released <b>and</b> this register has been written to. <sup>(2)</sup>
4	TEMP	If this field is high then a temperature event has occurred (write to this register to clear IRQ). This field will stay high even when the IRQ is cleared so long as the event occurs. This bit is only valid whenever the loudspeaker amplifier is turned off. <sup>(2)</sup>
5	GPIN1	When GPIO_SEL is set to a readable configuration a digital input on GPIO1 can be read back here.
6	GPIN2	When GPIO_SEL is set to a readable configuration, a digital input on the relevant GPIO can be read back here.

### 3D CONFIGURATION REGISTER

This register is used to control the configuration of the 3D circuit.

**Table 32. 3D (0x19h)**

Bits	Field	Description
0	3D_ENB	Setting this bit enables the 3D effect. When cleared to zero, the 3D effect is disabled and the 3D module then passes the I <sup>2</sup> S left and right channel inputs to the DAC unchanged. The stereo AUX inputs are unaffected by the 3D module.
1	3D_TYPE	This bit selects between type 1 and type 2 3D sound effect. Clearing this bit to zero selects type 1 effect and setting it to one selects type 2. Type1: Rout = Ri-G*Lout3d, Lout = Li-G*Rout3d Type2: Rout = -Ri-G*Lout3d, Lout = Li+G*Rout3d where, Ri = Right I <sup>2</sup> S channel input Li = Left I <sup>2</sup> S channel input G = 3D gain level (Mix ratio) Rout3d = Ri filtered through a high-pass filter with a corner frequency controlled by FREQ Lout3d = Li filtered through a high-pass filter with a corner frequency controlled by FREQ
3:2	LEVEL	This programs the level of 3D effect that is applied.
		LEVEL
		00 <sub>2</sub> 25%
		01 <sub>2</sub> 37.5%
		10 <sub>2</sub> 50%
		11 <sub>2</sub> 75%
5:4	FREQ	This programs the HPF rolloff (-3dB) frequency of the 3D effect.
		FREQ
		00 <sub>2</sub> 0Hz
		01 <sub>2</sub> 300Hz
		10 <sub>2</sub> 600Hz
		11 <sub>2</sub> 900Hz
6	ATTENUATE	Clearing this bit to zero maintains the level of the left and right input channels at the output. Setting this bit to one attenuates the output level by 50%. This may be appropriate for high level audio inputs when type 2 3D effect is used. Type 2 effect involves adding the same polarity of left and right inputs to give the final outputs. Type 2 effect has the potential for creating a clipping condition, however this bit offers an alternative to clipping.
7	CUST_COMP	If set, the DAC compensation filter may be programmed by the user through registers (0x20h) to( 0x25h). Otherwise, the defaults are used.

## I2S PORT MODE CONFIGURATION REGISTER

This register is used to control the audio data interfaces.

**Table 33. I2S Mode (0x1Ah)**

Bit s	Field	Description
0	I2S_OUT_ENB	If set, the I <sup>2</sup> S output bus is enabled. If cleared, the I <sup>2</sup> S output will be tristate and all RX clocks will be gated.
1	I2S_IN_ENB	If set, the I <sup>2</sup> S input is enabled. If this bit cleared, the I <sup>2</sup> S input is ignored and all TX clocks gated.
2	I2S_MODE	This programs the format of the I <sup>2</sup> S interface.
		Definition
	0	Normal
	1	Left Justified
3	I2S_STEREO_REVERSE	If set, the left and right channels are reversed.
		Operation
	0	Normal
	1	Reversed
4	I2S_WS_MS	If set, I2S_WS generation is enabled and is Master. If cleared, I2S_WS acts as slave.
6:5	I2S_WS_GEN_MODE	This programs the I <sup>2</sup> S word length.
		Bits/Word
	00 <sub>2</sub>	16
	01 <sub>2</sub>	25
	10 <sub>2</sub>	32
	11 <sub>2</sub>	—
7	I2S_WORD_ORDER	This bit alters the RX phasing of left and right channels. If this bit is cleared: right then left. If this bit is set: left then right.

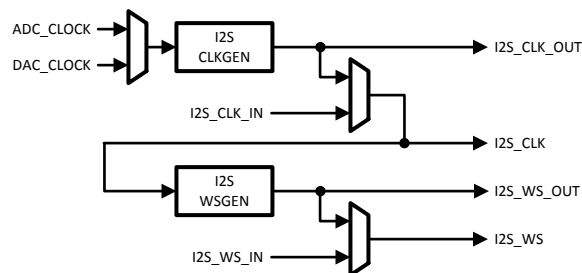

**Figure 18. I2S Audio Port CLOCK/SYNC Options**

## I2S PORT CLOCK CONFIGURATION REGISTER

This register is used to control the audio data interfaces.

**Table 34. I2S Clock (0x1Bh)**

Bit s	Field	Description
0	I2S_CLOCK_MS	If set, then I <sup>2</sup> S clock generation is enabled and is Master. If this bit is cleared, then the I <sup>2</sup> S clock is driven by the device slave.
1	I2S_CLOCK_SOURCE	This selects the source of the clock to be used by the I2S clock generator.
	I2S_CLOCK_SOURCE	Clock is source from
	0	DAC (from R divider)
	1	ADC (from Q divider)

**Table 34. I2S Clock (0x1Bh) (continued)**

Bits	Field	Description		
5:2	I2S_CLOCK_GEN_MODE	This programs a clock divider that divides the clock defined by I2S_CLOCK_SOURCE. This divided clock is used to generate I2S_CLK in Master mode. <sup>(1)</sup>		
		Value	Divide By	Ratio
		0000 <sub>2</sub>	1	
		0001 <sub>2</sub>	2	
		0010 <sub>2</sub>	4	
		0011 <sub>2</sub>	6	
		0100 <sub>2</sub>	8	
		0101 <sub>2</sub>	10	
		0110 <sub>2</sub>	16	
		0111 <sub>2</sub>	20	—
		1000 <sub>2</sub>	2.5	2/5
		1001 <sub>2</sub>	3	1/3
		1010 <sub>2</sub>	3.90625	32/125
		1011 <sub>2</sub>	5	25/125
		1100 <sub>2</sub>	7.8125	16/125
7:6	PCM_SYNC_WIDTH	This programs the width of the PCM sync signal.		
		Generated SYNC Looks like:		
		00 <sub>2</sub>	1 bit (Used for Short PCM Modes)	
		01 <sub>2</sub>	4 bits (Used for Long PCM Modes)	
		10 <sub>2</sub>	8 bits (Used for Long PCM Modes)	
		11 <sub>2</sub>	15 bits (Used for Long PCM Modes) Should not be set if the bits/word is less than 16.	

(1) For DAC\_MODE = '00', '10', '11', DAC\_CLOCK is the clock at the output of the R divider. For DAC\_MODE = '01', DAC\_CLOCK is a divided by two version of the clock at the output of the R divider.

**DIGITAL AUDIO DATA FORMATS**

I<sup>2</sup>S master mode can only be used when the DAC is enabled unless the FORCE\_RQ bit is set. PCM Master mode can only be used when the ADC is enabled, unless the FORCE\_RQ bit is set. If the PCM receiver interface is operated in slave mode the clock and sync should be enabled at the same time because the PCM receiver uses the first PCM frame to calculate the PCM interface format. This format can not be changed unless a soft reset is issued. Operating the LM49370 in master mode eliminates the risk of sample rate mismatch between the data converters and the audio interfaces.

In slave mode, the PCM and I<sup>2</sup>S receivers only record the 1st 16 and 18 bits of the serial words respectively. The I<sup>2</sup>S and PCM formats are as followed:

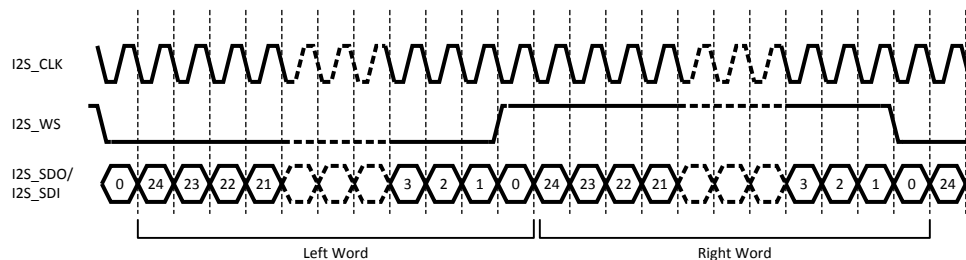

**Figure 19. I<sup>2</sup>S Serial Data Format (Default Mode)**

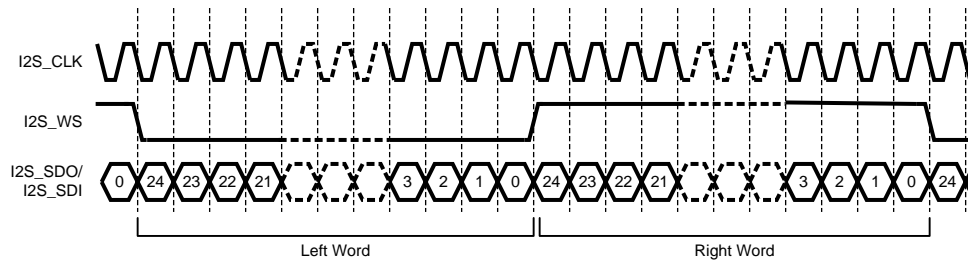

**Figure 20. I<sup>2</sup>S Serial Data Format (Left Justified)**

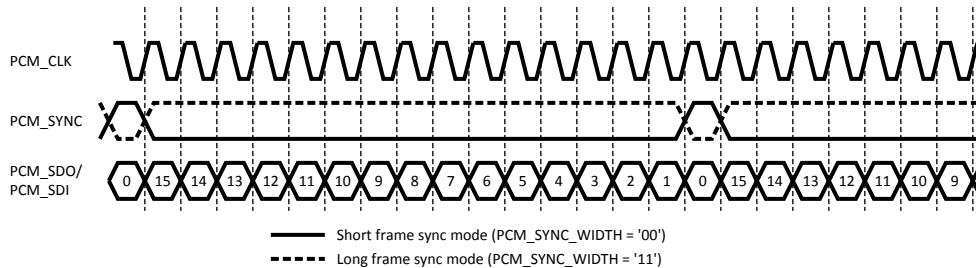

**Figure 21. PCM Serial Data Format (16 bit Slave Example)**

## PCM PORT MODE CONFIGURATION REGISTER

This register is used to control the audio data interfaces.

**Table 35. PCM MODE (0x1Ch)**

Bits	Field	Description
0	PCM_OUT_ENB	If set, the PCM output bus is enabled. If this bit is cleared, the PCM output will be tristate and all RX clocks will be gated.
1	PCM_IN_ENB	If set, the PCM input is enabled. If this bit is cleared, the PCM input is ignored and TX clocks are generated.
3	PCM_CLOCK_SOURCE	DAC or ADC Clock 0 = DAC, 1 = ADC <sup>(1)</sup>
4	PCM_SYNC_MS	If set, PCM_SYNC generation is enabled and is driven by the device (Master).
5	PCM_SDO_LSB_HZ	If set, when the PCM port has run out of bits to transmit, it will tristate the SDO output.
6	PCM_COMPAND	If set, the data sent to the PCM port is companded and the PCM data received by the PCM receiver is treated as companded data.
7	PCM_ALAW_μLAW	If PCM_COMPAND is set, then the data across the PCM interface to the DAC and from the ADC is companded as follows:
	PCM_ALAW_μLAW	Commanding Type
	0	μ-LAW
	1	A-Law

(1) For DAC\_MODE = '00', '10', '11', DAC\_CLOCK is the clock at the output of the R divider. For DAC\_MODE = '01', DAC\_CLOCK is a divided by two version of the clock at the output of the R divider.



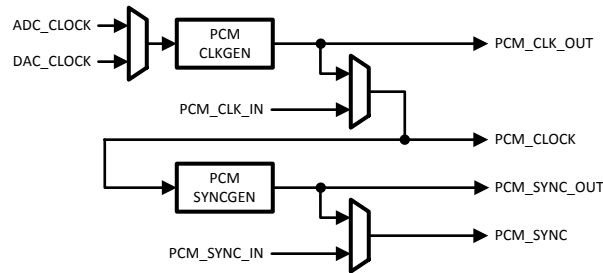

Figure 22. PCM Audio Port CLOCK/SYNC Options

PCM PORT CLOCK CONFIGURATION REGISTER

This register is used to control the configuration of audio data interfaces.

Table 36. PCM Clock (0x1Dh)

Bits	Field	Description		
3:0	PCM_CLOCK_GEN_MODE	This programs a clock divider that divides the clock defined by PCM_CLOCK_SOURCE reg(0x1Ch). The divided clock is used to generate PCM_CLK in Master mode. <sup>(1)</sup>		
		Value	Divide By	Ratio
		0000 <sub>2</sub>	1	
		0001 <sub>2</sub>	2	
		0010 <sub>2</sub>	4	
		0011 <sub>2</sub>	6	
		0100 <sub>2</sub>	8	
		0101 <sub>2</sub>	10	
		0110 <sub>2</sub>	16	
		0111 <sub>2</sub>	20	—
		1000 <sub>2</sub>	2.5	2/5
		1001 <sub>2</sub>	3	1/3
		1010 <sub>2</sub>	3.90625	32/125
		1011 <sub>2</sub>	5	25/125
		1100 <sub>2</sub>	7.8125	16/125
		6:4	PCM_SYNC_MODE	This programs a clock divider that divides PCM_CLK. The divided clock is used to generate PCM_SYNC.
Value	Divide By			
000 <sub>2</sub>	8			
001 <sub>2</sub>	16			
010 <sub>2</sub>	25			
011 <sub>2</sub>	32			
100 <sub>2</sub>	64			
101 <sub>2</sub>	128			
110 <sub>2</sub>	—			
111 <sub>2</sub>	—			

(1) For DAC\_MODE = '00', '10', '11', DAC\_CLOCK is the clock at the output of the R divider. For DAC\_MODE = '01', DAC\_CLOCK is a divided by two version of the clock at the output of the R divider.

**SRC CONFIGURATION REGISTER**

This register is used to control the configuration of the Digital Routing interfaces. <sup>(2)</sup>

**Table 37. Bridges (0x1Eh)**

Bits	Field	Description	
0	PCM_TX_SEL	This controls the data sent to the PCM transmitter.	
		PCM_TX_SEL	<b>Source</b>
		0	ADC
		1	MONO SUM Circuit
2:1	I2S_TX_SEL	This controls the data sent to the I <sup>2</sup> S transmitter.	
		I2S_TX_SEL	<b>Source</b>
		00 <sub>2</sub>	ADC
		01 <sub>2</sub>	PCM Receiver
		10 <sub>2</sub>	DAC Interpolator (oversampled)
11 <sub>2</sub>	Disabled		
4:3	DAC_INPUT_SEL	This controls the data sent to the DAC.	
		DAC_INPUT_SEL	<b>Source</b>
		00 <sub>2</sub>	I2S Receiver (In stereo)
		01 <sub>2</sub>	PCM Receiver (Dual Mono)
		10 <sub>2</sub>	ADC
11 <sub>2</sub>	Disabled		
5	MONO_SUM_SEL	This controls the data sent to the Stereo to Mono Converter	
		MONO_SUM_SEL	<b>Source</b>
		0	DAC Interpolated Output
1	I2S Receiver Output		
7:6	MONO_SUM_MODE	This controls the operation of the Stereo to Mono Converter.	
		MONO_SUM_MODE	<b>Operation</b>
		00 <sub>2</sub>	(Left + Right)/2
		01 <sub>2</sub>	Left
		10 <sub>2</sub>	Right
11 <sub>2</sub>	(Left + Right)/2		

(2) Please refer to the Application Note AN-1591 ([SNAA039](#)) for the detailed discussion on how to use the I<sup>2</sup>S to PCM Bridge.

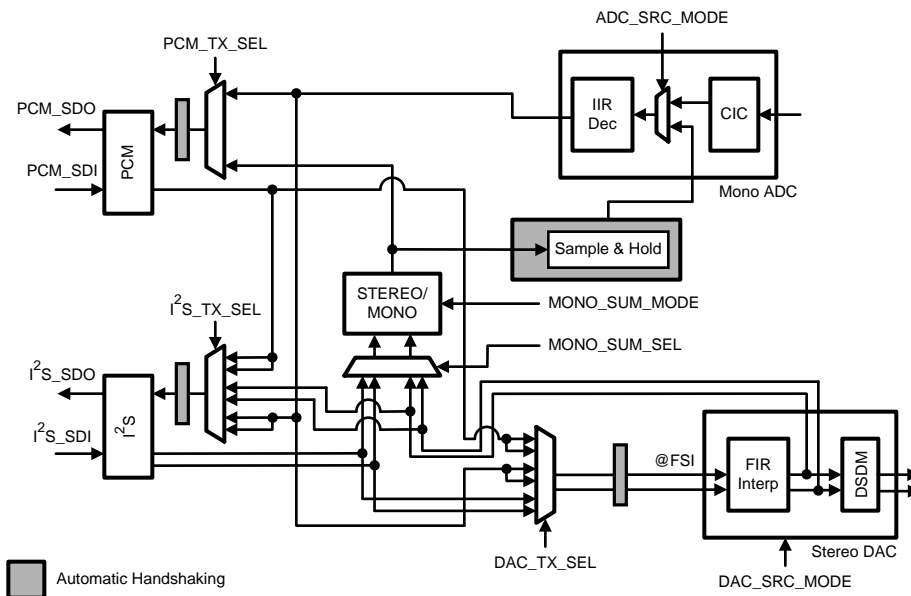

Figure 23. I²S to PCM Bridge

**GPIO CONFIGURATION REGISTER**

This register is used to control the GPIOs and to control the digital signal routing when using the ADC and DAC to perform sample rate conversion.

Table 38. GPIO Control (0x1Fh)

Bits	Field	Description		
2:0	GPIO_1_SEL	This configures the GPIO_1 pin.		
		<b>GPIO_1_SEL</b>	<b>Does What?</b>	<b>Direction</b>
		000 <sub>2</sub>	Disable	HiZ
		001 <sub>2</sub>	SPI_SDO	Output
		010 <sub>2</sub>	Output 0	Output
		011 <sub>2</sub>	Output 1	Output
		100 <sub>2</sub>	Read	Input
		101 <sub>2</sub>	Class D Enable	Output
		110 <sub>2</sub>	AUX Enable	Output
111 <sub>2</sub>	Dig_Mic_Data	Input		
5:3	GPIO_2_SEL	This configures the GPIO_2 pin.		
		<b>GPIO_2_SEL</b>	<b>Does What?</b>	<b>Direction</b>
		000 <sub>2</sub>	Disable	HiZ
		001 <sub>2</sub>	SPI_SDO	Output
		010 <sub>2</sub>	Output 0	Output
		011 <sub>2</sub>	Output 1	Output
		100 <sub>2</sub>	Read	Input
		101 <sub>2</sub>	Class D Enable	Output
		110 <sub>2</sub>	Dig_Mic L Clock	Output
111 <sub>2</sub>	Dig_Mic R Clock	Output		
6	ADC_SRC_MODE	If set, the ADC analog is disabled and the digital is enabled, using the resampler input.		
7	DAC_SRC_MODE	This does not have to be set to use DAC in SRC mode, but should be set if the user wishes to disable the DAC analog to save power.		

## DAC PATH COMPENSATION FIR CONFIGURATION REGISTERS

To allow for compensation of roll off in the DAC and analog filter sections an FIR compensation filter is applied to the DAC input data at the original sample rate. Since the DAC can operate at different over sampling ratios the FIR compensation filter is programmable. By default the filter applies approx 2dB of compensation at 20kHz. 5 taps is sufficient to allow passband equalization and ripple cancellation to around +/-0.01dB.

The filter can also be used for precise digital gain and simple tone controls although a DSP or CPU should be used for more powerful tone control if required. As the FIR filter must always be phase linear, the coefficients are symmetrical. Coefficients C0, C1, and C2 are programmable, C3 is equal to C1 and C4 is equal to C0. The maximum power of this filter must not exceed that of the examples given below:

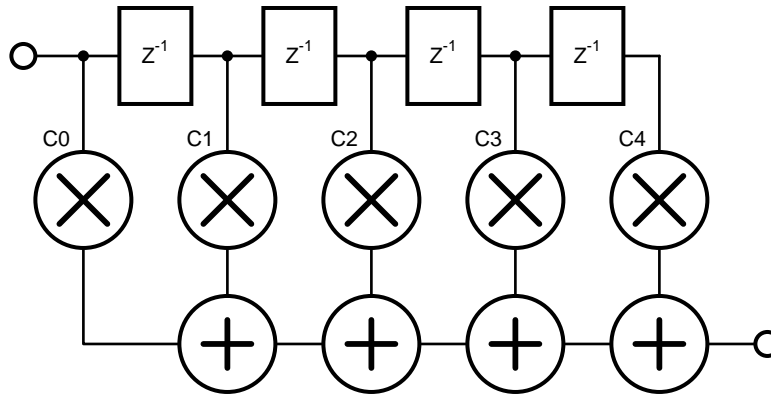

Figure 24. FIR Consumption Filter Taps

Sample Rate	DAC_MODE	C0	C1	C2	C3	C4
48kHz	00	334	-2291	26984	-2291	343
48kHz	01	61	-371	25699	-371	61

For DAC\_MODE = '00' and '01', the defaults should be sufficient; but for DAC\_MODE = '10' and '11', care should be taken to ensure the widest bandwidth is available without requiring such a large attenuation at DC that inband noise becomes audible.

Table 39. Compensation Filter C0 LSBs (0x20h)

Bits	Field	Description
7:0	C0_LSB	Bits 7:0 of C0[15:0]

Table 40. Compensation Filter C0 MSBs (0x21h)

Bits	Field	Description
7:0	C0_MSB	Bits 15:8 of C0[15:0]

Table 41. Compensation Filter C1 LSBs (0x22h)

Bits	Field	Description
7:0	C1_LSB	Bits 7:0 of C1[15:0]

Table 42. Compensation Filter C1 MSBs (0x23h)

Bits	Field	Description
7:0	C1_MSB	Bits 15:8 of C1[15:0]

Table 43. Compensation Filter C2 LSBs (0x24h)

Bits	Field	Description
7:0	C2_LSB	Bits 7:0 of C2[15:0]

**Table 44. Compensation Filter C2 MSBs (0x25h)**

Bits	Field	Description
7:0	C2_MSB	Bits 15:8 of C2[15:0]

### Typical Performance Characteristics

(For all performance curves  $AV_{DD}$  refers to the voltage applied to the  $A_{V_{DD}}$  and  $LS_{V_{DD}}$  pins.  $DV_{DD}$  refers to the voltage applied to the  $D_{V_{DD}}$  and  $PLL_{V_{DD}}$  pins;  $AV_{DD} = 3.3V$  and  $DV_{DD} = 3.3V$  unless otherwise specified.)

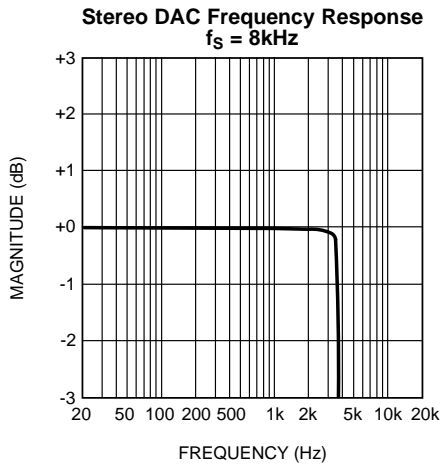

Figure 25.

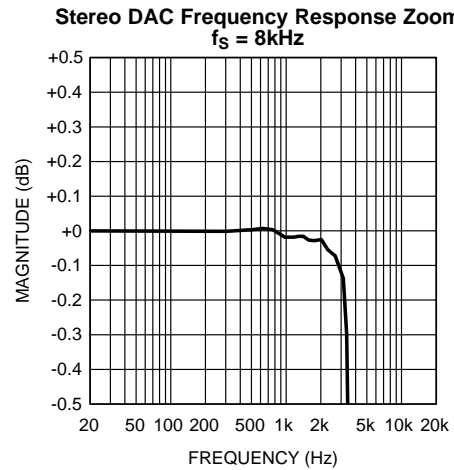

Figure 26.

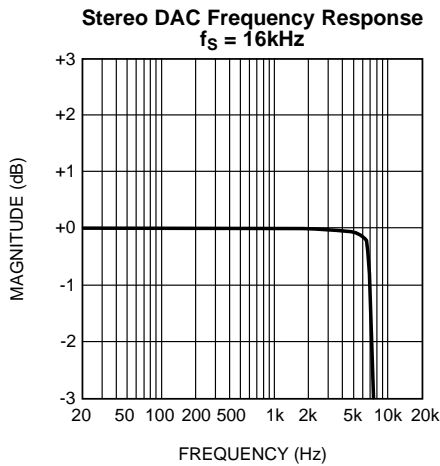

Figure 27.

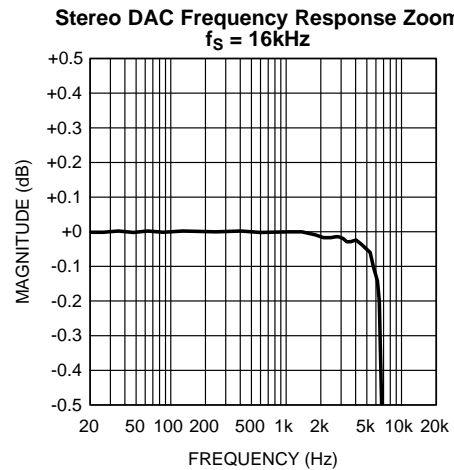

Figure 28.

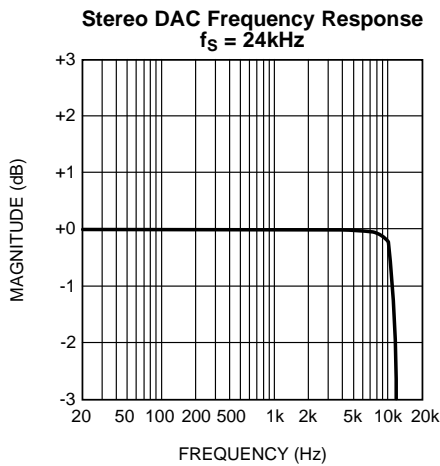

Figure 29.

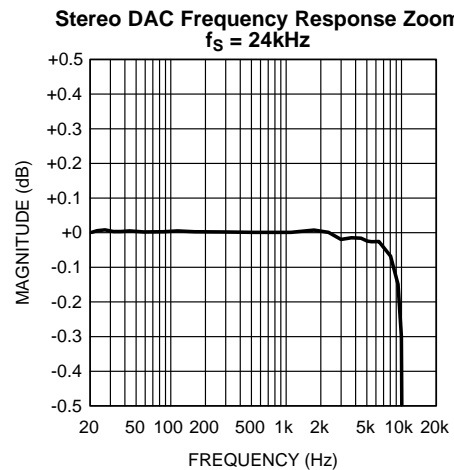

Figure 30.

**Typical Performance Characteristics (continued)**

(For all performance curves  $AV_{DD}$  refers to the voltage applied to the  $A_{V_{DD}}$  and  $LS_{V_{DD}}$  pins.  $DV_{DD}$  refers to the voltage applied to the  $D_{V_{DD}}$  and  $PLL_{V_{DD}}$  pins;  $AV_{DD} = 3.3V$  and  $DV_{DD} = 3.3V$  unless otherwise specified.

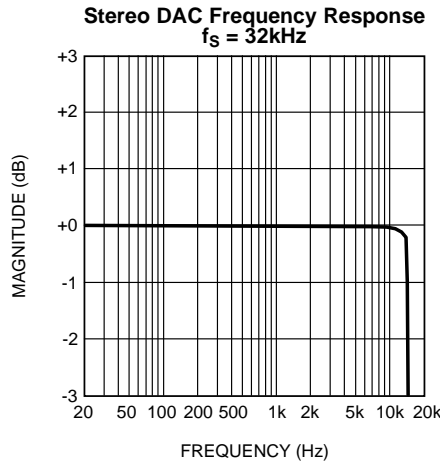

Figure 31.

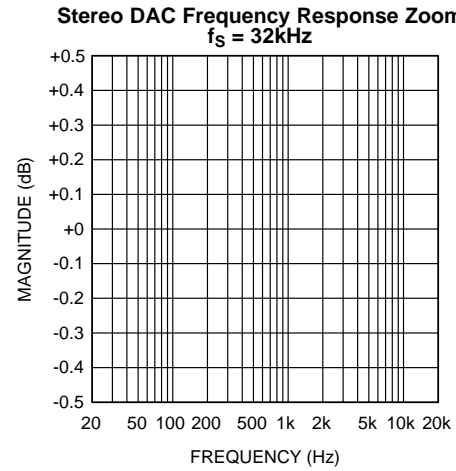

Figure 32.

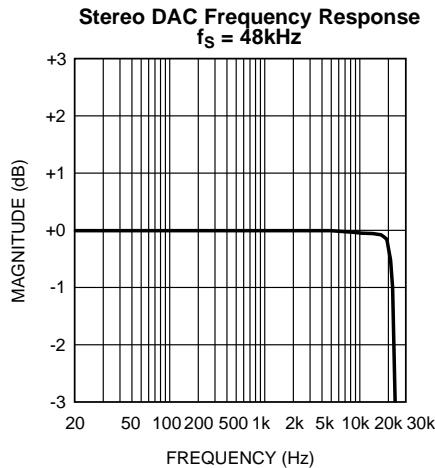

Figure 33.

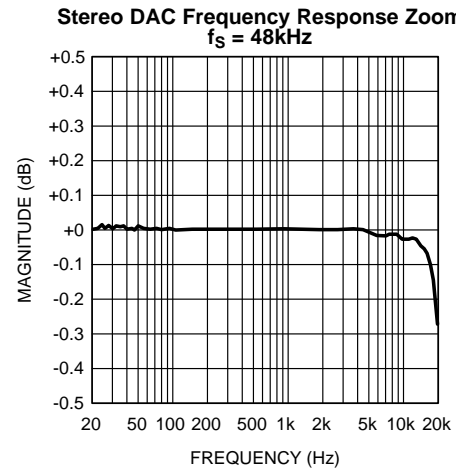

Figure 34.

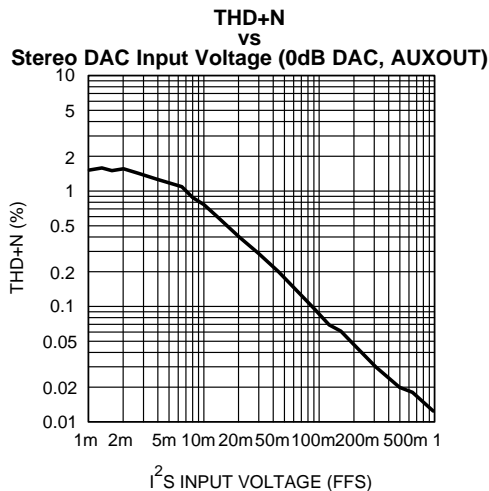

Figure 35.

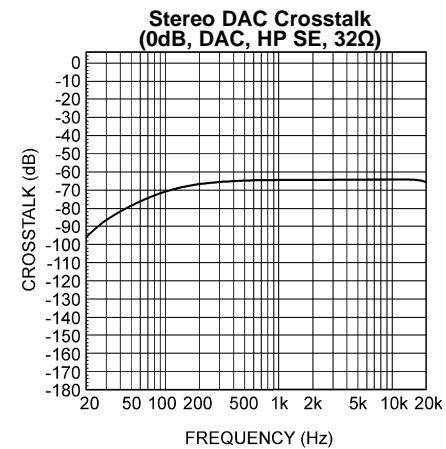

Figure 36.

**Typical Performance Characteristics (continued)**

(For all performance curves  $AV_{DD}$  refers to the voltage applied to the  $A_{V_{DD}}$  and  $LS_{V_{DD}}$  pins.  $DV_{DD}$  refers to the voltage applied to the  $D_{V_{DD}}$  and  $PLL_{V_{DD}}$  pins;  $AV_{DD} = 3.3V$  and  $DV_{DD} = 3.3V$  unless otherwise specified.

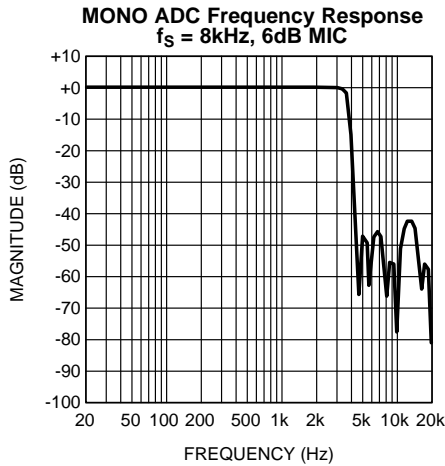

Figure 37.

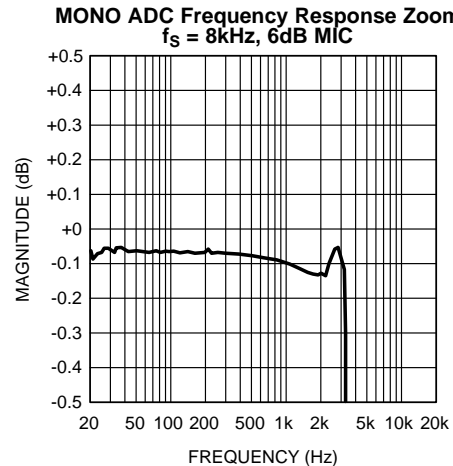

Figure 38.

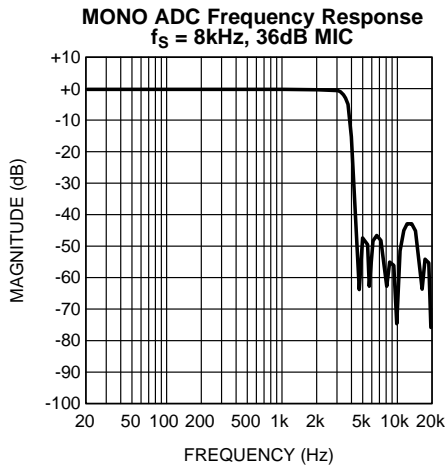

Figure 39.

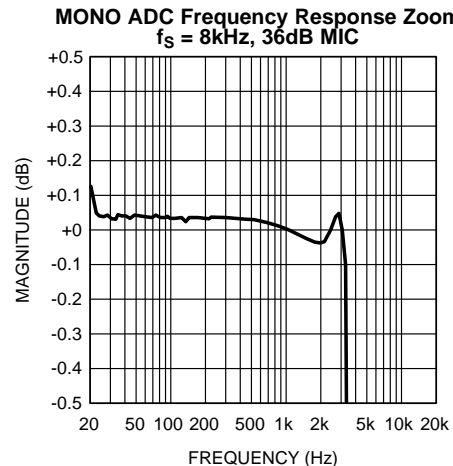

Figure 40.

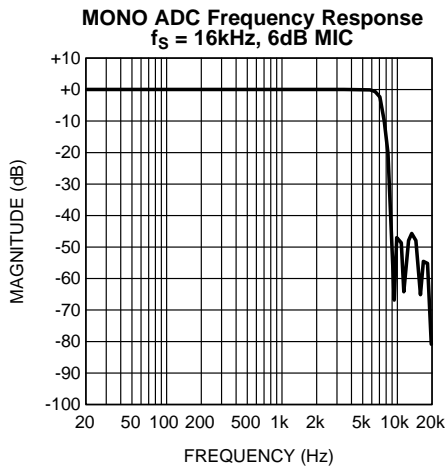

Figure 41.

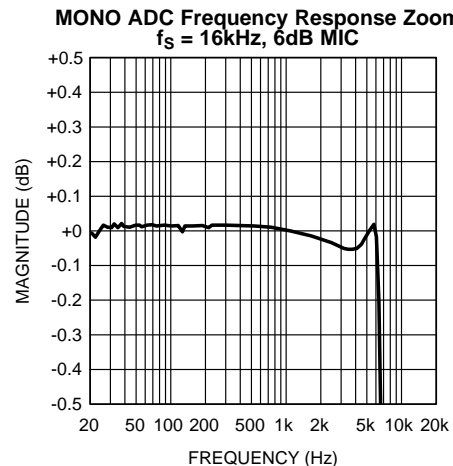

Figure 42.



**Typical Performance Characteristics (continued)**

(For all performance curves  $AV_{DD}$  refers to the voltage applied to the  $A_{V_{DD}}$  and  $LS_{V_{DD}}$  pins.  $DV_{DD}$  refers to the voltage applied to the  $D_{V_{DD}}$  and  $PLL_{V_{DD}}$  pins;  $AV_{DD} = 3.3V$  and  $DV_{DD} = 3.3V$  unless otherwise specified.

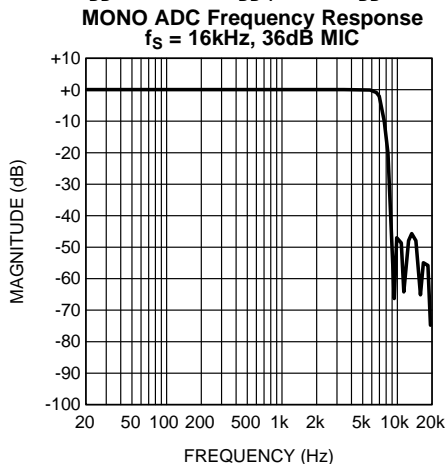

Figure 43.

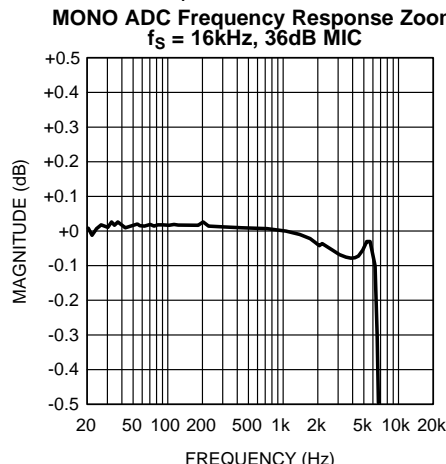

Figure 44.

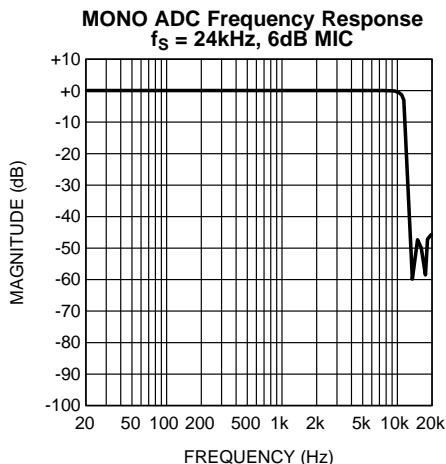

Figure 45.

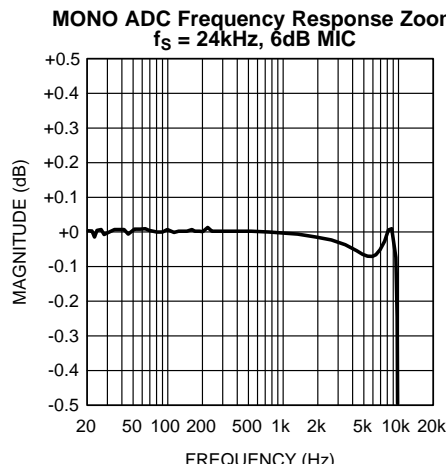

Figure 46.

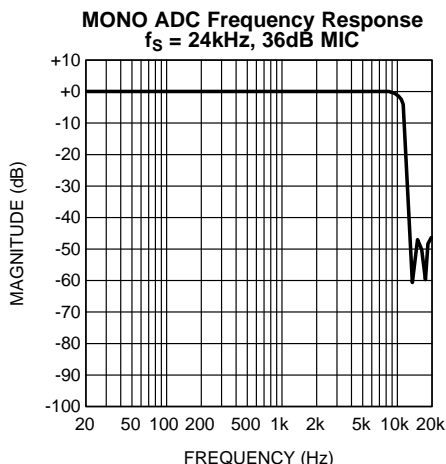

Figure 47.

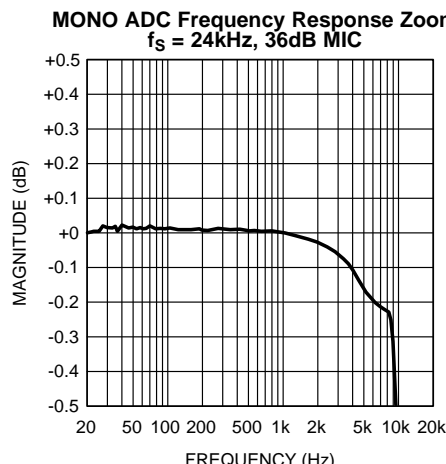

Figure 48.

**Typical Performance Characteristics (continued)**

(For all performance curves  $AV_{DD}$  refers to the voltage applied to the  $A_{V_{DD}}$  and  $LS_{V_{DD}}$  pins.  $DV_{DD}$  refers to the voltage applied to the  $D_{V_{DD}}$  and  $PLL_{V_{DD}}$  pins;  $AV_{DD} = 3.3V$  and  $DV_{DD} = 3.3V$  unless otherwise specified.

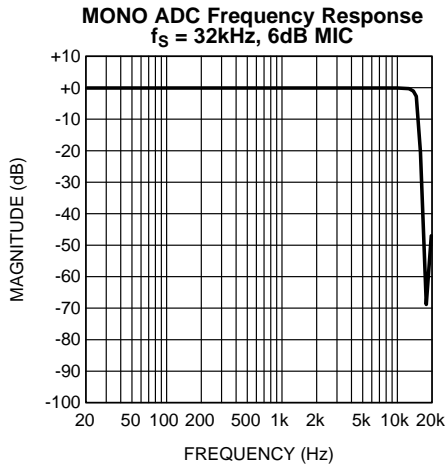

Figure 49.

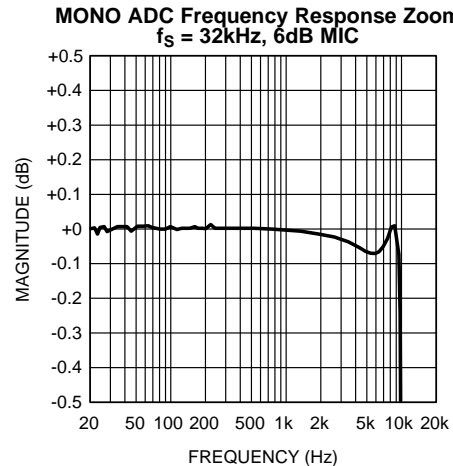

Figure 50.

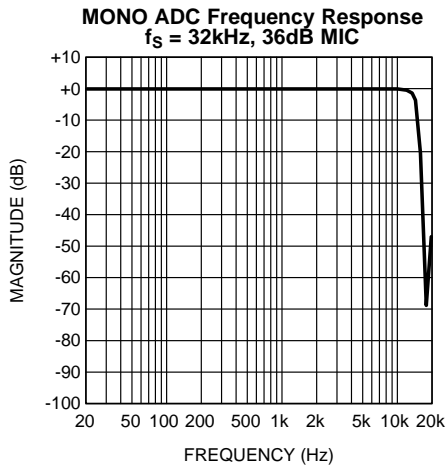

Figure 51.

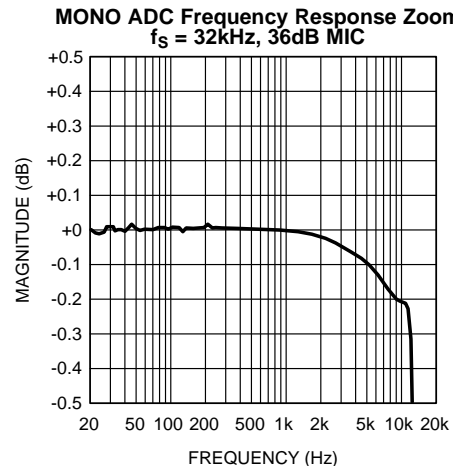

Figure 52.

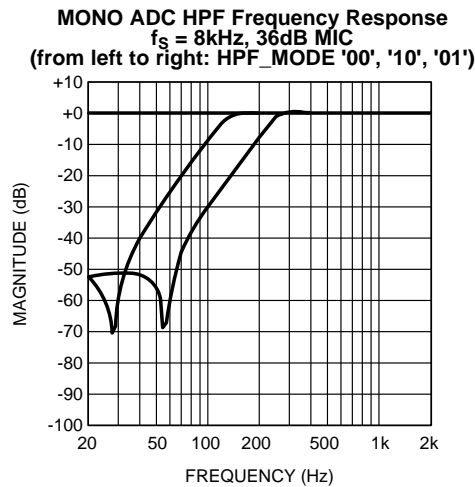

Figure 53.

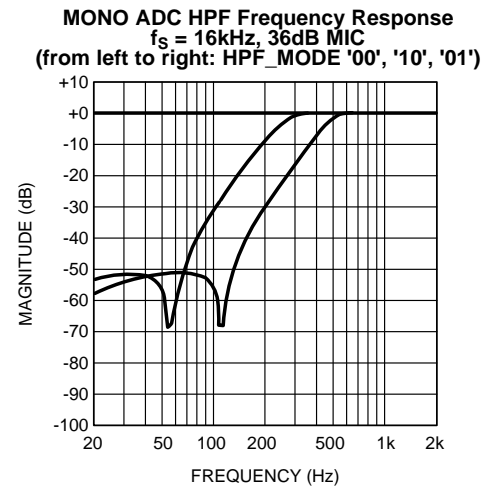

Figure 54.

**Typical Performance Characteristics (continued)**

(For all performance curves  $AV_{DD}$  refers to the voltage applied to the  $A\_V_{DD}$  and  $LS\_V_{DD}$  pins.  $DV_{DD}$  refers to the voltage applied to the  $D\_V_{DD}$  and  $PLL\_V_{DD}$  pins;  $AV_{DD} = 3.3V$  and  $DV_{DD} = 3.3V$  unless otherwise specified.)

**MONO ADC HPF Frequency Response**  
 $f_s = 24kHz$ , 36dB MIC  
 (from left to right: HPF\_MODE '00', '10', '01')

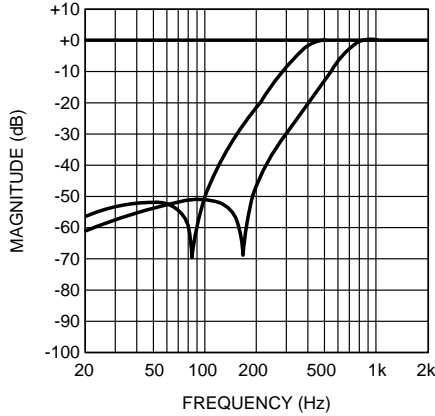

Figure 55.

**MONO ADC HPF Frequency Response**  
 $f_s = 32kHz$ , 36dB MIC  
 (from left to right: HPF\_MODE '00', '10', '01')

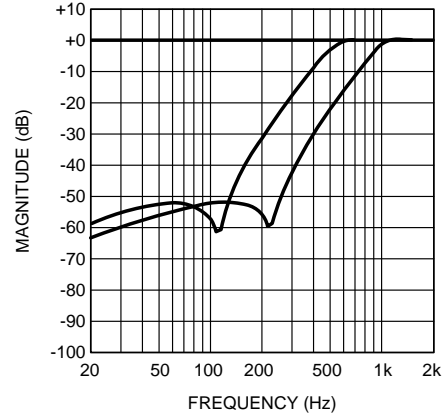

Figure 56.

**MONO ADC THD+N vs MIC Input Voltage**  
 $f_s = 8kHz$ , 6dB MIC

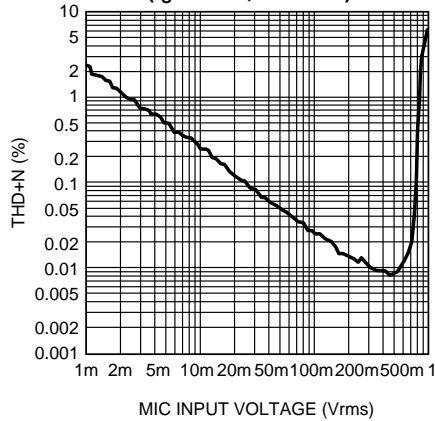

Figure 57.

**MONO ADC THD+N vs MIC Input Voltage**  
 $f_s = 8kHz$ , 36dB MIC

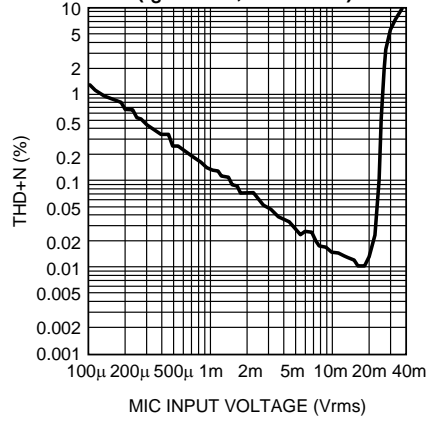

Figure 58.

**MONO ADC PSRR vs Frequency**  
 $AV_{DD} = 3.3V$ , 6dB MIC

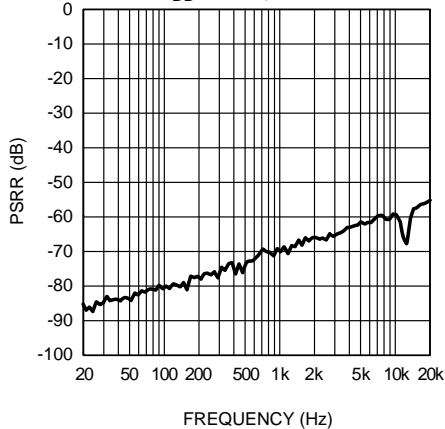

Figure 59.

**MONO ADC PSRR vs Frequency**  
 $AV_{DD} = 5V$ , 6dB MIC

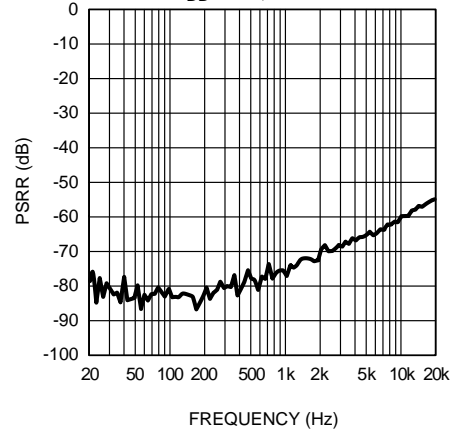

Figure 60.

**Typical Performance Characteristics (continued)**

(For all performance curves  $AV_{DD}$  refers to the voltage applied to the  $A\_V_{DD}$  and  $LS\_V_{DD}$  pins.  $DV_{DD}$  refers to the voltage applied to the  $D\_V_{DD}$  and  $PLL\_V_{DD}$  pins;  $AV_{DD} = 3.3V$  and  $DV_{DD} = 3.3V$  unless otherwise specified.)

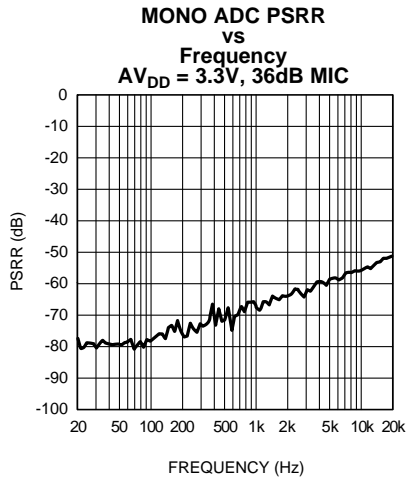

Figure 61.

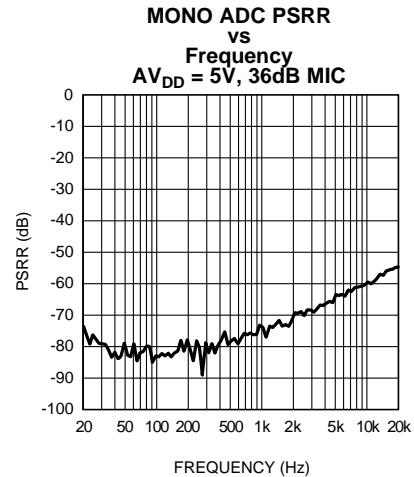

Figure 62.

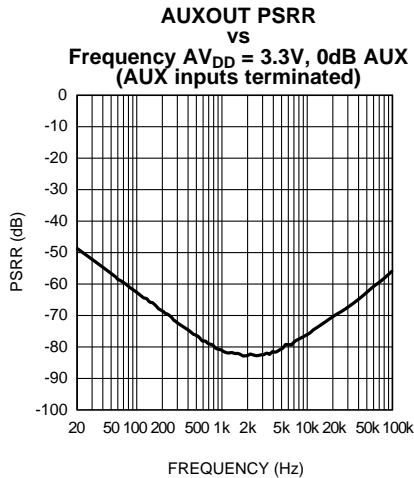

Figure 63.

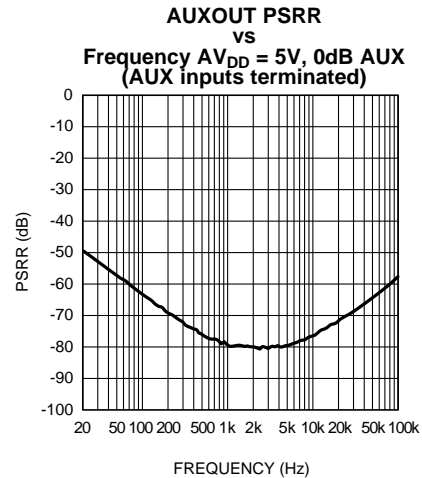

Figure 64.

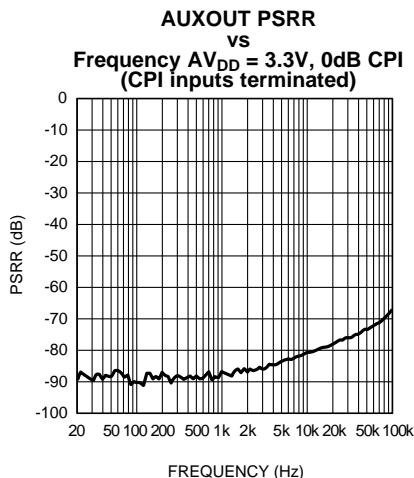

Figure 65.

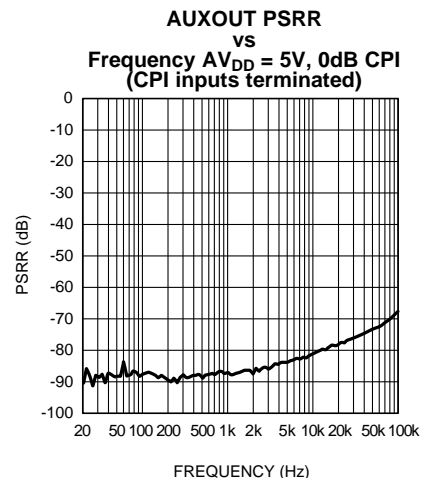

Figure 66.

### Typical Performance Characteristics (continued)

(For all performance curves  $AV_{DD}$  refers to the voltage applied to the  $A_{V_{DD}}$  and  $LS_{V_{DD}}$  pins.  $DV_{DD}$  refers to the voltage applied to the  $D_{V_{DD}}$  and  $PLL_{V_{DD}}$  pins;  $AV_{DD} = 3.3V$  and  $DV_{DD} = 3.3V$  unless otherwise specified.

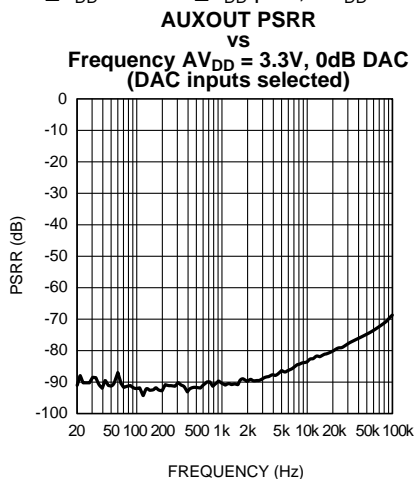

Figure 67.

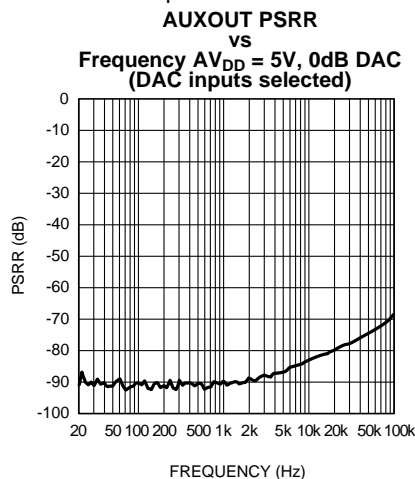

Figure 68.

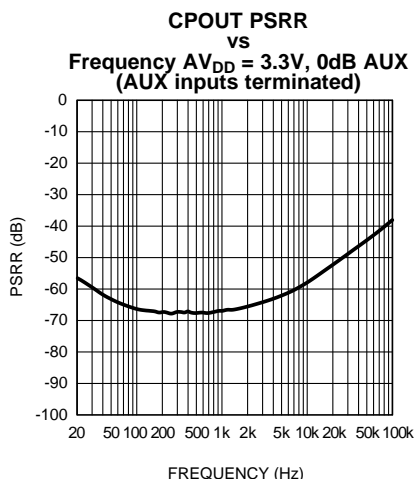

Figure 69.

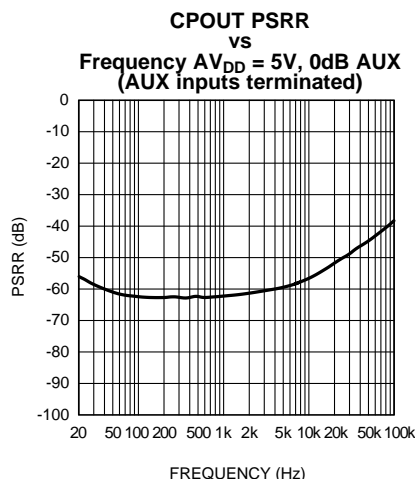

Figure 70.

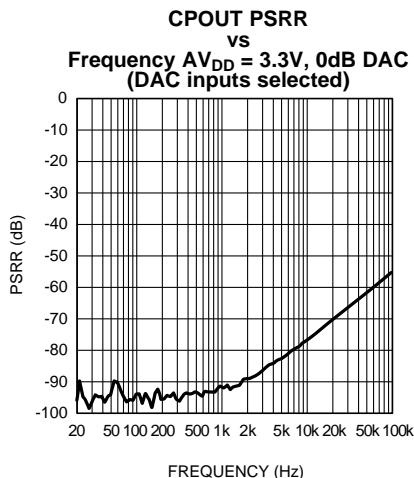

Figure 71.

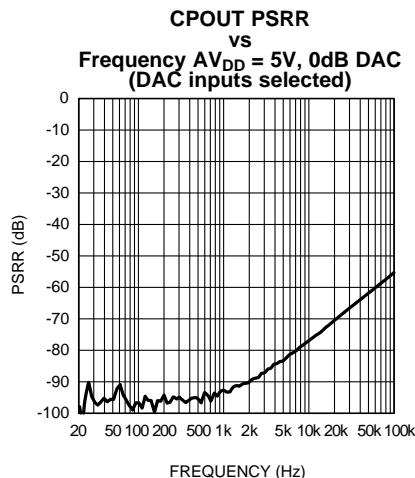
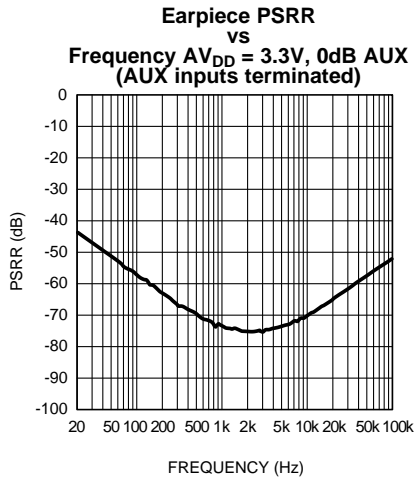

Figure 72.

**Typical Performance Characteristics (continued)**

(For all performance curves  $AV_{DD}$  refers to the voltage applied to the  $A\_V_{DD}$  and  $LS\_V_{DD}$  pins.  $DV_{DD}$  refers to the voltage applied to the  $D\_V_{DD}$  and  $PLL\_V_{DD}$  pins;  $AV_{DD} = 3.3V$  and  $DV_{DD} = 3.3V$  unless otherwise specified.



**Figure 73.**

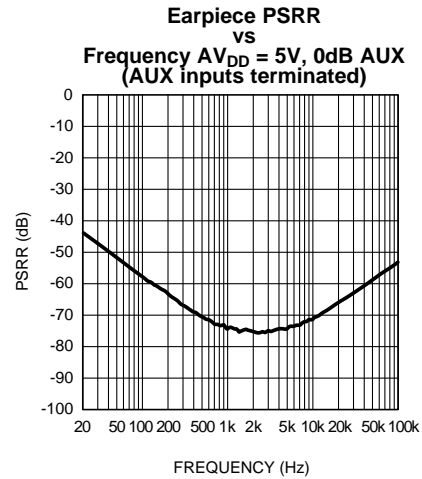

**Figure 74.**

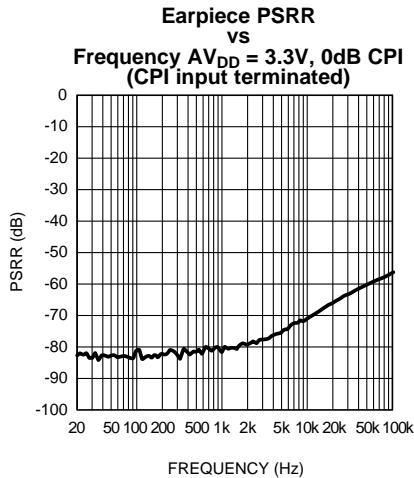

**Figure 75.**

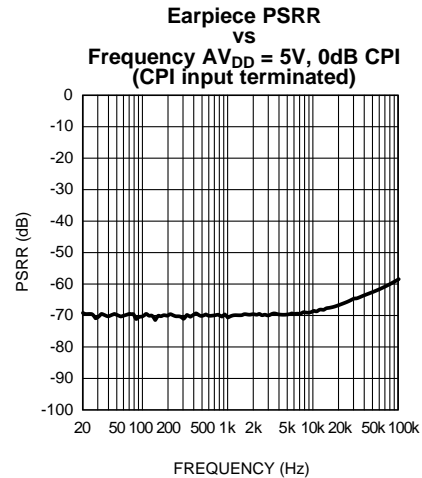

**Figure 76.**

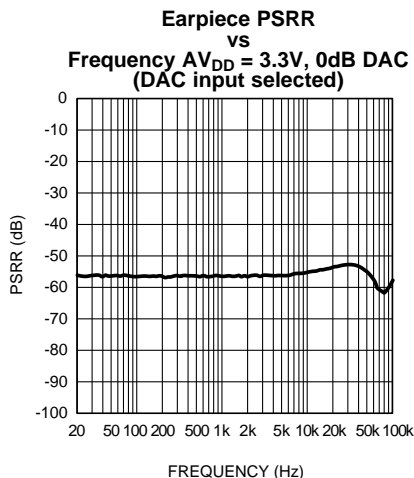

**Figure 77.**

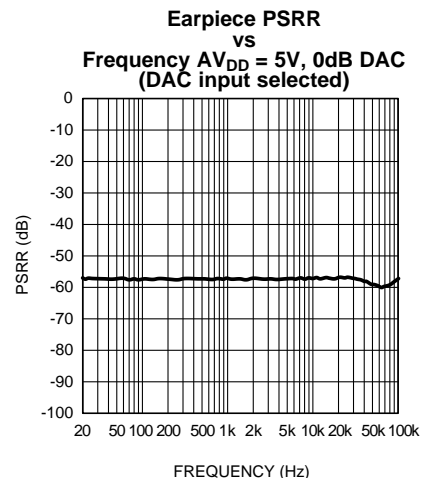

**Figure 78.**

**Typical Performance Characteristics (continued)**

(For all performance curves  $AV_{DD}$  refers to the voltage applied to the  $A\_V_{DD}$  and  $LS\_V_{DD}$  pins.  $DV_{DD}$  refers to the voltage applied to the  $D\_V_{DD}$  and  $PLL\_V_{DD}$  pins;  $AV_{DD} = 3.3V$  and  $DV_{DD} = 3.3V$  unless otherwise specified.

**Headphone PSRR vs Frequency**  
 $AV_{DD} = 3.3V$ , 0dB AUX, OCL 1.2V  
 (AUX inputs terminated)

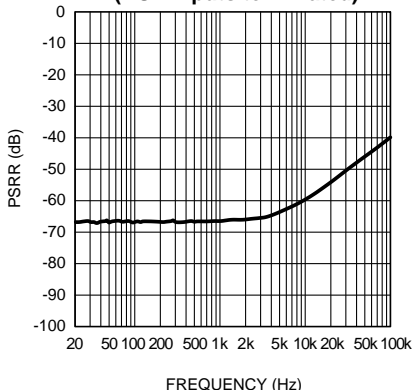

Figure 79.

**Headphone PSRR vs Frequency**  
 $AV_{DD} = 5V$ , 0dB AUX, OCL 1.2V  
 (AUX inputs terminated)

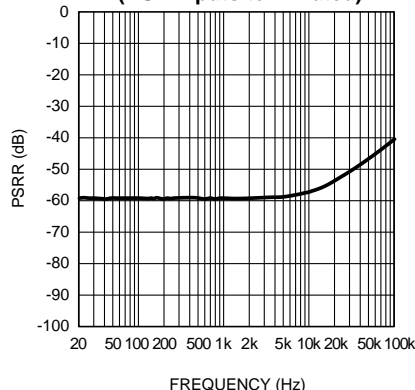

Figure 80.

**Headphone PSRR vs Frequency**  
 $AV_{DD} = 3.3V$ , 0dB CPI, OCL 1.2V  
 (CPI input terminated)

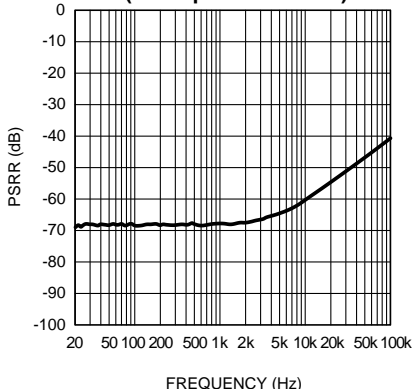

Figure 81.

**Headphone PSRR vs Frequency**  
 $AV_{DD} = 5V$ , 0dB CPI, OCL 1.2V  
 (CPI input terminated)

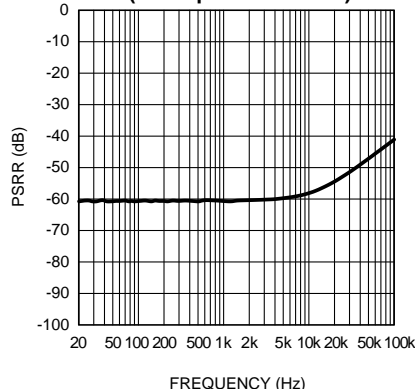

Figure 82.

**Headphone PSRR vs Frequency**  
 $AV_{DD} = 3.3V$ , 0dB ADC, OCL 1.2V  
 (DAC input selected)

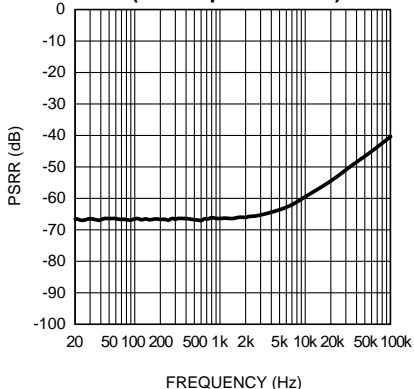

Figure 83.

**Headphone PSRR vs Frequency**  
 $AV_{DD} = 5V$ , 0dB ADC, OCL 1.2V  
 (DAC input selected)

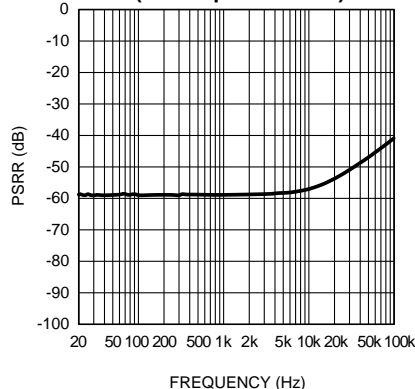

Figure 84.

**Typical Performance Characteristics (continued)**

(For all performance curves  $AV_{DD}$  refers to the voltage applied to the  $A\_V_{DD}$  and  $LS\_V_{DD}$  pins.  $DV_{DD}$  refers to the voltage applied to the  $D\_V_{DD}$  and  $PLL\_V_{DD}$  pins;  $AV_{DD} = 3.3V$  and  $DV_{DD} = 3.3V$  unless otherwise specified.)

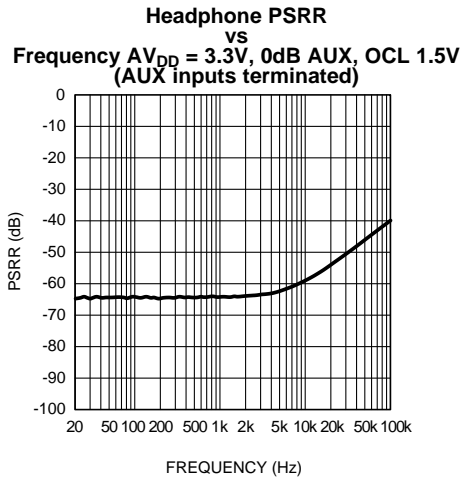

Figure 85.

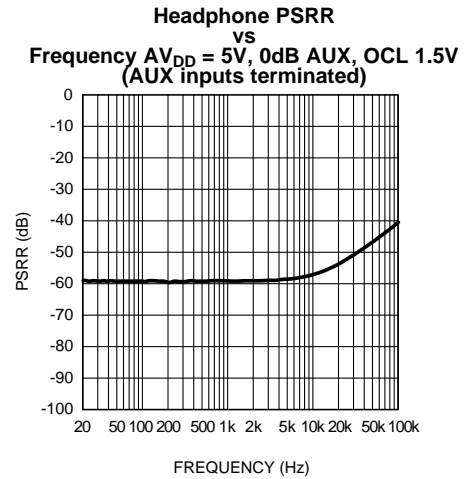

Figure 86.

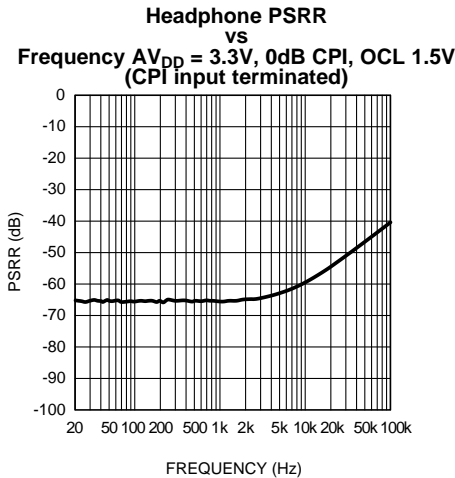

Figure 87.

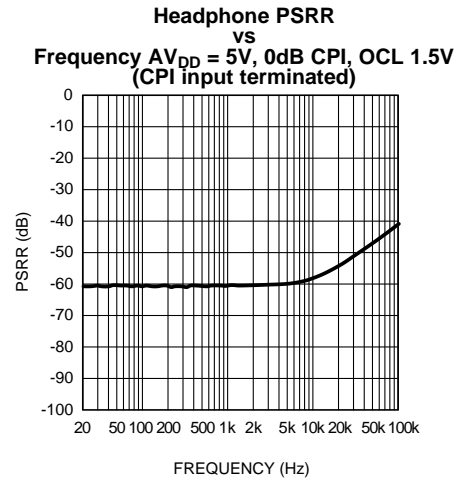

Figure 88.

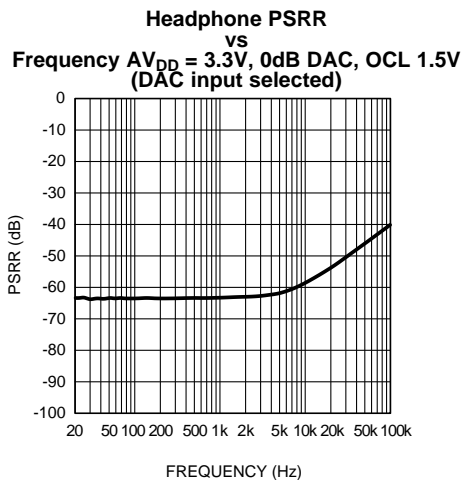

Figure 89.

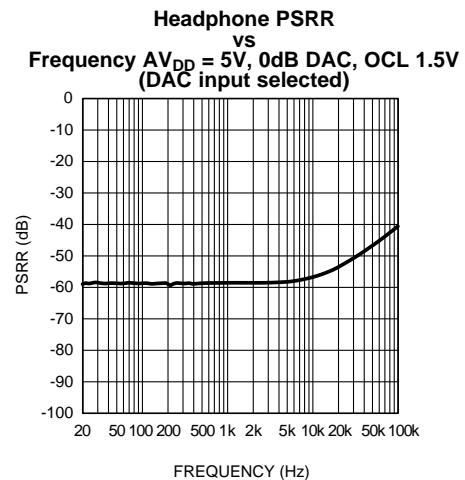
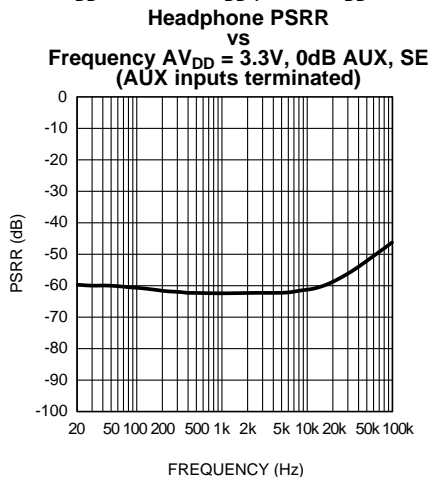

Figure 90.



**Typical Performance Characteristics (continued)**

(For all performance curves  $AV_{DD}$  refers to the voltage applied to the  $A\_V_{DD}$  and  $LS\_V_{DD}$  pins.  $DV_{DD}$  refers to the voltage applied to the  $D\_V_{DD}$  and  $PLL\_V_{DD}$  pins;  $AV_{DD} = 3.3V$  and  $DV_{DD} = 3.3V$  unless otherwise specified.)



**Figure 91.**

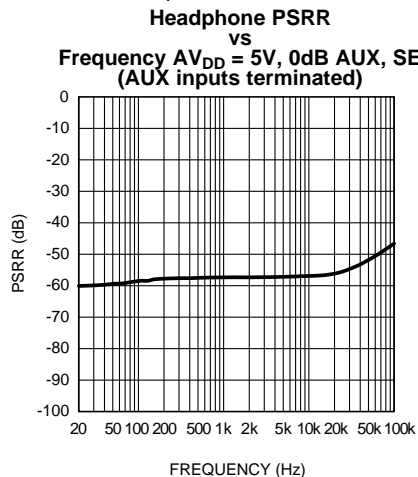

**Figure 92.**

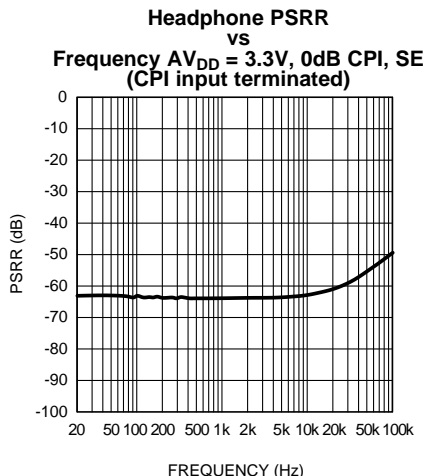

**Figure 93.**

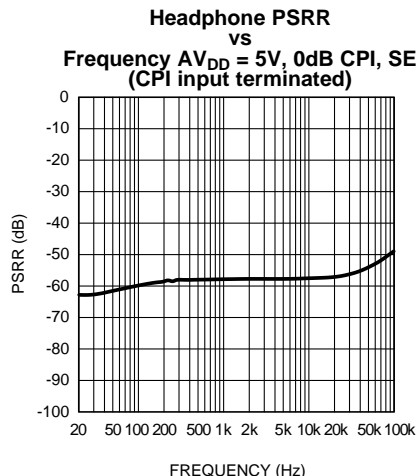

**Figure 94.**

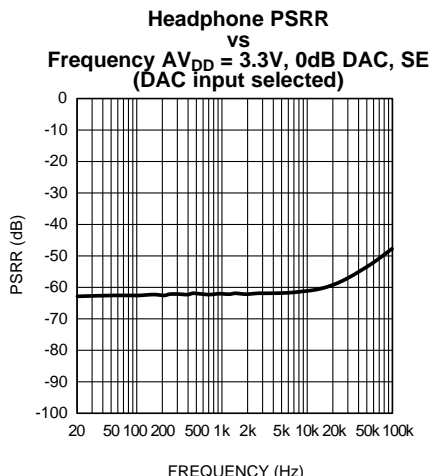

**Figure 95.**

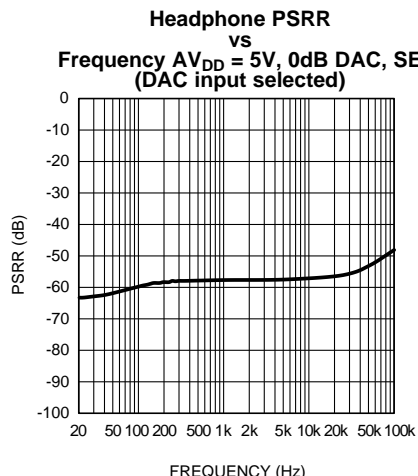

**Figure 96.**

**Typical Performance Characteristics (continued)**

(For all performance curves  $AV_{DD}$  refers to the voltage applied to the  $A_{VDD}$  and  $LS_{VDD}$  pins.  $DV_{DD}$  refers to the voltage applied to the  $D_{VDD}$  and  $PLL_{VDD}$  pins;  $AV_{DD} = 3.3V$  and  $DV_{DD} = 3.3V$  unless otherwise specified.)

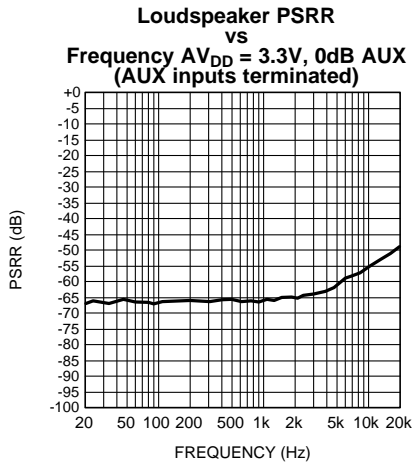

Figure 97.

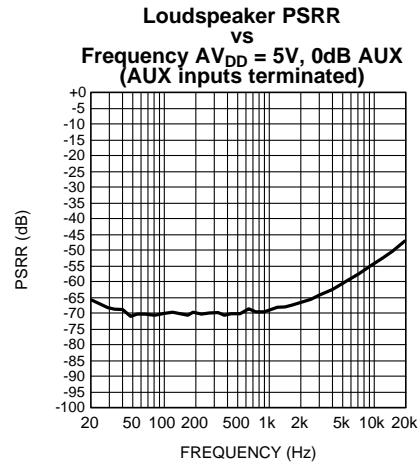

Figure 98.

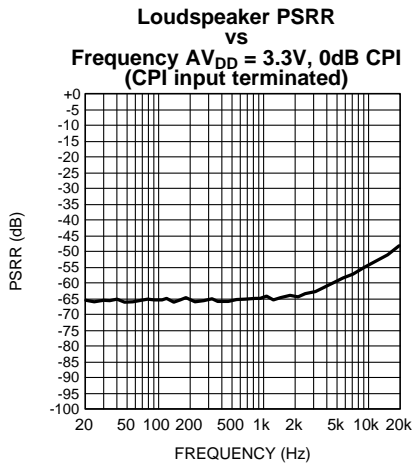

Figure 99.

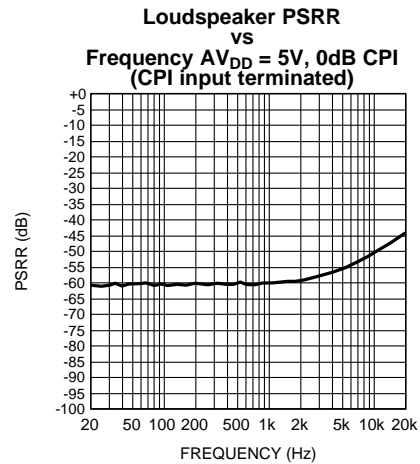

Figure 100.

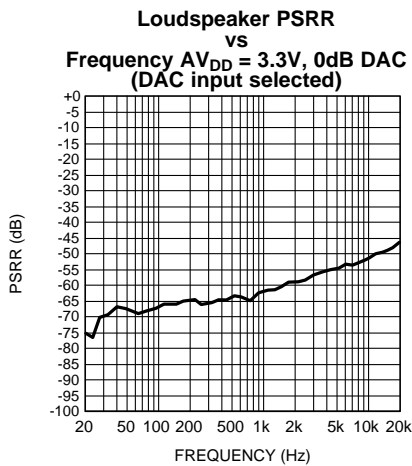

Figure 101.

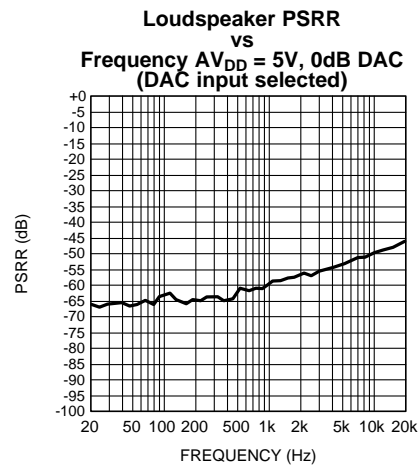
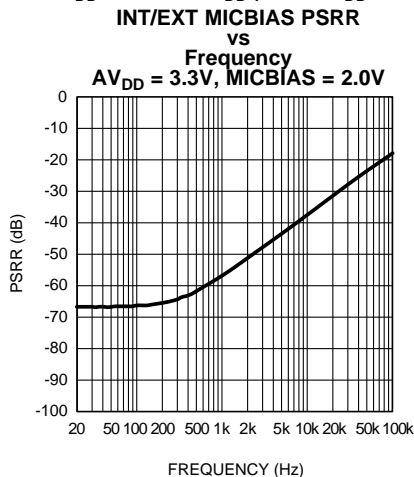

Figure 102.

**Typical Performance Characteristics (continued)**

(For all performance curves  $AV_{DD}$  refers to the voltage applied to the  $A\_V_{DD}$  and  $LS\_V_{DD}$  pins.  $DV_{DD}$  refers to the voltage applied to the  $D\_V_{DD}$  and  $PLL\_V_{DD}$  pins;  $AV_{DD} = 3.3V$  and  $DV_{DD} = 3.3V$  unless otherwise specified.



**Figure 103.**

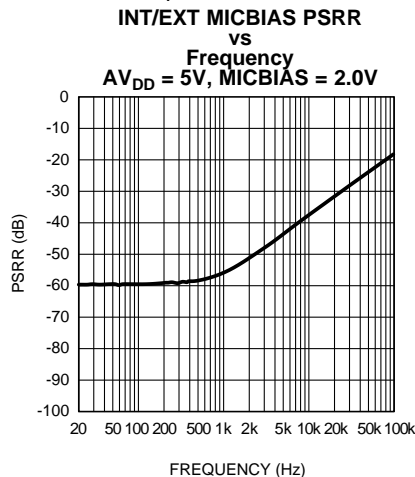

**Figure 104.**

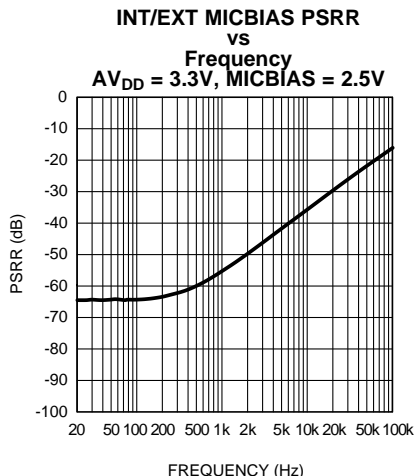

**Figure 105.**

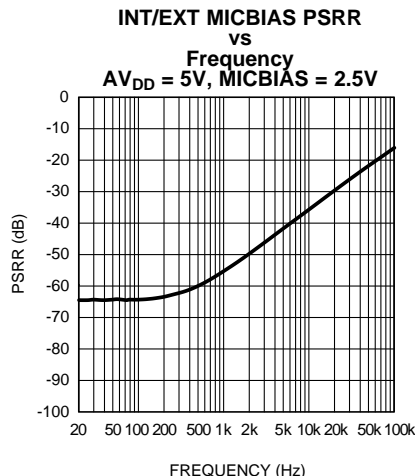

**Figure 106.**

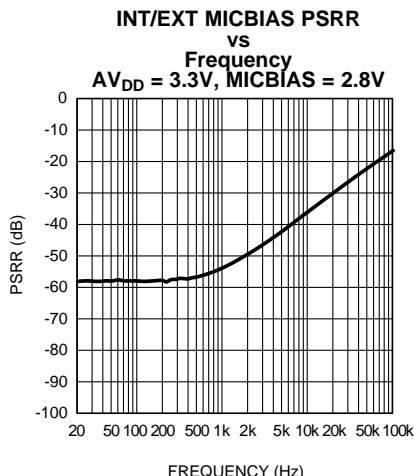

**Figure 107.**

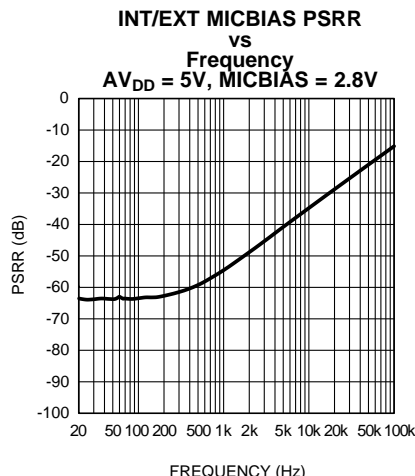

**Figure 108.**

**Typical Performance Characteristics (continued)**

(For all performance curves  $AV_{DD}$  refers to the voltage applied to the  $A\_V_{DD}$  and  $LS\_V_{DD}$  pins.  $DV_{DD}$  refers to the voltage applied to the  $D\_V_{DD}$  and  $PLL\_V_{DD}$  pins;  $AV_{DD} = 3.3V$  and  $DV_{DD} = 3.3V$  unless otherwise specified.)

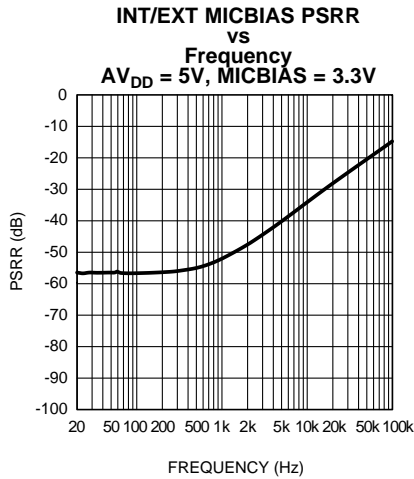

Figure 109.

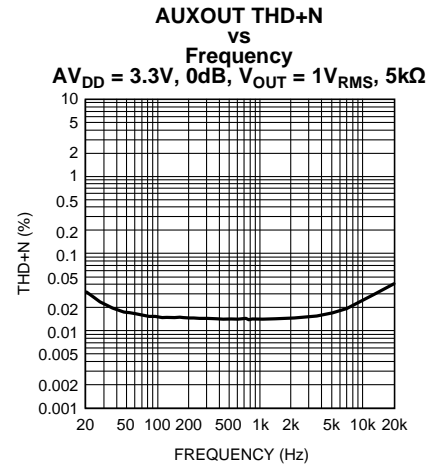

Figure 110.

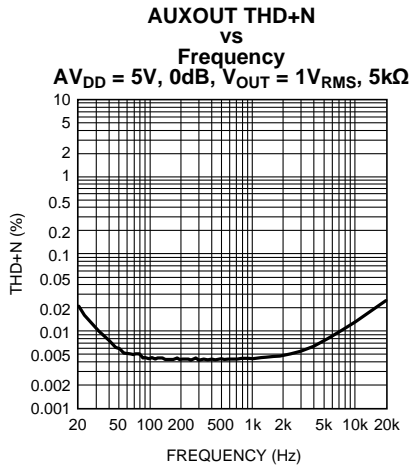

Figure 111.

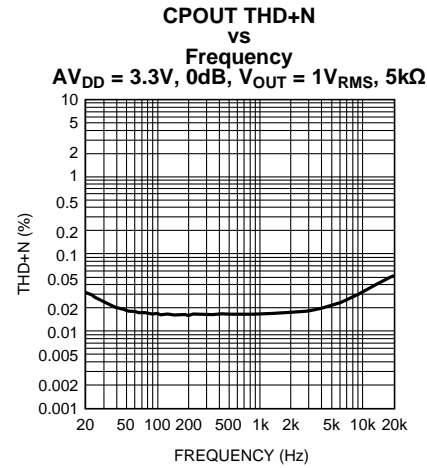

Figure 112.

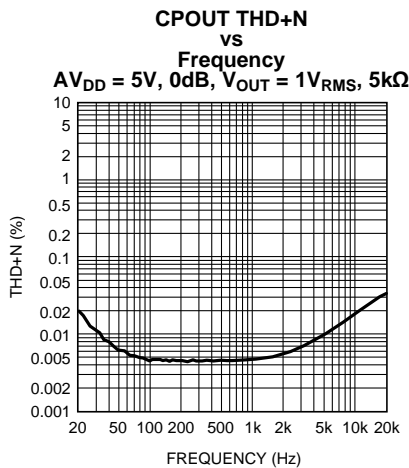

Figure 113.

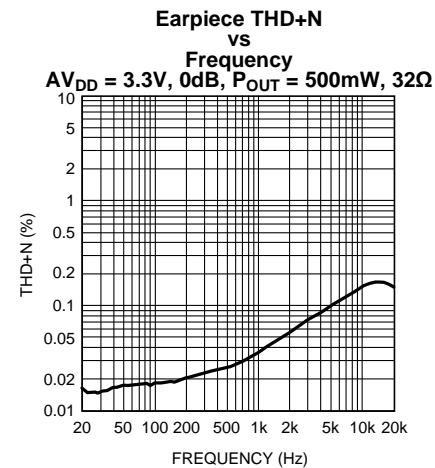

Figure 114.

**Typical Performance Characteristics (continued)**

(For all performance curves  $AV_{DD}$  refers to the voltage applied to the  $A_{VDD}$  and  $LS_{VDD}$  pins.  $DV_{DD}$  refers to the voltage applied to the  $D_{VDD}$  and  $PLL_{VDD}$  pins;  $AV_{DD} = 3.3V$  and  $DV_{DD} = 3.3V$  unless otherwise specified.

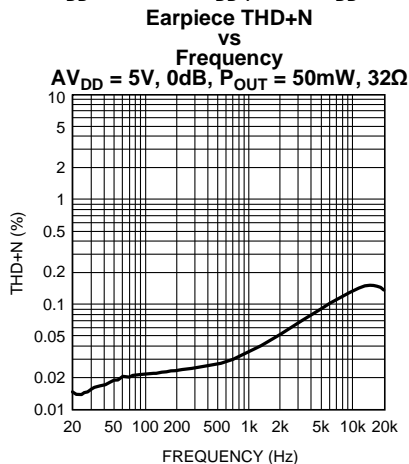

Figure 115.

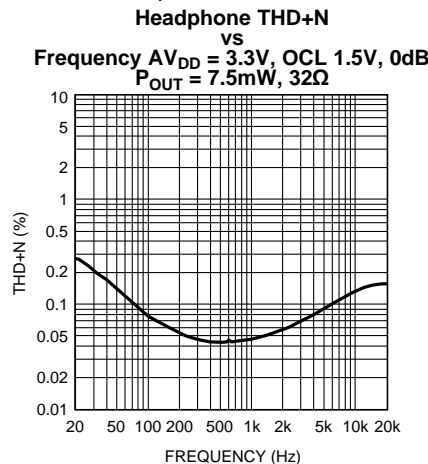

Figure 116.

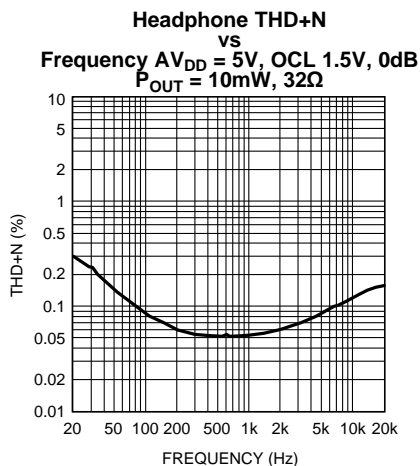

Figure 117.

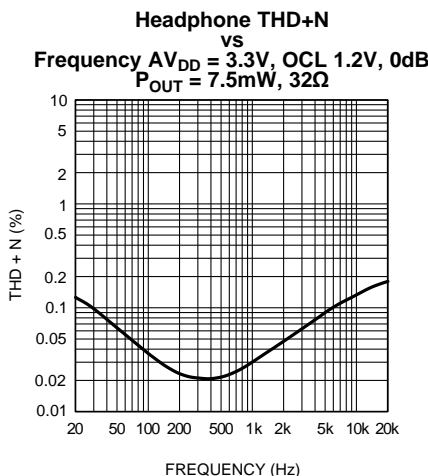

Figure 118.

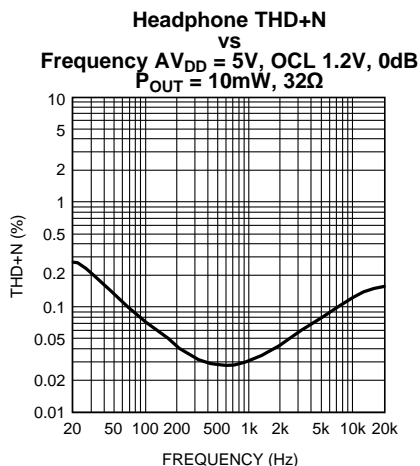

Figure 119.

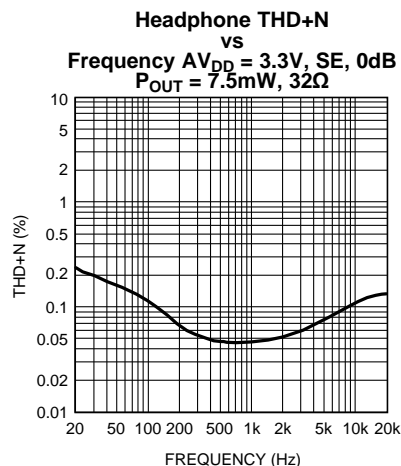

Figure 120.

**Typical Performance Characteristics (continued)**

(For all performance curves  $AV_{DD}$  refers to the voltage applied to the  $A\_V_{DD}$  and  $LS\_V_{DD}$  pins.  $DV_{DD}$  refers to the voltage applied to the  $D\_V_{DD}$  and  $PLL\_V_{DD}$  pins;  $AV_{DD} = 3.3V$  and  $DV_{DD} = 3.3V$  unless otherwise specified.

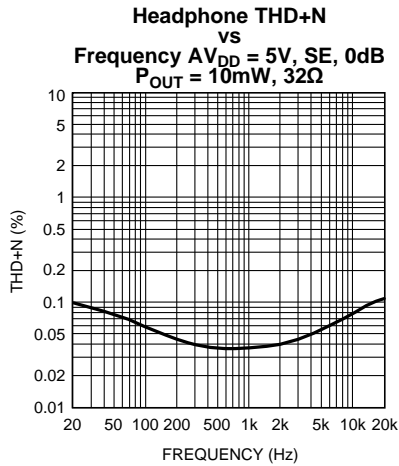

Figure 121.

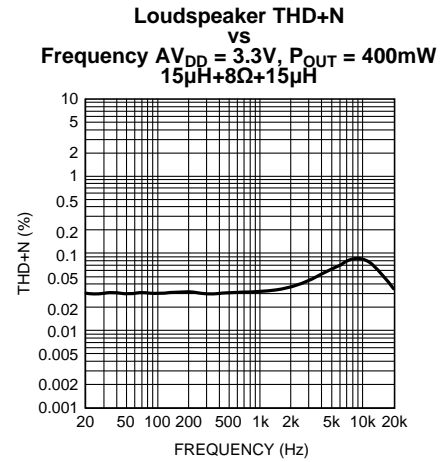

Figure 122.

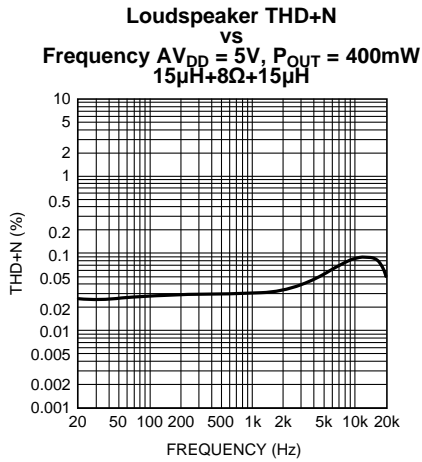

Figure 123.

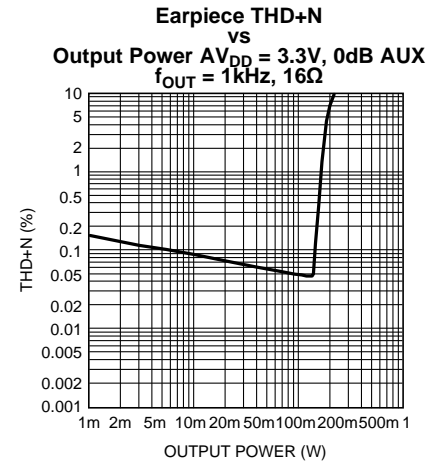

Figure 124.

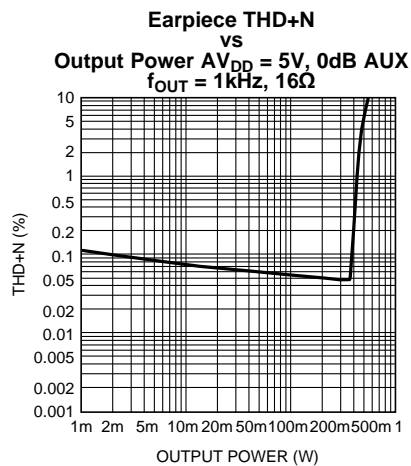

Figure 125.

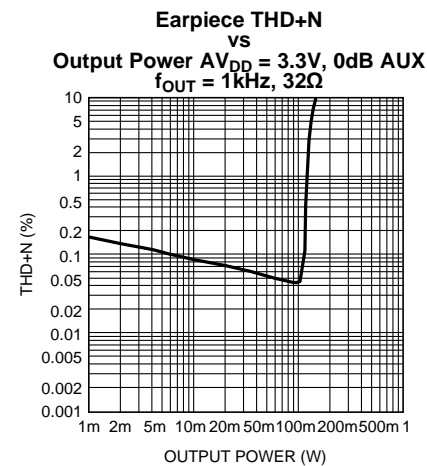

Figure 126.

Typical Performance Characteristics (continued)

(For all performance curves  $AV_{DD}$  refers to the voltage applied to the  $A\_V_{DD}$  and  $LS\_V_{DD}$  pins.  $DV_{DD}$  refers to the voltage applied to the  $D\_V_{DD}$  and  $PLL\_V_{DD}$  pins;  $AV_{DD} = 3.3V$  and  $DV_{DD} = 3.3V$  unless otherwise specified.

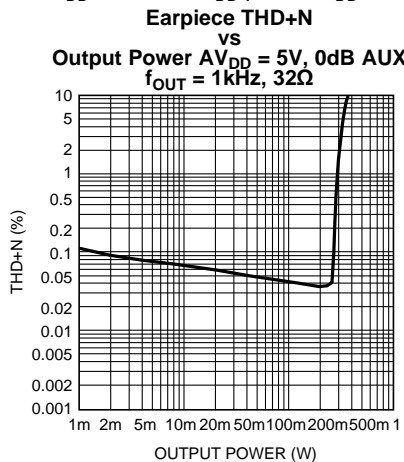

Figure 127.

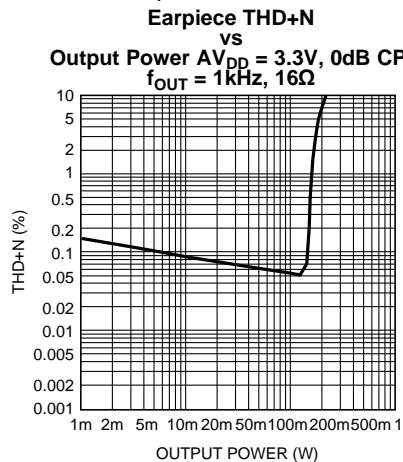

Figure 128.

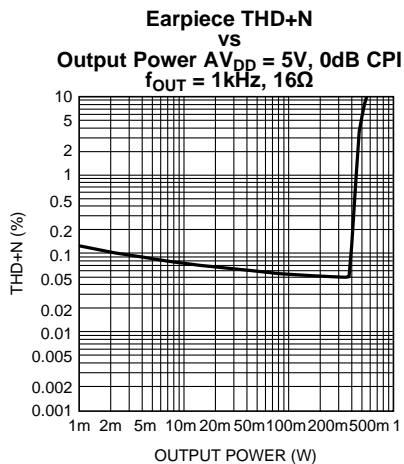

Figure 129.

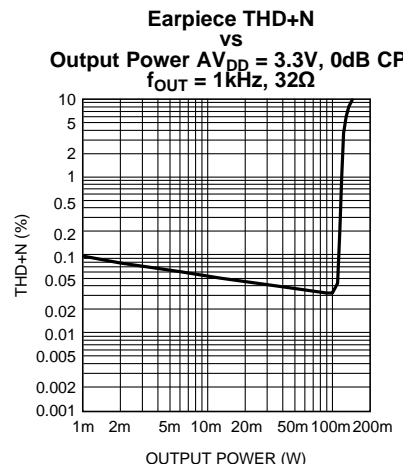

Figure 130.

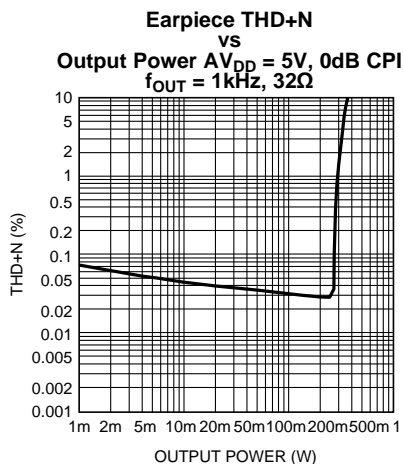

Figure 131.

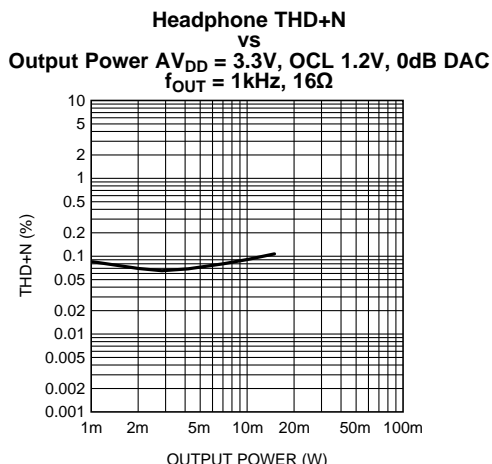

Figure 132.

**Typical Performance Characteristics (continued)**

(For all performance curves  $AV_{DD}$  refers to the voltage applied to the  $A_{V_{DD}}$  and  $LS_{V_{DD}}$  pins.  $DV_{DD}$  refers to the voltage applied to the  $D_{V_{DD}}$  and  $PLL_{V_{DD}}$  pins;  $AV_{DD} = 3.3V$  and  $DV_{DD} = 3.3V$  unless otherwise specified.

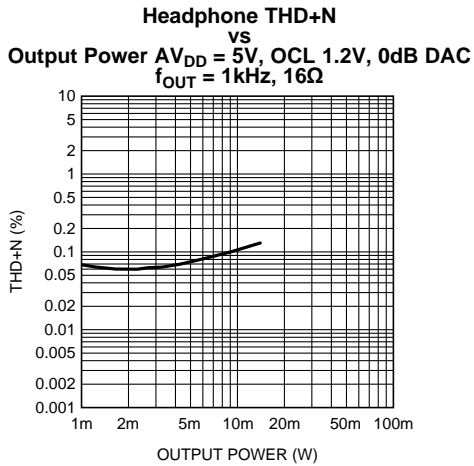

Figure 133.

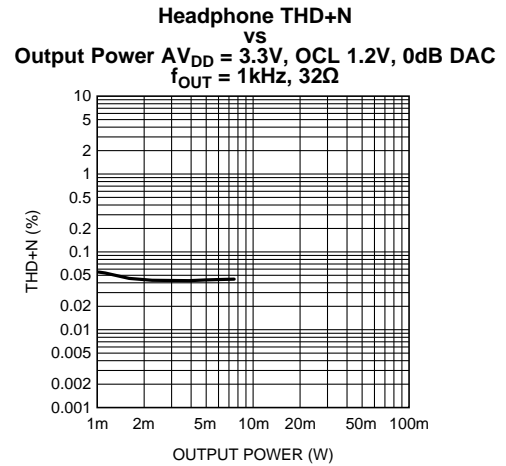

Figure 134.

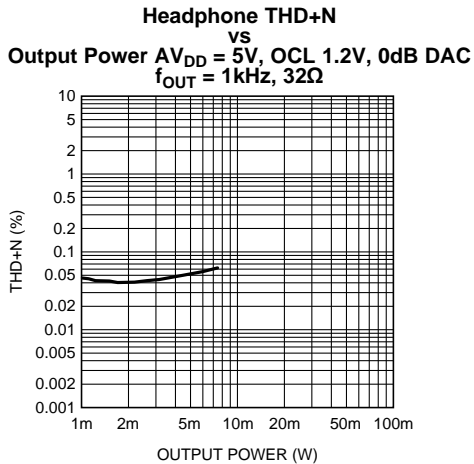

Figure 135.

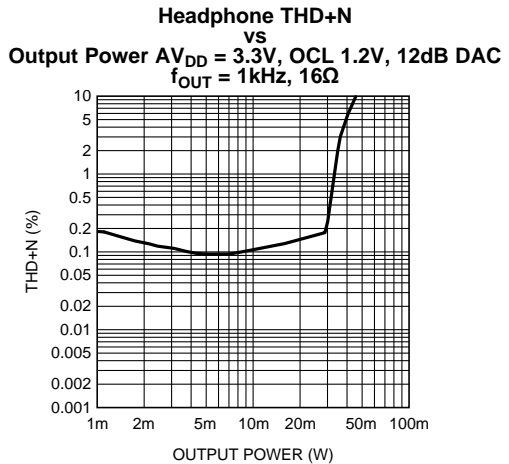

Figure 136.

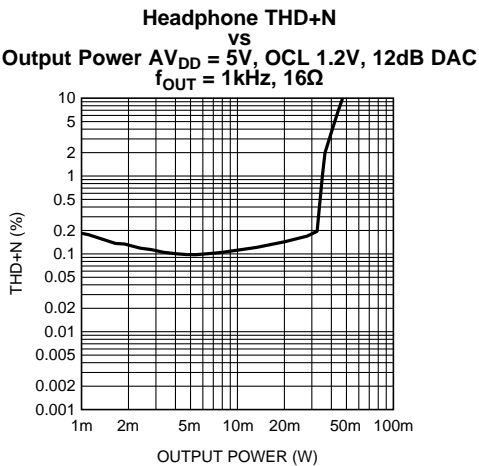

Figure 137.

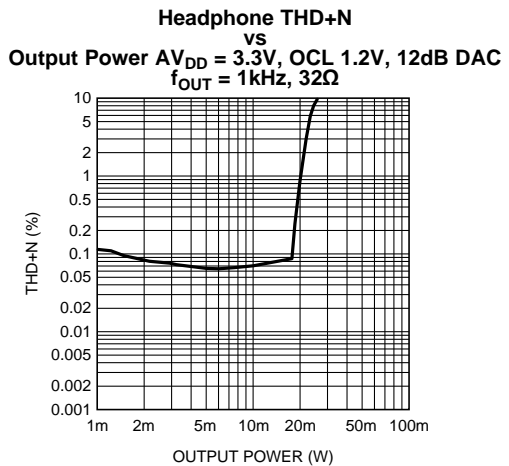

Figure 138.



Typical Performance Characteristics (continued)

(For all performance curves  $AV_{DD}$  refers to the voltage applied to the  $A\_V_{DD}$  and  $LS\_V_{DD}$  pins.  $DV_{DD}$  refers to the voltage applied to the  $D\_V_{DD}$  and  $PLL\_V_{DD}$  pins;  $AV_{DD} = 3.3V$  and  $DV_{DD} = 3.3V$  unless otherwise specified.

Headphone THD+N  
vs  
Output Power  $AV_{DD} = 5V$ , OCL 1.2V, 12dB DAC  
 $f_{OUT} = 1kHz, 32\Omega$

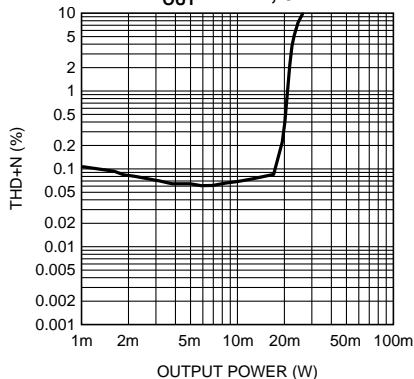

Figure 139.

Headphone THD+N  
vs  
Output Power  $AV_{DD} = 3.3V$ , OCL 1.5V, 0dB DAC  
 $f_{OUT} = 1kHz, 16\Omega$

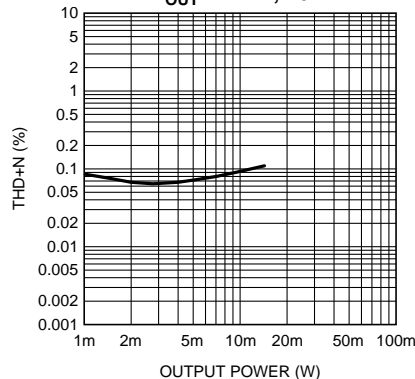

Figure 140.

Headphone THD+N  
vs  
Output Power  $AV_{DD} = 5V$ , OCL 1.5V, 0dB DAC  
 $f_{OUT} = 1kHz, 16\Omega$

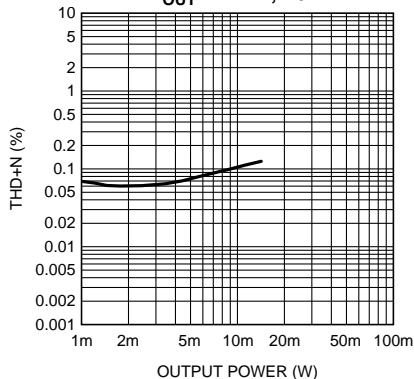

Figure 141.

Headphone THD+N  
vs  
Output Power  $AV_{DD} = 3.3V$ , OCL 1.5V, 0dB DAC  
 $f_{OUT} = 1kHz, 32\Omega$

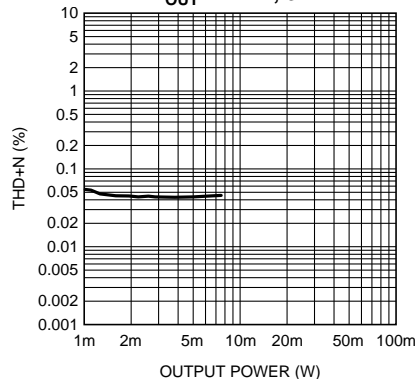

Figure 142.

Headphone THD+N  
vs  
Output Power  $AV_{DD} = 5V$ , OCL 1.5V, 0dB DAC  
 $f_{OUT} = 1kHz, 32\Omega$

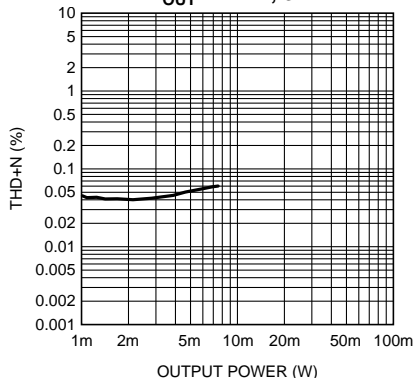

Figure 143.

Headphone THD+N  
vs  
Output Power  $AV_{DD} = 3.3V$ , OCL 1.5V, 12dB DAC  
 $f_{OUT} = 1kHz, 16\Omega$

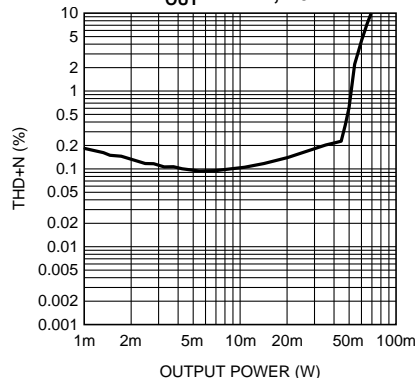

Figure 144.

**Typical Performance Characteristics (continued)**

(For all performance curves  $AV_{DD}$  refers to the voltage applied to the  $A_{V_{DD}}$  and  $LS_{V_{DD}}$  pins.  $DV_{DD}$  refers to the voltage applied to the  $D_{V_{DD}}$  and  $PLL_{V_{DD}}$  pins;  $AV_{DD} = 3.3V$  and  $DV_{DD} = 3.3V$  unless otherwise specified.

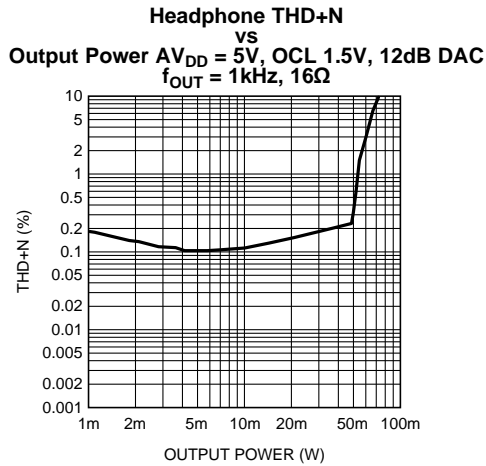

Figure 145.

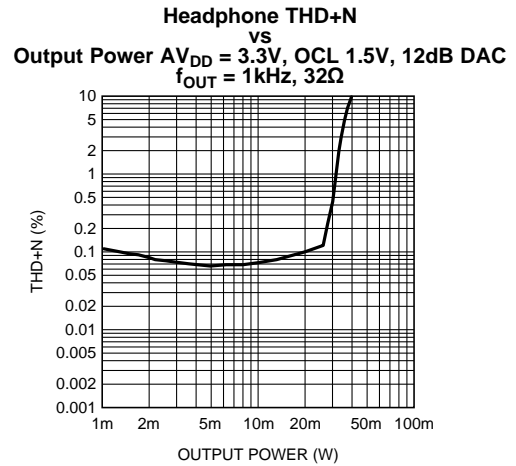

Figure 146.

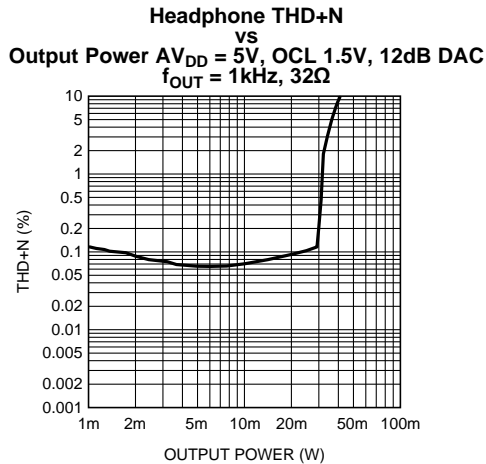

Figure 147.

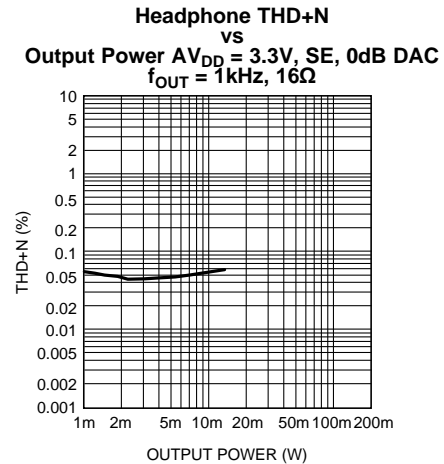

Figure 148.

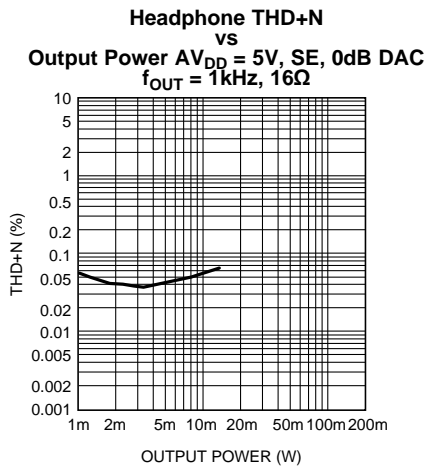

Figure 149.

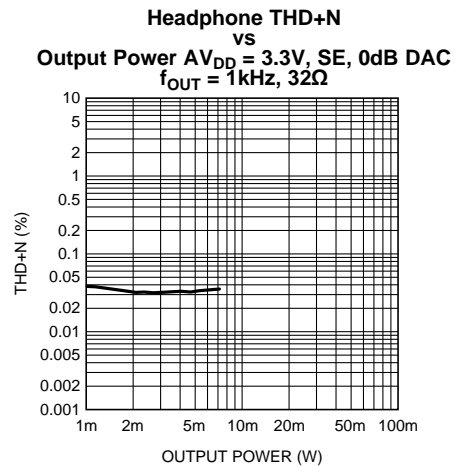

Figure 150.

**Typical Performance Characteristics (continued)**

(For all performance curves  $AV_{DD}$  refers to the voltage applied to the  $A_{V_{DD}}$  and  $LS_{V_{DD}}$  pins.  $DV_{DD}$  refers to the voltage applied to the  $D_{V_{DD}}$  and  $PLL_{V_{DD}}$  pins;  $AV_{DD} = 3.3V$  and  $DV_{DD} = 3.3V$  unless otherwise specified.

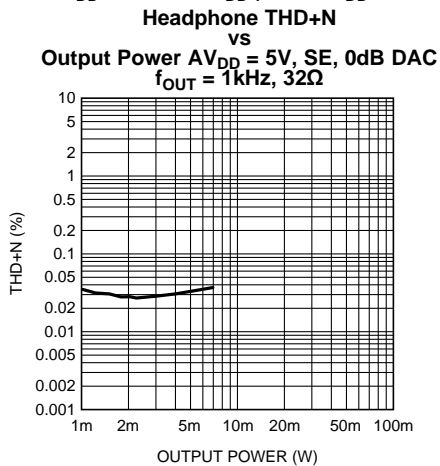

Figure 151.

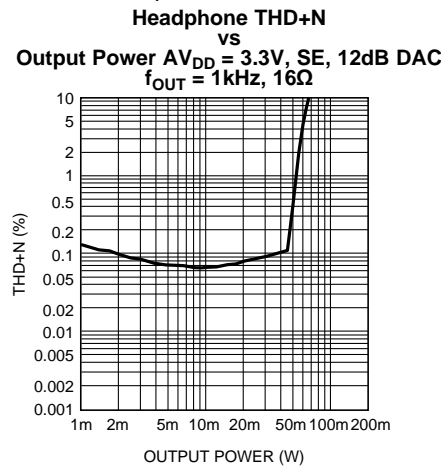

Figure 152.

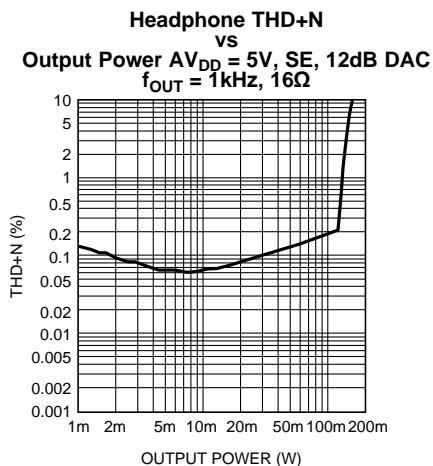

Figure 153.

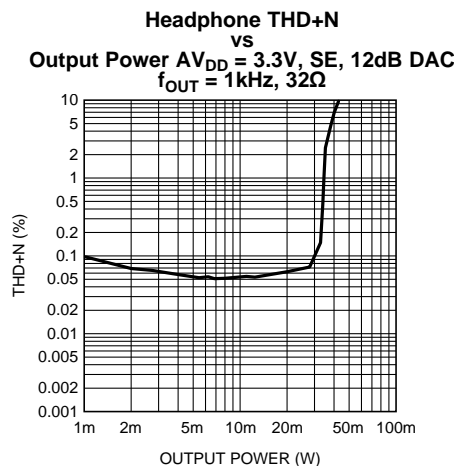

Figure 154.

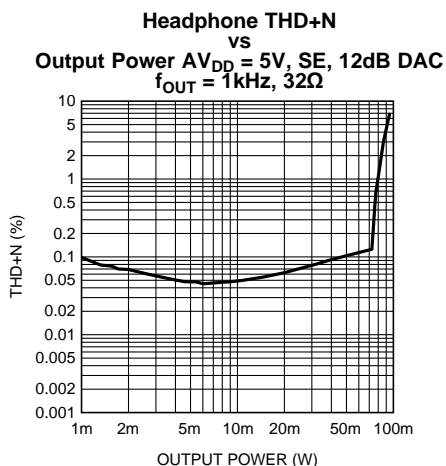

Figure 155.

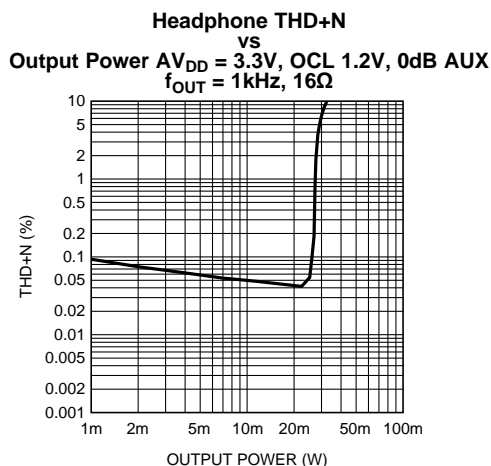

Figure 156.

**Typical Performance Characteristics (continued)**

(For all performance curves  $AV_{DD}$  refers to the voltage applied to the  $A\_V_{DD}$  and  $LS\_V_{DD}$  pins.  $DV_{DD}$  refers to the voltage applied to the  $D\_V_{DD}$  and  $PLL\_V_{DD}$  pins;  $AV_{DD} = 3.3V$  and  $DV_{DD} = 3.3V$  unless otherwise specified.

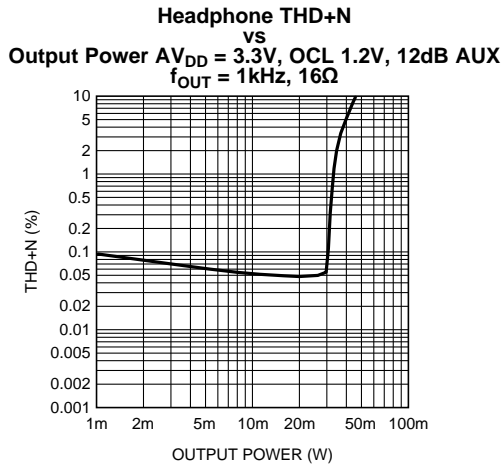

Figure 157.

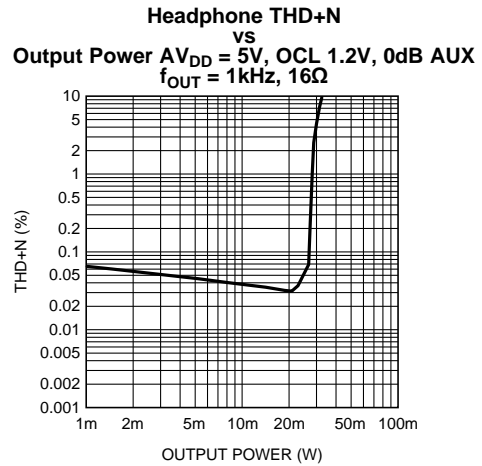

Figure 158.

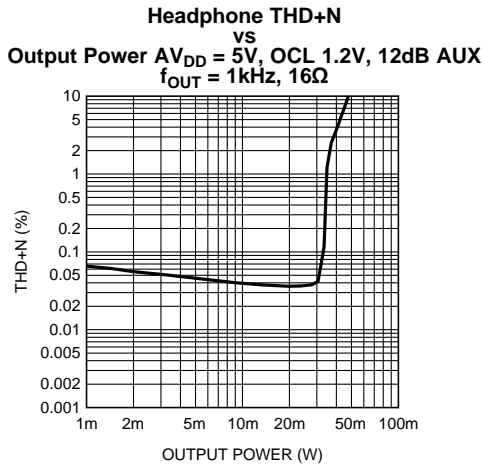

Figure 159.

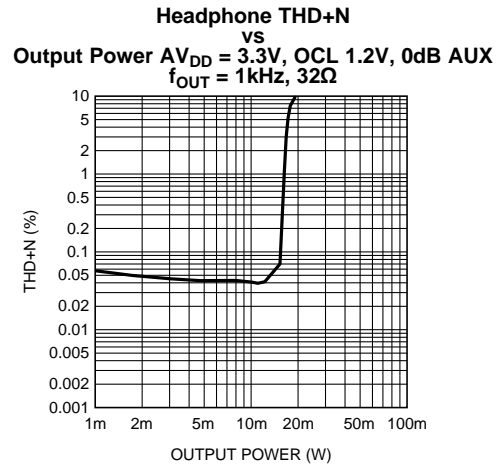

Figure 160.

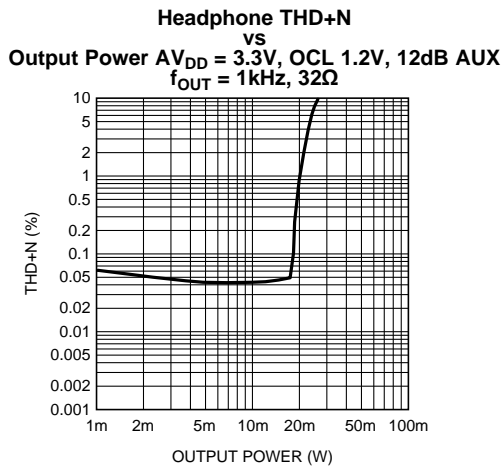

Figure 161.

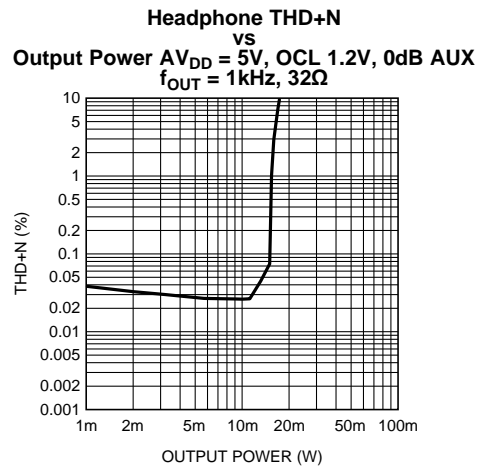
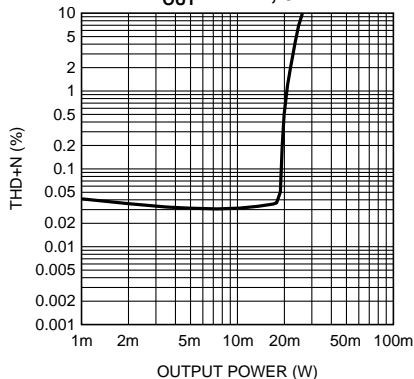

Figure 162.

**Typical Performance Characteristics (continued)**

(For all performance curves  $AV_{DD}$  refers to the voltage applied to the  $A\_V_{DD}$  and  $LS\_V_{DD}$  pins.  $DV_{DD}$  refers to the voltage applied to the  $D\_V_{DD}$  and  $PLL\_V_{DD}$  pins;  $AV_{DD} = 3.3V$  and  $DV_{DD} = 3.3V$  unless otherwise specified.)

**Headphone THD+N vs Output Power**  
 $AV_{DD} = 5V$ , OCL 1.2V, 12dB AUX  
 $f_{OUT} = 1kHz$ ,  $32\Omega$



**Figure 163.**

**Headphone THD+N vs Output Power**  
 $AV_{DD} = 3.3V$ , OCL 1.2V, 0dB CPI  
 $f_{OUT} = 1kHz$ ,  $16\Omega$

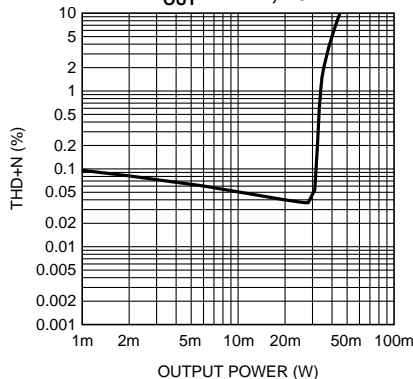

**Figure 164.**

**Headphone THD+N vs Output Power**  
 $AV_{DD} = 5V$ , OCL 1.2V, 0dB CPI  
 $f_{OUT} = 1kHz$ ,  $16\Omega$

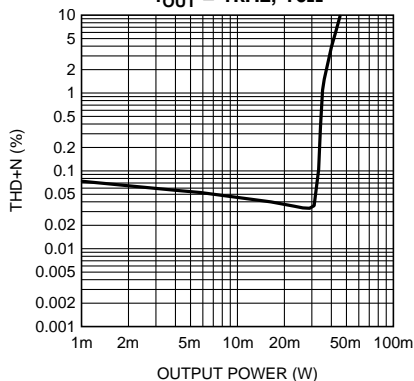

**Figure 165.**

**Headphone THD+N vs Output Power**  
 $AV_{DD} = 3.3V$ , OCL 1.2V, 0dB CPI  
 $f_{OUT} = 1kHz$ ,  $32\Omega$

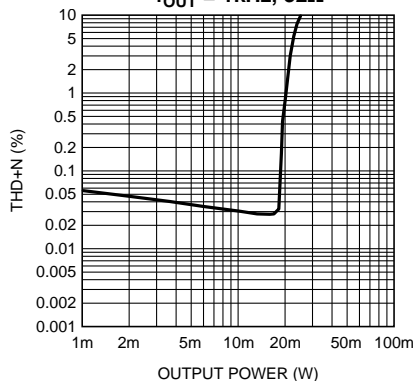

**Figure 166.**

**Headphone THD+N vs Output Power**  
 $AV_{DD} = 5V$ , OCL 1.2V, 0dB CPI  
 $f_{OUT} = 1kHz$ ,  $32\Omega$

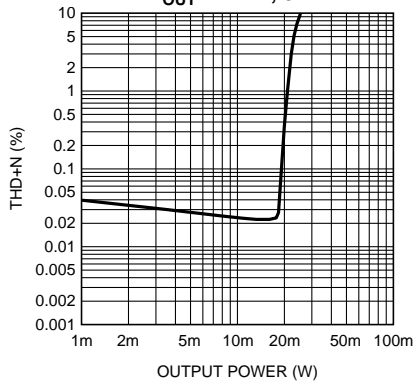

**Figure 167.**

**Headphone THD+N vs Output Power**  
 $AV_{DD} = 3.3V$ , OCL 1.5V, 0dB AUX  
 $f_{OUT} = 1kHz$ ,  $16\Omega$

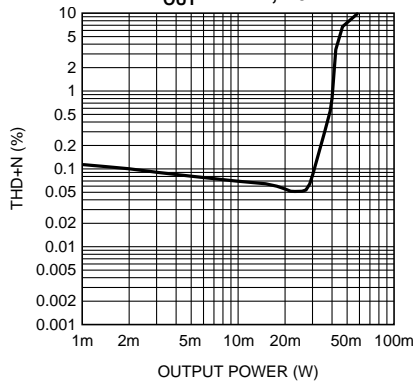

**Figure 168.**

**Typical Performance Characteristics (continued)**

(For all performance curves  $AV_{DD}$  refers to the voltage applied to the  $A_{V_{DD}}$  and  $LS_{V_{DD}}$  pins.  $DV_{DD}$  refers to the voltage applied to the  $D_{V_{DD}}$  and  $PLL_{V_{DD}}$  pins;  $AV_{DD} = 3.3V$  and  $DV_{DD} = 3.3V$  unless otherwise specified.

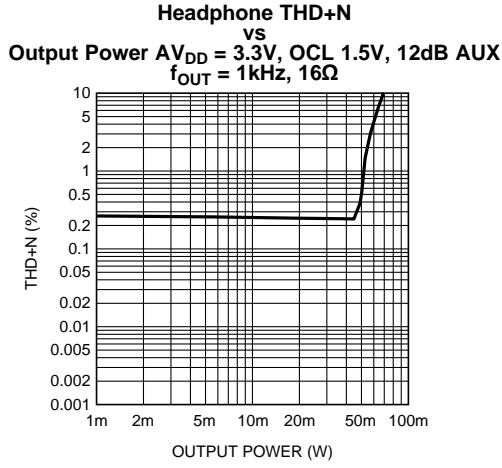

Figure 169.

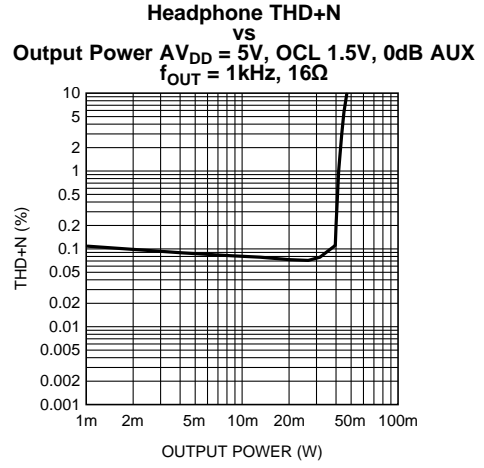

Figure 170.

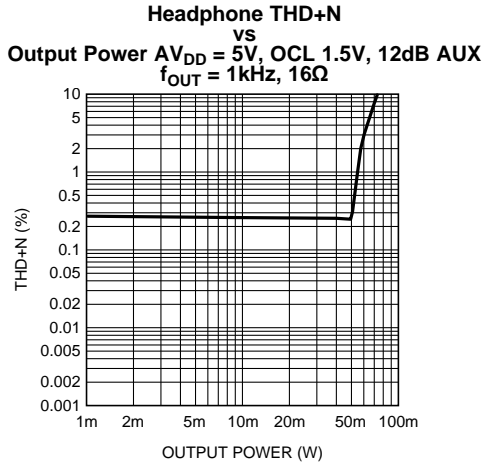

Figure 171.

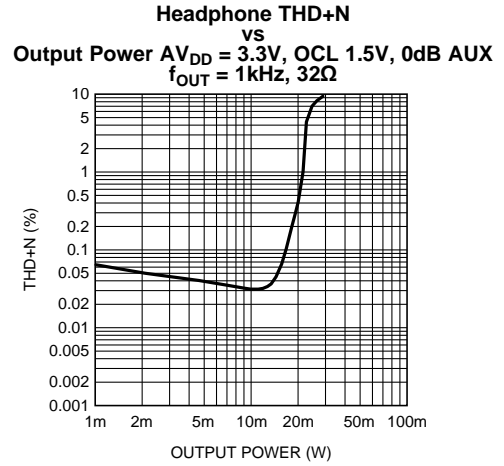

Figure 172.

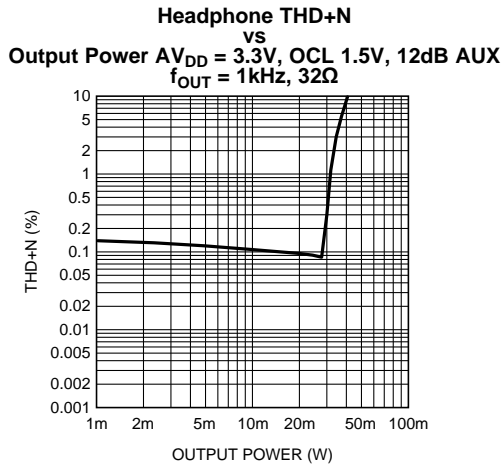

Figure 173.

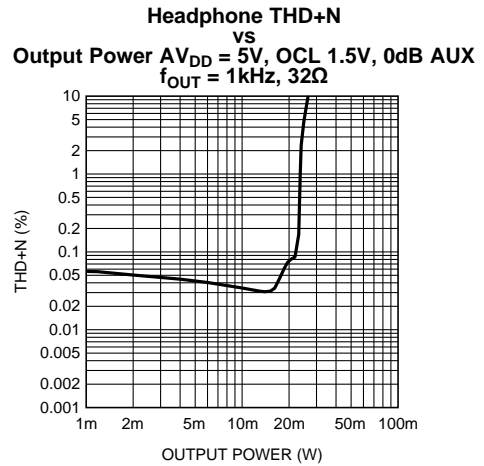

Figure 174.

### Typical Performance Characteristics (continued)

(For all performance curves  $AV_{DD}$  refers to the voltage applied to the  $A_{V_{DD}}$  and  $LS_{V_{DD}}$  pins.  $DV_{DD}$  refers to the voltage applied to the  $D_{V_{DD}}$  and  $PLL_{V_{DD}}$  pins;  $AV_{DD} = 3.3V$  and  $DV_{DD} = 3.3V$  unless otherwise specified.

**Headphone THD+N**  
vs  
**Output Power  $AV_{DD} = 5V$ , OCL 1.5V, 12dB AUX**  
 $f_{OUT} = 1kHz, 32\Omega$

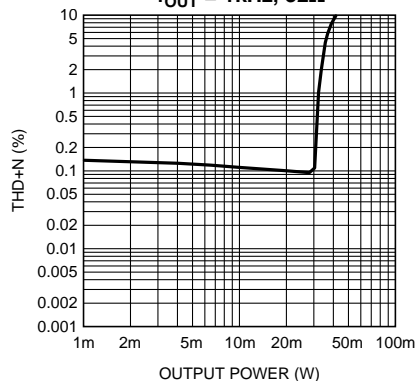

Figure 175.

**Headphone THD+N**  
vs  
**Output Power  $AV_{DD} = 3.3V$ , OCL 1.5V, 0dB CPI**  
 $f_{OUT} = 1kHz, 16\Omega$

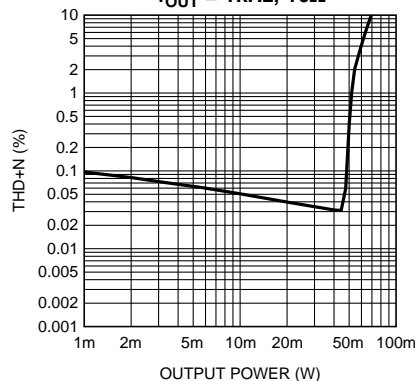

Figure 176.

**Headphone THD+N**  
vs  
**Output Power  $AV_{DD} = 5V$ , OCL 1.5V, 0dB CPI**  
 $f_{OUT} = 1kHz, 16\Omega$

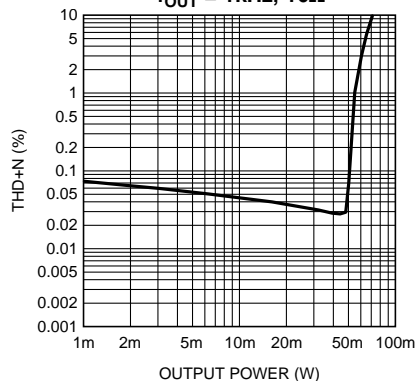

Figure 177.

**Headphone THD+N**  
vs  
**Output Power  $AV_{DD} = 3.3V$ , OCL 1.5V, 0dB CPI**  
 $f_{OUT} = 1kHz, 32\Omega$

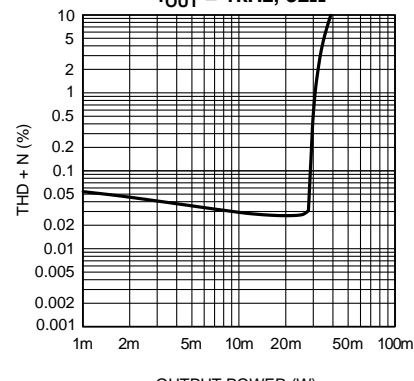

Figure 178.

**Headphone THD+N**  
vs  
**Output Power  $AV_{DD} = 5V$ , OCL 1.5V, 0dB CPI**  
 $f_{OUT} = 1kHz, 32\Omega$

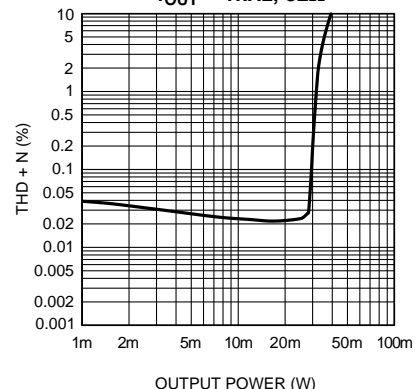

Figure 179.

**Headphone THD+N**  
vs  
**Output Power  $AV_{DD} = 3.3V$ , SE, 0dB AUX**  
 $f_{OUT} = 1kHz, 16\Omega$

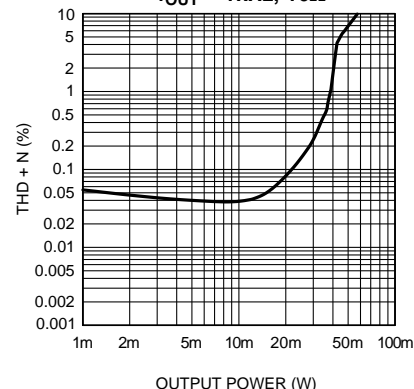

Figure 180.

**Typical Performance Characteristics (continued)**

(For all performance curves  $AV_{DD}$  refers to the voltage applied to the  $A\_V_{DD}$  and  $LS\_V_{DD}$  pins.  $DV_{DD}$  refers to the voltage applied to the  $D\_V_{DD}$  and  $PLL\_V_{DD}$  pins;  $AV_{DD} = 3.3V$  and  $DV_{DD} = 3.3V$  unless otherwise specified.

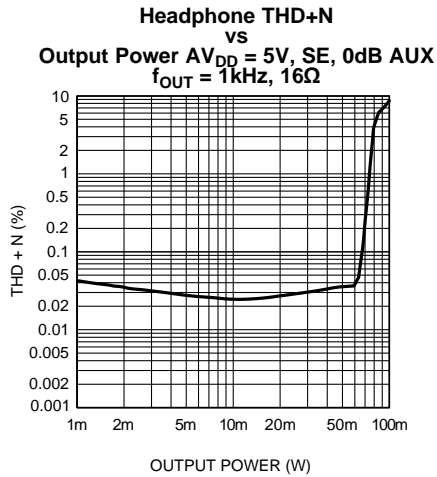

Figure 181.

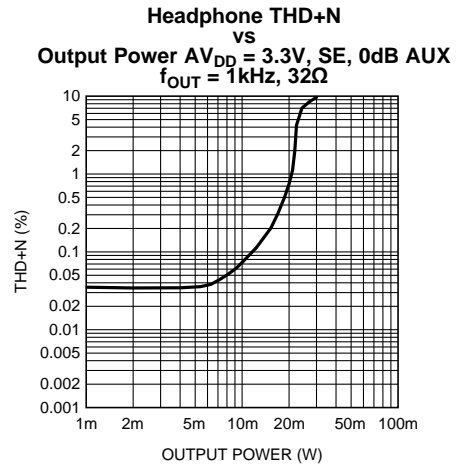

Figure 182.

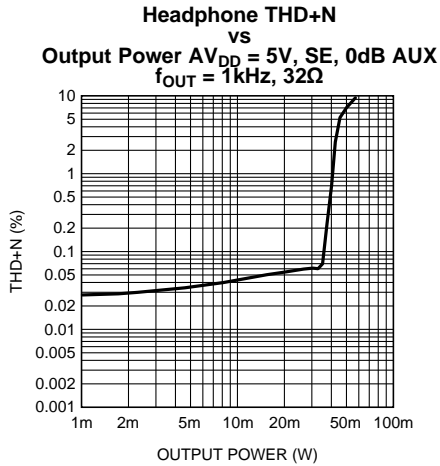

Figure 183.

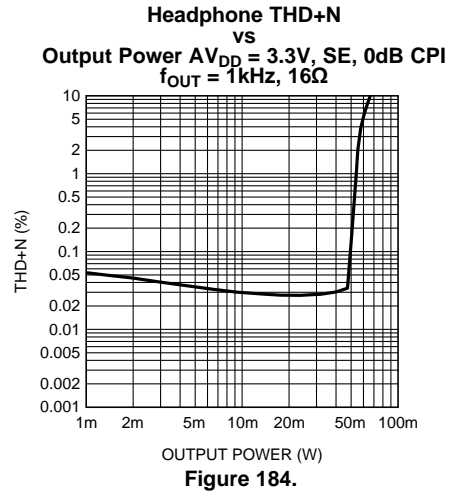

Figure 184.

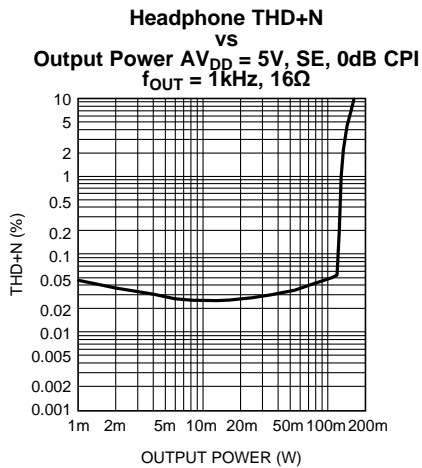

Figure 185.

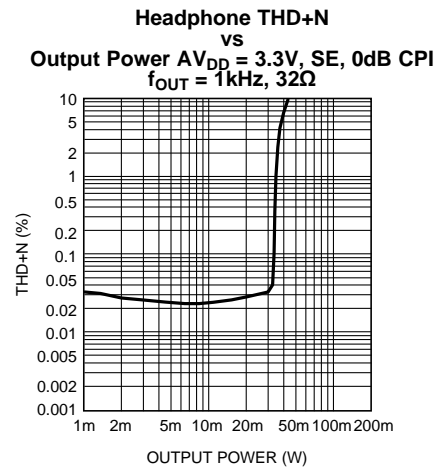

Figure 186.



Typical Performance Characteristics (continued)

(For all performance curves  $AV_{DD}$  refers to the voltage applied to the  $A_{VDD}$  and  $LS_{VDD}$  pins.  $DV_{DD}$  refers to the voltage applied to the  $D_{VDD}$  and  $PLL_{VDD}$  pins;  $AV_{DD} = 3.3V$  and  $DV_{DD} = 3.3V$  unless otherwise specified.

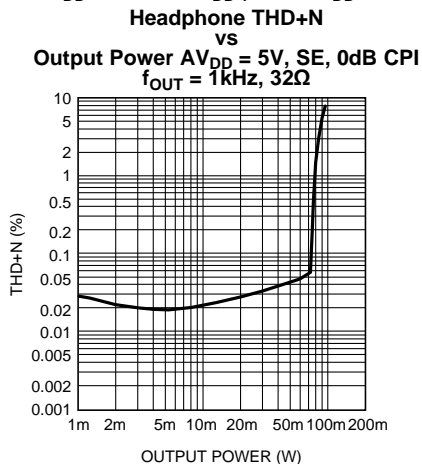

Figure 187.

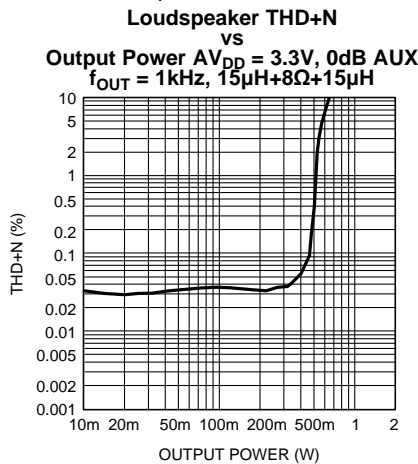

Figure 188.

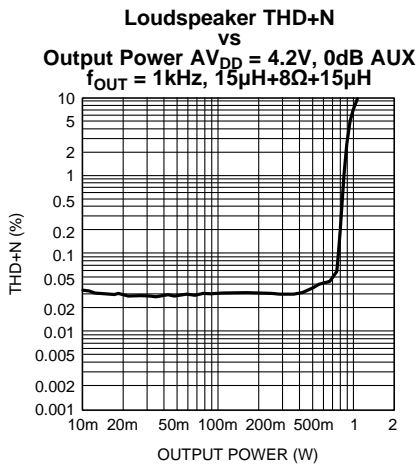

Figure 189.

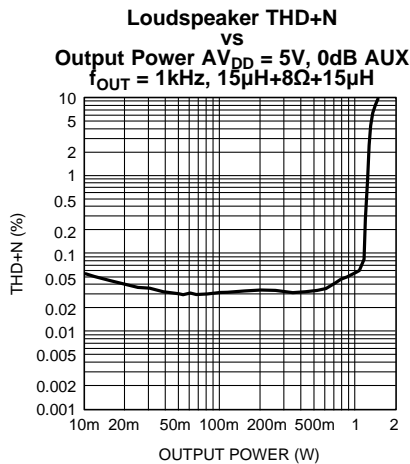

Figure 190.

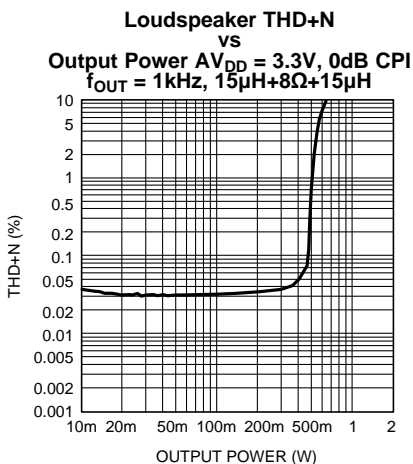

Figure 191.

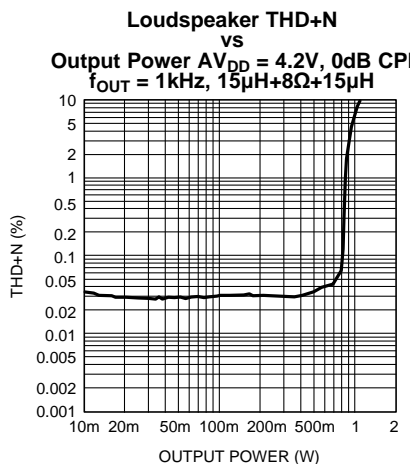
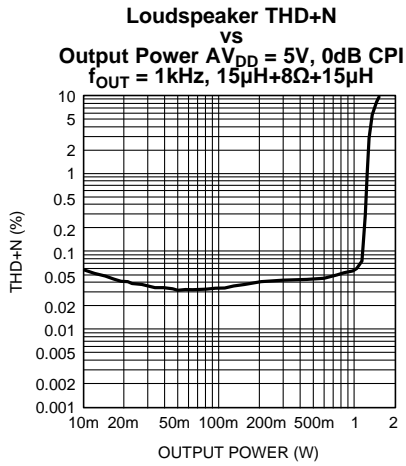

Figure 192.

**Typical Performance Characteristics (continued)**

(For all performance curves  $AV_{DD}$  refers to the voltage applied to the  $A_{VDD}$  and  $LS_{VDD}$  pins.  $DV_{DD}$  refers to the voltage applied to the  $D_{VDD}$  and  $PLL_{VDD}$  pins;  $AV_{DD} = 3.3V$  and  $DV_{DD} = 3.3V$  unless otherwise specified.)



**Figure 193.**

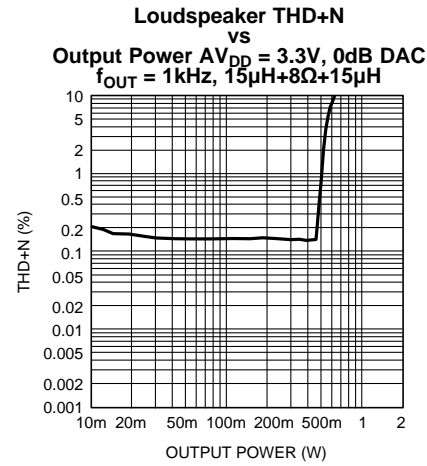

**Figure 194.**

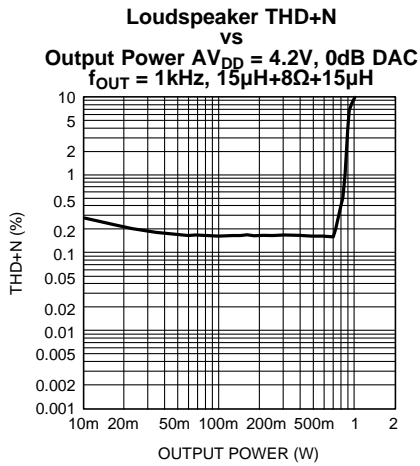

**Figure 195.**

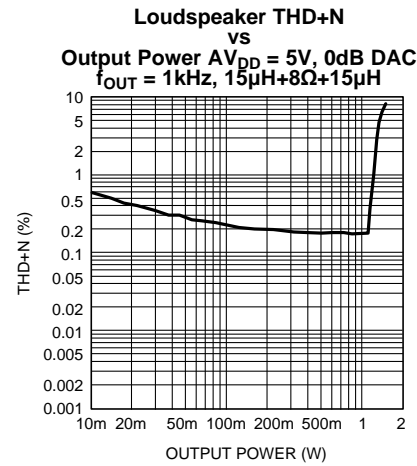

**Figure 196.**

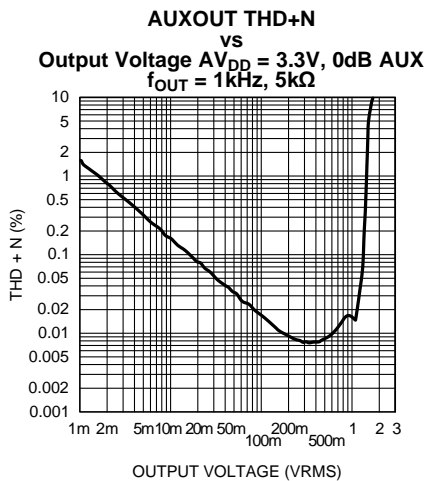

**Figure 197.**

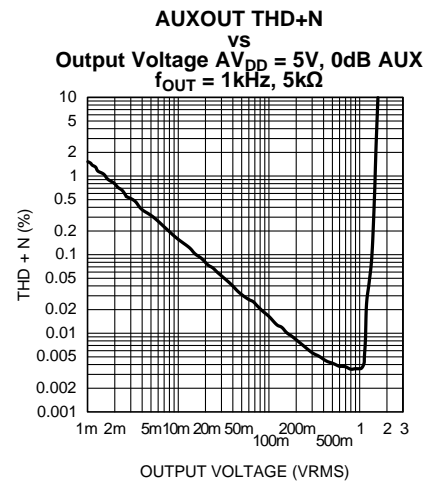

**Figure 198.**

Typical Performance Characteristics (continued)

(For all performance curves  $AV_{DD}$  refers to the voltage applied to the  $A\_V_{DD}$  and  $LS\_V_{DD}$  pins.  $DV_{DD}$  refers to the voltage applied to the  $D\_V_{DD}$  and  $PLL\_V_{DD}$  pins;  $AV_{DD} = 3.3V$  and  $DV_{DD} = 3.3V$  unless otherwise specified.

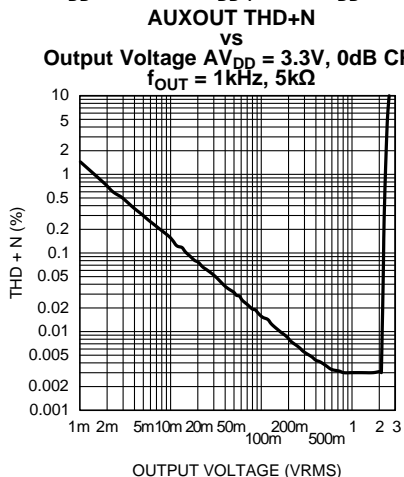

Figure 199.

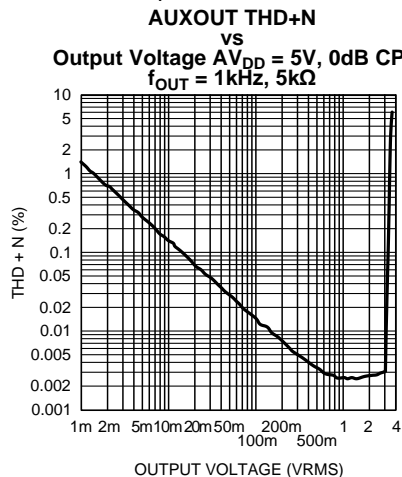

Figure 200.

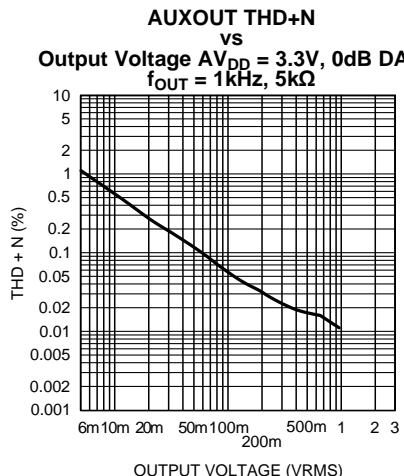

Figure 201.

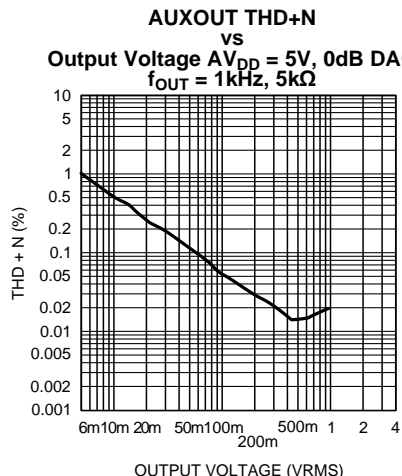

Figure 202.

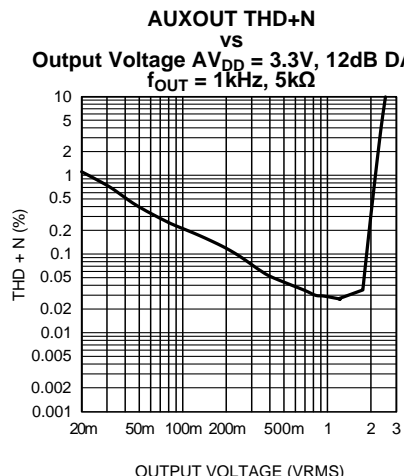

Figure 203.

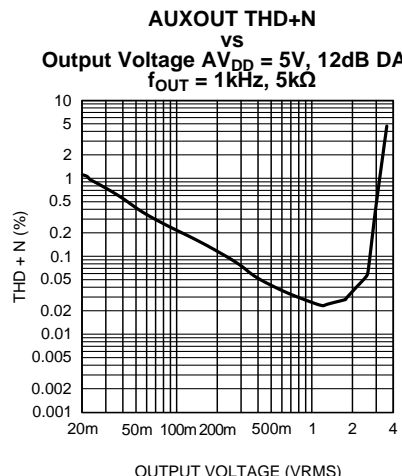

Figure 204.

**Typical Performance Characteristics (continued)**

(For all performance curves  $AV_{DD}$  refers to the voltage applied to the  $A\_V_{DD}$  and  $LS\_V_{DD}$  pins.  $DV_{DD}$  refers to the voltage applied to the  $D\_V_{DD}$  and  $PLL\_V_{DD}$  pins;  $AV_{DD} = 3.3V$  and  $DV_{DD} = 3.3V$  unless otherwise specified.

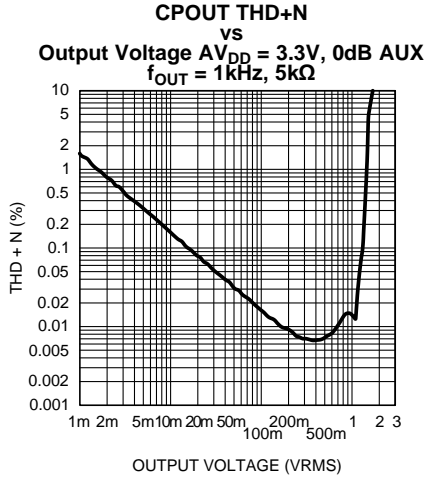

Figure 205.

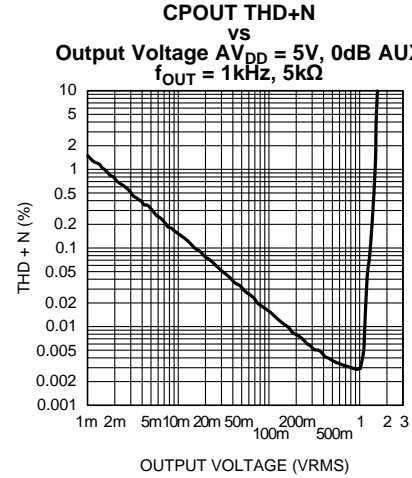

Figure 206.

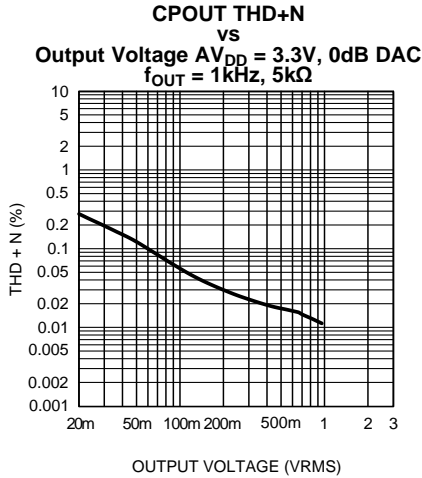

Figure 207.

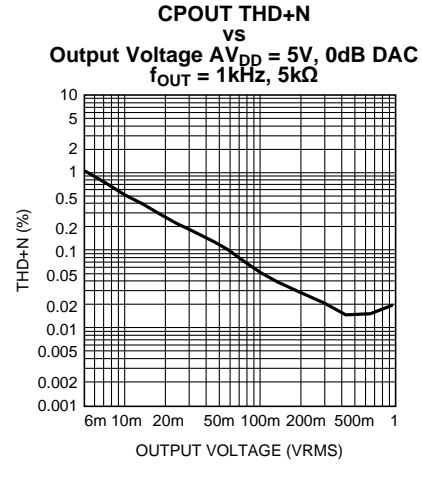

Figure 208.

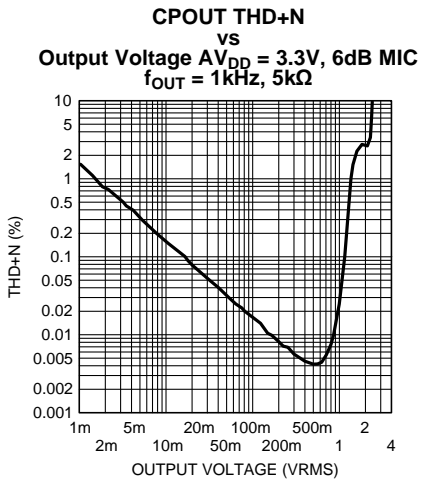

Figure 209.

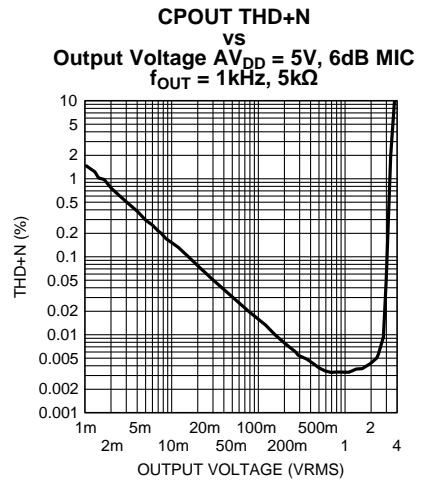

Figure 210.

Typical Performance Characteristics (continued)

(For all performance curves  $AV_{DD}$  refers to the voltage applied to the  $A_{VDD}$  and  $LS_{VDD}$  pins.  $DV_{DD}$  refers to the voltage applied to the  $D_{VDD}$  and  $PLL_{VDD}$  pins;  $AV_{DD} = 3.3V$  and  $DV_{DD} = 3.3V$  unless otherwise specified.

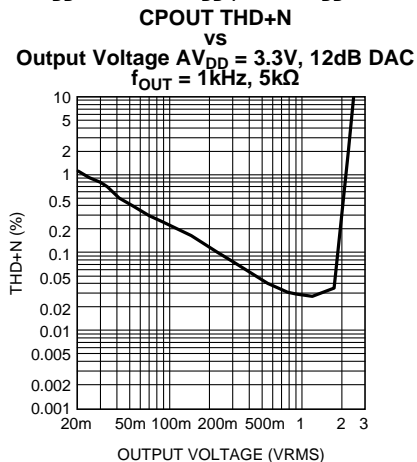

Figure 211.

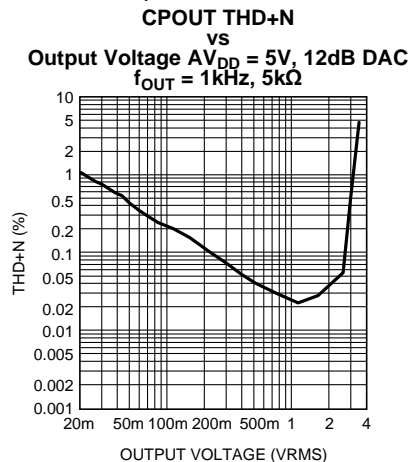

Figure 212.

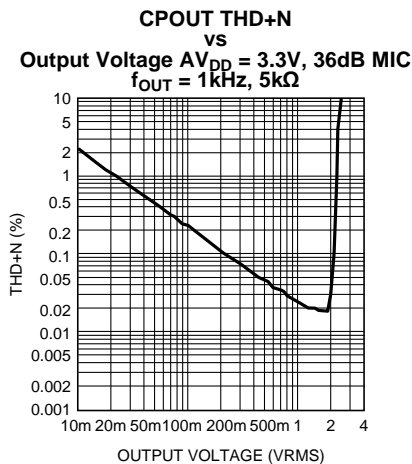

Figure 213.

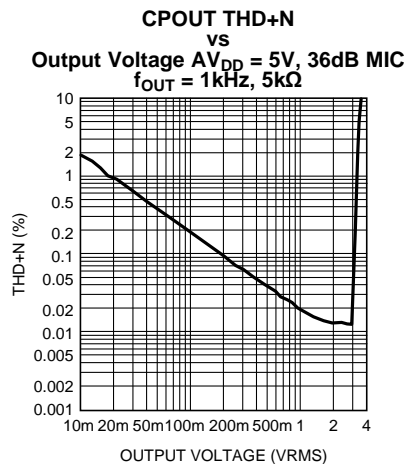

Figure 214.

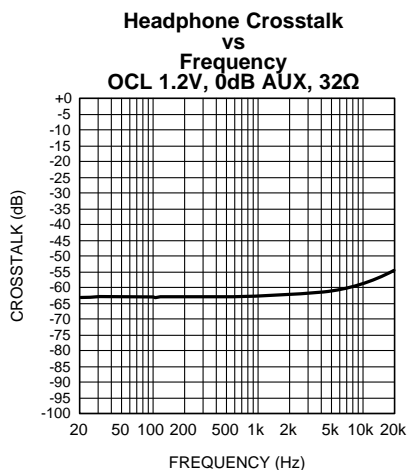

Figure 215.

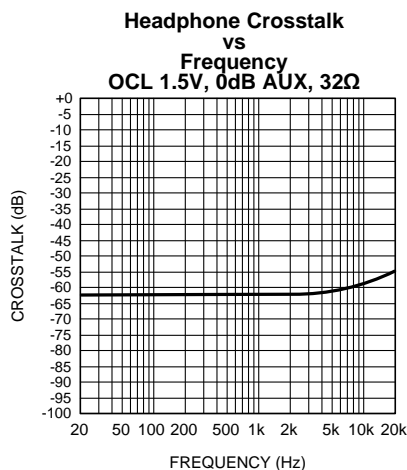
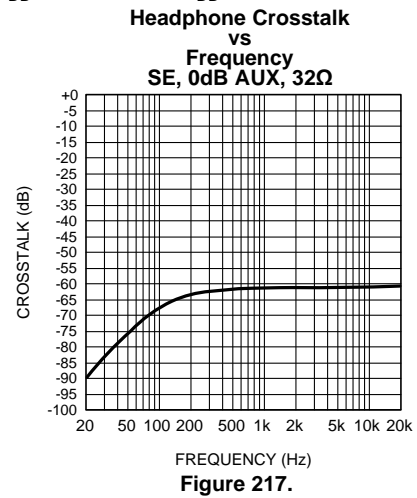

Figure 216.

### Typical Performance Characteristics (continued)

(For all performance curves  $AV_{DD}$  refers to the voltage applied to the  $A_{VDD}$  and  $LS_{VDD}$  pins.  $DV_{DD}$  refers to the voltage applied to the  $D_{VDD}$  and  $PLL_{VDD}$  pins;  $AV_{DD} = 3.3V$  and  $DV_{DD} = 3.3V$  unless otherwise specified.)



## APPLICATION NOTE

### MICROPHONE BIAS CONFIGURATIONS

#### Schematic Considerations for MEMs Microphones

The internal microphone bias of the LM49370 is provided through a two stage amplifier. Adding a capacitor larger than 100pF directly to this pin can cause instability. In many cases, when using MEMs microphones, a larger bypass capacitor is required on the INT\_MIC\_BIAS pin. To avoid oscillations and to keep the device stable, it is recommended to add a resistor ( $R_B$ ) greater than  $10\Omega$  in series with the capacitor ( $C_B$ ). Another option is to bias the MEMs microphone from the 1.8V supply used for  $D\_V_{DD}/IO\_V_{DD}$ .

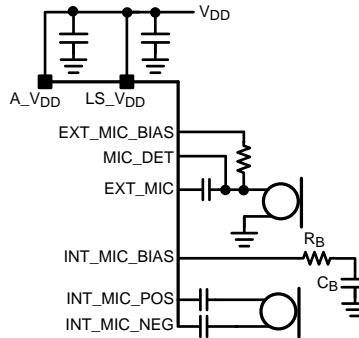

Figure 218. Schematic for MEMs Microphones

#### Schematic Considerations for ECM Microphones

When using ECM microphones, refer to the configurations shown in [Figure 219](#) to bias the microphones.

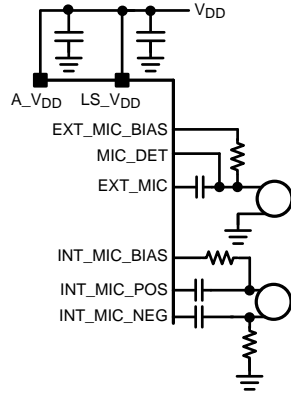

Figure 219. Schematic Option for ECM Microphones

### PCB LAYOUT CONSIDERATIONS

#### A\_VDD and LS\_VDD

Due to internal ESD diodes structure, for best performance, in the PCB board A\_VDD and LS\_VDD need to be tied to the same plane, but requires separate bypassing capacitors for each supply rail.

#### Microphone Inputs

When routing the differential microphone inputs the electrical length of the two traces should be well matched. The differential input pair can be routed in parallel on the same plane or the traces can overlap on two adjacent planes. It is important to surround these traces with a ground plane or trace to isolate the microphone inputs from the noise coupling from the class D amplifier.

### Class D Loudspeaker

To minimize trace resistance and therefore maintain the highest possible output power, the power (LS\_V<sub>DD</sub>) and class D output (LS-, LS+) traces should be as wide as possible. It is also essential to keep these same traces as short and well shielded as possible to decrease the amount of EMI radiation.

### Capacitors

All supply bypass capacitors (for A\_V<sub>DD</sub>, D\_V<sub>DD</sub>, I/O V<sub>DD</sub>, and LS\_V<sub>DD</sub>), and charge pump capacitors should be as close to the device as possible. Careful consideration should be taken with the ground connection of the analog supply (A\_V<sub>DD</sub>) bypass cap, for proper performance it should be referenced to a low noise ground plane. The charge pump capacitors and traces connecting the capacitor to the device should be kept away from the input and output traces to avoid noise coupling issues.

### LM49370 Demonstration Board Schematic Diagram

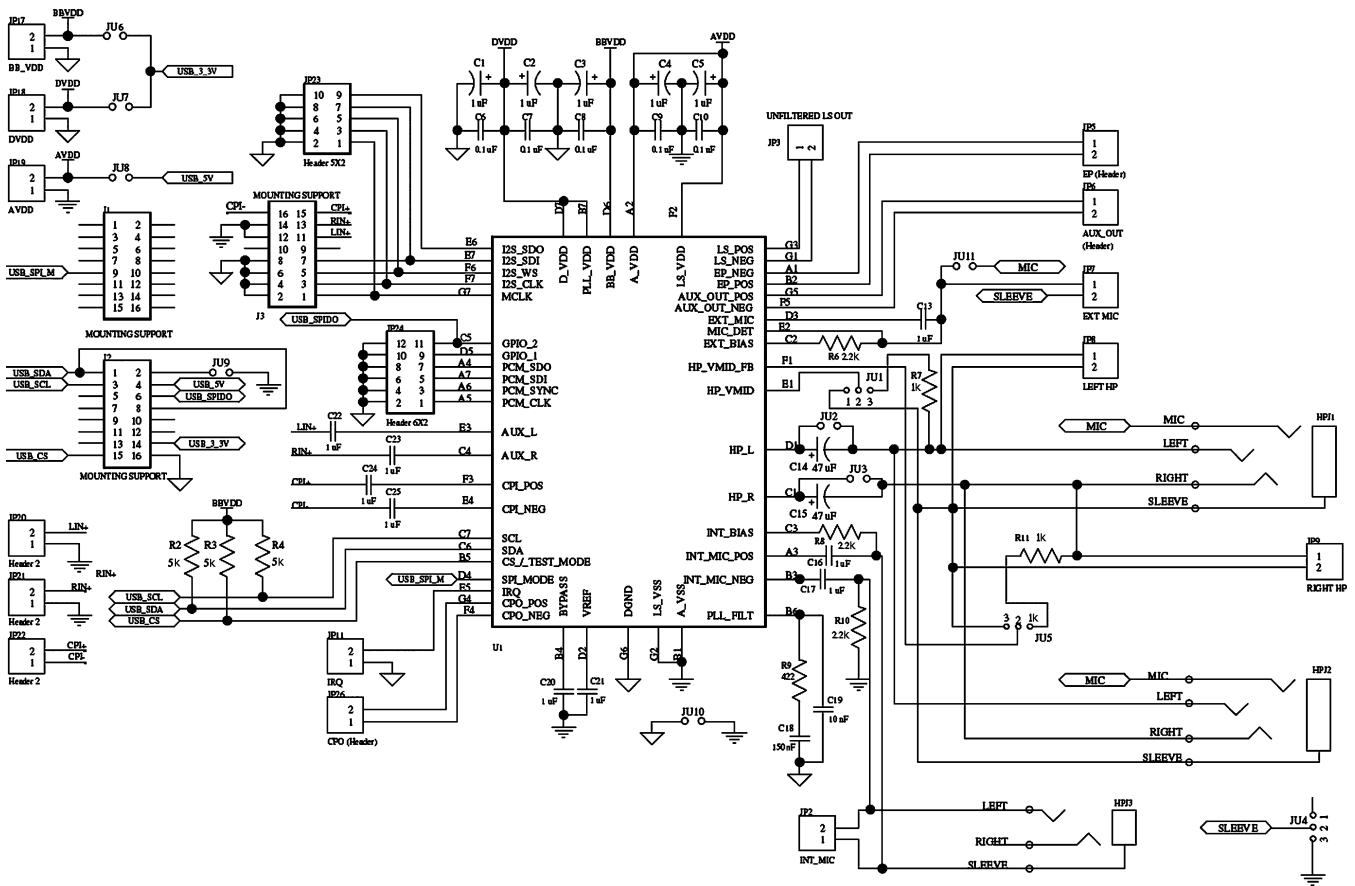



Demoboard PCB Layout

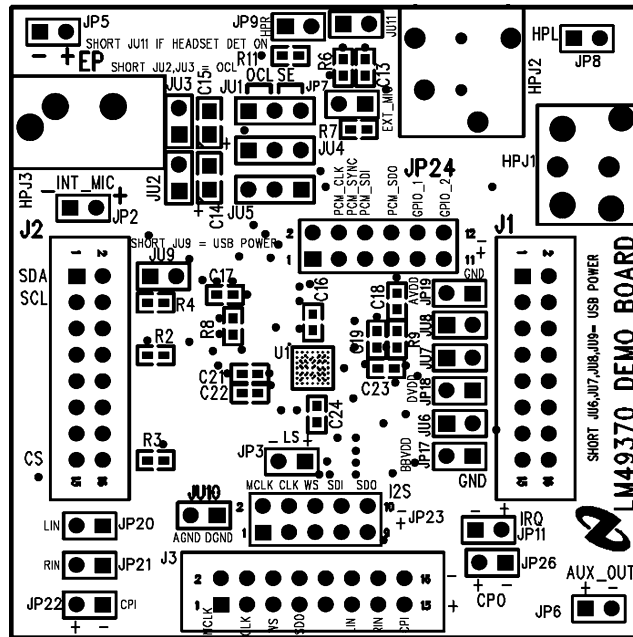

Figure 220. Top Silkscreen

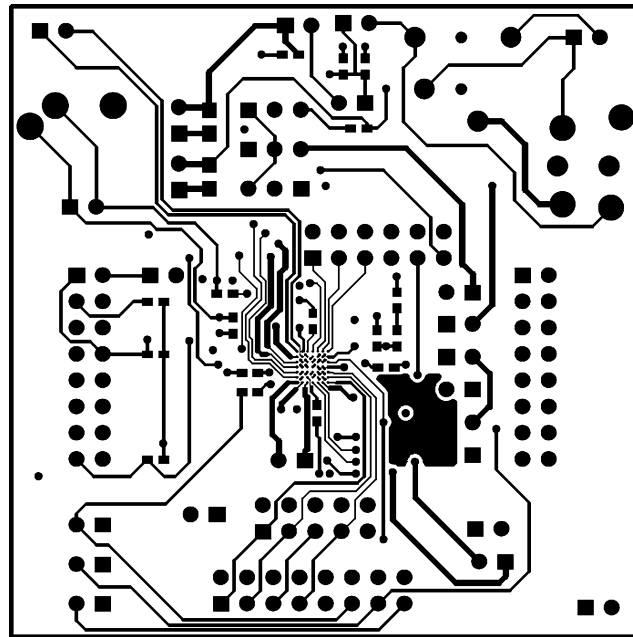

Figure 221. Top Layer

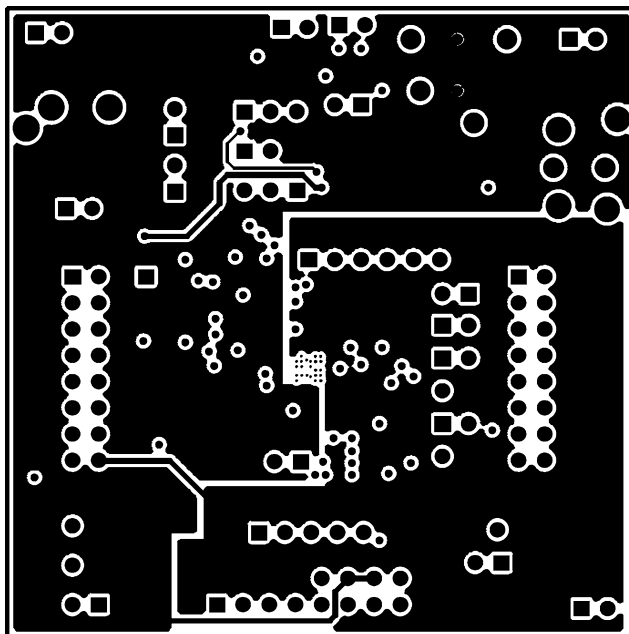

Figure 222. Mid Layer 1

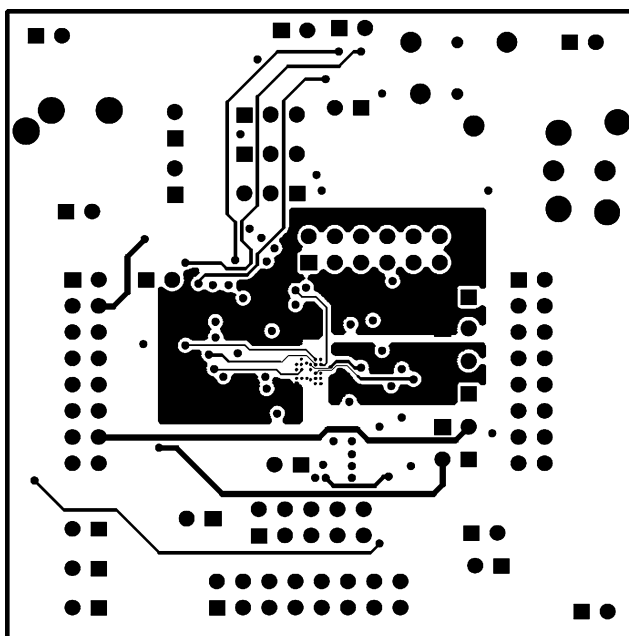

Figure 223. Mid Layer 2

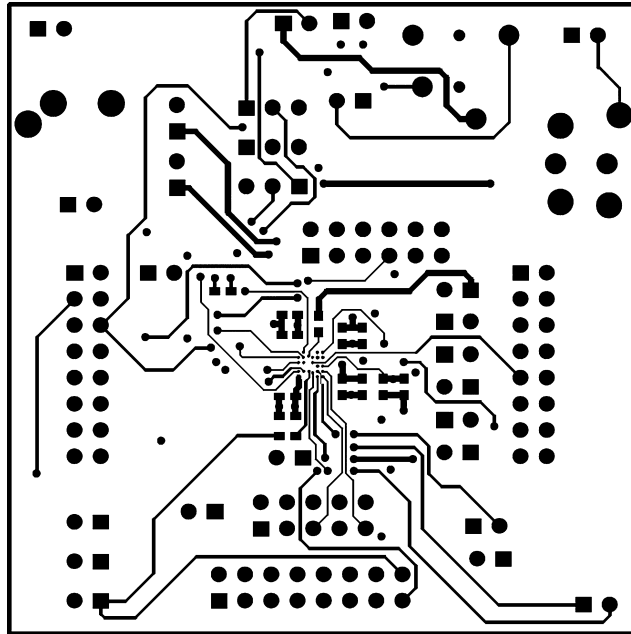

Figure 224. Bottom Layer

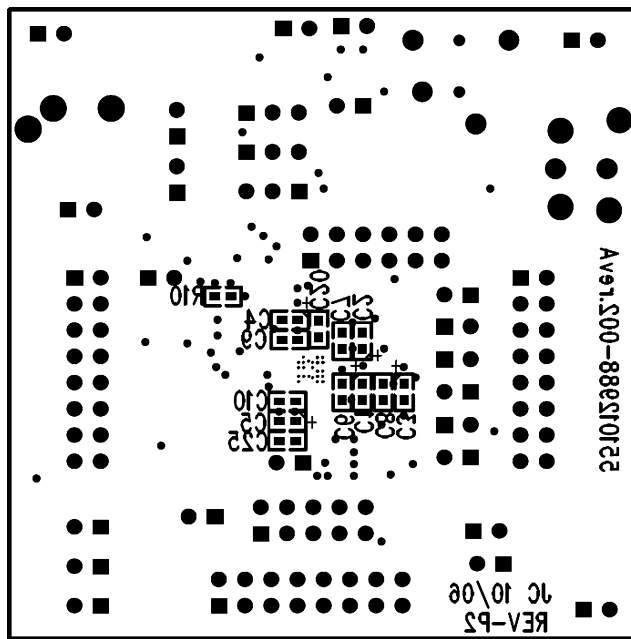

Figure 225. Bottom Silkscreen

**REVISION HISTORY**

Rev	Date	Description
1.0	02/14/07	Initial release.
1.01	01/08/08	Fixed a typo on X3 value (Physical Dimension section) in the last page.
1.02	02/11/08	Text edits.
1.03	03/31/11	Input edits and added the section "PLL LOOP FILTER".
1.04	05/26/11	Added the Application Note section.
1.05	06/02/11	Edited (tweak) Figures 16 and 17 (schematics for MEM and ECM microphones) respectively. Also added the paragraph "In non-OCL mode, two 1kohm resistors are optional..... (under Figure 9, Connection of Headset.... )
1.06	03/09/12	Replaced curve 20191721 (stereo DAC crosstalk, 32Ω) with 201917k5

**PACKAGING INFORMATION**

Orderable Device	Status (1)	Package Type	Package Drawing	Pins	Package Qty	Eco Plan (2)	Lead finish/ Ball material (6)	MSL Peak Temp (3)	Op Temp (°C)	Device Marking (4/5)	Samples
LM49370RL/NOPB	OBSOLETE	DSBGA	YPG	49		TBD	Call TI	Call TI	-40 to 85	GI3	

(1) The marketing status values are defined as follows:

**ACTIVE:** Product device recommended for new designs.

**LIFEBUY:** TI has announced that the device will be discontinued, and a lifetime-buy period is in effect.

**NRND:** Not recommended for new designs. Device is in production to support existing customers, but TI does not recommend using this part in a new design.

**PREVIEW:** Device has been announced but is not in production. Samples may or may not be available.

**OBSOLETE:** TI has discontinued the production of the device.

(2) **RoHS:** TI defines "RoHS" to mean semiconductor products that are compliant with the current EU RoHS requirements for all 10 RoHS substances, including the requirement that RoHS substance do not exceed 0.1% by weight in homogeneous materials. Where designed to be soldered at high temperatures, "RoHS" products are suitable for use in specified lead-free processes. TI may reference these types of products as "Pb-Free".

**RoHS Exempt:** TI defines "RoHS Exempt" to mean products that contain lead but are compliant with EU RoHS pursuant to a specific EU RoHS exemption.

**Green:** TI defines "Green" to mean the content of Chlorine (Cl) and Bromine (Br) based flame retardants meet JS709B low halogen requirements of <=1000ppm threshold. Antimony trioxide based flame retardants must also meet the <=1000ppm threshold requirement.

(3) MSL, Peak Temp. - The Moisture Sensitivity Level rating according to the JEDEC industry standard classifications, and peak solder temperature.

(4) There may be additional marking, which relates to the logo, the lot trace code information, or the environmental category on the device.

(5) Multiple Device Markings will be inside parentheses. Only one Device Marking contained in parentheses and separated by a "-" will appear on a device. If a line is indented then it is a continuation of the previous line and the two combined represent the entire Device Marking for that device.

(6) Lead finish/Ball material - Orderable Devices may have multiple material finish options. Finish options are separated by a vertical ruled line. Lead finish/Ball material values may wrap to two lines if the finish value exceeds the maximum column width.

**Important Information and Disclaimer:**The information provided on this page represents TI's knowledge and belief as of the date that it is provided. TI bases its knowledge and belief on information provided by third parties, and makes no representation or warranty as to the accuracy of such information. Efforts are underway to better integrate information from third parties. TI has taken and continues to take reasonable steps to provide representative and accurate information but may not have conducted destructive testing or chemical analysis on incoming materials and chemicals. TI and TI suppliers consider certain information to be proprietary, and thus CAS numbers and other limited information may not be available for release.

In no event shall TI's liability arising out of such information exceed the total purchase price of the TI part(s) at issue in this document sold by TI to Customer on an annual basis.

YPG0049

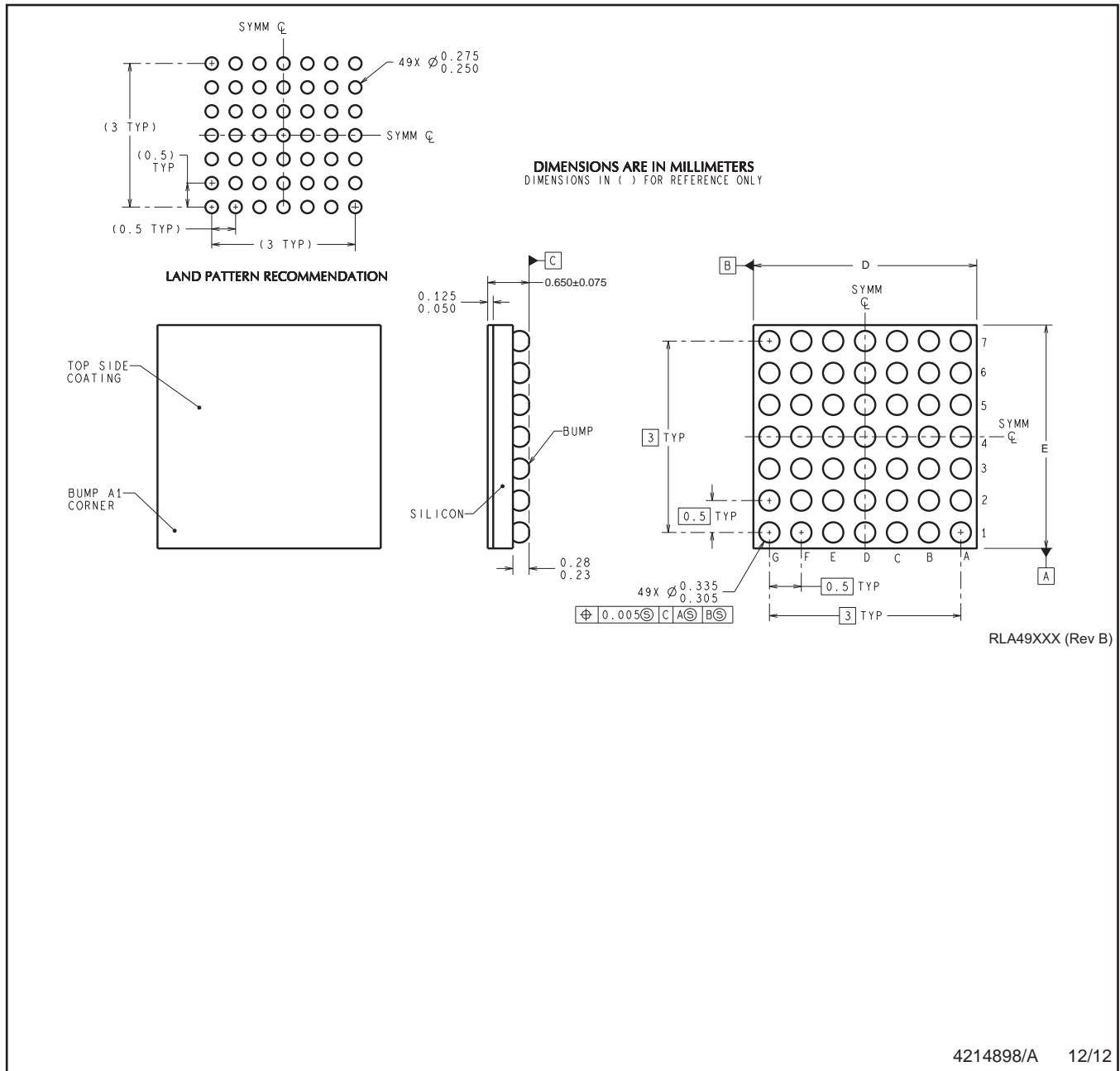

NOTES: A. All linear dimensions are in millimeters. Dimensioning and tolerancing per ASME Y14.5M-1994.  
B. This drawing is subject to change without notice.

## IMPORTANT NOTICE AND DISCLAIMER

TI PROVIDES TECHNICAL AND RELIABILITY DATA (INCLUDING DATA SHEETS), DESIGN RESOURCES (INCLUDING REFERENCE DESIGNS), APPLICATION OR OTHER DESIGN ADVICE, WEB TOOLS, SAFETY INFORMATION, AND OTHER RESOURCES "AS IS" AND WITH ALL FAULTS, AND DISCLAIMS ALL WARRANTIES, EXPRESS AND IMPLIED, INCLUDING WITHOUT LIMITATION ANY IMPLIED WARRANTIES OF MERCHANTABILITY, FITNESS FOR A PARTICULAR PURPOSE OR NON-INFRINGEMENT OF THIRD PARTY INTELLECTUAL PROPERTY RIGHTS.

These resources are intended for skilled developers designing with TI products. You are solely responsible for (1) selecting the appropriate TI products for your application, (2) designing, validating and testing your application, and (3) ensuring your application meets applicable standards, and any other safety, security, regulatory or other requirements.

These resources are subject to change without notice. TI grants you permission to use these resources only for development of an application that uses the TI products described in the resource. Other reproduction and display of these resources is prohibited. No license is granted to any other TI intellectual property right or to any third party intellectual property right. TI disclaims responsibility for, and you will fully indemnify TI and its representatives against, any claims, damages, costs, losses, and liabilities arising out of your use of these resources.

TI's products are provided subject to [TI's Terms of Sale](#) or other applicable terms available either on [ti.com](https://www.ti.com) or provided in conjunction with such TI products. TI's provision of these resources does not expand or otherwise alter TI's applicable warranties or warranty disclaimers for TI products.

TI objects to and rejects any additional or different terms you may have proposed.

Mailing Address: Texas Instruments, Post Office Box 655303, Dallas, Texas 75265  
Copyright © 2024, Texas Instruments Incorporated