

LM62 2.7V, 15.6 mV/°C SOT-23 Temperature Sensor

Check for Samples: [LM62](#)

FEATURES

- Calibrated Linear Scale Factor of +15.6 mV/°C
- Rated for Full 0°C to +90°C Range with 3.0V Supply
- Suitable for Remote Applications

APPLICATIONS

- Cellular Phones
- Computers
- Power Supply Modules
- Battery Management
- FAX Machines
- Printers
- HVAC
- Disk Drives
- Appliances

KEY SPECIFICATIONS

- Accuracy at 25°C ±2.0 or ±3.0°C (max)
- Temperature Slope +15.6 mV/°C
- Power Supply Voltage Range +2.7V to +10V
- Current Drain @ 25°C 130 µA (max)
- Nonlinearity ±0.8°C (max)
- Output Impedance 4.7 kΩ (max)

Connection Diagram

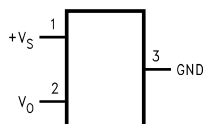

See Package Number DBZ

DESCRIPTION

The LM62 is a precision integrated-circuit temperature sensor that can sense a 0°C to +90°C temperature range while operating from a single +3.0V supply. The LM62's output voltage is linearly proportional to Celsius (Centigrade) temperature (+15.6 mV/°C) and has a DC offset of +480 mV. The offset allows reading temperatures down to 0°C without the need for a negative supply. The nominal output voltage of the LM62 ranges from +480 mV to +1884 mV for a 0°C to +90°C temperature range. The LM62 is calibrated to provide accuracies of ±2.0°C at room temperature and +2.5°C/–2.0°C over the full 0°C to +90°C temperature range.

The LM62's linear output, +480 mV offset, and factory calibration simplify external circuitry required in a single supply environment where reading temperatures down to 0°C is required. Because the LM62's quiescent current is less than 130 µA, self-heating is limited to a very low 0.2°C in still air. Shutdown capability for the LM62 is intrinsic because its inherent low power consumption allows it to be powered directly from the output of many logic gates.

Typical Application

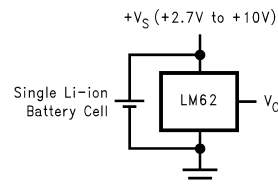

$$V_O = (+15.6 \text{ mV/}^\circ\text{C} \times T^\circ\text{C}) + 480 \text{ mV}$$

Figure 1. Full-Range Centigrade Temp. Sensor (0°C to +90°C) Stabilizing a Crystal Oscillator

Temperature (T)	Typical V_O
+90°C	+1884 mV
+70°C	+1572 mV
+25°C	870 mV
0°C	+480 mV



Please be aware that an important notice concerning availability, standard warranty, and use in critical applications of Texas Instruments semiconductor products and disclaimers thereto appears at the end of this data sheet.

All trademarks are the property of their respective owners.

Absolute Maximum Ratings⁽¹⁾

Supply Voltage		+12V to -0.2V
Output Voltage		(+V _S + 0.6V) to -0.6V
Output Current		10 mA
Input Current at any pin ⁽²⁾		5 mA
Storage Temperature		-65°C to +150°C
Junction Temperature, max (T _{JMAX})		+125°C
ESD Susceptibility ⁽³⁾	Human Body Model	2500V
	Machine Model	250V

- (1) Absolute Maximum Ratings indicate limits beyond which damage to the device may occur. Operating Ratings indicate conditions for which the device is functional, but do not ensure specific performance limits. For ensured specifications and test conditions, see the Electrical Characteristics. The ensured specifications apply only for the test conditions listed. Some performance characteristics may degrade when the device is not operated under the listed test conditions.
- (2) When the input voltage (V_I) at any pin exceeds power supplies (V_I < GND or V_I > +V_S), the current at that pin should be limited to 5 mA.
- (3) The human body model is a 100 pF capacitor discharged through a 1.5 kΩ resistor into each pin. The machine model is a 200 pF capacitor discharged directly into each pin.

Operating Ratings⁽¹⁾

Specified Temperature Range		T_{MIN} ≤ T_A ≤ T_{MAX}
LM62B, LM62C		0°C ≤ T _A ≤ +90°C
Supply Voltage Range (+V _S)		+2.7V to +10V
Thermal Resistance, θ _{JA} ⁽²⁾		450°C/W
Soldering process must comply with Texas Instruments' Reflow Temperature Profile specifications. Refer to http://www.ti.com/packaging ⁽³⁾		

- (1) Absolute Maximum Ratings indicate limits beyond which damage to the device may occur. Operating Ratings indicate conditions for which the device is functional, but do not ensure specific performance limits. For ensured specifications and test conditions, see the Electrical Characteristics. The ensured specifications apply only for the test conditions listed. Some performance characteristics may degrade when the device is not operated under the listed test conditions.
- (2) The junction to ambient thermal resistance (θ_{JA}) is specified without a heat sink in still air.
- (3) Reflow temperature profiles are different for lead-free and non-lead-free packages.

Electrical Characteristics

Unless otherwise noted, these specifications apply for $+V_S = +3.0 V_{DC}$. **Boldface limits apply for $T_A = T_J = T_{MIN}$ to T_{MAX}** ; all other limits $T_A = T_J = 25^\circ C$.

Parameter	Conditions	Typical ⁽¹⁾	LM62B	LM62C	Units (Limit)
			Limits ⁽²⁾	Limits ⁽²⁾	
Accuracy ⁽³⁾			± 2.0	± 3.0	$^\circ C$ (max)
			$+2.5/-2.0$	$+4.0/-3.0$	$^\circ C$ (max)
Output Voltage at $0^\circ C$		+480			mV
Nonlinearity ⁽⁴⁾			± 0.8	± 1.0	$^\circ C$ (max)
Sensor Gain (Average Slope)		+16	+16.1 +15.1	+16.3 +14.9	mV/ $^\circ C$ (max) mV/ $^\circ C$ (min)
Output Impedance	$+3.0V \leq +V_S \leq +10V$		4.7	4.7	k Ω (max)
	$0^\circ C \leq T_A \leq +75^\circ C, +V_S = +2.7V$		4.4	4.4	k Ω (max)
Line Regulation ⁽⁵⁾	$+3.0V \leq +V_S \leq +10V$		± 1.13	± 1.13	mV/V (max)
	$+2.7V \leq +V_S \leq +3.3V, 0^\circ C \leq T_A \leq +75^\circ C$		± 9.7	± 9.7	mV (max)
Quiescent Current	$+2.7V \leq +V_S \leq +10V$	82	130 165	130 165	μA (max) μA (max)
Change of Quiescent Current	$+2.7V \leq +V_S \leq +10V$	± 5			μA
Temperature Coefficient of Quiescent Current		0.2			$\mu A/^\circ C$
Long Term Stability ⁽⁶⁾	$T_J = T_{MAX} = +100^\circ C$, for 1000 hours	± 0.2			$^\circ C$

- (1) Typicals are at $T_J = T_A = 25^\circ C$ and represent most likely parametric norm.
- (2) Limits are ensured to Texas Instruments' AOQL (Average Outgoing Quality Level).
- (3) Accuracy is defined as the error between the output voltage and $+15.6 mV/^\circ C$ times the device's case temperature plus 480 mV, at specified conditions of voltage, current, and temperature (expressed in $^\circ C$).
- (4) Nonlinearity is defined as the deviation of the output-voltage-versus-temperature curve from the best-fit straight line, over the device's rated temperature range.
- (5) Regulation is measured at constant junction temperature, using pulse testing with a low duty cycle. Changes in output due to heating effects can be computed by multiplying the internal dissipation by the thermal resistance.
- (6) For best long-term stability, any precision circuit will give best results if the unit is aged at a warm temperature, and/or temperature cycled for at least 46 hours before long-term life test begins. This is especially true when a small (Surface-Mount) part is wave-soldered; allow time for stress relaxation to occur. The majority of the drift will occur in the first 1000 hours at elevated temperatures. The drift after 1000 hours will not continue at the first 1000 hour rate.

Typical Performance Characteristics

To generate these curves the LM62 was mounted to a printed circuit board as shown in [Figure 12](#).

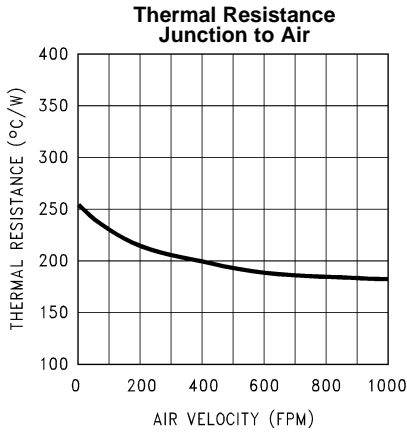

Figure 2.

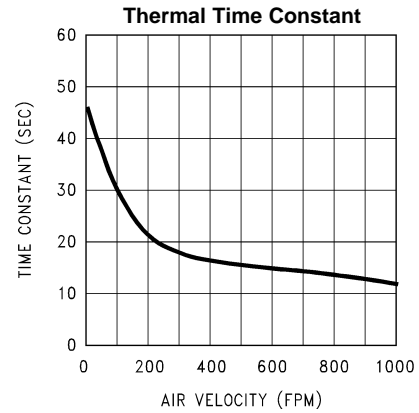

Figure 3.

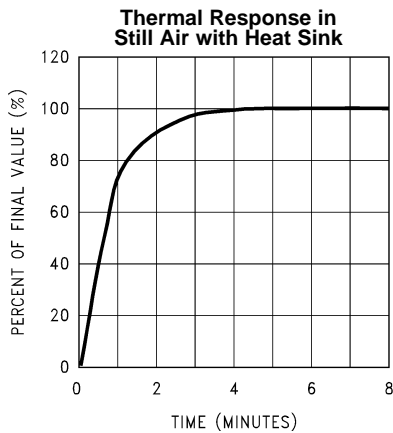

Figure 4.

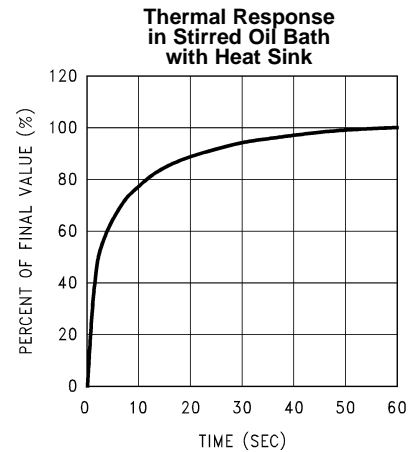

Figure 5.

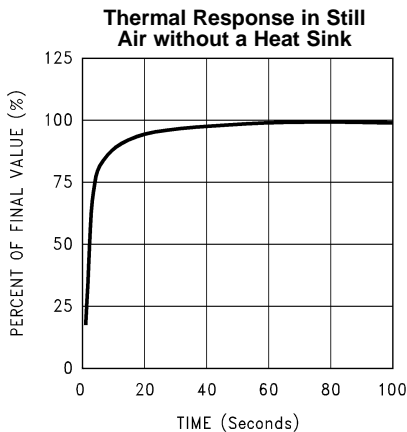

Figure 6.

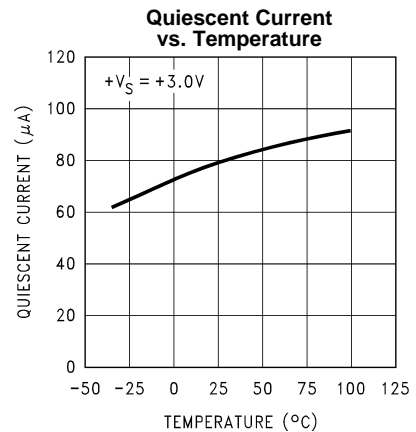

Figure 7.

Typical Performance Characteristics (continued)

To generate these curves the LM62 was mounted to a printed circuit board as shown in Figure 12.

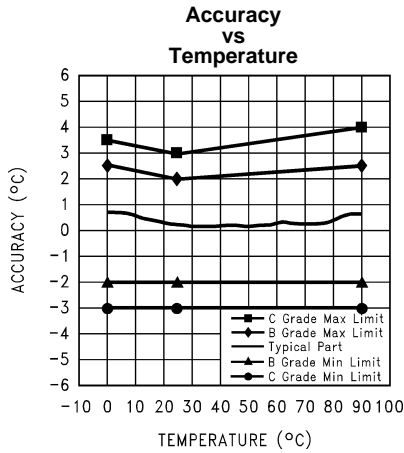

Figure 8.

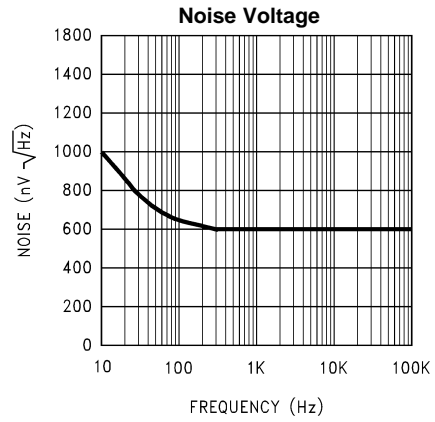

Figure 9.

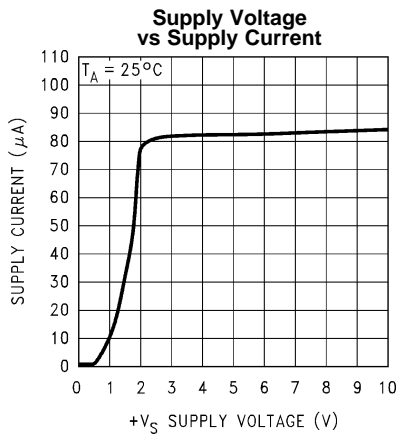

Figure 10.

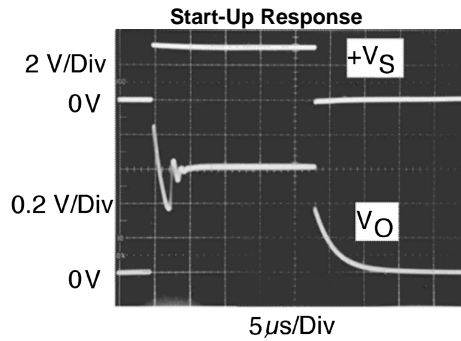
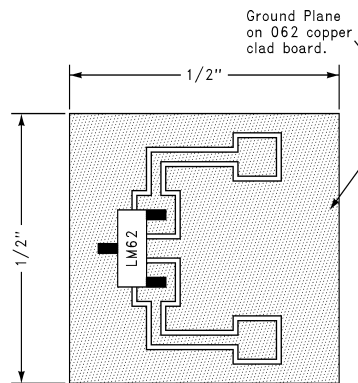

Figure 11.

CIRCUIT BOARD



1/2" Square Printed Circuit Board with 2 oz. Copper Foil or Similar.

Figure 12. Printed Circuit Board Used for Heat Sink to Generate All Curves

Mounting

The LM62 can be applied easily in the same way as other integrated-circuit temperature sensors. It can be glued or cemented to a surface. The temperature that the LM62 is sensing will be within about +0.2°C of the surface temperature that LM62's leads are attached to.

This presumes that the ambient air temperature is almost the same as the surface temperature; if the air temperature were much higher or lower than the surface temperature, the actual temperature measured would be at an intermediate temperature between the surface temperature and the air temperature.

To ensure good thermal conductivity the backside of the LM62 die is directly attached to the GND pin. The lands and traces to the LM62 will, of course, be part of the printed circuit board, which is the object whose temperature is being measured. These printed circuit board lands and traces will not cause the LM62's temperature to deviate from the desired temperature.

Alternatively, the LM62 can be mounted inside a sealed-end metal tube, and can then be dipped into a bath or screwed into a threaded hole in a tank. As with any IC, the LM62 and accompanying wiring and circuits must be kept insulated and dry, to avoid leakage and corrosion. This is especially true if the circuit may operate at cold temperatures where condensation can occur. Printed-circuit coatings and varnishes such as Humiseal and epoxy paints or dips are often used to ensure that moisture cannot corrode the LM62 or its connections.

The thermal resistance junction to ambient (θ_{JA}) is the parameter used to calculate the rise of a device junction temperature due to its power dissipation. For the LM62 the equation used to calculate the rise in the die temperature is as follows:

$$T_J = T_A + \theta_{JA} [(+V_S I_Q) + (+V_S - V_O) I_L] \quad (1)$$

where I_Q is the quiescent current and I_L is the load current on the output. Since the LM62's junction temperature is the actual temperature being measured care should be taken to minimize the load current that the LM62 is required to drive.

The table shown in [Table 1](#) summarizes the rise in die temperature of the LM62 without any loading, and the thermal resistance for different conditions.

Table 1. Temperature Rise of LM62 Due to Self-Heating and Thermal Resistance (θ_{JA})

	SOT-23 no heat sink ⁽¹⁾		SOT-23 small heat fin ⁽²⁾	
	θ_{JA} (°C/W)	$T_J - T_A$ (°C)	θ_{JA} (°C/W)	$T_J - T_A$ (°C)
Still air	450	0.17	260	0.1
Moving air			180	0.07

(1) Part soldered to 30 gauge wire.

(2) Heat sink used is 1/2" square printed circuit board with 2 oz. foil with part attached as shown in [Figure 12](#).

Capacitive Loads

The LM62 handles capacitive loading well. Without any special precautions, the LM62 can drive any capacitive load as shown in Figure 13. Over the specified temperature range the LM62 has a maximum output impedance of 4.7 kΩ. In an extremely noisy environment it may be necessary to add some filtering to minimize noise pickup. It is recommended that 0.1 μF be added from +V_S to GND to bypass the power supply voltage, as shown in Figure 14. In a noisy environment it may be necessary to add a capacitor from the output to ground. A 1 μF output capacitor with the 4.7 kΩ maximum output impedance will form a 34 Hz lowpass filter. Since the thermal time constant of the LM62 is much slower than the 30 ms time constant formed by the RC, the overall response time of the LM62 will not be significantly affected. For much larger capacitors this additional time lag will increase the overall response time of the LM62.

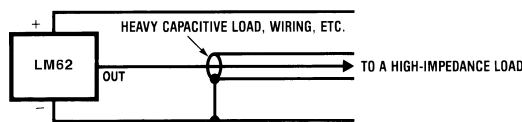

Figure 13. LM62 No Decoupling Required for Capacitive Load

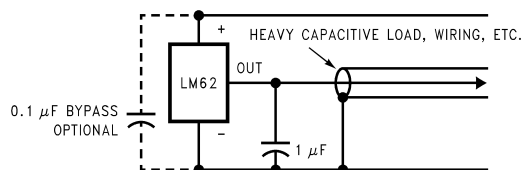

Figure 14. LM62 with Filter for Noisy Environment

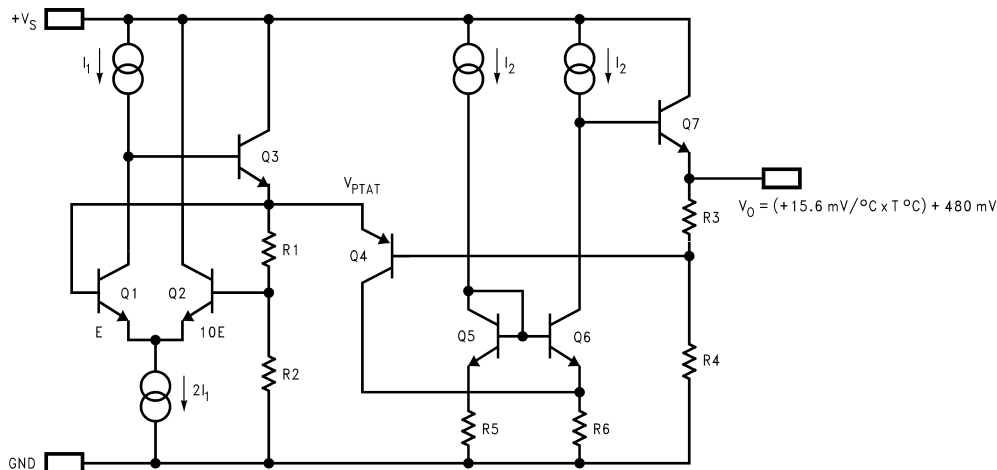

Figure 15. Simplified Schematic

Applications Circuits

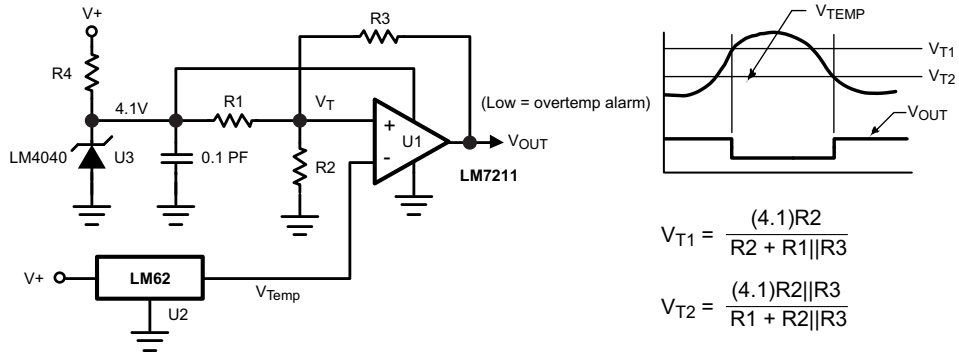

Figure 16. Centigrade Thermostat

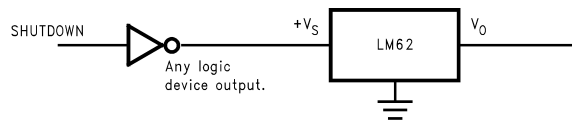

Figure 17. Conserving Power Dissipation with Shutdown

REVISION HISTORY

Changes from Revision D (March 2013) to Revision E	Page
<hr/> <ul style="list-style-type: none">• Changed layout of National Data Sheet to TI format	<hr/> 8

PACKAGING INFORMATION

Orderable Device	Status (1)	Package Type	Package Drawing	Pins	Package Qty	Eco Plan (2)	Lead finish/ Ball material (6)	MSL Peak Temp (3)	Op Temp (°C)	Device Marking (4/5)	Samples
LM62BIM3X/NOPB	ACTIVE	SOT-23	DBZ	3	3000	RoHS & Green	SN	Level-1-260C-UNLIM	0 to 90	T7B	Samples
LM62CIM3X/NOPB	ACTIVE	SOT-23	DBZ	3	3000	RoHS & Green	SN	Level-1-260C-UNLIM	0 to 90	T7C	Samples

(1) The marketing status values are defined as follows:

ACTIVE: Product device recommended for new designs.

LIFEBUY: TI has announced that the device will be discontinued, and a lifetime-buy period is in effect.

NRND: Not recommended for new designs. Device is in production to support existing customers, but TI does not recommend using this part in a new design.

PREVIEW: Device has been announced but is not in production. Samples may or may not be available.

OBSOLETE: TI has discontinued the production of the device.

(2) **RoHS:** TI defines "RoHS" to mean semiconductor products that are compliant with the current EU RoHS requirements for all 10 RoHS substances, including the requirement that RoHS substance do not exceed 0.1% by weight in homogeneous materials. Where designed to be soldered at high temperatures, "RoHS" products are suitable for use in specified lead-free processes. TI may reference these types of products as "Pb-Free".

RoHS Exempt: TI defines "RoHS Exempt" to mean products that contain lead but are compliant with EU RoHS pursuant to a specific EU RoHS exemption.

Green: TI defines "Green" to mean the content of Chlorine (Cl) and Bromine (Br) based flame retardants meet JS709B low halogen requirements of <=1000ppm threshold. Antimony trioxide based flame retardants must also meet the <=1000ppm threshold requirement.

(3) MSL, Peak Temp. - The Moisture Sensitivity Level rating according to the JEDEC industry standard classifications, and peak solder temperature.

(4) There may be additional marking, which relates to the logo, the lot trace code information, or the environmental category on the device.

(5) Multiple Device Markings will be inside parentheses. Only one Device Marking contained in parentheses and separated by a "~" will appear on a device. If a line is indented then it is a continuation of the previous line and the two combined represent the entire Device Marking for that device.

(6) Lead finish/Ball material - Orderable Devices may have multiple material finish options. Finish options are separated by a vertical ruled line. Lead finish/Ball material values may wrap to two lines if the finish value exceeds the maximum column width.

Important Information and Disclaimer:The information provided on this page represents TI's knowledge and belief as of the date that it is provided. TI bases its knowledge and belief on information provided by third parties, and makes no representation or warranty as to the accuracy of such information. Efforts are underway to better integrate information from third parties. TI has taken and continues to take reasonable steps to provide representative and accurate information but may not have conducted destructive testing or chemical analysis on incoming materials and chemicals. TI and TI suppliers consider certain information to be proprietary, and thus CAS numbers and other limited information may not be available for release.

In no event shall TI's liability arising out of such information exceed the total purchase price of the TI part(s) at issue in this document sold by TI to Customer on an annual basis.

TAPE AND REEL INFORMATION

QUADRANT ASSIGNMENTS FOR PIN 1 ORIENTATION IN TAPE

*All dimensions are nominal

Device	Package Type	Package Drawing	Pins	SPQ	Reel Diameter (mm)	Reel Width W1 (mm)	A0 (mm)	B0 (mm)	K0 (mm)	P1 (mm)	W (mm)	Pin1 Quadrant
LM62BIM3X/NOPB	SOT-23	DBZ	3	3000	178.0	8.4	3.3	2.9	1.22	4.0	8.0	Q3
LM62CIM3X/NOPB	SOT-23	DBZ	3	3000	178.0	8.4	3.3	2.9	1.22	4.0	8.0	Q3

TAPE AND REEL BOX DIMENSIONS

*All dimensions are nominal

Device	Package Type	Package Drawing	Pins	SPQ	Length (mm)	Width (mm)	Height (mm)
LM62BIM3X/NOPB	SOT-23	DBZ	3	3000	208.0	191.0	35.0
LM62CIM3X/NOPB	SOT-23	DBZ	3	3000	208.0	191.0	35.0

DBZ0003A



PACKAGE OUTLINE

SOT-23 - 1.12 mm max height

SMALL OUTLINE TRANSISTOR

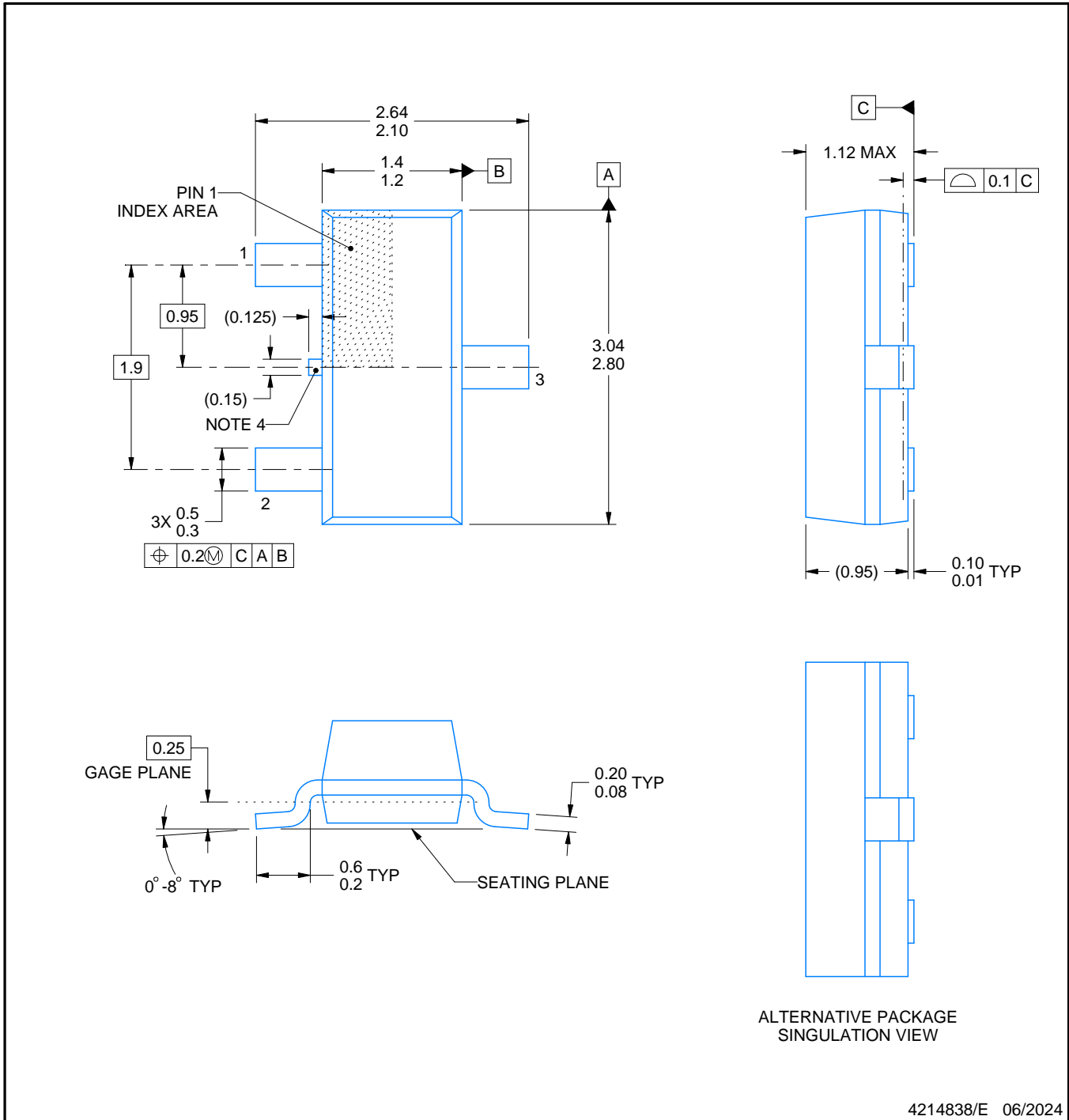

4214838/E 06/2024

NOTES:

- All linear dimensions are in millimeters. Any dimensions in parenthesis are for reference only. Dimensioning and tolerancing per ASME Y14.5M.
- This drawing is subject to change without notice.
- Reference JEDEC registration TO-236, except minimum foot length.
- Support pin may differ or may not be present.
- Body dimensions do not include mold flash, protrusions, or gate burrs. Mold flash, protrusions, or gate burrs shall not exceed 0.25mm per side

EXAMPLE BOARD LAYOUT

DBZ0003A

SOT-23 - 1.12 mm max height

SMALL OUTLINE TRANSISTOR

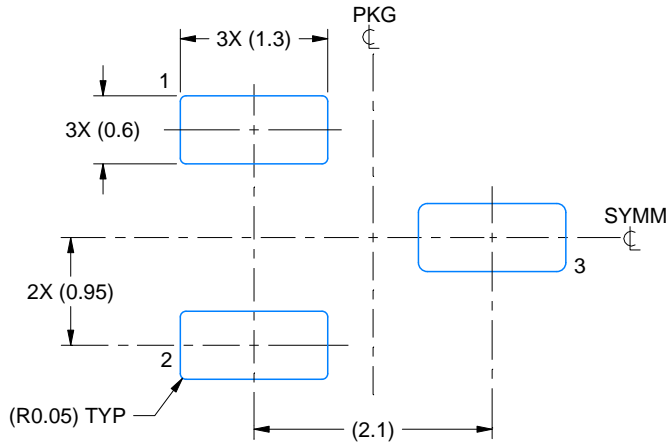

LAND PATTERN EXAMPLE
SCALE:15X

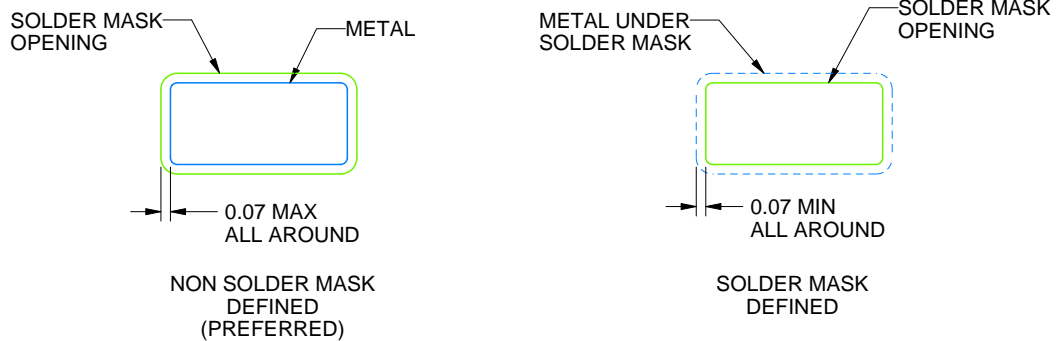

SOLDER MASK DETAILS

4214838/E 06/2024

NOTES: (continued)

5. Publication IPC-7351 may have alternate designs.
6. Solder mask tolerances between and around signal pads can vary based on board fabrication site.

EXAMPLE STENCIL DESIGN

DBZ0003A

SOT-23 - 1.12 mm max height

SMALL OUTLINE TRANSISTOR

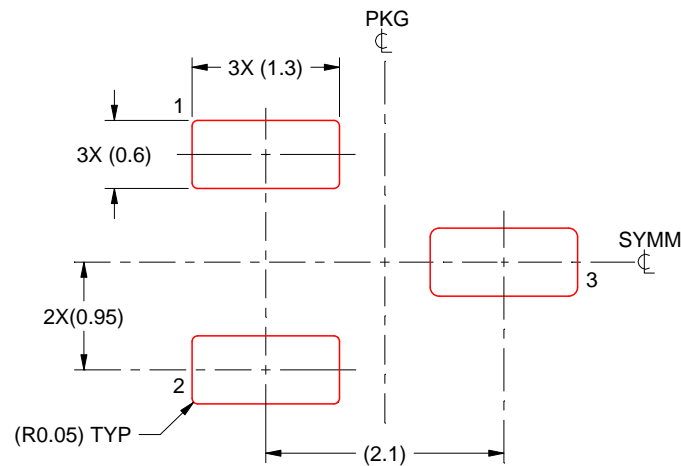

SOLDER PASTE EXAMPLE
BASED ON 0.125 THICK STENCIL
SCALE:15X

4214838/E 06/2024

NOTES: (continued)

7. Laser cutting apertures with trapezoidal walls and rounded corners may offer better paste release. IPC-7525 may have alternate design recommendations.
8. Board assembly site may have different recommendations for stencil design.

IMPORTANT NOTICE AND DISCLAIMER

TI PROVIDES TECHNICAL AND RELIABILITY DATA (INCLUDING DATA SHEETS), DESIGN RESOURCES (INCLUDING REFERENCE DESIGNS), APPLICATION OR OTHER DESIGN ADVICE, WEB TOOLS, SAFETY INFORMATION, AND OTHER RESOURCES "AS IS" AND WITH ALL FAULTS, AND DISCLAIMS ALL WARRANTIES, EXPRESS AND IMPLIED, INCLUDING WITHOUT LIMITATION ANY IMPLIED WARRANTIES OF MERCHANTABILITY, FITNESS FOR A PARTICULAR PURPOSE OR NON-INFRINGEMENT OF THIRD PARTY INTELLECTUAL PROPERTY RIGHTS.

These resources are intended for skilled developers designing with TI products. You are solely responsible for (1) selecting the appropriate TI products for your application, (2) designing, validating and testing your application, and (3) ensuring your application meets applicable standards, and any other safety, security, regulatory or other requirements.

These resources are subject to change without notice. TI grants you permission to use these resources only for development of an application that uses the TI products described in the resource. Other reproduction and display of these resources is prohibited. No license is granted to any other TI intellectual property right or to any third party intellectual property right. TI disclaims responsibility for, and you will fully indemnify TI and its representatives against, any claims, damages, costs, losses, and liabilities arising out of your use of these resources.

TI's products are provided subject to [TI's Terms of Sale](#) or other applicable terms available either on [ti.com](https://www.ti.com) or provided in conjunction with such TI products. TI's provision of these resources does not expand or otherwise alter TI's applicable warranties or warranty disclaimers for TI products.

TI objects to and rejects any additional or different terms you may have proposed.

Mailing Address: Texas Instruments, Post Office Box 655303, Dallas, Texas 75265
Copyright © 2024, Texas Instruments Incorporated