

LMC7101 Tiny, Low-Power Operational Amplifier With Rail-to-Rail Input and Output

1 Features

- Tiny 5-Pin SOT-23 package saves space; typical circuit layouts take half the space of 8-pin SOIC designs
- Specified for 2.7V, 3V, 5V, and 15V supplies
- Typical supply current 0.5mA at 5V
- Typical total harmonic distortion of 0.01% at 5V
- 1MHz gain bandwidth
- Specified to industrial temperature: -40°C to $+85^{\circ}\text{C}$
- Similar to popular [LMC6482](#) and [LMC6484](#)
- Rail-to-rail input and output

2 Applications

- Mobile communications
- Notebooks and PDAs
- Battery-powered products
- Sensor interface
- Automotive applications

3 Description

The LMC7101 device is a high-performance, automotive, CMOS operational amplifier available in a space-saving, 5-pin, SOT-23 tiny package. This design makes the LMC7101 an excellent choice for space- and weight-critical designs. The performance is similar to the single amplifier of the LMC6482 and LMC6484, with rail-to-rail input and output, high open-loop gain, low distortion, and low-supply currents.

The main benefits of the tiny package are most apparent in small, portable electronic devices, such as mobile phones, pagers, notebook computers, personal digital assistants, and PCMCIA cards. The tiny amplifiers can be placed on a board where needed, thus simplifying board layout.

Package Information

PART NUMBER	PACKAGE ⁽¹⁾	PACKAGE SIZE ⁽²⁾
LMC7101	DBV (SOT-23, 5)	2.9mm × 2.8mm

- (1) For more information, see [Section 10](#).
 (2) The package size (length × width) is a nominal value and includes pins, where applicable.

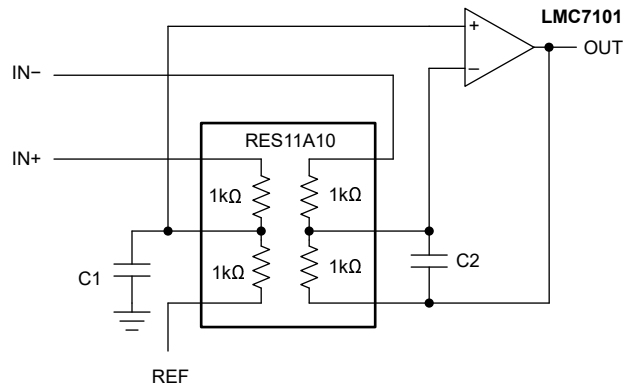

Difference Amplifier Application With RES11A



Table of Contents

1 Features	1	6.2 Functional Block Diagram.....	21
2 Applications	1	6.3 Feature Description.....	21
3 Description	1	6.4 Device Functional Modes.....	22
4 Pin Configuration and Functions	2	7 Application and Implementation	23
5 Specifications	3	7.1 Application Information.....	23
5.1 Absolute Maximum Ratings.....	3	7.2 Typical Application.....	24
5.2 ESD Ratings.....	3	7.3 Power Supply Recommendations.....	26
5.3 Recommended Operating Conditions.....	3	7.4 Layout.....	26
5.4 Thermal Information.....	3	8 Device and Documentation Support	27
5.5 Electrical Characteristics for $V_S = \pm 1.35V$ or $2.7V$	4	8.1 Documentation Support.....	27
5.6 Electrical Characteristics for $V_S = \pm 1.5V$ or $3V$	5	8.2 Receiving Notification of Documentation Updates.....	27
5.7 Electrical Characteristics for $V_S = \pm 2.5V$ or $5V$	6	8.3 Support Resources.....	27
5.8 Electrical Characteristics for $V_S = \pm 7.5V$ or $15V$	8	8.4 Trademarks.....	27
5.9 Typical Characteristics for $V_S = 2.7V$	10	8.5 Electrostatic Discharge Caution.....	27
5.10 Typical Characteristics for $V_S = 3V$	12	8.6 Glossary.....	27
5.11 Typical Characteristics for $V_S = 5V$	13	9 Revision History	27
5.12 Typical Characteristics for $V_S = 15V$	14	10 Mechanical, Packaging, and Orderable Information	28
6 Detailed Description	21		
6.1 Overview.....	21		

4 Pin Configuration and Functions

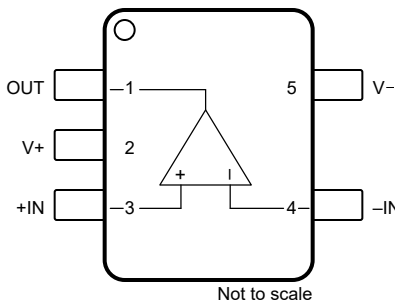

Figure 4-1. DBV Package, 5-Pin SOT-23 (Top View)

Table 4-1. Pin Functions

PIN		TYPE	DESCRIPTION
NO.	NAME		
1	OUT	Output	Output
2	V+	Power	Positive supply
3	+IN	Input	Noninverting input
4	-IN	Input	Inverting input
5	V-	Power	Negative supply

5 Specifications

5.1 Absolute Maximum Ratings

over operating free-air temperature range (unless otherwise noted)⁽¹⁾ ⁽²⁾

		MIN	MAX	UNIT
	Difference Input voltage		±Supply voltage	V
	Voltage at input and output pins	(V-) – 0.3	(V+) + 0.3	V
V _S	Supply voltage, V _S = (V+) – (V-)		16	V
	Current at input pin	-5	5	mA
	Current at output pin ⁽³⁾	-35	35	mA
	Current at power supply pin		35	mA
	Lead temperature (soldering, 10s)		260	°C
T _J	Junction temperature ⁽⁴⁾		150	°C
T _{stg}	Storage temperature	-65	150	°C

- (1) Operation outside the *Absolute Maximum Ratings* may cause permanent device damage. *Absolute Maximum Ratings* do not imply functional operation of the device at these or any other conditions beyond those listed under *Recommended Operating Conditions*. If used outside the *Recommended Operating Conditions* but within the *Absolute Maximum Ratings*, the device may not be fully functional, and this may affect device reliability, functionality, performance, and shorten the device lifetime.
- (2) If Military/Aerospace specified devices are required, contact the TI Sales Office or Distributors for availability and specifications.
- (3) Applies to both single-supply and split-supply operation. Continuous short operation at elevated ambient temperature can result in exceeding the maximum allowed junction temperature at 150°C
- (4) The maximum power dissipation is a function of T_{J(MAX)}, R_{θJA} and T_A. The maximum allowable power dissipation at any ambient temperature is P_D = (T_{J(MAX)} – T_A) / R_{θJA}. All numbers apply for packages soldered directly into a PC board.

5.2 ESD Ratings

			VALUE	UNIT
V _(ESD)	Electrostatic discharge	Human-body model (HBM), per ANSI/ESDA/JEDEC JS-001 ⁽¹⁾	±1000	V
		Charged-device model (CDM), per JEDEC specification JESD22-C101 ⁽²⁾	±1000	

- (1) JEDEC document JEP155 states that 500V HBM allows safe manufacturing with a standard ESD control process.
- (2) JEDEC document JEP157 states that 250V CDM allows safe manufacturing with a standard ESD control process.

5.3 Recommended Operating Conditions

over operating free-air temperature range (unless otherwise noted)

		MIN	NOM	MAX	UNIT
V _S	Supply voltage, V _S = (V+) – (V-)	2.7		15.5	V
T _J	Junction temperature	-40		85	°C

5.4 Thermal Information

THERMAL METRIC ⁽¹⁾		LMC7101	UNIT
		DBV (SOT)	
		5 PINS	
R _{θJA}	Junction-to-ambient thermal resistance	193.5	°C/W
R _{θJC(top)}	Junction-to-case(top) thermal resistance	128.5	°C/W
R _{θJB}	Junction-to-board thermal resistance	88.9	°C/W
ψ _{JT}	Junction-to-top characterization parameter	66.8	°C/W
ψ _{JB}	Junction-to-board characterization parameter	88.6	°C/W
R _{θJC(bot)}	Junction-to-case(bottom) thermal resistance	N/A	°C/W

- (1) For information about traditional and new thermal metrics, see the [Semiconductor and IC Package Thermal Metrics](#) application report.

5.5 Electrical Characteristics for $V_S = \pm 1.35V$ or $2.7V$

 at $T_J = 25^\circ C$, $V_+ = 2.7V$, $V_- = 0V$, $V_{CM} = V_{OUT} = V_+ / 2$, and $R_L > 1M\Omega$ connected to $V_+ / 2$ (unless otherwise noted)

PARAMETER		TEST CONDITIONS		MIN	TYP	MAX	UNIT
OFFSET VOLTAGE							
V_{OS}	Input offset voltage	LMC7101A			± 0.11	± 6	mV
		LMC7101B			± 0.11	± 9	
dV_{OS}/dT	Input offset voltage drift	$T_J = -40^\circ C$ to $+85^\circ C$			1		$\mu V/^\circ C$
PSRR	Power-supply rejection ratio	$V_+ = 1.35V$ to $1.65V$, $V_- = -1.35V$ to $-1.65V$, $V_{CM} = 0V$		45	60		dB
INPUT BIAS CURRENT							
I_B	Input bias current	$T_J = -40^\circ C$ to $+85^\circ C$			± 1	± 64	pA
I_{OS}	Input offset current	$T_J = -40^\circ C$ to $+85^\circ C$			± 0.5	± 32	pA
INPUT VOLTAGE							
V_{CM}	Input common-mode voltage	For CMRR ≥ 47 dB	Positive	2.7	3		V
			Negative		0	0	
CMRR	Common-mode rejection	$0V \leq V_{CM} \leq 2.7V$		47	70		dB
INPUT IMPEDANCE							
R_{IN}	Input resistance				> 1		$T\Omega$
C_{IN}	Common-mode input capacitance				3		pF
FREQUENCY RESPONSE							
GBW	Gain bandwidth product				0.6		MHz
SR	Slew rate ⁽¹⁾	$(V_+) = 15V$, 10V step, $R_L = 100k\Omega$ to $7.5V$, $V_{OUT} = 10V_{PP}$, $f = 1kHz$			0.7		V/ μs
OUTPUT							
V_O	Voltage output swing	Positive rail	$R_L = 2k\Omega$	2.15	2.45		V
			$R_L = 10k\Omega$	2.64	2.68		
		Negative rail	$R_L = 2k\Omega$		0.25	0.5	
			$R_L = 10k\Omega$		0.025	0.06	
POWER SUPPLY							
I_Q	Quiescent current per amplifier				500	810	μA
		$T_J = -40^\circ C$ to $+85^\circ C$			500	950	

(1) Number specified is the slower of the positive and negative slew rates.

5.6 Electrical Characteristics for $V_S = \pm 1.5V$ or $3V$

at $T_J = 25^\circ\text{C}$, $V_+ = 3V$, $V_- = 0V$, $V_{CM} = V_{OUT} = V_+ / 2$, and $R_L = 1M\Omega$ connected to $V_+ / 2$ (unless otherwise noted)

PARAMETER		TEST CONDITIONS		MIN	TYP	MAX	UNIT
OFFSET VOLTAGE							
V_{OS}	Input offset voltage	LMC7101A			± 0.11	± 3	mV
		LMC7101B			± 0.11	± 7	
dV_{OS}/dT	Input offset voltage drift	$T_J = -40^\circ\text{C}$ to $+85^\circ\text{C}$			1		$\mu\text{V}/^\circ\text{C}$
PSRR	Power-supply rejection ratio	$V_+ = 1.5V$ to $7.5V$ $V_- = -1.5V$ to $-7.5V$ $V_{OUT} = V_{CM} = 0V$	LMC7101A	68	80		dB
			LMC7101B	60	80		
INPUT BIAS CURRENT							
I_B	Input bias current	$T_J = -40^\circ\text{C}$ to $+85^\circ\text{C}$			± 1	± 64	pA
I_{OS}	Input offset current	$T_J = -40^\circ\text{C}$ to $+85^\circ\text{C}$			± 0.5	± 32	pA
INPUT VOLTAGE							
V_{CM}	Input common-mode voltage	For $CMRR \geq 47\text{dB}$	Positive	3	3.3		V
			Negative		0	0	
CMRR	Common-mode rejection	$0V \leq V_{CM} \leq 3V$		47	70		dB
INPUT IMPEDANCE							
R_{IN}	Input resistance				> 1		$T\Omega$
C_{IN}	Common-mode input capacitance				3		pF
OUTPUT							
V_O	Voltage output swing	Positive rail	$R_L = 2k\Omega$	2.6	2.8		V
			$R_L = 600\Omega$	2.5	2.7		
		Negative rail	$R_L = 2k\Omega$		0.2	0.4	
			$R_L = 600\Omega$		0.37	0.6	
POWER SUPPLY							
I_Q	Quiescent current per amplifier				500	810	μA
		$T_J = -40^\circ\text{C}$ to $+85^\circ\text{C}$			500	950	

5.7 Electrical Characteristics for $V_S = \pm 2.5V$ or $5V$

at $T_J = 25^\circ C$, $V_+ = 5V$, $V_- = 0V$, $V_{CM} = V_{OUT} = V_+ / 2$, and $R_L = 1M\Omega$ connected to $V_+ / 2$ (unless otherwise noted)

PARAMETER		TEST CONDITIONS		MIN	TYP	MAX	UNIT
OFFSET VOLTAGE							
V_{OS}	Input offset voltage	LMC7101A			± 0.11	± 3	mV
			$T_J = -40^\circ C$ to $+85^\circ C$		± 0.11	± 5	
		LMC7101B			± 0.11	± 7	
			$T_J = -40^\circ C$ to $+85^\circ C$		± 0.11	± 9	
dV_{OS}/dT	Input offset voltage drift	$T_J = -40^\circ C$ to $+85^\circ C$			1		$\mu V/^\circ C$
PSRR	Power-supply rejection ratio	Positive $V_+ = 5V$ to $15V$ $V_- = 0V$, $V_{OUT} = 1.5V$	LMC7101A	70	82	dB	
			LMC7101B	65	82		
			LMC7101A $T_J = -40^\circ C$ to $+85^\circ C$	65	82		
			LMC7101B $T_J = -40^\circ C$ to $+85^\circ C$	62	82		
		Negative $V_+ = -5V$ to $-15V$ $V_- = 0V$, $V_{OUT} = -1.5V$	LMC7101A	70	82		
			LMC7101B	65	82		
			LMC7101A $T_J = -40^\circ C$ to $+85^\circ C$	65	82		
			LMC7101B $T_J = -40^\circ C$ to $+85^\circ C$	62	82		
INPUT BIAS CURRENT							
I_B	Input bias current				± 1		pA
		$T_J = -40^\circ C$ to $+85^\circ C$				± 64	
I_{OS}	Input offset current				± 0.5		pA
		$T_J = -40^\circ C$ to $+85^\circ C$				± 32	
NOISE							
THD	Total harmonic distortion	$f = 10kHz$, $G = -2V/V$, $R_L = 10k\Omega$, $V_{OUT} = 4V_{pp}$			0.01		%
INPUT VOLTAGE							
V_{CM}	Input common-mode voltage	To positive rail CMRR > 50dB		5.2	5.3	V	
			$T_J = -40^\circ C$ to $+85^\circ C$	5	5.3		
		To negative rail CMRR > 50dB		-0.3	-0.2		
			$T_J = -40^\circ C$ to $+85^\circ C$	-0.3	0		
CMRR	Common-mode rejection ratio	$0V \leq V_{CM} \leq 5V$		52	75	dB	
			$T_J = -40^\circ C$ to $+85^\circ C$	51	74		
INPUT IMPEDANCE							
R_{IN}	Input resistance				> 1		$T\Omega$
C_{IN}	Input capacitance				3		pF
FREQUENCY RESPONSE							
GBW	Gain bandwidth product				1		MHz
SR	Slew rate				1		$V/\mu s$

5.7 Electrical Characteristics for $V_S = \pm 2.5V$ or $5V$ (continued)

at $T_J = 25^\circ\text{C}$, $V_+ = 5V$, $V_- = 0V$, $V_{CM} = V_{OUT} = V_+ / 2$, and $R_L = 1M\Omega$ connected to $V_+ / 2$ (unless otherwise noted)

PARAMETER		TEST CONDITIONS		MIN	TYP	MAX	UNIT	
OUTPUT								
V_O	Voltage output swing	Positive rail $R_L = 2k\Omega$		4.7	4.9		V	
			$T_J = -40^\circ\text{C to } +85^\circ\text{C}$	4.6	4.9			
		Negative rail $R_L = 2k\Omega$			0.1	0.18		
			$T_J = -40^\circ\text{C to } +85^\circ\text{C}$		0.1	0.24		
Positive rail $R_L = 600\Omega$		4.5	4.7					
	$T_J = -40^\circ\text{C to } +85^\circ\text{C}$	4.24	4.7					
Negative rail $R_L = 600\Omega$			0.3	0.5				
	$T_J = -40^\circ\text{C to } +85^\circ\text{C}$		0.3	0.65				
I_{SC}	Short-circuit current	Sourcing $V_{OUT} = 0V$		16	24		mA	
			$T_J = -40^\circ\text{C to } +85^\circ\text{C}$	11	24			
		Sinking $V_{OUT} = 5V$		11	19			
			$T_J = -40^\circ\text{C to } +85^\circ\text{C}$	7.5	19			
POWER SUPPLY								
I_Q	Quiescent current per amplifier			0.5	0.85		mA	
		$T_J = -40^\circ\text{C to } +85^\circ\text{C}$		0.5	1			

5.8 Electrical Characteristics for $V_S = \pm 7.5V$ or $15V$

at $T_J = 25^\circ C$, $V_+ = 15V$, $V_- = 0V$, $V_{CM} = V_{OUT} = V_+ / 2$, and $R_L = 1M\Omega$ connected to $V_+ / 2$ (unless otherwise noted)

PARAMETER		TEST CONDITIONS		MIN	TYP	MAX	UNIT
OFFSET VOLTAGE							
V_{OS}	Input offset voltage				± 0.26		mV
dV_{OS}/dT	Input offset voltage drift	$T_J = -40^\circ C$ to $+85^\circ C$			1		$\mu V/^\circ C$
PSRR	Power-supply rejection ratio	Positive $V_+ = 5V$ to $15V$ $V_- = 0V$, $V_{OUT} = 1.5V$	LMC7101A	70	82	dB	
			LMC7101B	65	82		
			LMC7101A $T_J = -40^\circ C$ to $+85^\circ C$	65	82		
			LMC7101B $T_J = -40^\circ C$ to $+85^\circ C$	60	82		
		Negative $V_+ = -5V$ to $-15V$ $V_- = 0V$, $V_{OUT} = -1.5V$	LMC7101A	70	82		
			LMC7101B	65	82		
			LMC7101A $T_J = -40^\circ C$ to $+85^\circ C$	65	82		
			LMC7101B $T_J = -40^\circ C$ to $+85^\circ C$	62	82		
INPUT BIAS CURRENT							
I_B	Input bias current				± 1		pA
		$T_J = -40^\circ C$ to $+85^\circ C$				± 64	
I_{OS}	Input offset current				± 0.5		pA
		$T_J = -40^\circ C$ to $+85^\circ C$				± 32	
NOISE							
e_n	Input voltage noise density	$f = 1kHz$, $V_{CM} = 1V$			37		nV/\sqrt{Hz}
i_n	Input current noise density	$f = 1kHz$			6.8		fA/\sqrt{Hz}
THD	Total harmonic distortion	$f = 10kHz$, $G = -2V/V$, $R_L = 10k\Omega$, $V_{OUT} = 8.5V_{pp}$			0.01		%
INPUT VOLTAGE							
V_{CM}	Input common-mode voltage	To positive rail CMRR > 50dB		15.2	15.3	V	
			$T_J = -40^\circ C$ to $+85^\circ C$		15		15.3
		To negative rail CMRR > 50dB		-0.3	-0.2		
			$T_J = -40^\circ C$ to $+85^\circ C$		-0.3		0
CMRR	Common-mode rejection ratio	$0V \leq V_{CM} \leq 15V$		62	82	dB	
		$T_J = -40^\circ C$ to $+85^\circ C$		60	82		
INPUT IMPEDANCE							
R_{IN}	Input resistance				> 1		$T\Omega$
C_{IN}	Input capacitance				3		pF
OPEN-LOOP GAIN							
A_{OL}	Open-loop voltage gain	Sourcing $7.5V < V_O < 12.5V$, $V_{CM} = 1.5V$ $R_L = 2k\Omega$ to $7.5V$		80	340	V/mV	
			$T_J = -40^\circ C$ to $+85^\circ C$		40		340
		Sinking $2.5V < V_O < 7.5V$, $V_{CM} = 1.5V$ $R_L = 2k\Omega$ to $7.5V$		15	24		
			$T_J = -40^\circ C$ to $+85^\circ C$		10		24
		Sourcing, $V_{CM} = 1.5V$, $7.5V < V_O < 12.5V$, $R_L = 600\Omega$			34		300
		Sinking, $V_{CM} = 1.5V$, $2.5V < V_O < 7.5V$, $R_L = 600\Omega$			6		15

5.8 Electrical Characteristics for $V_S = \pm 7.5V$ or $15V$ (continued)

at $T_J = 25^\circ C$, $V_+ = 15V$, $V_- = 0V$, $V_{CM} = V_{OUT} = V_+ / 2$, and $R_L = 1M\Omega$ connected to $V_+ / 2$ (unless otherwise noted)

PARAMETER		TEST CONDITIONS		MIN	TYP	MAX	UNIT	
FREQUENCY RESPONSE								
GBW	Gain bandwidth product				1.1		MHz	
SR	Slew rate ⁽¹⁾	$V_S = 15V$, 10V step, $R_L = 100k\Omega$ to $7.5V$ $V_{OUT} = 10V_{PP}$, $f = 1kHz$		0.5	1.1		V/ μs	
			$T_J = -40^\circ C$ to $+85^\circ C$	0.4	1.1			
θ_m	Phase margin				45		°	
G_m	Gain margin				10		dB	
OUTPUT								
V_O	Voltage output swing	Positive rail $R_L = 2k\Omega$		14.4	14.7		V	
			$T_J = -40^\circ C$ to $+85^\circ C$	14.2	14.7			
		Negative rail $R_L = 2k\Omega$			0.16	0.32		
			$T_J = -40^\circ C$ to $+85^\circ C$		0.16	0.45		
		Positive rail $R_L = 600\Omega$		13.4	14.1			
			$T_J = -40^\circ C$ to $+85^\circ C$	13	14.1			
		Negative rail $R_L = 600\Omega$			0.5	1		
			$T_J = -40^\circ C$ to $+85^\circ C$		0.5	1.3		
I_{SC}	Short-circuit current ⁽²⁾	Sourcing $V_{OUT} = 0V$		30	50		mA	
			$T_J = -40^\circ C$ to $+85^\circ C$	20	50			
		Sinking $V_{OUT} = 12V$		30	50			
			$T_J = -40^\circ C$ to $+85^\circ C$	20	50			
POWER SUPPLY								
I_Q	Quiescent current per amplifier			0.8	1.5		mA	
		$T_J = -40^\circ C$ to $+85^\circ C$		0.8	1.71			

(1) Number specified is the slower of the positive and negative slew rates.

(2) Do not short circuit output to V_+ when V_+ is greater than 12V or reliability can be adversely affected.

5.9 Typical Characteristics for $V_S = 2.7V$

at $V_+ = 2.7V$, $V_- = 0V$, and $T_A = 25^\circ C$ (unless otherwise specified)

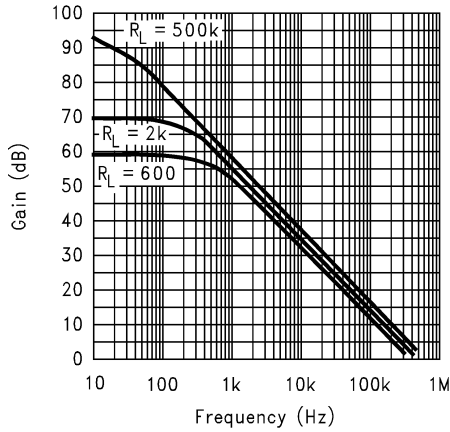

Figure 5-1. Open-Loop Frequency Response

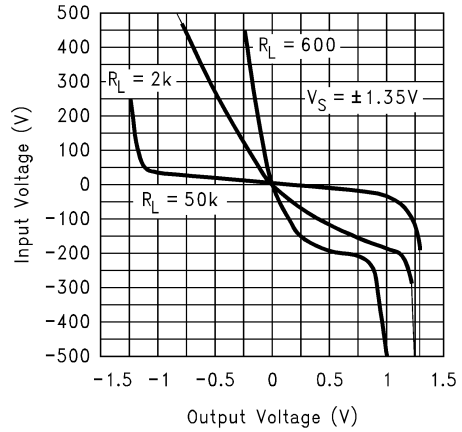

Figure 5-2. Input Voltage vs Output Voltage

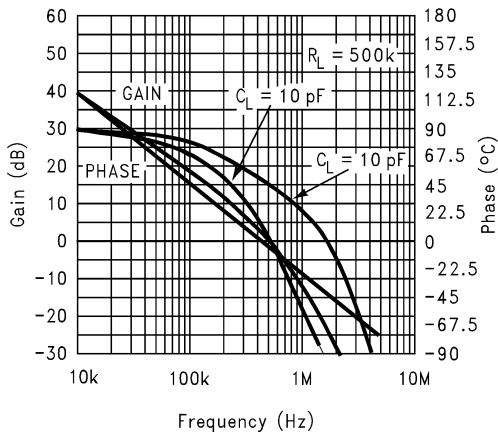

Figure 5-3. Gain and Phase vs Capacitance Load

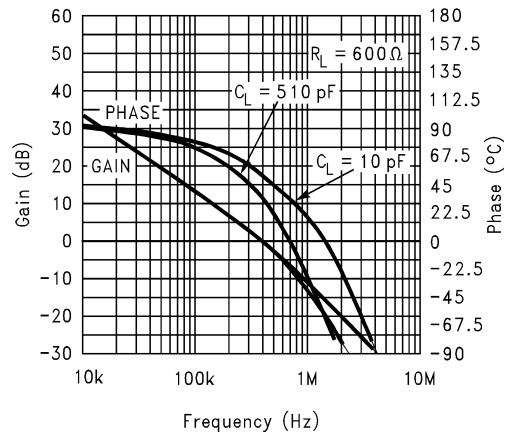

Figure 5-4. Gain and Phase vs Capacitance Load

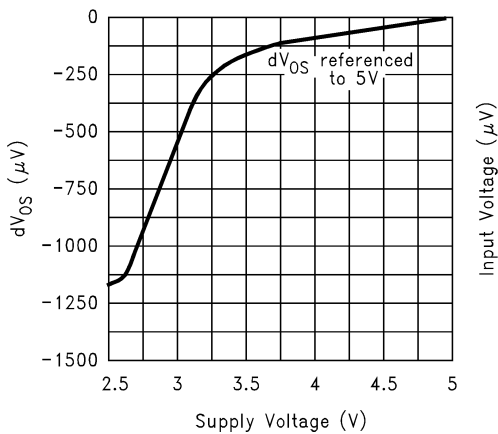

Figure 5-5. dV_{OS} vs Supply Voltage

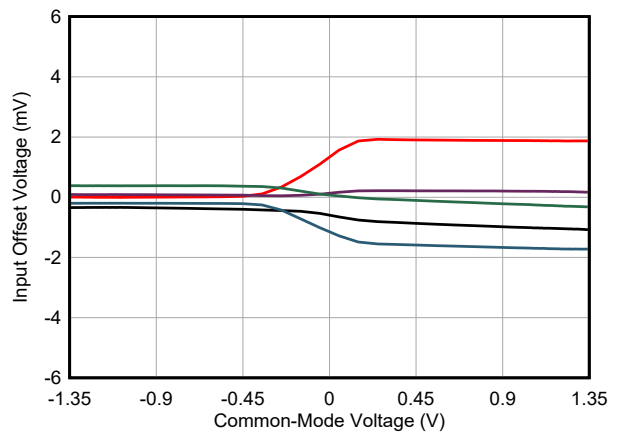

Figure 5-6. Input Offset Voltage vs Common-Mode Voltage

5.9 Typical Characteristics for $V_S = 2.7V$ (continued)

at $V_+ = 2.7V$, $V_- = 0V$, and $T_A = 25^\circ C$ (unless otherwise specified)

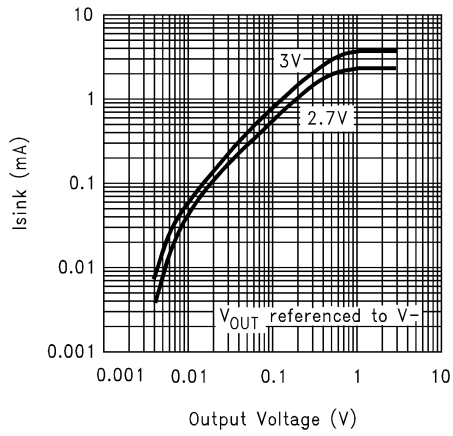

Figure 5-7. Sinking Current vs Output Voltage

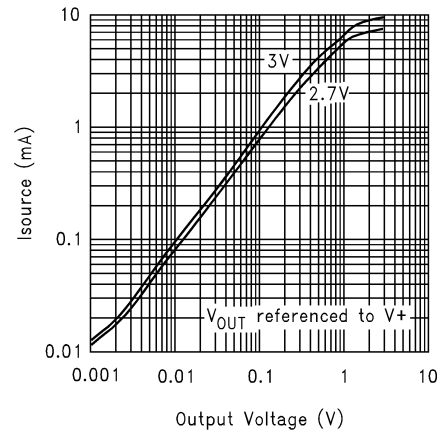

Figure 5-8. Sourcing Current vs Output Voltage

5.10 Typical Characteristics for $V_S = 3V$

at $V_+ = 3V$, $V_- = 0V$, and $T_A = 25^\circ C$ (unless otherwise specified)

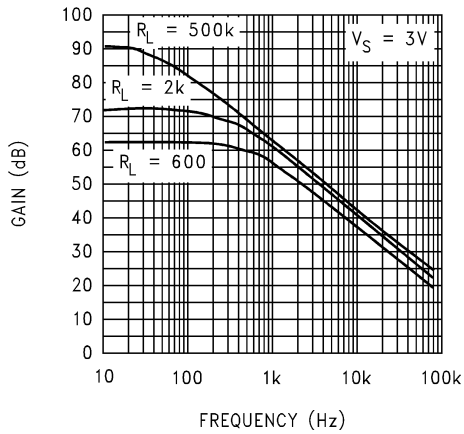

Figure 5-9. Open-Loop Frequency Response

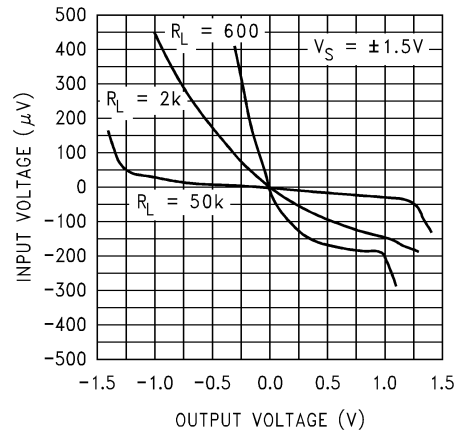

Figure 5-10. Input Voltage vs Output Voltage

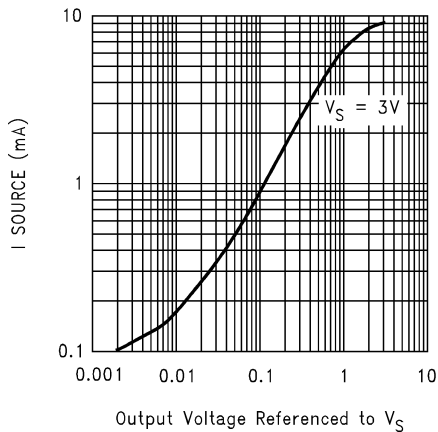

Figure 5-11. Sourcing Current vs Output Voltage

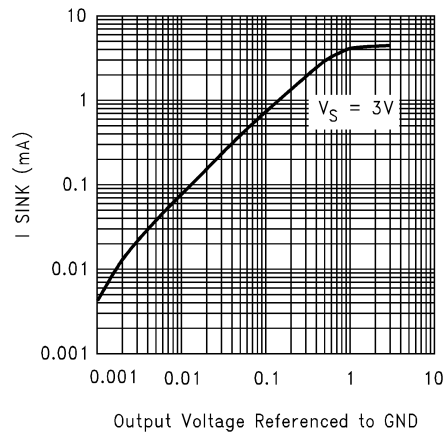

Figure 5-12. Sinking Current vs Output Voltage

5.11 Typical Characteristics for $V_S = 5V$

at $V_+ = 5V$, $V_- = 0V$, and $T_A = 25^\circ C$ (unless otherwise specified)

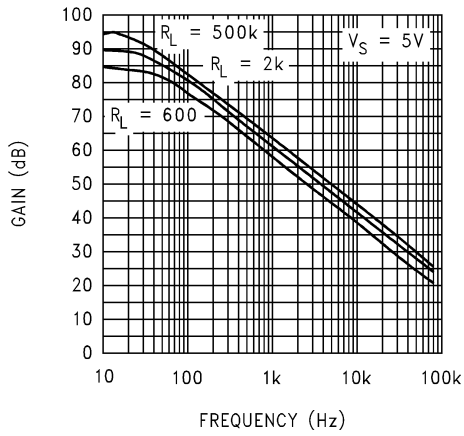

Figure 5-13. Open-Loop Frequency Response

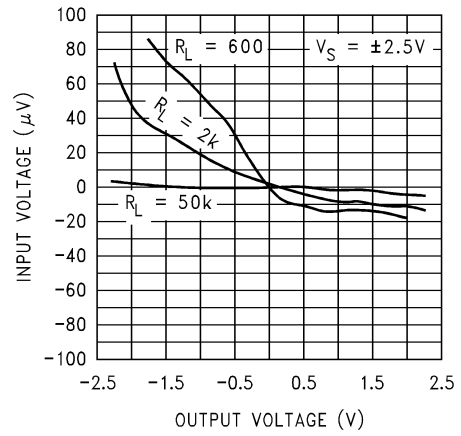

Figure 5-14. Input Voltage vs Output Voltage

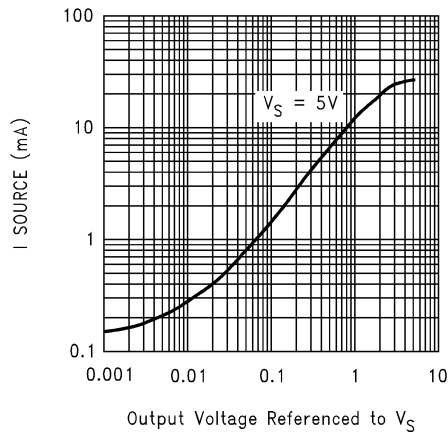

Figure 5-15. Sourcing Current vs Output Voltage

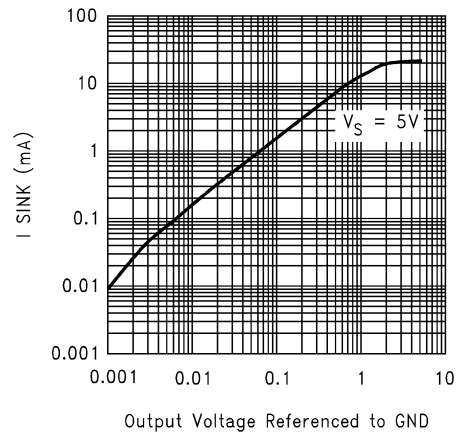

Figure 5-16. Sinking Current vs Output Voltage

5.12 Typical Characteristics for $V_S = 15V$

at $V_+ = 15V$, $V_- = 0V$, and $T_A = 25^\circ C$ (unless otherwise specified)

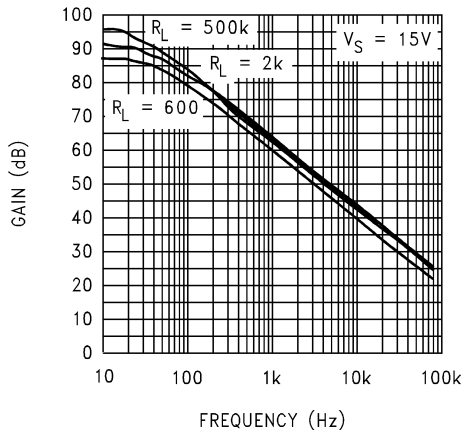

Figure 5-17. Open-Loop Frequency Response

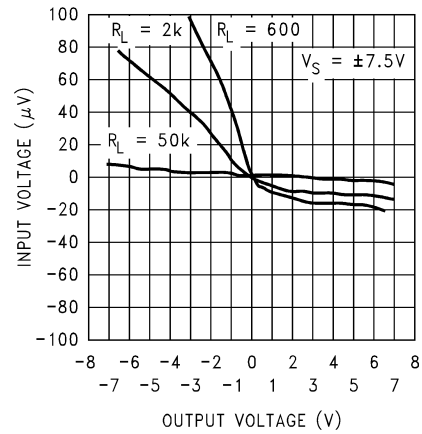

Figure 5-18. Input Voltage vs Output Voltage

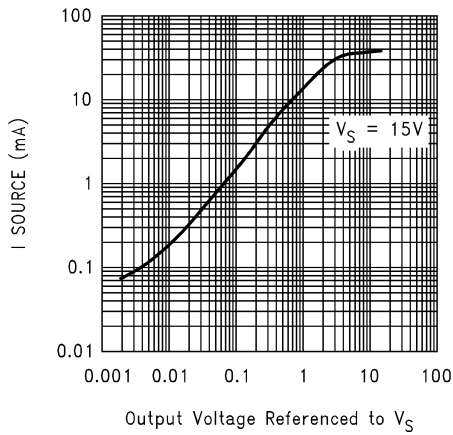

Figure 5-19. Sourcing Current vs Output Voltage

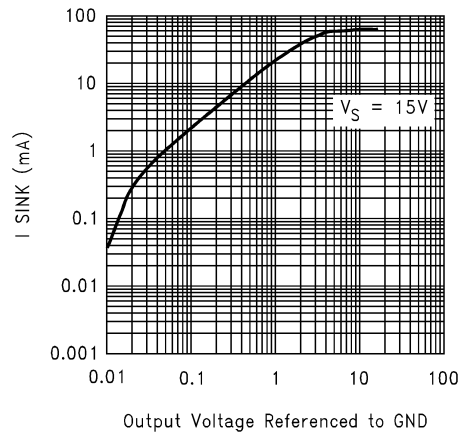

Figure 5-20. Sinking Current vs Output Voltage

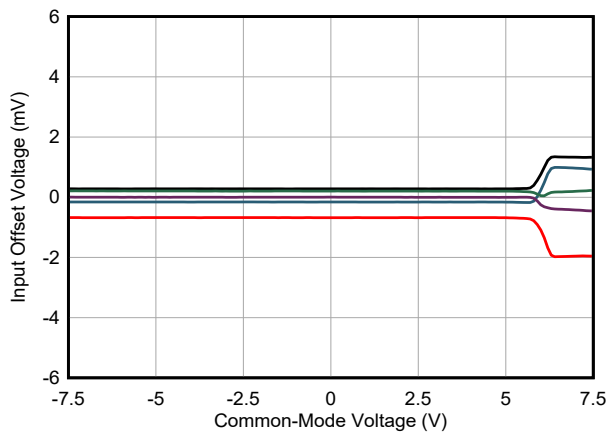

Figure 5-21. Input Offset Voltage vs Common-Mode Voltage

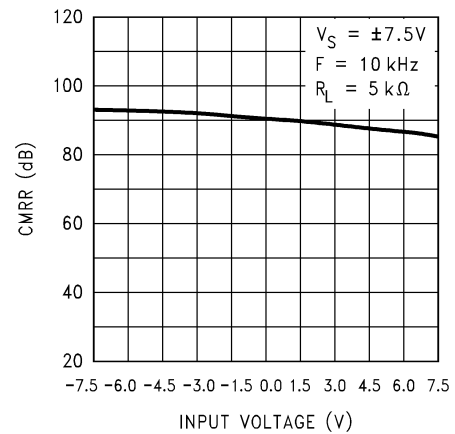

Figure 5-22. CMRR vs Input Voltage

5.12 Typical Characteristics for $V_S = 15V$ (continued)

at $V_+ = 15V$, $V_- = 0V$, and $T_A = 25^\circ C$ (unless otherwise specified)

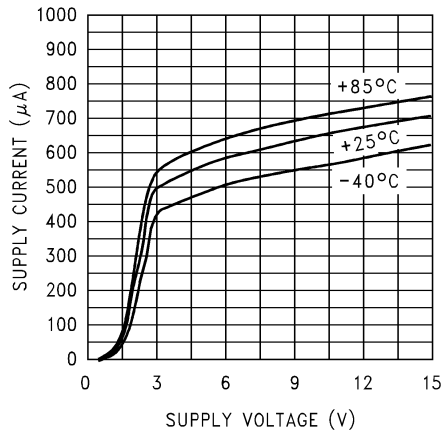

Figure 5-23. Supply Current vs Supply Voltage

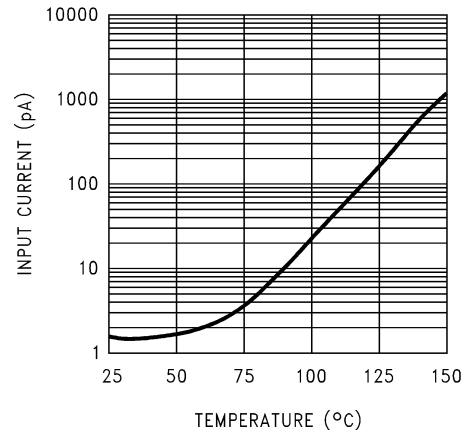

Figure 5-24. Input Current vs Temperature

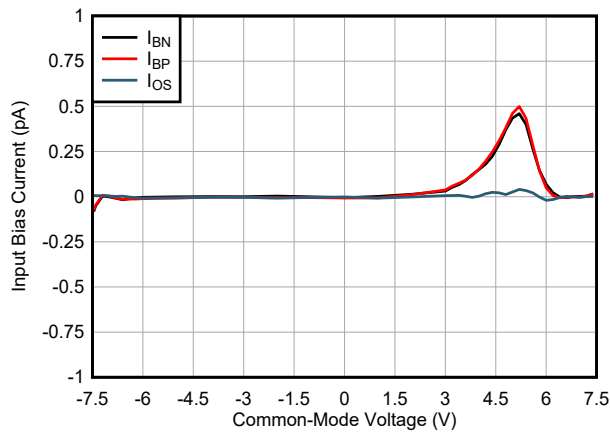

Figure 5-25. Input Bias Current vs Common-Mode Voltage

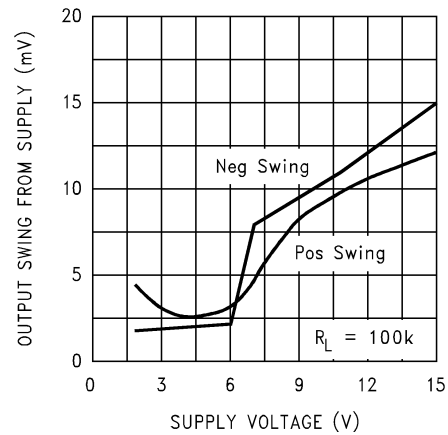

Figure 5-26. Output Voltage Swing vs Supply Voltage

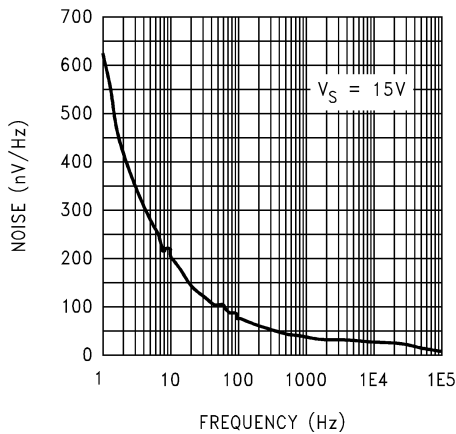

Figure 5-27. Input Voltage Noise vs Frequency

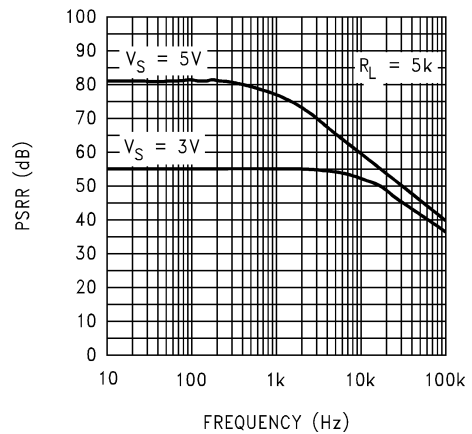

Figure 5-28. Positive PSRR vs Frequency

5.12 Typical Characteristics for $V_S = 15V$ (continued)

at $V_+ = 15V$, $V_- = 0V$, and $T_A = 25^\circ C$ (unless otherwise specified)

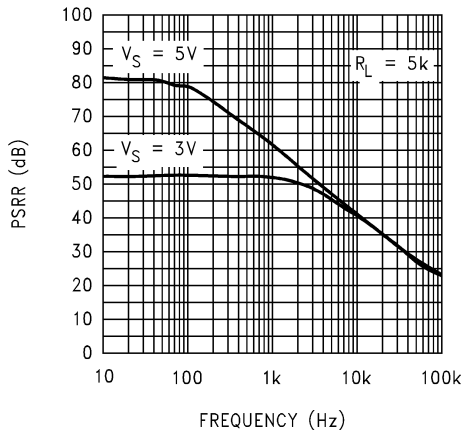

Figure 5-29. Negative PSRR vs Frequency

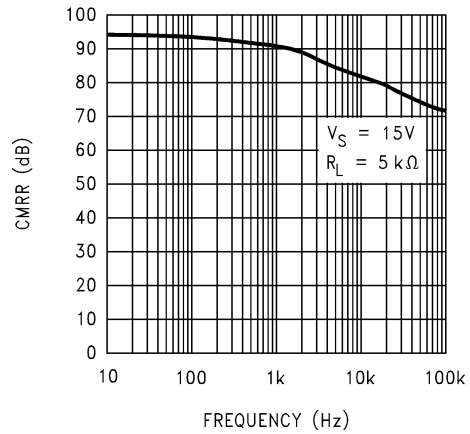

Figure 5-30. CMRR vs Frequency

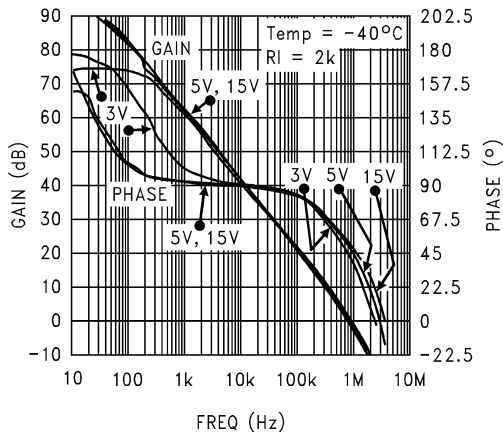

Figure 5-31. Open-Loop Frequency Response at $-40^\circ C$

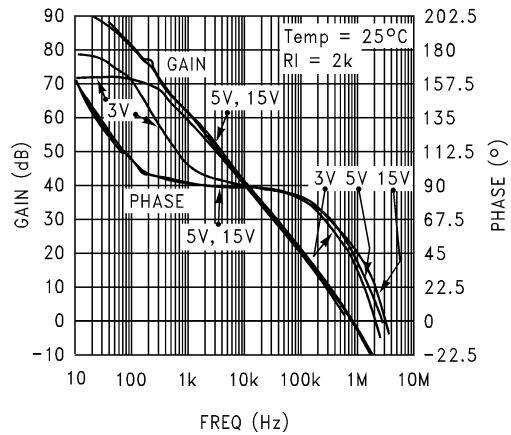

Figure 5-32. Open-Loop Frequency Response at $25^\circ C$

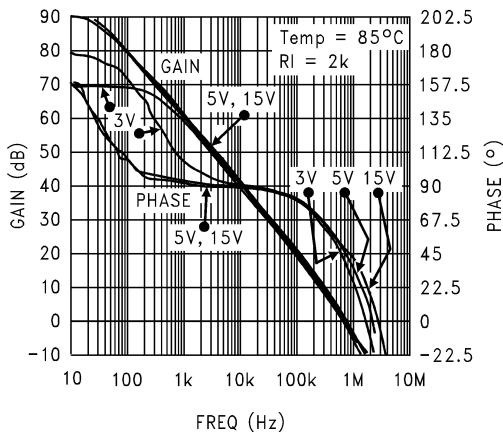

Figure 5-33. Open-Loop Frequency Response at $85^\circ C$

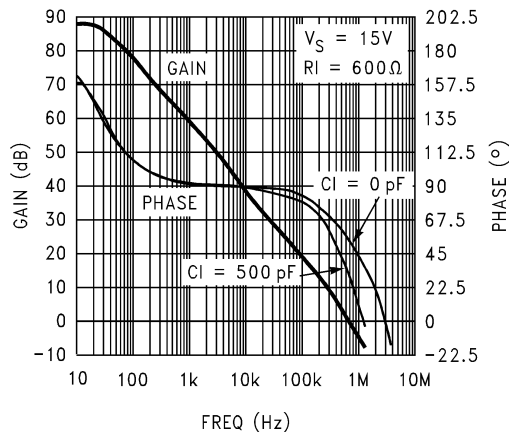

Figure 5-34. Gain and Phase vs Capacitive Load

5.12 Typical Characteristics for $V_S = 15V$ (continued)

at $V_+ = 15V$, $V_- = 0V$, and $T_A = 25^\circ C$ (unless otherwise specified)

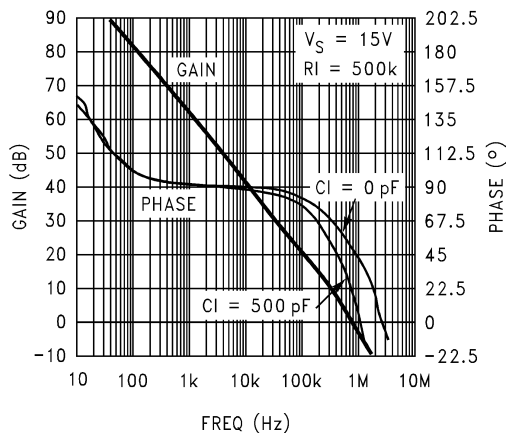

Figure 5-35. Gain and Phase vs Capacitive Load

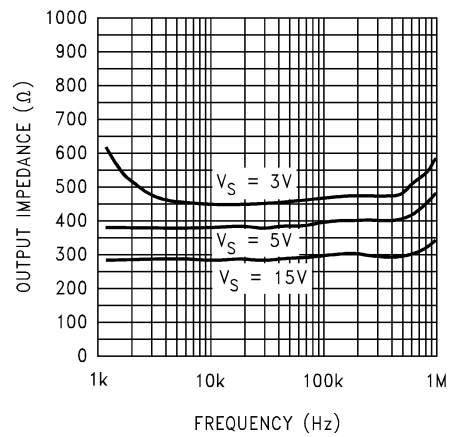

Figure 5-36. Output Impedance vs Frequency

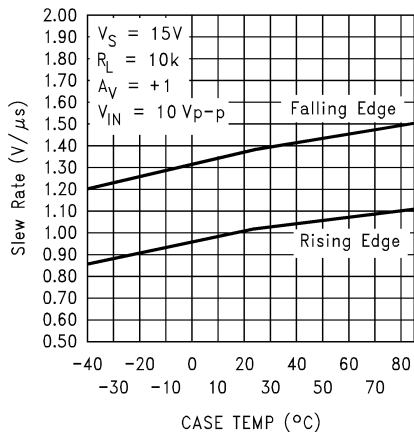

Figure 5-37. Slew Rate vs Temperature

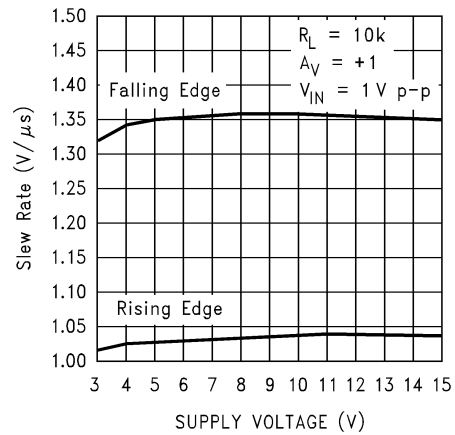

Figure 5-38. Slew Rate vs Supply Voltage

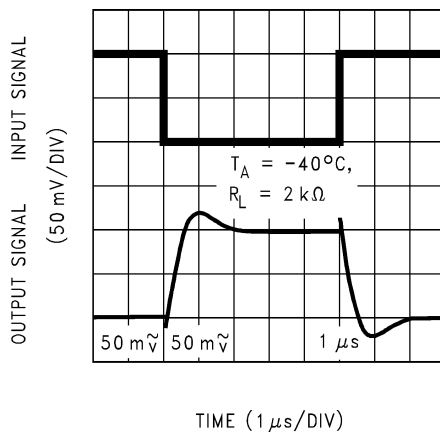

Figure 5-39. Inverting Small-Signal Pulse Response

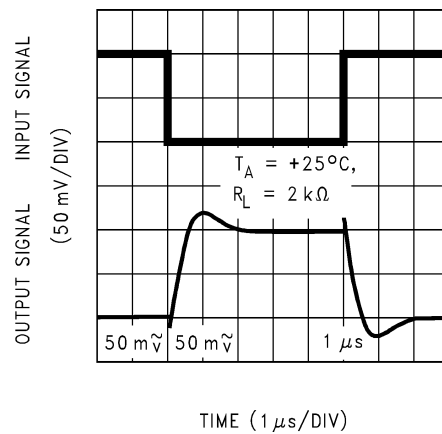

Figure 5-40. Inverting Small-Signal Pulse Response

5.12 Typical Characteristics for $V_S = 15V$ (continued)

at $V_+ = 15V$, $V_- = 0V$, and $T_A = 25^\circ C$ (unless otherwise specified)

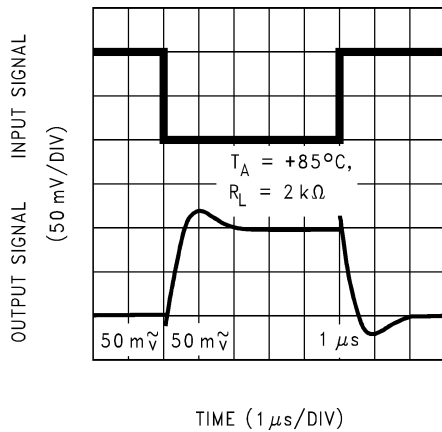

Figure 5-41. Inverting Small-Signal Pulse Response

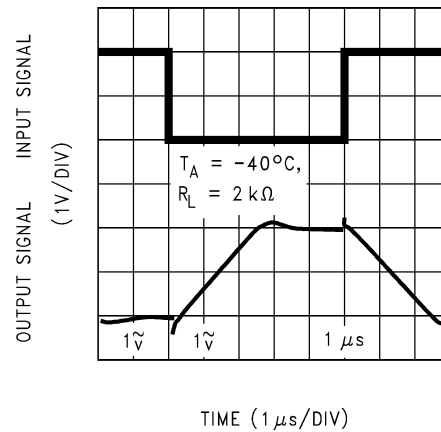

Figure 5-42. Inverting Large-Signal Pulse Response

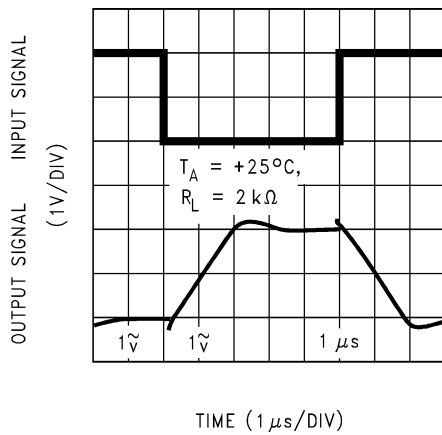

Figure 5-43. Inverting Large-Signal Pulse Response

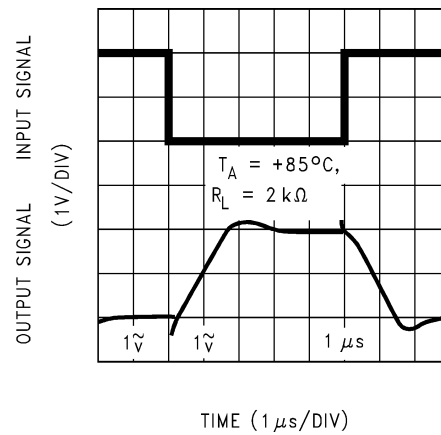

Figure 5-44. Inverting Large-Signal Pulse Response

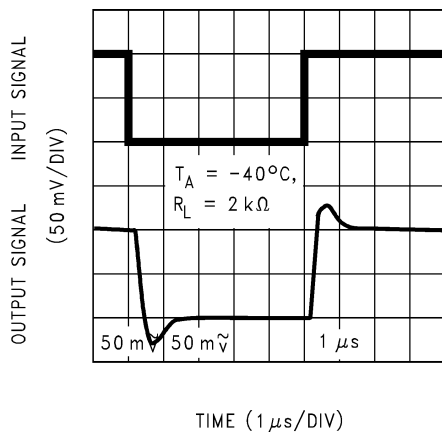

Figure 5-45. Noninverting Small-Signal Pulse Response

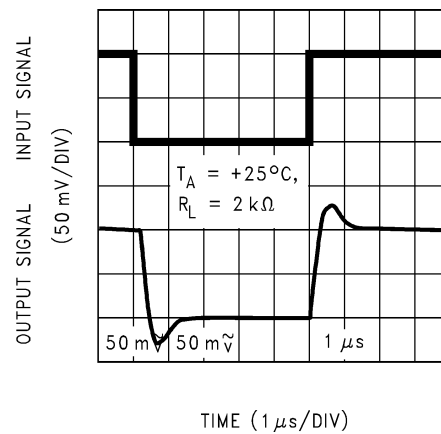

Figure 5-46. Noninverting Small-Signal Pulse Response

5.12 Typical Characteristics for $V_S = 15V$ (continued)

at $V_+ = 15V$, $V_- = 0V$, and $T_A = 25^\circ C$ (unless otherwise specified)

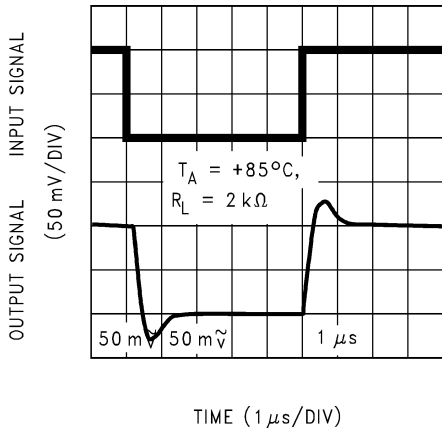

Figure 5-47. Noninverting Small-Signal Pulse Response

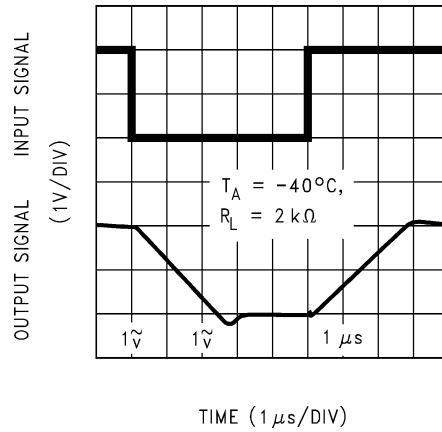

Figure 5-48. Noninverting Large-Signal Pulse Response

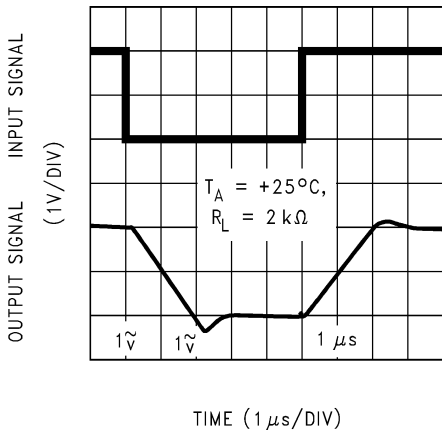

Figure 5-49. Noninverting Large-Signal Pulse Response

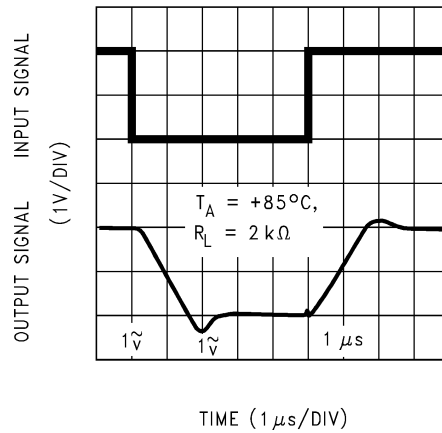

Figure 5-50. Noninverting Large-Signal Pulse Response

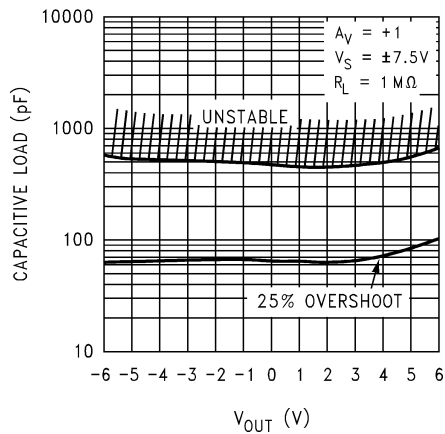

Figure 5-51. Stability vs Capacitive Load

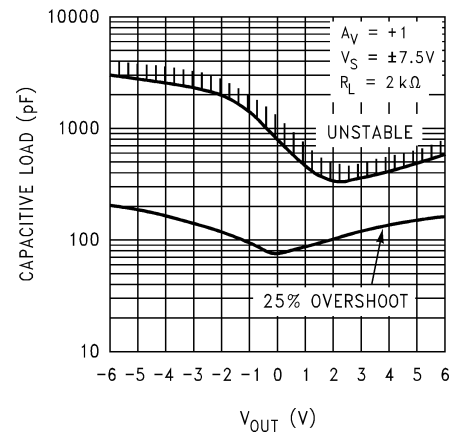

Figure 5-52. Stability vs Capacitive Load

5.12 Typical Characteristics for $V_S = 15V$ (continued)

at $V_+ = 15V$, $V_- = 0V$, and $T_A = 25^\circ C$ (unless otherwise specified)

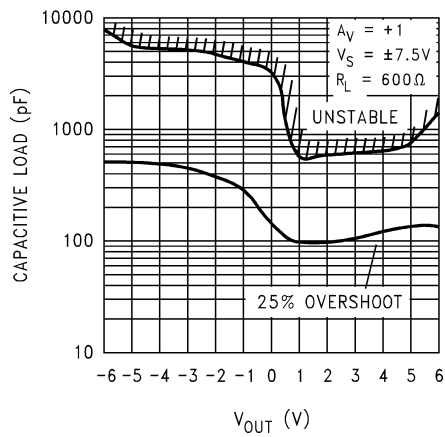

Figure 5-53. Stability vs Capacitive Load

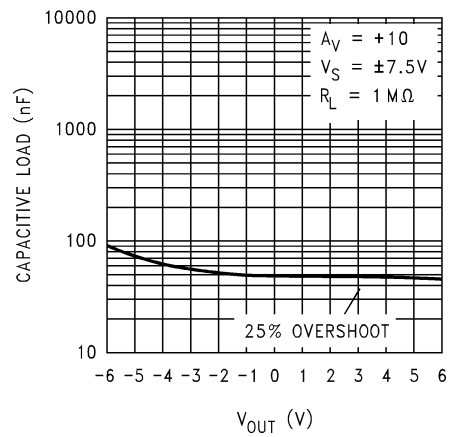

Figure 5-54. Stability vs Capacitive Load

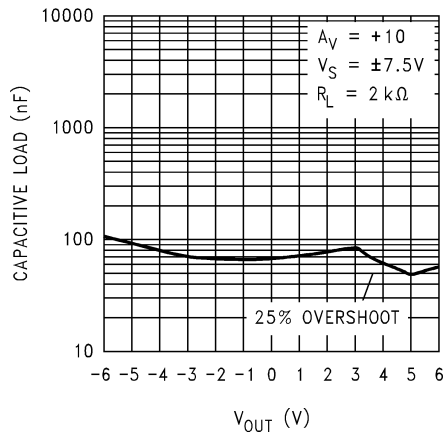

Figure 5-55. Stability vs Capacitive Load

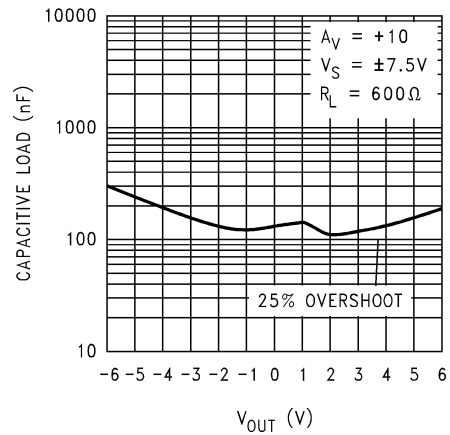

Figure 5-56. Stability vs Capacitive Load

6 Detailed Description

6.1 Overview

The LMC7101 is a single-channel, low-power operational amplifier available in a space-saving SOT-23 package, offering rail-to-rail input and output operation across a wide range of power-supply configurations.

The LMC7101 is also available in an automotive-grade variant, see LMC7101Q-Q1.

6.2 Functional Block Diagram

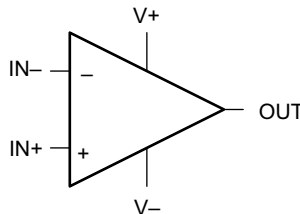

6.3 Feature Description

6.3.1 Benefits of the LMC7101 Tiny Amplifier

6.3.1.1 Size

The small footprint of the SOT-23-5 packaged tiny amplifier, (0.12in × 0.118in, 3.05mm × 3mm) saves space on printed circuit boards, and enable the design of smaller electronic products. Many customers prefer smaller and lighter products because the designs can contribute to overall weight reduction in portable electronics.

6.3.1.2 Height

The 0.056 inches (1.43mm) height of the tiny LMC7101 amplifier makes the device an excellent choice for use in a wide range of circuit boards in which a thin profile is required.

6.3.1.3 Signal Integrity

Signals can pick up noise between the signal source and the amplifier. By using a physically smaller amplifier package, the tiny amplifier can be placed closer to the signal source, thus reducing noise pickup and increasing signal integrity. The tiny amplifier can also be placed next to the signal destination, such as a buffer, for the reference of an analog-to-digital converter.

6.3.1.4 Simplified Board Layout

The tiny LMC7101 amplifier can simplify board layout in several ways. Avoid long PCB traces by correctly placing amplifiers instead of routing signals to a dual or quad device. By using multiple tiny amplifiers instead of duals or quads, complex signal routing and possibly crosstalk can be reduced.

6.3.1.5 Low THD

The high open-loop gain of the LMC7101 amplifier helps to achieve very low audio distortion—typically 0.01% at 10kHz with a 10kΩ load at 5V supplies. This makes the tiny amplifier an excellent choice for audio and low-frequency signal-processing applications.

6.3.1.6 Low Supply Current

The typical 0.5mA supply current of the LMC7101 can help improve thermal performance on high density circuit boards, and can allow the reduction of the overall board size in some applications.

6.3.1.7 Wide Voltage Range

The LMC7101 is characterized at 15V, 5V and 3V. Performance data is provided at these popular voltages. This wide voltage range makes the LMC7101 a good choice for devices where the supply voltage can vary.

6.4 Device Functional Modes

6.4.1 Input Common Mode

6.4.1.1 Input Common-Mode Voltage Range

The LMC7101 does not exhibit phase inversion when an input voltage exceeds the negative supply voltage. [Figure 6-1](#) shows an input voltage exceeding both supplies with no resulting phase inversion of the output.

The absolute maximum input voltage is 300mV beyond either rail at room temperature. Voltages greatly exceeding this maximum rating, as in [Figure 6-2](#), can cause excessive current to flow in or out of the input pins, thus adversely affecting reliability.

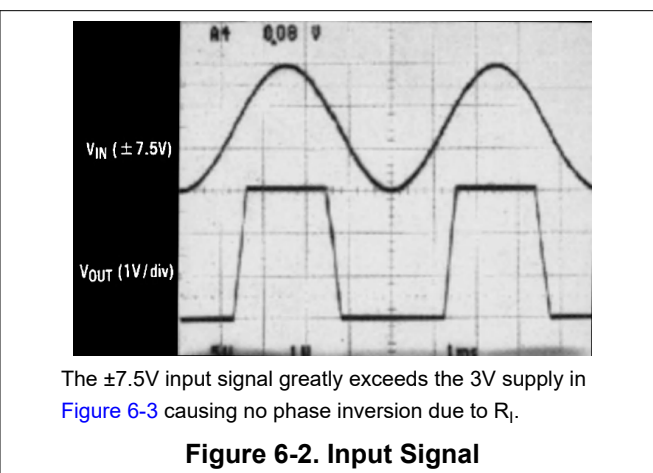
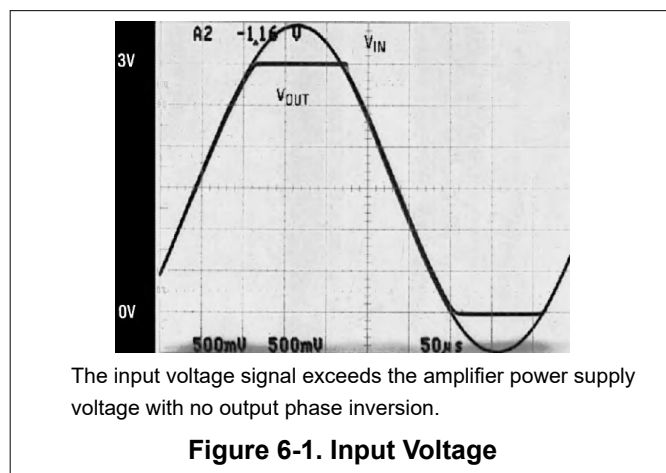

Applications that exceed this rating must externally limit the maximum input current to $\pm 5\text{mA}$ with an input resistor as shown in [Figure 6-3](#).

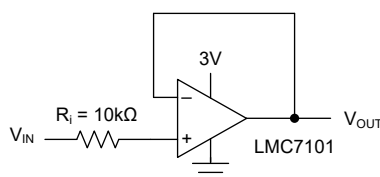

Figure 6-3. R_i Input Current Protection for Voltages Exceeding the Supply Voltage

7 Application and Implementation

Note

Information in the following applications sections is not part of the TI component specification, and TI does not warrant its accuracy or completeness. TI's customers are responsible for determining suitability of components for their purposes, as well as validating and testing their design implementation to confirm system functionality.

7.1 Application Information

7.1.1 Rail-to-Rail Output

The approximate output resistance of the LMC7101 is 180Ω sourcing and 130Ω sinking at $V_S = 3V$ and 110Ω sourcing and 80Ω sinking at $V_S = 5V$. Using the calculated output resistance, maximum output voltage swing can be estimated as a function of load.

7.1.2 Capacitive Load Tolerance

The LMC7101 can typically directly drive a 100pF load with $V_S = 15V$ at unity gain without oscillating. The unity gain follower is the most sensitive configuration. Direct capacitive loading reduces the phase margin of operational amplifiers. The combination of the output impedance and the capacitive load of the operational amplifier induces phase lag, which results in either an underdamped pulse response or oscillation.

Capacitive load compensation can be accomplished using resistive isolation as shown in [Figure 7-1](#). This simple technique is useful for isolating the capacitive input of multiplexers and A/D converters.

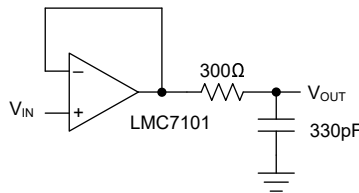

Figure 7-1. Resistive Isolation of a 330pF Capacitive Load

7.1.3 Compensating for Input Capacitance When Using Large Value Feedback Resistors

When using very large value feedback resistors, (usually >500 kΩ) the large feedback resistance can react with the input capacitance due to transducers, photo diodes, and circuit board parasitics to reduce phase margins.

The effect of input capacitance can be compensated for by adding a feedback capacitor. The feedback capacitor (as in [Figure 7-2](#)), C_f is first estimated by [Equation 1](#) and [Equation 2](#), which typically provides significant overcompensation.

$$\frac{1}{2\pi R_1 C_{IN}} \geq \frac{1}{2\pi R_2 C_f} \quad (1)$$

$$2\pi R_1 C_{IN} \leq 2\pi R_2 C_f \quad (2)$$

Printed circuit board stray capacitance can be larger or smaller than that of a breadboard, so the actual optimum value for C_f can be different. The values of C_f must be checked on the actual circuit.

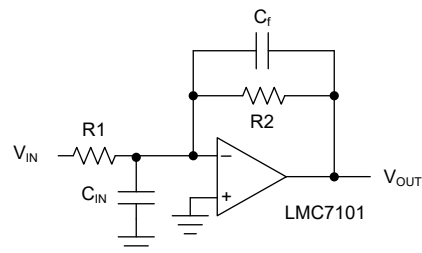

Figure 7-2. Canceling the Effect of Input Capacitance

7.2 Typical Application

[Figure 7-3](#) shows a high input impedance noninverting circuit. This circuit gives a closed-loop gain equal to the ratio of the sum of R_1 and R_2 to R_1 and a closed-loop 3dB bandwidth equal to the amplifier unity-gain frequency divided by the closed-loop gain. This design has the benefit of a very high input impedance, which is equal to the differential input impedance multiplied by loop gain (open loop gain / closed loop gain). In dc-coupled applications, input impedance is not as important as input current and the voltage drop across the source resistance. The amplifier output can go into saturation if the input is allowed to float, which can be important if the amplifier must be switched from source to source.

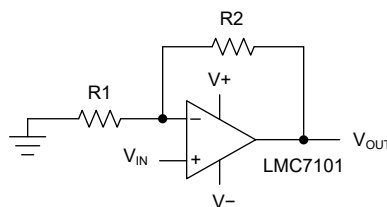

Figure 7-3. Example Application

7.2.1 Design Requirements

For this example application, the supply voltage is 5V, and $100 \times \pm 5\%$ of noninverting gain is necessary. The signal input impedance is approximately 10k Ω .

7.2.2 Detailed Design Procedure

Use the equation for a noninverting amplifier configuration; $G = 1 + R_2 / R_1$, set R_1 to 10k Ω , and R_2 to $99 \times R_1$, which is 990k Ω . Replacing the 990k Ω resistor with a more readily available 1M Ω resistor results in a gain of 101, which is within the desired gain tolerance. The gain-frequency characteristic of the amplifier and the feedback network must be such that oscillation does not occur. To meet this condition, the phase shift through amplifier and feedback network must never exceed 180° for any frequency where the gain of the amplifier and the feedback network is greater than unity. In practical applications, the phase shift must not approach 180° because this is the situation of conditional stability. The most critical case occurs when the attenuation of the feedback network is zero.

7.2.3 Application Curve

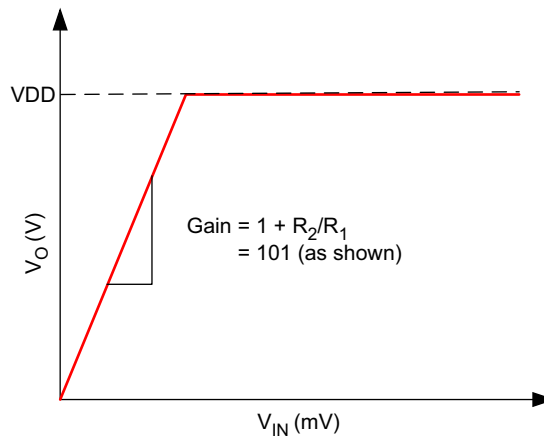

Figure 7-4. Output Response

7.3 Power Supply Recommendations

For proper operation, the power supplies must be decoupled. For supply decoupling, TI recommends placing 10nF to 1 μ F capacitors as close as possible to the operational-amplifier power supply pins. For single supply configurations, place a capacitor between the V+ and V- supply pins. For dual supply configurations, place one capacitor between V+ and ground, and place a second capacitor between V- and ground. Bypass capacitors must have a low ESR of less than 0.1 Ω .

7.4 Layout

7.4.1 Layout Guidelines

Care must be taken to minimize the loop area formed by the bypass capacitor connection between supply pins and ground. A ground plane underneath the device is recommended; any bypass components to ground must have a nearby via to the ground plane. The optimum bypass capacitor placement is closest to the corresponding supply pin. Use of thicker traces from the bypass capacitors to the corresponding supply pins can lower the power-supply inductance and provide a more stable power supply.

The feedback components must be placed as close as possible to the device to minimize stray parasitics.

7.4.2 Layout Example

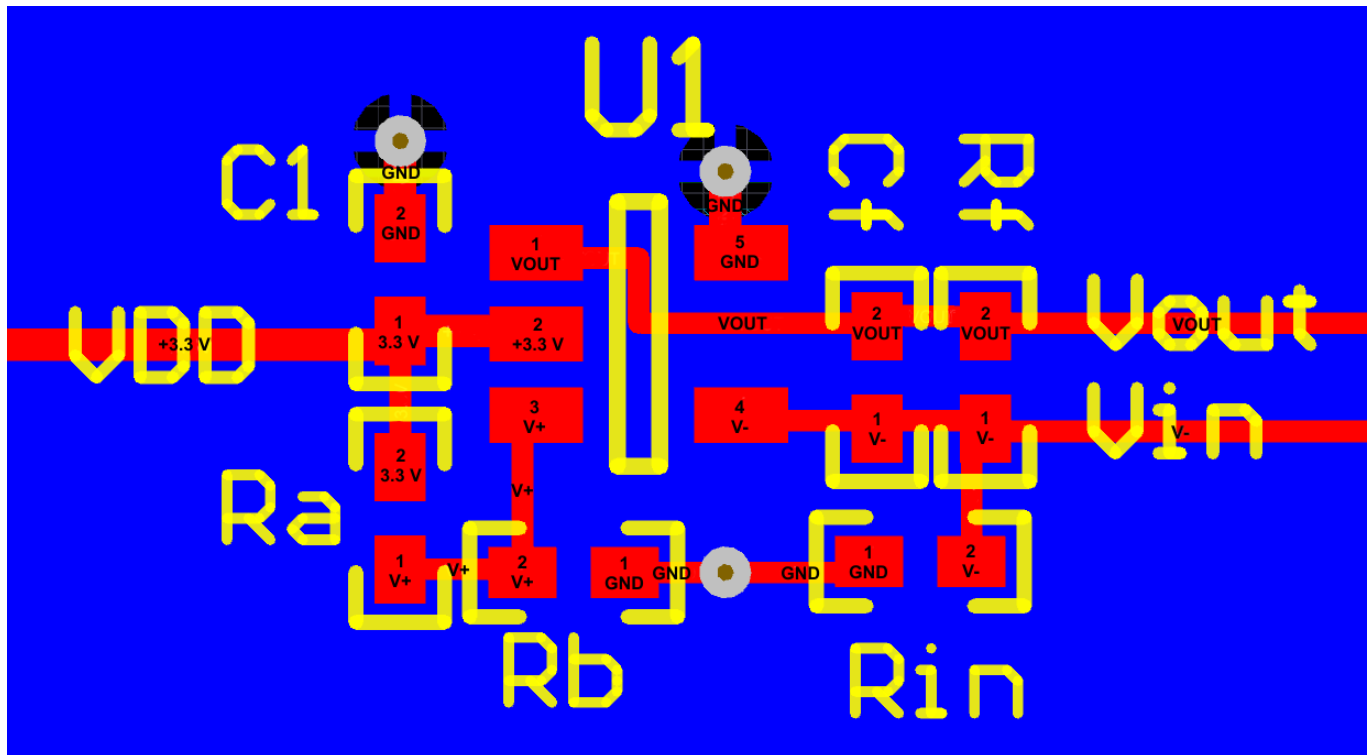

Figure 7-5. LMC7101 Example Layout

8 Device and Documentation Support

8.1 Documentation Support

8.1.1 Related Documentation

For related documentation, see the following:

- Texas Instruments, [LMC66x CMOS Dual Operational Amplifiers data sheet](#)
- Texas Instruments, [RES11A Matched, Thin-Film Resistor Dividers With 1kΩ Inputs data sheet](#)

8.2 Receiving Notification of Documentation Updates

To receive notification of documentation updates, navigate to the device product folder on ti.com. Click on *Notifications* to register and receive a weekly digest of any product information that has changed. For change details, review the revision history included in any revised document.

8.3 Support Resources

[TI E2E™ support forums](#) are an engineer's go-to source for fast, verified answers and design help — straight from the experts. Search existing answers or ask your own question to get the quick design help you need.

Linked content is provided "AS IS" by the respective contributors. They do not constitute TI specifications and do not necessarily reflect TI's views; see TI's [Terms of Use](#).

8.4 Trademarks

TI E2E™ is a trademark of Texas Instruments.
All trademarks are the property of their respective owners.

8.5 Electrostatic Discharge Caution



This integrated circuit can be damaged by ESD. Texas Instruments recommends that all integrated circuits be handled with appropriate precautions. Failure to observe proper handling and installation procedures can cause damage.

ESD damage can range from subtle performance degradation to complete device failure. Precision integrated circuits may be more susceptible to damage because very small parametric changes could cause the device not to meet its published specifications.

8.6 Glossary

[TI Glossary](#) This glossary lists and explains terms, acronyms, and definitions.

9 Revision History

NOTE: Page numbers for previous revisions may differ from page numbers in the current version.

Changes from Revision SNOS719G (September 2015) to Revision * (January 2025)	Page
• Moved LMC7101 commercial device from SNOS719G data sheet into new SBOSAL2 data sheet.....	1
• Updated <i>Features</i>	1
• Deleted machine model (MM) in <i>ESD Ratings</i>	3
• Updated <i>Thermal Information</i>	3
• Updated parameter names and table format in all <i>Electrical Characteristics</i>	4
• Added missing temperature range for input offset voltage drift in all <i>Electrical Characteristics</i>	4
• Changed power-supply rejection ratio from 50dB to 45dB for LMC7101A.....	4
• Changed power-supply rejection ratio from 50dB to 45dB for LMC7101A.....	4
• Changed input common-mode voltage condition from CMRR ≥ 50dB to CMRR ≥ 47dB.....	4
• Changed CMRR MIN from 50dB to 47dB for LMC7101B and from 55dB to 47dB for LMC7101A.....	4
• Deleted notes 1 and 2 in all <i>Electrical Characteristics</i>	4
• Updated note 3 to move information into slew rate test conditions.....	4
• Changed input common-mode voltage condition from CMRR > 50dB to CMRR > 47dB.....	5
• Changed CMRR MIN from 60dB to 47dB for LMC7101B and from 64dB to 47dB for LMC7101A.....	5
• Added missing quiescent current per amplifier TYP value.....	5

• Changed CMRR TYP from 82dB to 75dB.....	6
• Changed CMRR MIN from 60dB to 52dB for LMC7101B and from 65dB to 52dB for LMC7101A.....	6
• Changed CMRR MIN for T _J = –40°C to +85°C from 55dB to 51dB for LMC7101B and from 60dB to 51dB for LMC7101A.....	6
• Changed CMRR TYP for T _J = –40C to +85C from 82dB to 74dB.....	6
• Changed input offset voltage TYP from 0.11mV to 0.26mV.....	8
• Changed CMRR MIN from 65dB to 62dB for LMC7101B and from 70dB to 62dB for LMC7101A.....	8
• Changed CMRR MIN for T _J = –40°C to +85°C from 65dB to 60dB LMC7101A.....	8
• Deleted note 3 and included information to open-loop voltage gain test conditions.....	8
• Deleted Figures 6, 11, 14, 17, 20, 23, and 37.....	10
• Added Figure 5-6.....	10
• Added Figures 5-21 and 5-25.....	14

10 Mechanical, Packaging, and Orderable Information

The following pages include mechanical, packaging, and orderable information. This information is the most current data available for the designated devices. This data is subject to change without notice and revision of this document. For browser-based versions of this data sheet, refer to the left-hand navigation.

PACKAGING INFORMATION

Orderable Device	Status (1)	Package Type	Package Drawing	Pins	Package Qty	Eco Plan (2)	Lead finish/ Ball material (6)	MSL Peak Temp (3)	Op Temp (°C)	Device Marking (4/5)	Samples
LMC7101AIM5/NOPB	OBSOLETE	SOT-23	DBV	5		TBD	Call TI	Call TI	-40 to 85	A00A	
LMC7101AIM5X/NOPB	ACTIVE	SOT-23	DBV	5	3000	RoHS & Green	NIPDAU SN	Level-1-260C-UNLIM	-40 to 85	A00A	Samples
LMC7101BIM5/NOPB	OBSOLETE	SOT-23	DBV	5		TBD	Call TI	Call TI	-40 to 85	A00B	
LMC7101BIM5X/NOPB	ACTIVE	SOT-23	DBV	5	3000	RoHS & Green	NIPDAU SN	Level-1-260C-UNLIM	-40 to 85	A00B	Samples

(1) The marketing status values are defined as follows:

ACTIVE: Product device recommended for new designs.

LIFEBUY: TI has announced that the device will be discontinued, and a lifetime-buy period is in effect.

NRND: Not recommended for new designs. Device is in production to support existing customers, but TI does not recommend using this part in a new design.

PREVIEW: Device has been announced but is not in production. Samples may or may not be available.

OBSOLETE: TI has discontinued the production of the device.

(2) **RoHS:** TI defines "RoHS" to mean semiconductor products that are compliant with the current EU RoHS requirements for all 10 RoHS substances, including the requirement that RoHS substance do not exceed 0.1% by weight in homogeneous materials. Where designed to be soldered at high temperatures, "RoHS" products are suitable for use in specified lead-free processes. TI may reference these types of products as "Pb-Free".

RoHS Exempt: TI defines "RoHS Exempt" to mean products that contain lead but are compliant with EU RoHS pursuant to a specific EU RoHS exemption.

Green: TI defines "Green" to mean the content of Chlorine (Cl) and Bromine (Br) based flame retardants meet JS709B low halogen requirements of <=1000ppm threshold. Antimony trioxide based flame retardants must also meet the <=1000ppm threshold requirement.

(3) MSL, Peak Temp. - The Moisture Sensitivity Level rating according to the JEDEC industry standard classifications, and peak solder temperature.

(4) There may be additional marking, which relates to the logo, the lot trace code information, or the environmental category on the device.

(5) Multiple Device Markings will be inside parentheses. Only one Device Marking contained in parentheses and separated by a "~" will appear on a device. If a line is indented then it is a continuation of the previous line and the two combined represent the entire Device Marking for that device.

(6) Lead finish/Ball material - Orderable Devices may have multiple material finish options. Finish options are separated by a vertical ruled line. Lead finish/Ball material values may wrap to two lines if the finish value exceeds the maximum column width.

Important Information and Disclaimer:The information provided on this page represents TI's knowledge and belief as of the date that it is provided. TI bases its knowledge and belief on information provided by third parties, and makes no representation or warranty as to the accuracy of such information. Efforts are underway to better integrate information from third parties. TI has taken and continues to take reasonable steps to provide representative and accurate information but may not have conducted destructive testing or chemical analysis on incoming materials and chemicals. TI and TI suppliers consider certain information to be proprietary, and thus CAS numbers and other limited information may not be available for release.

In no event shall TI's liability arising out of such information exceed the total purchase price of the TI part(s) at issue in this document sold by TI to Customer on an annual basis.

TAPE AND REEL INFORMATION

QUADRANT ASSIGNMENTS FOR PIN 1 ORIENTATION IN TAPE

*All dimensions are nominal

Device	Package Type	Package Drawing	Pins	SPQ	Reel Diameter (mm)	Reel Width W1 (mm)	A0 (mm)	B0 (mm)	K0 (mm)	P1 (mm)	W (mm)	Pin1 Quadrant
LMC7101AIM5X/NOPB	SOT-23	DBV	5	3000	180.0	8.4	3.2	3.2	1.4	4.0	8.0	Q3
LMC7101AIM5X/NOPB	SOT-23	DBV	5	3000	178.0	8.4	3.2	3.2	1.4	4.0	8.0	Q3
LMC7101BIM5X/NOPB	SOT-23	DBV	5	3000	178.0	8.4	3.2	3.2	1.4	4.0	8.0	Q3
LMC7101BIM5X/NOPB	SOT-23	DBV	5	3000	180.0	8.4	3.2	3.2	1.4	4.0	8.0	Q3

TAPE AND REEL BOX DIMENSIONS

*All dimensions are nominal

Device	Package Type	Package Drawing	Pins	SPQ	Length (mm)	Width (mm)	Height (mm)
LMC7101AIM5X/NOPB	SOT-23	DBV	5	3000	210.0	185.0	35.0
LMC7101AIM5X/NOPB	SOT-23	DBV	5	3000	208.0	191.0	35.0
LMC7101BIM5X/NOPB	SOT-23	DBV	5	3000	208.0	191.0	35.0
LMC7101BIM5X/NOPB	SOT-23	DBV	5	3000	210.0	185.0	35.0

EXAMPLE BOARD LAYOUT

DBV0005A

SOT-23 - 1.45 mm max height

SMALL OUTLINE TRANSISTOR



LAND PATTERN EXAMPLE
EXPOSED METAL SHOWN
SCALE:15X



SOLDER MASK DETAILS

4214839/K 08/2024

NOTES: (continued)

- 6. Publication IPC-7351 may have alternate designs.
- 7. Solder mask tolerances between and around signal pads can vary based on board fabrication site.

EXAMPLE STENCIL DESIGN

DBV0005A

SOT-23 - 1.45 mm max height

SMALL OUTLINE TRANSISTOR



SOLDER PASTE EXAMPLE
BASED ON 0.125 mm THICK STENCIL
SCALE:15X

4214839/K 08/2024

NOTES: (continued)

8. Laser cutting apertures with trapezoidal walls and rounded corners may offer better paste release. IPC-7525 may have alternate design recommendations.
9. Board assembly site may have different recommendations for stencil design.

IMPORTANT NOTICE AND DISCLAIMER

TI PROVIDES TECHNICAL AND RELIABILITY DATA (INCLUDING DATA SHEETS), DESIGN RESOURCES (INCLUDING REFERENCE DESIGNS), APPLICATION OR OTHER DESIGN ADVICE, WEB TOOLS, SAFETY INFORMATION, AND OTHER RESOURCES "AS IS" AND WITH ALL FAULTS, AND DISCLAIMS ALL WARRANTIES, EXPRESS AND IMPLIED, INCLUDING WITHOUT LIMITATION ANY IMPLIED WARRANTIES OF MERCHANTABILITY, FITNESS FOR A PARTICULAR PURPOSE OR NON-INFRINGEMENT OF THIRD PARTY INTELLECTUAL PROPERTY RIGHTS.

These resources are intended for skilled developers designing with TI products. You are solely responsible for (1) selecting the appropriate TI products for your application, (2) designing, validating and testing your application, and (3) ensuring your application meets applicable standards, and any other safety, security, regulatory or other requirements.

These resources are subject to change without notice. TI grants you permission to use these resources only for development of an application that uses the TI products described in the resource. Other reproduction and display of these resources is prohibited. No license is granted to any other TI intellectual property right or to any third party intellectual property right. TI disclaims responsibility for, and you will fully indemnify TI and its representatives against, any claims, damages, costs, losses, and liabilities arising out of your use of these resources.

TI's products are provided subject to [TI's Terms of Sale](#) or other applicable terms available either on [ti.com](https://www.ti.com) or provided in conjunction with such TI products. TI's provision of these resources does not expand or otherwise alter TI's applicable warranties or warranty disclaimers for TI products.

TI objects to and rejects any additional or different terms you may have proposed.

Mailing Address: Texas Instruments, Post Office Box 655303, Dallas, Texas 75265
Copyright © 2025, Texas Instruments Incorporated