

## LMV1015 Analog Series: Built-in Gain IC's for High Sensitivity 2-Wire Microphones

Check for Samples: [LMV1015](#)

### FEATURES

- (Typical LMV1015-15, 2.2V supply,  $R_L = 2.2\text{ k}\Omega$ ,  $C = 2.2\text{ }\mu\text{F}$ ,  $V_{IN} = 18\text{ mV}_{PP}$ , unless otherwise specified)
- **Supply Voltage: 2V - 5V**
- **Supply Current: <180  $\mu\text{A}$**
- **Signal to Noise Ratio (A-Weighted): 60 dB**
- **Output Voltage Noise (A-Weighted): -89 dBV**
- **Total Harmonic Distortion 0.09%**
- **Voltage Gain**
  - LMV1015-15: 15.6 dB
  - LMV1015-25: 23.8 dB
- **Temperature Range: -40°C to 85°C**
- **Large Dome 4-Bump DSBGA Package with Improved Adhesion Technology.**

### APPLICATIONS

- Cellular Phones
- Headsets
- Mobile Communications
- Automotive Accessories
- PDAs
- Accessory Microphone Products

### Schematic Diagram

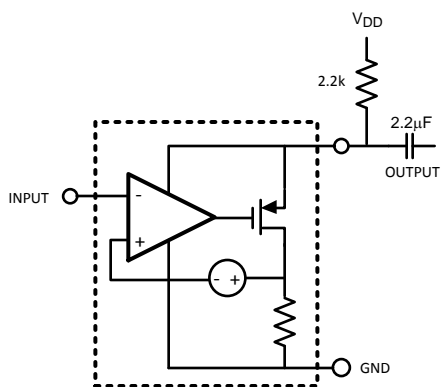

### DESCRIPTION

The LMV1015 is an audio amplifier series for small form factor electret microphones. This 2-wire portfolio is designed to replace the JFET amplifier. The LMV1015 series is ideally suited for applications requiring high signal integrity in the presence of ambient or RF noise, such as in cellular communications. The LMV1015 audio amplifiers are ensured to operate over a 2.2V to 5.0V supply voltage range with fixed gains of 15.6 dB and 23.8 dB. The devices offer excellent THD, gain accuracy and temperature stability as compared to a JFET microphone.

The LMV1015 series enables a two-pin electret microphone solution, which provides direct pin-to-pin compatibility with the existing older JFET market.

Texas Instruments' built-in gain families are offered in extremely thin space saving 4-bump DSBGA packages (0.3 mm maximum). The LMV1015XR is designed for 1.0 mm ECM canisters and thicker. These extremely miniature packages have the Large Dome Bump (LDB) technology. This DSBGA technology is designed for microphone PCBs requiring 1 kg adhesion criteria.

### Built-In Gain Electret Microphone

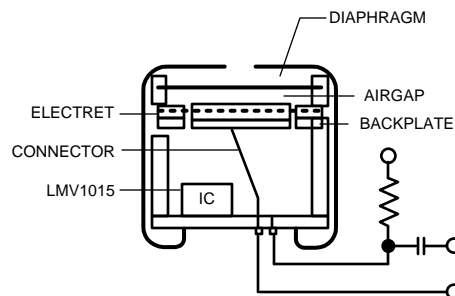

These devices have limited built-in ESD protection. The leads should be shorted together or the device placed in conductive foam during storage or handling to prevent electrostatic damage to the MOS gates.



Please be aware that an important notice concerning availability, standard warranty, and use in critical applications of Texas Instruments semiconductor products and disclaimers thereto appears at the end of this data sheet.

All trademarks are the property of their respective owners.

### Absolute Maximum Ratings<sup>(1)</sup>

ESD Tolerance <sup>(2)</sup>	Human Body Model	2500V
	Machine Model	250V
Supply Voltage	V <sub>DD</sub> - GND	5.5V
Storage Temperature Range		-65°C to 150°C
Junction Temperature <sup>(3)</sup>		150°C max
Mounting Temperature	Infrared or Convection (20 sec.)	235°C

- (1) Absolute Maximum Ratings indicate limits beyond which damage to the device may occur. Operating Ratings indicate conditions for which the device is intended to be functional, but specific performance is not ensured. For ensured specifications and the test conditions, see the Electrical Characteristics.
- (2) Human Body Model (HBM) is 1.5 kΩ in series with 100 pF.
- (3) The maximum power dissipation is a function of T<sub>J(MAX)</sub>, θ<sub>JA</sub> and T<sub>A</sub>. The maximum allowable power dissipation at any ambient temperature is P<sub>D</sub> = (T<sub>J(MAX)</sub> - T<sub>A</sub>)/θ<sub>JA</sub>. All numbers apply for packages soldered directly into a PC board.

### Operating Ratings<sup>(1)</sup>

Supply Voltage	2V to 5V
Operating Temperature Range	-40°C to 85°C
Thermal Resistance (θ <sub>JA</sub> )	368°C/W

- (1) Absolute Maximum Ratings indicate limits beyond which damage to the device may occur. Operating Ratings indicate conditions for which the device is intended to be functional, but specific performance is not ensured. For ensured specifications and the test conditions, see the Electrical Characteristics.

### 2.2V Electrical Characteristics<sup>(1)</sup>

Unless otherwise specified, all limits ensured for T<sub>J</sub> = 25°C, V<sub>DD</sub> = 2.2V, V<sub>IN</sub> = 18 mV<sub>PP</sub>, R<sub>L</sub> = 2.2 kΩ and C = 2.2 μF.

**Boldface** limits apply at the temperature extremes.

Parameter		Test Conditions	Min <sup>(2)</sup>	Typ <sup>(3)</sup>	Max <sup>(2)</sup>	Units
I <sub>DD</sub>	Supply Current	V <sub>IN</sub> = GND	LMV1015-15	180	300 <b>325</b>	μA
			LMV1015-25	141	250 <b>300</b>	
SNR	Signal to Noise Ratio	f = 1 kHz, V <sub>IN</sub> = 18 mV <sub>PP</sub> , A-Weighted	LMV1015-15	60		dB
			LMV1015-25	61		
V <sub>IN</sub>	Max Input Signal	f = 1 kHz and THD+N < 1%	LMV1015-15	100		mV <sub>PP</sub>
			LMV1015-25	28		
V <sub>OUT</sub>	Output Voltage	V <sub>IN</sub> = GND	LMV1015-15	1.54 <b>1.48</b>	1.81 <b>2.00</b>	V
			LMV1015-25	1.65 <b>1.49</b>	1.90 <b>2.18</b>	
f <sub>LOW</sub>	Lower -3dB Roll Off Frequency	R <sub>SOURCE</sub> = 50Ω		65		Hz
f <sub>HIGH</sub>	Upper -3dB Roll Off Frequency	R <sub>SOURCE</sub> = 50Ω		95		kHz
e <sub>n</sub>	Output Noise	A-Weighted	LMV1015-15	-89		dBV
			LMV1015-25	-82		
THD	Total Harmonic Distortion	f = 1 kHz, V <sub>IN</sub> = 18 mV <sub>PP</sub>	LMV1015-15	0.09		%
			LMV1015-25	0.15		
C <sub>IN</sub>	Input Capacitance			2		pF
Z <sub>IN</sub>	Input Impedance			>1000		GΩ
A <sub>V</sub>	Gain	f = 1 kHz, R <sub>SOURCE</sub> = 50Ω	LMV1015-15	14.0 <b>13.1</b>	15.6 <b>17.5</b>	dB
			LMV1015-25	22.5 <b>21.4</b>	23.8 <b>25.7</b>	

- (1) Electrical Table values apply only for factory testing conditions at the temperature indicated. Factory testing conditions result in very limited self-heating of the device such that T<sub>J</sub> = T<sub>A</sub>. No specification of parametric performance is indicated in the electrical tables under conditions of internal self-heating where T<sub>J</sub> > T<sub>A</sub>.
- (2) All limits are specified by design or statistical analysis.
- (3) Typical values represent the most likely parametric norm.

### 5V Electrical Characteristics<sup>(1)</sup>

Unless otherwise specified, all limits ensured for  $T_J = 25^\circ\text{C}$ ,  $V_{DD} = 5\text{V}$ ,  $V_{IN} = 18\text{ mV}_{PP}$ ,  $R_L = 2.2\text{ k}\Omega$  and  $C = 2.2\text{ }\mu\text{F}$ . **Boldface** limits apply at the temperature extremes.

Parameter		Test Conditions		Min <sup>(2)</sup>	Typ <sup>(3)</sup>	Max <sup>(2)</sup>	Units
$I_{DD}$	Supply Current	$V_{IN} = \text{GND}$	LMV1015-15		200	300 <b>325</b>	$\mu\text{A}$
			LMV1015-25		160	250 <b>300</b>	
SNR	Signal to Noise Ratio	$f = 1\text{ kHz}$ , $V_{IN} = 18\text{ mV}_{PP}$ , A-Weighted	LMV1015-15		60		dB
			LMV1015-25		61		
$V_{IN}$	Max Input Signal	$f = 1\text{ kHz}$ and $\text{THD} + \text{N} < 1\%$	LMV1015-15		100		$\text{mV}_{PP}$
			LMV1015-25		28		
$V_{OUT}$	Output Voltage	$V_{IN} = \text{GND}$	LMV1015-15	4.34 <b>4.28</b>	4.56	4.74 <b>4.80</b>	V
			LMV1015-25	4.45 <b>4.39</b>	4.65	4.83 <b>4.86</b>	
$f_{LOW}$	Lower -3dB Roll Off Frequency	$R_{SOURCE} = 50\Omega$			67		Hz
$f_{HIGH}$	Upper -3dB Roll Off Frequency	$R_{SOURCE} = 50\Omega$			150		kHz
$e_n$	Output Noise	A-Weighted	LMV1015-15		-89		dBV
			LMV1015-25		-82		
THD	Total Harmonic Distortion	$f = 1\text{ kHz}$ , $V_{IN} = 18\text{ mV}_{PP}$	LMV1015-15		0.13		%
			LMV1015-25		0.21		
$C_{IN}$	Input Capacitance				2		pF
$Z_{IN}$	Input Impedance				>1000		$\text{G}\Omega$
$A_V$	Gain	$f = 1\text{ kHz}$ , $R_{SOURCE} = 50\Omega$	LMV1015-15	14.0 <b>13.1</b>	15.6	16.9 <b>17.5</b>	dB
			LMV1015-25	22.5 <b>21.2</b>	23.9	25.1 <b>25.9</b>	

- (1) Electrical Table values apply only for factory testing conditions at the temperature indicated. Factory testing conditions result in very limited self-heating of the device such that  $T_J = T_A$ . No specification of parametric performance is indicated in the electrical tables under conditions of internal self-heating where  $T_J > T_A$ .
- (2) All limits are specified by design or statistical analysis.
- (3) Typical values represent the most likely parametric norm.

### Connection Diagram

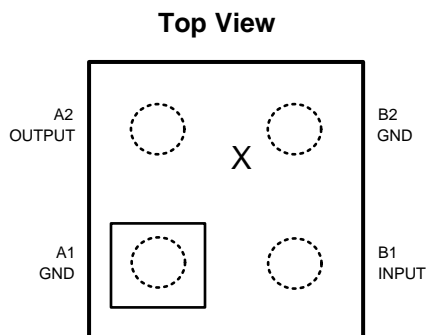

**Figure 1. Large Dome 4-Bump DSBGA Package**

**NOTE:**

- Pin numbers are referenced to package marking text orientation.
- The actual physical placement of the package marking will vary slightly from part to part. The package will designate the date code and will vary considerably. Package marking does not correlate to device type in any way.

### Typical Performance Characteristics

Unless otherwise specified,  $V_S = 2.2V$ ,  $R_L = 2.2\text{ k}\Omega$ ,  $C = 2.2\text{ }\mu\text{F}$ , single supply,  $T_A = 25^\circ\text{C}$

**Supply Current vs. Supply Voltage (LMV1015-15)**

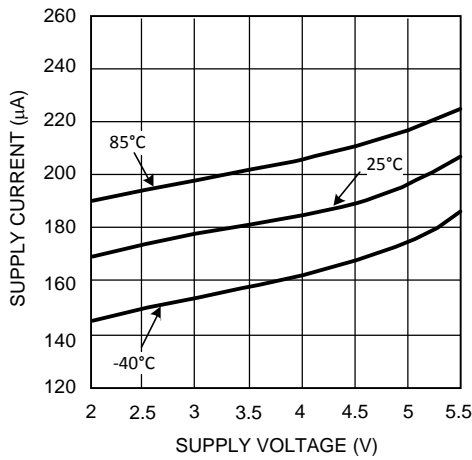

**Figure 2.**

**Supply Current vs. Supply Voltage (LMV1015-25)**

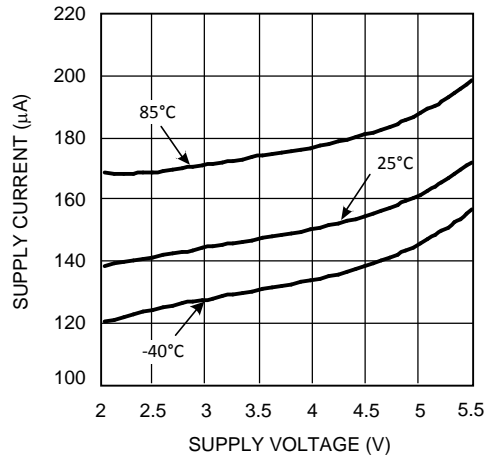

**Figure 3.**

**Gain and Phase vs. Frequency (LMV1015-15)**

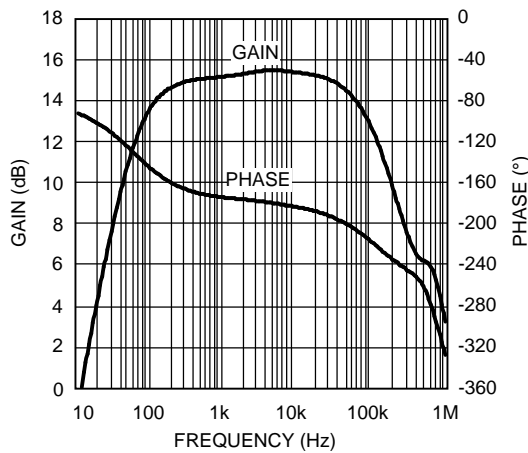

**Figure 4.**

**Gain and Phase vs. Frequency (LMV1015-25)**

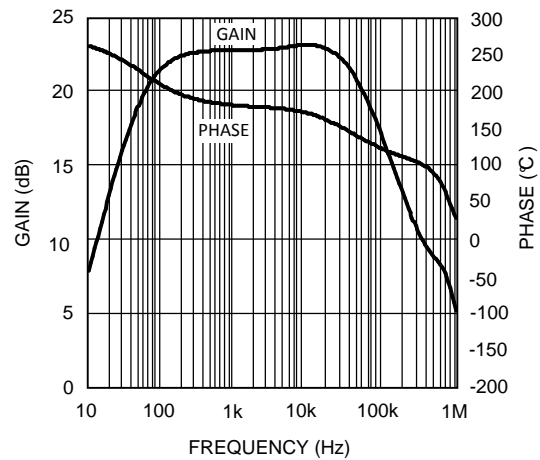

**Figure 5.**

**Total Harmonic Distortion vs. Frequency (LMV1015-15)**

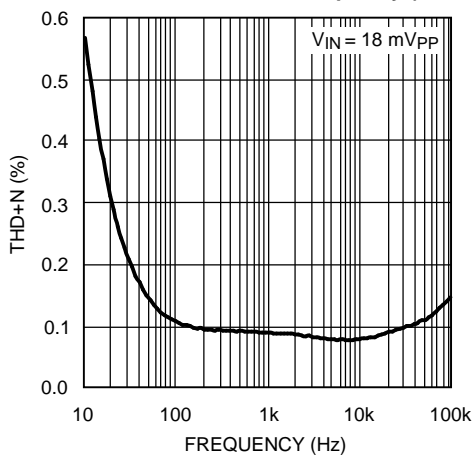

**Figure 6.**

**Total Harmonic Distortion vs. Frequency (LMV1015-25)**

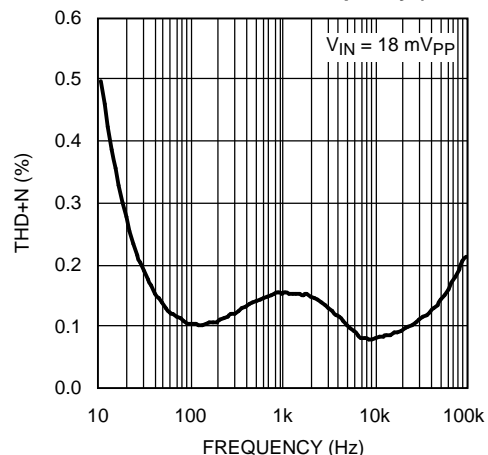
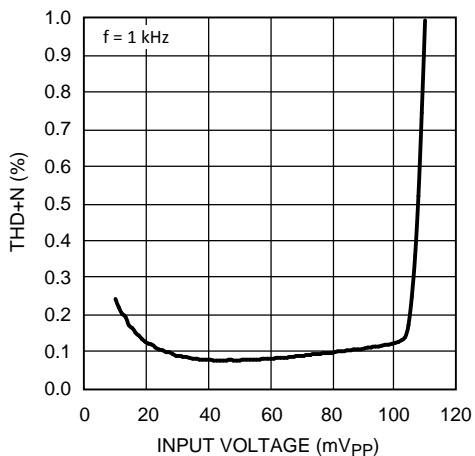

**Figure 7.**

**Typical Performance Characteristics (continued)**

Unless otherwise specified,  $V_S = 2.2V$ ,  $R_L = 2.2\text{ k}\Omega$ ,  $C = 2.2\text{ }\mu\text{F}$ , single supply,  $T_A = 25^\circ\text{C}$

**Total Harmonic Distortion vs. Input Voltage (LMV1015-15)**



**Figure 8.**

**Total Harmonic Distortion vs. Input Voltage (LMV1015-25)**

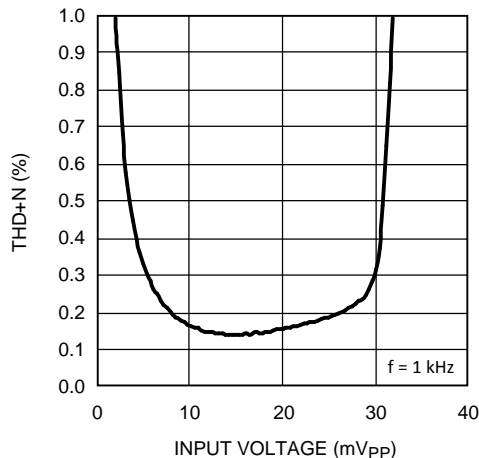

**Figure 9.**

**Output Noise vs. Frequency (LMV1015-15)**

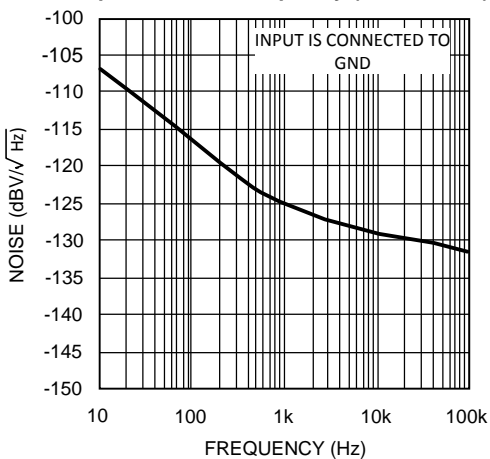

**Figure 10.**

**Output Noise vs. Frequency (LMV1015-25)**

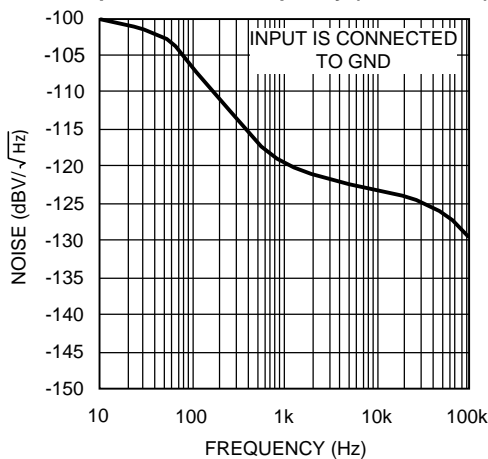

**Figure 11.**

## APPLICATION SECTION

### HIGH GAIN

The LMV1015 series provides outstanding gain versus the JFET and still maintains the same ease of implementation, with improved gain, linearity and temperature stability. A high gain eliminates the need for extra external components.

### BUILT IN GAIN

The LMV1015 is offered in 0.3 mm height space saving small 4-pin DSBGA packages in order to fit inside the different size ECM canisters of a microphone. The LMV1015 is placed on the PCB inside the microphone using Large Dome Bump technology (LDB).

The bottom side of the PCB usually shows a bull's eye pattern where the outer ring, which is shorted to the metal can, should be connected to the ground. The center dot on the PCB is connected to the  $V_{DD}$  through a resistor. This phantom biasing allows both supply voltage and output signal on one connection.

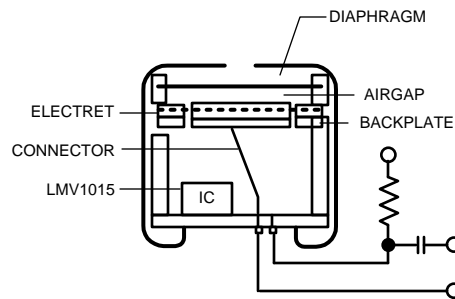

Figure 12. Built in Gain

### A-WEIGHTED FILTER

The human ear has a frequency range from 20 Hz to about 20 kHz. Within this range the sensitivity of the human ear is not equal for each frequency. To approach the hearing response weighting filters are introduced. One of those filters is the A-weighted filter.

The A-weighted filter is usually used in signal to noise ratio measurements, where sound is compared to device noise. This filter improves the correlation of the measured data to the signal to noise ratio perceived by the human ear.

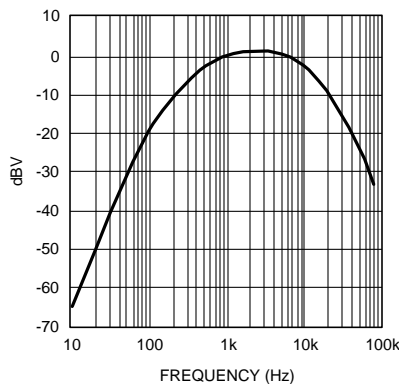

Figure 13. A-Weighted Filter

## MEASURING NOISE AND SNR

The overall noise of the LMV1015 is measured within the frequency band from 10 Hz to 22 kHz using an A-weighted filter. The input of the LMV1015 is connected to ground with a 5 pF capacitor, as in Figure 14. Special precautions in the internal structure of the LMV1015 have been taken to reduce the noise on the output.

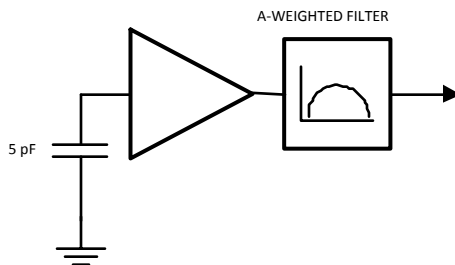

Figure 14. Noise Measurement Setup

The signal to noise ratio (SNR) is measured with a 1 kHz input signal of 18 mV<sub>pp</sub> using an A-weighted filter. This represents a sound pressure level of 94 dB SPL. No input capacitor is connected for the measurement.

## SOUND PRESSURE LEVEL

The volume of sound applied to a microphone is usually stated as a pressure level referred to the threshold of hearing of the human ear. The sound pressure level (SPL) in decibels is defined by:

$$\text{Sound pressure level (dB)} = 20 \log P_m/P_0$$

Where,

$P_m$  is the measured sound pressure

$P_0$  is the threshold of hearing (20  $\mu$ Pa)

In order to be able to calculate the resulting output voltage of the microphone for a given SPL, the sound pressure in dB SPL needs to be converted to the absolute sound pressure in dBPa. This is the sound pressure level in decibels referred to 1 Pascal (Pa).

The conversion is given by:

$$\text{dBPa} = \text{dB SPL} + 20 \cdot \log 20 \mu\text{Pa}$$

$$\text{dBPa} = \text{dB SPL} - 94 \text{ dB}$$

Translation from absolute sound pressure level to a voltage is specified by the sensitivity of the microphone. A conventional microphone has a sensitivity of -44 dBV/Pa.

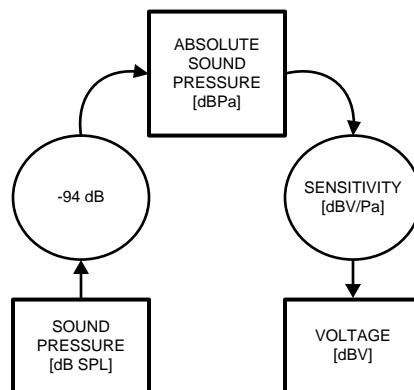

Figure 15. dB SPL to dBV Conversion

Example: Busy traffic is 70 dB SPL.

$$V_{OUT} = 70 - 94 - 44 = -68 \text{ dBV. This is equivalent to } 1.13 \text{ mV}_{PP}$$

Since the LMV1015-15 has a gain of 6 (15.6 dB) over the JFET, the output voltage of the microphone is 6.78 mV<sub>PP</sub>. By implementing the LMV1015-15, the sensitivity of the microphone is -28.4 dBV/Pa (-44 + 15.6).

## LOW FREQUENCY CUT OFF FILTER

To reduce noise on the output of the microphone a low frequency cut off filter has been implemented. This filter reduces the effect of wind and handling noise.

It's also helpful to reduce the proximity effect in directional microphones. This effect occurs when the sound source is very close to the microphone. The lower frequencies are amplified which gives a bass sound. This amplification can cause an overload, which results in a distortion of the signal.

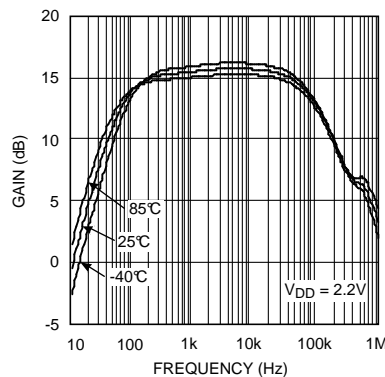

**Figure 16. LMV1015-15 Gain vs. Frequency Over Temperature**

The LMV1015 is optimized to be used in audio band applications. By using the LMV1015, the gain response is flat within the audio band and has linearity and temperature stability [Figure 16](#).

## NOISE

Noise pick-up by a microphone in cell phones is a well-known problem. A conventional JFET circuit is sensitive for noise pick-up because of its high output impedance, which is usually around 2.2 kΩ.

RF noise is amongst other caused by non-linear behavior. The non-linear behavior of the amplifier at high frequencies, well above the usable bandwidth of the device, causes AM-demodulation of high frequency signals. The AM modulation contained in such signals folds back into the audio band, thereby disturbing the intended microphone signal. The GSM signal of a cell phone is such an AM-modulated signal. The modulation frequency of 216 Hz and its harmonics can be observed in the audio band. This kind of noise is called bumblebee noise.

RF noise caused by a GSM signal can be reduced by connecting two external capacitors to ground, see [Figure 17](#). One capacitor reduces the noise caused by the 900 MHz carrier and the other reduces the noise caused by 1800/1900 MHz.

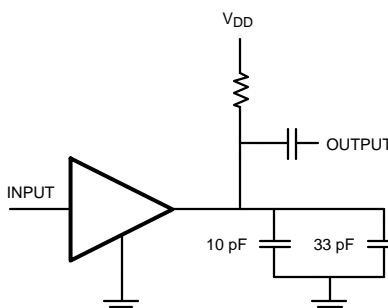

**Figure 17. RF Noise Reduction**



---

**REVISION HISTORY**

<b>Changes from Revision A (April 2013) to Revision B</b>	<b>Page</b>
• Changed layout of National Data Sheet to TI format .....	<a href="#">8</a>

---

**PACKAGING INFORMATION**

Orderable Device	Status (1)	Package Type	Package Drawing	Pins	Package Qty	Eco Plan (2)	Lead finish/ Ball material (6)	MSL Peak Temp (3)	Op Temp (°C)	Device Marking (4/5)	Samples
LMV1015UR-25/NOPB	ACTIVE	DSBGA	YPD	4	250	RoHS & Green	SNAGCU	Level-1-260C-UNLIM			<b>Samples</b>

(1) The marketing status values are defined as follows:

**ACTIVE:** Product device recommended for new designs.

**LIFEBUY:** TI has announced that the device will be discontinued, and a lifetime-buy period is in effect.

**NRND:** Not recommended for new designs. Device is in production to support existing customers, but TI does not recommend using this part in a new design.

**PREVIEW:** Device has been announced but is not in production. Samples may or may not be available.

**OBSOLETE:** TI has discontinued the production of the device.

(2) **RoHS:** TI defines "RoHS" to mean semiconductor products that are compliant with the current EU RoHS requirements for all 10 RoHS substances, including the requirement that RoHS substance do not exceed 0.1% by weight in homogeneous materials. Where designed to be soldered at high temperatures, "RoHS" products are suitable for use in specified lead-free processes. TI may reference these types of products as "Pb-Free".

**RoHS Exempt:** TI defines "RoHS Exempt" to mean products that contain lead but are compliant with EU RoHS pursuant to a specific EU RoHS exemption.

**Green:** TI defines "Green" to mean the content of Chlorine (Cl) and Bromine (Br) based flame retardants meet JS709B low halogen requirements of <=1000ppm threshold. Antimony trioxide based flame retardants must also meet the <=1000ppm threshold requirement.

(3) MSL, Peak Temp. - The Moisture Sensitivity Level rating according to the JEDEC industry standard classifications, and peak solder temperature.

(4) There may be additional marking, which relates to the logo, the lot trace code information, or the environmental category on the device.

(5) Multiple Device Markings will be inside parentheses. Only one Device Marking contained in parentheses and separated by a "-" will appear on a device. If a line is indented then it is a continuation of the previous line and the two combined represent the entire Device Marking for that device.

(6) Lead finish/Ball material - Orderable Devices may have multiple material finish options. Finish options are separated by a vertical ruled line. Lead finish/Ball material values may wrap to two lines if the finish value exceeds the maximum column width.

**Important Information and Disclaimer:**The information provided on this page represents TI's knowledge and belief as of the date that it is provided. TI bases its knowledge and belief on information provided by third parties, and makes no representation or warranty as to the accuracy of such information. Efforts are underway to better integrate information from third parties. TI has taken and continues to take reasonable steps to provide representative and accurate information but may not have conducted destructive testing or chemical analysis on incoming materials and chemicals. TI and TI suppliers consider certain information to be proprietary, and thus CAS numbers and other limited information may not be available for release.

In no event shall TI's liability arising out of such information exceed the total purchase price of the TI part(s) at issue in this document sold by TI to Customer on an annual basis.

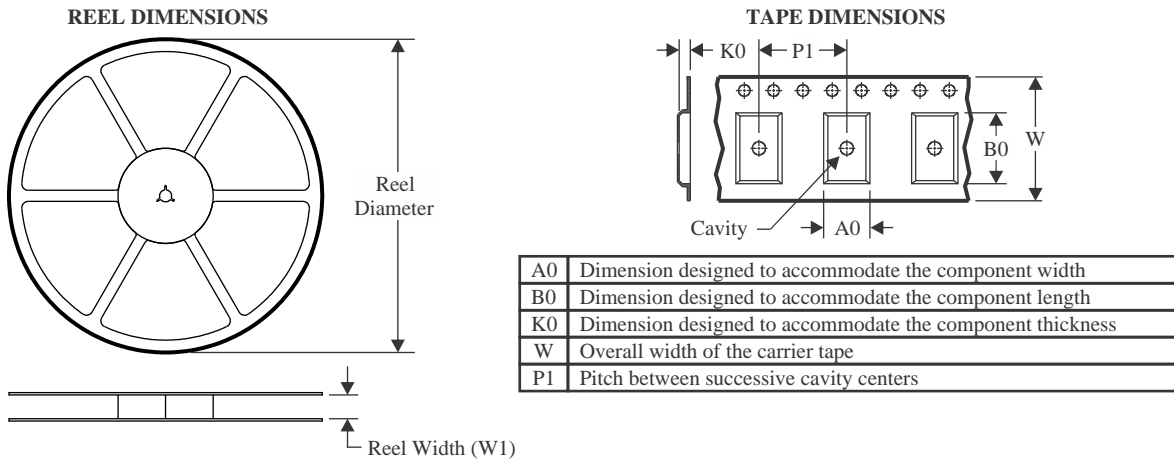
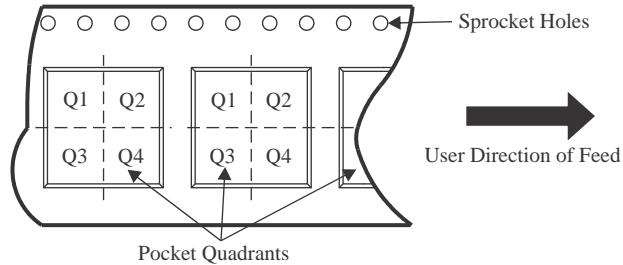
**TAPE AND REEL INFORMATION**

**QUADRANT ASSIGNMENTS FOR PIN 1 ORIENTATION IN TAPE**

\*All dimensions are nominal

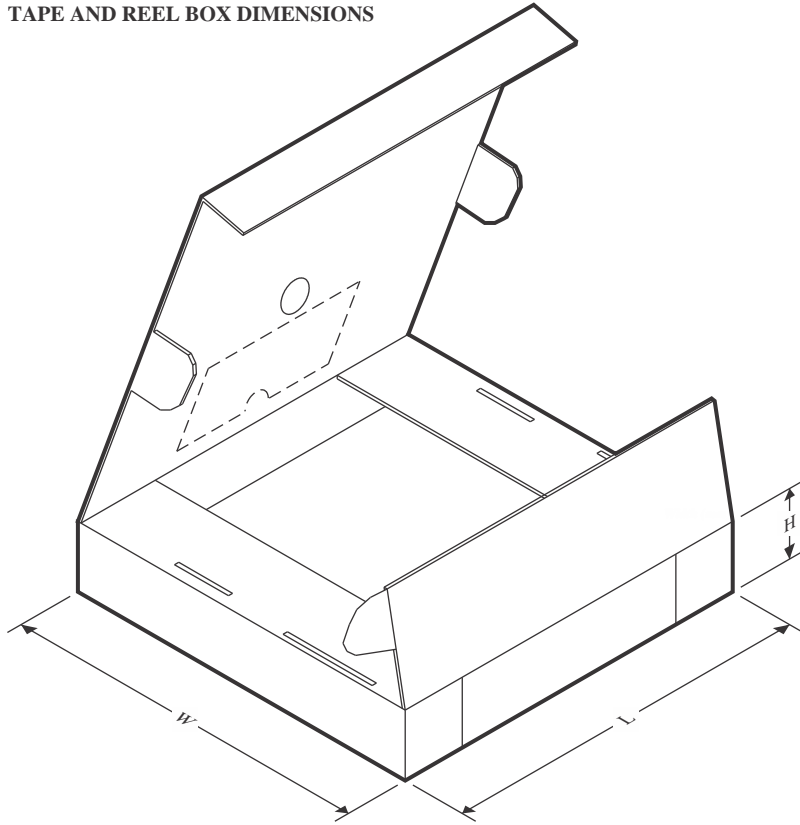
Device	Package Type	Package Drawing	Pins	SPQ	Reel Diameter (mm)	Reel Width W1 (mm)	A0 (mm)	B0 (mm)	K0 (mm)	P1 (mm)	W (mm)	Pin1 Quadrant
LMV1015UR-25/NOPB	DSBGA	YPD	4	250	178.0	8.4	1.02	1.09	0.56	4.0	8.0	Q1

**TAPE AND REEL BOX DIMENSIONS**

\*All dimensions are nominal

Device	Package Type	Package Drawing	Pins	SPQ	Length (mm)	Width (mm)	Height (mm)
LMV1015UR-25/NOPB	DSBGA	YPD	4	250	208.0	191.0	35.0

YPD0004

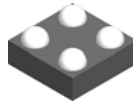

# PACKAGE OUTLINE

DSBGA - 0.395 mm max height

DIE SIZE BALL GRID ARRAY

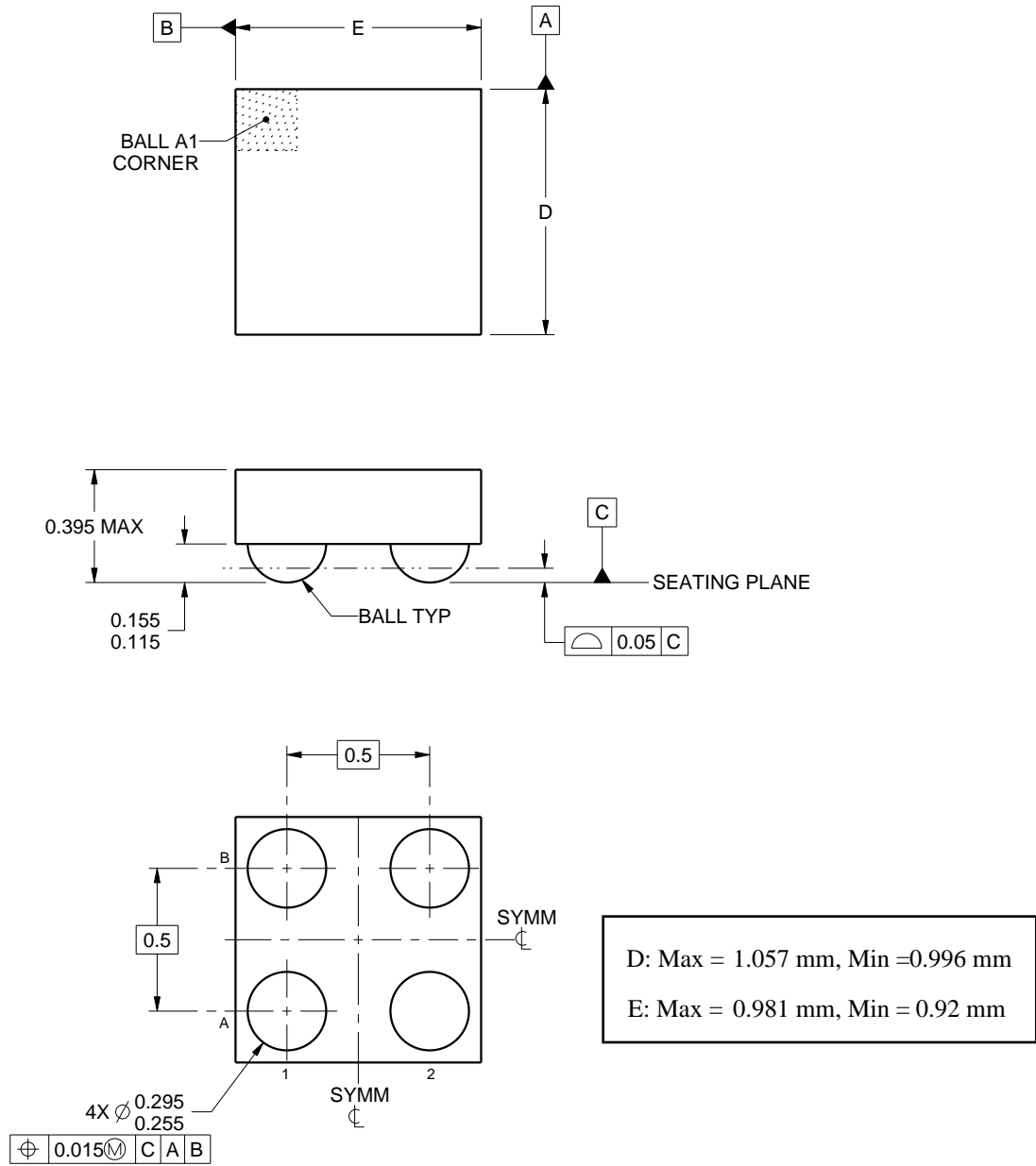

4215141/B 08/2016

NOTES:

1. All linear dimensions are in millimeters. Any dimensions in parenthesis are for reference only. Dimensioning and tolerancing per ASME Y14.5M.
2. This drawing is subject to change without notice.

# EXAMPLE BOARD LAYOUT

YPD0004

DSBGA - 0.395 mm max height

DIE SIZE BALL GRID ARRAY

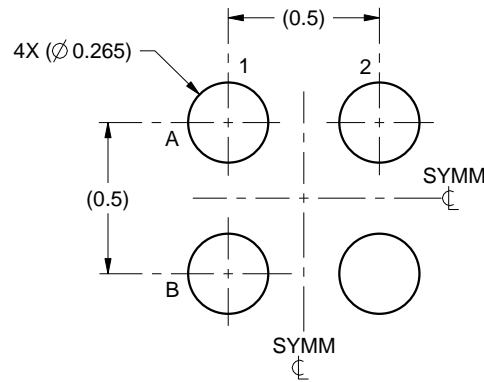

LAND PATTERN EXAMPLE  
SCALE:40X

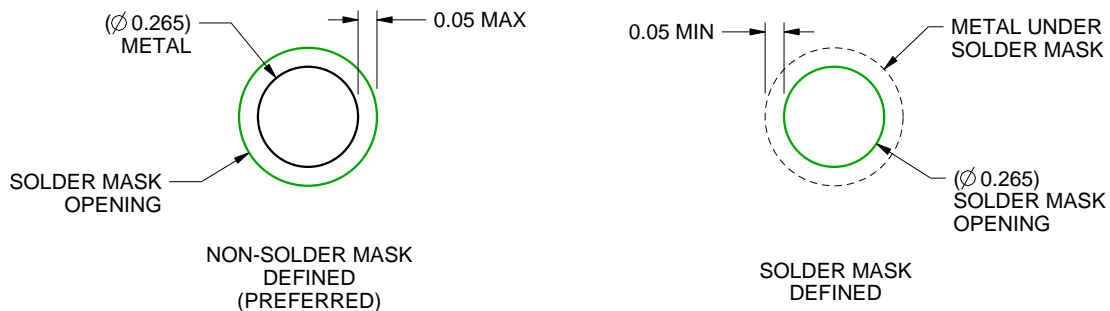

SOLDER MASK DETAILS  
NOT TO SCALE

4215141/B 08/2016

NOTES: (continued)

3. Final dimensions may vary due to manufacturing tolerance considerations and also routing constraints. See Texas Instruments Literature No. SNVA009 ([www.ti.com/lit/snva009](http://www.ti.com/lit/snva009)).

# EXAMPLE STENCIL DESIGN

YPD0004

DSBGA - 0.395 mm max height

DIE SIZE BALL GRID ARRAY

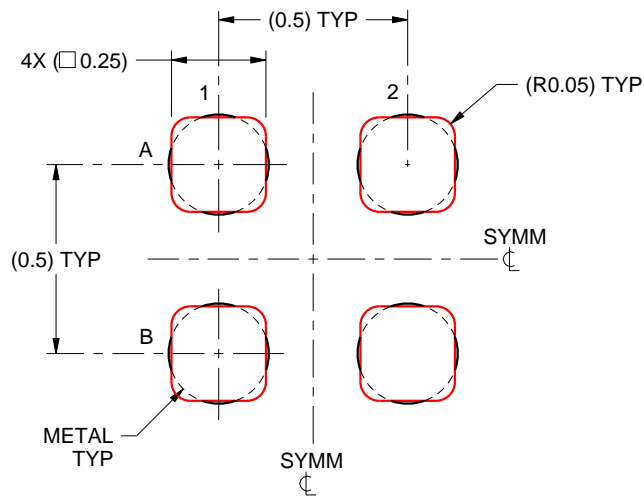

SOLDER PASTE EXAMPLE  
BASED ON 0.1 mm THICK STENCIL  
SCALE:50X

4215141/B 08/2016

NOTES: (continued)

4. Laser cutting apertures with trapezoidal walls and rounded corners may offer better paste release.

## IMPORTANT NOTICE AND DISCLAIMER

TI PROVIDES TECHNICAL AND RELIABILITY DATA (INCLUDING DATA SHEETS), DESIGN RESOURCES (INCLUDING REFERENCE DESIGNS), APPLICATION OR OTHER DESIGN ADVICE, WEB TOOLS, SAFETY INFORMATION, AND OTHER RESOURCES "AS IS" AND WITH ALL FAULTS, AND DISCLAIMS ALL WARRANTIES, EXPRESS AND IMPLIED, INCLUDING WITHOUT LIMITATION ANY IMPLIED WARRANTIES OF MERCHANTABILITY, FITNESS FOR A PARTICULAR PURPOSE OR NON-INFRINGEMENT OF THIRD PARTY INTELLECTUAL PROPERTY RIGHTS.

These resources are intended for skilled developers designing with TI products. You are solely responsible for (1) selecting the appropriate TI products for your application, (2) designing, validating and testing your application, and (3) ensuring your application meets applicable standards, and any other safety, security, regulatory or other requirements.

These resources are subject to change without notice. TI grants you permission to use these resources only for development of an application that uses the TI products described in the resource. Other reproduction and display of these resources is prohibited. No license is granted to any other TI intellectual property right or to any third party intellectual property right. TI disclaims responsibility for, and you will fully indemnify TI and its representatives against, any claims, damages, costs, losses, and liabilities arising out of your use of these resources.

TI's products are provided subject to [TI's Terms of Sale](#) or other applicable terms available either on [ti.com](https://www.ti.com) or provided in conjunction with such TI products. TI's provision of these resources does not expand or otherwise alter TI's applicable warranties or warranty disclaimers for TI products.

TI objects to and rejects any additional or different terms you may have proposed.

Mailing Address: Texas Instruments, Post Office Box 655303, Dallas, Texas 75265  
Copyright © 2024, Texas Instruments Incorporated