

LMV3xxA Low-Voltage Rail-to-Rail Output Operational Amplifiers

1 Features

- Low input offset voltage: $\pm 1\text{mV}$
- Rail-to-rail output
- Unity-gain bandwidth: 1MHz
- Low broadband noise: $30\text{nV}/\sqrt{\text{Hz}}$
- Low input bias current: 10pA
- Low quiescent current: $70\mu\text{A}/\text{Ch}$
- Unity-gain stable
- Internal RFI and EMI filter
- Operational at supply voltages as low as 2.5V
- Easier to stabilize with higher capacitive load due to resistive open-loop output impedance
- Extended temperature range: -40°C to 125°C

2 Applications

- Smoke detectors
- [Motion detectors](#)
- [Wearable devices](#)
- Large and small appliances
- EPOS
- [Barcode scanners](#)
- Sensor signal conditioning
- Power modules
- [Personal electronics](#)
- Active filters
- [HVAC: heating, ventilating, and air conditioning](#)
- [Motor control: AC induction](#)
- Low-side current sensing

3 Description

The LMV3xxA family includes single (LMV321A), dual (LMV358A), and quad-channel (LMV324A) low-voltage (2.5V to 5.5V) operational amplifiers (op amps) with rail-to-rail output swing capabilities. These op amps provide a cost-effective solution for space-constrained applications such as large appliances, smoke detectors, and personal electronics where low-voltage operation and high capacitive-load drive are required. The capacitive-load drive of the LMV3xxA family is 500pF, and the resistive open-loop output impedance makes stabilization easier with much higher capacitive loads. These op amps are designed specifically for low-voltage operation (2.5V to 5.5V) with performance specifications similar to the LMV3xx devices.

The robust design of the LMV3xxA family simplifies circuit design. The op amps feature unity-gain stability, an integrated RFI and EMI rejection filter, and no-phase reversal in overdrive conditions.

The LMV3xxA family is available in industry-standard packages such as SOIC, MSOP, SOT-23, and TSSOP packages.

Package Information

PART NUMBER	PACKAGE ⁽¹⁾	PACKAGE SIZE ⁽²⁾
LMV321A	DBV (SOT-23, 5)	2.9mm × 2.8mm
	DCK (SC70, 5)	2mm × 2.1mm
LMV358A	D (SOIC, 8)	4.9mm × 6mm
	DGK (VSSOP, 8)	3mm × 4.9mm
	PW (TSSOP, 8)	3mm × 6.4mm
	DDF (SOT-23, 8)	2.9mm × 2.8mm
	LMV324A	D (SOIC, 14)
	DYY (SOT-23, 14)	4.2mm × 3.26mm
	PW (TSSOP, 14)	5mm × 6.4mm

- (1) For all available packages, see [Section 10](#).
- (2) The package size (length × width) is a nominal value and includes pins, where applicable.

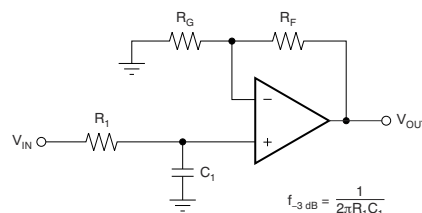

$$\frac{V_{OUT}}{V_{IN}} = \left(1 + \frac{R_F}{R_G}\right) \left(\frac{1}{1 + sR_1C_1}\right)$$

Single-Pole, Low-Pass Filter



Table of Contents

1 Features	1	6.4 Device Functional Modes.....	15
2 Applications	1	7 Application and Implementation	16
3 Description	1	7.1 Application Information.....	16
4 Pin Functions and Configurations	3	7.2 Typical Application.....	16
5 Specifications	5	7.3 Power Supply Recommendations.....	20
5.1 Absolute Maximum Ratings.....	5	7.4 Layout.....	20
5.2 ESD Ratings.....	5	8 Device and Documentation Support	22
5.3 Recommended Operating Conditions.....	5	8.1 Documentation Support.....	22
5.4 Thermal Information: LMV321A.....	6	8.2 Receiving Notification of Documentation Updates....	22
5.5 Thermal Information: LMV358A.....	6	8.3 Support Resources.....	22
5.6 Thermal Information: LMV324A.....	6	8.4 Trademarks.....	22
5.7 Electrical Characteristics.....	7	8.5 Electrostatic Discharge Caution.....	22
5.8 Typical Characteristics.....	8	8.6 Glossary.....	22
6 Detailed Description	14	9 Revision History	22
6.1 Overview.....	14	10 Mechanical, Packaging, and Orderable Information	23
6.2 Functional Block Diagram.....	14		
6.3 Feature Description.....	15		

4 Pin Functions and Configurations

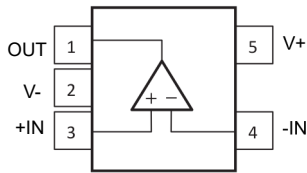

Figure 4-1. LMV321A DBV Package 5-Pin SOT-23 Top View

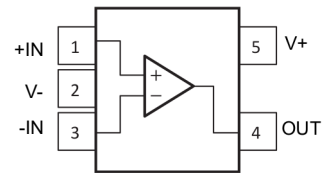

Figure 4-2. LMV321AU DBV, LMV321A DCK Package 5-Pin SOT-23, SC70 Top View

Table 4-1. Pin Functions: LMV321A

PIN			TYPE ⁽¹⁾	DESCRIPTION
NAME	DBV	DBV (U), DCK		
-IN	4	3	I	Inverting input
+IN	3	1	I	Noninverting input
OUT	1	4	O	Output
V-	2	2	—	Negative (lowest) supply or ground (for single-supply operation)
V+	5	5	—	Positive (highest) supply

(1) I = input, O = output

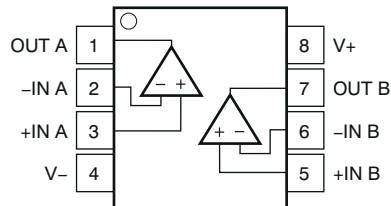

Figure 4-3. LMV358A D, DDF, DGK, or PW Packages, 8-Pin SOIC, SOT-23, VSSOP, or TSSOP (Top View)

Table 4-2. Pin Functions: LMV358A

PIN		TYPE ⁽¹⁾	DESCRIPTION
NAME	NO.		
-IN A	2	I	Inverting input, channel A
+IN A	3	I	Noninverting input, channel A
-IN B	6	I	Inverting input, channel B
+IN B	5	I	Noninverting input, channel B
OUT A	1	O	Output, channel A
OUT B	7	O	Output, channel B
V-	4	—	Negative (lowest) supply or ground (for single-supply operation)
V+	8	—	Positive (highest) supply

(1) I = input, O = output

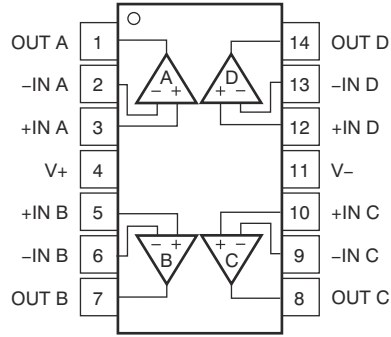

Figure 4-4. LMV324A D, DYY, PW Packages, 14-Pin SOIC, SOT-23, TSSOP (Top View)

Table 4-3. Pin Functions: LMV324A

PIN		TYPE ⁽¹⁾	DESCRIPTION
NAME	NO.		
-IN A	2	I	Inverting input, channel A
+IN A	3	I	Noninverting input, channel A
-IN B	6	I	Inverting input, channel B
+IN B	5	I	Noninverting input, channel B
-IN C	9	I	Inverting input, channel C
+IN C	10	I	Noninverting input, channel C
-IN D	13	I	Inverting input, channel D
+IN D	12	I	Noninverting input, channel D
OUT A	1	O	Output, channel A
OUT B	7	O	Output, channel B
OUT C	8	O	Output, channel C
OUT D	14	O	Output, channel D
V-	11	—	Negative (lowest) supply or ground (for single-supply operation)
V+	4	—	Positive (highest) supply

(1) I = input, O = output

5 Specifications

5.1 Absolute Maximum Ratings

over operating temperature range (unless otherwise noted)⁽¹⁾

		MIN	MAX	UNIT	
Supply voltage, ([V+] – [V–])		0	6	V	
Signal input pins	Voltage ⁽²⁾	Common-mode	(V–) – 0.5	(V+) + 0.5	V
		Differential	(V+) – (V–) + 0.2		V
	Current ⁽²⁾	–10	10	mA	
Output short-circuit ⁽³⁾		Continuous			
Operating, T _A		–55	150	°C	
Operating junction temperature, T _J		150		°C	
Storage temperature, T _{stg}		–65	150	°C	

- (1) Stresses beyond those listed under *Absolute Maximum Ratings* may cause permanent damage to the device. These are stress ratings only, which do not imply functional operation of the device at these or any other conditions beyond those indicated under *Recommended Operating Conditions*. Exposure to absolute-maximum-rated conditions for extended periods may affect device reliability.
- (2) Input pins are diode-clamped to the power-supply rails. Input signals that may swing more than 0.5 V beyond the supply rails must be current limited to 10 mA or less.
- (3) Short-circuit to ground, one amplifier per package.

5.2 ESD Ratings

		VALUE	UNIT
V _(ESD)	Electrostatic discharge	Human-body model (HBM), per ANSI/ESDA/JEDEC JS-001 ⁽¹⁾	±2000
		Charged-device model (CDM), per JEDEC specification JESD22-C101 ⁽²⁾	±1000

- (1) JEDEC document JEP155 states that 500-V HBM allows safe manufacturing with a standard ESD control process.
- (2) JEDEC document JEP157 states that 250-V CDM allows safe manufacturing with a standard ESD control process.

5.3 Recommended Operating Conditions

over operating temperature range (unless otherwise noted)

		MIN	MAX	UNIT
V _S	Supply voltage	2.5	5.5	V
T _A	Specified temperature	–40	125	°C

5.4 Thermal Information: LMV321A

THERMAL METRIC ⁽¹⁾		LMV321A		UNIT
		DBV (SOT-23)	DCK (SC70)	
		5 PINS	5 PINS	
$R_{\theta JA}$	Junction-to-ambient thermal resistance	232.8	239.6	°C/W
$R_{\theta JC(top)}$	Junction-to-case (top) thermal resistance	153.8	148.5	°C/W
$R_{\theta JB}$	Junction-to-board thermal resistance	100.9	82.3	°C/W
ψ_{JT}	Junction-to-top characterization parameter	77.2	54.5	°C/W
ψ_{JB}	Junction-to-board characterization parameter	100.4	81.8	°C/W
$R_{\theta JC(bot)}$	Junction-to-case (bottom) thermal resistance	N/A	N/A	°C/W

(1) For more information about traditional and new thermal metrics, see [Semiconductor and IC Package Thermal Metrics](#).

5.5 Thermal Information: LMV358A

THERMAL METRIC ⁽¹⁾		LMV358A				UNIT
		D (SOIC)	DGK (VSSOP)	PW (TSSOP)	DDF (SOT-23)	
		8 PINS	8 PINS	8 PINS	8 PINS	
$R_{\theta JA}$	Junction-to-ambient thermal resistance	147.4	201.2	205.8	183.7	°C/W
$R_{\theta JC(top)}$	Junction-to-case (top) thermal resistance	94.3	85.7	106.7	112.5	°C/W
$R_{\theta JB}$	Junction-to-board thermal resistance	89.5	122.9	133.9	98.2	°C/W
ψ_{JT}	Junction-to-top characterization parameter	47.3	21.2	34.4	18.8	°C/W
ψ_{JB}	Junction-to-board characterization parameter	89	121.4	132.6	97.6	°C/W

(1) For more information about traditional and new thermal metrics, see [Semiconductor and IC Package Thermal Metrics](#).

5.6 Thermal Information: LMV324A

THERMAL METRIC ⁽¹⁾		LMV324A			UNIT
		D (SOIC)	DYY (SOT-23)	PW (TSSOP)	
		14 PINS	14 PINS	8 PINS	
$R_{\theta JA}$	Junction-to-ambient thermal resistance	102.1	154.3	148.3	°C/W
$R_{\theta JC(top)}$	Junction-to-case (top) thermal resistance	56.8	86.8	68.1	°C/W
$R_{\theta JB}$	Junction-to-board thermal resistance	58.5	67.9	92.7	°C/W
ψ_{JT}	Junction-to-top characterization parameter	20.5	10.1	16.9	°C/W
ψ_{JB}	Junction-to-board characterization parameter	58.1	67.5	91.8	°C/W

5.7 Electrical Characteristics

For $V_S = (V_+) - (V_-) = 2.5\text{ V to }5.5\text{ V}$ ($\pm 1.25\text{ V to } \pm 2.75\text{ V}$), $T_A = 25^\circ\text{C}$, $R_L = 10\text{ k}\Omega$ connected to $V_S / 2$, and $V_{CM} = V_{OUT} = V_S / 2$ (unless otherwise noted)

PARAMETER		TEST CONDITIONS	MIN	TYP	MAX	UNIT
OFFSET VOLTAGE						
V_{OS}	Input offset voltage	$V_S = 5\text{ V}$		± 1	± 4	mV
		$V_S = 5\text{ V}$, $T_A = -40^\circ\text{C to }125^\circ\text{C}$			± 5	
dV_{OS}/dT	V_{OS} vs temperature	$T_A = -40^\circ\text{C to }125^\circ\text{C}$		± 1		$\mu\text{V}/^\circ\text{C}$
PSRR	Power-supply rejection ratio	$V_S = 2.5\text{ to }5.5\text{ V}$, $V_{CM} = (V_-)$	78	100		dB
INPUT VOLTAGE RANGE						
V_{CM}	Common-mode voltage range	No phase reversal, rail-to-rail input	$(V_-) - 0.1$		$(V_+) - 1$	V
CMRR	Common-mode rejection ratio	$V_S = 2.5\text{ V}$, $(V_-) - 0.1\text{ V} < V_{CM} < (V_+) - 1.4\text{ V}$ $T_A = -40^\circ\text{C to }125^\circ\text{C}$		86		dB
		$V_S = 5.5\text{ V}$, $(V_-) - 0.1\text{ V} < V_{CM} < (V_+) - 1.4\text{ V}$ $T_A = -40^\circ\text{C to }125^\circ\text{C}$		95		
		$V_S = 5.5\text{ V}$, $(V_-) - 0.1\text{ V} < V_{CM} < (V_+) + 0.1\text{ V}$ $T_A = -40^\circ\text{C to }125^\circ\text{C}$	63	77		
		$V_S = 2.5\text{ V}$, $(V_-) - 0.1\text{ V} < V_{CM} < (V_+) + 0.1\text{ V}$ $T_A = -40^\circ\text{C to }125^\circ\text{C}$		68		
INPUT BIAS CURRENT						
I_B	Input bias current	$V_S = 5\text{ V}$		± 10		pA
I_{OS}	Input offset current			± 3		pA
NOISE						
E_n	Input voltage noise (peak-to-peak)	$f = 0.1\text{ Hz to }10\text{ Hz}$, $V_S = 5\text{ V}$		5.1		μV_{PP}
e_n	Input voltage noise density	$f = 1\text{ kHz}$, $V_S = 5\text{ V}$		33		$\text{nV}/\sqrt{\text{Hz}}$
		$f = 10\text{ kHz}$, $V_S = 5\text{ V}$		30		
i_n	Input current noise density	$f = 1\text{ kHz}$, $V_S = 5\text{ V}$		25		$\text{fA}/\sqrt{\text{Hz}}$
INPUT CAPACITANCE						
C_{ID}	Differential			1.5		pF
C_{IC}	Common-mode			5		pF
OPEN-LOOP GAIN						
A_{OL}	Open-loop voltage gain	$V_S = 5.5\text{ V}$, $(V_-) + 0.05\text{ V} < V_O < (V_+) - 0.05\text{ V}$, $R_L = 10\text{ k}\Omega$	100	115		dB
		$V_S = 2.5\text{ V}$, $(V_-) + 0.04\text{ V} < V_O < (V_+) - 0.04\text{ V}$, $R_L = 10\text{ k}\Omega$		98		
		$V_S = 2.5\text{ V}$, $(V_-) + 0.1\text{ V} < V_O < (V_+) - 0.1\text{ V}$, $R_L = 2\text{ k}\Omega$		112		
		$V_S = 5.5\text{ V}$, $(V_-) + 0.15\text{ V} < V_O < (V_+) - 0.15\text{ V}$, $R_L = 2\text{ k}\Omega$		128		
FREQUENCY RESPONSE						
GBW	Gain-bandwidth product	$V_S = 5\text{ V}$		1		MHz
ϕ_m	Phase margin	$V_S = 5.5\text{ V}$, $G = 1$		76		$^\circ$
SR	Slew rate	$V_S = 5\text{ V}$		1.7		V/ μs
t_s	Settling time	To 0.1%, $V_S = 5\text{ V}$, 2-V step, $G = +1$, $C_L = 100\text{ pF}$		3		μs
		To 0.01%, $V_S = 5\text{ V}$, 2-V step, $G = +1$, $C_L = 100\text{ pF}$		4		
t_{OR}	Overload recovery time	$V_S = 5\text{ V}$, $V_{IN} \times \text{gain} > V_S$		0.9		μs
THD+N	Total harmonic distortion + noise	$V_S = 5.5\text{ V}$, $V_{CM} = 2.5\text{ V}$, $V_O = 1\text{ V}_{RMS}$, $G = +1$, $f = 1\text{ kHz}$, 80-kHz measurement BW		0.005%		
OUTPUT						
V_O	Voltage output swing from supply rails	$V_S = 5.5\text{ V}$, $R_L = 10\text{ k}\Omega$		20	50	mV
		$V_S = 5.5\text{ V}$, $R_L = 2\text{ k}\Omega$		40	75	
I_{SC}	Short-circuit current	$V_S = 5.5\text{ V}$		± 40		mA
Z_O	Open-loop output impedance	$V_S = 5\text{ V}$, $f = 1\text{ MHz}$		1200		Ω
POWER SUPPLY						
V_S	Specified voltage range		2.5 (± 1.25)		5.5 (± 2.75)	V
I_Q	Quiescent current per amplifier	$I_O = 0\text{ mA}$, $V_S = 5.5\text{ V}$		70	125	μA
		$I_O = 0\text{ mA}$, $V_S = 5.5\text{ V}$, $T_A = -40^\circ\text{C to }125^\circ\text{C}$			150	
	Power-on time	$V_S = 0\text{ V to }5\text{ V}$, to 90% I_Q level		50		μs

5.8 Typical Characteristics

at $T_A = 25^\circ\text{C}$, $V_+ = 2.75\text{ V}$, $V_- = -2.75\text{ V}$, $R_L = 10\text{ k}\Omega$ connected to $V_S / 2$, $V_{CM} = V_S / 2$, and $V_{OUT} = V_S / 2$ (unless otherwise noted)

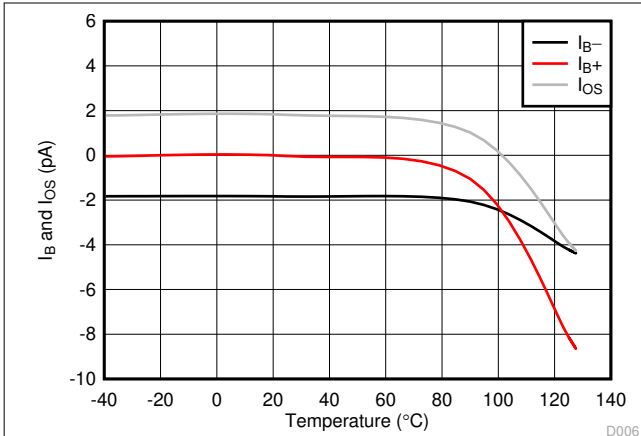

Figure 5-1. I_B and I_{OS} vs Temperature

D006

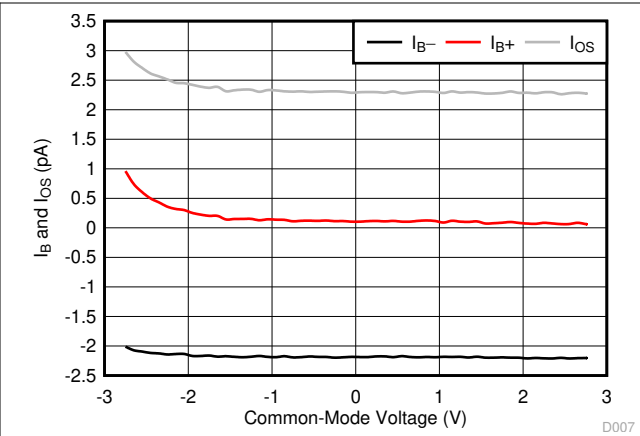

Figure 5-2. I_B and I_{OS} vs Common-Mode Voltage

D007

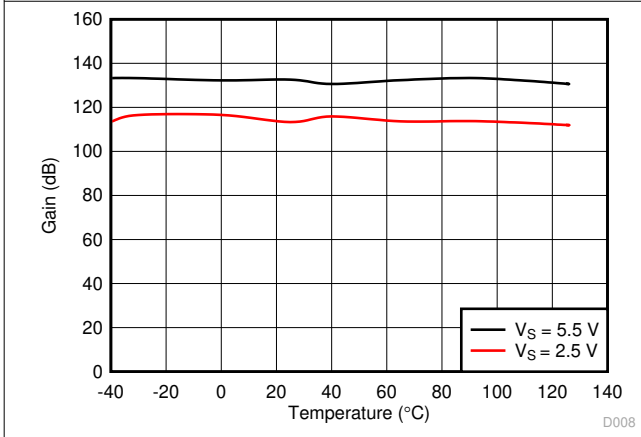

Figure 5-3. Open-Loop Gain vs Temperature

D008

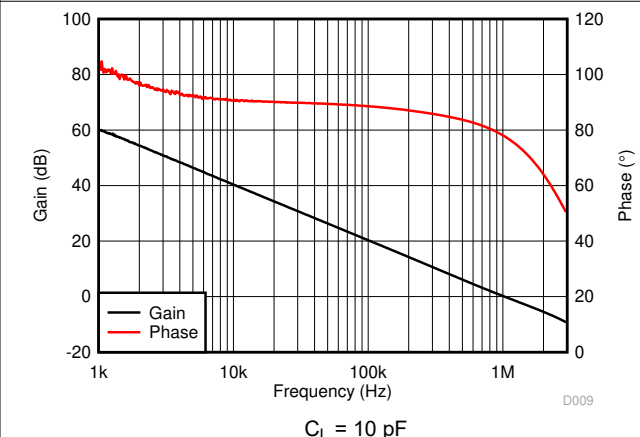

Figure 5-4. Open-Loop Gain and Phase vs Frequency

D009

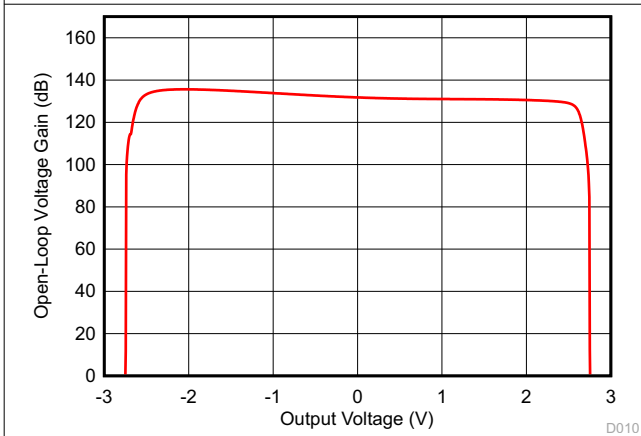

Figure 5-5. Open-Loop Gain vs Output Voltage

D010

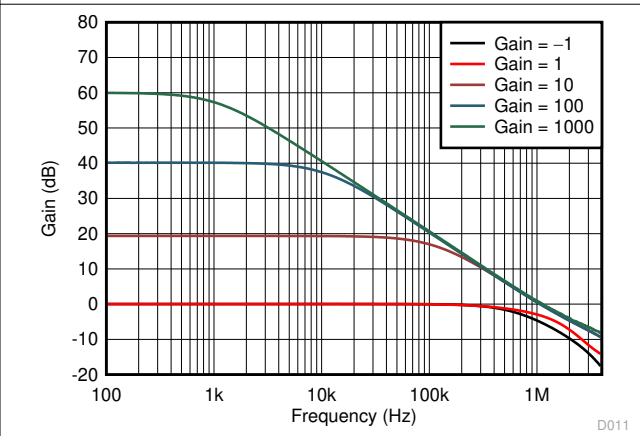

Figure 5-6. Closed-Loop Gain vs Frequency

D011

5.8 Typical Characteristics (continued)

at $T_A = 25^\circ\text{C}$, $V_+ = 2.75\text{ V}$, $V_- = -2.75\text{ V}$, $R_L = 10\text{ k}\Omega$ connected to $V_S / 2$, $V_{CM} = V_S / 2$, and $V_{OUT} = V_S / 2$ (unless otherwise noted)

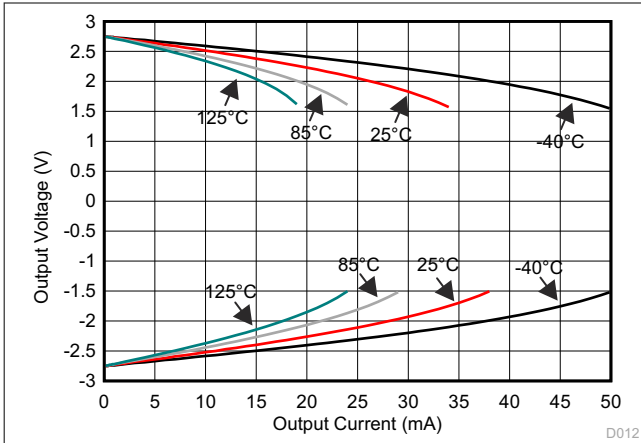

Figure 5-7. Output Voltage vs Output Current (Claw)

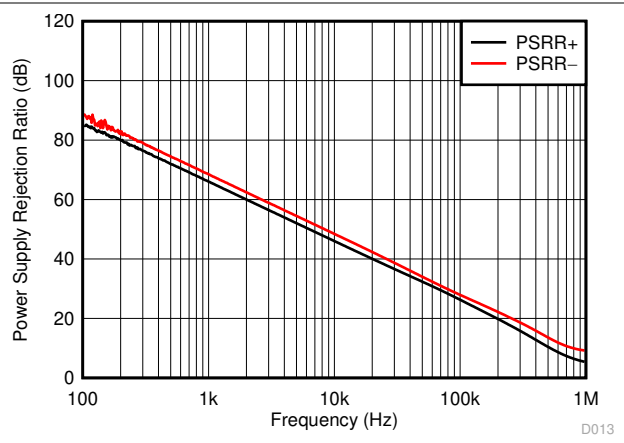

Figure 5-8. PSRR vs Frequency

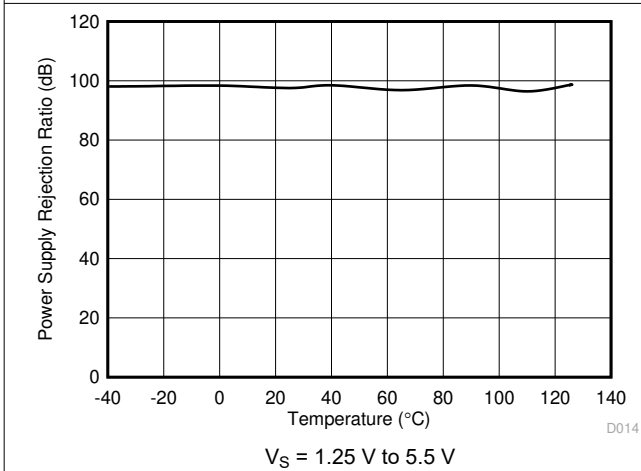

Figure 5-9. DC PSRR vs Temperature

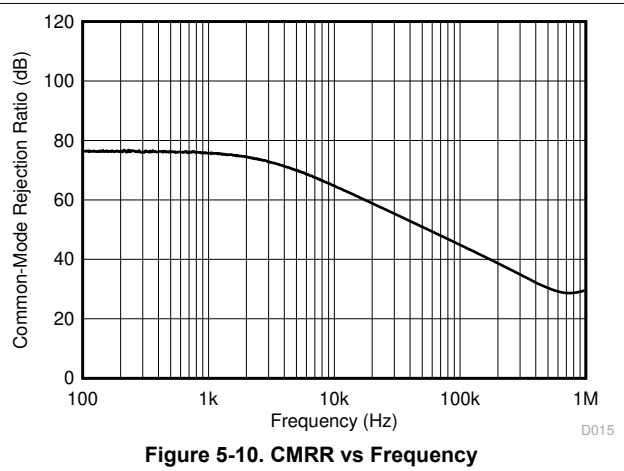
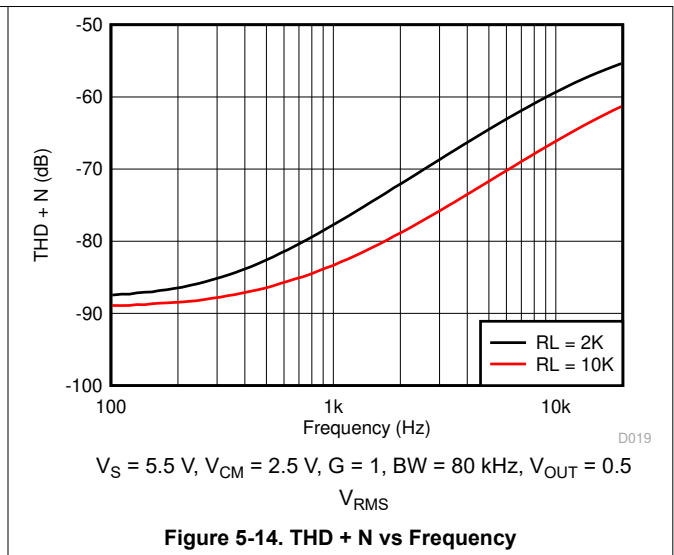
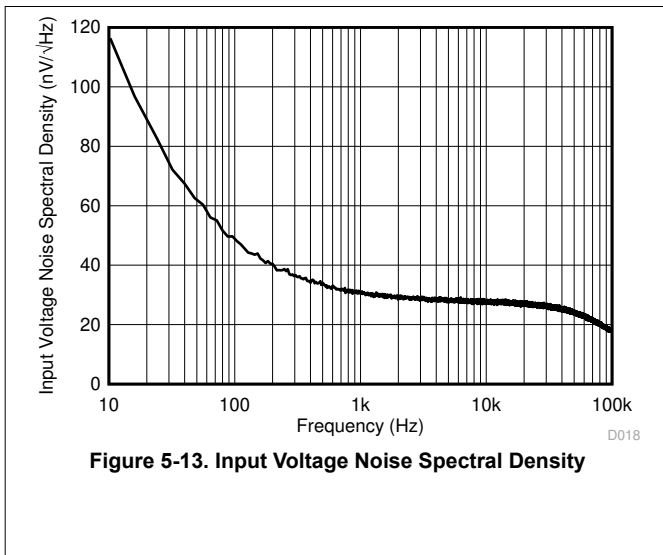
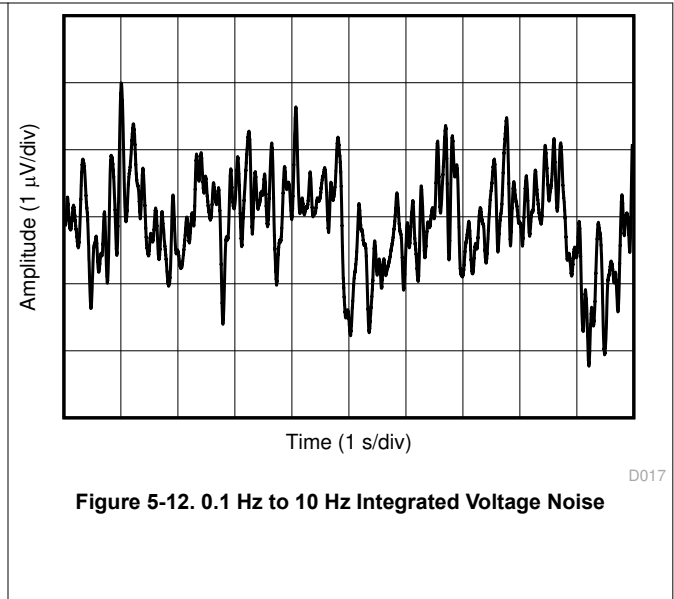
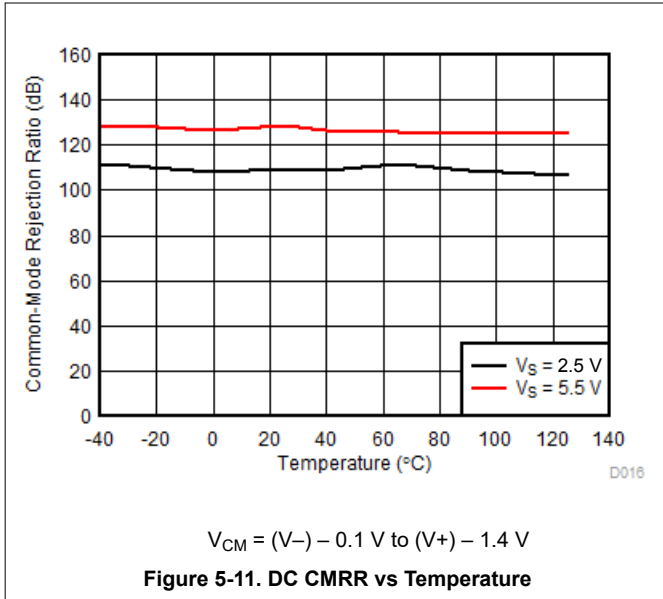

Figure 5-10. CMRR vs Frequency

5.8 Typical Characteristics (continued)

at $T_A = 25^\circ\text{C}$, $V_+ = 2.75\text{ V}$, $V_- = -2.75\text{ V}$, $R_L = 10\text{ k}\Omega$ connected to $V_S / 2$, $V_{CM} = V_S / 2$, and $V_{OUT} = V_S / 2$ (unless otherwise noted)



5.8 Typical Characteristics (continued)

at $T_A = 25^\circ\text{C}$, $V_+ = 2.75\text{ V}$, $V_- = -2.75\text{ V}$, $R_L = 10\text{ k}\Omega$ connected to $V_S / 2$, $V_{CM} = V_S / 2$, and $V_{OUT} = V_S / 2$ (unless otherwise noted)

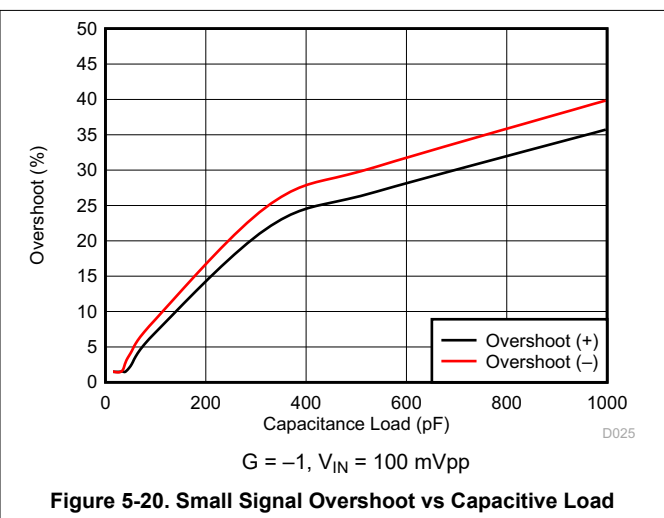
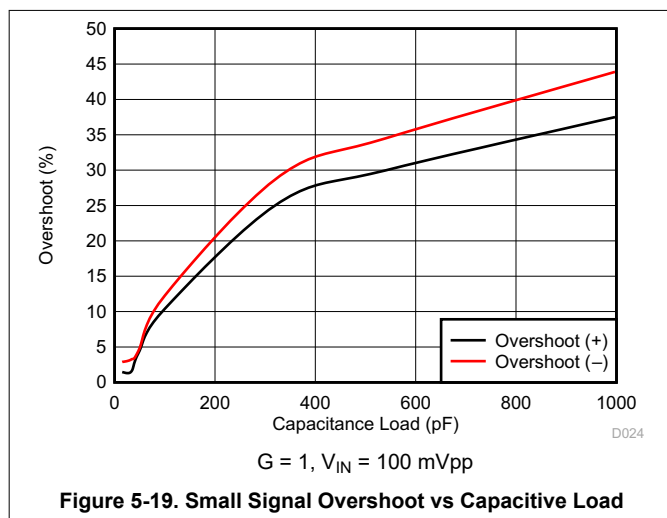
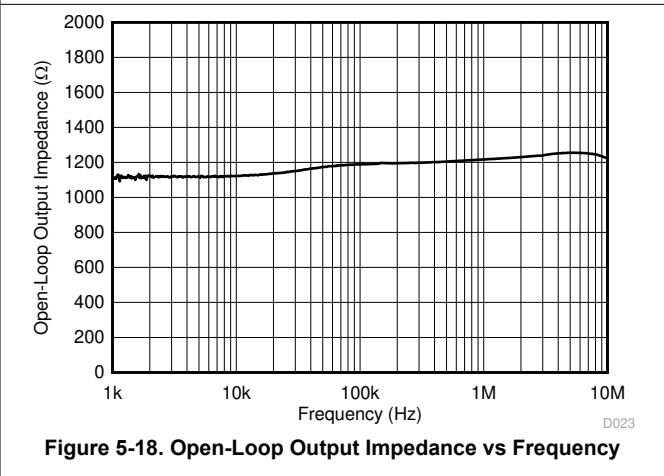
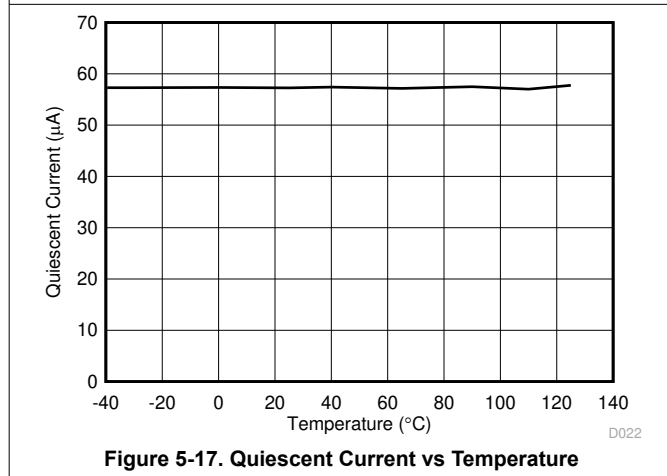
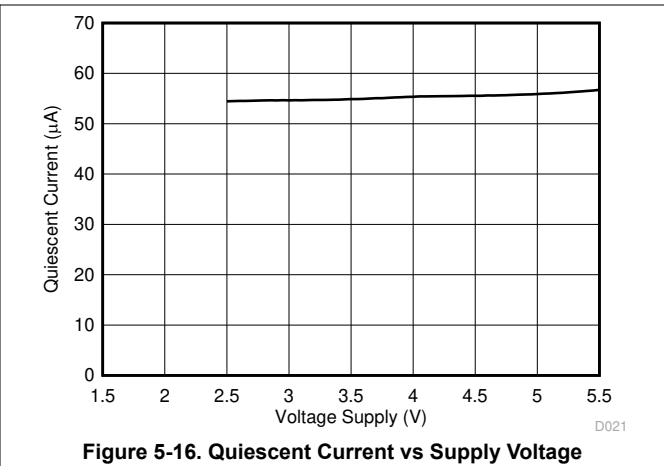
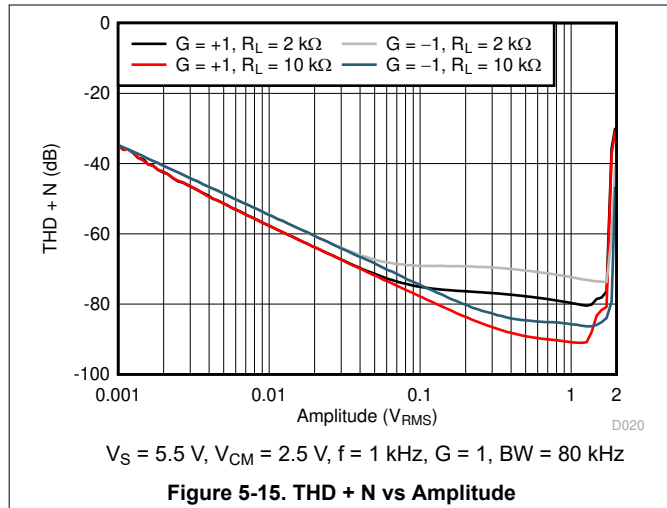

5.8 Typical Characteristics (continued)

at $T_A = 25^\circ\text{C}$, $V_+ = 2.75\text{ V}$, $V_- = -2.75\text{ V}$, $R_L = 10\text{ k}\Omega$ connected to $V_S / 2$, $V_{CM} = V_S / 2$, and $V_{OUT} = V_S / 2$ (unless otherwise noted)

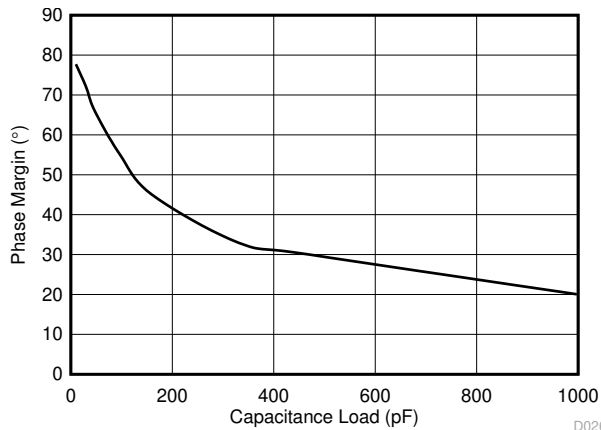
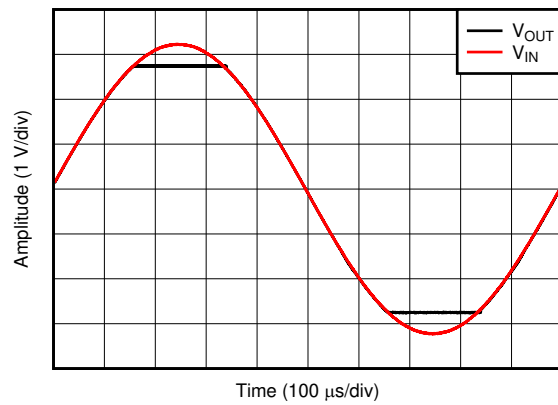

Figure 5-21. Phase Margin vs Capacitive Load

D026



$G = 1$, $V_{IN} = 6.5\text{ V}_{PP}$

Figure 5-22. No Phase Reversal

D027

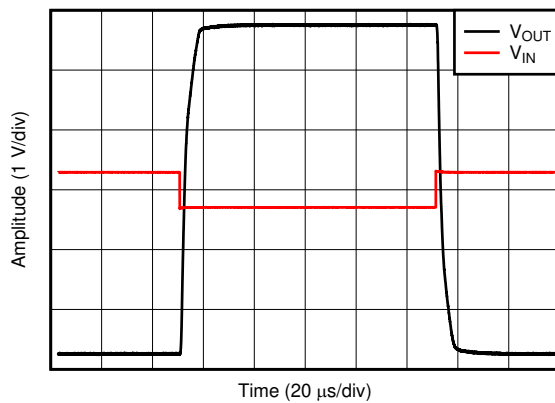

$G = -10$, $V_{IN} = 600\text{ mV}_{PP}$

Figure 5-23. Overload Recovery

D028

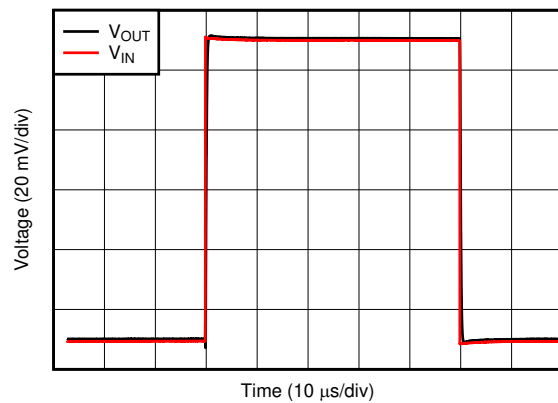

$G = 1$, $V_{IN} = 100\text{ mV}_{PP}$, $C_L = 10\text{ pF}$

Figure 5-24. Small-Signal Step Response

D029

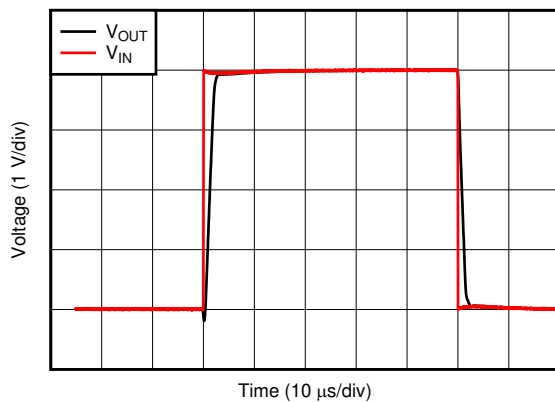

$G = 1$, $V_{IN} = 4\text{ V}_{PP}$, $C_L = 10\text{ pF}$

Figure 5-25. Large-Signal Step Response

D030

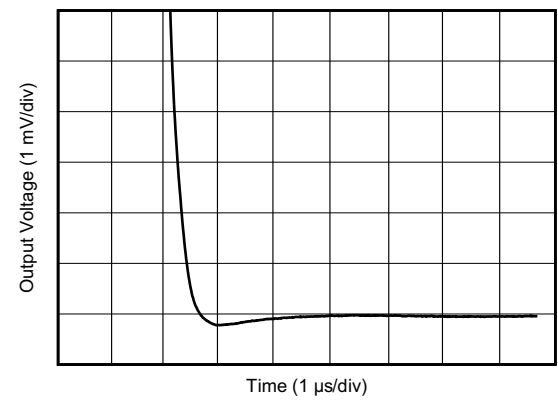

$G = 1$, $C_L = 100\text{ pF}$, 2-V step

Figure 5-26. Large-Signal Settling Time (Negative)

D031

5.8 Typical Characteristics (continued)

at $T_A = 25^\circ\text{C}$, $V_+ = 2.75\text{ V}$, $V_- = -2.75\text{ V}$, $R_L = 10\text{ k}\Omega$ connected to $V_S / 2$, $V_{CM} = V_S / 2$, and $V_{OUT} = V_S / 2$ (unless otherwise noted)

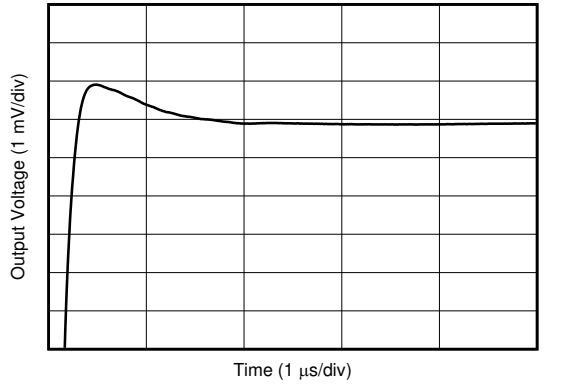

$G = 1$, $C_L = 100\text{ pF}$, 2-V step

Figure 5-27. Large-Signal Settling Time (Positive)

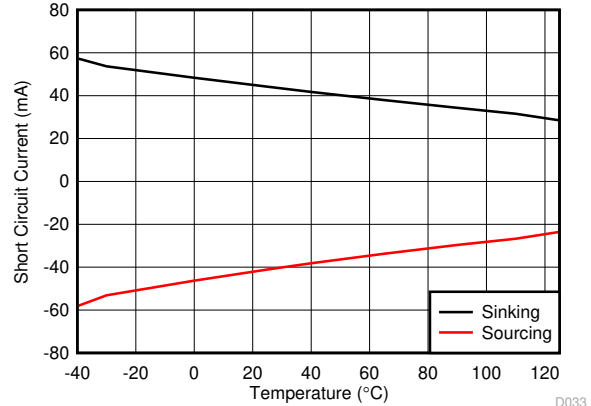

Figure 5-28. Short-Circuit Current vs Temperature

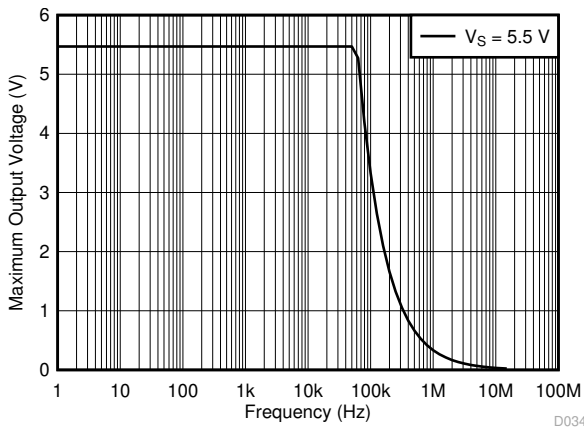

Figure 5-29. Maximum Output Voltage vs Frequency

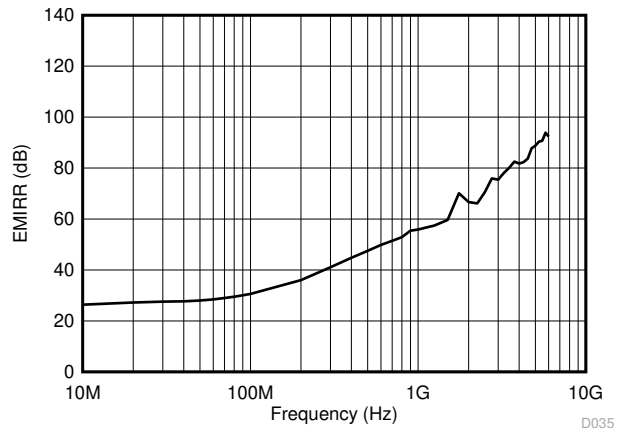

Figure 5-30. Electromagnetic Interference Rejection Ratio Referred to Noninverting Input (EMIRR+) vs Frequency

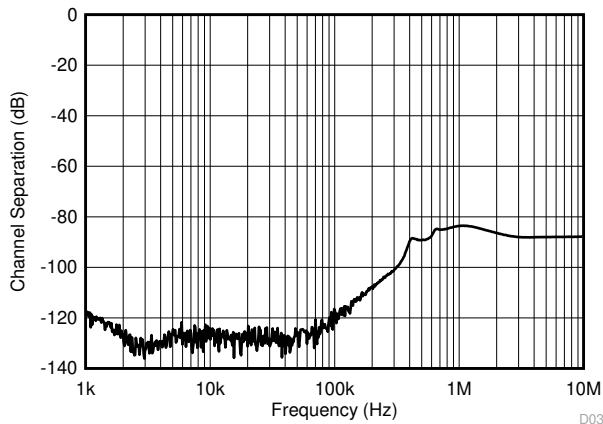

Figure 5-31. Channel Separation

6 Detailed Description

6.1 Overview

The LMV3xxA is a family of low-power, rail-to-rail output op amps. These devices operate from 2.5 V to 5.5 V, are unity-gain stable, and are designed for a wide range of general-purpose applications. The input common-mode voltage range includes the negative rail and allows the LMV3xxA family to be used in many single-supply applications. Rail-to-rail output swing significantly increases dynamic range, especially in low-supply applications, and makes them suitable for driving sampling analog-to-digital converters (ADCs).

6.2 Functional Block Diagram

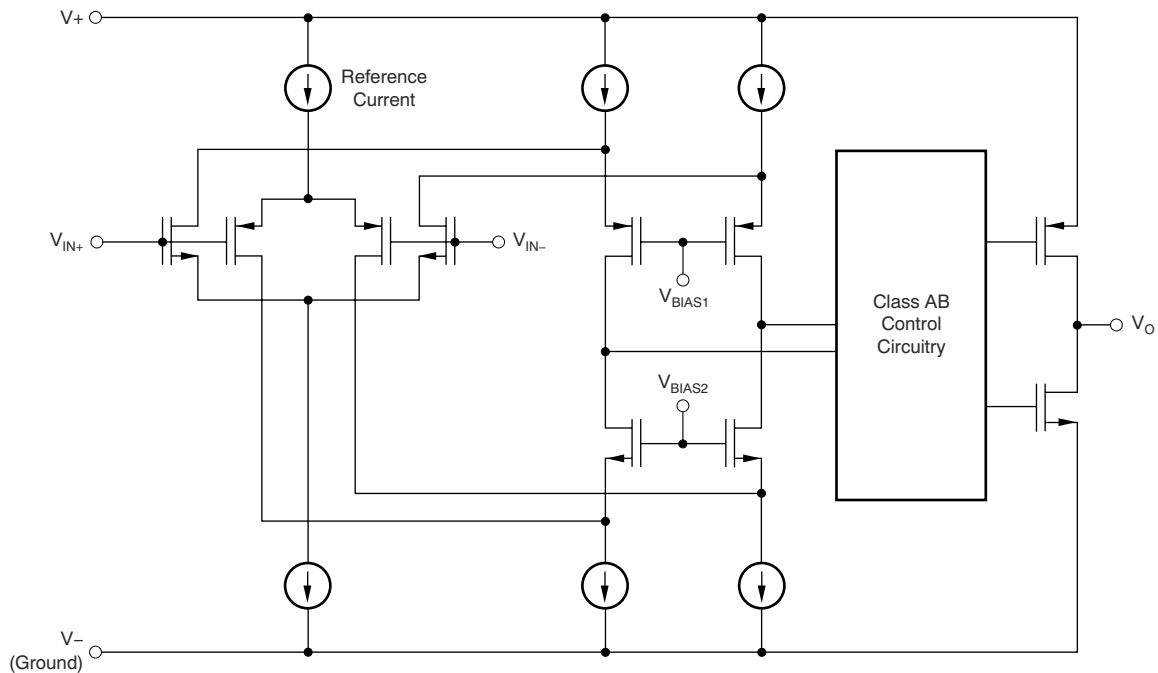

6.3 Feature Description

6.3.1 Operating Voltage

The LMV3xxA family of op amps are for operate from 2.5 V to 5.5 V. In addition, many specifications such as input offset voltage, quiescent current, offset current, and short circuit current apply from -40°C to 125°C . Parameters that vary significantly with operating voltages or temperature are shown in [Section 5.8](#).

6.3.2 Input Common Mode Range

The input common-mode voltage range of the LMV3xxA family extends 100 mV beyond the negative supply rail and within 1 V below the positive rail for the full supply voltage range of 2.5 V to 5.5 V. This performance is achieved with a P-channel differential pair, as shown in the [Functional Block Diagram](#). Additionally, a complementary N-channel differential pair has been included in parallel to eliminate issues with phase reversal that are common with previous generations of op amps. However, the N-channel pair is not optimized for operation. TI recommends limiting any voltages applied at the inputs to less than $V_{\text{CC}} - 1\text{ V}$ to ensure that the op amp conforms to the specifications detailed in the [Electrical Characteristics](#) table.

6.3.3 Rail-to-Rail Output

Designed as a low-power, low-voltage operational amplifier, the LMV3xxA family delivers a robust output drive capability. A class-AB output stage with common-source transistors achieves full rail-to-rail output swing capability. For resistive loads of 10 k Ω , the output swings to within 20 mV of either supply rail, regardless of the applied power-supply voltage. Different load conditions change the ability of the amplifier to swing close to the rails.

6.3.4 Overload Recovery

Overload recovery is defined as the time required for the operational amplifier output to recover from a saturated state to a linear state. The output devices of the operational amplifier enter a saturation region when the output voltage exceeds the rated operating voltage, because of the high input voltage or the high gain. After the device enters the saturation region, the charge carriers in the output devices require time to return to the linear state. After the charge carriers return to the linear state, the device begins to slew at the specified slew rate. Therefore, the propagation delay (in case of an overload condition) is the sum of the overload recovery time and the slew time. The overload recovery time for the LMV3xxA family is approximately 850 ns.

6.4 Device Functional Modes

The LMV3xxA family has a single functional mode. The devices are powered on as long as the power-supply voltage is between 2.5 V ($\pm 1.25\text{ V}$) and 5.5 V ($\pm 2.75\text{ V}$).

7 Application and Implementation

Note

Information in the following applications sections is not part of the TI component specification, and TI does not warrant its accuracy or completeness. TI's customers are responsible for determining suitability of components for their purposes. Customers should validate and test their design implementation to confirm system functionality.

7.1 Application Information

The LMV3xxA family of low-power, rail-to-rail output operational amplifiers is specifically designed for portable applications. The devices operate from 2.5 V to 5.5 V, are unity-gain stable, and are suitable for a wide range of general-purpose applications. The class AB output stage is capable of driving less than or equal to 10-k Ω loads connected to any point between V+ and V-. The input common-mode voltage range includes the negative rail, and allows the LMV3xxA devices to be used in many single-supply applications.

7.2 Typical Application

7.2.1 LMV3xxA Low-Side, Current Sensing Application

Figure 7-1 shows the LMV3xxA configured in a low-side current sensing application.

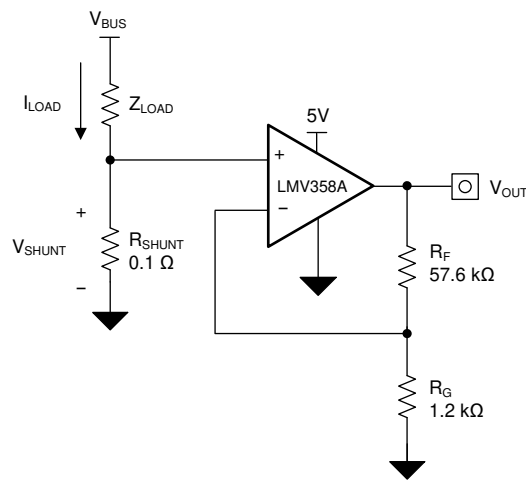

Figure 7-1. LMV3xxA in a Low-Side, Current-Sensing Application

7.2.1.1 Design Requirements

The design requirements for this design are:

- Load current: 0 A to 1 A
- Output voltage: 4.9 V
- Maximum shunt voltage: 100 mV

7.2.1.2 Detailed Design Procedure

The transfer function of the circuit in [Figure 7-1](#) is given in [Equation 1](#).

$$V_{OUT} = I_{LOAD} \times R_{SHUNT} \times Gain \quad (1)$$

The load current (I_{LOAD}) produces a voltage drop across the shunt resistor (R_{SHUNT}). The load current is set from 0 A to 1 A. To keep the shunt voltage below 100 mV at maximum load current, the largest shunt resistor is shown using [Equation 2](#).

$$R_{SHUNT} = \frac{V_{SHUNT_MAX}}{I_{LOAD_MAX}} = \frac{100\text{ mV}}{1\text{ A}} = 100\text{ m}\Omega \quad (2)$$

Using [Equation 2](#), R_{SHUNT} is calculated to be 100 m Ω . The voltage drop produced by I_{LOAD} and R_{SHUNT} is amplified by the LMV3xxA to produce an output voltage of approximately 0 V to 4.9 V. The gain needed by the LMV3xxA to produce the necessary output voltage is calculated using [Equation 3](#).

$$Gain = \frac{(V_{OUT_MAX} - V_{OUT_MIN})}{(V_{IN_MAX} - V_{IN_MIN})} \quad (3)$$

Using [Equation 3](#), the required gain is calculated to be 49 V/V, which is set with resistors R_F and R_G . [Equation 4](#) sizes the resistors R_F and R_G , to set the gain of the LMV3xxA to 49 V/V.

$$Gain = 1 + \frac{(R_F)}{(R_G)} \quad (4)$$

Selecting R_F as 57.6 k Ω and R_G as 1.2 k Ω provides a combination that equals 49 V/V. [Figure 7-2](#) shows the measured transfer function of the circuit shown in [Figure 7-1](#). Notice that the gain is only a function of the feedback and gain resistors. This gain is adjusted by varying the ratio of the resistors and the actual resistors values are determined by the impedance levels that the designer wants to establish. The impedance level determines the current drain, the effect that stray capacitance has, and a few other behaviors. There is no optimal impedance selection that works for every system, you must choose an impedance that is ideal for your system parameters.

7.2.1.3 Application Curve

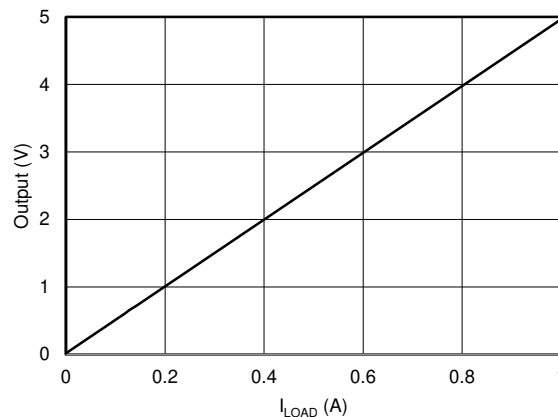

Figure 7-2. Low-Side, Current-Sense Transfer Function

7.2.2 Single-Supply Photodiode Amplifier

Photodiodes are used in many applications to convert light signals to electrical signals. The current through the photodiode is proportional to the photon energy absorbed, and is commonly in the range of a few hundred picoamps to a few tens of microamps. An amplifier in a transimpedance configuration is typically used to convert the low-level photodiode current to a voltage signal for processing in an MCU. The circuit shown in Figure 7-3 is an example of a single-supply photodiode amplifier circuit using the LMV358A.

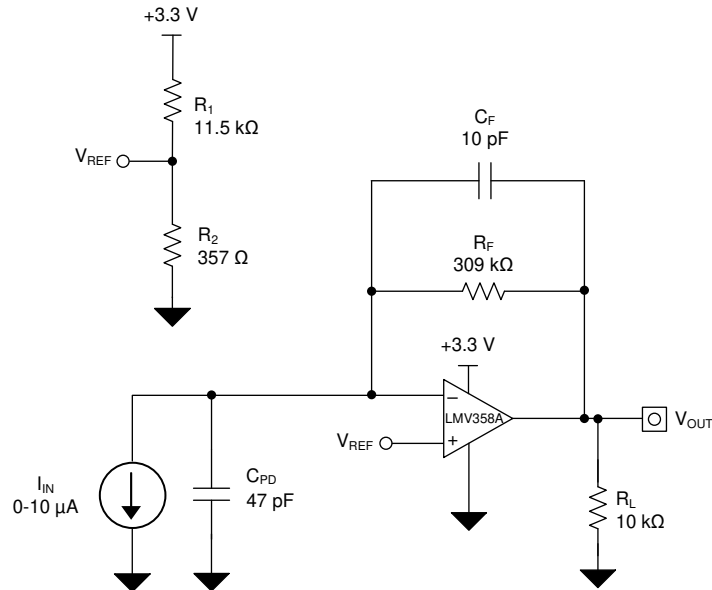

Figure 7-3. Single-Supply Photodiode Amplifier Circuit

7.2.2.1 Design Requirements

The design requirements for this design are:

- Supply voltage: 3.3 V
- Input: 0 μ A to 10 μ A
- Output: 0.1 V to 3.2 V
- Bandwidth: 50 kHz

7.2.2.2 Detailed Design Procedure

The transfer function between the output voltage (V_{OUT}), the input current, (I_{IN}) and the reference voltage (V_{REF}) is defined in [Equation 5](#).

$$V_{OUT} = I_{IN} \times R_F + V_{REF} \quad (5)$$

Where:

$$V_{REF} = V_+ \times \left(\frac{R_1 \times R_2}{R_1 + R_2} \right) \quad (6)$$

Set V_{REF} to 100 mV to meet the minimum output voltage level by setting R1 and R2 to meet the required ratio calculated in [Equation 7](#).

$$\frac{V_{REF}}{V_+} = \frac{0.1 V}{3.3 V} = 0.0303 \quad (7)$$

The closest resistor ratio to meet this ratio sets R1 to 11.5 k Ω and R2 to 357 Ω .

The required feedback resistance can be calculated based on the input current and desired output voltage.

$$R_F = \frac{V_{OUT} - V_{REF}}{I_{IN}} = \frac{3.2 V - 0.1 V}{10 \mu A} = 310 \frac{kV}{A} \approx 309 k\Omega \quad (8)$$

Calculate the value for the feedback capacitor based on R_F and the desired -3 -dB bandwidth, (f_{-3dB}) using [Equation 9](#).

$$C_F = \frac{1}{2 \times \pi \times R_F \times f_{-3 dB}} = \frac{1}{2 \times \pi \times 309 k\Omega \times 50 kHz} = 10.3 pF \approx 10 pF \quad (9)$$

The minimum op amp bandwidth required for this application is based on the value of R_F , C_F , and the capacitance on the INx– pin of the LMV358A which is equal to the sum of the photodiode shunt capacitance, (CPD) the common-mode input capacitance, (CCM) and the differential input capacitance (CD) as [Equation 10](#) shows.

$$C_{IN} = C_{PD} + C_{CM} + C_D = 47 pF + 5 pF + 1 pF = 53 pF \quad (10)$$

The minimum op amp bandwidth is calculated in [Equation 11](#).

$$f = BGW \geq \frac{C_{IN} + C_F}{2 \times \pi \times R_F \times C_F^2} \geq 324 kHz \quad (11)$$

The 1-MHz bandwidth of the LMV3xxA meets the minimum bandwidth requirement and remains stable in this application configuration.

7.2.2.3 Application Curves

The measured current-to-voltage transfer function for the photodiode amplifier circuit is shown in Figure 7-4. The measured performance of the photodiode amplifier circuit is shown in Figure 7-5.

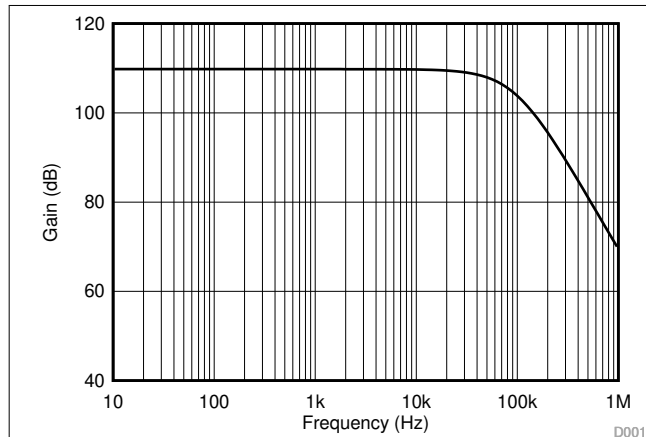

Figure 7-4. Photodiode Amplifier Circuit AC Gain Results

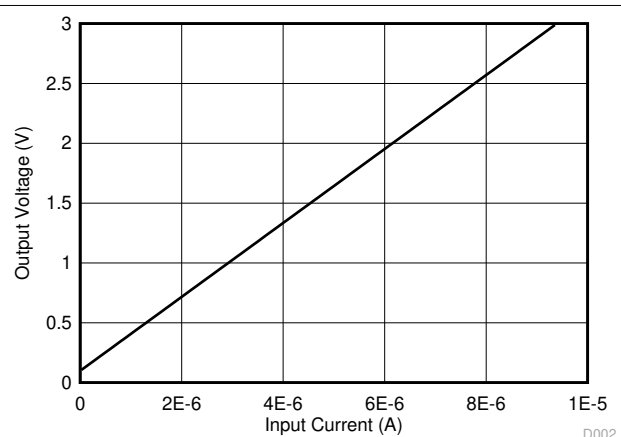

Figure 7-5. Photodiode Amplifier Circuit DC Results

7.3 Power Supply Recommendations

The LMV3xxA family is specified for operation from 2.5 V to 5.5 V (± 1.25 V to ± 2.75 V); many specifications apply from -40°C to 125°C . Section 5.8 presents parameters that may exhibit significant variance with regard to operating voltage or temperature.

CAUTION

Supply voltages larger than 6 V may permanently damage the device; see Section 5.1.

Place 0.1- μF bypass capacitors close to the power-supply pins to reduce coupling errors from noisy or high-impedance power supplies. For more detailed information on bypass capacitor placement, see Section 7.4.1.

7.3.1 Input and ESD Protection

The LMV3xxA family incorporates internal ESD protection circuits on all pins. For input and output pins, this protection primarily consists of current-steering diodes connected between the input and power-supply pins. These ESD protection diodes provide in-circuit, input overdrive protection, as long as the current is limited to 10 mA. Figure 7-6 shows how a series input resistor can be added to the driven input to limit the input current. The added resistor contributes thermal noise at the amplifier input and the value must be kept to a minimum in noise-sensitive applications.

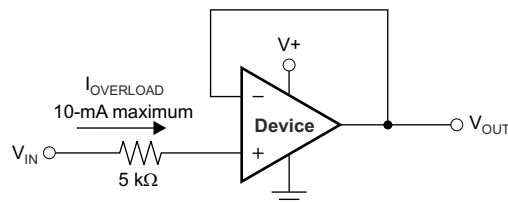

Figure 7-6. Input Current Protection

7.4 Layout

7.4.1 Layout Guidelines

For best operational performance of the device, use good printed circuit board (PCB) layout practices, including:

- Noise can propagate into analog circuitry through the power connections of the board and propagate to the power pins of the op amp itself. Bypass capacitors are used to reduce the coupled noise by providing a low-impedance path to ground.
 - Connect low-ESR, 0.1- μF ceramic bypass capacitors between each supply pin and ground, placed as close to the device as possible. A single bypass capacitor from V_+ to ground is adequate for single-supply applications.
- Separate grounding for analog and digital portions of circuitry is one of the simplest and most effective methods of noise suppression. One or more layers on multilayer PCBs are usually devoted to ground planes. A ground plane helps distribute heat and reduces electromagnetic interference (EMI) noise pickup. Take care to physically separate digital and analog grounds, paying attention to the flow of the ground current.
- To reduce parasitic coupling, run the input traces as far away from the supply or output traces as possible. If these traces cannot be kept separate, crossing the sensitive trace at a 90 degree angle is much better as opposed to running the traces in parallel with the noisy trace.
- Place the external components as close to the device as possible, as shown in Figure 7-8. Keeping R_F and R_G close to the inverting input minimizes parasitic capacitance.
- Keep the length of input traces as short as possible. Remember that the input traces are the most sensitive part of the circuit.
- Consider a driven, low-impedance guard ring around the critical traces. A guard ring may significantly reduce leakage currents from nearby traces that are at different potentials.
- Cleaning the PCB following board assembly is recommended for best performance.
- Any precision integrated circuit can experience performance shifts resulting from moisture ingress into the plastic package. Following any aqueous PCB cleaning process, baking the PCB assembly is recommended to remove moisture introduced into the device packaging during the cleaning process. A low-temperature, post-cleaning bake at 85°C for 30 minutes is sufficient for most circumstances.

7.4.2 Layout Example

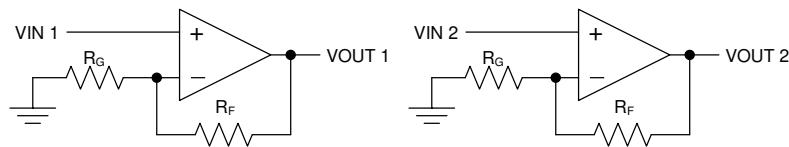

Figure 7-7. Schematic Representation

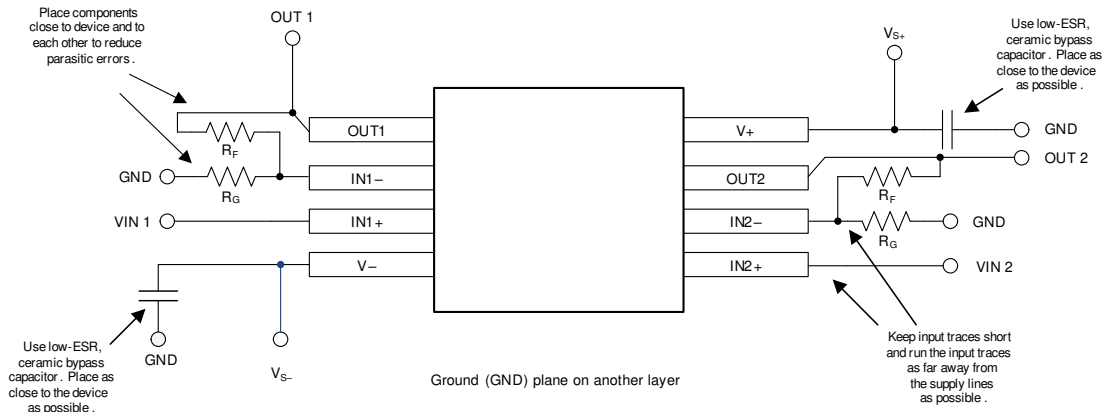

Figure 7-8. Layout Example

8 Device and Documentation Support

8.1 Documentation Support

8.1.1 Related Documentation

For related documentation, see the following:

- Texas Instruments, [EMI Rejection Ratio of Operational Amplifiers application note](#)

8.2 Receiving Notification of Documentation Updates

To receive notification of documentation updates, navigate to the device product folder on ti.com. Click on *Notifications* to register and receive a weekly digest of any product information that has changed. For change details, review the revision history included in any revised document.

8.3 Support Resources

TI E2E™ support forums are an engineer's go-to source for fast, verified answers and design help — straight from the experts. Search existing answers or ask your own question to get the quick design help you need.

Linked content is provided "AS IS" by the respective contributors. They do not constitute TI specifications and do not necessarily reflect TI's views; see TI's [Terms of Use](#).

8.4 Trademarks

TI E2E™ is a trademark of Texas Instruments.
 All trademarks are the property of their respective owners.

8.5 Electrostatic Discharge Caution



This integrated circuit can be damaged by ESD. Texas Instruments recommends that all integrated circuits be handled with appropriate precautions. Failure to observe proper handling and installation procedures can cause damage.

ESD damage can range from subtle performance degradation to complete device failure. Precision integrated circuits may be more susceptible to damage because very small parametric changes could cause the device not to meet its published specifications.

8.6 Glossary

[TI Glossary](#) This glossary lists and explains terms, acronyms, and definitions.

9 Revision History

NOTE: Page numbers for previous revisions may differ from page numbers in the current version.

Changes from Revision H (April 2023) to Revision I (July 2024)	Page
• Changed the <i>Device Information</i> table to <i>Package Information</i>	1
• Added LMV321A and LMV321AU variant names to the DBV pinouts in <i>Pin Configuration and Functions</i>	3
• Changed <i>Electrical Characteristics</i> table description from: $V_S = (V+) - (V-) = 2.5\text{ V to }5.5\text{ V } (\pm 0.9\text{ V to } \pm 2.75\text{ V})$, $T_A = 25^\circ\text{C}$, $R_L = 10\text{ k}\Omega$ connected to $V_S / 2$, and $V_{CM} = V_{OUT} = V_S / 2$ (unless otherwise noted) to: $V_S = (V+) - (V-) = 2.5\text{ V to }5.5\text{ V } (\pm 1.25\text{ V to } \pm 2.75\text{ V})$, $T_A = 25^\circ\text{C}$, $R_L = 10\text{ k}\Omega$ connected to $V_S / 2$, and $V_{CM} = V_{OUT} = V_S / 2$ (unless otherwise noted).....	7

Changes from Revision G (February 2022) to Revision H (April 2023)	Page
• Updated test condition of <i>Electrical Characteristics</i> table from " $V_S = (V+) - (V-) = 2.5\text{ V to }5.5\text{ V } (\pm 0.9\text{ V to } \pm 2.75\text{ V})$ " to " $V_S = (V+) - (V-) = 2.5\text{ V to }5.5\text{ V } (\pm 1.25\text{ V to } \pm 2.75\text{ V})$ ".....	7
• Updated <i>Typical Characteristics</i> section.....	8

Changes from Revision F (January 2020) to Revision G (February 2022)	Page
• Updated the numbering format for tables, figures, and cross-references throughout the document.	1
• Added SOT-23 (DYY) package to <i>Description</i> section.....	1
• Added SOT-23 (DYY) package information to <i>Pin Configuration and Functions</i> section.....	3
• Added SOT-23 (DYY) package to <i>Thermal Information: LMV324A</i>	6

Changes from Revision E (September 2019) to Revision F (January 2020)	Page
• Added SOT-23 (U) package information to <i>Pin Configuration and Functions</i> section.....	3

10 Mechanical, Packaging, and Orderable Information

The following pages include mechanical, packaging, and orderable information. This information is the most-current data available for the designated devices. This data is subject to change without notice and without revision of this document. For browser-based versions of this data sheet, see the left-hand navigation pane.

PACKAGING INFORMATION

Orderable Device	Status (1)	Package Type	Package Drawing	Pins	Package Qty	Eco Plan (2)	Lead finish/ Ball material (6)	MSL Peak Temp (3)	Op Temp (°C)	Device Marking (4/5)	Samples
LMV321AIDBVR	ACTIVE	SOT-23	DBV	5	3000	RoHS & Green	NIPDAU SN	Level-1-260C-UNLIM	-40 to 125	1OIF	Samples
LMV321AIDCKR	ACTIVE	SC70	DCK	5	3000	RoHS & Green	SN	Level-2-260C-1 YEAR	-40 to 125	1C2	Samples
LMV321AUIDBVR	ACTIVE	SOT-23	DBV	5	3000	RoHS & Green	NIPDAU SN	Level-1-260C-UNLIM	-40 to 125	1WOF	Samples
LMV324AIDR	ACTIVE	SOIC	D	14	2500	RoHS & Green	NIPDAU	Level-2-260C-1 YEAR	-40 to 125	LMV324	Samples
LMV324AIDYYR	ACTIVE	SOT-23-THIN	DYY	14	3000	RoHS & Green	NIPDAU	Level-1-260C-UNLIM	-40 to 125	LM324I	Samples
LMV324AIPWR	ACTIVE	TSSOP	PW	14	2000	RoHS & Green	NIPDAU SN	Level-2-260C-1 YEAR	-40 to 125	LMV324A	Samples
LMV358AIDDFR	ACTIVE	SOT-23-THIN	DDF	8	3000	RoHS & Green	NIPDAU	Level-1-260C-UNLIM	-40 to 125	358A	Samples
LMV358AIDGKR	ACTIVE	VSSOP	DGK	8	2500	RoHS & Green	NIPDAU SN NIPDAUAG	Level-2-260C-1 YEAR	-40 to 125	1MAX	Samples
LMV358AIDGKT	ACTIVE	VSSOP	DGK	8	250	RoHS & Green	NIPDAU SN NIPDAUAG	Level-2-260C-1 YEAR	-40 to 125	1MAX	Samples
LMV358AIDR	ACTIVE	SOIC	D	8	2500	RoHS & Green	NIPDAU SN	Level-2-260C-1 YEAR	-40 to 125	MV358A	Samples
LMV358AIPWR	ACTIVE	TSSOP	PW	8	2000	RoHS & Green	NIPDAU SN	Level-2-260C-1 YEAR	-40 to 125	LMV358	Samples

(1) The marketing status values are defined as follows:

ACTIVE: Product device recommended for new designs.

LIFEBUY: TI has announced that the device will be discontinued, and a lifetime-buy period is in effect.

NRND: Not recommended for new designs. Device is in production to support existing customers, but TI does not recommend using this part in a new design.

PREVIEW: Device has been announced but is not in production. Samples may or may not be available.

OBSELETE: TI has discontinued the production of the device.

(2) **RoHS:** TI defines "RoHS" to mean semiconductor products that are compliant with the current EU RoHS requirements for all 10 RoHS substances, including the requirement that RoHS substance do not exceed 0.1% by weight in homogeneous materials. Where designed to be soldered at high temperatures, "RoHS" products are suitable for use in specified lead-free processes. TI may reference these types of products as "Pb-Free".

RoHS Exempt: TI defines "RoHS Exempt" to mean products that contain lead but are compliant with EU RoHS pursuant to a specific EU RoHS exemption.

Green: TI defines "Green" to mean the content of Chlorine (Cl) and Bromine (Br) based flame retardants meet JS709B low halogen requirements of <=1000ppm threshold. Antimony trioxide based flame retardants must also meet the <=1000ppm threshold requirement.

(3) MSL, Peak Temp. - The Moisture Sensitivity Level rating according to the JEDEC industry standard classifications, and peak solder temperature.

(4) There may be additional marking, which relates to the logo, the lot trace code information, or the environmental category on the device.

(5) Multiple Device Markings will be inside parentheses. Only one Device Marking contained in parentheses and separated by a "~" will appear on a device. If a line is indented then it is a continuation of the previous line and the two combined represent the entire Device Marking for that device.

(6) Lead finish/Ball material - Orderable Devices may have multiple material finish options. Finish options are separated by a vertical ruled line. Lead finish/Ball material values may wrap to two lines if the finish value exceeds the maximum column width.

Important Information and Disclaimer:The information provided on this page represents TI's knowledge and belief as of the date that it is provided. TI bases its knowledge and belief on information provided by third parties, and makes no representation or warranty as to the accuracy of such information. Efforts are underway to better integrate information from third parties. TI has taken and continues to take reasonable steps to provide representative and accurate information but may not have conducted destructive testing or chemical analysis on incoming materials and chemicals. TI and TI suppliers consider certain information to be proprietary, and thus CAS numbers and other limited information may not be available for release.

In no event shall TI's liability arising out of such information exceed the total purchase price of the TI part(s) at issue in this document sold by TI to Customer on an annual basis.

OTHER QUALIFIED VERSIONS OF LMV321A, LMV324A, LMV358A :

- Automotive : [LMV321A-Q1](#), [LMV324A-Q1](#), [LMV358A-Q1](#)

NOTE: Qualified Version Definitions:

- Automotive - Q100 devices qualified for high-reliability automotive applications targeting zero defects

TAPE AND REEL INFORMATION

QUADRANT ASSIGNMENTS FOR PIN 1 ORIENTATION IN TAPE

*All dimensions are nominal

Device	Package Type	Package Drawing	Pins	SPQ	Reel Diameter (mm)	Reel Width W1 (mm)	A0 (mm)	B0 (mm)	K0 (mm)	P1 (mm)	W (mm)	Pin1 Quadrant
LMV321AIDBVR	SOT-23	DBV	5	3000	180.0	8.4	3.2	3.2	1.4	4.0	8.0	Q3
LMV321AIDBVR	SOT-23	DBV	5	3000	180.0	8.4	3.2	3.2	1.4	4.0	8.0	Q3
LMV321AIDCKR	SC70	DCK	5	3000	180.0	8.4	2.3	2.5	1.2	4.0	8.0	Q3
LMV321AUIDBVR	SOT-23	DBV	5	3000	180.0	8.4	3.2	3.2	1.4	4.0	8.0	Q3
LMV321AUIDBVR	SOT-23	DBV	5	3000	180.0	8.4	3.2	3.2	1.4	4.0	8.0	Q3
LMV321AUIDBVR	SOT-23	DBV	5	3000	180.0	8.4	3.2	3.2	1.4	4.0	8.0	Q3
LMV324AIDR	SOIC	D	14	2500	330.0	16.4	6.5	9.0	2.1	8.0	16.0	Q1
LMV324AIDYYR	SOT-23-THIN	DYY	14	3000	330.0	12.4	4.8	3.6	1.6	8.0	12.0	Q3
LMV324AIPWR	TSSOP	PW	14	2000	330.0	12.4	6.9	5.6	1.6	8.0	12.0	Q1
LMV358AIDDFR	SOT-23-THIN	DDF	8	3000	180.0	8.4	3.2	3.2	1.4	4.0	8.0	Q3
LMV358AIDGKR	VSSOP	DGK	8	2500	330.0	12.4	5.3	3.4	1.4	8.0	12.0	Q1
LMV358AIDGKT	VSSOP	DGK	8	250	330.0	12.4	5.3	3.4	1.4	8.0	12.0	Q1
LMV358AIDR	SOIC	D	8	2500	330.0	12.4	6.4	5.2	2.1	8.0	12.0	Q1
LMV358AIPWR	TSSOP	PW	8	2000	330.0	12.4	7.0	3.6	1.6	8.0	12.0	Q1

TAPE AND REEL BOX DIMENSIONS

*All dimensions are nominal

Device	Package Type	Package Drawing	Pins	SPQ	Length (mm)	Width (mm)	Height (mm)
LMV321AIDBVR	SOT-23	DBV	5	3000	210.0	185.0	35.0
LMV321AIDBVR	SOT-23	DBV	5	3000	210.0	185.0	35.0
LMV321AIDCKR	SC70	DCK	5	3000	210.0	185.0	35.0
LMV321AUIDBVR	SOT-23	DBV	5	3000	210.0	185.0	35.0
LMV321AUIDBVR	SOT-23	DBV	5	3000	210.0	185.0	35.0
LMV321AUIDBVR	SOT-23	DBV	5	3000	210.0	185.0	35.0
LMV324AIDR	SOIC	D	14	2500	356.0	356.0	35.0
LMV324AIDYYR	SOT-23-THIN	DYY	14	3000	336.6	336.6	31.8
LMV324AIPWR	TSSOP	PW	14	2000	353.0	353.0	32.0
LMV358AIDDFR	SOT-23-THIN	DDF	8	3000	210.0	185.0	35.0
LMV358AIDGKR	VSSOP	DGK	8	2500	356.0	356.0	35.0
LMV358AIDGKT	VSSOP	DGK	8	250	356.0	356.0	35.0
LMV358AIDR	SOIC	D	8	2500	356.0	356.0	35.0
LMV358AIPWR	TSSOP	PW	8	2000	356.0	356.0	35.0



D0014A

PACKAGE OUTLINE

SOIC - 1.75 mm max height

SMALL OUTLINE INTEGRATED CIRCUIT



4220718/A 09/2016

NOTES:

1. All linear dimensions are in millimeters. Dimensions in parenthesis are for reference only. Dimensioning and tolerancing per ASME Y14.5M.
2. This drawing is subject to change without notice.
3. This dimension does not include mold flash, protrusions, or gate burrs. Mold flash, protrusions, or gate burrs shall not exceed 0.15 mm, per side.
4. This dimension does not include interlead flash. Interlead flash shall not exceed 0.43 mm, per side.
5. Reference JEDEC registration MS-012, variation AB.

EXAMPLE BOARD LAYOUT

D0014A

SOIC - 1.75 mm max height

SMALL OUTLINE INTEGRATED CIRCUIT



LAND PATTERN EXAMPLE
SCALE:8X



SOLDER MASK DETAILS

4220718/A 09/2016

NOTES: (continued)

- 6. Publication IPC-7351 may have alternate designs.
- 7. Solder mask tolerances between and around signal pads can vary based on board fabrication site.

EXAMPLE STENCIL DESIGN

D0014A

SOIC - 1.75 mm max height

SMALL OUTLINE INTEGRATED CIRCUIT



SOLDER PASTE EXAMPLE
BASED ON 0.125 mm THICK STENCIL
SCALE:8X

4220718/A 09/2016

NOTES: (continued)

8. Laser cutting apertures with trapezoidal walls and rounded corners may offer better paste release. IPC-7525 may have alternate design recommendations.
9. Board assembly site may have different recommendations for stencil design.

DDF0008A



PACKAGE OUTLINE

SOT-23-THIN - 1.1 mm max height

PLASTIC SMALL OUTLINE

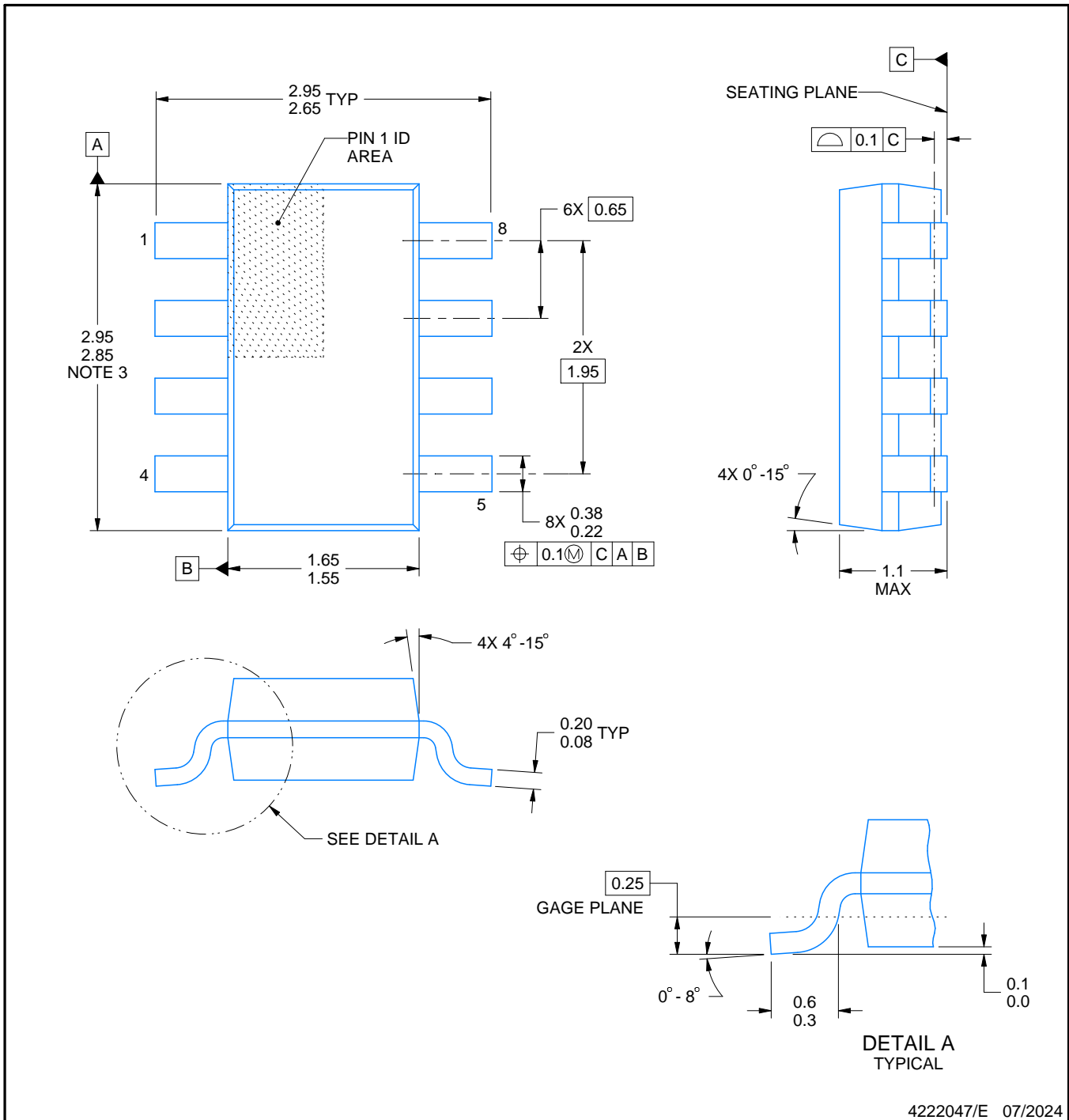

4222047/E 07/2024

NOTES:

1. All linear dimensions are in millimeters. Any dimensions in parenthesis are for reference only. Dimensioning and tolerancing per ASME Y14.5M.
2. This drawing is subject to change without notice.
3. This dimension does not include mold flash, protrusions, or gate burrs. Mold flash, protrusions, or gate burrs shall not exceed 0.15 mm per side.

EXAMPLE BOARD LAYOUT

DDF0008A

SOT-23-THIN - 1.1 mm max height

PLASTIC SMALL OUTLINE

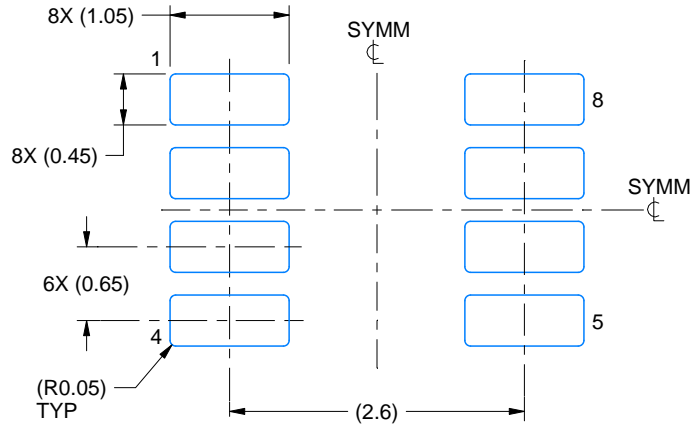

LAND PATTERN EXAMPLE
EXPOSED METAL SHOWN
SCALE:15X

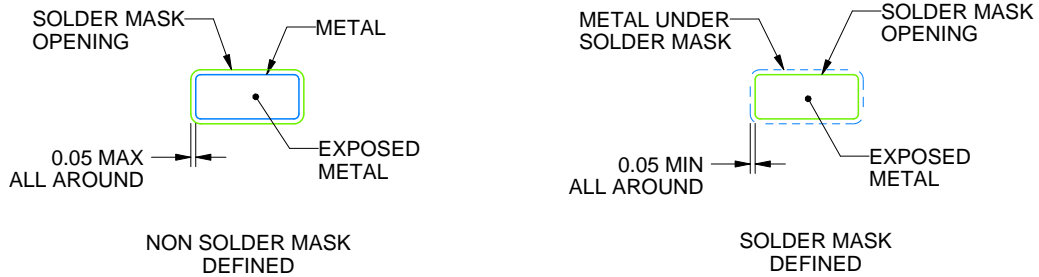

SOLDER MASK DETAILS

4222047/E 07/2024

NOTES: (continued)

- 4. Publication IPC-7351 may have alternate designs.
- 5. Solder mask tolerances between and around signal pads can vary based on board fabrication site.

EXAMPLE STENCIL DESIGN

DDF0008A

SOT-23-THIN - 1.1 mm max height

PLASTIC SMALL OUTLINE



SOLDER PASTE EXAMPLE
BASED ON 0.125 mm THICK STENCIL
SCALE:15X

4222047/E 07/2024

NOTES: (continued)

6. Laser cutting apertures with trapezoidal walls and rounded corners may offer better paste release. IPC-7525 may have alternate design recommendations.
7. Board assembly site may have different recommendations for stencil design.



D0008A

PACKAGE OUTLINE

SOIC - 1.75 mm max height

SMALL OUTLINE INTEGRATED CIRCUIT



4214825/C 02/2019

NOTES:

1. Linear dimensions are in inches [millimeters]. Dimensions in parenthesis are for reference only. Controlling dimensions are in inches. Dimensioning and tolerancing per ASME Y14.5M.
2. This drawing is subject to change without notice.
3. This dimension does not include mold flash, protrusions, or gate burrs. Mold flash, protrusions, or gate burrs shall not exceed $.006$ [0.15] per side.
4. This dimension does not include interlead flash.
5. Reference JEDEC registration MS-012, variation AA.

EXAMPLE BOARD LAYOUT

D0008A

SOIC - 1.75 mm max height

SMALL OUTLINE INTEGRATED CIRCUIT



LAND PATTERN EXAMPLE
 EXPOSED METAL SHOWN
 SCALE:8X



SOLDER MASK DETAILS

4214825/C 02/2019

NOTES: (continued)

- 6. Publication IPC-7351 may have alternate designs.
- 7. Solder mask tolerances between and around signal pads can vary based on board fabrication site.

EXAMPLE STENCIL DESIGN

D0008A

SOIC - 1.75 mm max height

SMALL OUTLINE INTEGRATED CIRCUIT



SOLDER PASTE EXAMPLE
BASED ON .005 INCH [0.125 MM] THICK STENCIL
SCALE:8X

4214825/C 02/2019

NOTES: (continued)

8. Laser cutting apertures with trapezoidal walls and rounded corners may offer better paste release. IPC-7525 may have alternate design recommendations.
9. Board assembly site may have different recommendations for stencil design.

DCK0005A



PACKAGE OUTLINE

SOT - 1.1 max height

SMALL OUTLINE TRANSISTOR

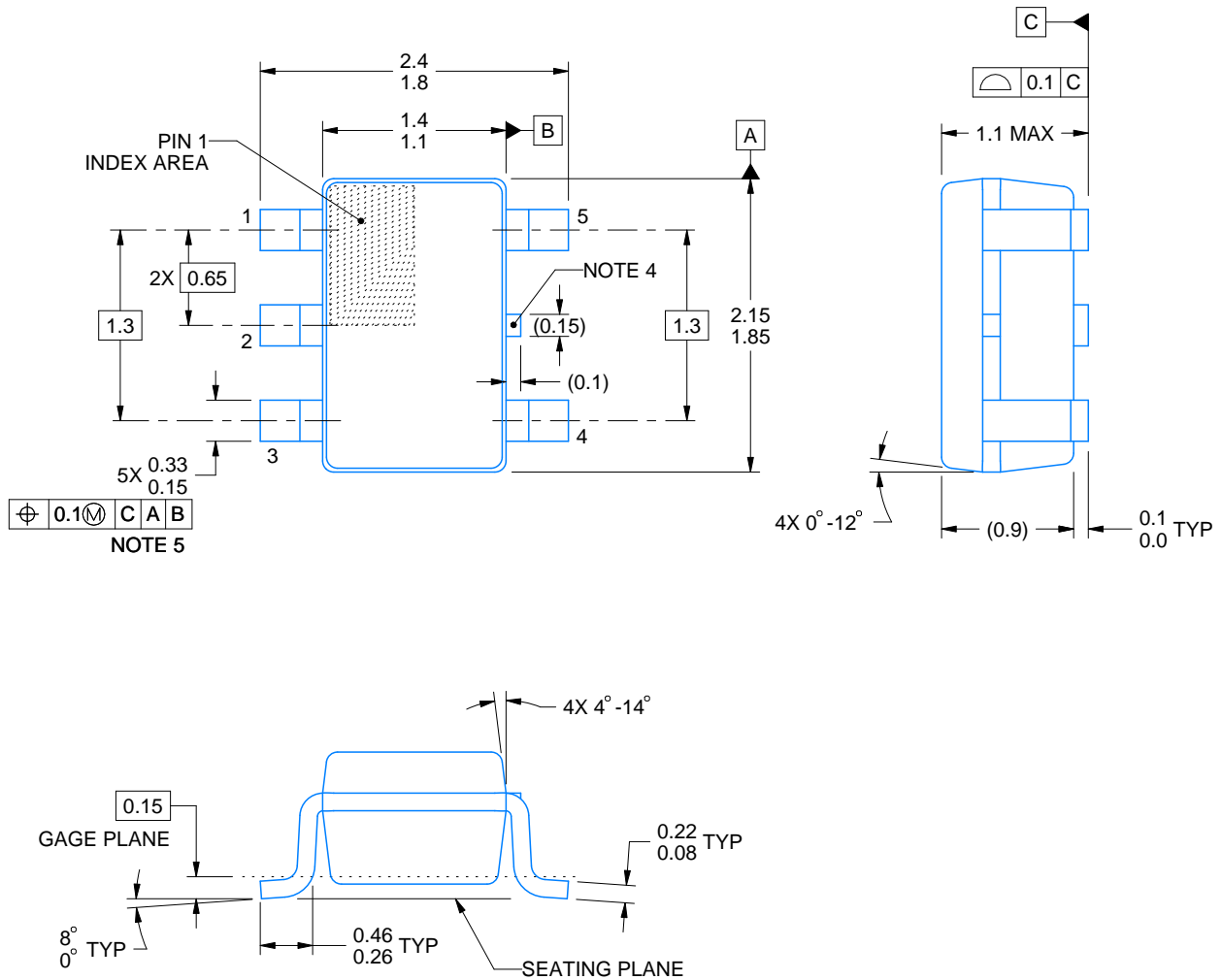

4214834/F 08/2024

NOTES:

1. All linear dimensions are in millimeters. Any dimensions in parenthesis are for reference only. Dimensioning and tolerancing per ASME Y14.5M.
2. This drawing is subject to change without notice.
3. Reference JEDEC MO-203.
4. Support pin may differ or may not be present.
5. Lead width does not comply with JEDEC.
6. Body dimensions do not include mold flash, protrusions, or gate burrs. Mold flash, protrusions, or gate burrs shall not exceed 0.25mm per side

EXAMPLE BOARD LAYOUT

DCK0005A

SOT - 1.1 max height

SMALL OUTLINE TRANSISTOR

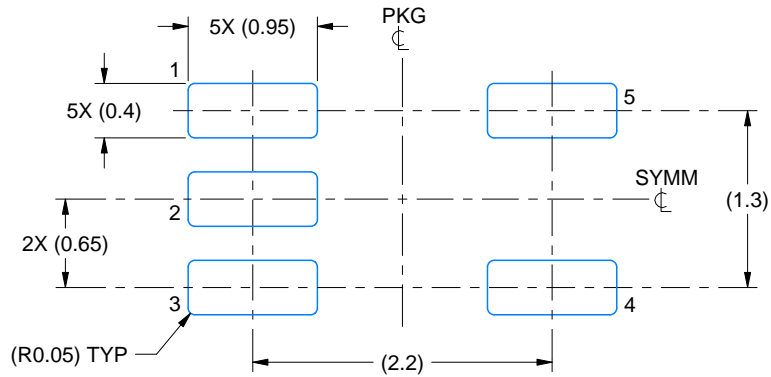

LAND PATTERN EXAMPLE
EXPOSED METAL SHOWN
SCALE:18X

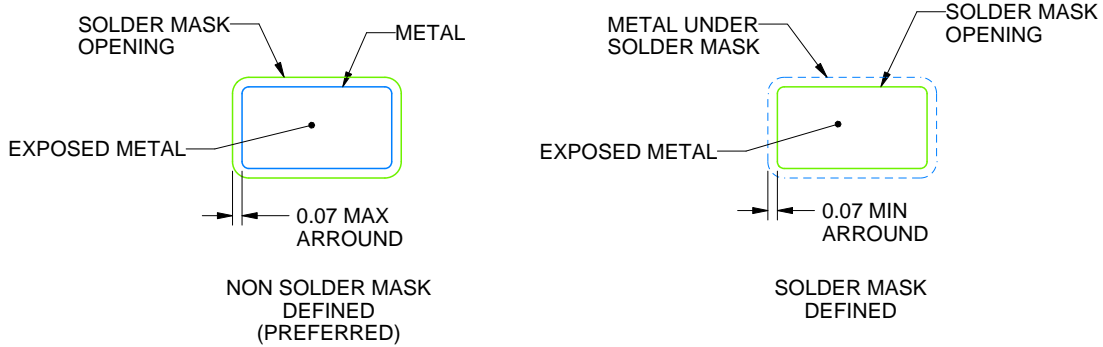

SOLDER MASK DETAILS

4214834/F 08/2024

NOTES: (continued)

- 7. Publication IPC-7351 may have alternate designs.
- 8. Solder mask tolerances between and around signal pads can vary based on board fabrication site.

EXAMPLE STENCIL DESIGN

DCK0005A

SOT - 1.1 max height

SMALL OUTLINE TRANSISTOR

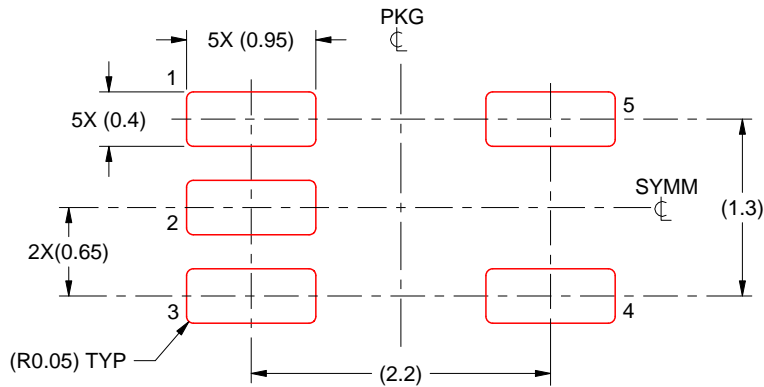

SOLDER PASTE EXAMPLE
BASED ON 0.125 THICK STENCIL
SCALE:18X

4214834/F 08/2024

NOTES: (continued)

9. Laser cutting apertures with trapezoidal walls and rounded corners may offer better paste release. IPC-7525 may have alternate design recommendations.
10. Board assembly site may have different recommendations for stencil design.

PW0014A



PACKAGE OUTLINE

TSSOP - 1.2 mm max height

SMALL OUTLINE PACKAGE



4220202/B 12/2023

NOTES:

1. All linear dimensions are in millimeters. Any dimensions in parenthesis are for reference only. Dimensioning and tolerancing per ASME Y14.5M.
2. This drawing is subject to change without notice.
3. This dimension does not include mold flash, protrusions, or gate burrs. Mold flash, protrusions, or gate burrs shall not exceed 0.15 mm per side.
4. This dimension does not include interlead flash. Interlead flash shall not exceed 0.25 mm per side.
5. Reference JEDEC registration MO-153.

EXAMPLE BOARD LAYOUT

PW0014A

TSSOP - 1.2 mm max height

SMALL OUTLINE PACKAGE



LAND PATTERN EXAMPLE
EXPOSED METAL SHOWN
SCALE: 10X



4220202/B 12/2023

NOTES: (continued)

- 6. Publication IPC-7351 may have alternate designs.
- 7. Solder mask tolerances between and around signal pads can vary based on board fabrication site.

EXAMPLE STENCIL DESIGN

PW0014A

TSSOP - 1.2 mm max height

SMALL OUTLINE PACKAGE



SOLDER PASTE EXAMPLE
BASED ON 0.125 mm THICK STENCIL
SCALE: 10X

4220202/B 12/2023

NOTES: (continued)

8. Laser cutting apertures with trapezoidal walls and rounded corners may offer better paste release. IPC-7525 may have alternate design recommendations.
9. Board assembly site may have different recommendations for stencil design.

PW0008A



PACKAGE OUTLINE
TSSOP - 1.2 mm max height

SMALL OUTLINE PACKAGE



4221848/A 02/2015

NOTES:

1. All linear dimensions are in millimeters. Any dimensions in parenthesis are for reference only. Dimensioning and tolerancing per ASME Y14.5M.
2. This drawing is subject to change without notice.
3. This dimension does not include mold flash, protrusions, or gate burrs. Mold flash, protrusions, or gate burrs shall not exceed 0.15 mm per side.
4. This dimension does not include interlead flash. Interlead flash shall not exceed 0.25 mm per side.
5. Reference JEDEC registration MO-153, variation AA.

EXAMPLE BOARD LAYOUT

PW0008A

TSSOP - 1.2 mm max height

SMALL OUTLINE PACKAGE



LAND PATTERN EXAMPLE
SCALE:10X



SOLDER MASK DETAILS
NOT TO SCALE

4221848/A 02/2015

NOTES: (continued)

- 6. Publication IPC-7351 may have alternate designs.
- 7. Solder mask tolerances between and around signal pads can vary based on board fabrication site.

EXAMPLE STENCIL DESIGN

PW0008A

TSSOP - 1.2 mm max height

SMALL OUTLINE PACKAGE



SOLDER PASTE EXAMPLE
BASED ON 0.125 mm THICK STENCIL
SCALE:10X

4221848/A 02/2015

NOTES: (continued)

8. Laser cutting apertures with trapezoidal walls and rounded corners may offer better paste release. IPC-7525 may have alternate design recommendations.
9. Board assembly site may have different recommendations for stencil design.

DBV0005A



PACKAGE OUTLINE

SOT-23 - 1.45 mm max height

SMALL OUTLINE TRANSISTOR

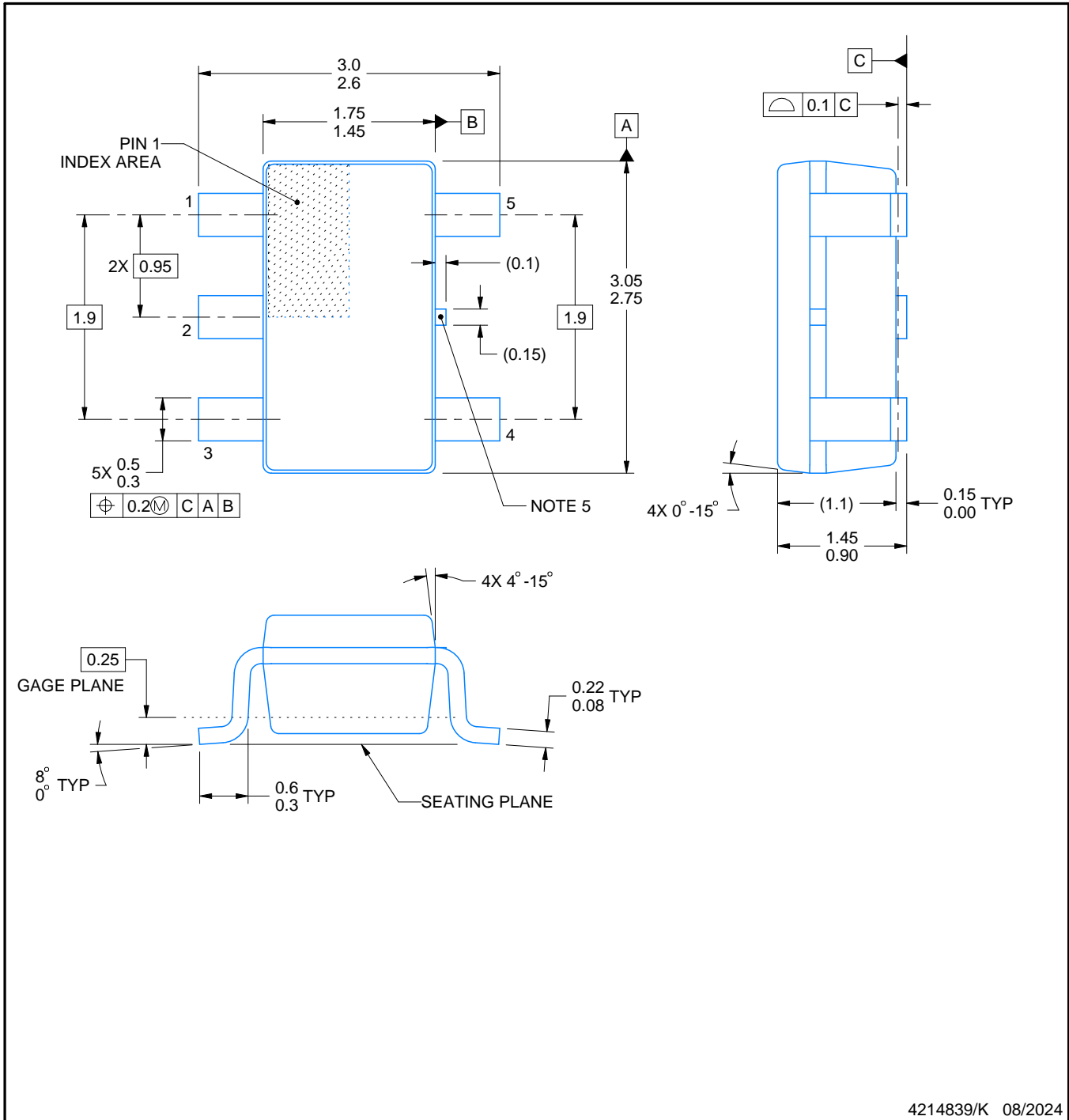

NOTES:

1. All linear dimensions are in millimeters. Any dimensions in parenthesis are for reference only. Dimensioning and tolerancing per ASME Y14.5M.
2. This drawing is subject to change without notice.
3. Reference JEDEC MO-178.
4. Body dimensions do not include mold flash, protrusions, or gate burrs. Mold flash, protrusions, or gate burrs shall not exceed 0.25 mm per side.
5. Support pin may differ or may not be present.

EXAMPLE BOARD LAYOUT

DBV0005A

SOT-23 - 1.45 mm max height

SMALL OUTLINE TRANSISTOR



LAND PATTERN EXAMPLE
EXPOSED METAL SHOWN
SCALE:15X

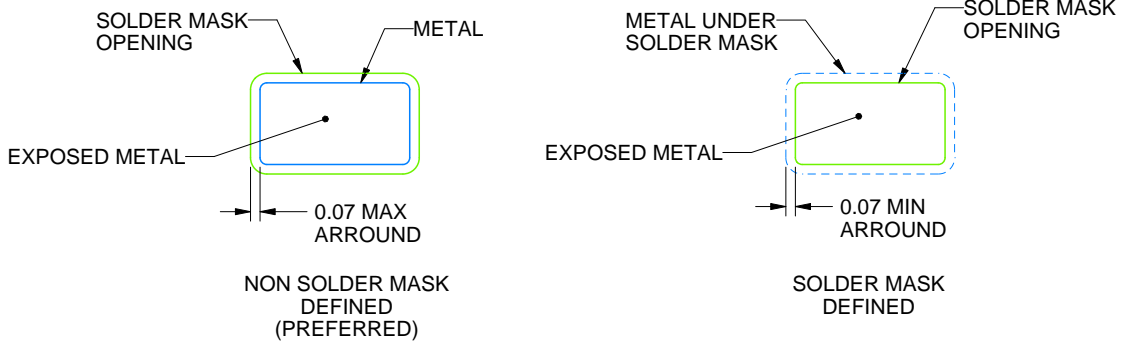

SOLDER MASK DETAILS

4214839/K 08/2024

NOTES: (continued)

- 6. Publication IPC-7351 may have alternate designs.
- 7. Solder mask tolerances between and around signal pads can vary based on board fabrication site.

EXAMPLE STENCIL DESIGN

DBV0005A

SOT-23 - 1.45 mm max height

SMALL OUTLINE TRANSISTOR



SOLDER PASTE EXAMPLE
BASED ON 0.125 mm THICK STENCIL
SCALE:15X

4214839/K 08/2024

NOTES: (continued)

8. Laser cutting apertures with trapezoidal walls and rounded corners may offer better paste release. IPC-7525 may have alternate design recommendations.
9. Board assembly site may have different recommendations for stencil design.

DGK0008A



PACKAGE OUTLINE

VSSOP - 1.1 mm max height

SMALL OUTLINE PACKAGE



4214862/A 04/2023

NOTES:

PowerPAD is a trademark of Texas Instruments.

1. All linear dimensions are in millimeters. Any dimensions in parenthesis are for reference only. Dimensioning and tolerancing per ASME Y14.5M.
2. This drawing is subject to change without notice.
3. This dimension does not include mold flash, protrusions, or gate burrs. Mold flash, protrusions, or gate burrs shall not exceed 0.15 mm per side.
4. This dimension does not include interlead flash. Interlead flash shall not exceed 0.25 mm per side.
5. Reference JEDEC registration MO-187.

EXAMPLE BOARD LAYOUT

DGK0008A

™ VSSOP - 1.1 mm max height

SMALL OUTLINE PACKAGE



LAND PATTERN EXAMPLE
EXPOSED METAL SHOWN
SCALE: 15X



SOLDER MASK DETAILS

4214862/A 04/2023

NOTES: (continued)

6. Publication IPC-7351 may have alternate designs.
7. Solder mask tolerances between and around signal pads can vary based on board fabrication site.
8. Vias are optional depending on application, refer to device data sheet. If any vias are implemented, refer to their locations shown on this view. It is recommended that vias under paste be filled, plugged or tented.
9. Size of metal pad may vary due to creepage requirement.

EXAMPLE STENCIL DESIGN

DGK0008A

TM VSSOP - 1.1 mm max height

SMALL OUTLINE PACKAGE



SOLDER PASTE EXAMPLE
SCALE: 15X

4214862/A 04/2023

NOTES: (continued)

11. Laser cutting apertures with trapezoidal walls and rounded corners may offer better paste release. IPC-7525 may have alternate design recommendations.
12. Board assembly site may have different recommendations for stencil design.

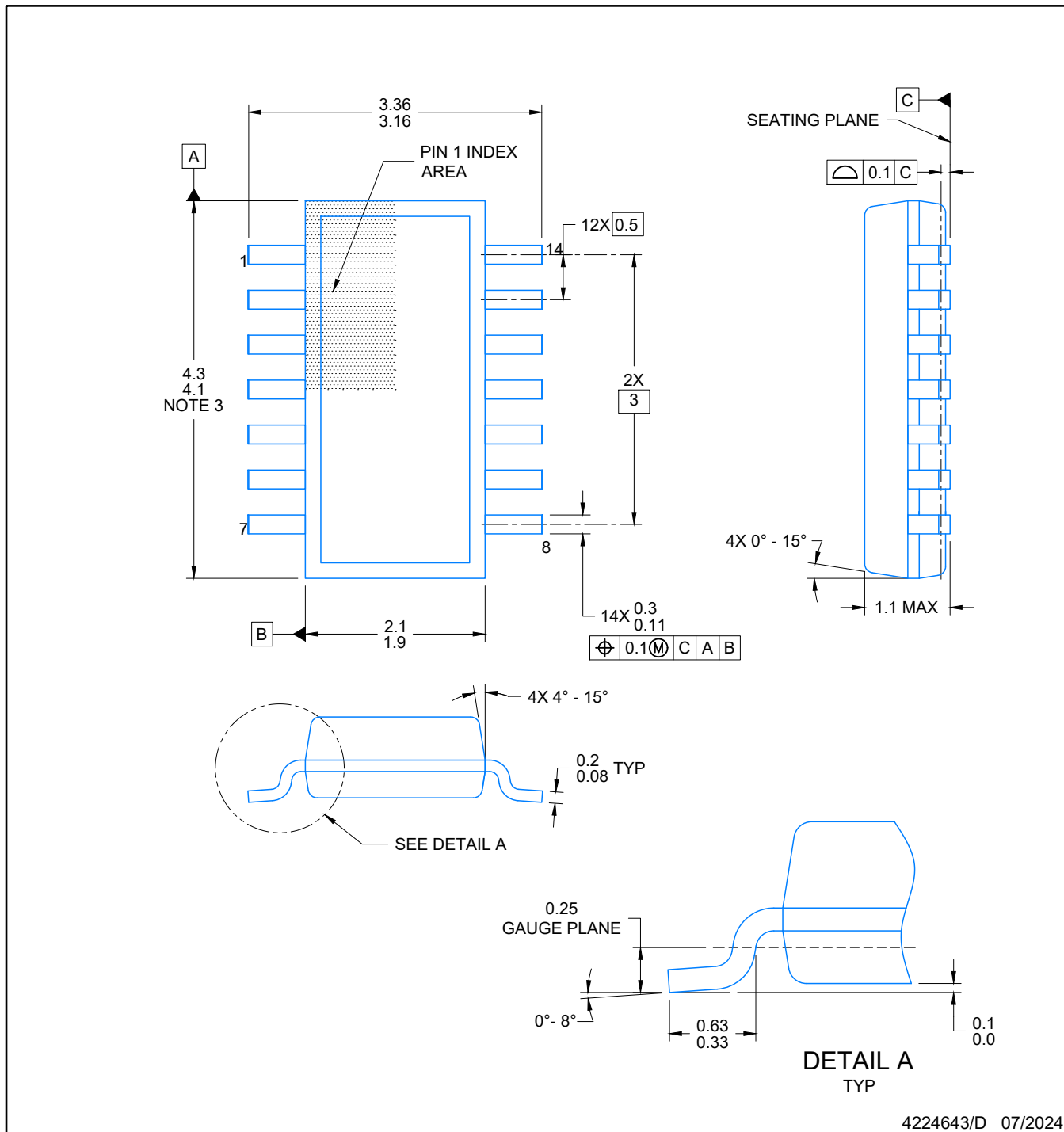

4224643/D 07/2024

NOTES:

1. All linear dimensions are in millimeters. Any dimensions in parenthesis are for reference only. Dimensioning and tolerancing per ASME Y14.5M.
2. This drawing is subject to change without notice.
3. This dimension does not include mold flash, protrusions, or gate burrs. Mold flash, protrusions, or gate burrs shall not exceed 0.15 per side.
4. This dimension does not include interlead flash. Interlead flash shall not exceed 0.50 per side.
5. Reference JEDEC Registration MO-345, Variation AB

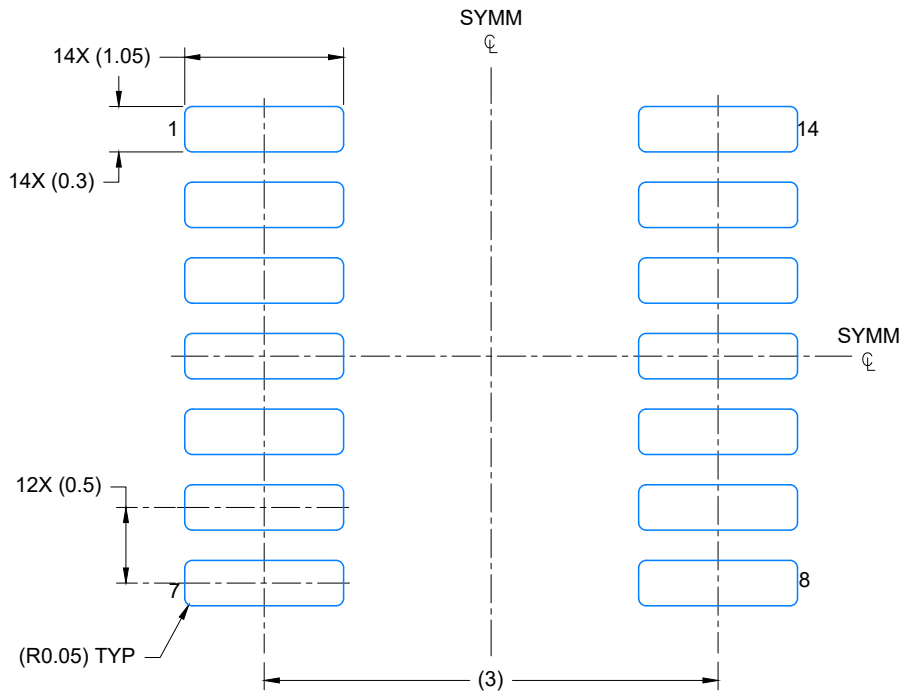

LAND PATTERN EXAMPLE
EXPOSED METAL SHOWN
SCALE: 20X

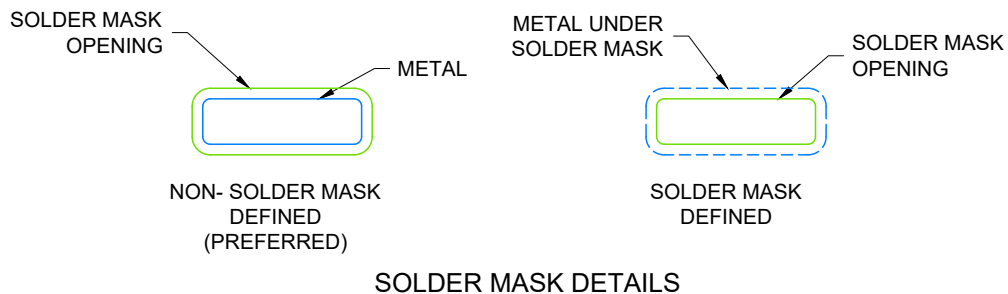

4224643/D 07/2024

NOTES: (continued)

- 6. Publication IPC-7351 may have alternate designs.
- 7. Solder mask tolerances between and around signal pads can vary based on board fabrication site.

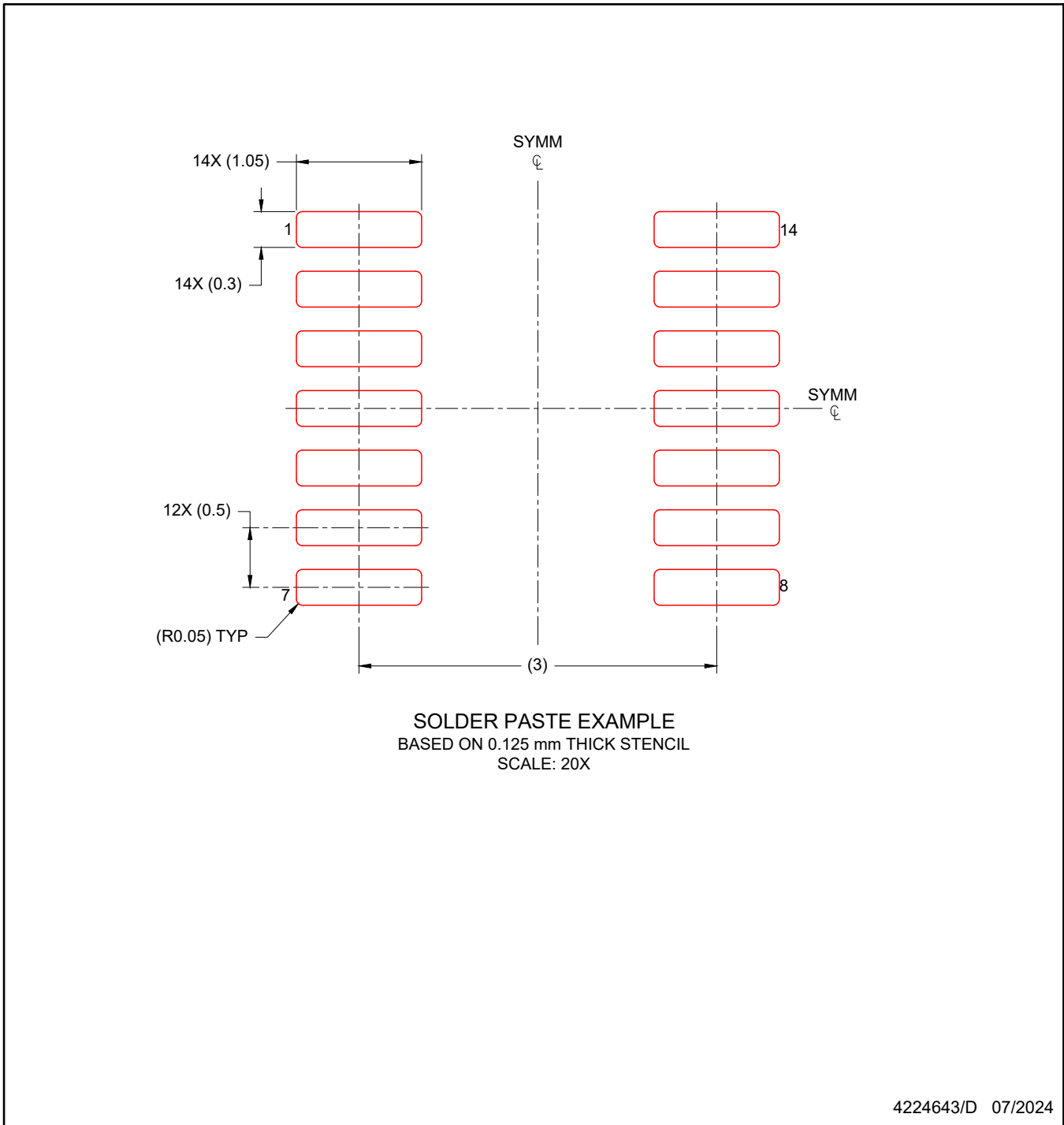

NOTES: (continued)

8. Laser cutting apertures with trapezoidal walls and rounded corners may offer better paste release. IPC-7525 may have alternate design recommendations.
9. Board assembly site may have different recommendations for stencil design.

IMPORTANT NOTICE AND DISCLAIMER

TI PROVIDES TECHNICAL AND RELIABILITY DATA (INCLUDING DATA SHEETS), DESIGN RESOURCES (INCLUDING REFERENCE DESIGNS), APPLICATION OR OTHER DESIGN ADVICE, WEB TOOLS, SAFETY INFORMATION, AND OTHER RESOURCES "AS IS" AND WITH ALL FAULTS, AND DISCLAIMS ALL WARRANTIES, EXPRESS AND IMPLIED, INCLUDING WITHOUT LIMITATION ANY IMPLIED WARRANTIES OF MERCHANTABILITY, FITNESS FOR A PARTICULAR PURPOSE OR NON-INFRINGEMENT OF THIRD PARTY INTELLECTUAL PROPERTY RIGHTS.

These resources are intended for skilled developers designing with TI products. You are solely responsible for (1) selecting the appropriate TI products for your application, (2) designing, validating and testing your application, and (3) ensuring your application meets applicable standards, and any other safety, security, regulatory or other requirements.

These resources are subject to change without notice. TI grants you permission to use these resources only for development of an application that uses the TI products described in the resource. Other reproduction and display of these resources is prohibited. No license is granted to any other TI intellectual property right or to any third party intellectual property right. TI disclaims responsibility for, and you will fully indemnify TI and its representatives against, any claims, damages, costs, losses, and liabilities arising out of your use of these resources.

TI's products are provided subject to [TI's Terms of Sale](#) or other applicable terms available either on [ti.com](https://www.ti.com) or provided in conjunction with such TI products. TI's provision of these resources does not expand or otherwise alter TI's applicable warranties or warranty disclaimers for TI products.

TI objects to and rejects any additional or different terms you may have proposed.

Mailing Address: Texas Instruments, Post Office Box 655303, Dallas, Texas 75265
Copyright © 2024, Texas Instruments Incorporated