

SN74AC541 Octal Buffers or Drivers With 3-State Outputs

1 Features

- Wide operating range of 1.5 V to 6 V
- Inputs accept voltages up to 6 V
- Continuous ± 24 -mA output drive at 5 V
- Supports up to ± 75 -mA output drive at 5 V in short bursts
- Drives 50- Ω transmission lines
- Maximum t_{pd} of 6 ns at 5 V, 50 pF load

2 Applications

- [Drive an indicator LED](#)
- [Redrive a digital signal](#)
- [Drive a transmission line](#)
- [Hold a signal during controller reset](#)

3 Description

The SN74AC541 contains eight independent logic buffers. The outputs can simultaneously be put into the high-impedance state using either of the provided output enable pins ($\overline{OE1}$ or $\overline{OE2}$).

Package Information

| PART NUMBER | PACKAGE ⁽¹⁾ | PACKAGE SIZE ⁽²⁾ | BODY SIZE ⁽³⁾ |
|-------------|------------------------|-----------------------------|--------------------------|
| SN74AC541 | DGS (VSSOP, 20) | 5.1 mm × 4.9 mm | 5.1 mm × 3 mm |
| | RKS (VQFN, 20) | 4.5 mm × 2.5 mm | 4.5 mm × 2.5 mm |

(1) For more information, see [Section 11](#).

(2) The package size (length × width) is a nominal value and includes pins, where applicable

(3) The body size (length × width) is a nominal value and does not include pins.

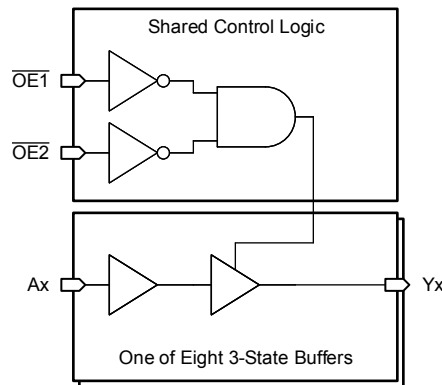

Logic Diagram (Positive Logic)



Table of Contents

| | | | |
|--|-----------|--|-----------|
| 1 Features | 1 | 8 Application and Implementation | 14 |
| 2 Applications | 1 | 8.1 Application Information..... | 14 |
| 3 Description | 1 | 8.2 Typical Application..... | 14 |
| 4 Pin Configuration and Functions | 3 | 8.3 Design Requirements..... | 14 |
| 5 Specifications | 4 | 8.4 Detailed Design Procedure..... | 16 |
| 5.1 Absolute Maximum Ratings..... | 4 | 8.5 Application Curve..... | 16 |
| 5.2 ESD Ratings..... | 4 | 8.6 Power Supply Recommendations..... | 17 |
| 5.3 Recommended Operating Conditions..... | 4 | 8.7 Layout..... | 17 |
| 5.4 Thermal Information..... | 5 | 9 Device and Documentation Support | 18 |
| 5.5 Electrical Characteristics..... | 5 | 9.1 Documentation Support..... | 18 |
| 5.6 Switching Characteristics..... | 6 | 9.2 Receiving Notification of Documentation Updates.... | 18 |
| 5.7 Typical Characteristics..... | 8 | 9.3 Support Resources..... | 18 |
| 6 Parameter Measurement Information | 11 | 9.4 Trademarks..... | 18 |
| 7 Detailed Description | 12 | 9.5 Electrostatic Discharge Caution..... | 18 |
| 7.1 Overview..... | 12 | 9.6 Glossary..... | 18 |
| 7.2 Functional Block Diagram..... | 12 | 10 Revision History | 18 |
| 7.3 Device Functional Modes..... | 12 | 11 Mechanical, Packaging, and Orderable Information | 18 |
| 7.4 Feature Description..... | 12 | | |

4 Pin Configuration and Functions

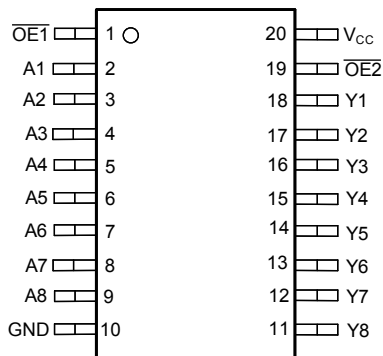

**Figure 4-1. DGS Package,
20-Pin SOT
(Top View)**

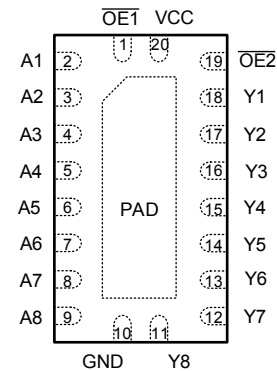

**Figure 4-2. RKS Package,
20-Pin VQFN
(Top View)**

Table 4-1. Pin Functions

| PIN | | TYPE ⁽¹⁾ | DESCRIPTION |
|----------------------------|-----|---------------------|---|
| NAME | NO. | | |
| OE1 | 1 | I | Output enable input 1, active low |
| A1 | 2 | I | Input for channel 1 |
| A2 | 3 | I | Input for channel 2 |
| A3 | 4 | I | Input for channel 3 |
| A4 | 5 | I | Input for channel 4 |
| A5 | 6 | I | Input for channel 5 |
| A6 | 7 | I | Input for channel 6 |
| A7 | 8 | I | Input for channel 7 |
| A8 | 9 | I | Input for channel 8 |
| GND | 10 | G | Ground |
| Y8 | 11 | O | Output for channel 8 |
| Y7 | 12 | O | Output for channel 7 |
| Y6 | 13 | O | Output for channel 6 |
| Y5 | 14 | O | Output for channel 5 |
| Y4 | 15 | O | Output for channel 4 |
| Y3 | 16 | O | Output for channel 3 |
| Y2 | 17 | O | Output for channel 2 |
| Y1 | 18 | O | Output for channel 1 |
| OE2 | 19 | I | Output enable input 2, active low |
| V _{CC} | 20 | P | Positive supply |
| Thermal Pad ⁽²⁾ | | — | The thermal pad can be connect to GND or left floating. Do not connect to any other signal or supply. |

(1) I = Input, O = Output, I/O = Input or Output, G = Ground, P = Power.

(2) RKS package only.

5 Specifications

5.1 Absolute Maximum Ratings

over operating free-air temperature range (unless otherwise noted)⁽¹⁾

| | | | MIN | MAX | UNIT |
|-----------|---|--|------|------------------|------|
| V_{CC} | Supply voltage range | | -0.5 | 7 | V |
| V_I | Input voltage range ⁽²⁾ | | -0.5 | $V_{CC} + 0.5$ V | V |
| V_O | Output voltage range ⁽²⁾ | | -0.5 | $V_{CC} + 0.5$ V | V |
| I_{IK} | Input clamp current | $V_I < -0.5$ V or $V_I > V_{CC} + 0.5$ V | | ±20 | mA |
| I_{OK} | Output clamp current | $V_O < -0.5$ V or $V_O > V_{CC} + 0.5$ V | | ±50 | mA |
| I_O | Continuous output current | $V_O = 0$ to V_{CC} | | ±50 | mA |
| | Continuous output current through V_{CC} or GND | | | ±200 | mA |
| T_{stg} | Storage temperature | | -65 | 150 | °C |

- (1) Operation outside the *Absolute Maximum Ratings* may cause permanent device damage. Absolute maximum ratings do not imply functional operation of the device at these or any other conditions beyond those listed under *Recommended Operating Conditions*. If briefly operating outside the *Recommended Operating Conditions* but within the *Absolute Maximum Ratings*, the device may not sustain damage, but it may not be fully functional. Operating the device in this manner may affect device reliability, functionality, performance, and shorten the device lifetime.
- (2) The input and output voltage ratings may be exceeded if the input and output current ratings are observed.

5.2 ESD Ratings

| | | | VALUE | UNIT |
|-------------|-------------------------|---|-------|------|
| $V_{(ESD)}$ | Electrostatic discharge | Human-body model (HBM), per ANSI/ESDA/JEDEC JS-001 ⁽¹⁾ | ±2000 | V |
| | | Charged-device model (CDM), per ANSI/ESDA/JEDEC JS-002 ⁽²⁾ | ±1000 | |

- (1) JEDEC document JEP155 states that 500-V HBM allows safe manufacturing with a standard ESD control process.
- (2) JEDEC document JEP157 states that 250-V CDM allows safe manufacturing with a standard ESD control process.

5.3 Recommended Operating Conditions

over operating free-air temperature range (unless otherwise noted)

| Specification | Description | Condition | MIN | MAX | UNIT |
|----------------------|---------------------------|------------------|------|----------|------|
| V_{CC} | Supply voltage | | 1.5 | 6 | V |
| V_{IH} | High-level input voltage | $V_{CC} = 1.5$ V | 1.2 | | V |
| | | $V_{CC} = 1.8$ V | 1.26 | | |
| | | $V_{CC} = 2.5$ V | 1.75 | | |
| | | $V_{CC} = 3$ V | 2.1 | | |
| | | $V_{CC} = 4.5$ V | 3.15 | | |
| | | $V_{CC} = 5.5$ V | 3.85 | | |
| V_{IL} | Low-Level input voltage | $V_{CC} = 1.5$ V | | 0.3 | V |
| | | $V_{CC} = 1.8$ V | | 0.54 | |
| | | $V_{CC} = 2.5$ V | | 0.75 | |
| | | $V_{CC} = 3$ V | | 0.9 | |
| | | $V_{CC} = 4.5$ V | | 1.35 | |
| | | $V_{CC} = 5.5$ V | | 1.65 | |
| V_I ⁽¹⁾ | Input Voltage | | 0 | V_{CC} | V |
| V_O | Output Voltage | | 0 | V_{CC} | V |
| I_{OH} | High-level output current | $V_{CC} = 1.8$ V | | -1 | mA |
| | | $V_{CC} = 2.5$ V | | -2 | |
| | | $V_{CC} = 3.3$ V | | -12 | |
| | | $V_{CC} = 5$ V | | -24 | |

5.3 Recommended Operating Conditions (continued)

over operating free-air temperature range (unless otherwise noted)

| Specification | Description | Condition | MIN | MAX | UNIT |
|-----------------|------------------------------------|-------------------------------|-----|-----|------|
| I _{OL} | Low-level output current | V _{CC} = 1.8 V | | 1 | mA |
| | | V _{CC} = 2.5 V | | 2 | |
| | | V _{CC} = 3.3 V | | 12 | |
| | | V _{CC} = 5 V | | 24 | |
| Δt/Δv | Input transition rise or fall rate | 1.5 V ≤ V _{CC} ≤ 3 V | | 50 | ns/V |
| | | 3 V < V _{CC} ≤ 5.5 V | | 20 | |
| T _A | Operating free-air temperature | | -40 | 125 | °C |

- (1) All unused inputs of the device must be held at V_{CC} or GND for proper device operation. Refer to the TI application report [Implications of Slow or Floating CMOS Inputs](#).

5.4 Thermal Information

| THERMAL METRIC ⁽¹⁾ | | DGS (VSSOP) | RKS (VQFN) | UNIT |
|-------------------------------|--|-------------|------------|------|
| | | 20 PINS | 20 PINS | |
| R _{θJA} | Junction-to-ambient thermal resistance | 125.5 | 72.9 | °C/W |
| R _{θJC(top)} | Junction-to-case (top) thermal resistance | 80.0 | 77.1 | °C/W |
| R _{θJB} | Junction-to-board thermal resistance | 63.8 | 45.6 | °C/W |
| Ψ _{JT} | Junction-to-top characterization parameter | 8.4 | 13.2 | °C/W |
| Ψ _{JB} | Junction-to-board characterization parameter | 79.9 | 45.6 | °C/W |
| R _{θJC(bot)} | Junction-to-case (bottom) thermal resistance | N/A | 29.4 | °C/W |

- (1) For more information about traditional and new thermal metrics, see the [Semiconductor and IC Package Thermal Metrics](#) application report.

5.5 Electrical Characteristics

over operating free-air temperature range (unless otherwise noted); typical values measured at T_A = 25°C

| PARAMETER | TEST CONDITIONS | V _{CC} | MIN | TYP | MAX | UNIT |
|--------------------------|--------------------------|-----------------|------|------|-----|------|
| V _{OH} | I _{OH} = -50 μA | 1.5 V | 1.4 | 1.49 | V | |
| | | 1.8 V | 1.7 | 1.79 | | |
| | | 2.5 V | 2.4 | 2.49 | | |
| | | 3 V | 2.9 | 2.99 | | |
| | | 4.5 V | 4.4 | 4.49 | | |
| | | 5.5 V | 5.4 | 5.49 | | |
| | I _{OH} = -1 mA | 1.8 V | 1.44 | | | |
| | I _{OH} = -2 mA | 2.5 V | 2 | | | |
| | I _{OH} = -4 mA | 3 V | 2.4 | | | |
| | I _{OH} = -12 mA | 3 V | 2.4 | | | |
| | I _{OH} = -24 mA | 4.5 V | 3.7 | | | |
| | I _{OH} = -24 mA | 5.5 V | 4.7 | | | |
| | I _{OH} = -75 mA | 5.5 V | | | | |
| I _{OH} = -50 mA | 5.5 V | 3.85 | | | | |

5.5 Electrical Characteristics (continued)

over operating free-air temperature range (unless otherwise noted); typical values measured at $T_A = 25^\circ\text{C}$

| PARAMETER | TEST CONDITIONS | V_{CC} | MIN | TYP | MAX | UNIT |
|--------------------------|---|--------------|------|------|---------|---------------|
| V_{OL} | $I_{OL} = 50 \mu\text{A}$ | 1.5 V | 0.01 | 0.1 | | V |
| | | 1.8 V | 0.01 | 0.1 | | |
| | | 2.5 V | 0.01 | 0.1 | | |
| | | 3 V | 0.01 | 0.1 | | |
| | | 4.5 V | 0.01 | 0.1 | | |
| | | 5.5 V | 0.01 | 0.1 | | |
| | $I_{OL} = 1 \text{ mA}$ | 1.8 V | | | 0.36 | |
| | $I_{OL} = 2 \text{ mA}$ | 2.5 V | | | 0.5 | |
| | $I_{OL} = 4 \text{ mA}$ | 3 V | | | 0.5 | |
| | $I_{OL} = 12 \text{ mA}$ | 3 V | | | 0.5 | |
| | $I_{OL} = 24 \text{ mA}$ | 4.5 V | | | 0.5 | |
| | $I_{OL} = 24 \text{ mA}$ | 5.5 V | | | 0.5 | |
| | $I_{OL} = 50 \text{ mA}$ | 5.5 V | | | 1.65 | |
| $I_{OL} = 75 \text{ mA}$ | 5.5 V | | | 1.65 | | |
| I_I | $V_I = 5.5 \text{ V or GND}$ | 0 V to 5.5 V | | | ± 1 | μA |
| I_{OZ} | $V_O = V_{CC} \text{ or GND}$ | 5.5 V | | | ± 5 | μA |
| I_{CC} | $V_I = V_{CC} \text{ or GND, } I_O = 0$ | 5.5 V | | | 20 | μA |
| C_I | $V_I = V_{CC} \text{ or GND}$ | 5 V | | 9 | | pF |
| C_O | $V_O = V_{CC} \text{ or GND}$ | 5 V | | 15 | | pF |
| $C_{PD}^{(1)(2)}$ | $F = 1 \text{ MHz}$ | 5 V | | 60 | | pF |

(1) C_{PD} is used to determine the dynamic power consumption, per channel

(2) $P_D = V_{CC}^2 \times F_I \times (C_{PD} + C_L)$ where F_I = input frequency, C_L = output load capacitance, V_{CC} = supply voltage

5.6 Switching Characteristics

$C_L = 50 \text{ pF}$; over operating free-air temperature range (unless otherwise noted). See *Parameter Measurement Information*

| PARAMETER | FROM (INPUT) | TO (OUTPUT) | V_{CC} | $T_A = 25^\circ\text{C}$ | | | $-40^\circ\text{C to } 85^\circ\text{C}$ | | | $-40^\circ\text{C to } 125^\circ\text{C}$ | | | UNIT |
|-----------|-----------------|-------------|----------|--------------------------|------|------|--|-----|------|---|------|-----|------|
| | | | | MIN | TYP | MAX | MIN | TYP | MAX | MIN | TYP | MAX | |
| t_{PLH} | A | Y | 1.5 V | | 14.5 | 25.6 | | | 26.5 | | 26.8 | ns | |
| t_{PHL} | A | Y | 1.5 V | | 14.8 | 27.5 | | | 28.4 | | 28.8 | ns | |
| t_{PZH} | \overline{OE} | Y | 1.5 V | | 17.6 | 35 | | | 36.8 | | 37.7 | ns | |
| t_{PZL} | \overline{OE} | Y | 1.5 V | | 19.2 | 36.3 | | | 37.7 | | 38.1 | ns | |
| t_{PHZ} | \overline{OE} | Y | 1.5 V | | 22.3 | 32.7 | | | 33.8 | | 34.3 | ns | |
| t_{PLZ} | \overline{OE} | Y | 1.5 V | | 14 | 21.8 | | | 22.3 | | 22.3 | ns | |
| t_{PLH} | A | Y | 1.8 V | | 10.1 | 16.4 | | | 17.7 | | 18.5 | ns | |
| t_{PHL} | A | Y | 1.8 V | | 10.9 | 18.6 | | | 19.8 | | 20.6 | ns | |
| t_{PZH} | \overline{OE} | Y | 1.8 V | | 12.8 | 22.7 | | | 24.7 | | 25.9 | ns | |
| t_{PZL} | \overline{OE} | Y | 1.8 V | | 14.1 | 24.2 | | | 26 | | 26.9 | ns | |
| t_{PHZ} | \overline{OE} | Y | 1.8 V | | 17.7 | 23.3 | | | 25.8 | | 25.8 | ns | |
| t_{PLZ} | \overline{OE} | Y | 1.8 V | | 10.6 | 15.3 | | | 15.9 | | 16 | ns | |
| t_{PLH} | A | Y | 2.5 V | | 6.4 | 9.5 | | | 10.6 | | 11.3 | ns | |
| t_{PHL} | A | Y | 2.5 V | | 7.1 | 11.4 | | | 12.4 | | 13.1 | ns | |
| t_{PZH} | \overline{OE} | Y | 2.5 V | | 8.3 | 13.5 | | | 15.1 | | 16.2 | ns | |
| t_{PZL} | \overline{OE} | Y | 2.5 V | | 9.3 | 15.1 | | | 16.7 | | 17.4 | ns | |
| t_{PHZ} | \overline{OE} | Y | 2.5 V | | 7.6 | 10.5 | | | 11.4 | | 11.9 | ns | |

5.6 Switching Characteristics (continued)

$C_L = 50$ pF; over operating free-air temperature range (unless otherwise noted). See *Parameter Measurement Information*

| PARAMETER | FROM (INPUT) | TO (OUTPUT) | V_{CC} | $T_A = 25^\circ\text{C}$ | | | $-40^\circ\text{C to } 85^\circ\text{C}$ | | | $-40^\circ\text{C to } 125^\circ\text{C}$ | | | UNIT |
|-----------|-----------------|-------------|----------|--------------------------|-----|------|--|-----|------|---|-----|------|------|
| | | | | MIN | TYP | MAX | MIN | TYP | MAX | MIN | TYP | MAX | |
| t_{PLZ} | \overline{OE} | Y | 2.5 V | | 5.4 | 7.9 | | | 8.7 | | | 8.9 | ns |
| t_{PLH} | A | Y | 3.3 V | | 5.3 | 7.6 | | | 8.6 | | | 9.2 | ns |
| t_{PHL} | A | Y | 3.3 V | | 5.9 | 9.4 | | | 10.2 | | | 10.8 | ns |
| t_{PZH} | \overline{OE} | Y | 3.3 V | | 7.2 | 11.2 | | | 12.4 | | | 13.2 | ns |
| t_{PZL} | \overline{OE} | Y | 3.3 V | | 7.7 | 12.5 | | | 13.6 | | | 14.5 | ns |
| t_{PHZ} | \overline{OE} | Y | 3.3 V | | 6.3 | 8.4 | | | 9.3 | | | 10 | ns |
| t_{PLZ} | \overline{OE} | Y | 3.3 V | | 4.7 | 6.6 | | | 7.1 | | | 7.7 | ns |
| t_{PLH} | A | Y | 5 V | | 3.9 | 5.3 | | | 6 | | | 6.4 | ns |
| t_{PHL} | A | Y | 5 V | | 4.5 | 7 | | | 7.6 | | | 8 | ns |
| t_{PZH} | \overline{OE} | Y | 5 V | | 5.6 | 8.3 | | | 9.2 | | | 9.8 | ns |
| t_{PZL} | \overline{OE} | Y | 5 V | | 5.8 | 8.8 | | | 9.6 | | | 10.2 | ns |
| t_{PHZ} | \overline{OE} | Y | 5 V | | 5 | 6.3 | | | 6.8 | | | 6.8 | ns |
| t_{PLZ} | \overline{OE} | Y | 5 V | | 3.5 | 4.5 | | | 4.9 | | | 5.2 | ns |

5.7 Typical Characteristics

T_A = 25°C (unless otherwise noted)

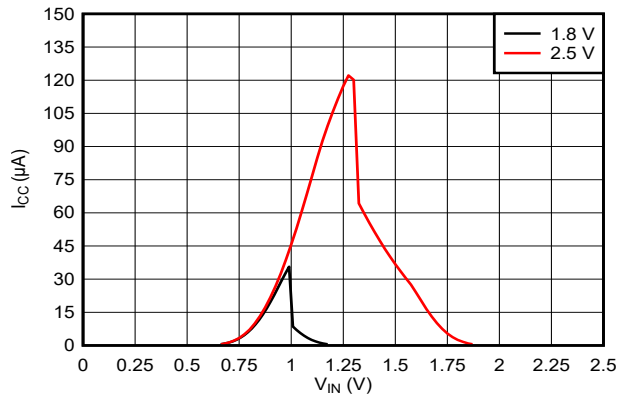

Figure 5-1. Supply Current Across Input Voltage 1.8-V and 2.5-V Supply

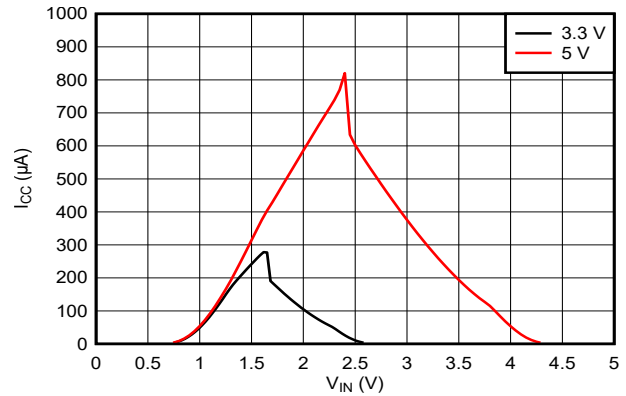

Figure 5-2. Supply Current Across Input Voltage 3.3-V and 5.0-V Supply

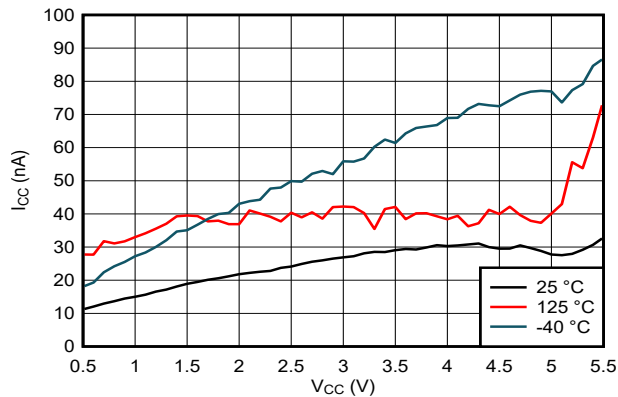

Figure 5-3. Supply Current Across Supply Voltage

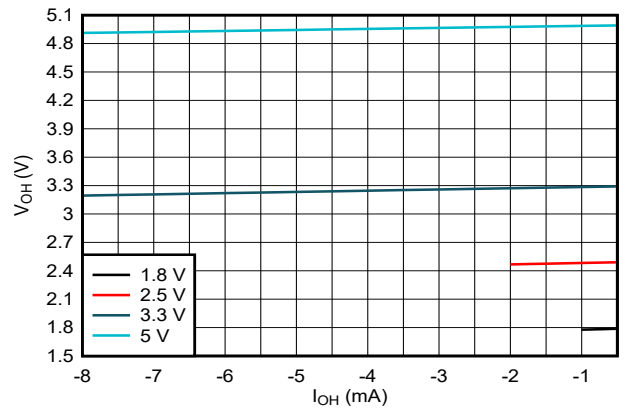

Figure 5-4. Output Voltage vs Current in HIGH State

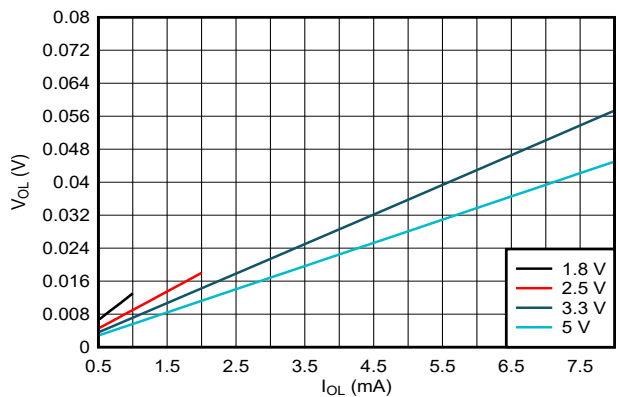

Figure 5-5. Output Voltage vs Current in LOW State

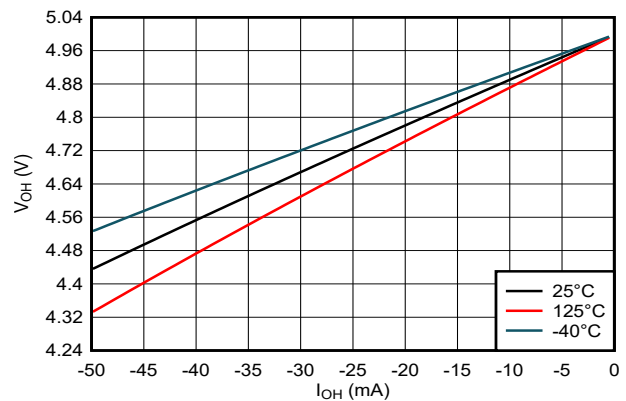

Figure 5-6. Output Voltage vs Current in HIGH State; 5-V Supply

5.7 Typical Characteristics (continued)

$T_A = 25^\circ\text{C}$ (unless otherwise noted)

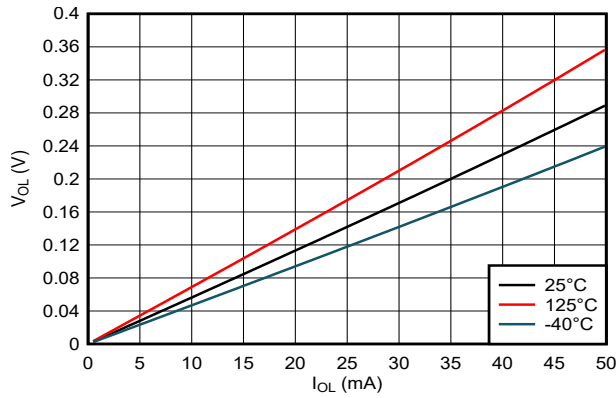

Figure 5-7. Output Voltage vs Current in LOW State; 5-V Supply

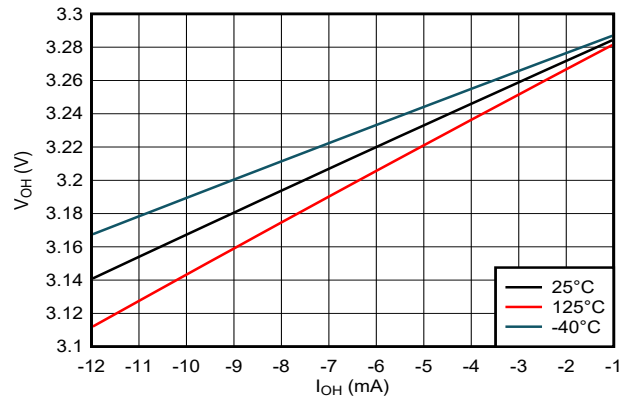

Figure 5-8. Output Voltage vs Current in HIGH State; 3.3-V Supply

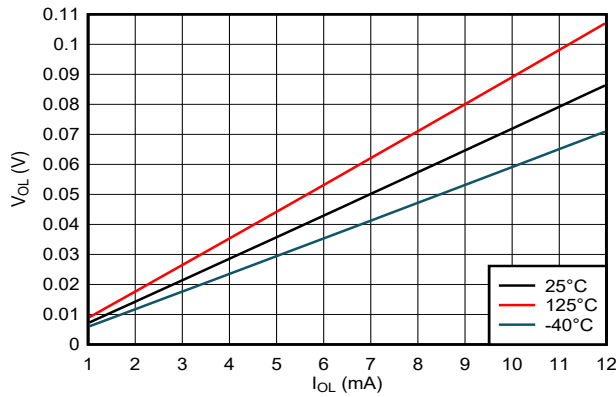

Figure 5-9. Output Voltage vs Current in LOW State; 3.3-V Supply

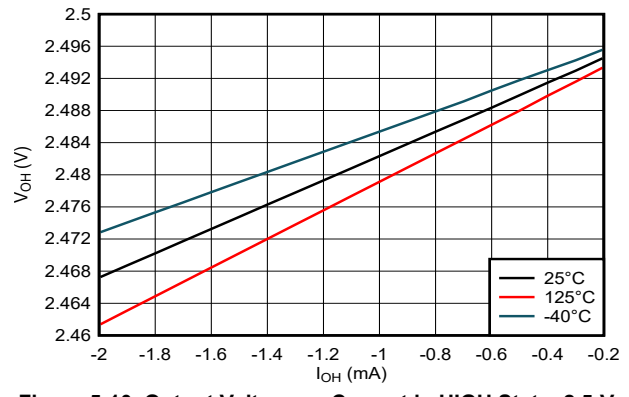

Figure 5-10. Output Voltage vs Current in HIGH State; 2.5-V Supply

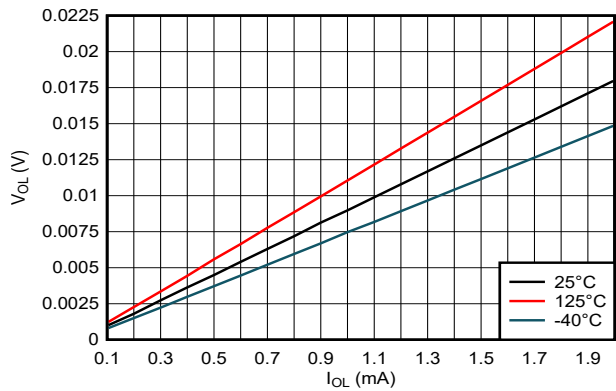

Figure 5-11. Output Voltage vs Current in LOW State; 2.5-V Supply

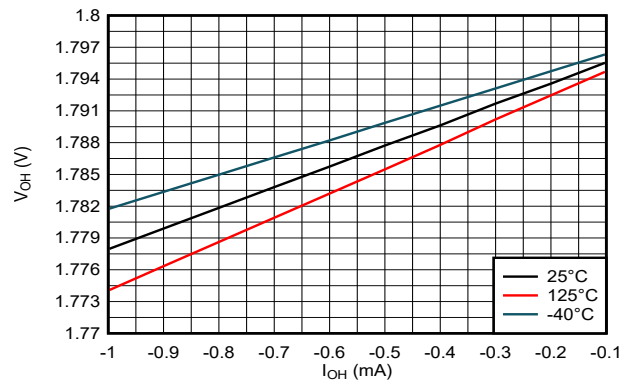

Figure 5-12. Output Voltage vs Current in HIGH State; 1.8-V Supply

5.7 Typical Characteristics (continued)

T_A = 25°C (unless otherwise noted)

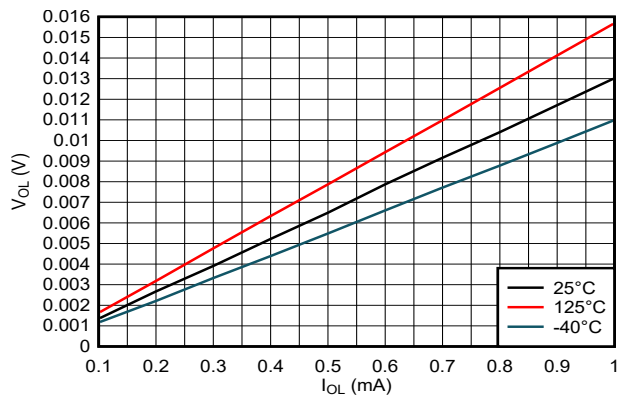

Figure 5-13. Output Voltage vs Current in LOW State; 1.8-V Supply

6 Parameter Measurement Information

Phase relationships between waveforms were chosen arbitrarily for the examples listed in the following table. All input pulses are supplied by generators having the following characteristics: PRR \leq 1 MHz, $Z_O = 50 \Omega$, $t_t < 2.5$ ns.

The outputs are measured individually with one input transition per measurement.

| TEST | S1 | S2 | R_L | C_L | ΔV | V_{CC} |
|-----------------------|--------|--------|--------------|-------|------------|--------------|
| t_{PLH} , t_{PHL} | OPEN | OPEN | — | 50 pF | — | ALL |
| t_{PLZ} , t_{PZL} | CLOSED | OPEN | 1 k Ω | 50 pF | 0.15 V | ≤ 2.5 V |
| t_{PHZ} , t_{PZH} | OPEN | CLOSED | 1 k Ω | 50 pF | 0.15 V | ≤ 2.5 V |
| t_{PLZ} , t_{PZL} | CLOSED | OPEN | 500 Ω | 50 pF | 0.3 V | > 2.5 V |
| t_{PHZ} , t_{PZH} | OPEN | CLOSED | 500 Ω | 50 pF | 0.3 V | > 2.5 V |

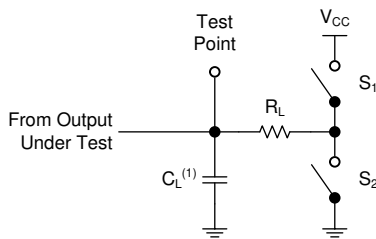

(1) C_L includes probe and test-fixture capacitance.

Figure 6-1. Load Circuit for 3-State Outputs

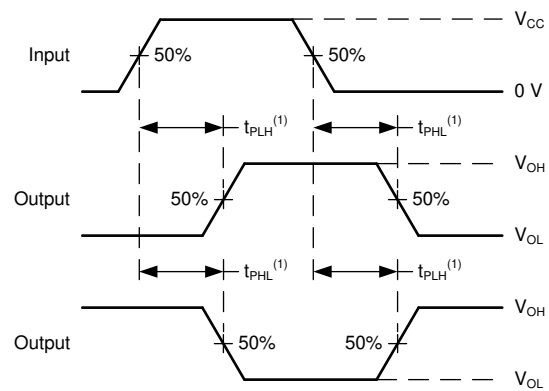

(1) The greater between t_{PLH} and t_{PHL} is the same as t_{pd} .

Figure 6-2. Voltage Waveforms Propagation Delays

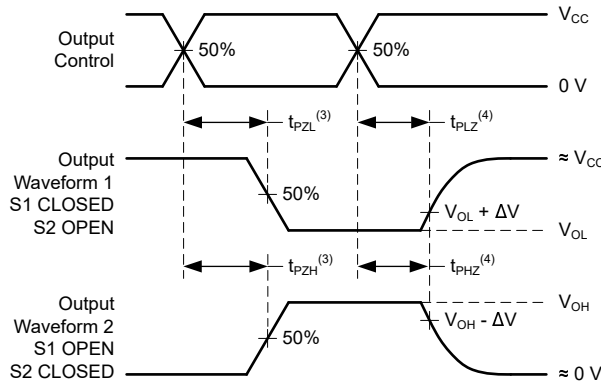

(3) The greater between t_{PZL} and t_{PZH} is the same as t_{en} .

(4) The greater between t_{PLZ} and t_{PHZ} is the same as t_{dis} .

Figure 6-3. Voltage Waveforms Propagation Delays

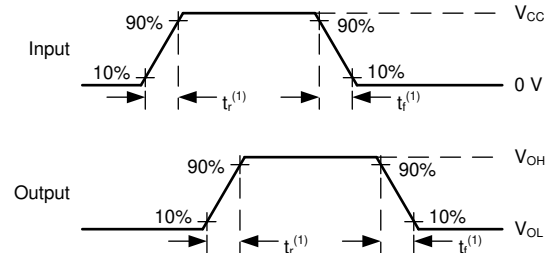

(1) The greater between t_r and t_f is the same as t_t .

Figure 6-4. Voltage Waveforms, Input and Output Transition Times

7 Detailed Description

7.1 Overview

The SN74AC541 contains eight buffers with 3-state outputs. The active low output enable pins ($\overline{OE1}$ and $\overline{OE2}$) control all eight channels, and are configured so that both must be low for the outputs to be active.

When the outputs are enabled, the outputs are actively driven low or high.

When the outputs are disabled, the outputs are set into the high-impedance state.

7.2 Functional Block Diagram

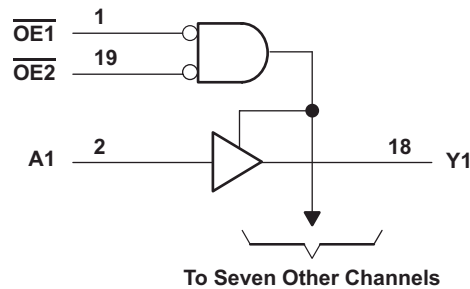

Copyright © 2016, Texas Instruments Incorporated

Figure 7-1. Logic Diagram (Positive Logic)

7.3 Device Functional Modes

Table 7-1. Function Table

| INPUTS ⁽¹⁾ | | | OUTPUT ⁽²⁾ |
|-----------------------|------------------|---|-----------------------|
| $\overline{OE1}$ | $\overline{OE2}$ | A | Y |
| L | L | L | L |
| L | L | H | H |
| H | X | X | Z |
| X | H | X | Z |

(1) L = input low, H = input high, X = do not care

(2) L = output low, H = output high, Z = high impedance

7.4 Feature Description

7.4.1 Balanced CMOS 3-State Outputs

This device includes balanced CMOS 3-state outputs. Driving high, driving low, and high impedance are the three states that these outputs can be in. The term *balanced* indicates that the device can sink and source similar currents. The drive capability of this device may create fast edges into light loads, so routing and load conditions should be considered to prevent ringing. Additionally, the outputs of this device can drive larger currents than the device can sustain without being damaged. It is important for the output power of the device to be limited to avoid damage due to overcurrent. The electrical and thermal limits defined in the *Absolute Maximum Ratings* must be followed at all times.

When placed into the high-impedance state, the output will neither source nor sink current, with the exception of minor leakage current as defined in the *Electrical Characteristics* table. In the high-impedance state, the output voltage is not controlled by the device and is dependent on external factors. If no other drivers are connected to the node, then this is known as a floating node and the voltage is unknown. A pull-up or pull-down resistor can be connected to the output to provide a known voltage at the output while it is in the high-impedance state. The value of the resistor will depend on multiple factors, including parasitic capacitance and power consumption limitations. Typically, a 10-k Ω resistor can be used to meet these requirements.

Unused 3-state CMOS outputs should be left disconnected.

7.4.2 Standard CMOS Inputs

This device includes standard CMOS inputs. Standard CMOS inputs are high impedance and are typically modeled as a resistor in parallel with the input capacitance given in the *Electrical Characteristics*. The worst case resistance is calculated with the maximum input voltage, given in the *Absolute Maximum Ratings*, and the maximum input leakage current, given in the *Electrical Characteristics*, using Ohm's law ($R = V \div I$).

Standard CMOS inputs require that input signals transition between valid logic states quickly, as defined by the input transition time or rate in the *Recommended Operating Conditions* table. Failing to meet this specification will result in excessive power consumption and could cause oscillations. More details can be found in [Implications of Slow or Floating CMOS Inputs](#).

Do not leave standard CMOS inputs floating at any time during operation. Unused inputs must be terminated at V_{CC} or GND. If a system will not be actively driving an input at all times, then a pull-up or pull-down resistor can be added to provide a valid input voltage during these times. The resistor value will depend on multiple factors; a 10-k Ω resistor, however, is recommended and will typically meet all requirements.

7.4.3 Clamp Diode Structure

As shown in [Figure 7-2](#), the inputs and outputs to this device have both positive and negative clamping diodes.

CAUTION

Voltages beyond the values specified in the *Absolute Maximum Ratings* table can cause damage to the device. The input and output voltage ratings may be exceeded if the input and output clamp-current ratings are observed.

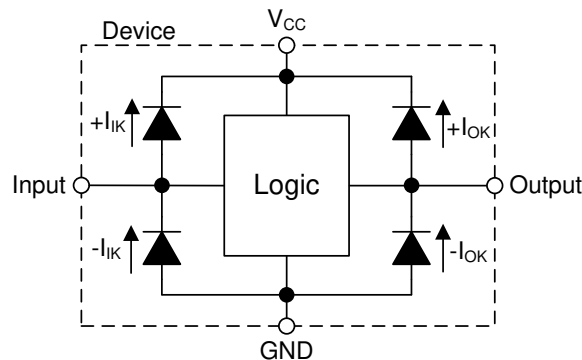

Figure 7-2. Electrical Placement of Clamping Diodes for Each Input and Output

8 Application and Implementation

Note

Information in the following applications sections is not part of the TI component specification, and TI does not warrant its accuracy or completeness. TI's customers are responsible for determining suitability of components for their purposes, as well as validating and testing their design implementation to confirm system functionality.

8.1 Application Information

The SN74AC541 can be used to drive signals over relatively long traces or transmission lines. A series damping resistor placed in series with the transmitter's output can be used to reduce ringing caused by impedance mismatches between the driver, transmission line, and receiver. The figure in the *Application Curve* section shows the received signal with three separate resistor values. Just a small amount of resistance can make a significant impact on signal integrity in this type of application.

8.2 Typical Application

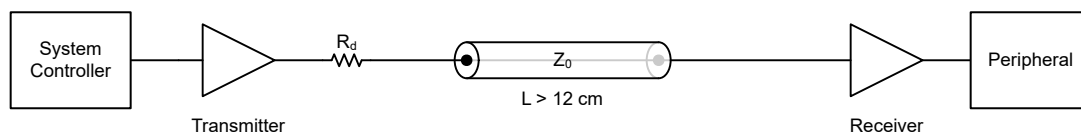

Figure 8-1. Typical Application Block Diagram

8.3 Design Requirements

8.3.1 Power Considerations

Ensure the desired supply voltage is within the range specified in the *Recommended Operating Conditions*. The supply voltage sets the device's electrical characteristics as described in the *Electrical Characteristics* section.

The positive voltage supply must be capable of sourcing current equal to the total current to be sourced by all outputs of the SN74AC541 plus the maximum static supply current, I_{CC} , listed in the *Electrical Characteristics*, and any transient current required for switching. The logic device can only source as much current that is provided by the positive supply source. Be sure to not exceed the maximum total current through V_{CC} listed in the *Absolute Maximum Ratings*.

The ground must be capable of sinking current equal to the total current to be sunk by all outputs of the SN74AC541 plus the maximum supply current, I_{CC} , listed in the *Electrical Characteristics*, and any transient current required for switching. The logic device can only sink as much current that can be sunk into its ground connection. Be sure to not exceed the maximum total current through GND listed in the *Absolute Maximum Ratings*.

The SN74AC541 can drive a load with a total capacitance less than or equal to 50 pF while still meeting all of the data sheet specifications. Larger capacitive loads can be applied; however, it is not recommended to exceed 50 pF.

The SN74AC541 can drive a load with total resistance described by $R_L \geq V_O / I_O$, with the output voltage and current defined in the *Electrical Characteristics* table with V_{OH} and V_{OL} . When outputting in the HIGH state, the output voltage in the equation is defined as the difference between the measured output voltage and the supply voltage at the V_{CC} pin.

Total power consumption can be calculated using the information provided in [CMOS Power Consumption and Cpd Calculation](#).

Thermal increase can be calculated using the information provided in [Thermal Characteristics of Standard Linear and Logic \(SLL\) Packages and Devices](#).

CAUTION

The maximum junction temperature, $T_{J(max)}$ listed in the *Absolute Maximum Ratings*, is an additional limitation to prevent damage to the device. Do not violate any values listed in the *Absolute Maximum Ratings*. These limits are provided to prevent damage to the device.

8.3.2 Input Considerations

Input signals must cross $V_{IL(max)}$ to be considered a logic LOW, and $V_{IH(min)}$ to be considered a logic HIGH. Do not exceed the maximum input voltage range found in the *Absolute Maximum Ratings*.

Unused inputs must be terminated to either V_{CC} or ground. The unused inputs can be directly terminated if the input is completely unused, or they can be connected with a pull-up or pull-down resistor if the input will be used sometimes, but not always. A pull-up resistor is used for a default state of HIGH, and a pull-down resistor is used for a default state of LOW. The drive current of the controller, leakage current into the SN74AC541 (as specified in the *Electrical Characteristics*), and the desired input transition rate limits the resistor size. A 10-k Ω resistor value is often used due to these factors.

The SN74AC541 has CMOS inputs and thus requires fast input transitions to operate correctly, as defined in the *Recommended Operating Conditions* table. Slow input transitions can cause oscillations, additional power consumption, and reduction in device reliability.

Refer to the *Feature Description* section for additional information regarding the inputs for this device.

8.3.3 Output Considerations

The positive supply voltage is used to produce the output HIGH voltage. Drawing current from the output will decrease the output voltage as specified by the V_{OH} specification in the *Electrical Characteristics*. The ground voltage is used to produce the output LOW voltage. Sinking current into the output will increase the output voltage as specified by the V_{OL} specification in the *Electrical Characteristics*.

Push-pull outputs that could be in opposite states, even for a very short time period, should never be connected directly together. This can cause excessive current and damage to the device.

Two channels within the same device with the same input signals can be connected in parallel for additional output drive strength.

Unused outputs can be left floating. Do not connect outputs directly to V_{CC} or ground.

Refer to the *Feature Description* section for additional information regarding the outputs for this device.

8.4 Detailed Design Procedure

1. Add a decoupling capacitor from V_{CC} to GND. The capacitor needs to be placed physically close to the device and electrically close to both the V_{CC} and GND pins. An example layout is shown in the *Layout* section.
2. Ensure the capacitive load at the output is ≤ 50 pF. This is not a hard limit; by design, however, it will optimize performance. This can be accomplished by providing short, appropriately sized traces from the SN74AC541 to one or more of the receiving devices.
3. Ensure the resistive load at the output is larger than $(V_{CC} / I_{O(max)}) \Omega$. Doing this will prevent the maximum output current from the *Absolute Maximum Ratings* from being violated. Most CMOS inputs have a resistive load measured in $M\Omega$; much larger than the minimum calculated previously.
4. Thermal issues are rarely a concern for logic gates; the power consumption and thermal increase, however, can be calculated using the steps provided in the application report, [CMOS Power Consumption and Cpd Calculation](#).

8.5 Application Curve

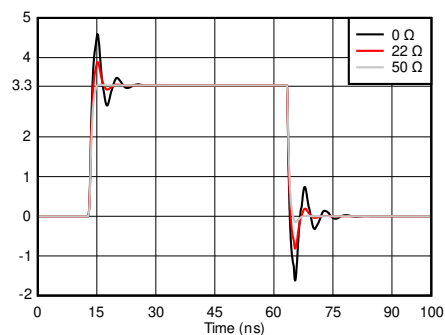

Figure 8-2. Simulated Signal Integrity at the Receiver with Different Damping Resistor (R_d) Values

8.6 Power Supply Recommendations

The power supply can be any voltage between the minimum and maximum supply voltage rating located in the *Recommended Operating Conditions*. Each V_{CC} terminal should have a good bypass capacitor to prevent power disturbance. A 0.1- μF capacitor is recommended for this device. It is acceptable to parallel multiple bypass capacitors to reject different frequencies of noise. The 0.1- μF and 1- μF capacitors are commonly used in parallel. The bypass capacitor should be installed as close to the power terminal as possible for best results.

8.7 Layout

8.7.1 Layout Guidelines

When using multiple-input and multiple-channel logic devices, inputs must never be left floating. In many cases, functions or parts of functions of digital logic devices are unused; for example, when only two inputs of a triple-input AND gate are used or only 3 of the 4 buffer gates are used. Such unused input pins must not be left unconnected because the undefined voltages at the outside connections result in undefined operational states. All unused inputs of digital logic devices must be connected to a logic high or logic low voltage, as defined by the input voltage specifications, to prevent them from floating. The logic level that must be applied to any particular unused input depends on the function of the device. Generally, the inputs are tied to GND or V_{CC} , whichever makes more sense for the logic function or is more convenient.

8.7.2 Layout Example

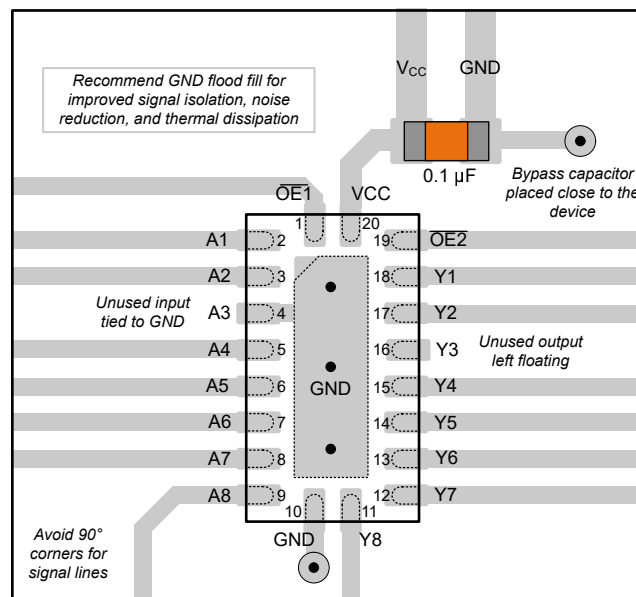

Figure 8-3. Example Layout for the SN74AC541 in the RKS Package

9 Device and Documentation Support

9.1 Documentation Support

9.1.1 Related Documentation

For related documentation, see the following:

- Texas Instruments, [CMOS Power Consumption and Cpd Calculation](#)
- Texas Instruments, [Implications of Slow or Floating CMOS Inputs](#)
- Texas Instruments, [Thermal Characteristics of Standard Linear and Logic \(SLL\) Packages and Devices](#)

9.2 Receiving Notification of Documentation Updates

To receive notification of documentation updates, navigate to the device product folder on ti.com. Click on *Notifications* to register and receive a weekly digest of any product information that has changed. For change details, review the revision history included in any revised document.

9.3 Support Resources

[TI E2E™ support forums](#) are an engineer's go-to source for fast, verified answers and design help — straight from the experts. Search existing answers or ask your own question to get the quick design help you need.

Linked content is provided "AS IS" by the respective contributors. They do not constitute TI specifications and do not necessarily reflect TI's views; see TI's [Terms of Use](#).

9.4 Trademarks

TI E2E™ is a trademark of Texas Instruments.
 All trademarks are the property of their respective owners.

9.5 Electrostatic Discharge Caution



This integrated circuit can be damaged by ESD. Texas Instruments recommends that all integrated circuits be handled with appropriate precautions. Failure to observe proper handling and installation procedures can cause damage.

ESD damage can range from subtle performance degradation to complete device failure. Precision integrated circuits may be more susceptible to damage because very small parametric changes could cause the device not to meet its published specifications.

9.6 Glossary

[TI Glossary](#) This glossary lists and explains terms, acronyms, and definitions.

10 Revision History

| DATE | REVISION | NOTES |
|---------------|----------|-----------------|
| November 2023 | * | Initial Release |

11 Mechanical, Packaging, and Orderable Information

The following pages include mechanical, packaging, and orderable information. This information is the most current data available for the designated devices. This data is subject to change without notice and revision of this document. For browser-based versions of this data sheet, refer to the left-hand navigation.

PACKAGING INFORMATION

| Orderable Device | Status (1) | Package Type | Package Drawing | Pins | Package Qty | Eco Plan (2) | Lead finish/ Ball material (6) | MSL Peak Temp (3) | Op Temp (°C) | Device Marking (4/5) | Samples |
|------------------|---------------|--------------|-----------------|------|-------------|-----------------|--------------------------------------|----------------------|--------------|-------------------------|-------------------------|
| SN74AC541DGSR | ACTIVE | VSSOP | DGS | 20 | 5000 | RoHS & Green | NIPDAU | Level-1-260C-UNLIM | -40 to 125 | AC541 | Samples |
| SN74AC541RKSR | ACTIVE | VQFN | RKS | 20 | 3000 | RoHS & Green | NIPDAU | Level-1-260C-UNLIM | -40 to 125 | AC541 | Samples |

(1) The marketing status values are defined as follows:

ACTIVE: Product device recommended for new designs.

LIFEBUY: TI has announced that the device will be discontinued, and a lifetime-buy period is in effect.

NRND: Not recommended for new designs. Device is in production to support existing customers, but TI does not recommend using this part in a new design.

PREVIEW: Device has been announced but is not in production. Samples may or may not be available.

OBSOLETE: TI has discontinued the production of the device.

(2) **RoHS:** TI defines "RoHS" to mean semiconductor products that are compliant with the current EU RoHS requirements for all 10 RoHS substances, including the requirement that RoHS substance do not exceed 0.1% by weight in homogeneous materials. Where designed to be soldered at high temperatures, "RoHS" products are suitable for use in specified lead-free processes. TI may reference these types of products as "Pb-Free".

RoHS Exempt: TI defines "RoHS Exempt" to mean products that contain lead but are compliant with EU RoHS pursuant to a specific EU RoHS exemption.

Green: TI defines "Green" to mean the content of Chlorine (Cl) and Bromine (Br) based flame retardants meet JS709B low halogen requirements of <=1000ppm threshold. Antimony trioxide based flame retardants must also meet the <=1000ppm threshold requirement.

(3) MSL, Peak Temp. - The Moisture Sensitivity Level rating according to the JEDEC industry standard classifications, and peak solder temperature.

(4) There may be additional marking, which relates to the logo, the lot trace code information, or the environmental category on the device.

(5) Multiple Device Markings will be inside parentheses. Only one Device Marking contained in parentheses and separated by a "~" will appear on a device. If a line is indented then it is a continuation of the previous line and the two combined represent the entire Device Marking for that device.

(6) Lead finish/Ball material - Orderable Devices may have multiple material finish options. Finish options are separated by a vertical ruled line. Lead finish/Ball material values may wrap to two lines if the finish value exceeds the maximum column width.

Important Information and Disclaimer:The information provided on this page represents TI's knowledge and belief as of the date that it is provided. TI bases its knowledge and belief on information provided by third parties, and makes no representation or warranty as to the accuracy of such information. Efforts are underway to better integrate information from third parties. TI has taken and continues to take reasonable steps to provide representative and accurate information but may not have conducted destructive testing or chemical analysis on incoming materials and chemicals. TI and TI suppliers consider certain information to be proprietary, and thus CAS numbers and other limited information may not be available for release.

In no event shall TI's liability arising out of such information exceed the total purchase price of the TI part(s) at issue in this document sold by TI to Customer on an annual basis.

TAPE AND REEL INFORMATION

QUADRANT ASSIGNMENTS FOR PIN 1 ORIENTATION IN TAPE

*All dimensions are nominal

| Device | Package Type | Package Drawing | Pins | SPQ | Reel Diameter (mm) | Reel Width W1 (mm) | A0 (mm) | B0 (mm) | K0 (mm) | P1 (mm) | W (mm) | Pin1 Quadrant |
|---------------|--------------|-----------------|------|------|--------------------|--------------------|---------|---------|---------|---------|--------|---------------|
| SN74AC541DGSR | VSSOP | DGS | 20 | 5000 | 330.0 | 16.4 | 5.4 | 5.4 | 1.45 | 8.0 | 16.0 | Q1 |
| SN74AC541RKSR | VQFN | RKS | 20 | 3000 | 180.0 | 12.4 | 2.8 | 4.8 | 1.2 | 4.0 | 12.0 | Q1 |

TAPE AND REEL BOX DIMENSIONS



*All dimensions are nominal

| Device | Package Type | Package Drawing | Pins | SPQ | Length (mm) | Width (mm) | Height (mm) |
|---------------|--------------|-----------------|------|------|-------------|------------|-------------|
| SN74AC541DGSR | VSSOP | DGS | 20 | 5000 | 353.0 | 353.0 | 32.0 |
| SN74AC541RKSR | VQFN | RKS | 20 | 3000 | 210.0 | 185.0 | 35.0 |

GENERIC PACKAGE VIEW

RKS 20

VQFN - 1 mm max height

2.5 x 4.5, 0.5 mm pitch

PLASTIC QUAD FLATPACK - NO LEAD

This image is a representation of the package family, actual package may vary.
Refer to the product data sheet for package details.

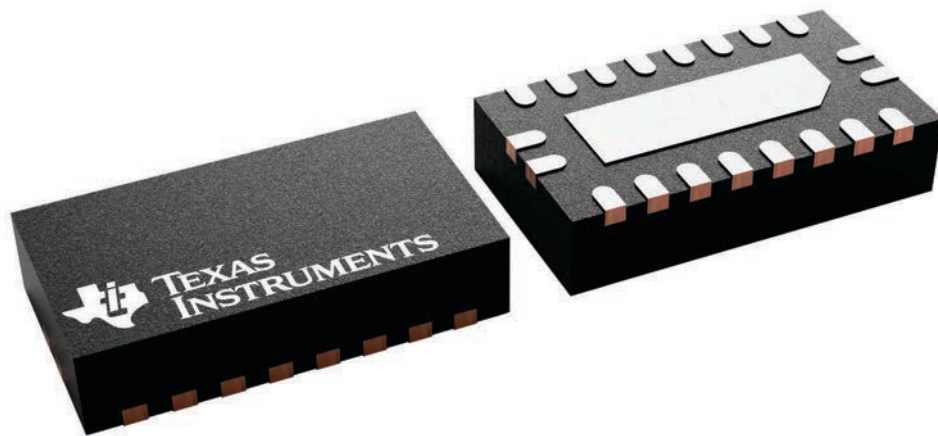

4226872/A

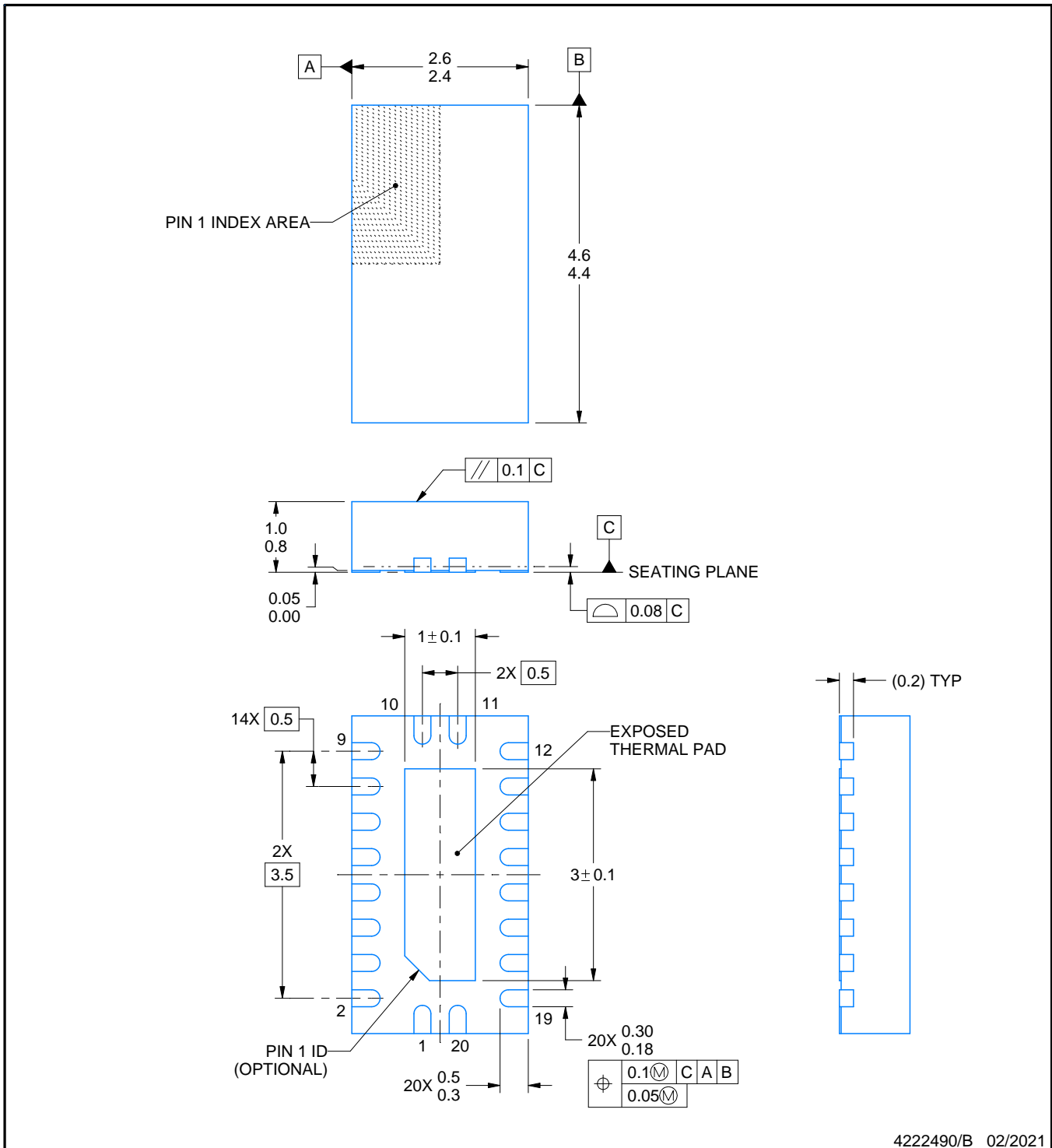

NOTES:

1. All linear dimensions are in millimeters. Any dimensions in parenthesis are for reference only. Dimensioning and tolerancing per ASME Y14.5M.
2. This drawing is subject to change without notice.
3. The package thermal pad must be soldered to the printed circuit board for thermal and mechanical performance.

EXAMPLE BOARD LAYOUT

RKS0020A

VQFN - 1 mm max height

PLASTIC QUAD FLATPACK - NO LEAD

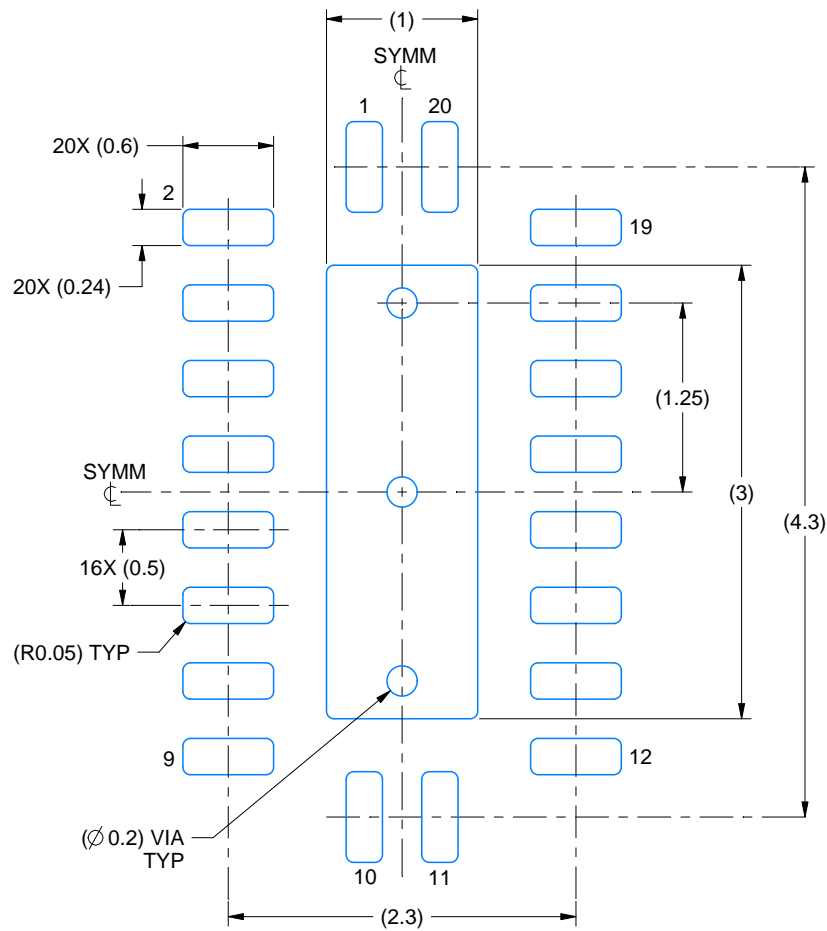

LAND PATTERN EXAMPLE
SCALE:20X



SOLDER MASK DETAILS

4222490/B 02/2021

NOTES: (continued)

- This package is designed to be soldered to a thermal pad on the board. For more information, see Texas Instruments literature number SLUA271 (www.ti.com/lit/slua271).
- Vias are optional depending on application, refer to device data sheet. If some or all are implemented, recommended via locations are shown.

EXAMPLE STENCIL DESIGN

RKS0020A

VQFN - 1 mm max height

PLASTIC QUAD FLATPACK - NO LEAD



SOLDER PASTE EXAMPLE
BASED ON 0.125 mm THICK STENCIL

EXPOSED PAD
83% PRINTED SOLDER COVERAGE BY AREA
SCALE:25X

4222490/B 02/2021

NOTES: (continued)

6. Laser cutting apertures with trapezoidal walls and rounded corners may offer better paste release. IPC-7525 may have alternate design recommendations.

IMPORTANT NOTICE AND DISCLAIMER

TI PROVIDES TECHNICAL AND RELIABILITY DATA (INCLUDING DATA SHEETS), DESIGN RESOURCES (INCLUDING REFERENCE DESIGNS), APPLICATION OR OTHER DESIGN ADVICE, WEB TOOLS, SAFETY INFORMATION, AND OTHER RESOURCES "AS IS" AND WITH ALL FAULTS, AND DISCLAIMS ALL WARRANTIES, EXPRESS AND IMPLIED, INCLUDING WITHOUT LIMITATION ANY IMPLIED WARRANTIES OF MERCHANTABILITY, FITNESS FOR A PARTICULAR PURPOSE OR NON-INFRINGEMENT OF THIRD PARTY INTELLECTUAL PROPERTY RIGHTS.

These resources are intended for skilled developers designing with TI products. You are solely responsible for (1) selecting the appropriate TI products for your application, (2) designing, validating and testing your application, and (3) ensuring your application meets applicable standards, and any other safety, security, regulatory or other requirements.

These resources are subject to change without notice. TI grants you permission to use these resources only for development of an application that uses the TI products described in the resource. Other reproduction and display of these resources is prohibited. No license is granted to any other TI intellectual property right or to any third party intellectual property right. TI disclaims responsibility for, and you will fully indemnify TI and its representatives against, any claims, damages, costs, losses, and liabilities arising out of your use of these resources.

TI's products are provided subject to [TI's Terms of Sale](#) or other applicable terms available either on [ti.com](https://www.ti.com) or provided in conjunction with such TI products. TI's provision of these resources does not expand or otherwise alter TI's applicable warranties or warranty disclaimers for TI products.

TI objects to and rejects any additional or different terms you may have proposed.

Mailing Address: Texas Instruments, Post Office Box 655303, Dallas, Texas 75265
Copyright © 2024, Texas Instruments Incorporated