

# SN74AHC1G32-Q1 Automotive Single 2-Input Positive-OR Gate

## 1 Features

- AEC-Q100 qualified for automotive applications:
  - Device temperature grade 1: -40°C to +125°C
  - Device HBM ESD classification level 2
  - Device CDM ESD classification level C4B
- Qualified for automotive applications
- Operating range of 2V to 5.5V
- Maximum  $t_{pd}$  of 6.5ns at 5V
- Low power consumption, 10µA maximum  $I_{CC}$
- ±8mA output drive at 5V
- Latch-up performance exceeds 250mA per JESD 17

## 2 Applications

- [Enable or disable a digital signal](#)
- [Controlling an indicator LED](#)

## 3 Description

The SN74AHC1G32-Q1 is a single 2-input positive-OR gate. The device performs the Boolean function  $Y = A + B$  in positive logic.

### Package Information

PART NUMBER	PACKAGE <sup>(1)</sup>	PACKAGE SIZE <sup>(2)</sup>	BODY SIZE <sup>(3)</sup>
SN74AHC1G32-Q1	DBV (SOT-23, 5)	2.9mm × 2.8mm	2.9mm × 1.6mm
	DCK (SC70, 5)	2mm × 1.25mm	2mm × 1.25mm
	DTX (X2SON, 5)	1.1mm × 0.85mm	1.1mm × 0.85mm

- (1) For more information, see [Mechanical, Packaging, and Orderable Information](#).
- (2) The package size (length × width) is a nominal value and includes pins, where applicable.
- (3) The body size (length × width) is a nominal value and does not include pins.



**Logic Diagram (Positive Logic)**



## Table of Contents

<b>1 Features</b> .....	1	7.3 Feature Description.....	7
<b>2 Applications</b> .....	1	7.4 Device Functional Modes.....	8
<b>3 Description</b> .....	1	<b>8 Application and Implementation</b> .....	9
<b>4 Pin Configuration and Functions</b> .....	3	8.1 Application Information.....	9
<b>5 Specifications</b> .....	4	8.2 Typical Application.....	9
5.1 Absolute Maximum Ratings.....	4	8.3 Power Supply Recommendations.....	10
5.2 ESD Ratings.....	4	8.4 Layout.....	10
5.3 Recommended Operating Conditions.....	4	<b>9 Device and Documentation Support</b> .....	11
5.4 Thermal Information.....	5	9.1 Documentation Support.....	11
5.5 Electrical Characteristics.....	5	9.2 Receiving Notification of Documentation Updates....	11
5.6 Switching Characteristics, $V_{CC} = 3.3\text{ V} \pm 0.3\text{ V}$ .....	5	9.3 Support Resources.....	11
5.7 Switching Characteristics, $V_{CC} = 5\text{ V} \pm 0.5\text{ V}$ .....	5	9.4 Trademarks.....	11
5.8 Operating Characteristics.....	5	9.5 Electrostatic Discharge Caution.....	11
<b>6 Parameter Measurement Information</b> .....	6	9.6 Glossary.....	11
<b>7 Detailed Description</b> .....	7	<b>10 Revision History</b> .....	11
7.1 Overview.....	7	<b>11 Mechanical, Packaging, and Orderable Information</b> .....	11
7.2 Functional Block Diagram.....	7		

## 4 Pin Configuration and Functions

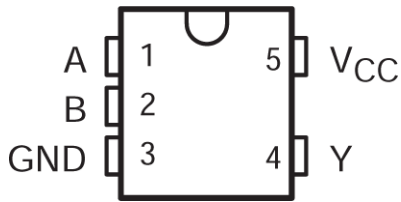

**Figure 4-1. DBV or DCK Package, 5-Pin SOT-23 or SOT-SC70 (Top View)**

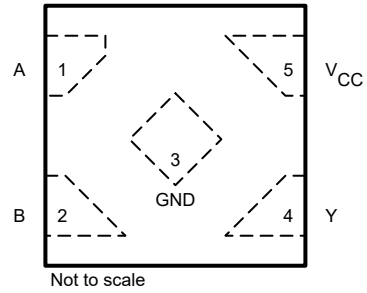

**Figure 4-2. DTX Package, 5-Pin X2SON (Top View)**

**Table 4-1. Pin Functions**

PIN		TYPE <sup>(1)</sup>	DESCRIPTION
NAME	NO.		
A	1	I	Input A
B	2	I	Input B
GND	3	—	Ground Pin
Y	4	O	Output Y
V <sub>CC</sub>	5	—	Power Pin

(1) Signal Types: I = Input, O = Output, I/O = Input or Output

## 5 Specifications

### 5.1 Absolute Maximum Ratings

over operating free-air temperature (unless otherwise noted)<sup>(1)</sup>

		MIN	MAX	UNIT
V <sub>CC</sub>	Supply voltage range	-0.5	7	V
V <sub>I</sub> <sup>(2)</sup>	Input voltage range	-0.5	7	V
V <sub>O</sub> <sup>(2)</sup>	Output voltage range	-0.5	V <sub>CC</sub> + 0.5	V
I <sub>IK</sub>	Input clamp current	(V <sub>I</sub> < 0)	-20	mA
I <sub>OK</sub>	Output clamp current	(V <sub>O</sub> < 0 or V <sub>O</sub> > V <sub>CC</sub> )	±20	mA
I <sub>O</sub>	Continuous output current	(V <sub>O</sub> = 0 to V <sub>CC</sub> )	±25	mA
	Continuous current through V <sub>CC</sub> or GND		±50	mA
T <sub>stg</sub>	Storage temperature range	-65	150	°C

- (1) Stresses beyond those listed under *Absolute Maximum Ratings* may cause permanent damage to the device. These are stress ratings only, and functional operation of the device at these or any other conditions beyond those indicated under *Recommended Operating Conditions* is not implied. Exposure to absolute-maximum-rated conditions for extended periods may affect device reliability.
- (2) The input and output voltage ratings may be exceeded if the input and output current ratings are observed.

### 5.2 ESD Ratings

		VALUE	UNIT
V <sub>(ESD)</sub>	Electrostatic discharge	Human body model (HBM), per AEC Q100-002 <sup>1</sup>	±1500 V

- (1) AEC Q100-002 indicates that HBM stressing must be in accordance with the ANSI/ESDA/JEDEC JS-001 specification.

### 5.3 Recommended Operating Conditions

(over operating free-air temperature (unless otherwise noted)<sup>(1)</sup>

		MIN	MAX	UNIT
V <sub>CC</sub>	Supply voltage	2	5.5	V
V <sub>IH</sub>	High-level input voltage	V <sub>CC</sub> = 2 V	1.5	V
		V <sub>CC</sub> = 3 V	2.1	
		V <sub>CC</sub> = 5.5 V	3.85	
V <sub>IL</sub>	Low-level input voltage	V <sub>CC</sub> = 2 V	0.5	V
		V <sub>CC</sub> = 3 V	0.9	
		V <sub>CC</sub> = 5.5 V	1.65	
V <sub>I</sub>	Input voltage	0	5.5	V
V <sub>O</sub>	Output voltage	0	V <sub>CC</sub>	V
I <sub>OH</sub>	High-level output current	V <sub>CC</sub> = 2 V	-50	μA
		V <sub>CC</sub> = 3.3 V ± 0.3 V	-4	mA
		V <sub>CC</sub> = 5 V ± 0.5 V	-8	
I <sub>OL</sub>	Low-level output current	V <sub>CC</sub> = 2 V	50	μA
		V <sub>CC</sub> = 3.3 V ± 0.3 V	4	mA
		V <sub>CC</sub> = 5 V ± 0.5 V	8	
Δt/Δv	Input transition rise or fall rate	V <sub>CC</sub> = 3.3 V ± 0.3 V	100	ns/V
		V <sub>CC</sub> = 5 V ± 0.5 V	20	
T <sub>A</sub>	Operating free-air temperature (SN74AHC1G32-Q1T)	-40	105	°C
T <sub>A</sub>	Operating free-air temperature (SN74AHC1G32-Q1Q)	-40	125	°C

- (1) All unused inputs of the device must be held at V<sub>CC</sub> or GND for proper device operation. Refer to the TI application report, *Implications of Slow or Floating CMOS Inputs*, literature number SCBA004.

## 5.4 Thermal Information

THERMAL METRIC <sup>(1)</sup>		SN74AHC1G32-Q1			UNIT
		DBV	DCK	DTX	
		5 PINS	5 PINS	5 PINS	
$R_{\theta JA}$	Junction-to-ambient thermal resistance	278	289.2	184.7	°C/W

(1) For more information about traditional and new thermal metrics, see the *IC Package Thermal Metrics* application report (SPRA953).

## 5.5 Electrical Characteristics

over recommended operating free-air temperature range (unless otherwise noted)

PARAMETER	TEST CONDITIONS	$V_{CC}$	$T_A = 25^\circ\text{C}$			MIN	MAX	UNIT
			MIN	TYP	MAX			
$V_{OH}$	$I_{OH} = -50 \mu\text{A}$	2 V	1.9	2		1.9	V	
		3 V	2.9	3		2.9		
		4.5 V	4.4	4.5		4.4		
	$I_{OH} = -4 \text{ mA}$	3 V	2.58		2.48			
	$I_{OH} = -8 \text{ mA}$	4.5 V	3.94		3.8			
$V_{OL}$	$I_{OL} = 50 \mu\text{A}$	2 V			0.1	0.1	V	
		3 V			0.1	0.1		
		4.5 V			0.1	0.1		
	$I_{OL} = 4 \text{ mA}$	3 V		0.36	0.44			
	$I_{OL} = 8 \text{ mA}$	4.5 V		0.36	0.44			
$I_I$	$V_I = 5.5 \text{ V or GND}$	0 V to 5.5 V			$\pm 0.1$	$\pm 1$	$\mu\text{A}$	
$I_{CC}$	$V_I = V_{CC}$ or GND, $I_O = 0$	5.5 V			1	10	$\mu\text{A}$	
$C_i$	$V_I = V_{CC}$ or GND	5 V		2	10	10	pF	

## 5.6 Switching Characteristics, $V_{CC} = 3.3 \text{ V} \pm 0.3 \text{ V}$

over recommended operating free-air temperature range,  $V_{CC} = 3.3 \text{ V} \pm 0.3 \text{ V}$  (unless otherwise noted) (see [Load Circuit and Voltage Waveforms](#))

PARAMETER	FROM (INPUT)	TO (OUTPUT)	LOAD CAPACITANCE	$T_A = 25^\circ\text{C}$			MIN	MAX	UNIT
				MIN	TYP	MAX			
$t_{PLH}$	A or B	Y	$C_L = 50 \text{ pF}$		8	11.4	1	13	ns
$t_{PHL}$					8	11.4	1	13	

## 5.7 Switching Characteristics, $V_{CC} = 5 \text{ V} \pm 0.5 \text{ V}$

over recommended operating free-air temperature range,  $V_{CC} = 5 \text{ V} \pm 0.5 \text{ V}$  (unless otherwise noted) (see [Load Circuit and Voltage Waveforms](#))

PARAMETER	FROM (INPUT)	TO (OUTPUT)	LOAD CAPACITANCE	$T_A = 25^\circ\text{C}$			MIN	MAX	UNIT
				MIN	TYP	MAX			
$t_{PLH}$	A or B	Y	$C_L = 50 \text{ pF}$		5.3	7.5	1	8.5	ns
$t_{PHL}$					5.3	7.5	1	8.5	

## 5.8 Operating Characteristics

$V_{CC} = 5 \text{ V}$ ,  $T_A = 25^\circ\text{C}$

PARAMETER	TEST CONDITIONS	TYP	UNIT
$C_{pd}$	Power dissipation capacitance	No load, $f = 1 \text{ MHz}$	14 pF

## 6 Parameter Measurement Information

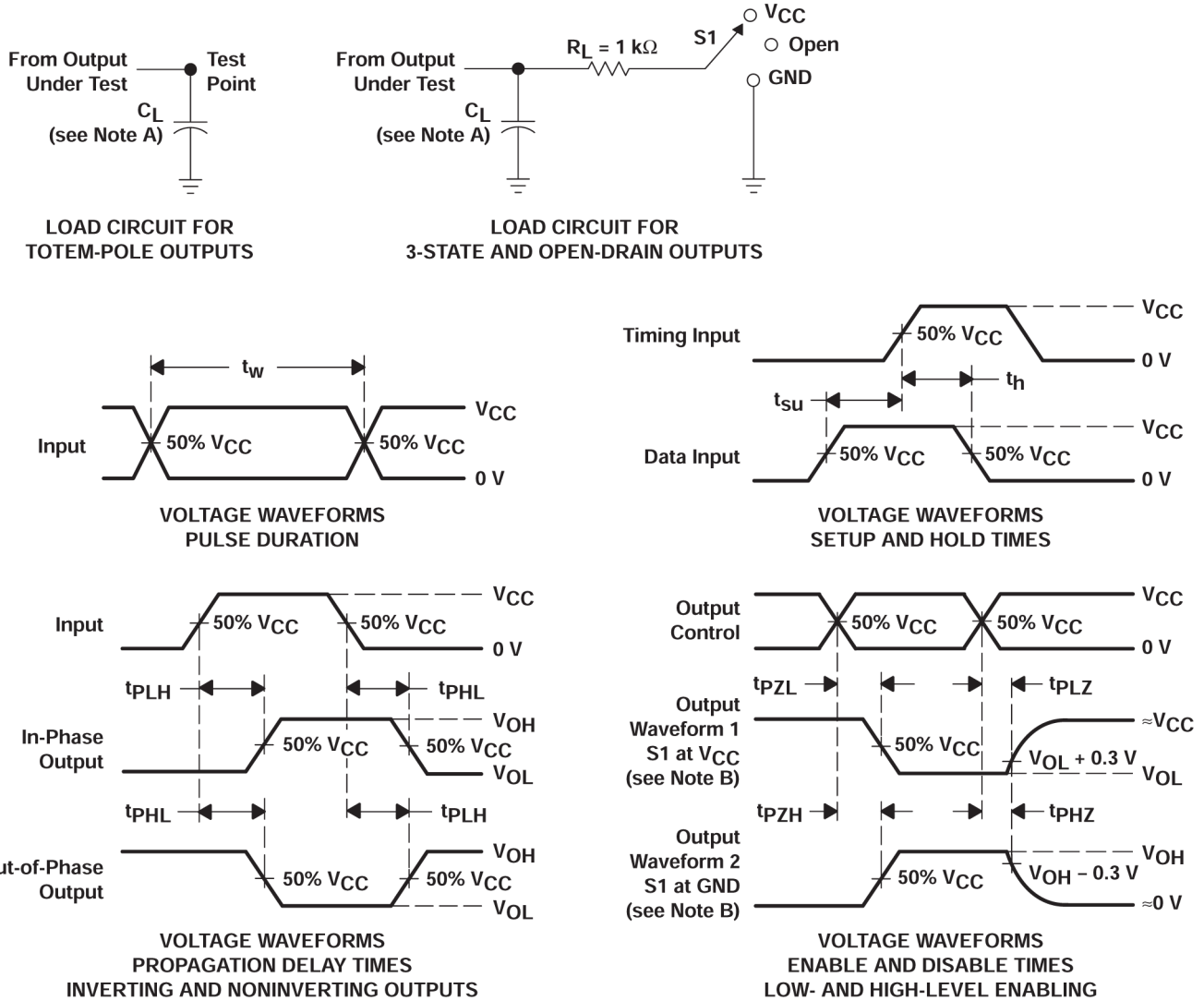

- A.  $C_L$  includes probe and jig capacitance.
- B. Waveform 1 is for an output with internal conditions such that the output is low except when disabled by the output control. Waveform 2 is for an output with internal conditions such that the output is high except when disabled by the output control.
- C. All input pulses are supplied by generators having the following characteristics:  $PRR \leq 1$  MHz,  $Z_O = 50 \Omega$ ,  $t_r \leq 3$  ns,  $t_f \leq 3$  ns.
- D. The outputs are measured one at a time with one input transition per measurement.
- E. All parameters and waveforms are not applicable to all devices.

**Figure 6-1. Load Circuit and Voltage Waveforms**

TEST	S1
$t_{PLH}/t_{PHL}$	Open
$t_{PLZ}/t_{PZL}$	$V_{CC}$
$t_{PHZ}/t_{PZH}$	GND
Open Drain	$V_{CC}$

## 7 Detailed Description

### 7.1 Overview

This device contains a 2-input OR Gate. The gate performs the Boolean function  $Y = A + B$  in positive logic. The output level is referenced to the supply voltage ( $V_{CC}$ ) and supports 2.0-V, 3.0-V, and 5-V CMOS levels.

### 7.2 Functional Block Diagram



Figure 7-1. Logic Diagram (Positive Logic)

### 7.3 Feature Description

#### 7.3.1 Standard CMOS Inputs

This device includes standard CMOS inputs. Standard CMOS inputs are high impedance and are typically modeled as a resistor in parallel with the input capacitance given in the *Electrical Characteristics*. The worst case resistance is calculated with the maximum input voltage, given in the *Absolute Maximum Ratings*, and the maximum input leakage current, given in the *Electrical Characteristics*, using Ohm's law ( $R = V \div I$ ).

Standard CMOS inputs require that input signals transition between valid logic states quickly, as defined by the input transition time or rate in the *Recommended Operating Conditions* table. Failing to meet this specification will result in excessive power consumption and could cause oscillations. More details can be found in [Implications of Slow or Floating CMOS Inputs](#).

Do not leave standard CMOS inputs floating at any time during operation. Unused inputs must be terminated at  $V_{CC}$  or GND. If a system will not be actively driving an input at all times, then a pull-up or pull-down resistor can be added to provide a valid input voltage during these times. The resistor value will depend on multiple factors; a 10-k $\Omega$  resistor, however, is recommended and will typically meet all requirements.

#### 7.3.2 Balanced CMOS Push-Pull Outputs

This device includes balanced CMOS push-pull outputs. The term *balanced* indicates that the device can sink and source similar currents. The drive capability of this device may create fast edges into light loads, so routing and load conditions should be considered to prevent ringing. Additionally, the outputs of this device are capable of driving larger currents than the device can sustain without being damaged. It is important to limit the output power of the device to avoid damage due to overcurrent. The electrical and thermal limits defined in the *Absolute Maximum Ratings* must be followed at all times.

Unused push-pull CMOS outputs must be left disconnected.

### 7.3.3 Clamp Diode Structure

The outputs to this device have both positive and negative clamping diodes, and the inputs to this device have negative clamping diodes only as shown in Figure 7-2.

**CAUTION**

Voltages beyond the values specified in the *Absolute Maximum Ratings* table can cause damage to the device. The input and output voltage ratings may be exceeded if the input and output clamp-current ratings are observed.

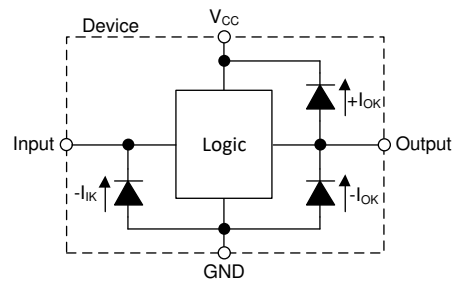

Figure 7-2. Electrical Placement of Clamping Diodes for Each Input and Output

### 7.4 Device Functional Modes

Table 7-1. Function Table

INPUTS <sup>(1)</sup>		OUTPUT Y
A	B	
H	X	H
X	H	H
L	L	L

(1) H = high voltage level, L = low voltage level, X = do not care



## 8 Application and Implementation

### Note

Information in the following applications sections is not part of the TI component specification, and TI does not warrant its accuracy or completeness. TI's customers are responsible for determining suitability of components for their purposes, as well as validating and testing their design implementation to confirm system functionality.

### 8.1 Application Information

In this application, three 2-input OR gates are combined to produce a 4-input OR gate function as shown in [Typical Application Block Diagram](#). The fourth gate can be used for another application in the system, or the inputs can be grounded and the channel left unused.

The SN74AHC1G32-Q1 device is used to directly control the enable pin of a fan driver. The fan driver requires only one input signal to be HIGH before being enabled, and should be disabled in the event that all signals go LOW. The 4-input OR gate function combines the four individual overheat signals into a single active-high enable signal.

Temperature sensors can often be spread throughout a system rather than being in a centralized location. This would mean longer length traces or wires to pass signals through leading to slower edge transitions. This makes the SN74AHC1G32-Q1 useful for combining the incoming signals.

### 8.2 Typical Application

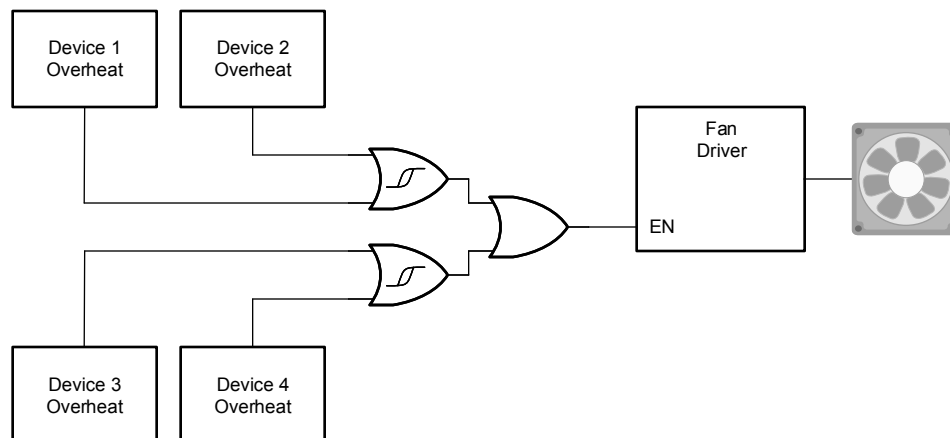

Figure 8-1. Typical Application Block Diagram

#### 8.2.1 Design Requirements

#### 8.2.2 Detailed Design Procedure

1. Add a decoupling capacitor from  $V_{CC}$  to GND. The capacitor needs to be placed physically close to the device and electrically close to both the  $V_{CC}$  and GND pins. An example layout is shown in the *Layout* section.
2. Ensure the capacitive load at the output is  $\leq 50$  pF. This is not a hard limit; by design, however, it will optimize performance. This can be accomplished by providing short, appropriately sized traces from the SN74AHC1G32-Q1 to one or more of the receiving devices.
3. Ensure the resistive load at the output is larger than  $(V_{CC} / I_{O(max)}) \Omega$ . Doing this will prevent the maximum output current from the *Absolute Maximum Ratings* from being violated. Most CMOS inputs have a resistive load measured in M $\Omega$ ; much larger than the minimum calculated previously.
4. Thermal issues are rarely a concern for logic gates; the power consumption and thermal increase, however, can be calculated using the steps provided in the application report, [CMOS Power Consumption and Cpd Calculation](#).

### 8.2.3 Application Curves

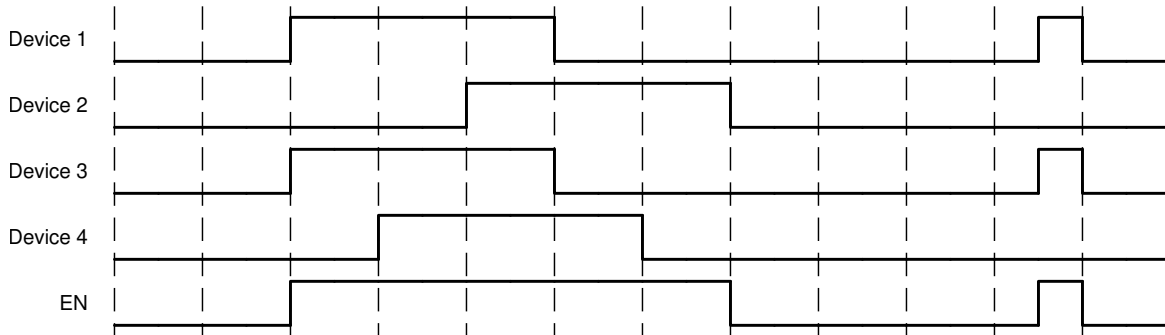

Figure 8-2. Application Timing Diagram

### 8.3 Power Supply Recommendations

The power supply can be any voltage between the minimum and maximum supply voltage rating located in the *Recommended Operating Conditions*. Each  $V_{CC}$  terminal should have a good bypass capacitor to prevent power disturbance. A 0.1- $\mu\text{F}$  capacitor is recommended for this device. It is acceptable to parallel multiple bypass capacitors to reject different frequencies of noise. The 0.1- $\mu\text{F}$  and 1- $\mu\text{F}$  capacitors are commonly used in parallel. The bypass capacitor should be installed as close to the power terminal as possible for best results, as shown in the following layout example.

### 8.4 Layout

#### 8.4.1 Layout Guidelines

When using multiple-input and multiple-channel logic devices, inputs must never be left floating. In many cases, functions or parts of functions of digital logic devices are unused (for example, when only two inputs of a triple-input AND gate are used or only 3 of the 4 buffer gates are used). Such unused input pins must not be left unconnected because the undefined voltages at the outside connections result in undefined operational states. All unused inputs of digital logic devices must be connected to a logic high or logic low voltage, as defined by the input voltage specifications, to prevent them from floating. The logic level that must be applied to any particular unused input depends on the function of the device. Generally, the inputs are tied to GND or  $V_{CC}$ , whichever makes more sense for the logic function or is more convenient.

#### 8.4.2 Layout Example

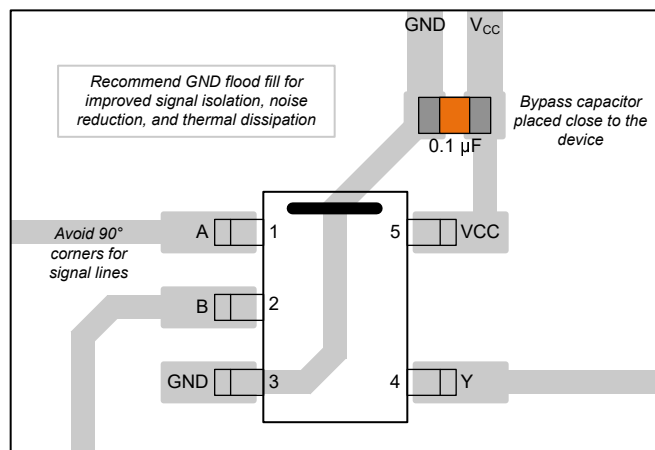

Figure 8-3. Example Layout for the SN74AHC1G32-Q1

## 9 Device and Documentation Support

### 9.1 Documentation Support

#### 9.1.1 Related Documentation

For related documentation, see the following:

- Texas Instruments, [Implications of Slow or Floating CMOS Inputs](#)

### 9.2 Receiving Notification of Documentation Updates

To receive notification of documentation updates, navigate to the device product folder on [ti.com](#). Click on *Notifications* to register and receive a weekly digest of any product information that has changed. For change details, review the revision history included in any revised document.

### 9.3 Support Resources

[TI E2E™ support forums](#) are an engineer's go-to source for fast, verified answers and design help — straight from the experts. Search existing answers or ask your own question to get the quick design help you need.

Linked content is provided "AS IS" by the respective contributors. They do not constitute TI specifications and do not necessarily reflect TI's views; see TI's [Terms of Use](#).

### 9.4 Trademarks

TI E2E™ is a trademark of Texas Instruments.  
All trademarks are the property of their respective owners.

### 9.5 Electrostatic Discharge Caution



This integrated circuit can be damaged by ESD. Texas Instruments recommends that all integrated circuits be handled with appropriate precautions. Failure to observe proper handling and installation procedures can cause damage.

ESD damage can range from subtle performance degradation to complete device failure. Precision integrated circuits may be more susceptible to damage because very small parametric changes could cause the device not to meet its published specifications.

### 9.6 Glossary

[TI Glossary](#) This glossary lists and explains terms, acronyms, and definitions.

## 10 Revision History

NOTE: Page numbers for previous revisions may differ from page numbers in the current version.

### Changes from Revision D (January 2024) to Revision E (October 2024) Page

- Added DTX package to *Package Information* table, *Pin Configuration and Functions* section, and *Thermal Information* table ..... 1

### Changes from Revision C (October 2023) to Revision D (January 2024) Page

- Added ESD classifications to *Features* section..... 1
- Updated RθJA values: DBV = 206 to 278, all values in °C/W..... 5

## 11 Mechanical, Packaging, and Orderable Information

The following pages include mechanical, packaging, and orderable information. This information is the most current data available for the designated devices. This data is subject to change without notice and revision of this document. For browser-based versions of this data sheet, refer to the left-hand navigation.

**PACKAGING INFORMATION**

Orderable Device	Status (1)	Package Type	Package Drawing	Pins	Package Qty	Eco Plan (2)	Lead finish/ Ball material (6)	MSL Peak Temp (3)	Op Temp (°C)	Device Marking (4/5)	Samples
SN74AHC1G32QDBVRQ1	ACTIVE	SOT-23	DBV	5	3000	RoHS & Green	SN	Level-1-260C-UNLIM	-40 to 125	39DH	<a href="#">Samples</a>
SN74AHC1G32QDCKRQ1	ACTIVE	SC70	DCK	5	3000	RoHS & Green	NIPDAU	Level-1-260C-UNLIM	-40 to 125	1OF	<a href="#">Samples</a>
SN74AHC1G32TDBVRQ1	ACTIVE	SOT-23	DBV	5	3000	RoHS & Green	NIPDAU   SN	Level-1-260C-UNLIM	-40 to 105	(39GH, A32U)	<a href="#">Samples</a>
SN74AHC1G32TDCKRQ1	ACTIVE	SC70	DCK	5	3000	RoHS & Green	NIPDAU	Level-1-260C-UNLIM	-40 to 105	AGU	<a href="#">Samples</a>

(1) The marketing status values are defined as follows:

**ACTIVE:** Product device recommended for new designs.

**LIFEBUY:** TI has announced that the device will be discontinued, and a lifetime-buy period is in effect.

**NRND:** Not recommended for new designs. Device is in production to support existing customers, but TI does not recommend using this part in a new design.

**PREVIEW:** Device has been announced but is not in production. Samples may or may not be available.

**OBSOLETE:** TI has discontinued the production of the device.

(2) **RoHS:** TI defines "RoHS" to mean semiconductor products that are compliant with the current EU RoHS requirements for all 10 RoHS substances, including the requirement that RoHS substance do not exceed 0.1% by weight in homogeneous materials. Where designed to be soldered at high temperatures, "RoHS" products are suitable for use in specified lead-free processes. TI may reference these types of products as "Pb-Free".

**RoHS Exempt:** TI defines "RoHS Exempt" to mean products that contain lead but are compliant with EU RoHS pursuant to a specific EU RoHS exemption.

**Green:** TI defines "Green" to mean the content of Chlorine (Cl) and Bromine (Br) based flame retardants meet JS709B low halogen requirements of <=1000ppm threshold. Antimony trioxide based flame retardants must also meet the <=1000ppm threshold requirement.

(3) MSL, Peak Temp. - The Moisture Sensitivity Level rating according to the JEDEC industry standard classifications, and peak solder temperature.

(4) There may be additional marking, which relates to the logo, the lot trace code information, or the environmental category on the device.

(5) Multiple Device Markings will be inside parentheses. Only one Device Marking contained in parentheses and separated by a "-" will appear on a device. If a line is indented then it is a continuation of the previous line and the two combined represent the entire Device Marking for that device.

(6) Lead finish/Ball material - Orderable Devices may have multiple material finish options. Finish options are separated by a vertical ruled line. Lead finish/Ball material values may wrap to two lines if the finish value exceeds the maximum column width.

**Important Information and Disclaimer:**The information provided on this page represents TI's knowledge and belief as of the date that it is provided. TI bases its knowledge and belief on information provided by third parties, and makes no representation or warranty as to the accuracy of such information. Efforts are underway to better integrate information from third parties. TI has taken and

continues to take reasonable steps to provide representative and accurate information but may not have conducted destructive testing or chemical analysis on incoming materials and chemicals. TI and TI suppliers consider certain information to be proprietary, and thus CAS numbers and other limited information may not be available for release.

In no event shall TI's liability arising out of such information exceed the total purchase price of the TI part(s) at issue in this document sold by TI to Customer on an annual basis.

**OTHER QUALIFIED VERSIONS OF SN74AHC1G32-Q1 :**

- Catalog : [SN74AHC1G32](#)

NOTE: Qualified Version Definitions:

- Catalog - TI's standard catalog product

## TAPE AND REEL INFORMATION



### QUADRANT ASSIGNMENTS FOR PIN 1 ORIENTATION IN TAPE



\*All dimensions are nominal

Device	Package Type	Package Drawing	Pins	SPQ	Reel Diameter (mm)	Reel Width W1 (mm)	A0 (mm)	B0 (mm)	K0 (mm)	P1 (mm)	W (mm)	Pin1 Quadrant
SN74AHC1G32QDBVRQ1	SOT-23	DBV	5	3000	180.0	8.4	3.2	3.2	1.4	4.0	8.0	Q3
SN74AHC1G32QDCKRQ1	SC70	DCK	5	3000	178.0	9.0	2.4	2.5	1.2	4.0	8.0	Q3
SN74AHC1G32TDBVRQ1	SOT-23	DBV	5	3000	179.0	8.4	3.2	3.2	1.4	4.0	8.0	Q3
SN74AHC1G32TDCKRQ1	SC70	DCK	5	3000	178.0	9.0	2.4	2.5	1.2	4.0	8.0	Q3

## TAPE AND REEL BOX DIMENSIONS



\*All dimensions are nominal

Device	Package Type	Package Drawing	Pins	SPQ	Length (mm)	Width (mm)	Height (mm)
SN74AHC1G32QDBVRQ1	SOT-23	DBV	5	3000	210.0	185.0	35.0
SN74AHC1G32QDCKRQ1	SC70	DCK	5	3000	190.0	190.0	30.0
SN74AHC1G32TDBVRQ1	SOT-23	DBV	5	3000	200.0	183.0	25.0
SN74AHC1G32TDCKRQ1	SC70	DCK	5	3000	190.0	190.0	30.0





# EXAMPLE BOARD LAYOUT

DBV0005A

SOT-23 - 1.45 mm max height

SMALL OUTLINE TRANSISTOR



LAND PATTERN EXAMPLE  
EXPOSED METAL SHOWN  
SCALE:15X



SOLDER MASK DETAILS

4214839/K 08/2024

NOTES: (continued)

- 6. Publication IPC-7351 may have alternate designs.
- 7. Solder mask tolerances between and around signal pads can vary based on board fabrication site.

# EXAMPLE STENCIL DESIGN

DBV0005A

SOT-23 - 1.45 mm max height

SMALL OUTLINE TRANSISTOR



SOLDER PASTE EXAMPLE  
BASED ON 0.125 mm THICK STENCIL  
SCALE:15X

4214839/K 08/2024

NOTES: (continued)

8. Laser cutting apertures with trapezoidal walls and rounded corners may offer better paste release. IPC-7525 may have alternate design recommendations.
9. Board assembly site may have different recommendations for stencil design.

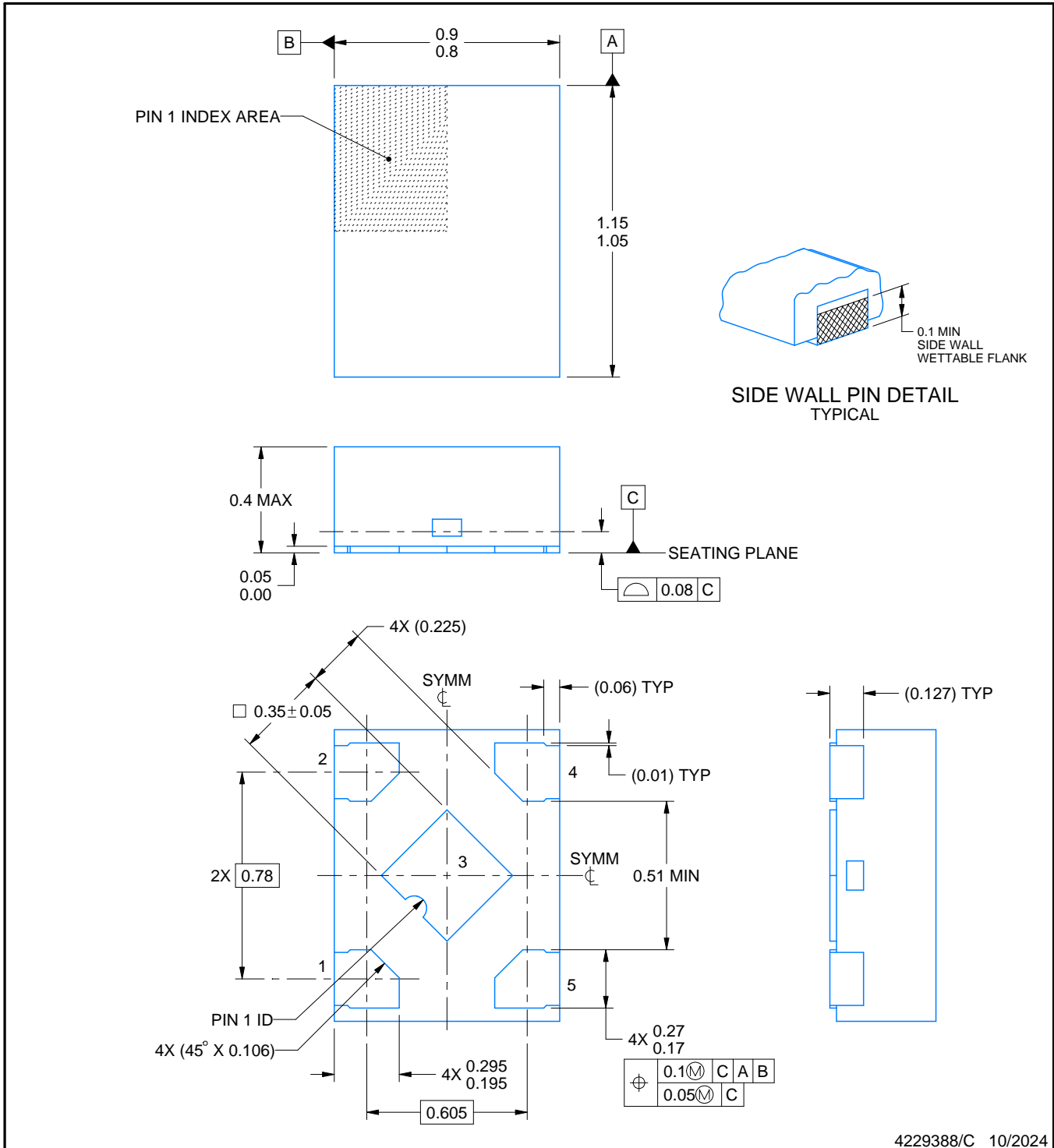
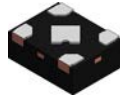

4229388/C 10/2024

NOTES:

1. All linear dimensions are in millimeters. Any dimensions in parenthesis are for reference only. Dimensioning and tolerancing per ASME Y14.5M.
2. This drawing is subject to change without notice.
3. The package thermal pad must be soldered to the printed circuit board for thermal and mechanical performance.

# EXAMPLE BOARD LAYOUT

DTX0005A

X2SON - 0.4 mm max height

PLASTIC SMALL OUTLINE - NO LEAD

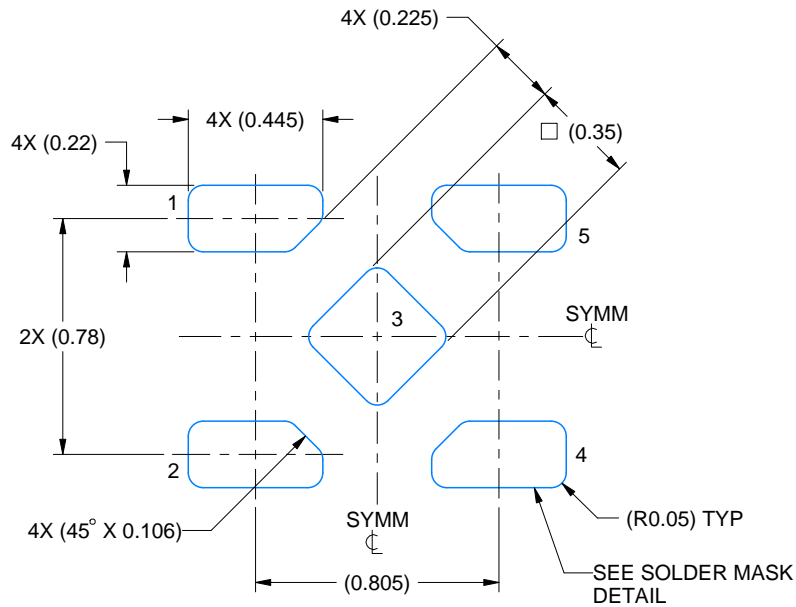

LAND PATTERN EXAMPLE  
EXPOSED METAL SHOWN  
SCALE: 40X

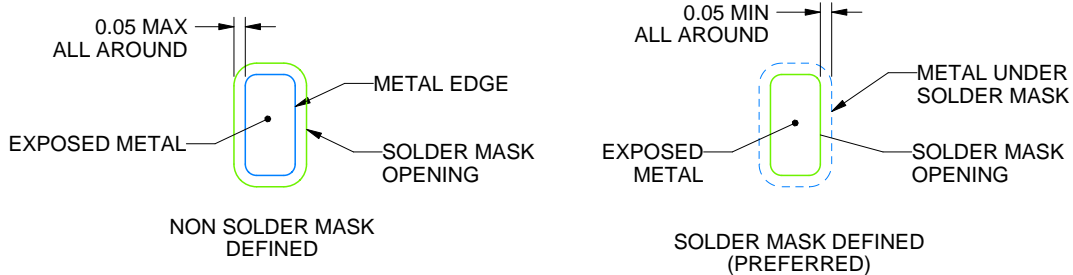

SOLDER MASK DETAILS

4229388/C 10/2024

NOTES: (continued)

4. This package is designed to be soldered to a thermal pad on the board. For more information, see Texas Instruments literature number SLUA271 ([www.ti.com/lit/slua271](http://www.ti.com/lit/slua271)).

# EXAMPLE STENCIL DESIGN

DTX0005A

X2SON - 0.4 mm max height

PLASTIC SMALL OUTLINE - NO LEAD

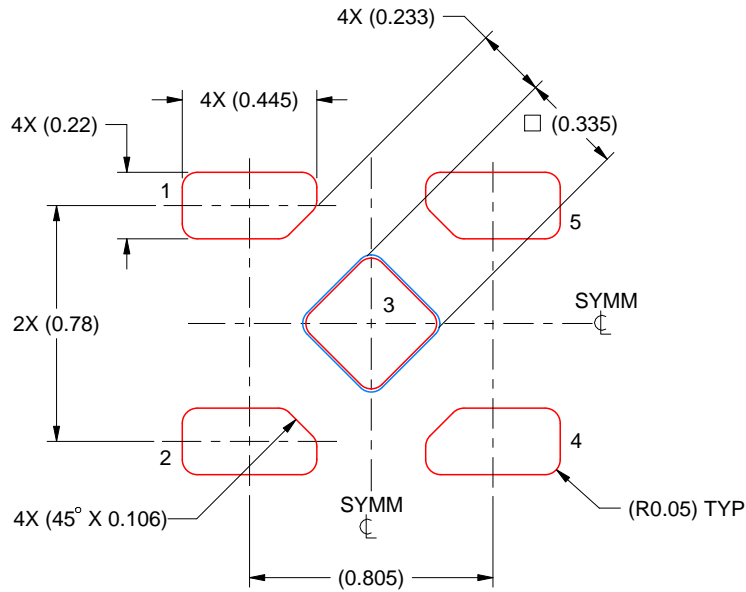

SOLDER PASTE EXAMPLE  
BASED ON 0.1 mm THICK STENCIL  
SCALE: 40X

PRINTED SOLDER PASTE COVERAGE BY AREA UNDER PACKAGE  
PAD 5: 92%

4229388/C 10/2024

NOTES: (continued)

5. Laser cutting apertures with trapezoidal walls and rounded corners may offer better paste release. IPC-7525 may have alternate design recommendations.

# DCK0005A



# PACKAGE OUTLINE

SOT - 1.1 max height

SMALL OUTLINE TRANSISTOR

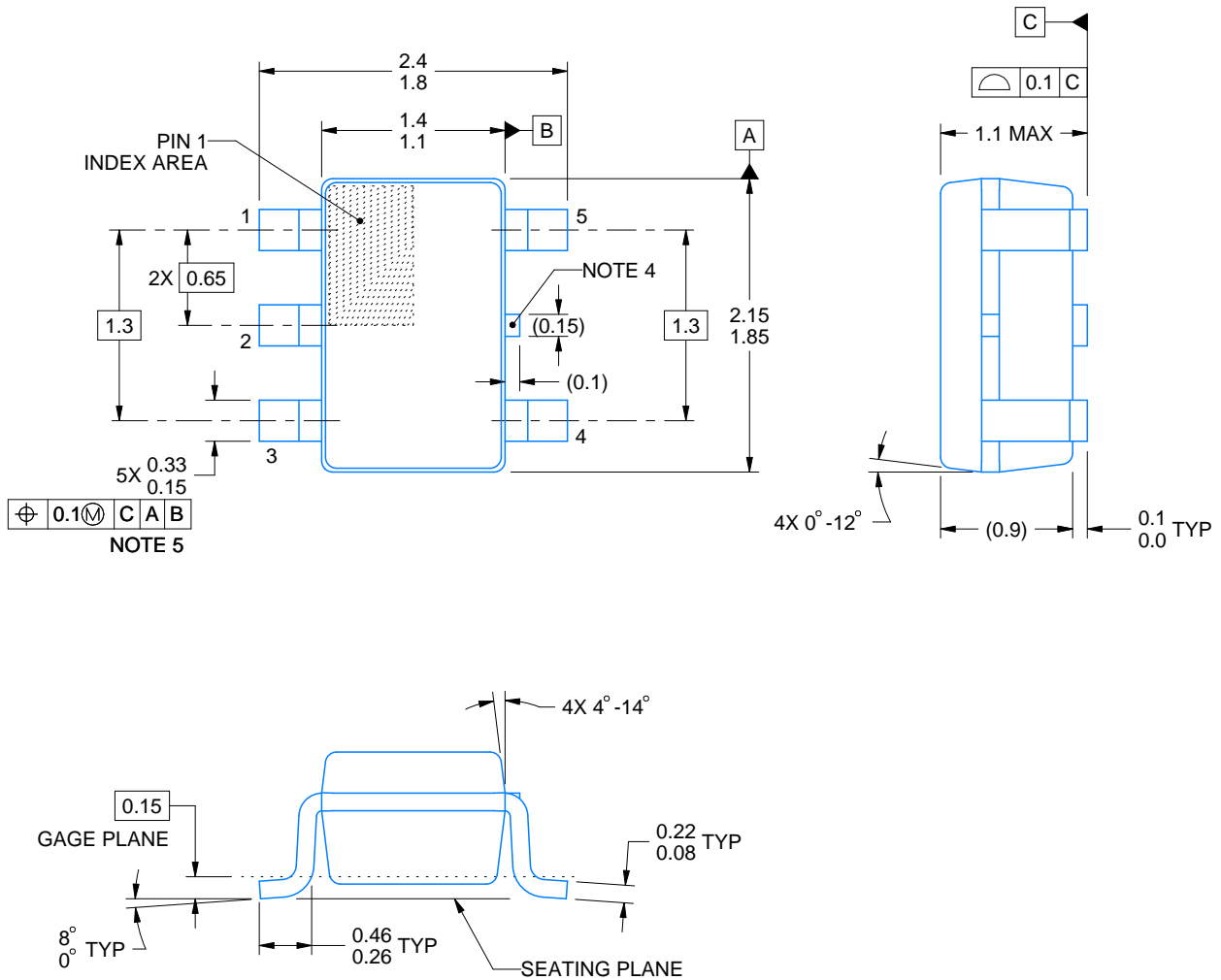

4214834/F 08/2024

## NOTES:

1. All linear dimensions are in millimeters. Any dimensions in parenthesis are for reference only. Dimensioning and tolerancing per ASME Y14.5M.
2. This drawing is subject to change without notice.
3. Reference JEDEC MO-203.
4. Support pin may differ or may not be present.
5. Lead width does not comply with JEDEC.
6. Body dimensions do not include mold flash, protrusions, or gate burrs. Mold flash, protrusions, or gate burrs shall not exceed 0.25mm per side

# EXAMPLE BOARD LAYOUT

DCK0005A

SOT - 1.1 max height

SMALL OUTLINE TRANSISTOR



LAND PATTERN EXAMPLE  
EXPOSED METAL SHOWN  
SCALE:18X

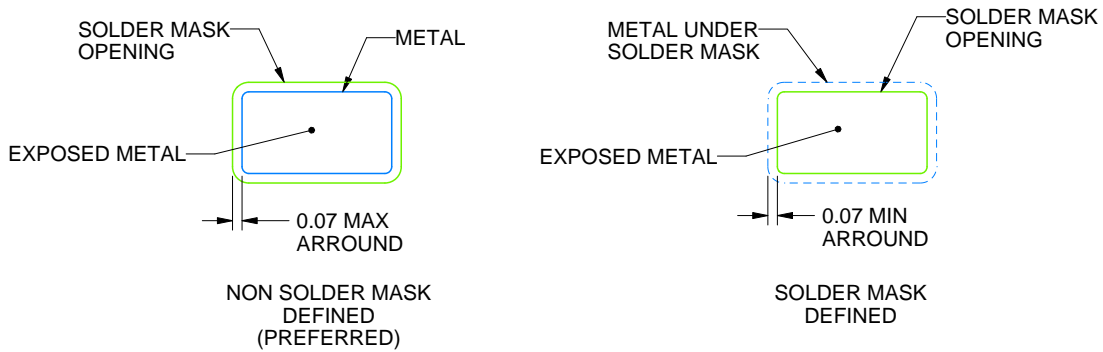

SOLDER MASK DETAILS

4214834/F 08/2024

NOTES: (continued)

7. Publication IPC-7351 may have alternate designs.
8. Solder mask tolerances between and around signal pads can vary based on board fabrication site.

# EXAMPLE STENCIL DESIGN

DCK0005A

SOT - 1.1 max height

SMALL OUTLINE TRANSISTOR



SOLDER PASTE EXAMPLE  
BASED ON 0.125 THICK STENCIL  
SCALE: 18X

4214834/F 08/2024

NOTES: (continued)

9. Laser cutting apertures with trapezoidal walls and rounded corners may offer better paste release. IPC-7525 may have alternate design recommendations.
10. Board assembly site may have different recommendations for stencil design.



## IMPORTANT NOTICE AND DISCLAIMER

TI PROVIDES TECHNICAL AND RELIABILITY DATA (INCLUDING DATA SHEETS), DESIGN RESOURCES (INCLUDING REFERENCE DESIGNS), APPLICATION OR OTHER DESIGN ADVICE, WEB TOOLS, SAFETY INFORMATION, AND OTHER RESOURCES "AS IS" AND WITH ALL FAULTS, AND DISCLAIMS ALL WARRANTIES, EXPRESS AND IMPLIED, INCLUDING WITHOUT LIMITATION ANY IMPLIED WARRANTIES OF MERCHANTABILITY, FITNESS FOR A PARTICULAR PURPOSE OR NON-INFRINGEMENT OF THIRD PARTY INTELLECTUAL PROPERTY RIGHTS.

These resources are intended for skilled developers designing with TI products. You are solely responsible for (1) selecting the appropriate TI products for your application, (2) designing, validating and testing your application, and (3) ensuring your application meets applicable standards, and any other safety, security, regulatory or other requirements.

These resources are subject to change without notice. TI grants you permission to use these resources only for development of an application that uses the TI products described in the resource. Other reproduction and display of these resources is prohibited. No license is granted to any other TI intellectual property right or to any third party intellectual property right. TI disclaims responsibility for, and you will fully indemnify TI and its representatives against, any claims, damages, costs, losses, and liabilities arising out of your use of these resources.

TI's products are provided subject to [TI's Terms of Sale](#) or other applicable terms available either on [ti.com](https://www.ti.com) or provided in conjunction with such TI products. TI's provision of these resources does not expand or otherwise alter TI's applicable warranties or warranty disclaimers for TI products.

TI objects to and rejects any additional or different terms you may have proposed.

Mailing Address: Texas Instruments, Post Office Box 655303, Dallas, Texas 75265  
Copyright © 2024, Texas Instruments Incorporated