

## SN74LVC7032A Quad 2-Input OR Gates with Schmitt-Trigger Inputs

### 1 Features

- Operating range from 1.1V to 3.6V
- 5.5V tolerant input pins
- Supports standard pinouts
- Latch-up performance exceeds 250mA per JESD 17
- ESD protection exceeds JESD 22
  - 2000V Human-Body Model (A114-A)
  - 1000V Charged-Device Model (C101)

### 2 Applications

- [Use fewer inputs to monitor error signals](#)
- [Combine active-low enable signals](#)

### 3 Description

This device contains four independent 2-input OR Gates with Schmitt-trigger inputs. Each gate performs the Boolean function  $Y = A + B$  in positive logic.

#### Package Information

| PART NUMBER  | PACKAGE <sup>(1)</sup> | PACKAGE SIZE <sup>(2)</sup> | BODY SIZE (NOM) <sup>(3)</sup> |
|--------------|------------------------|-----------------------------|--------------------------------|
| SN74LVC7032A | BQA (WQFN, 14)         | 3mm × 2.5mm                 | 3mm × 2.5mm                    |
|              | PW (TSSOP, 14)         | 5mm × 6.4mm                 | 5mm × 4.4mm                    |

- (1) For more information, see [Section 11](#)
- (2) The package size (length × width) is a nominal value and includes pins, where applicable
- (3) The body size (length × width) is a nominal value and does not include pins.

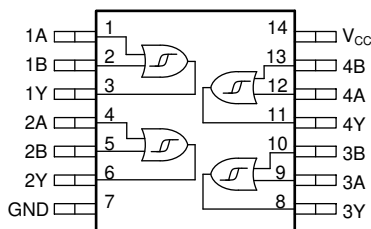

Functional Pinout



## Table of Contents

|                                                  |    |                                                                      |    |
|--------------------------------------------------|----|----------------------------------------------------------------------|----|
| <b>1 Features</b> .....                          | 1  | 7.3 Feature Description.....                                         | 10 |
| <b>2 Applications</b> .....                      | 1  | 7.4 Device Functional Modes.....                                     | 11 |
| <b>3 Description</b> .....                       | 1  | <b>8 Application and Implementation</b> .....                        | 12 |
| <b>4 Pin Configuration and Functions</b> .....   | 3  | 8.1 Application Information.....                                     | 12 |
| <b>5 Specifications</b> .....                    | 4  | 8.2 Typical Application.....                                         | 12 |
| 5.1 Absolute Maximum Ratings.....                | 4  | 8.3 Power Supply Recommendations.....                                | 14 |
| 5.2 ESD Ratings.....                             | 4  | 8.4 Layout.....                                                      | 14 |
| 5.3 Recommended Operating Conditions.....        | 4  | <b>9 Device and Documentation Support</b> .....                      | 16 |
| 5.4 Thermal Information.....                     | 5  | 9.1 Documentation Support.....                                       | 16 |
| 5.5 Electrical Characteristics.....              | 5  | 9.2 Receiving Notification of Documentation Updates....              | 16 |
| 5.6 Switching Characteristics.....               | 6  | 9.3 Support Resources.....                                           | 16 |
| 5.7 Noise Characteristics.....                   | 6  | 9.4 Trademarks.....                                                  | 16 |
| 5.8 Typical Characteristics.....                 | 7  | 9.5 Electrostatic Discharge Caution.....                             | 16 |
| <b>6 Parameter Measurement Information</b> ..... | 9  | 9.6 Glossary.....                                                    | 16 |
| <b>7 Detailed Description</b> .....              | 10 | <b>10 Revision History</b> .....                                     | 16 |
| 7.1 Overview.....                                | 10 | <b>11 Mechanical, Packaging, and Orderable<br/>Information</b> ..... | 16 |
| 7.2 Functional Block Diagram.....                | 10 |                                                                      |    |

## 4 Pin Configuration and Functions

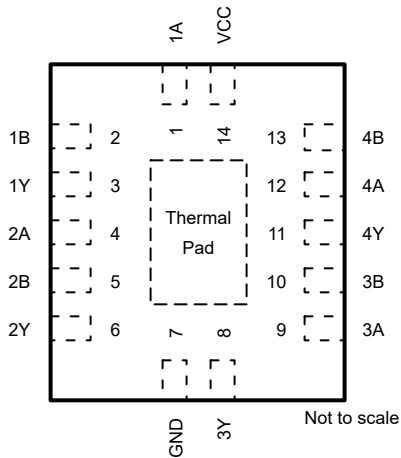

**Figure 4-1. SN74LVC7032A BQA Package, 14-Pin WQFN (Top View)**

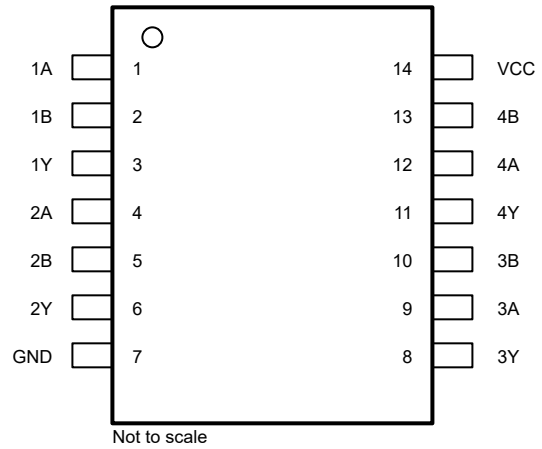

**Figure 4-2. SN74LVC7032A PW Package, 14-Pin TSSOP (Top View)**

**Table 4-1. Pin Functions**

| PIN                        |     | TYPE <sup>(1)</sup> | DESCRIPTION                                                                                             |
|----------------------------|-----|---------------------|---------------------------------------------------------------------------------------------------------|
| NAME                       | NO. |                     |                                                                                                         |
| 1A                         | 1   | I                   | Channel 1, Input A                                                                                      |
| 1B                         | 2   | I                   | Channel 1, Input B                                                                                      |
| 1Y                         | 3   | O                   | Channel 1, Output Y                                                                                     |
| 2A                         | 4   | I                   | Channel 2, Input A                                                                                      |
| 2B                         | 5   | I                   | Channel 2, Input B                                                                                      |
| 2Y                         | 6   | O                   | Channel 2, Output Y                                                                                     |
| GND                        | 7   | —                   | Ground                                                                                                  |
| 3Y                         | 8   | O                   | Channel 3, Output Y                                                                                     |
| 3A                         | 9   | I                   | Channel 3, Input A                                                                                      |
| 3B                         | 10  | I                   | Channel 3, Input B                                                                                      |
| 4Y                         | 11  | O                   | Channel 4, Output Y                                                                                     |
| 4A                         | 12  | I                   | Channel 4, Input A                                                                                      |
| 4B                         | 13  | I                   | Channel 4, Input B                                                                                      |
| VCC                        | 14  | —                   | Positive Supply                                                                                         |
| Thermal Pad <sup>(2)</sup> |     | —                   | The thermal pad can be connected to GND or left floating. Do not connect to any other signal or supply. |

(1) I = input, O = output, I/O = input or output, G = ground, P = power.

(2) BQA package only.

## 5 Specifications

### 5.1 Absolute Maximum Ratings

over operating free-air temperature range (unless otherwise noted)<sup>(1)</sup>

|                  |                                                          |                     | MIN  | MAX                   | UNIT |
|------------------|----------------------------------------------------------|---------------------|------|-----------------------|------|
| V <sub>CC</sub>  | Supply voltage range                                     |                     | -0.5 | 6.5                   | V    |
| V <sub>I</sub>   | Input voltage range <sup>(2)</sup>                       |                     | -0.5 | 6.5                   | V    |
| V <sub>O</sub>   | Output voltage range <sup>(2)</sup>                      |                     | -0.5 | V <sub>CC</sub> + 0.5 | V    |
| I <sub>IK</sub>  | Input clamp current                                      | V <sub>I</sub> < 0V |      | -50                   | mA   |
| I <sub>OK</sub>  | Output clamp current                                     | V <sub>O</sub> < 0V |      | -50                   | mA   |
| I <sub>O</sub>   | Continuous output current                                |                     |      | ±50                   | mA   |
| I <sub>O</sub>   | Continuous output current through V <sub>CC</sub> or GND |                     |      | ±100                  | mA   |
| T <sub>J</sub>   | Junction temperature                                     |                     | -65  | 150                   | °C   |
| T <sub>stg</sub> | Storage temperature                                      |                     | -65  | 150                   | °C   |

- (1) Operation outside the *Absolute Maximum Ratings* may cause permanent device damage. Absolute maximum ratings do not imply functional operation of the device at these or any other conditions beyond those listed under *Recommended Operating Conditions*. If briefly operating outside the *Recommended Operating Conditions* but within the *Absolute Maximum Ratings*, the device may not sustain damage, but it may not be fully functional. Operating the device in this manner may affect device reliability, functionality, performance, and shorten the device lifetime.
- (2) The input and output voltage ratings may be exceeded if the input and output current ratings are observed.

### 5.2 ESD Ratings

|                    |                         |                                                                       | VALUE | UNIT |
|--------------------|-------------------------|-----------------------------------------------------------------------|-------|------|
| V <sub>(ESD)</sub> | Electrostatic discharge | Human-body model (HBM), per ANSI/ESDA/JEDEC JS-001 <sup>(1)</sup>     | ±2000 | V    |
|                    |                         | Charged-device model (CDM), per ANSI/ESDA/JEDEC JS-002 <sup>(2)</sup> | ±1000 |      |

- (1) JEDEC document JEP155 states that 500-V HBM allows safe manufacturing with a standard ESD control process.
- (2) JEDEC document JEP157 states that 250-V CDM allows safe manufacturing with a standard ESD control process.

### 5.3 Recommended Operating Conditions

over operating free-air temperature range (unless otherwise noted)

| Specifications  | Description                        | Condition              | MIN | MAX             | UNIT |
|-----------------|------------------------------------|------------------------|-----|-----------------|------|
| V <sub>CC</sub> | Supply voltage                     |                        | 1.1 | 3.6             | V    |
| V <sub>I</sub>  | Input voltage                      |                        |     | 5.5             | V    |
| V <sub>O</sub>  | Output voltage                     | (High or low state)    |     | V <sub>CC</sub> | V    |
| I <sub>OH</sub> | High-level output current          | V <sub>CC</sub> = 1.8V |     | -4              | mA   |
|                 |                                    | V <sub>CC</sub> = 2.3V |     | -8              |      |
|                 |                                    | V <sub>CC</sub> = 2.7V |     | -12             |      |
|                 |                                    | V <sub>CC</sub> = 3V   |     | -24             |      |
| I <sub>OL</sub> | Low-level output current           | V <sub>CC</sub> = 1.8V |     | 4               | mA   |
|                 |                                    | V <sub>CC</sub> = 2.3V |     | 8               |      |
|                 |                                    | V <sub>CC</sub> = 2.7V |     | 12              |      |
|                 |                                    | V <sub>CC</sub> = 3V   |     | 24              |      |
| Δt/Δv           | Input transition rise or fall rate |                        |     | 10              | ns/V |
| T <sub>A</sub>  | Operating free-air temperature     |                        | -40 | 125             | °C   |

## 5.4 Thermal Information

| THERMAL METRIC <sup>(1)</sup> |                                              | Package Options |            | UNIT |
|-------------------------------|----------------------------------------------|-----------------|------------|------|
|                               |                                              | PW (TSSOP)      | BQA (WQFN) |      |
|                               |                                              | 14 PINS         | 14 PINS    |      |
| R <sub>θJA</sub>              | Junction-to-ambient thermal resistance       | 150.8           | 102.3      | °C/W |
| R <sub>θJC(top)</sub>         | Junction-to-case (top) thermal resistance    | 78.3            | 96.8       | °C/W |
| R <sub>θJB</sub>              | Junction-to-board thermal resistance         | 93.8            | 70.9       | °C/W |
| Ψ <sub>JT</sub>               | Junction-to-top characterization parameter   | 24.7            | 16.6       | °C/W |
| Y <sub>JB</sub>               | Junction-to-board characterization parameter | 93.2            | 70.9       | °C/W |
| R <sub>θJC(bot)</sub>         | Junction-to-case (bottom) thermal resistance | -               | 50.1       | °C/W |

(1) For more information about traditional and new thermal metrics, see the [Semiconductor and IC Package Thermal Metrics](#) application report.

## 5.5 Electrical Characteristics

over operating free-air temperature range (unless otherwise noted)

| PARAMETER       | TEST CONDITIONS                                 | V <sub>CC</sub> | -40°C to 125°C        |     |      | UNIT |
|-----------------|-------------------------------------------------|-----------------|-----------------------|-----|------|------|
|                 |                                                 |                 | MIN                   | TYP | MAX  |      |
| V <sub>T+</sub> | Positive-going input threshold voltage          | 1.1V            | 0.5                   |     | 0.8  | V    |
| V <sub>T+</sub> | Positive-going input threshold voltage          | 1.5V            | 0.7                   |     | 1.11 | V    |
| V <sub>T+</sub> | Positive-going input threshold voltage          | 1.65V           | 0.4                   |     | 1.3  | V    |
| V <sub>T+</sub> | Positive-going input threshold voltage          | 1.95V           | 0.6                   |     | 1.5  | V    |
| V <sub>T+</sub> | Positive-going input threshold voltage          | 2.3V            | 0.8                   |     | 1.7  | V    |
| V <sub>T+</sub> | Positive-going input threshold voltage          | 2.5V            | 0.8                   |     | 1.7  | V    |
| V <sub>T+</sub> | Positive-going input threshold voltage          | 2.7V            | 0.8                   |     | 2    | V    |
| V <sub>T+</sub> | Positive-going input threshold voltage          | 3V              | 0.9                   |     | 2    | V    |
| V <sub>T+</sub> | Positive-going input threshold voltage          | 3.6V            | 1.1                   |     | 2    | V    |
| V <sub>T-</sub> | Negative-going input threshold voltage          | 1.1V            | 0.2                   |     | 0.6  | V    |
| V <sub>T-</sub> | Negative-going input threshold voltage          | 1.5V            | 0.34                  |     | 0.75 | V    |
| V <sub>T-</sub> | Negative-going input threshold voltage          | 1.65V           | 0.2                   |     | 0.9  | V    |
| V <sub>T-</sub> | Negative-going input threshold voltage          | 1.95V           | 0.3                   |     | 1    | V    |
| V <sub>T-</sub> | Negative-going input threshold voltage          | 2.3V            | 0.4                   |     | 1.2  | V    |
| V <sub>T-</sub> | Negative-going input threshold voltage          | 2.5V            | 0.4                   |     | 1.2  | V    |
| V <sub>T-</sub> | Negative-going input threshold voltage          | 2.7V            | 0.4                   |     | 1.4  | V    |
| V <sub>T-</sub> | Negative-going input threshold voltage          | 3V              | 0.6                   |     | 1.5  | V    |
| V <sub>T-</sub> | Negative-going input threshold voltage          | 3.6V            | 0.8                   |     | 1.7  | V    |
| ΔV <sub>T</sub> | Hysteresis (V <sub>T+</sub> - V <sub>T-</sub> ) | 1.1V            | 0.07                  |     | 0.53 | V    |
| ΔV <sub>T</sub> | Hysteresis (V <sub>T+</sub> - V <sub>T-</sub> ) | 1.5V            | 0.18                  |     | 0.60 | V    |
| ΔV <sub>T</sub> | Hysteresis (V <sub>T+</sub> - V <sub>T-</sub> ) | 1.65V           | 0.1                   |     | 1.2  | V    |
| ΔV <sub>T</sub> | Hysteresis (V <sub>T+</sub> - V <sub>T-</sub> ) | 1.95V           | 0.2                   |     | 1.3  | V    |
| ΔV <sub>T</sub> | Hysteresis (V <sub>T+</sub> - V <sub>T-</sub> ) | 2.3V            | 0.3                   |     | 1.3  | V    |
| ΔV <sub>T</sub> | Hysteresis (V <sub>T+</sub> - V <sub>T-</sub> ) | 2.5V            | 0.3                   |     | 1.3  | V    |
| ΔV <sub>T</sub> | Hysteresis (V <sub>T+</sub> - V <sub>T-</sub> ) | 2.7V            | 0.3                   |     | 1.1  | V    |
| ΔV <sub>T</sub> | Hysteresis (V <sub>T+</sub> - V <sub>T-</sub> ) | 3V              | 0.3                   |     | 1.2  | V    |
| ΔV <sub>T</sub> | Hysteresis (V <sub>T+</sub> - V <sub>T-</sub> ) | 3.6V            | 0.3                   |     | 1.2  | V    |
| V <sub>OH</sub> | I <sub>OH</sub> = -100μA                        | 1.1V to 3.6V    | V <sub>CC</sub> - 0.2 |     |      | V    |
| V <sub>OH</sub> | I <sub>OH</sub> = -4mA                          | 1.65V           | 1.2                   |     |      | V    |

## 5.5 Electrical Characteristics (continued)

over operating free-air temperature range (unless otherwise noted)

| PARAMETER        | TEST CONDITIONS                                                             | V <sub>CC</sub> | -40°C to 125°C |     |     | UNIT |
|------------------|-----------------------------------------------------------------------------|-----------------|----------------|-----|-----|------|
|                  |                                                                             |                 | MIN            | TYP | MAX |      |
| V <sub>OH</sub>  | I <sub>OH</sub> = -8mA                                                      | 2.3V            | 1.75           |     |     | V    |
| V <sub>OH</sub>  | I <sub>OH</sub> = -12mA                                                     | 2.7V            | 2.2            |     |     | V    |
| V <sub>OH</sub>  |                                                                             | 3V              | 2.4            |     |     | V    |
| V <sub>OH</sub>  | I <sub>OH</sub> = -24mA                                                     | 3V              | 2.2            |     |     | V    |
| V <sub>OL</sub>  | I <sub>OH</sub> = 100μA                                                     | 1.1V to 3.6V    | 0.15           |     |     | V    |
| V <sub>OL</sub>  | I <sub>OH</sub> = 4mA                                                       | 1.65V           | 0.45           |     |     | V    |
| V <sub>OL</sub>  | I <sub>OH</sub> = 8mA                                                       | 2.3V            | 0.7            |     |     | V    |
| V <sub>OL</sub>  | I <sub>OH</sub> = 12mA                                                      | 2.7V            | 0.4            |     |     | V    |
| V <sub>OL</sub>  | I <sub>OH</sub> = 24mA                                                      | 3V              | 0.55           |     |     | V    |
| I <sub>I</sub>   | V <sub>I</sub> = V <sub>CC</sub> or GND                                     | 3.6V            | ±5             |     |     | μA   |
| I <sub>off</sub> | V <sub>I</sub> or V <sub>O</sub> = V <sub>CC</sub>                          | 0V              | ±10            |     |     | μA   |
| I <sub>CC</sub>  | V <sub>I</sub> = V <sub>CC</sub> or GND, I <sub>O</sub> = 0                 | 3.6V            | 40             |     |     | μA   |
| ΔI <sub>CC</sub> | One input at V <sub>CC</sub> - 0.6V, other inputs at V <sub>CC</sub> or GND | 2.7V to 3.6V    | 500            |     |     | μA   |
| C <sub>I</sub>   | V <sub>I</sub> = V <sub>CC</sub> or GND                                     | 3.3V            |                |     |     | pF   |
| C <sub>O</sub>   | V <sub>O</sub> = V <sub>CC</sub> or GND                                     | 3.3V            |                |     |     | pF   |
| C <sub>PD</sub>  | f = 10MHz                                                                   | 1.8V            | 31             |     |     | pF   |
| C <sub>PD</sub>  | f = 10MHz                                                                   | 2.5V            | 31             |     |     | pF   |
| C <sub>PD</sub>  | f = 10MHz                                                                   | 3.3V            | 32             |     |     | pF   |

## 5.6 Switching Characteristics

over operating free-air temperature range; typical values measured at T<sub>A</sub> = 25°C (unless otherwise noted). See *Parameter Measurement Information*

| PARAMETER          | FROM (INPUT) | TO (OUTPUT) | LOAD CAPACITANCE      | V <sub>CC</sub> | -40°C to 125°C |     |     | UNIT |
|--------------------|--------------|-------------|-----------------------|-----------------|----------------|-----|-----|------|
|                    |              |             |                       |                 | MIN            | TYP | MAX |      |
| t <sub>pd</sub>    | A or B       | Y           | C <sub>L</sub> = 15pF | 1.2V ± 0.1V     | 12             |     | 44  | ns   |
| t <sub>pd</sub>    | A or B       | Y           | C <sub>L</sub> = 15pF | 1.5V ± 0.12V    | 9              |     | 15  | ns   |
| t <sub>pd</sub>    | A or B       | Y           | C <sub>L</sub> = 30pF | 1.8V ± 0.15V    | 10.2           |     |     | ns   |
| t <sub>pd</sub>    | A or B       | Y           | C <sub>L</sub> = 30pF | 2.5V ± 0.2V     | 6.9            |     |     | ns   |
| t <sub>pd</sub>    | A or B       | Y           | C <sub>L</sub> = 50pF | 2.7V            | 6.4            |     |     | ns   |
| t <sub>pd</sub>    | A or B       | Y           | C <sub>L</sub> = 50pF | 3.3V ± 0.3V     | 5.6            |     |     | ns   |
| t <sub>sk(o)</sub> |              |             |                       | 3.3V ± 0.3V     | 1.5            |     |     | ns   |

## 5.7 Noise Characteristics

V<sub>CC</sub> = 3.3V, C<sub>L</sub> = 50pF, T<sub>A</sub> = 25°C

| PARAMETER          | DESCRIPTION                                   | MIN  | TYP  | MAX | UNIT |
|--------------------|-----------------------------------------------|------|------|-----|------|
| V <sub>OL(P)</sub> | Quiet output, maximum dynamic V <sub>OL</sub> |      | 0.9  | 0.8 | V    |
| V <sub>OL(V)</sub> | Quiet output, minimum dynamic V <sub>OL</sub> | -0.8 | -0.3 |     | V    |
| V <sub>OH(V)</sub> | Quiet output, minimum dynamic V <sub>OH</sub> | 2.2  | 3.3  |     | V    |
| V <sub>IH(D)</sub> | High-level dynamic input voltage              | 2.0  |      |     | V    |
| V <sub>IL(D)</sub> | Low-level dynamic input voltage               |      |      | 0.8 | V    |

## 5.8 Typical Characteristics

$T_A = 25^\circ\text{C}$  (unless otherwise noted)

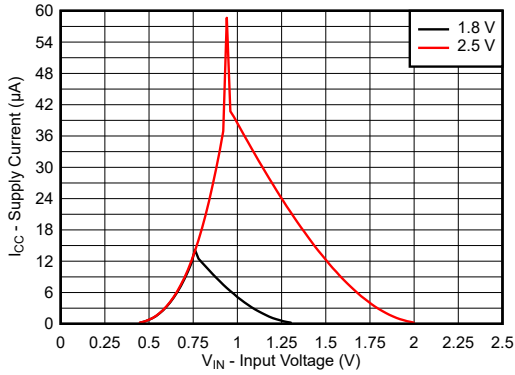

**Figure 5-1. Supply Current Across Input Voltage 1.8V and 2.5V Supply**

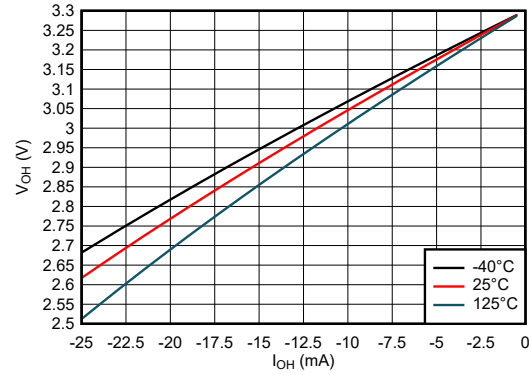

**Figure 5-2. Output Voltage vs Current in HIGH State; 3.3V Supply**

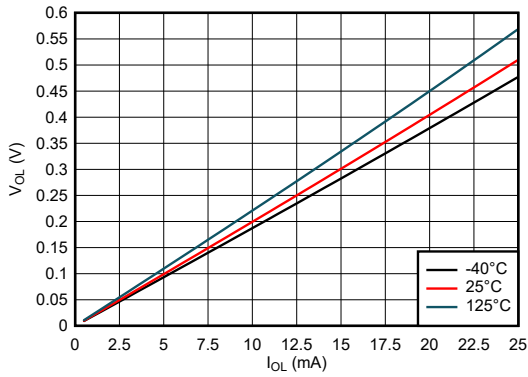

**Figure 5-3. Output Voltage vs Current in LOW State; 3.3V Supply**

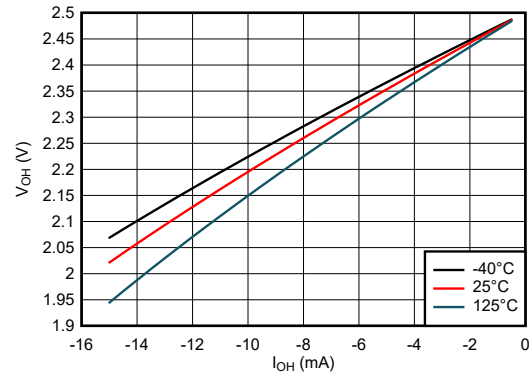

**Figure 5-4. Output Voltage vs Current in HIGH State; 2.5V Supply**

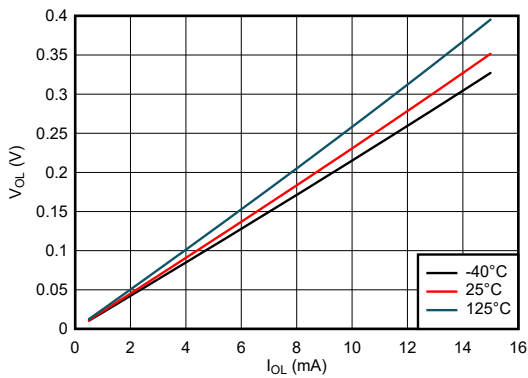

**Figure 5-5. Output Voltage vs Current in LOW State; 2.5V Supply**

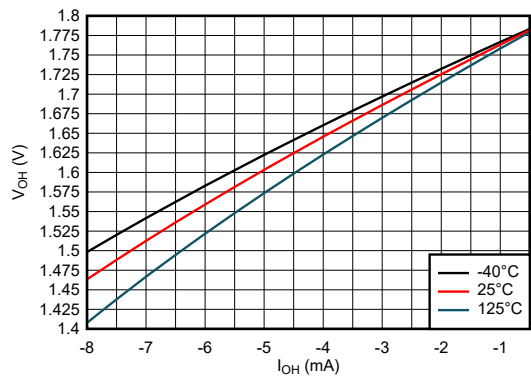

**Figure 5-6. Output Voltage vs Current in HIGH State; 1.8V Supply**

## 5.8 Typical Characteristics (continued)

T<sub>A</sub> = 25°C (unless otherwise noted)

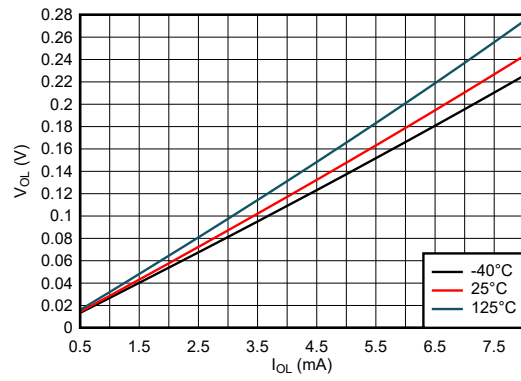

Figure 5-7. Output Voltage vs Current in LOW State; 1.8V Supply



## 6 Parameter Measurement Information

Phase relationships between waveforms were chosen arbitrarily. All input pulses are supplied by generators having the following characteristics: PRR ≤ 1MHz,  $Z_O = 50\Omega$ .

For clock inputs,  $f_{max}$  is measured when the input duty cycle is 50%.

The outputs are measured one at a time with one input transition per measurement.



(1)  $C_L$  includes probe and test-fixture capacitance.

**Figure 6-1. Load Circuit for Push-Pull Outputs**

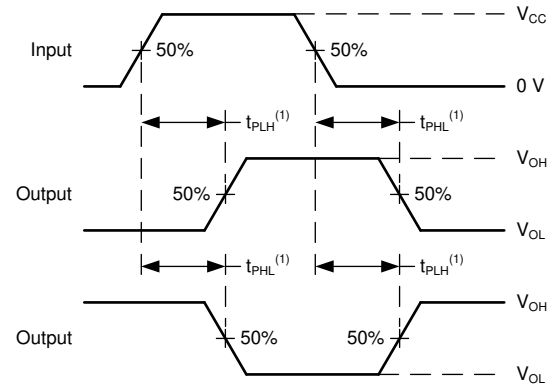

(1) The greater between  $t_{PLH}$  and  $t_{PHL}$  is the same as  $t_{pd}$ .

**Figure 6-2. Voltage Waveforms Propagation Delays**

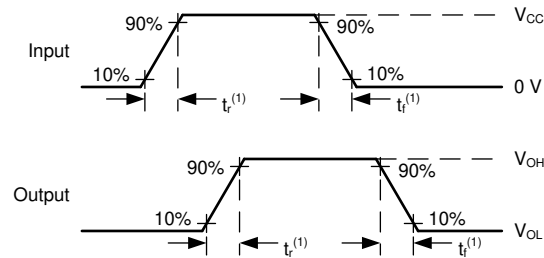

(1) The greater between  $t_r$  and  $t_f$  is the same as  $t_t$ .

**Figure 6-3. Voltage Waveforms, Input and Output Transition Times**

## 7 Detailed Description

### 7.1 Overview

This device contains four independent 2-input OR Gates with Schmitt-trigger inputs. Each gate performs the Boolean function  $Y = A + B$  in positive logic.

### 7.2 Functional Block Diagram

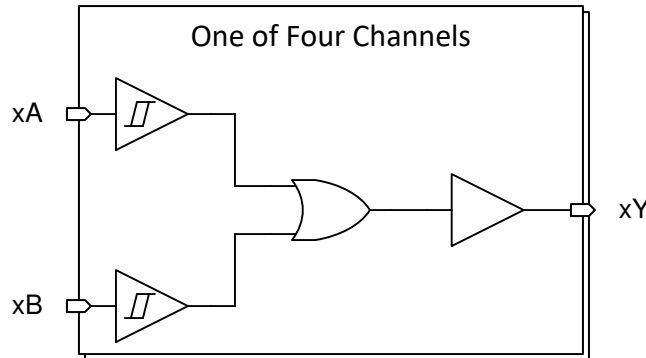

### 7.3 Feature Description

#### 7.3.1 CMOS Schmitt-Trigger Inputs

This device includes inputs with the Schmitt-trigger architecture. These inputs are high impedance and are typically modeled as a resistor in parallel with the input capacitance given in the *Electrical Characteristics* table from the input to ground. The worst case resistance is calculated with the maximum input voltage, given in the *Absolute Maximum Ratings* table, and the maximum input leakage current, given in the *Electrical Characteristics* table, using Ohm's law ( $R = V \div I$ ).

The Schmitt-trigger input architecture provides hysteresis as defined by  $\Delta V_T$  in the *Electrical Characteristics* table, which makes this device extremely tolerant to slow or noisy inputs. While the inputs can be driven much slower than standard CMOS inputs, it is still recommended to properly terminate unused inputs. Driving the inputs with slow transitioning signals will increase dynamic current consumption of the device. For additional information regarding Schmitt-trigger inputs, please see [Understanding Schmitt Triggers](#).

#### 7.3.2 Balanced CMOS Push-Pull Outputs

A balanced output allows the device to sink and source similar currents. The drive capability of this device may create fast edges into light loads so routing and load conditions should be considered to prevent ringing. Additionally, the outputs of this device are capable of driving larger currents than the device can sustain without being damaged. It is important for the output power of the device to be limited to avoid damage due to over-current. The electrical and thermal limits defined in the *Absolute Maximum Ratings* must be followed at all times.

The device can drive a load with a total capacitance less than or equal to the maximum load listed in the *Switching Characteristics - 74* connected to a high-impedance CMOS input while still meeting all of the data sheet specifications. Larger capacitive loads can be applied, however it is not recommended to exceed the provided load value. If larger capacitive loads are required, it is recommended to add a series resistor between the output and the capacitor to limit output current to the values given in the *Absolute Maximum Ratings*.

#### 7.3.3 Clamp Diode Structure

Figure 7-1 shows the inputs and outputs to this device have negative clamping diodes only.

#### CAUTION

Voltages beyond the values specified in the *Absolute Maximum Ratings* table can cause damage to the device. The input and output voltage ratings may be exceeded if the input and output clamp-current ratings are observed.

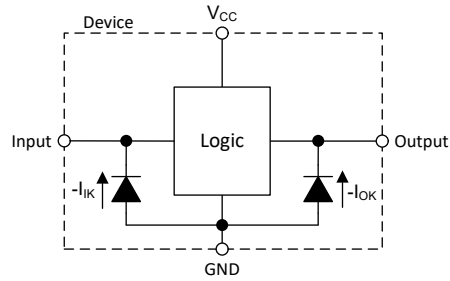

**Figure 7-1. Electrical Placement of Clamping Diodes for Each Input and Output**

## 7.4 Device Functional Modes

**Table 7-1. Function Table**

| INPUTS <sup>(1)</sup> |   | OUTPUT <sup>(2)</sup><br>Y |
|-----------------------|---|----------------------------|
| A                     | B |                            |
| H                     | X | H                          |
| X                     | H | H                          |
| L                     | L | L                          |

- (1) H = High Voltage Level, L = Low Voltage Level, X = Don't Care  
 (2) H = Driving High, L = Driving Low

## 8 Application and Implementation

### Note

Information in the following applications sections is not part of the TI component specification, and TI does not warrant its accuracy or completeness. TI's customers are responsible for determining suitability of components for their purposes, as well as validating and testing their design implementation to confirm system functionality.

### 8.1 Application Information

In this application, three 2-input OR gates are combined to produce a 4-input OR gate function as shown in [Figure 8-1](#). The fourth gate can be used for another application in the system, or the inputs can be grounded and the channel left unused.

The SN74LVC7032A is used to directly control the Enable pin of a fan driver. The fan driver requires only one input signal to be HIGH before being enabled, and should be disabled in the event that all signals go LOW. The 4-input OR gate function combines the four individual overhear signals into a single active-high enable signal.

Temperature sensors can often be spread throughout a system rather than being in a centralized location. This would mean longer length traces or wires to pass signals through leading to slower edge transitions. This makes the SN74LVC7032A an excellent choice for the application since it has Schmitt-trigger inputs that do not have input transition rate requirements.

### 8.2 Typical Application

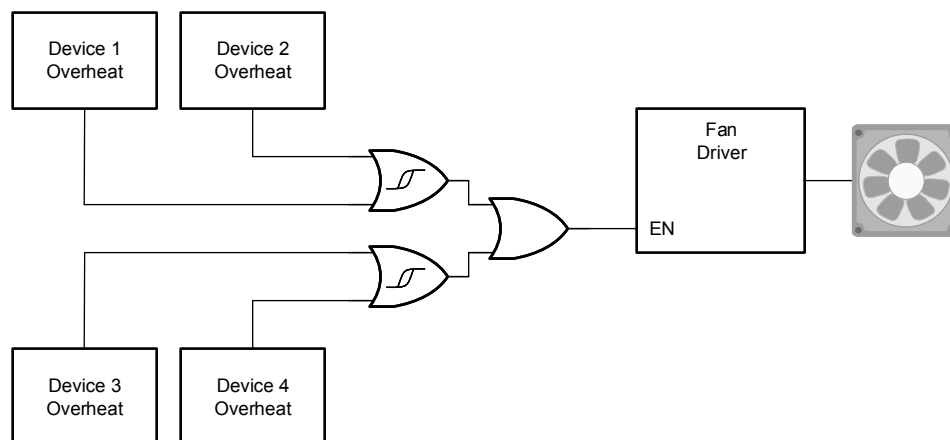

Figure 8-1. Typical Application Block Diagram

#### 8.2.1 Design Requirements

##### 8.2.1.1 Power Considerations

Ensure the desired supply voltage is within the range specified in the *Recommended Operating Conditions*. The supply voltage sets the electrical characteristics of the device as described in the *Electrical Characteristics* section.

The positive voltage supply must be capable of sourcing current equal to the total current to be sourced by all outputs of the SN74LVC7032A plus the maximum static supply current,  $I_{CC}$ , listed in the *Electrical Characteristics*, and any transient current required for switching. The logic device can only source as much current that is provided by the positive supply source. Be sure to not exceed the maximum total current through  $V_{CC}$  listed in the *Absolute Maximum Ratings*.

The ground must be capable of sinking current equal to the total current to be sunk by all outputs of the SN74LVC7032A plus the maximum supply current,  $I_{CC}$ , listed in the *Electrical Characteristics*, and any transient current required for switching. The logic device can only sink as much current that can be sunk into its ground connection. Be sure to not exceed the maximum total current through GND listed in the *Absolute Maximum Ratings*.

The SN74LVC7032A can drive a load with a total capacitance less than or equal to 50pF while still meeting all of the data sheet specifications. Larger capacitive loads can be applied; however, it is not recommended to exceed 50pF.

The SN74LVC7032A can drive a load with total resistance described by  $R_L \geq V_O / I_O$ , with the output voltage and current defined in the *Electrical Characteristics* table with  $V_{OH}$  and  $V_{OL}$ . When outputting in the HIGH state, the output voltage in the equation is defined as the difference between the measured output voltage and the supply voltage at the  $V_{CC}$  pin.

Total power consumption can be calculated using the information provided in the [CMOS Power Consumption and Cpd Calculation](#) application note.

Thermal increase can be calculated using the information provided in the [Thermal Characteristics of Standard Linear and Logic \(SLL\) Packages and Devices](#) application note.

#### CAUTION

The maximum junction temperature,  $T_{J(max)}$  listed in the *Absolute Maximum Ratings*, is an additional limitation to prevent damage to the device. Do not violate any values listed in the *Absolute Maximum Ratings*. These limits are provided to prevent damage to the device.

### 8.2.1.2 Input Considerations

Input signals must cross  $V_{t-(min)}$  to be considered a logic LOW, and  $V_{t+(max)}$  to be considered a logic HIGH. Do not exceed the maximum input voltage range found in the *Absolute Maximum Ratings*.

Unused inputs must be terminated to either  $V_{CC}$  or ground. The unused inputs can be directly terminated if the input is completely unused, or they can be connected with a pull-up or pull-down resistor if the input will be used sometimes, but not always. A pull-up resistor is used for a default state of HIGH, and a pull-down resistor is used for a default state of LOW. The drive current of the controller, leakage current into the SN74LVC7032A (as specified in the *Electrical Characteristics*), and the desired input transition rate limits the resistor size. A 10k $\Omega$  resistor value is often used due to these factors.

The SN74LVC7032A has no input signal transition rate requirements because it has Schmitt-trigger inputs.

Another benefit to having Schmitt-trigger inputs is the ability to reject noise. Noise with a large enough amplitude can still cause issues. To know how much noise is too much, please refer to the  $\Delta V_{T(min)}$  in the *Electrical Characteristics*. This hysteresis value will provide the peak-to-peak limit.

Unlike what happens with standard CMOS inputs, Schmitt-trigger inputs can be held at any valid value without causing huge increases in power consumption. The typical additional current caused by holding an input at a value other than  $V_{CC}$  or ground is plotted in the *Typical Characteristics*.

Refer to the *Feature Description* section for additional information regarding the inputs for this device.

### 8.2.1.3 Output Considerations

The positive supply voltage is used to produce the output HIGH voltage. Drawing current from the output will decrease the output voltage as specified by the  $V_{OH}$  specification in the *Electrical Characteristics*. The ground voltage is used to produce the output LOW voltage. Sinking current into the output will increase the output voltage as specified by the  $V_{OL}$  specification in the *Electrical Characteristics*.

Push-pull outputs that could be in opposite states, even for a very short time period, should never be connected directly together. This can cause excessive current and damage to the device.

Two channels within the same device with the same input signals can be connected in parallel for additional output drive strength.

Unused outputs can be left floating. Do not connect outputs directly to  $V_{CC}$  or ground.

Refer to the *Feature Description* section for additional information regarding the outputs for this device.

### 8.2.2 Detailed Design Procedure

1. Add a decoupling capacitor from  $V_{CC}$  to GND. The capacitor needs to be placed physically close to the device and electrically close to both the  $V_{CC}$  and GND pins. An example layout is shown in the *Layout Example* section.
2. Ensure the capacitive load at the output is  $\leq 70\text{pF}$ . This is not a hard limit; by design, however, it will optimize performance. This can be accomplished by providing short, appropriately sized traces from the SN74LVC7032A to the receiving device.
3. Ensure the resistive load at the output is larger than  $(V_{CC} / I_{O(\text{max})}) \Omega$ , so that the maximum output current from the *Absolute Maximum Ratings* is not violated. Most CMOS inputs have a resistive load measured in mega ohms; much larger than the minimum calculated previously.
4. Thermal issues are rarely a concern for logic gates, however the power consumption and thermal increase can be calculated using the steps provided in the application report, [CMOS Power Consumption and Cpd Calculation](#)

### 8.2.3 Application Curves

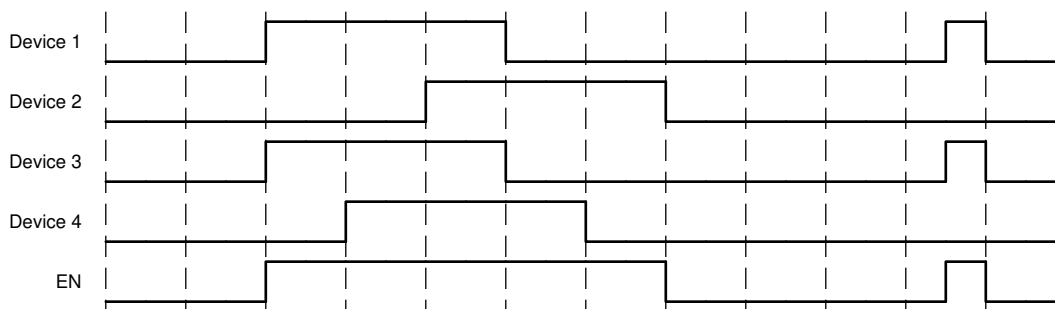

Figure 8-2. Application Timing Diagram

## 8.3 Power Supply Recommendations

The power supply can be any voltage between the minimum and maximum supply voltage rating located in the *Recommended Operating Conditions*. Each  $V_{CC}$  terminal should have a bypass capacitor to prevent power disturbance. A  $0.1\mu\text{F}$  capacitor is recommended for this device. It is acceptable to parallel multiple bypass capacitors to reject different frequencies of noise. The  $0.1\mu\text{F}$  and  $1\mu\text{F}$  capacitors are commonly used in parallel. The bypass capacitor should be installed as close to the power terminal as possible for best results, as shown in [Figure 8-3](#).

## 8.4 Layout

### 8.4.1 Layout Guidelines

When using multiple-input and multiple-channel logic devices inputs must never be left floating. In many cases, functions or parts of functions of digital logic devices are unused; for example, when only two inputs of a triple-input AND gate are used. Such unused input pins must not be left unconnected because the undefined voltages at the outside connections result in undefined operational states. All unused inputs of digital logic devices must be connected to a logic high or logic low voltage, as defined by the input voltage specifications, to prevent them from floating. The logic level that must be applied to any particular unused input depends on the function of the device. Generally, the inputs are tied to GND or  $V_{CC}$ , whichever makes more sense for the logic function or is more convenient.

### 8.4.2 Layout Example

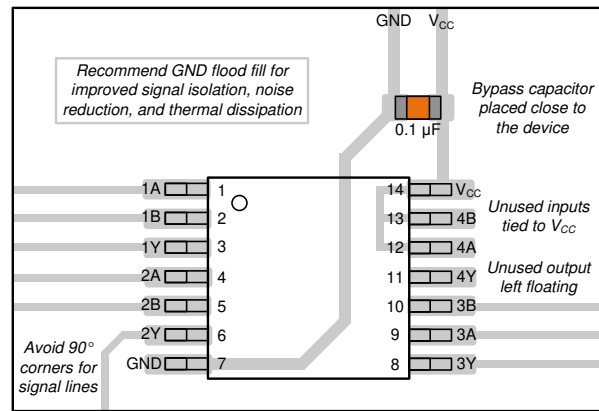

**Figure 8-3. Example Layout for the SN74LVC7032A**

## 9 Device and Documentation Support

TI offers an extensive line of development tools. Tools and software to evaluate the performance of the device, generate code, and develop solutions are listed below.

### 9.1 Documentation Support

#### 9.1.1 Related Documentation

For related documentation, see the following:

- Texas Instruments, [CMOS Power Consumption and Cpd Calculation application note](#)
- Texas Instruments, [Designing With Logic application note](#)
- Texas Instruments, [Thermal Characteristics of Standard Linear and Logic \(SLL\) Packages and Devices application note](#)
- Texas Instruments, [Implications of Slow or Floating CMOS Inputs application note](#)

### 9.2 Receiving Notification of Documentation Updates

To receive notification of documentation updates, navigate to the device product folder on [ti.com](http://ti.com). Click on *Notifications* to register and receive a weekly digest of any product information that has changed. For change details, review the revision history included in any revised document.

### 9.3 Support Resources

TI E2E™ [support forums](#) are an engineer's go-to source for fast, verified answers and design help — straight from the experts. Search existing answers or ask your own question to get the quick design help you need.

Linked content is provided "AS IS" by the respective contributors. They do not constitute TI specifications and do not necessarily reflect TI's views; see TI's [Terms of Use](#).

### 9.4 Trademarks

TI E2E™ is a trademark of Texas Instruments.  
All trademarks are the property of their respective owners.

### 9.5 Electrostatic Discharge Caution



This integrated circuit can be damaged by ESD. Texas Instruments recommends that all integrated circuits be handled with appropriate precautions. Failure to observe proper handling and installation procedures can cause damage.

ESD damage can range from subtle performance degradation to complete device failure. Precision integrated circuits may be more susceptible to damage because very small parametric changes could cause the device not to meet its published specifications.

### 9.6 Glossary

[TI Glossary](#) This glossary lists and explains terms, acronyms, and definitions.

## 10 Revision History

| DATE       | REVISION | NOTES           |
|------------|----------|-----------------|
| March 2024 | *        | Initial Release |

## 11 Mechanical, Packaging, and Orderable Information

The following pages include mechanical, packaging, and orderable information. This information is the most current data available for the designated devices. This data is subject to change without notice and revision of this document. For browser-based versions of this data sheet, refer to the left-hand navigation.



**PACKAGING INFORMATION**

| Orderable Device | Status<br>(1) | Package Type | Package Drawing | Pins | Package Qty | Eco Plan<br>(2) | Lead finish/<br>Ball material<br>(6) | MSL Peak Temp<br>(3) | Op Temp (°C) | Device Marking<br>(4/5) | Samples |
|------------------|---------------|--------------|-----------------|------|-------------|-----------------|--------------------------------------|----------------------|--------------|-------------------------|---------|
| SN74LVC7032ABQAR | ACTIVE        | WQFN         | BQA             | 14   | 3000        | RoHS & Green    | NIPDAU                               | Level-1-260C-UNLIM   | -40 to 125   | LC732A                  | Samples |
| SN74LVC7032APWR  | ACTIVE        | TSSOP        | PW              | 14   | 3000        | RoHS & Green    | NIPDAU   SN                          | Level-1-260C-UNLIM   | -40 to 125   | LVC7032                 | Samples |

(1) The marketing status values are defined as follows:

**ACTIVE:** Product device recommended for new designs.

**LIFEBUY:** TI has announced that the device will be discontinued, and a lifetime-buy period is in effect.

**NRND:** Not recommended for new designs. Device is in production to support existing customers, but TI does not recommend using this part in a new design.

**PREVIEW:** Device has been announced but is not in production. Samples may or may not be available.

**OBSOLETE:** TI has discontinued the production of the device.

(2) **RoHS:** TI defines "RoHS" to mean semiconductor products that are compliant with the current EU RoHS requirements for all 10 RoHS substances, including the requirement that RoHS substance do not exceed 0.1% by weight in homogeneous materials. Where designed to be soldered at high temperatures, "RoHS" products are suitable for use in specified lead-free processes. TI may reference these types of products as "Pb-Free".

**RoHS Exempt:** TI defines "RoHS Exempt" to mean products that contain lead but are compliant with EU RoHS pursuant to a specific EU RoHS exemption.

**Green:** TI defines "Green" to mean the content of Chlorine (Cl) and Bromine (Br) based flame retardants meet JS709B low halogen requirements of <=1000ppm threshold. Antimony trioxide based flame retardants must also meet the <=1000ppm threshold requirement.

(3) MSL, Peak Temp. - The Moisture Sensitivity Level rating according to the JEDEC industry standard classifications, and peak solder temperature.

(4) There may be additional marking, which relates to the logo, the lot trace code information, or the environmental category on the device.

(5) Multiple Device Markings will be inside parentheses. Only one Device Marking contained in parentheses and separated by a "~" will appear on a device. If a line is indented then it is a continuation of the previous line and the two combined represent the entire Device Marking for that device.

(6) Lead finish/Ball material - Orderable Devices may have multiple material finish options. Finish options are separated by a vertical ruled line. Lead finish/Ball material values may wrap to two lines if the finish value exceeds the maximum column width.

**Important Information and Disclaimer:**The information provided on this page represents TI's knowledge and belief as of the date that it is provided. TI bases its knowledge and belief on information provided by third parties, and makes no representation or warranty as to the accuracy of such information. Efforts are underway to better integrate information from third parties. TI has taken and continues to take reasonable steps to provide representative and accurate information but may not have conducted destructive testing or chemical analysis on incoming materials and chemicals. TI and TI suppliers consider certain information to be proprietary, and thus CAS numbers and other limited information may not be available for release.

In no event shall TI's liability arising out of such information exceed the total purchase price of the TI part(s) at issue in this document sold by TI to Customer on an annual basis.

**OTHER QUALIFIED VERSIONS OF SN74LVC7032A :**

- Automotive : [SN74LVC7032A-Q1](#)

## NOTE: Qualified Version Definitions:

- Automotive - Q100 devices qualified for high-reliability automotive applications targeting zero defects

**TAPE AND REEL INFORMATION**

**QUADRANT ASSIGNMENTS FOR PIN 1 ORIENTATION IN TAPE**

\*All dimensions are nominal

| Device           | Package Type | Package Drawing | Pins | SPQ  | Reel Diameter (mm) | Reel Width W1 (mm) | A0 (mm) | B0 (mm) | K0 (mm) | P1 (mm) | W (mm) | Pin1 Quadrant |
|------------------|--------------|-----------------|------|------|--------------------|--------------------|---------|---------|---------|---------|--------|---------------|
| SN74LVC7032ABQAR | WQFN         | BQA             | 14   | 3000 | 180.0              | 12.4               | 2.8     | 3.3     | 1.1     | 4.0     | 12.0   | Q1            |
| SN74LVC7032APWR  | TSSOP        | PW              | 14   | 3000 | 330.0              | 12.4               | 6.9     | 5.6     | 1.6     | 8.0     | 12.0   | Q1            |

**TAPE AND REEL BOX DIMENSIONS**

\*All dimensions are nominal

| Device           | Package Type | Package Drawing | Pins | SPQ  | Length (mm) | Width (mm) | Height (mm) |
|------------------|--------------|-----------------|------|------|-------------|------------|-------------|
| SN74LVC7032ABQAR | WQFN         | BQA             | 14   | 3000 | 210.0       | 185.0      | 35.0        |
| SN74LVC7032APWR  | TSSOP        | PW              | 14   | 3000 | 356.0       | 356.0      | 35.0        |

## GENERIC PACKAGE VIEW

**BQA 14**

**WQFN - 0.8 mm max height**

2.5 x 3, 0.5 mm pitch

PLASTIC QUAD FLATPACK - NO LEAD

This image is a representation of the package family, actual package may vary.  
Refer to the product data sheet for package details.



4227145/A



**NOTES:**

1. All linear dimensions are in millimeters. Any dimensions in parenthesis are for reference only. Dimensioning and tolerancing per ASME Y14.5M.
2. This drawing is subject to change without notice.
3. The package thermal pad must be soldered to the printed circuit board for optimal thermal and mechanical performance.

# EXAMPLE BOARD LAYOUT

WQFN - 0.8 mm max height

BQA0014A

PLASTIC QUAD FLAT PACK-NO LEAD



LAND PATTERN EXAMPLE  
EXPOSED METAL SHOWN  
SCALE: 20X



4224636/A 11/2018

NOTES: (continued)

4. This package is designed to be soldered to a thermal pad on the board. For more information, see Texas Instruments literature number SLUA271 ([www.ti.com/lit/sluea271](http://www.ti.com/lit/sluea271)).
5. Vias are optional depending on application, refer to device data sheet. If any vias are implemented, refer to their locations shown on this view. It is recommended that vias under paste be filled, plugged or tented.

# EXAMPLE STENCIL DESIGN

BQA0014A

WQFN - 0.8 mm max height

PLASTIC QUAD FLAT PACK-NO LEAD



SOLDER PASTE EXAMPLE  
 BASED ON 0.125 mm THICK STENCIL

EXPOSED PAD  
 88% PRINTED COVERAGE BY AREA  
 SCALE: 20X

4224636/A 11/2018

NOTES: (continued)

- 6. Laser cutting apertures with trapezoidal walls and rounded corners may offer better paste release. IPC-7525 may have alternate design recommendations.



PW0014A



**PACKAGE OUTLINE**  
**TSSOP - 1.2 mm max height**

SMALL OUTLINE PACKAGE



4220202/B 12/2023

NOTES:

1. All linear dimensions are in millimeters. Any dimensions in parenthesis are for reference only. Dimensioning and tolerancing per ASME Y14.5M.
2. This drawing is subject to change without notice.
3. This dimension does not include mold flash, protrusions, or gate burrs. Mold flash, protrusions, or gate burrs shall not exceed 0.15 mm per side.
4. This dimension does not include interlead flash. Interlead flash shall not exceed 0.25 mm per side.
5. Reference JEDEC registration MO-153.

# EXAMPLE BOARD LAYOUT

PW0014A

TSSOP - 1.2 mm max height

SMALL OUTLINE PACKAGE



LAND PATTERN EXAMPLE  
EXPOSED METAL SHOWN  
SCALE: 10X



4220202/B 12/2023

NOTES: (continued)

- 6. Publication IPC-7351 may have alternate designs.
- 7. Solder mask tolerances between and around signal pads can vary based on board fabrication site.

# EXAMPLE STENCIL DESIGN

PW0014A

TSSOP - 1.2 mm max height

SMALL OUTLINE PACKAGE



SOLDER PASTE EXAMPLE  
BASED ON 0.125 mm THICK STENCIL  
SCALE: 10X

4220202/B 12/2023

NOTES: (continued)

8. Laser cutting apertures with trapezoidal walls and rounded corners may offer better paste release. IPC-7525 may have alternate design recommendations.
9. Board assembly site may have different recommendations for stencil design.

## IMPORTANT NOTICE AND DISCLAIMER

TI PROVIDES TECHNICAL AND RELIABILITY DATA (INCLUDING DATA SHEETS), DESIGN RESOURCES (INCLUDING REFERENCE DESIGNS), APPLICATION OR OTHER DESIGN ADVICE, WEB TOOLS, SAFETY INFORMATION, AND OTHER RESOURCES "AS IS" AND WITH ALL FAULTS, AND DISCLAIMS ALL WARRANTIES, EXPRESS AND IMPLIED, INCLUDING WITHOUT LIMITATION ANY IMPLIED WARRANTIES OF MERCHANTABILITY, FITNESS FOR A PARTICULAR PURPOSE OR NON-INFRINGEMENT OF THIRD PARTY INTELLECTUAL PROPERTY RIGHTS.

These resources are intended for skilled developers designing with TI products. You are solely responsible for (1) selecting the appropriate TI products for your application, (2) designing, validating and testing your application, and (3) ensuring your application meets applicable standards, and any other safety, security, regulatory or other requirements.

These resources are subject to change without notice. TI grants you permission to use these resources only for development of an application that uses the TI products described in the resource. Other reproduction and display of these resources is prohibited. No license is granted to any other TI intellectual property right or to any third party intellectual property right. TI disclaims responsibility for, and you will fully indemnify TI and its representatives against, any claims, damages, costs, losses, and liabilities arising out of your use of these resources.

TI's products are provided subject to [TI's Terms of Sale](#) or other applicable terms available either on [ti.com](https://www.ti.com) or provided in conjunction with such TI products. TI's provision of these resources does not expand or otherwise alter TI's applicable warranties or warranty disclaimers for TI products.

TI objects to and rejects any additional or different terms you may have proposed.

Mailing Address: Texas Instruments, Post Office Box 655303, Dallas, Texas 75265  
Copyright © 2024, Texas Instruments Incorporated