

TLV1704-SEP 2.2V to 24V, Radiation-Tolerant microPower Quad Comparator in Space Enhanced Plastic

1 Features

- VID V62/18613
- Radiation-Tolerant
 - Single Event Latch-up (SEL) immune to 43MeV-cm²/mg at 125°C
 - ELDRS free to 30krad(Si)
 - Total Ionizing Dose (TID) flat for every wafer lot up to 30krad(Si)
- Space enhanced plastic
 - Controlled baseline
 - Gold wire
 - NiPdAu lead finish
 - One assembly and test site
 - One fabrication site
 - Available in military (–55°C to 125°C) temperature range
 - Extended product life cycle
 - Extended product-change notification
 - Product traceability
 - Enhanced mold compound for low outgassing
- Supply range: 2.2V to 24V
- Low quiescent current: 55µA per comparator
- Input common-mode range includes both rails
- Low propagation delay: 560ns
- Low input offset voltage: 300µV
- Open collector outputs:
 - Up to 24V above negative supply regardless of supply voltage
- Small packages:
 - Quad: TSSOP-14

2 Applications

- [Command & data handling \(C&DH\)](#)
- [Aircraft cockpit display](#)
- [Flight control unit](#)
- [Satellite electrical power system \(EPS\)](#)

3 Description

The TLV1704-SEP (Quad) device offers a wide supply range, rail-to-rail inputs, low quiescent current, and low propagation delay. All these features come in an industry-standard, TSSOP-14 plastic package, making these devices appropriate for applications where size, weight, and design flexibility are important..

The open-collector output offers the advantage of allowing the output to be level shifted to any voltage rail up to 24V above the negative power supply, regardless of the TLV1704-SEP supply voltage. Likewise, the outputs can be wired together to form a single alert signal.

The device is a microPower comparator. Low input offset voltage, low input bias currents, low supply current, and open-collector configuration make the TLV1704-SEP device well-suited for system diagnostics such as voltage monitoring, current sensing, and zero-cross detection.

Device Information

PART NUMBER	GRADE ⁽¹⁾	PACKAGE ⁽²⁾
TLV1704AMPWTPSEP	30krad(Si) RLAT	TSSOP (14)
TLV1704AMPWPSEP		

- (1) For all available packages, see the package option addendum at the end of the data sheet.
- (2) The package size (length × width) is a nominal value and includes pins, where applicable.

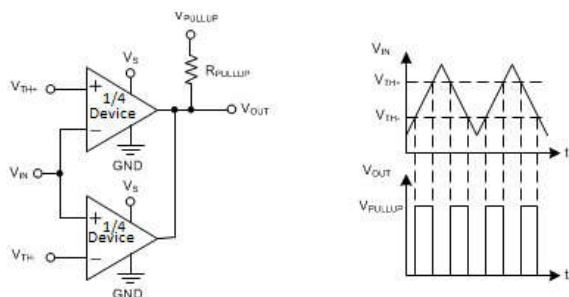

TLV1704-SEP as a Window Comparator

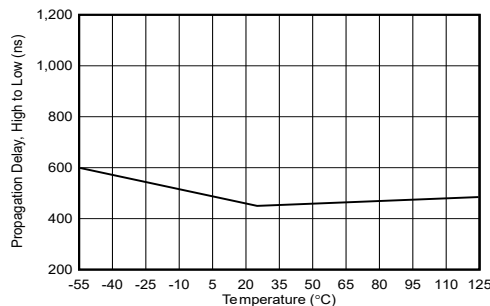
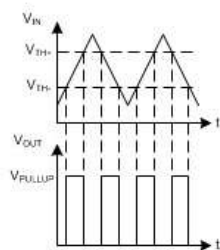

Stable Propagation Delay vs Temperature



Table of Contents

1 Features	1	6.4 Device Functional Modes.....	9
2 Applications	1	7 Application and Implementation	10
3 Description	1	7.1 Application Information.....	10
4 Pin Configuration and Functions	3	7.2 Typical Application.....	10
5 Specifications	4	7.3 Power Supply Recommendations.....	11
5.1 Absolute Maximum Ratings.....	4	7.4 Layout.....	12
5.2 ESD Ratings.....	4	8 Device and Documentation Support	13
5.3 Recommended Operating Conditions.....	4	8.1 Documentation Support.....	13
5.4 Thermal Information.....	4	8.2 Receiving Notification of Documentation Updates....	13
5.5 Electrical Characteristics.....	5	8.3 Support Resources.....	13
5.6 Switching Characteristics.....	5	8.4 Trademarks.....	13
5.7 Typical Characteristics.....	6	8.5 Electrostatic Discharge Caution.....	13
6 Detailed Description	8	8.6 Glossary.....	13
6.1 Overview.....	8	9 Revision History	13
6.2 Functional Block Diagram.....	8	10 Mechanical, Packaging, and Orderable Information	14
6.3 Feature Description.....	9		

4 Pin Configuration and Functions

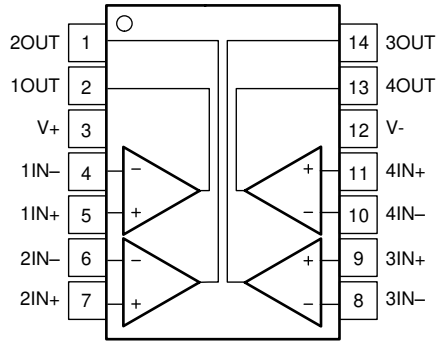

**Figure 4-1. TLV1704-SEP PW Package
14-Pin TSSOP
Top View**

Table 4-1. Pin Functions

PIN		I/O	DESCRIPTION
NAME	NO.		
IN+	—	I	Noninverting input.
1IN+	5	I	Noninverting input, channel 1.
2IN+	7	I	Noninverting input, channel 2.
3IN+	9	I	Noninverting input, channel 3.
4IN+	11	I	Noninverting input, channel 4.
IN-	—	I	Inverting input.
1IN-	4	I	Inverting input, channel 1.
2IN-	6	I	Inverting input, channel 2.
3IN-	8	I	Inverting input, channel 3.
4IN-	10	I	Inverting input, channel 4.
OUT	—	O	Output.
1OUT	2	O	Output, channel 1.
2OUT	1	O	Output, channel 2.
3OUT	14	O	Output, channel 3.
4OUT	13	O	Output, channel 4.
V+	3	—	Positive (highest) power supply.
V-	12	—	Negative (lowest) power supply.

5 Specifications

5.1 Absolute Maximum Ratings

over operating free-air temperature range (unless otherwise noted)⁽¹⁾

		MIN	MAX	UNIT
Supply voltage			24	V
Signal input pins	Voltage ⁽²⁾	$(V_{S-}) - 0.5$	$(V_{S+}) + 0.5$	V
	Current ⁽²⁾		±10	mA
Output short-circuit ⁽³⁾			Continuous	mA
Operating Junction temperature, T_J		-55	125	°C
Storage temperature, T_{stg}		-65	150	°C

- (1) Stresses beyond those listed under *Absolute Maximum Ratings* may cause permanent damage to the device. These are stress ratings only, and functional operation of the device at these or any other conditions beyond those indicated under *Recommended Operating Conditions* is not implied. Exposure to absolute-maximum-rated conditions for extended periods may affect device reliability.
- (2) Input pins are diode-clamped to the power-supply rails. Input signals that can swing more than 0.5V beyond the supply rails must be current limited to 10mA or less.
- (3) Short-circuit to ground; one comparator per package.

5.2 ESD Ratings

		VALUE	UNIT
$V_{(ESD)}$ Electrostatic discharge	Human-body model (HBM), per AEC Q100-002 ⁽¹⁾	±1000	V
	Charged-device model (CDM), per AEC Q100-011	±1000	

- (1) AEC Q100-002 indicates that HBM stressing shall be in accordance with the ANSI/ESDA/JEDEC JS-001 specification.

5.3 Recommended Operating Conditions

over operating free-air temperature range (unless otherwise noted)

		MIN	NOM	MAX	UNIT
Supply voltage $V_S = (V_{S+}) - (V_{S-})$		2.2		24	V
Specified temperature		-55		125	°C

5.4 Thermal Information

THERMAL METRIC ⁽¹⁾		TLV1704-SEP	UNIT
		PW (TSSOP)	
		14 PINS	
$R_{\theta JA}$	Junction-to-ambient thermal resistance	128.1	°C/W
$R_{\theta JC(top)}$	Junction-to-case (top) thermal resistance	56.5	°C/W
$R_{\theta JB}$	Junction-to-board thermal resistance	69.9	°C/W
Ψ_{JT}	Junction-to-top characterization parameter	9.1	°C/W
Ψ_{JB}	Junction-to-board characterization parameter	69.3	°C/W
$R_{\theta JC(bot)}$	Junction-to-case (bottom) thermal resistance	N/A	°C/W

- (1) For more information about traditional and new thermal metrics, see the [Semiconductor and IC Package Thermal Metrics](#) application report.

5.5 Electrical Characteristics

at $T_A = -55^\circ\text{C}$ to 125°C , $V_S = 2.2\text{V}$ to 24V , $C_L = 15\text{pF}$, $R_{PULLUP} = 5.1\text{k}\Omega$, $V_{CM} = V_S / 2$, and $V_S = V_{PULLUP}$ (unless otherwise noted)

PARAMETER	TEST CONDITIONS	MIN	TYP	MAX	UNIT	
OFFSET VOLTAGE						
V_{OS}	Input offset voltage	$T_A = 25^\circ\text{C}$, $V_S = 2.2\text{V}$		± 0.5	± 3.5	mV
		$T_A = 25^\circ\text{C}$, $V_S = 24\text{V}$		± 0.3	± 2.5	mV
		$T_A = -55^\circ\text{C}$ to 125°C			± 5.5	mV
dV_{OS}/dT	Input offset voltage drift	$T_A = -55^\circ\text{C}$ to 125°C		± 4	± 20	$\mu\text{V}/^\circ\text{C}$
PSRR	Power-supply rejection ratio	$T_A = 25^\circ\text{C}$		15	100	$\mu\text{V}/\text{V}$
		$T_A = -55^\circ\text{C}$ to 125°C		20		$\mu\text{V}/\text{V}$
INPUT VOLTAGE RANGE						
V_{CM}	Common-mode voltage range	$T_A = -55^\circ\text{C}$ to 125°C		(V-)	(V+)	V
INPUT BIAS CURRENT						
I_B	Input bias current	$T_A = 25^\circ\text{C}$		5	15	nA
		$T_A = -55^\circ\text{C}$ to 125°C			20	nA
I_{OS}	Input offset current	$T_A = 25^\circ\text{C}$		0.5		nA
C_{LOAD}	Capacitive load drive			See Section 5.7		
OUTPUT						
V_O	Voltage output swing from rail	$I_O \leq 4\text{mA}$, input overdrive = 100mV , $V_S = 24\text{V}$			1100	mV
		$I_O = 0\text{mA}$, input overdrive = 100mV , $V_S = 24\text{V}$			700	mV
I_{SC}	Short circuit sink current	$T_A = 25^\circ\text{C}$		20		mA
	Output leakage current	$V_{IN+} > V_{IN-}$, $T_J = 25^\circ\text{C}$		70		nA
POWER SUPPLY						
V_S	Specified voltage range			2.2	24	V
I_Q	Quiescent current (per channel)	$I_O = 0\text{A}$, $T_A = 25^\circ\text{C}$		55	75	μA
		$I_O = 0\text{A}$, $T_A = -55^\circ\text{C}$ to 125°C			100	μA

5.6 Switching Characteristics

at $T_A = -55^\circ\text{C}$ to 125°C , $V_S = 2.2\text{V}$ to 24V , $C_L = 15\text{pF}$, $R_{PULLUP} = 5.1\text{k}\Omega$, $V_{CM} = V_S / 2$, and $V_S = V_{PULLUP}$ (unless otherwise noted)

PARAMETER	TEST CONDITIONS	MIN	TYP	MAX	UNIT
t_{pHL}	Propagation delay time, high-to-low	Input overdrive = 100mV , $T_A = 25^\circ\text{C}$		460	ns
t_{pLH}	Propagation delay time, low-to-high	Input overdrive = 100mV , $T_A = 25^\circ\text{C}$		560	ns
t_R	Rise time	Input overdrive = 100mV , $T_A = 25^\circ\text{C}$		365	ns
t_F	Fall time	Input overdrive = 100mV , $T_A = 25^\circ\text{C}$		240	ns

5.7 Typical Characteristics

at $T_A = 25^\circ\text{C}$, $V_S = 5\text{V}$, $R_{\text{PULLUP}} = 5.1\text{k}\Omega$, and input overdrive = 100mV (unless otherwise noted)

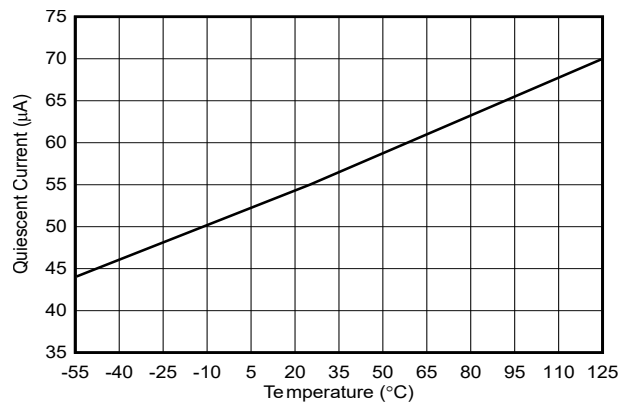

Figure 5-1. Quiescent Current vs Temperature

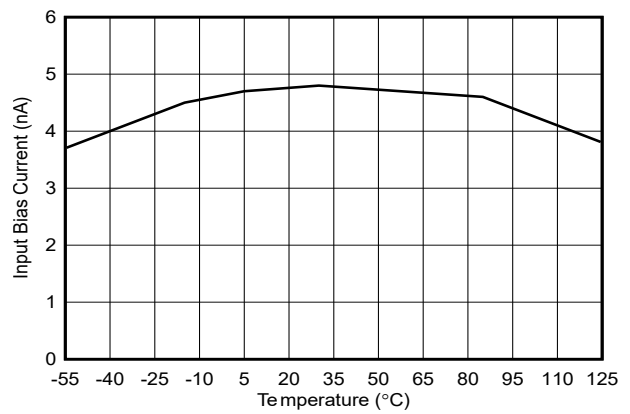

Figure 5-2. Input Bias Current vs Temperature

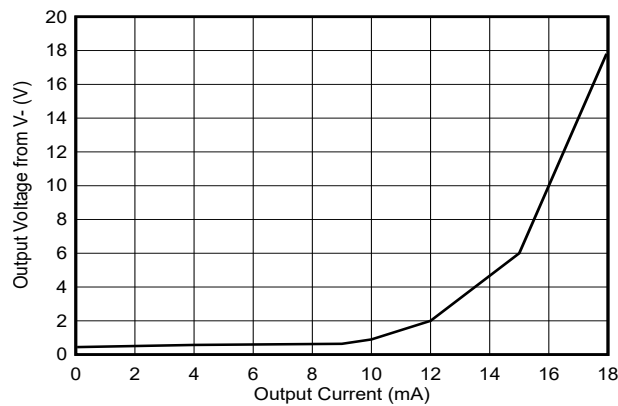

Figure 5-3. Output Voltage vs Output Current

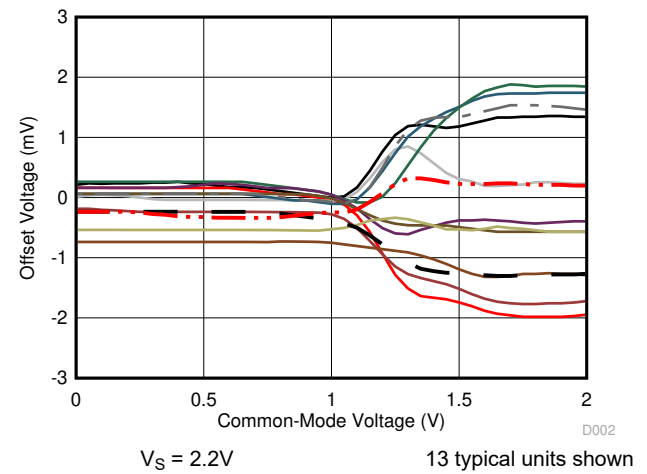

Figure 5-4. Offset Voltage vs Common-Mode Voltage

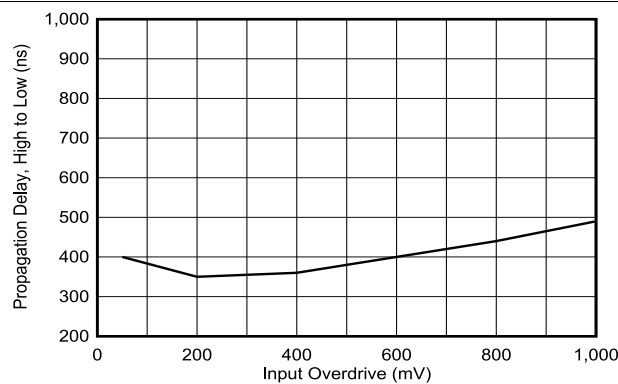

Figure 5-5. Propagation Delay vs Input Overdrive

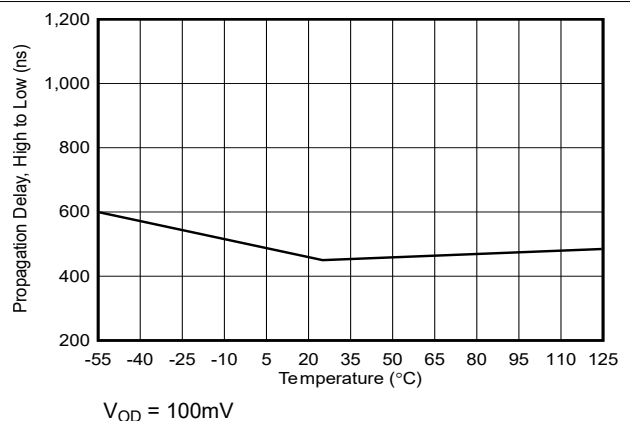
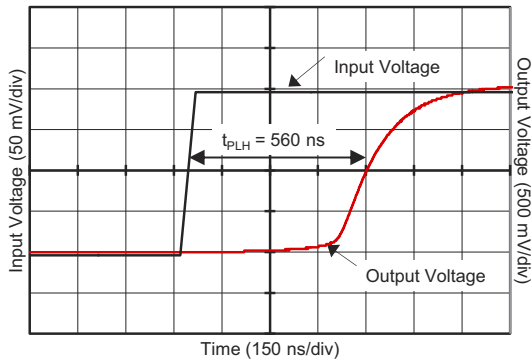

Figure 5-6. Propagation Delay vs Temperature

5.7 Typical Characteristics (continued)

at $T_A = 25^\circ\text{C}$, $V_S = 5\text{V}$, $R_{PULLUP} = 5.1\text{k}\Omega$, and input overdrive = 100mV (unless otherwise noted)



$V_S = 2.2\text{V}$ Overdrive = 100mV
Figure 5-7. Propagation Delay (T_{pLH})

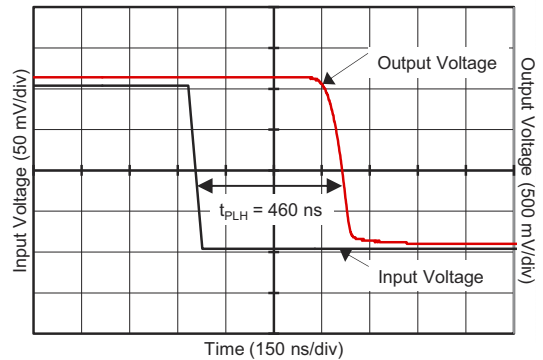

$V_S = 2.2\text{V}$ Overdrive = 100mV
Figure 5-8. Propagation Delay (T_{pHL})

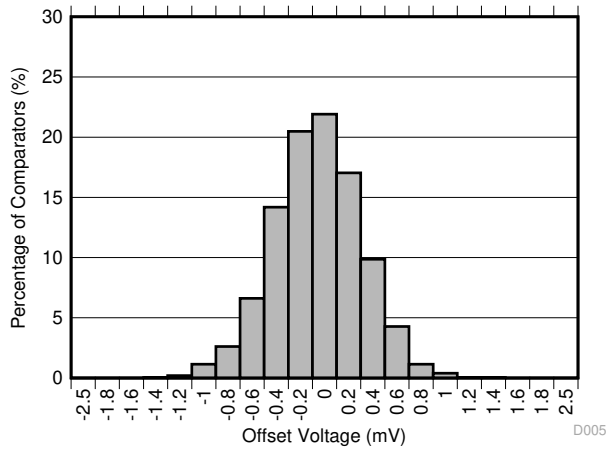

$V_S = 24\text{V}$ Distribution taken from 2524 comparators
Figure 5-9. Offset Voltage Production Distribution

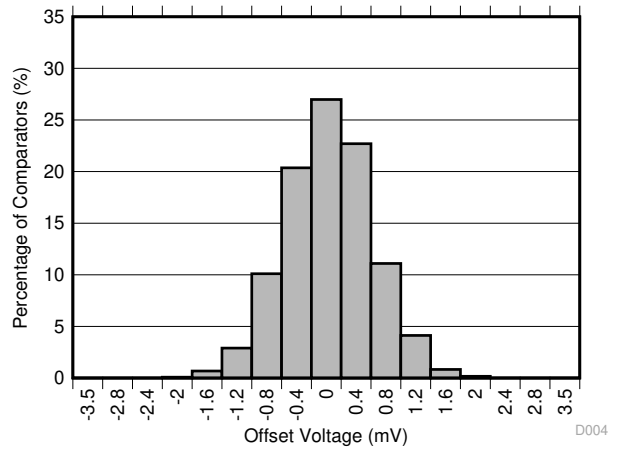

$V_S = 2.2\text{V}$ Distribution taken from 2524 comparators
Figure 5-10. Offset Voltage Production Distribution

6 Detailed Description

6.1 Overview

The TLV1704-SEP comparator features rail-to-rail input and output on supply voltages as high as 24V. The rail-to-rail input stage enables detection of signals close to the supply and ground. The open-collector configuration allows the device to be used in wired-OR configurations, such as a window comparator. A low supply current of 55µA per channel with small, space-saving packages, makes these comparators versatile for use in a wide range of applications, from portable to industrial.

6.2 Functional Block Diagram

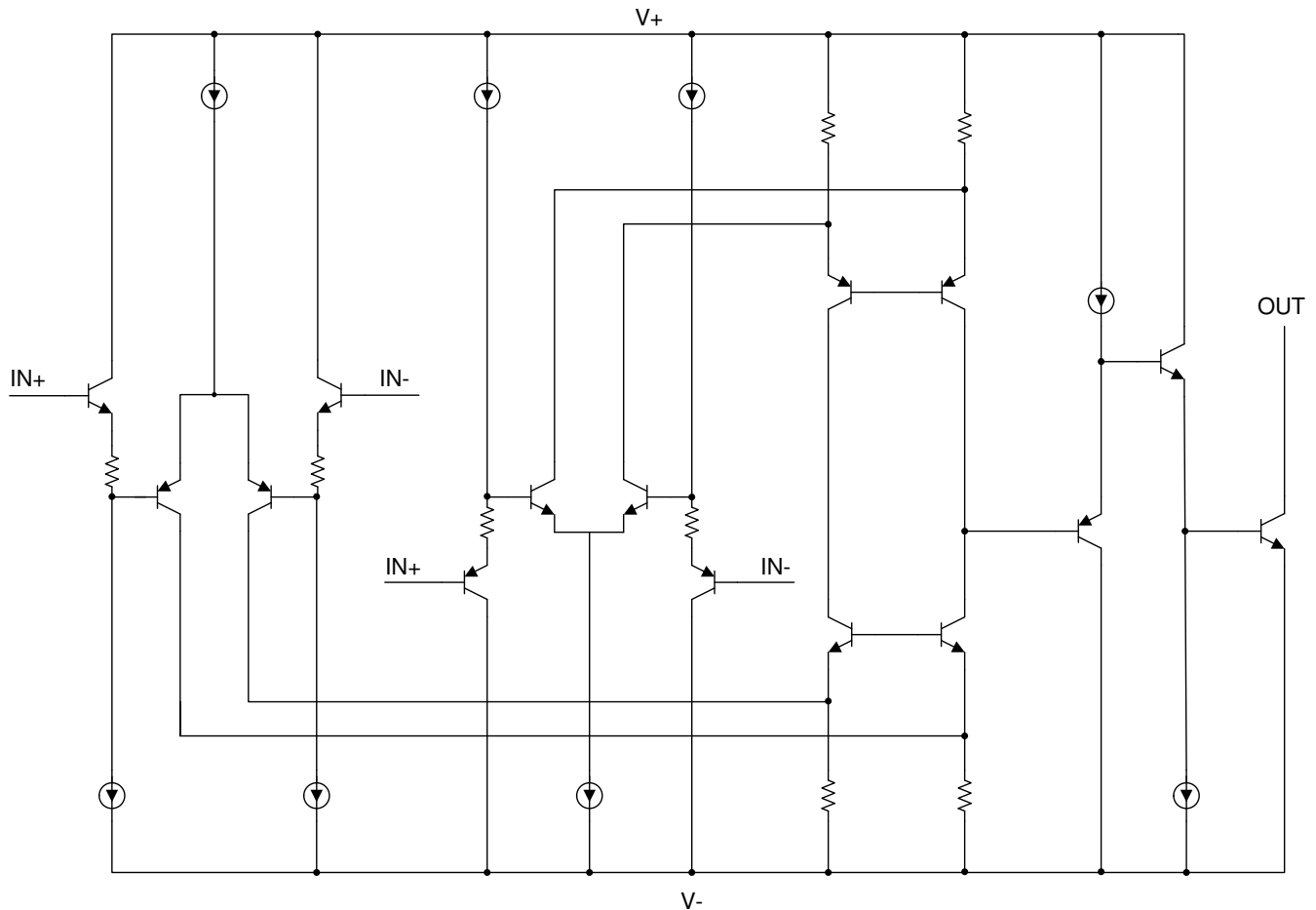

6.3 Feature Description

6.3.1 Comparator Inputs

The TLV1704-SEP device is a rail-to-rail input comparator, with an input common-mode range that includes the supply rails. The TLV1704-SEP device is designed to prevent phase inversion when the input pins exceed the supply voltage. Figure 6-1 shows the TLV1704-SEP device response when input voltages exceed the supply, resulting in no phase inversion.

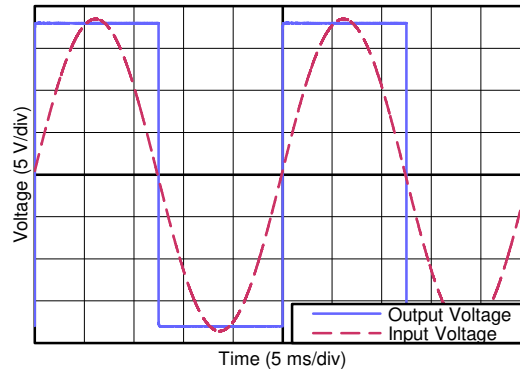

Figure 6-1. No Phase Inversion: Comparator Response to Input Voltage (Propagation Delay Included)

6.4 Device Functional Modes

6.4.1 Setting Reference Voltage

Using a stable reference is important when setting the transition point for the TLV1704-SEP device. The REF3333, as shown in Figure 6-2, provides a 3.3V reference voltage with low drift and only 3.9 μ A of quiescent current.

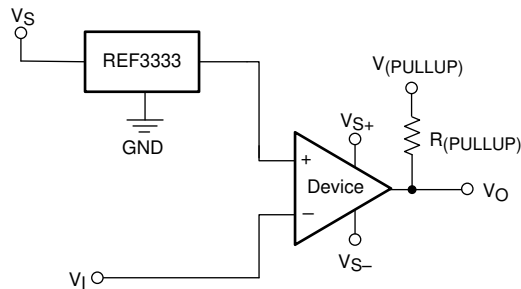

Figure 6-2. Reference Voltage for the TLV1704-SEP

7 Application and Implementation

Note

Information in the following applications sections is not part of the TI component specification, and TI does not warrant its accuracy or completeness. TI's customers are responsible for determining suitability of components for their purposes, as well as validating and testing their design implementation to confirm system functionality.

7.1 Application Information

The TLV1704-SEP device can be used in a wide variety of applications, such as zero crossing detectors, window comparators, over and undervoltage detectors, and high-side voltage sense circuits.

7.2 Typical Application

Comparators are used to differentiate between two different signal levels. For example, a comparator differentiates between an overtemperature and normal-temperature condition. However, noise or signal variation at the comparison threshold causes multiple transitions. This application example sets upper and lower hysteresis thresholds to eliminate the multiple transitions caused by noise.

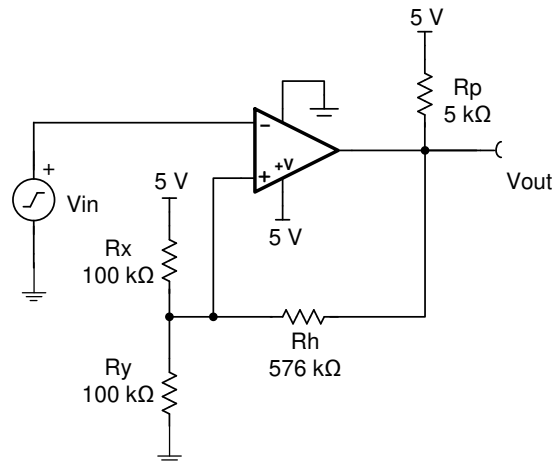

Figure 7-1. Comparator Schematic With Hysteresis

7.2.1 Design Requirements

The design requirements are as follows:

- Supply voltage: 5V
- Input: 0V to 5V
- Lower threshold (V_L) = $2.3V \pm 0.1V$
- Upper threshold (V_H) = $2.7V \pm 0.1V$
- $V_H - V_L = 2.4V \pm 0.1V$
- Low-power consumption

7.2.2 Detailed Design Procedure

Make a small change to the comparator circuit to add hysteresis. Hysteresis uses two different threshold voltages to avoid the multiple transitions introduced in the previous circuit. The input signal must exceed the upper threshold (VH) to transition low, or below the lower threshold (VL) to transition high.

Figure 7-1 illustrates hysteresis on a comparator. Resistor Rh sets the hysteresis level. An open-collector output stage requires a pullup resistor (Rp). The pullup resistor creates a voltage divider at the comparator output that introduces an error when the output is at logic high. This error can be minimized if $R_h > 100 R_p$.

When the output is at a logic high (5V), Rh is in parallel with Rx (ignoring Rp). This configuration drives more current into Ry, and raises the threshold voltage (VH) to 2.7V. The input signal must drive above $V_H = 2.7V$ to cause the output to transition to logic low (0V).

When the output is at logic low (0V), Rh is in parallel with Ry. This configuration reduces the current into Ry, and reduces the threshold voltage to 2.3V. The input signal must drive below $V_L = 2.3V$ to cause the output to transition to logic high (5V).

For more details on this design and other alternative devices that can be used in place of the TLV1702, refer to Precision Design TIPD144, *Comparator with Hysteresis Reference Design*.

7.2.3 Application Curve

Figure 7-2 shows the upper and lower thresholds for hysteresis. The upper threshold is 2.76V and the lower threshold is 2.34V, both of which are close to the design target.

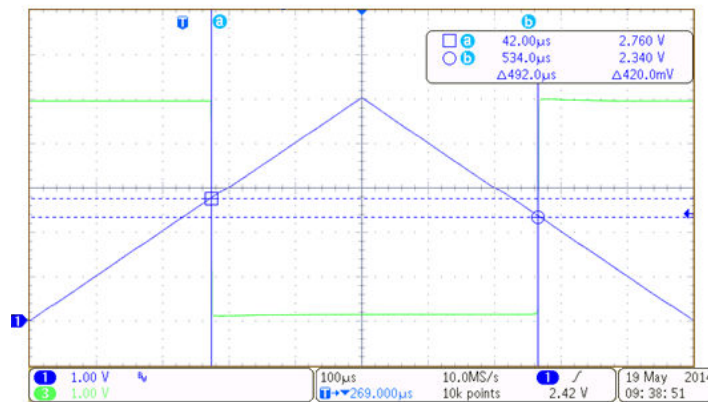

Figure 7-2. TLV1701 Upper and Lower Threshold With Hysteresis

7.3 Power Supply Recommendations

The TLV1704-SEP device is specified for operation from 2.2V to 24V; many specifications apply from $-55^{\circ}C$ to $125^{\circ}C$. Parameters that can exhibit significant variance with regard to operating voltage or temperature are presented in the [Section 5.7](#) section.

CAUTION

Supply voltages larger than 40V can permanently damage the device; see the [Section 5.1](#).

Place 0.1µF bypass capacitors close to the power-supply pins to reduce errors coupling in from noisy or high-impedance power supplies. For more detailed information on bypass capacitor placement; see the [Section 7.4.1](#) section.

7.4 Layout

7.4.1 Layout Guidelines

Comparators are very sensitive to input noise. For best results, maintain the following layout guidelines:

- Use a printed-circuit board (PCB) with a good, unbroken low-inductance ground plane. Proper grounding (use of ground plane) helps maintain specified performance of the TLV1704-SEP device.
- To minimize supply noise, place a decoupling capacitor (0.1 μF ceramic, surface-mount capacitor) as close as possible to V_S as shown in Figure 7-3.
- On the inputs and the output, keep lead lengths as short as possible to avoid unwanted parasitic feedback around the comparator. Keep inputs away from the output.
- Solder the device directly to the PCB rather than using a socket.
- For slow-moving input signals, take care to prevent parasitic feedback. A small capacitor (1000pF or less) placed between the inputs can help eliminate oscillations in the transition region. This capacitor causes some degradation to propagation delay when the impedance is low. Run the topside ground plane between the output and inputs.
- Run the ground pin ground trace under the device up to the bypass capacitor, shielding the inputs from the outputs.

7.4.2 Layout Example

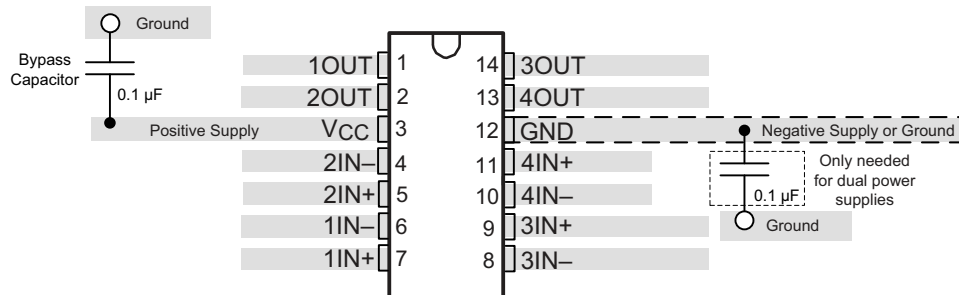

Figure 7-3. Comparator Board Layout

8 Device and Documentation Support

8.1 Documentation Support

8.1.1 Related Documentation

For related documentation, see the following:

- [Precision Design, Comparator with Hysteresis Reference Design](#) , TIDU020
- [REF33xx 3.9-µA, SC70-3, SOT-23-3, and UQFN-8, 30-ppm/°C Drift Voltage Reference](#) , SBOS392

8.2 Receiving Notification of Documentation Updates

To receive notification of documentation updates, navigate to the device product folder on [ti.com](https://www.ti.com). Click on *Notifications* to register and receive a weekly digest of any product information that has changed. For change details, review the revision history included in any revised document.

8.3 Support Resources

[TI E2E™ support forums](#) are an engineer's go-to source for fast, verified answers and design help — straight from the experts. Search existing answers or ask your own question to get the quick design help you need.

Linked content is provided "AS IS" by the respective contributors. They do not constitute TI specifications and do not necessarily reflect TI's views; see TI's [Terms of Use](#).

8.4 Trademarks

TI E2E™ is a trademark of Texas Instruments.
All trademarks are the property of their respective owners.

8.5 Electrostatic Discharge Caution



This integrated circuit can be damaged by ESD. Texas Instruments recommends that all integrated circuits be handled with appropriate precautions. Failure to observe proper handling and installation procedures can cause damage.

ESD damage can range from subtle performance degradation to complete device failure. Precision integrated circuits may be more susceptible to damage because very small parametric changes could cause the device not to meet its published specifications.

8.6 Glossary

[TI Glossary](#) This glossary lists and explains terms, acronyms, and definitions.

9 Revision History

NOTE: Page numbers for previous revisions may differ from page numbers in the current version.

Changes from Revision A (November 2022) to Revision B (July 2024)	Page
• Changed maximum supply voltage from 36V to 24V.....	1
• Changed device grade in the <i>Device Information</i> table from 20krad(Si) RLAT to 30krad(Si) RLAT.....	1
• Updated formatting for measurements throughout the document.....	1
• Updated the <i>Typical Performance Characteristics</i> graphs.....	6

Changes from Revision * (November 2018) to Revision A (November 2022)	Page
• Updated the numbering format for tables, figures, and cross-references throughout the document.....	1
• Updated the title from Radiation Hardened to Radiation-Tolerant.....	1
• Updated Applications with links.....	1

10 Mechanical, Packaging, and Orderable Information

The following pages include mechanical, packaging, and orderable information. This information is the most current data available for the designated devices. This data is subject to change without notice and revision of this document. For browser-based versions of this data sheet, refer to the left-hand navigation.

PACKAGING INFORMATION

Orderable Device	Status (1)	Package Type	Package Drawing	Pins	Package Qty	Eco Plan (2)	Lead finish/ Ball material (6)	MSL Peak Temp (3)	Op Temp (°C)	Device Marking (4/5)	Samples
TLV1704AMPWPSEP	ACTIVE	TSSOP	PW	14	90	RoHS & Green	NIPDAU	Level-2-260C-1 YEAR	-55 to 125	1704SEP	Samples
TLV1704AMPWTPSEP	ACTIVE	TSSOP	PW	14	250	RoHS & Green	NIPDAU	Level-2-260C-1 YEAR	-55 to 125	1704SEP	Samples
V62/18613-01XE	ACTIVE	TSSOP	PW	14	250	RoHS & Green	NIPDAU	Level-2-260C-1 YEAR	-55 to 125	1704SEP	Samples
V62/18613-01XE-T	ACTIVE	TSSOP	PW	14	90	RoHS & Green	NIPDAU	Level-2-260C-1 YEAR	-55 to 125	1704SEP	Samples

(1) The marketing status values are defined as follows:

ACTIVE: Product device recommended for new designs.

LIFEBUY: TI has announced that the device will be discontinued, and a lifetime-buy period is in effect.

NRND: Not recommended for new designs. Device is in production to support existing customers, but TI does not recommend using this part in a new design.

PREVIEW: Device has been announced but is not in production. Samples may or may not be available.

OBSELETE: TI has discontinued the production of the device.

(2) **RoHS:** TI defines "RoHS" to mean semiconductor products that are compliant with the current EU RoHS requirements for all 10 RoHS substances, including the requirement that RoHS substance do not exceed 0.1% by weight in homogeneous materials. Where designed to be soldered at high temperatures, "RoHS" products are suitable for use in specified lead-free processes. TI may reference these types of products as "Pb-Free".

RoHS Exempt: TI defines "RoHS Exempt" to mean products that contain lead but are compliant with EU RoHS pursuant to a specific EU RoHS exemption.

Green: TI defines "Green" to mean the content of Chlorine (Cl) and Bromine (Br) based flame retardants meet JS709B low halogen requirements of <=1000ppm threshold. Antimony trioxide based flame retardants must also meet the <=1000ppm threshold requirement.

(3) MSL, Peak Temp. - The Moisture Sensitivity Level rating according to the JEDEC industry standard classifications, and peak solder temperature.

(4) There may be additional marking, which relates to the logo, the lot trace code information, or the environmental category on the device.

(5) Multiple Device Markings will be inside parentheses. Only one Device Marking contained in parentheses and separated by a "-" will appear on a device. If a line is indented then it is a continuation of the previous line and the two combined represent the entire Device Marking for that device.

(6) Lead finish/Ball material - Orderable Devices may have multiple material finish options. Finish options are separated by a vertical ruled line. Lead finish/Ball material values may wrap to two lines if the finish value exceeds the maximum column width.

Important Information and Disclaimer:The information provided on this page represents TI's knowledge and belief as of the date that it is provided. TI bases its knowledge and belief on information provided by third parties, and makes no representation or warranty as to the accuracy of such information. Efforts are underway to better integrate information from third parties. TI has taken and

continues to take reasonable steps to provide representative and accurate information but may not have conducted destructive testing or chemical analysis on incoming materials and chemicals. TI and TI suppliers consider certain information to be proprietary, and thus CAS numbers and other limited information may not be available for release.

In no event shall TI's liability arising out of such information exceed the total purchase price of the TI part(s) at issue in this document sold by TI to Customer on an annual basis.

OTHER QUALIFIED VERSIONS OF TLV1704-SEP :

- Automotive : [TLV1704-Q1](#)

NOTE: Qualified Version Definitions:

- Automotive - Q100 devices qualified for high-reliability automotive applications targeting zero defects

TAPE AND REEL INFORMATION

QUADRANT ASSIGNMENTS FOR PIN 1 ORIENTATION IN TAPE

*All dimensions are nominal

Device	Package Type	Package Drawing	Pins	SPQ	Reel Diameter (mm)	Reel Width W1 (mm)	A0 (mm)	B0 (mm)	K0 (mm)	P1 (mm)	W (mm)	Pin1 Quadrant
TLV1704AMPWTPSEP	TSSOP	PW	14	250	180.0	12.4	6.9	5.6	1.6	8.0	12.0	Q1

TAPE AND REEL BOX DIMENSIONS

*All dimensions are nominal

Device	Package Type	Package Drawing	Pins	SPQ	Length (mm)	Width (mm)	Height (mm)
TLV1704AMPWTPSEP	TSSOP	PW	14	250	210.0	185.0	35.0

TUBE

*All dimensions are nominal

Device	Package Name	Package Type	Pins	SPQ	L (mm)	W (mm)	T (μm)	B (mm)
TLV1704AMPWPSEP	PW	TSSOP	14	90	530	10.2	3600	3.5
V62/18613-01XE-T	PW	TSSOP	14	90	530	10.2	3600	3.5

PW0014A



PACKAGE OUTLINE
TSSOP - 1.2 mm max height

SMALL OUTLINE PACKAGE



4220202/B 12/2023

NOTES:

1. All linear dimensions are in millimeters. Any dimensions in parenthesis are for reference only. Dimensioning and tolerancing per ASME Y14.5M.
2. This drawing is subject to change without notice.
3. This dimension does not include mold flash, protrusions, or gate burrs. Mold flash, protrusions, or gate burrs shall not exceed 0.15 mm per side.
4. This dimension does not include interlead flash. Interlead flash shall not exceed 0.25 mm per side.
5. Reference JEDEC registration MO-153.

EXAMPLE BOARD LAYOUT

PW0014A

TSSOP - 1.2 mm max height

SMALL OUTLINE PACKAGE

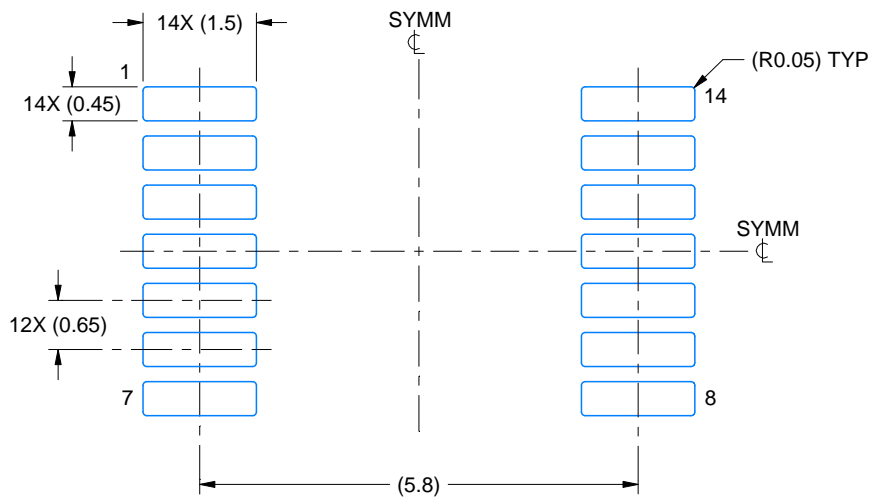

LAND PATTERN EXAMPLE
EXPOSED METAL SHOWN
SCALE: 10X



4220202/B 12/2023

NOTES: (continued)

6. Publication IPC-7351 may have alternate designs.
7. Solder mask tolerances between and around signal pads can vary based on board fabrication site.

EXAMPLE STENCIL DESIGN

PW0014A

TSSOP - 1.2 mm max height

SMALL OUTLINE PACKAGE



SOLDER PASTE EXAMPLE
BASED ON 0.125 mm THICK STENCIL
SCALE: 10X

4220202/B 12/2023

NOTES: (continued)

8. Laser cutting apertures with trapezoidal walls and rounded corners may offer better paste release. IPC-7525 may have alternate design recommendations.
9. Board assembly site may have different recommendations for stencil design.

IMPORTANT NOTICE AND DISCLAIMER

TI PROVIDES TECHNICAL AND RELIABILITY DATA (INCLUDING DATA SHEETS), DESIGN RESOURCES (INCLUDING REFERENCE DESIGNS), APPLICATION OR OTHER DESIGN ADVICE, WEB TOOLS, SAFETY INFORMATION, AND OTHER RESOURCES "AS IS" AND WITH ALL FAULTS, AND DISCLAIMS ALL WARRANTIES, EXPRESS AND IMPLIED, INCLUDING WITHOUT LIMITATION ANY IMPLIED WARRANTIES OF MERCHANTABILITY, FITNESS FOR A PARTICULAR PURPOSE OR NON-INFRINGEMENT OF THIRD PARTY INTELLECTUAL PROPERTY RIGHTS.

These resources are intended for skilled developers designing with TI products. You are solely responsible for (1) selecting the appropriate TI products for your application, (2) designing, validating and testing your application, and (3) ensuring your application meets applicable standards, and any other safety, security, regulatory or other requirements.

These resources are subject to change without notice. TI grants you permission to use these resources only for development of an application that uses the TI products described in the resource. Other reproduction and display of these resources is prohibited. No license is granted to any other TI intellectual property right or to any third party intellectual property right. TI disclaims responsibility for, and you will fully indemnify TI and its representatives against, any claims, damages, costs, losses, and liabilities arising out of your use of these resources.

TI's products are provided subject to [TI's Terms of Sale](#) or other applicable terms available either on [ti.com](https://www.ti.com) or provided in conjunction with such TI products. TI's provision of these resources does not expand or otherwise alter TI's applicable warranties or warranty disclaimers for TI products.

TI objects to and rejects any additional or different terms you may have proposed.

Mailing Address: Texas Instruments, Post Office Box 655303, Dallas, Texas 75265
Copyright © 2024, Texas Instruments Incorporated