

TLV277x-EP, TLV277xA-EP

FAMILY OF 2.7-V HIGH-SLEW-RATE RAIL-TO-RAIL OUTPUT OPERATIONAL AMPLIFIERS WITH SHUTDOWN

SGLS317A – OCTOBER 2005 – REVISED SEPTEMBER 2007

- **Controlled Baseline**
 - One Assembly/Test Site, One Fabrication Site
- **Extended Temperature Performance of –55°C to 125°C**
- **Enhanced Diminishing Manufacturing Sources (DMS) Support**
- **Enhanced Product-Change Notification**
- **Qualification Pedigree⁽¹⁾**
- **ESD Protection Exceeds 2000 V Per MIL-STD-883, Method 3015; Exceeds 200 V Using Machine Model (C = 200 pF, R = 0)**
- **High Slew Rate . . . 10.5 V/μs Typ**
- **High-Gain Bandwidth . . . 5.1 MHz Typ**
- **Supply Voltage Range 2.5 V to 5.5 V**
- **Rail-to-Rail Output**
- **360 μV Input Offset Voltage**
- **Low Distortion Driving 600-Ω 0.005% THD+N**
- **1 mA Supply Current (Per Channel)**
- **17 nV/√Hz Input Noise Voltage**
- **2 pA Input Bias Current**
- **Characterized From T_A = –55°C to 125°C**
- **Micropower Shutdown Mode . . . I_{DD} < 1 μA**

[†] Component qualification in accordance with JEDEC and industry standards to ensure reliable operation over an extended temperature range. This includes, but is not limited to, Highly Accelerated Stress Test (HAST) or biased 85/85, temperature cycle, autoclave or unbiased HAST, electromigration, bond intermetallic life, and mold compound life. Such qualification testing should not be viewed as justifying use of this component beyond specified performance and environmental limits.

description

The TLV277x CMOS operational amplifier family combines high slew rate and bandwidth, rail-to-rail output swing, high output drive, and excellent dc precision. The device provides 10.5 V/μs of slew rate and 5.1 MHz of bandwidth while only consuming 1 mA of supply current per channel. This ac performance is much higher than current competitive CMOS amplifiers. The rail-to-rail output swing and high output drive make these devices a good choice for driving the analog input or reference of analog-to-digital converters (ADCs). These devices also have low distortion while driving a 600-Ω load for use in telecom systems.

These amplifiers have a 360-μV input offset voltage, a 17 nV/√Hz input noise voltage, and a 2-pA input bias current for measurement, medical, and industrial applications. The TLV277x family is also specified across an extended temperature range (–55°C to 125°C), making it useful for military and avionics systems.

These devices operate from a 2.5-V to 5.5-V single supply voltage and are characterized at 2.7 V and 5 V. The single-supply operation and low power consumption make these devices a good solution for portable applications. The following table lists the packages available.

FAMILY PACKAGE TABLE

DEVICE	NUMBER OF CHANNELS	PACKAGE TYPES		SHUTDOWN	UNIVERSAL EVM BOARD
		SOIC	TSSOP		
TLV2770	1	8	—	Yes	See the EVM Selection Guide (SLOU060)
TLV2771	1	8	—	—	
TLV2772	2	8	8	—	
TLV2773	2	14	—	Yes	
TLV2774	4	14	14	—	
TLV2775	4	16	16	Yes	



Please be aware that an important notice concerning availability, standard warranty, and use in critical applications of Texas Instruments semiconductor products and disclaimers thereto appears at the end of this data sheet.

UNLESS OTHERWISE NOTED this document contains PRODUCTION DATA information current as of publication date. Products conform to specifications per the terms of Texas Instruments standard warranty. Production processing does not necessarily include testing of all parameters.



POST OFFICE BOX 655303 • DALLAS, TEXAS 75265

Copyright © 2007 Texas Instruments Incorporated

TLV277x-EP, TLV277xA-EP FAMILY OF 2.7-V HIGH-SLEW-RATE RAIL-TO-RAIL OUTPUT OPERATIONAL AMPLIFIERS WITH SHUTDOWN

SGLS317A – OCTOBER 2005 – REVISED SEPTEMBER 2007

SELECTION OF SINGLE-SUPPLY OPERATIONAL AMPLIFIER PRODUCTS†

DEVICE	V _{DD} (V)	BW (MHz)	SLEW RATE (V/μs)	I _{DD} (per channel) (μA)	RAIL-TO-RAIL
TLV277X	2.5 to 6	5.1	10.5	1000	O
TLV247X	2.7 to 6	2.8	1.5	600	I/O
TLV245X	2.7 to 6	0.22	0.11	23	I/O
TLV246X	2.7 to 6	6.4	1.6	550	I/O

† All specifications measured at 5 V.

ORDERING INFORMATION†

T _A	V _{IO} MAX AT 25°C (mV)	PACKAGE‡		ORDERABLE PART NUMBER	TOP SIDE MARKING
-55°C to 125°C	2.5	SOIC (D)	Tape and reel	TLV2770MDREP§	
	1.6	SOIC (D)	Tape and reel	TLV2770AMDREP§	
	2.5	SOIC (D)	Tape and reel	TLV2771MDREP§	
	1.6	SOIC (D)	Tape and reel	TLV2771AMDREP§	
	2.5	SOIC (D)	Tape and reel	TLV2772MDREP§	
		TSSOP (PW)	Tape and reel	TLV2772MPWREP§	
	1.6	SOIC (D)	Tape and reel	TLV2772AMDREP	2772AE
		TSSOP (PW)	Tape and reel	TLV2772AMPWREP§	
	2.5	SOIC (D)	Tape and reel	TLV2773MDREP§	
	1.6	SOIC (D)	Tape and reel	TLV2773AMDREP§	
	2.7	SOIC (D)	Tape and reel	TLV2774MDREP	2774EP
		TSSOP (PW)	Tape and reel	TLV2774MPWREP§	
	2.1	SOIC (D)	Tape and reel	TLV2774AMDREP	2774AEP
		TSSOP (PW)	Tape and reel	TLV2774AMPWREP§	
	2.7	SOIC (D)	Tape and reel	TLV2775MDREP§	
		TSSOP (PW)	Tape and reel	TLV2775MPWREP§	
	2.1	SOIC (D)	Tape and reel	TLV2775AMDREP§	
		TSSOP (PW)	Tape and reel	TLV2775AMPWREP§	

† For the most current package and ordering information, see the Package Option Addendum at the end of this document, or see the TI website at www.ti.com.

‡ Package drawings, standard packing quantities, thermal data, symbolization, and PCB design guidelines are available at www.ti.com/packaging.

§ Product Preview



TLV277x-EP, TLV277xA-EP FAMILY OF 2.7-V HIGH-SLEW-RATE RAIL-TO-RAIL OUTPUT OPERATIONAL AMPLIFIERS WITH SHUTDOWN

SGLS317A – OCTOBER 2005 – REVISED SEPTEMBER 2007

TLV277x PACKAGE PINOUTS

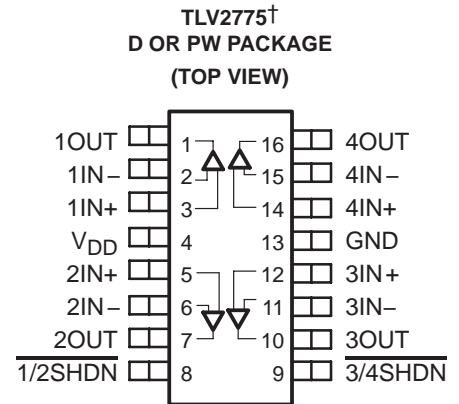
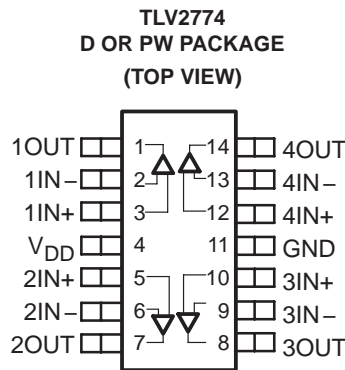
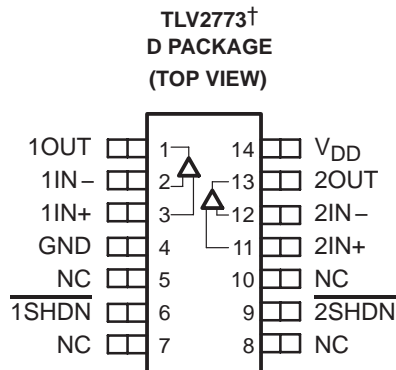
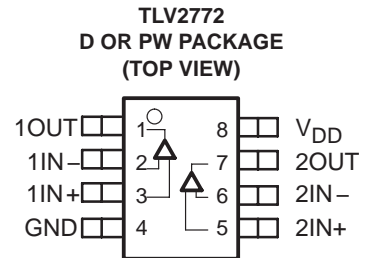
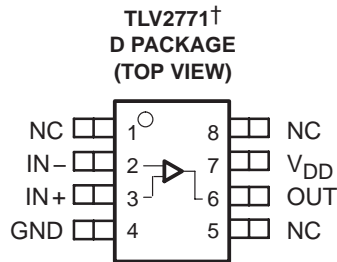
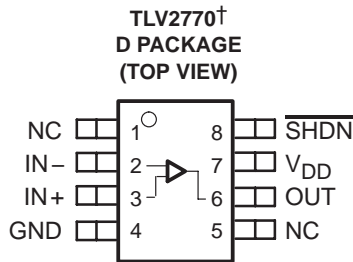

NC – No internal connection

† This device is in the Product Preview stage of development. Please contact your local TI sales office for availability.

TLV277x-EP, TLV277xA-EP FAMILY OF 2.7-V HIGH-SLEW-RATE RAIL-TO-RAIL OUTPUT OPERATIONAL AMPLIFIERS WITH SHUTDOWN

SGLS317A – OCTOBER 2005 – REVISED SEPTEMBER 2007

absolute maximum ratings over operating free-air temperature range (unless otherwise noted)†

Supply voltage, V_{DD} (see Note 1)	7 V
Differential input voltage, V_{ID} (see Note 2)	$\pm V_{DD}$
Input voltage range, V_I (any input, see Note 1)	-0.3 V to V_{DD}
Input current, I_I (any input)	± 4 mA
Output current, I_O	± 50 mA
Total current into V_{DD+}	± 50 mA
Total current out of GND	± 50 mA
Duration of short-circuit current (at or below) 25°C (see Note 3)	unlimited
Continuous total power dissipation	See Dissipation Rating Table
Operating free-air temperature range, T_A : M suffix	-55°C to 125°C
Storage temperature range, T_{stg}	-65°C to 150°C
Lead temperature 1,6 mm (1/16 inch) from case for 10 seconds	260°C

† Stresses beyond those listed under “absolute maximum ratings” may cause permanent damage to the device. These are stress ratings only, and functional operation of the device at these or any other conditions beyond those indicated under “recommended operating conditions” is not implied. Exposure to absolute-maximum-rated conditions for extended periods may affect device reliability.

- NOTES:
1. All voltage values, except differential voltages, are with respect to GND.
 2. Differential voltages are at the noninverting input with respect to the inverting input. Excessive current flows when input is brought below GND - 0.3 V.
 3. The output may be shorted to either supply. Temperature and/or supply voltages must be limited to ensure that the maximum dissipation rating is not exceeded.

DISSIPATION RATING TABLE

PACKAGE	θ_{JC} (°C/W)		θ_{JA} (°C/W, 0 AIR FLOW)	
	HIGH K	LOW K	HIGH K	LOW K
D(8)	39.4	42.4	97.1	165.5
D(14)	51.5	53.7	86.2	133.5
D(16)	36.9	38.4	73.1	111.6
PW(8)	65.1	69.4	149.4	230.5
PW(14)	45.8	46.6	111.7	131.4
PW(16)	33.6	35	108.4	147.0

NOTE 4: Thermal resistances are not production tested and are for informational purposes only.

recommended operating conditions

	M SUFFIX		UNIT
	MIN	MAX	
Supply voltage, V_{DD}	2.5	6	V
Input voltage range, V_I	GND	$V_{DD+} - 1.3$	V
Common-mode input voltage, V_{IC}	GND	$V_{DD+} - 1.3$	V
Operating free-air temperature, T_A	-55	125	°C



TLV277x-EP, TLV277xA-EP
FAMILY OF 2.7-V HIGH-SLEW-RATE RAIL-TO-RAIL OUTPUT
OPERATIONAL AMPLIFIERS WITH SHUTDOWN

SGLS317A – OCTOBER 2005 – REVISED SEPTEMBER 2007

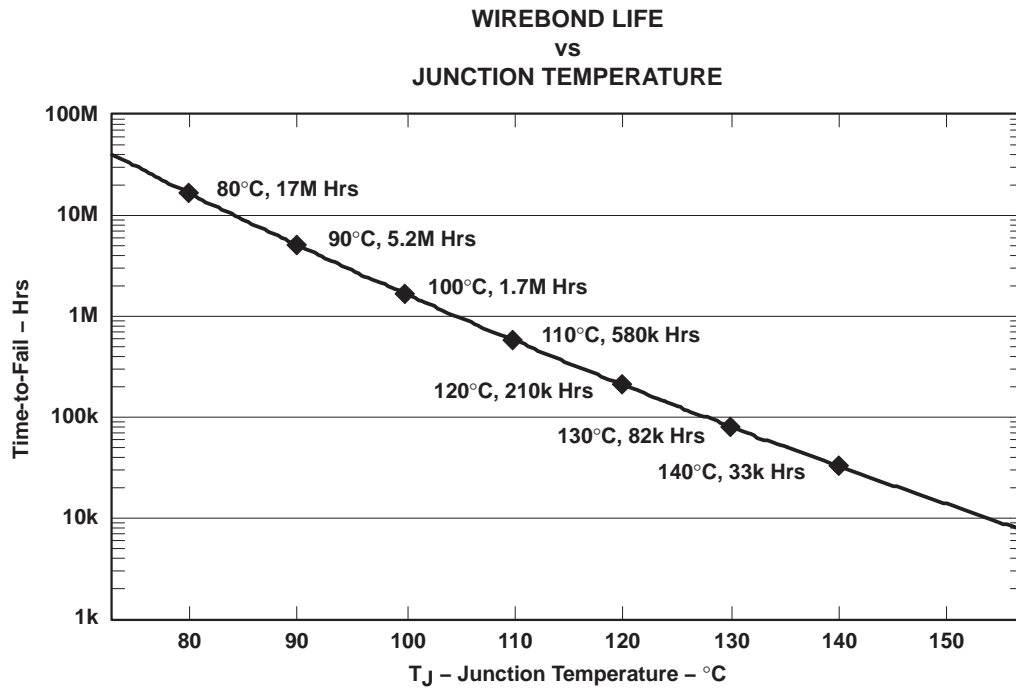

Figure 1. Wirebond Life Estimation

TLV277x-EP, TLV277xA-EP FAMILY OF 2.7-V HIGH-SLEW-RATE RAIL-TO-RAIL OUTPUT OPERATIONAL AMPLIFIERS WITH SHUTDOWN

SGLS317A – OCTOBER 2005 – REVISED SEPTEMBER 2007

electrical characteristics at specified free-air temperature, $V_{DD} = 2.7\text{ V}$ (unless otherwise noted)

PARAMETER	TEST CONDITIONS		T_A †	TLV277xM			TLV277xAM			UNIT
				MIN	TYP	MAX	MIN	TYP	MAX	
V_{IO} Input offset voltage	$V_{DD} = \pm 1.35\text{ V}$, $V_{IC} = 0$, $V_O = 0$, $R_S = 50\ \Omega$	TLV2770/1/2/3	25°C	0.44	2.5		0.44	1.6	mV	
			Full range			2.7		1.9		
		TLV2774/5	25°C		0.8	2.7		0.8		2.1
			Full range				3.0			2.4
α_{VIO} Temperature coefficient of input offset voltage	$V_{DD} = \pm 1.35\text{ V}$, $V_{IC} = 0$, $V_O = 0$, $R_S = 50\ \Omega$		25°C to 125°C		2		2		$\mu\text{V}/^\circ\text{C}$	
I_{IO} Input offset current	$V_{DD} = \pm 1.35\text{ V}$, $V_{IC} = 0$, $V_O = 0$, $R_S = 50\ \Omega$	TLV2770/1/2/3	25°C		1	60		1	60	pA
			Full range			125		125		
		TLV2774/5	Full range			200		200		
I_{IB} Input bias current	$V_{DD} = \pm 1.35\text{ V}$, $V_{IC} = 0$, $V_O = 0$, $R_S = 50\ \Omega$	TLV2770/1/2/3	25°C		2	60		2	60	pA
			Full range			350		350		
		TLV2774/5	Full range			500		500		
V_{ICR} Common-mode input voltage range	CMRR > 60 dB, $R_S = 50\ \Omega$		25°C	0 to 1.4	-0.3 to 1.7		0 to 1.4	-0.3 to 1.7	V	
			Full range	0 to 1.4	-0.3 to 1.7		0 to 1.4	-0.3 to 1.7		
V_{OH} High-level output voltage	$I_{OH} = -0.675\text{ mA}$		25°C		2.6		2.6	V		
			Full range		2.45		2.45			
	$I_{OH} = -2.2\text{ mA}$		25°C		2.4		2.4			
			Full range		2.1		2.1			
V_{OL} Low-level output voltage	$V_{IC} = 1.35\text{ V}$, $I_{OL} = 0.675\text{ mA}$		25°C		0.1		0.1	V		
			Full range			0.2			0.2	
	$V_{IC} = 1.35\text{ V}$, $I_{OL} = 2.2\text{ mA}$		25°C		0.21		0.21			
			Full range			0.6			0.6	
A_{VD} Large-signal differential voltage amplification	$V_{IC} = 1.35\text{ V}$, $V_O = 0.6\text{ V to } 2.1\text{ V}$	$R_L = 10\text{ k}\Omega$ ‡	25°C	20	380		20	380	V/mV	
			Full range		13		13			
$r_{i(d)}$ Differential input resistance			25°C		10^{12}		10^{12}	Ω		
$C_{i(c)}$ Common-mode input capacitance	$f = 10\text{ kHz}$,		25°C		8		8	pF		
Z_o Closed-loop output impedance	$f = 100\text{ kHz}$,	$A_V = 10$	25°C		25		25	Ω		
CMRR Common-mode rejection ratio	$V_{IC} = V_{ICR}(\text{min})$, $R_S = 50\ \Omega$	$V_O = 1.5\text{ V}$,	25°C	60	84		60	84	dB	
			Full range		60	82		60		82
k_{SVR} Supply voltage rejection ratio ($\Delta V_{DD} / \Delta V_{IO}$)	$V_{DD} = 2.7\text{ V to } 5\text{ V}$, No load	$V_{IC} = V_{DD}/2$,	25°C	70	89		70	89	dB	
			Full range		70	84		70		84
I_{DD} Supply current (per channel)	$V_O = 1.5\text{ V}$,	No load	25°C		1	2		1	2	mA
			Full range			2		2		

† Full range is -55°C to 125°C for M level part.

‡ Referenced to 1.35 V



TLV277x-EP, TLV277xA-EP
FAMILY OF 2.7-V HIGH-SLEW-RATE RAIL-TO-RAIL OUTPUT
OPERATIONAL AMPLIFIERS WITH SHUTDOWN

SGLS317A – OCTOBER 2005 – REVISED SEPTEMBER 2007

operating characteristics at specified free-air temperature, $V_{DD} = 2.7\text{ V}$ (unless otherwise noted)

PARAMETER	TEST CONDITIONS	T_A †	TLV277xM			TLV277xAM			UNIT	
			MIN	TYP	MAX	MIN	TYP	MAX		
SR	Slew rate at unity gain	$V_{O(PP)} = 0.8\text{ V}$, $C_L = 100\text{ pF}$, $R_L = 10\text{ k}\Omega$	25°C	5	9		5	9	V/ μ s	
			Full range	4.7	6		4.7	6		
V_n	Equivalent input noise voltage		25°C	f = 1 kHz			21			nV/ $\sqrt{\text{Hz}}$
				f = 10 kHz			17			
$V_{N(PP)}$	Peak-to-peak equivalent input noise voltage		25°C	f = 0.1 Hz to 1 Hz			0.33			μ V
				f = 0.1 Hz to 10 Hz			0.86			μ V
I_n	Equivalent input noise current		25°C	f = 100 Hz			0.6			fA/ $\sqrt{\text{Hz}}$
THD + N	Total harmonic distortion plus noise	$R_L = 600\ \Omega$, f = 1 kHz	25°C	$A_V = 1$			0.0085%			
				$A_V = 10$			0.025%			
				$A_V = 100$			0.12%			
	Gain-bandwidth product	f = 10 kHz, $C_L = 100\text{ pF}$	25°C	$R_L = 600\ \Omega$			4.8			MHz
t_s	Settling time	$A_V = -1$, Step = 0.85 V to 1.85 V, $R_L = 600\ \Omega$, $C_L = 100\text{ pF}$	25°C	0.1%			0.186			μ s
				0.01%			3.92			
ϕ_m	Phase margin at unity gain	$R_L = 600\ \Omega$, $C_L = 100\text{ pF}$	25°C	46°			46°			
	Gain margin		25°C	12			12			dB

† Full range is -55°C to 125°C for M level part.

TLV277x-EP, TLV277xA-EP FAMILY OF 2.7-V HIGH-SLEW-RATE RAIL-TO-RAIL OUTPUT OPERATIONAL AMPLIFIERS WITH SHUTDOWN

SGLS317A – OCTOBER 2005 – REVISED SEPTEMBER 2007

electrical characteristics at specified free-air temperature, $V_{DD} = 5\text{ V}$ (unless otherwise noted)

PARAMETER	TEST CONDITIONS		T_A †	TLV277xM			TLV277xAM			UNIT
				MIN	TYP	MAX	MIN	TYP	MAX	
V_{IO} Input offset voltage	$V_{DD} = \pm 2.5\text{ V}$, $V_{IC} = 0$, $V_O = 0$, $R_S = 50\ \Omega$	TLV2770/1/2/3	25°C	0.36	2.5		0.36	1.6	mV	
			Full range			2.7		1.9		
		TLV2774/5	25°C		0.8	2.5		0.8		2.1
			Full range			2.7		2.4		
α_{VIO} Temperature coefficient of input offset voltage	$V_{DD} = \pm 2.5\text{ V}$, $V_{IC} = 0$, $V_O = 0$, $R_S = 50\ \Omega$		25°C to 125°C		2		2		$\mu\text{V}/^\circ\text{C}$	
I_{IO} Input offset current	$V_{DD} = \pm 2.5\text{ V}$, $V_{IC} = 0$, $V_O = 0$, $R_S = 50\ \Omega$		25°C		1	60		1	60	pA
			Full range	TLV2770/1/2/3			125		125	
				TLV2774/5			200		200	
I_{IB} Input bias current	$V_{DD} = \pm 2.5\text{ V}$, $V_{IC} = 0$, $V_O = 0$, $R_S = 50\ \Omega$		25°C		2	60		2	60	pA
			Full range	TLV2770/1/2/3			350		350	
				TLV2774/5			500		500	
V_{ICR} Common-mode input voltage range	CMRR > 60 dB, $R_S = 50\ \Omega$		25°C	0 to 3.7	-0.3 to 3.8		0 to 3.7	-0.3 to 3.8	V	
			Full range	0 to 3.7	-0.3 to 3.8		0 to 3.7	-0.3 to 3.8		
V_{OH} High-level output voltage	$I_{OH} = -1.3\text{ mA}$		25°C		4.9		4.9	V		
			Full range		4.8		4.8			
	$I_{OH} = -4.2\text{ mA}$		25°C		4.7		4.7			
			Full range		4.4		4.4			
V_{OL} Low-level output voltage	$V_{IC} = 2.5\text{ V}$, $I_{OL} = 1.3\text{ mA}$		25°C		0.1		0.1	V		
			Full range		0.2		0.2			
	$V_{IC} = 2.5\text{ V}$, $I_{OL} = 4.2\text{ mA}$		25°C		0.21		0.21			
			Full range		0.6		0.6			
A_{VD} Large-signal differential voltage amplification	$V_{IC} = 2.5\text{ V}$, $V_O = 1\text{ V to }4\text{ V}$	$R_L = 10\text{ k}\Omega$, ‡	25°C	20	450		20	450	V/mV	
			Full range		13		13			
$r_{i(d)}$ Differential input resistance			25°C		1012		1012	Ω		
$C_{i(c)}$ Common-mode input capacitance	$f = 10\text{ kHz}$,		25°C		8		8	pF		
z_o Closed-loop output impedance	$f = 100\text{ kHz}$,	$A_V = 10$	25°C		20		20	Ω		
CMRR Common-mode rejection ratio	$V_{IC} = V_{ICR}(\text{min})$, $R_S = 50\ \Omega$	$V_O = 3.7\text{ V}$,	25°C	60	96		60	96	dB	
			Full range		60	93		60		93
k_{SVR} Supply voltage rejection ratio ($\Delta V_{DD} / \Delta V_{IO}$)	$V_{DD} = 2.7\text{ V to }5\text{ V}$, No load	$V_{IC} = V_{DD}/2$,	25°C	70	89		70	89	dB	
			Full range		70	84		70		84
I_{DD} Supply current (per channel)	$V_O = 1.5\text{ V}$,	No load	25°C		1	2		1	2	mA
			Full range			2		2		

† Full range is -55°C to 125°C for M level part.

‡ Referenced to 2.5 V



TLV277x-EP, TLV277xA-EP
FAMILY OF 2.7-V HIGH-SLEW-RATE RAIL-TO-RAIL OUTPUT
OPERATIONAL AMPLIFIERS WITH SHUTDOWN

SGLS317A – OCTOBER 2005 – REVISED SEPTEMBER 2007

operating characteristics at specified free-air temperature, $V_{DD} = 5\text{ V}$ (unless otherwise noted)

PARAMETER	TEST CONDITIONS	T_A †	TLV277xM			TLV2772xAM			UNIT	
			MIN	TYP	MAX	MIN	TYP	MAX		
SR	Slew rate at unity gain	$V_{O(PP)} = 1.5\text{ V}$, $C_L = 100\text{ pF}$, $R_L = 10\text{ k}\Omega$	25°C	5	10.5		5	10.5	V/ μs	
			Full range	4.7	6		4.7	6		
V_n	Equivalent input noise voltage		25°C	f = 1 kHz			17			nV/ $\sqrt{\text{Hz}}$
				f = 10 kHz			12			
$V_{N(PP)}$	Peak-to-peak equivalent input noise voltage		25°C	f = 0.1 Hz to 1 Hz			0.33			μV
				f = 0.1 Hz to 10 Hz			0.86			μV
I_n	Equivalent input noise current		25°C	f = 100 Hz			0.6			fA/ $\sqrt{\text{Hz}}$
THD + N	Total harmonic distortion plus noise	$R_L = 600\ \Omega$, f = 1 kHz	25°C	$A_V = 1$			0.005%			
				$A_V = 10$			0.016%			
				$A_V = 100$			0.095%			
	Gain-bandwidth product	f = 10 kHz, $C_L = 100\text{ pF}$	25°C	$R_L = 600\ \Omega$			5.1			MHz
t_s	Settling time	$A_V = -1$, Step = 1.5 V to 3.5 V, $R_L = 600\ \Omega$, $C_L = 100\text{ pF}$	25°C	0.1%			0.134			μs
				0.01%			1.97			
ϕ_m	Phase margin at unity gain	$R_L = 600\ \Omega$, $C_L = 100\text{ pF}$	25°C	46°			46°			
	Gain margin		25°C	12			12			dB

† Full range is -55°C to 125°C for M level part.

TLV277x-EP, TLV277xA-EP
FAMILY OF 2.7-V HIGH-SLEW-RATE RAIL-TO-RAIL OUTPUT
OPERATIONAL AMPLIFIERS WITH SHUTDOWN

SGLS317A – OCTOBER 2005 – REVISED SEPTEMBER 2007

TYPICAL CHARACTERISTICS

Table of Graphs

		FIGURE	
V_{IO}	Input offset voltage	Distribution	1,2
		vs Common-mode input voltage	3,4
		Distribution	5,6
I_{IB}/I_{IO}	Input bias and input offset currents	vs Free-air temperature	7
V_{OH}	High-level output voltage	vs High-level output current	8,9
V_{OL}	Low-level output voltage	vs Low-level output current	10,11
$V_{O(PP)}$	Maximum peak-to-peak output voltage	vs Frequency	12,13
I_{OS}	Short-circuit output current	vs Supply voltage	14
		vs Free-air temperature	15
V_O	Output voltage	vs Differential input voltage	16
A_{VD}	Large-signal differential voltage amplification and phase margin	vs Frequency	17,18
A_{VD}	Differential voltage amplification	vs Load resistance	19
		vs Free-air temperature	20,21
z_o	Output impedance	vs Frequency	22,23
CMRR	Common-mode rejection ratio	vs Frequency	24
		vs Free-air temperature	25
k_{SVR}	Supply-voltage rejection ratio	vs Frequency	26,27
I_{DD}	Supply current (per channel)	vs Supply voltage	28
SR	Slew rate	vs Load capacitance	29
		vs Free-air temperature	30
V_O	Voltage-follower small-signal pulse response		31,32
V_O	Voltage-follower large-signal pulse response		33,34
V_O	Inverting small-signal pulse response		35,36
V_O	Inverting large-signal pulse response		37,38
V_n	Equivalent input noise voltage	vs Frequency	39,40
		Noise voltage (referred to input)	Over a 10 second period
THD + N	Total harmonic distortion plus noise	vs Frequency	42,43
		Gain-bandwidth product	vs Supply voltage
B_1	Unity-gain bandwidth	vs Load capacitance	45
ϕ_m	Phase margin	vs Load capacitance	46
		Gain margin	vs Load capacitance
	Amplifier with shutdown pulse turnon/off characteristics		48 – 50
	Supply current with shutdown pulse turnon/off characteristics		51 – 53
	Shutdown supply current	vs Free-air temperature	54
	Shutdown forward/reverse isolation	vs Frequency	55, 56



TLV277x-EP, TLV277xA-EP
FAMILY OF 2.7-V HIGH-SLEW-RATE RAIL-TO-RAIL OUTPUT
OPERATIONAL AMPLIFIERS WITH SHUTDOWN

SGLS317A – OCTOBER 2005 – REVISED SEPTEMBER 2007

TYPICAL CHARACTERISTICS

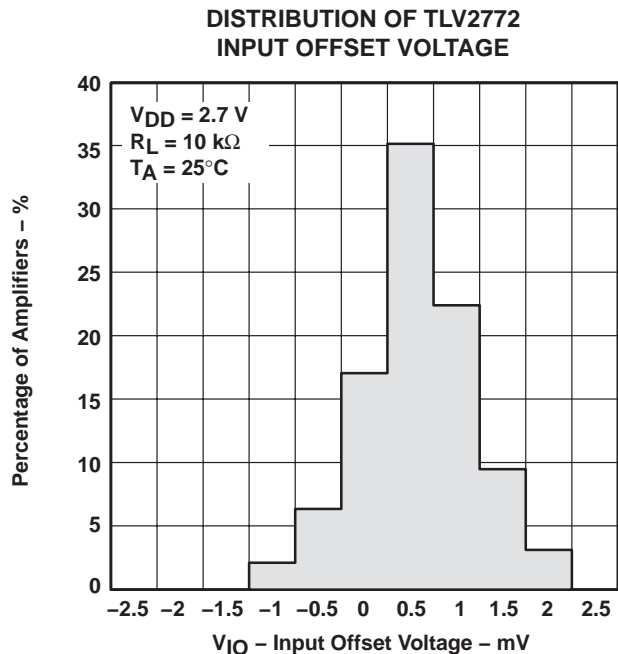

Figure 2

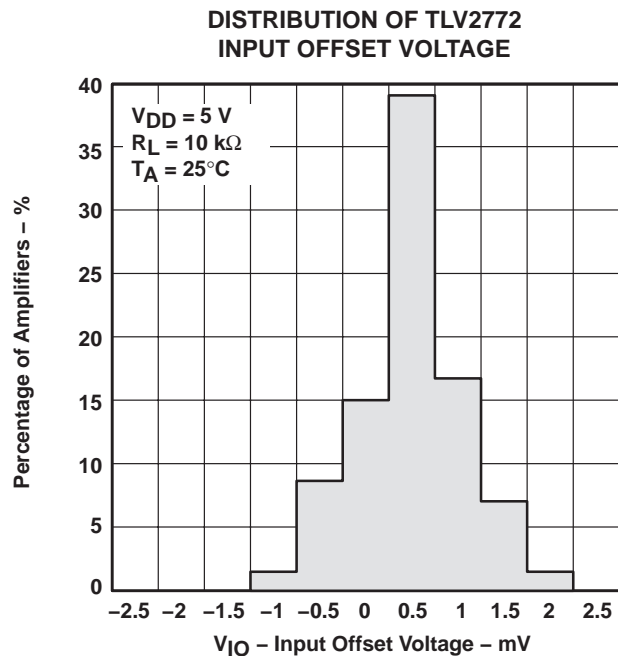

Figure 3

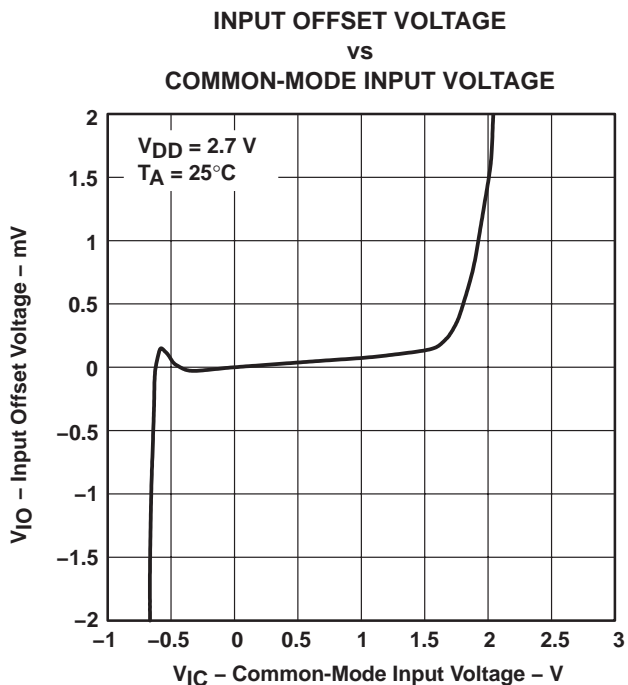

Figure 4



Figure 5

TLV277x-EP, TLV277xA-EP
FAMILY OF 2.7-V HIGH-SLEW-RATE RAIL-TO-RAIL OUTPUT
OPERATIONAL AMPLIFIERS WITH SHUTDOWN

SGLS317A – OCTOBER 2005 – REVISED SEPTEMBER 2007

TYPICAL CHARACTERISTICS

DISTRIBUTION OF TLV2772
INPUT OFFSET VOLTAGE

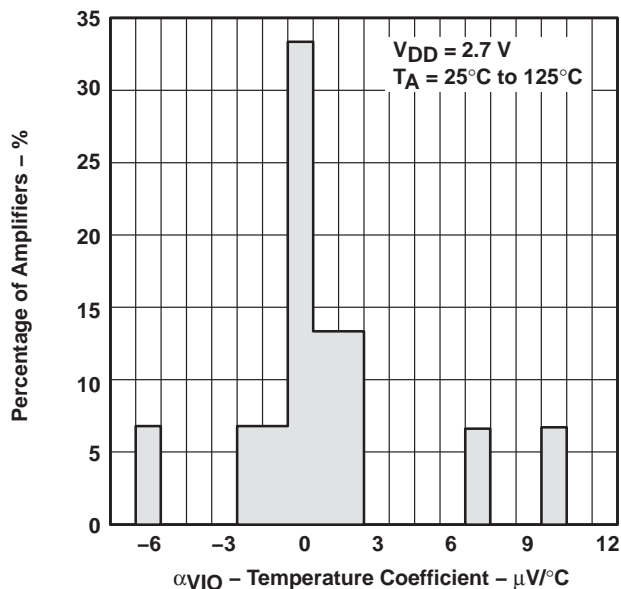

Figure 6

DISTRIBUTION OF TLV2772
INPUT OFFSET VOLTAGE

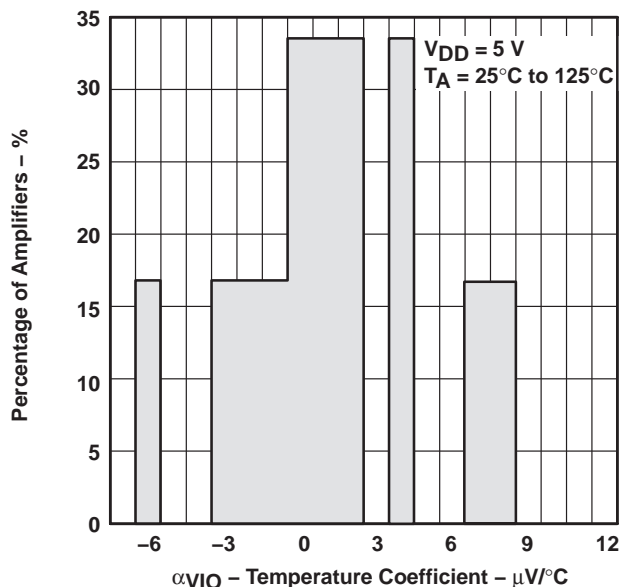

Figure 7

INPUT BIAS AND OFFSET CURRENT
vs
FREE-AIR TEMPERATURE



Figure 8

HIGH-LEVEL OUTPUT VOLTAGE
vs
HIGH-LEVEL OUTPUT CURRENT



Figure 9



TLV277x-EP, TLV277xA-EP
FAMILY OF 2.7-V HIGH-SLEW-RATE RAIL-TO-RAIL OUTPUT
OPERATIONAL AMPLIFIERS WITH SHUTDOWN

SGLS317A – OCTOBER 2005 – REVISED SEPTEMBER 2007

TYPICAL CHARACTERISTICS

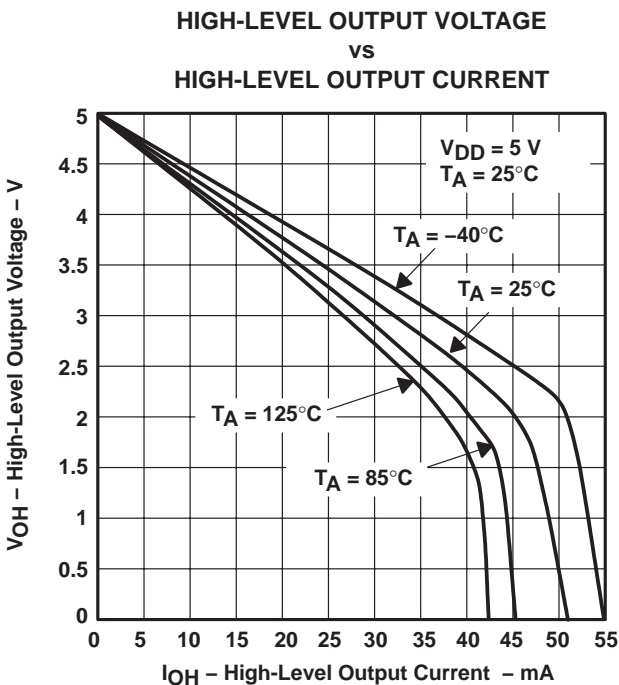

Figure 10



Figure 11

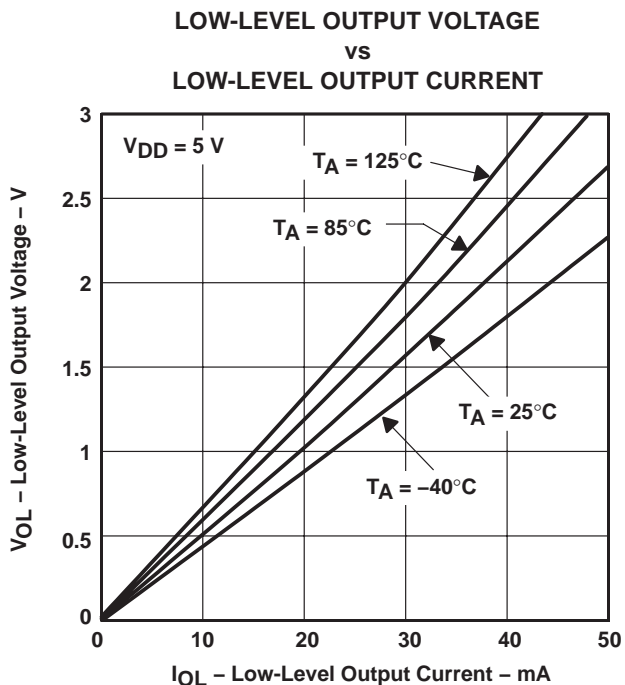

Figure 12

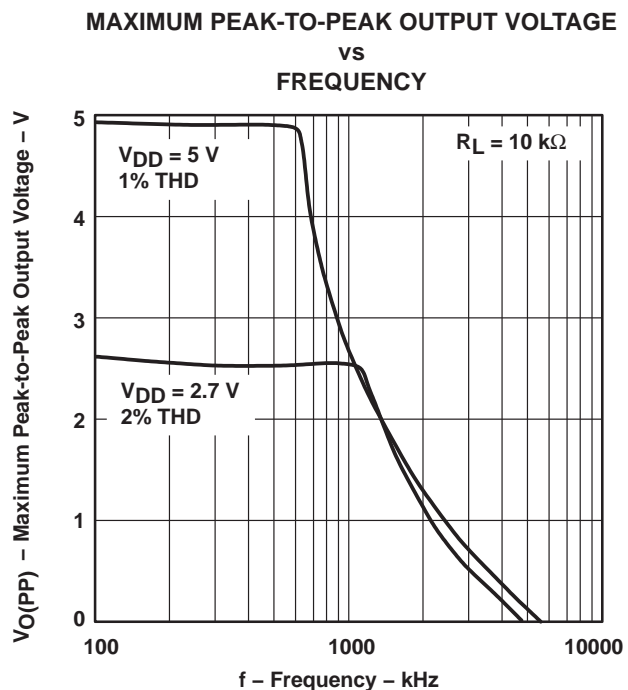

Figure 13



TLV277x-EP, TLV277xA-EP
FAMILY OF 2.7-V HIGH-SLEW-RATE RAIL-TO-RAIL OUTPUT
OPERATIONAL AMPLIFIERS WITH SHUTDOWN

SGLS317A – OCTOBER 2005 – REVISED SEPTEMBER 2007

TYPICAL CHARACTERISTICS

MAXIMUM PEAK-TO-PEAK OUTPUT VOLTAGE
vs
FREQUENCY

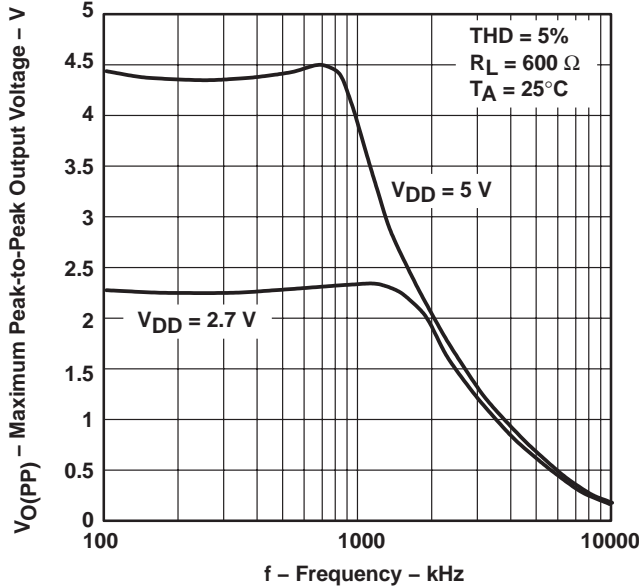

Figure 14

SHORT-CIRCUIT OUTPUT CURRENT
vs
SUPPLY VOLTAGE

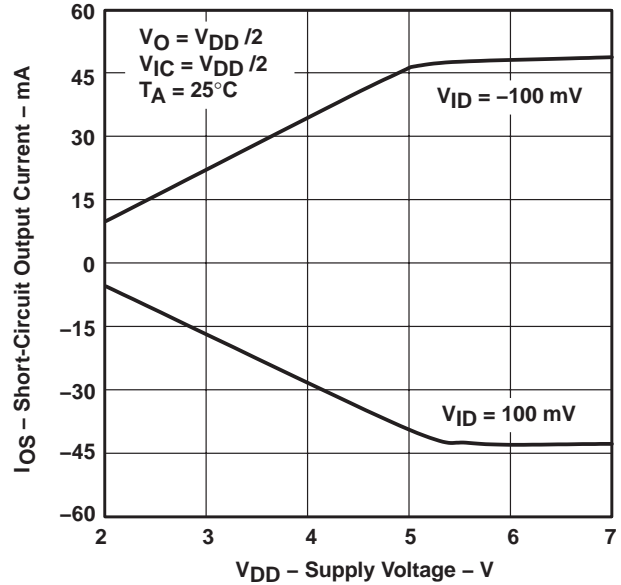

Figure 15

SHORT-CIRCUIT OUTPUT CURRENT
vs
FREE-AIR TEMPERATURE

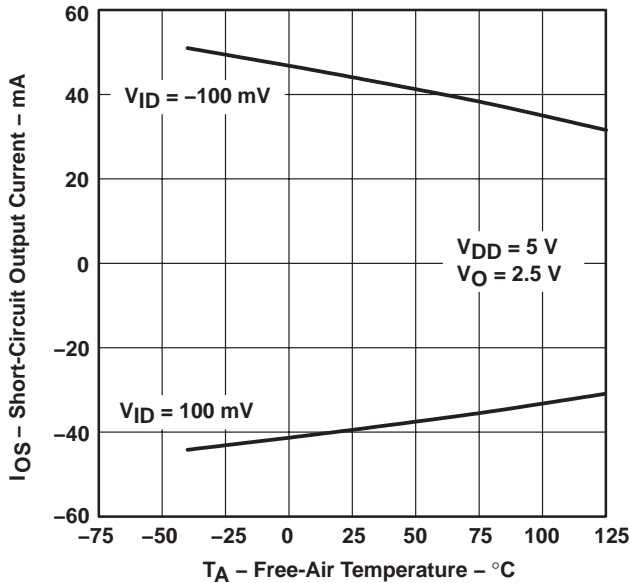

Figure 16

OUTPUT VOLTAGE
vs
DIFFERENTIAL INPUT VOLTAGE

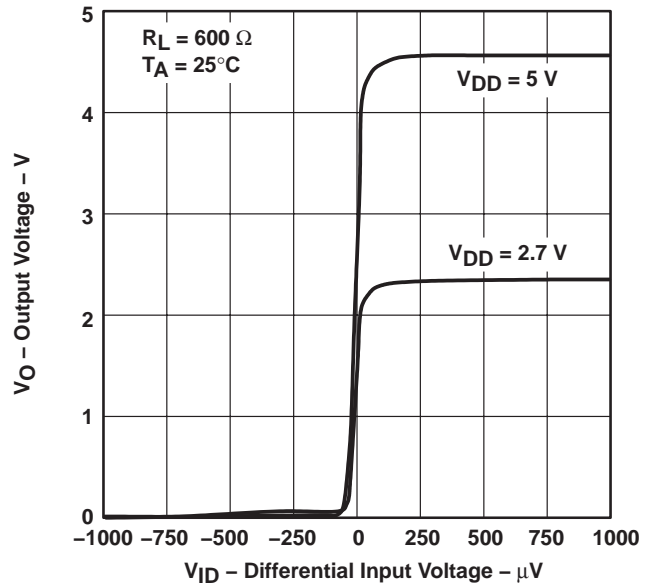

Figure 17

TLV277x-EP, TLV277xA-EP
FAMILY OF 2.7-V HIGH-SLEW-RATE RAIL-TO-RAIL OUTPUT
OPERATIONAL AMPLIFIERS WITH SHUTDOWN

SGLS317A – OCTOBER 2005 – REVISED SEPTEMBER 2007

TYPICAL CHARACTERISTICS

LARGE-SIGNAL DIFFERENTIAL VOLTAGE AMPLIFICATION
AND PHASE MARGIN

vs
FREQUENCY



Figure 18

LARGE-SIGNAL DIFFERENTIAL VOLTAGE AMPLIFICATION
AND PHASE MARGIN

vs
FREQUENCY



Figure 19



TLV277x-EP, TLV277xA-EP
FAMILY OF 2.7-V HIGH-SLEW-RATE RAIL-TO-RAIL OUTPUT
OPERATIONAL AMPLIFIERS WITH SHUTDOWN

SGLS317A – OCTOBER 2005 – REVISED SEPTEMBER 2007

TYPICAL CHARACTERISTICS

DIFFERENTIAL VOLTAGE AMPLIFICATION
vs
LOAD RESISTANCE



Figure 20

DIFFERENTIAL VOLTAGE AMPLIFICATION
vs
FREE-AIR TEMPERATURE

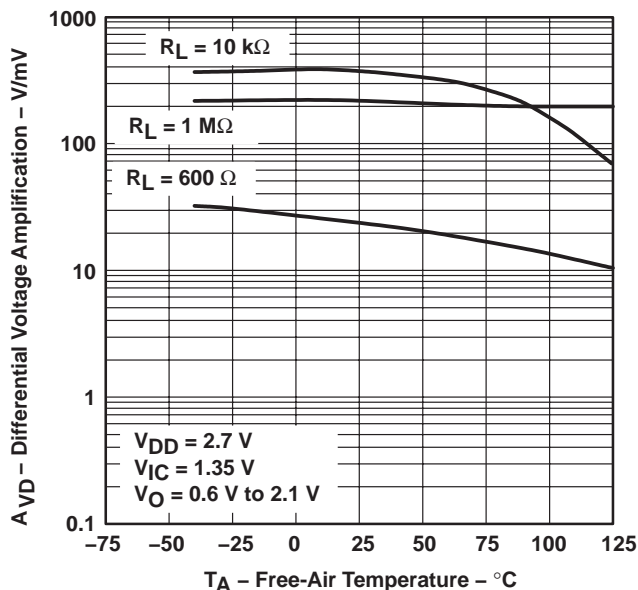

Figure 21

DIFFERENTIAL VOLTAGE AMPLIFICATION
vs
FREE-AIR TEMPERATURE

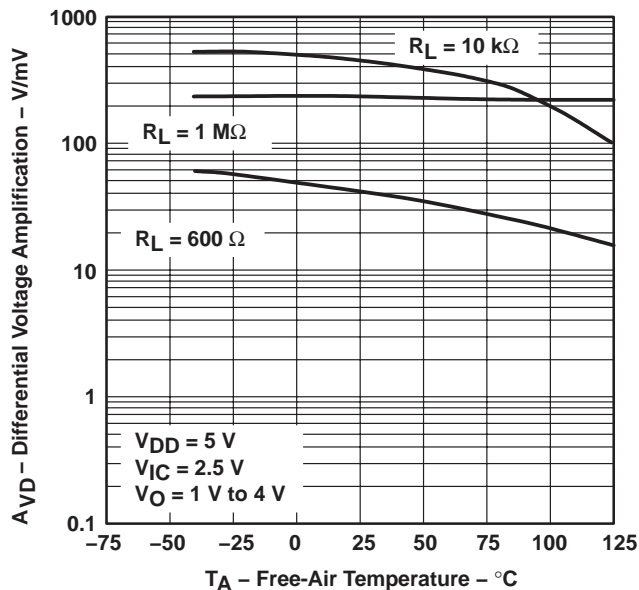

Figure 22

OUTPUT IMPEDANCE
vs
FREQUENCY

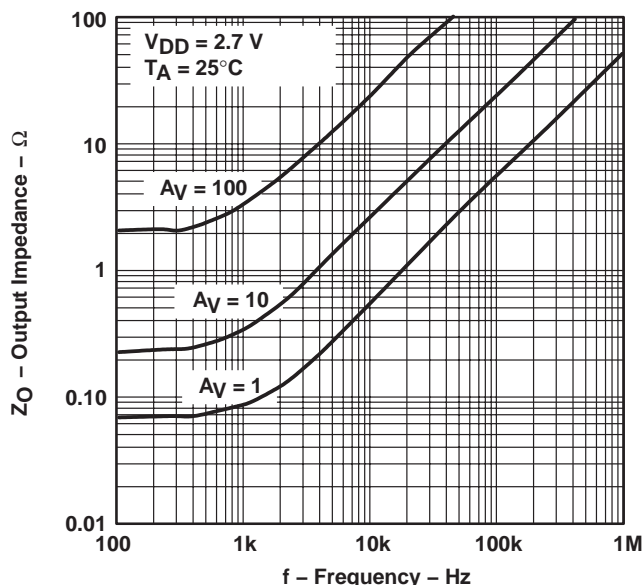

Figure 23



TLV277x-EP, TLV277xA-EP
FAMILY OF 2.7-V HIGH-SLEW-RATE RAIL-TO-RAIL OUTPUT
OPERATIONAL AMPLIFIERS WITH SHUTDOWN

SGLS317A – OCTOBER 2005 – REVISED SEPTEMBER 2007

TYPICAL CHARACTERISTICS

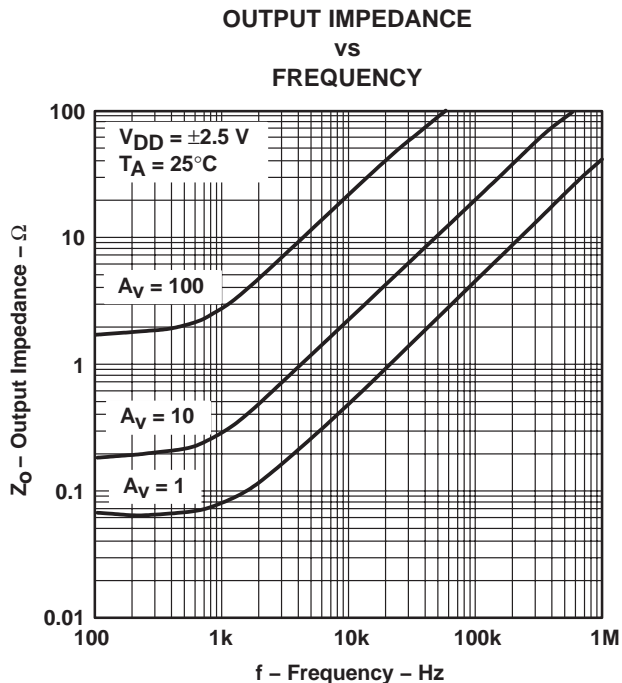

Figure 24



Figure 25



Figure 26



Figure 27

TLV277x-EP, TLV277xA-EP
FAMILY OF 2.7-V HIGH-SLEW-RATE RAIL-TO-RAIL OUTPUT
OPERATIONAL AMPLIFIERS WITH SHUTDOWN

SGLS317A – OCTOBER 2005 – REVISED SEPTEMBER 2007

TYPICAL CHARACTERISTICS

SUPPLY VOLTAGE REJECTION RATIO
vs
FREQUENCY

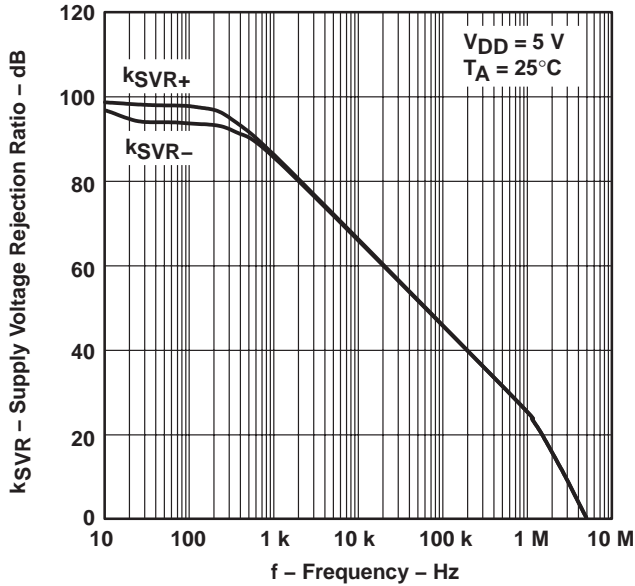

Figure 28

SUPPLY CURRENT (PER CHANNEL)
vs
SUPPLY VOLTAGE

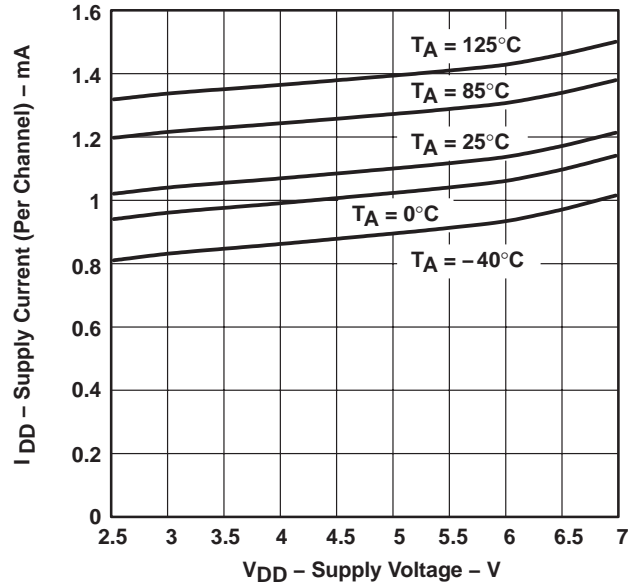

Figure 29

SLEW RATE
vs
LOAD CAPACITANCE

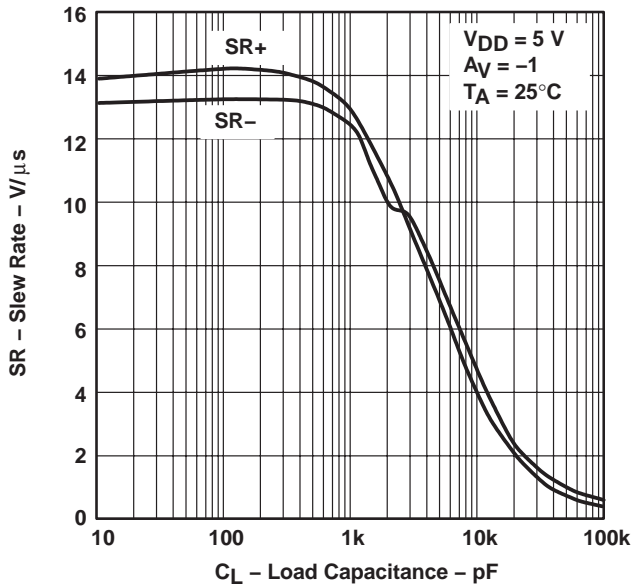

Figure 30

SLEW RATE
vs
FREE-AIR TEMPERATURE

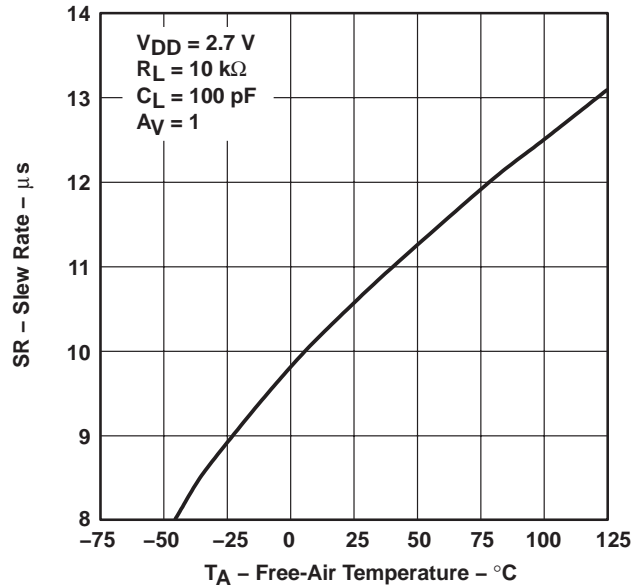

Figure 31



TYPICAL CHARACTERISTICS

**VOLTAGE-FOLLOWER
SMALL-SIGNAL PULSE RESPONSE**

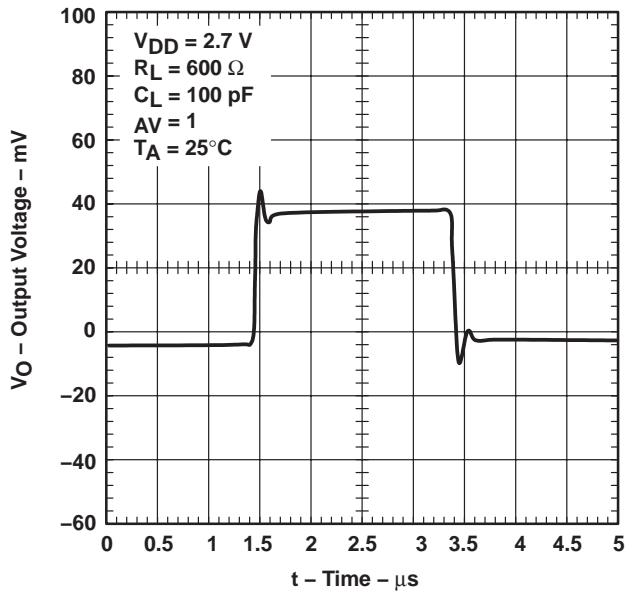

Figure 32

**VOLTAGE-FOLLOWER
SMALL-SIGNAL PULSE RESPONSE**

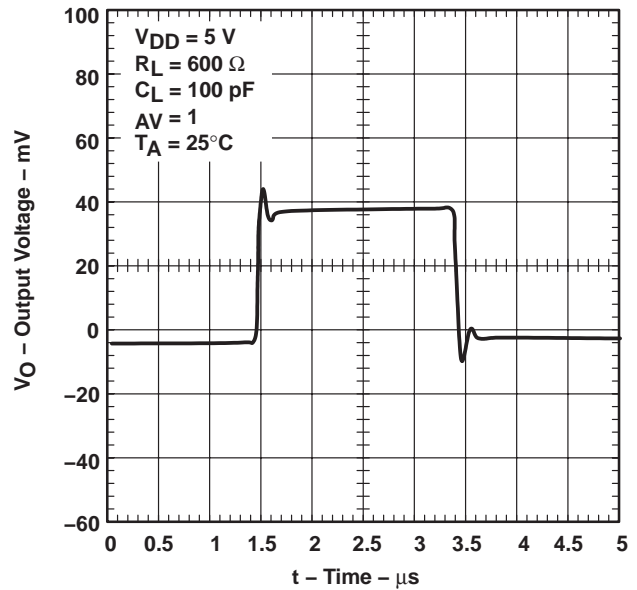

Figure 33

**VOLTAGE-FOLLOWER
LARGE-SIGNAL PULSE RESPONSE**

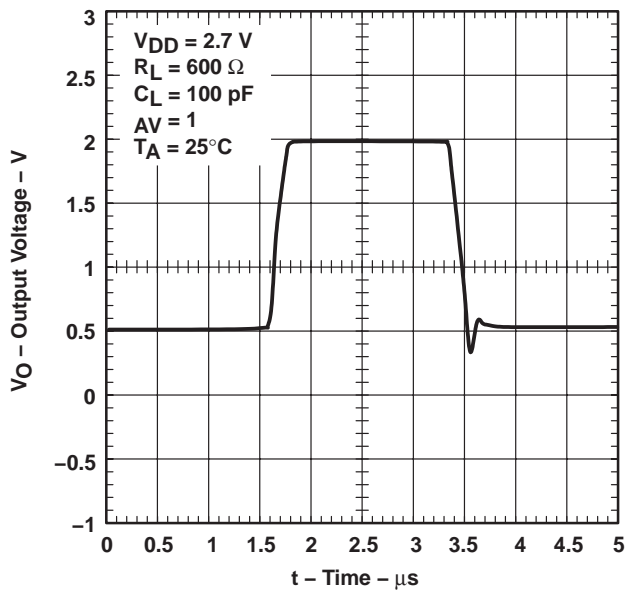

Figure 34

**VOLTAGE-FOLLOWER
LARGE-SIGNAL PULSE RESPONSE**

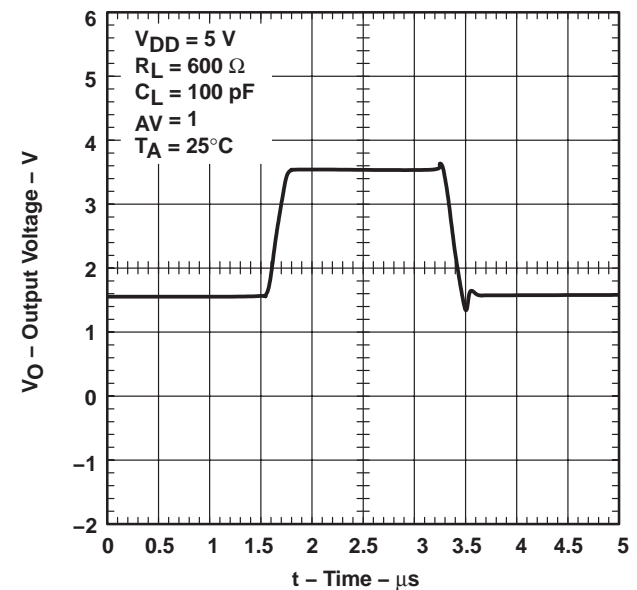

Figure 35

TLV277x-EP, TLV277xA-EP
FAMILY OF 2.7-V HIGH-SLEW-RATE RAIL-TO-RAIL OUTPUT
OPERATIONAL AMPLIFIERS WITH SHUTDOWN

SGLS317A – OCTOBER 2005 – REVISED SEPTEMBER 2007

TYPICAL CHARACTERISTICS

INVERTING SMALL-SIGNAL PULSE RESPONSE



Figure 36

INVERTING SMALL-SIGNAL PULSE RESPONSE



Figure 37

INVERTING LARGE-SIGNAL PULSE RESPONSE



Figure 38

INVERTING LARGE-SIGNAL PULSE RESPONSE

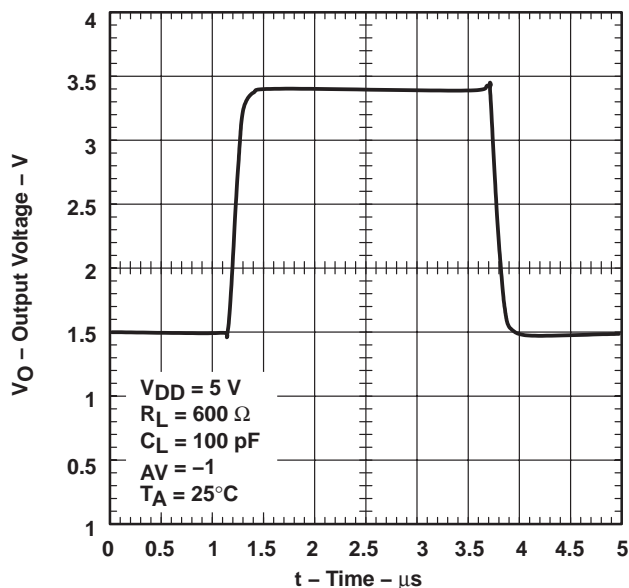

Figure 39



TYPICAL CHARACTERISTICS

EQUIVALENT INPUT NOISE VOLTAGE
 vs
 FREQUENCY

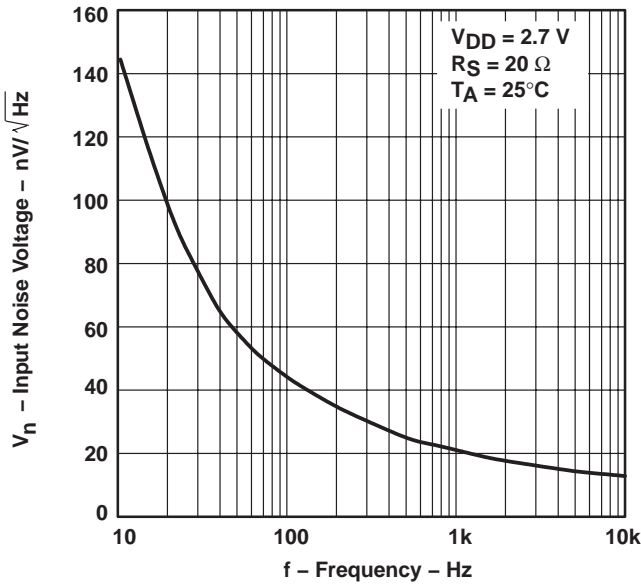

Figure 40

EQUIVALENT INPUT NOISE VOLTAGE
 vs
 FREQUENCY

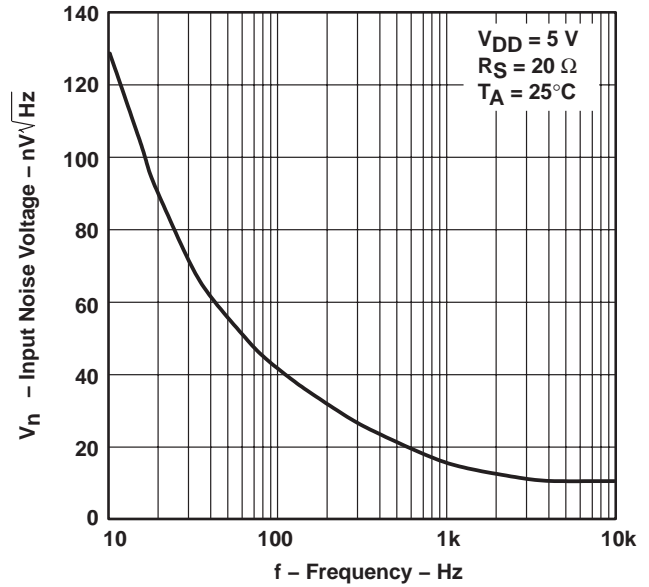

Figure 41

NOISE VOLTAGE
 OVER A 10 SECOND PERIOD

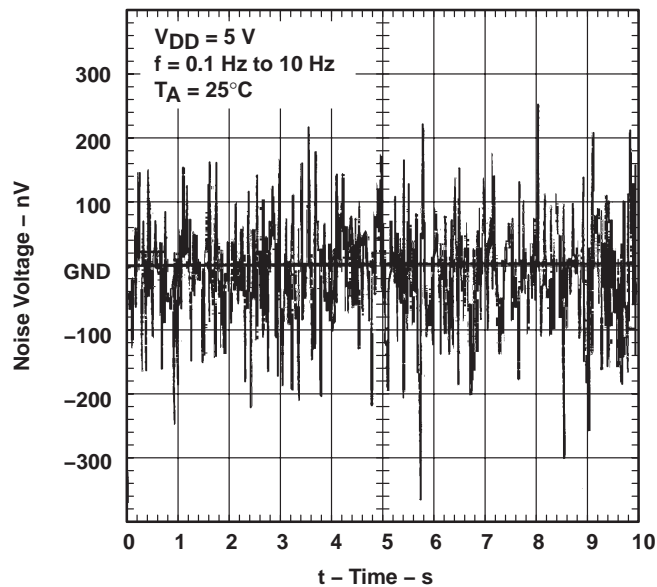

Figure 42

TLV277x-EP, TLV277xA-EP
FAMILY OF 2.7-V HIGH-SLEW-RATE RAIL-TO-RAIL OUTPUT
OPERATIONAL AMPLIFIERS WITH SHUTDOWN

SGLS317A – OCTOBER 2005 – REVISED SEPTEMBER 2007

TYPICAL CHARACTERISTICS

TOTAL HARMONIC DISTORTION PLUS NOISE
vs
FREQUENCY



Figure 43

TOTAL HARMONIC DISTORTION PLUS NOISE
vs
FREQUENCY



Figure 44

GAIN-BANDWIDTH PRODUCT
vs
SUPPLY VOLTAGE

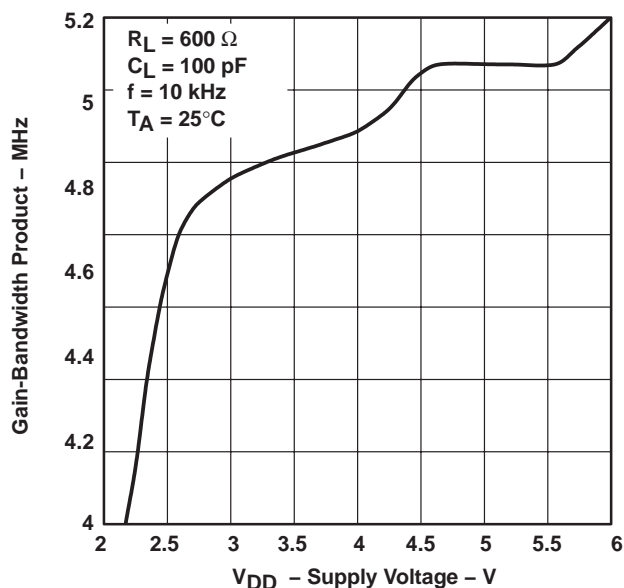

Figure 45

UNITY-GAIN BANDWIDTH
vs
LOAD CAPACITANCE

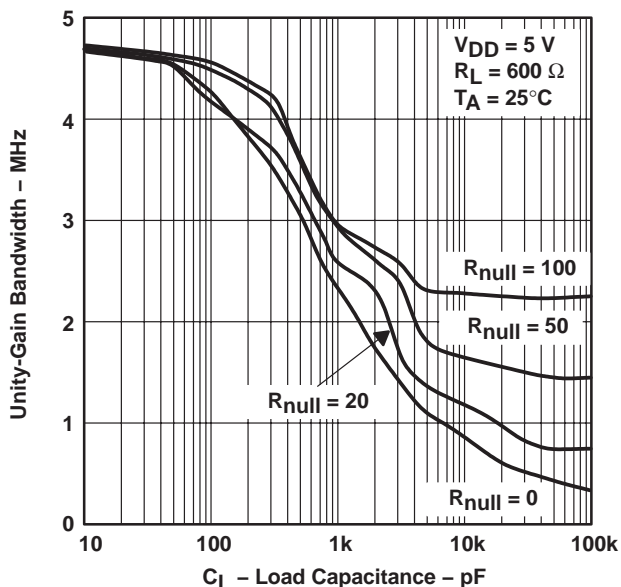

Figure 46

TLV277x-EP, TLV277xA-EP
FAMILY OF 2.7-V HIGH-SLEW-RATE RAIL-TO-RAIL OUTPUT
OPERATIONAL AMPLIFIERS WITH SHUTDOWN

SGLS317A – OCTOBER 2005 – REVISED SEPTEMBER 2007

TYPICAL CHARACTERISTICS

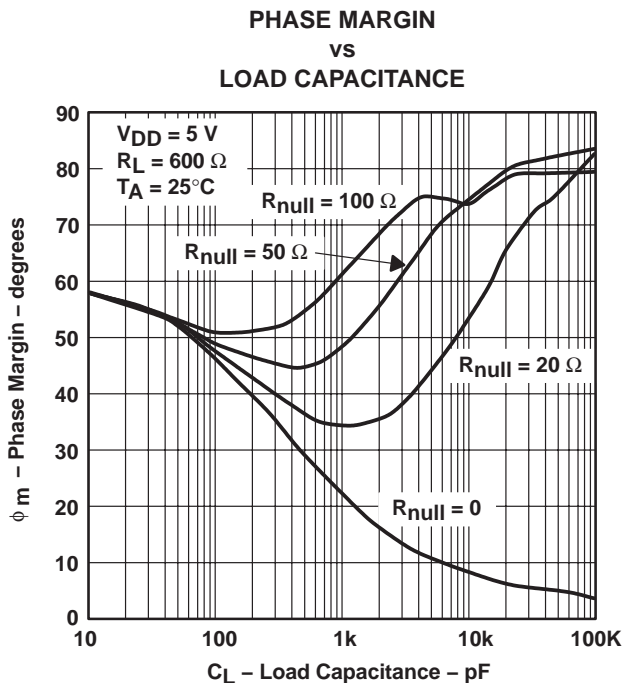

Figure 47



Figure 48



Figure 49



Figure 50

TLV277x-EP, TLV277xA-EP FAMILY OF 2.7-V HIGH-SLEW-RATE RAIL-TO-RAIL OUTPUT OPERATIONAL AMPLIFIERS WITH SHUTDOWN

SGLS317A – OCTOBER 2005 – REVISED SEPTEMBER 2007

TYPICAL CHARACTERISTICS

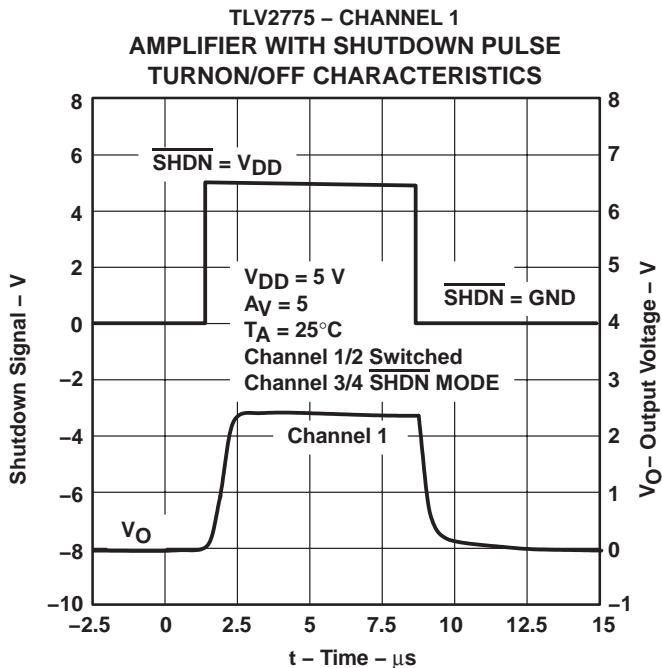

Figure 51

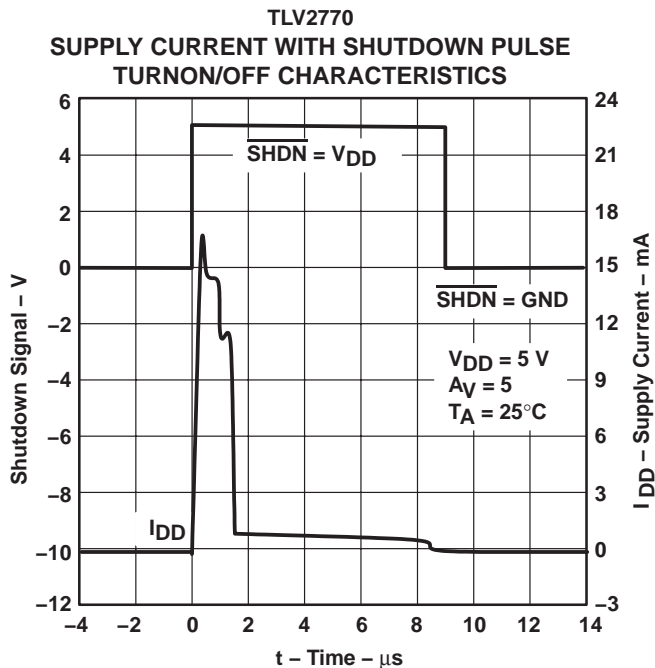

Figure 52

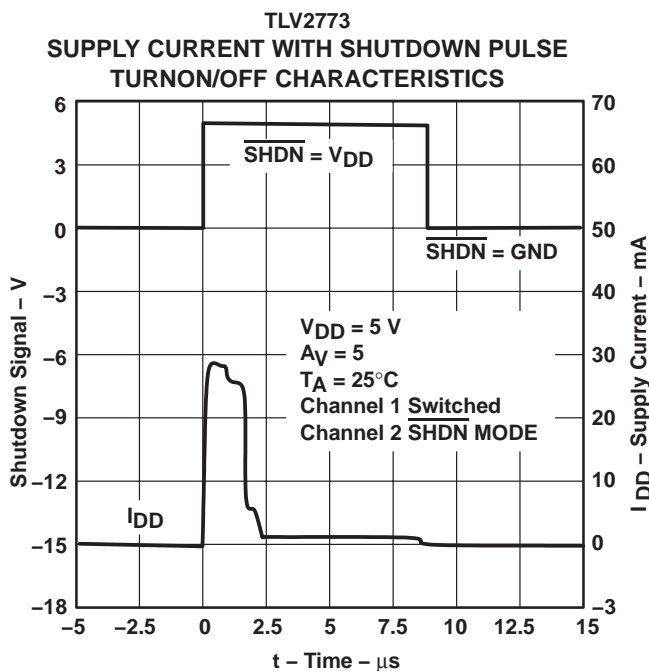

Figure 53

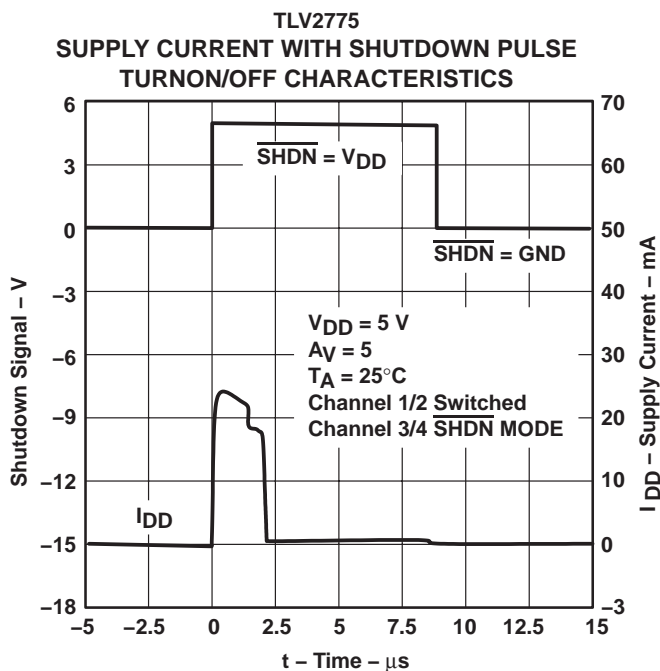

Figure 54

TLV277x-EP, TLV277xA-EP
FAMILY OF 2.7-V HIGH-SLEW-RATE RAIL-TO-RAIL OUTPUT
OPERATIONAL AMPLIFIERS WITH SHUTDOWN

SGLS317A – OCTOBER 2005 – REVISED SEPTEMBER 2007

TYPICAL CHARACTERISTICS

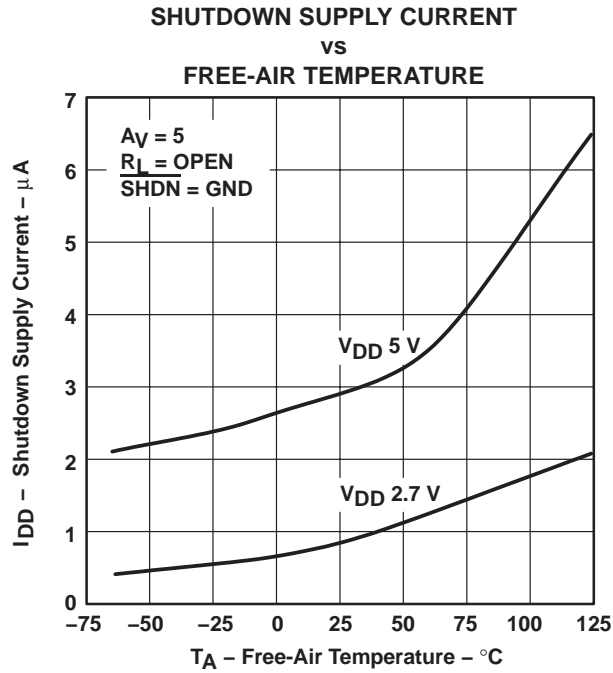

Figure 55

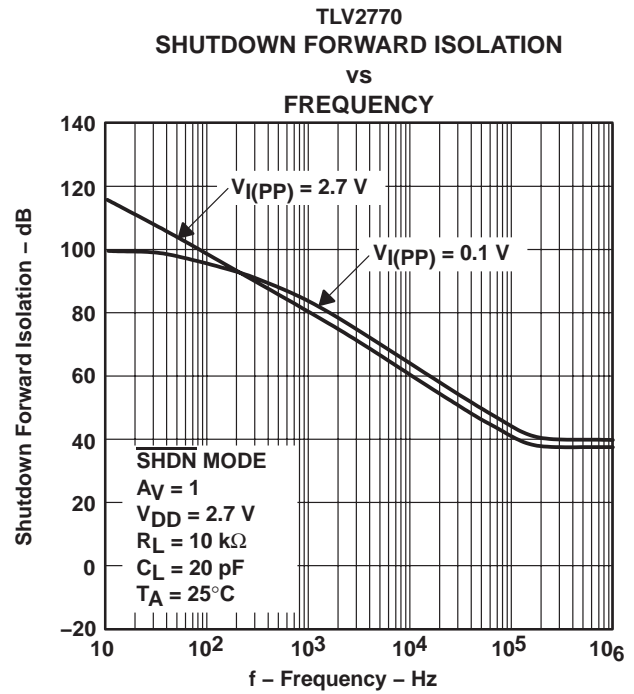

Figure 56

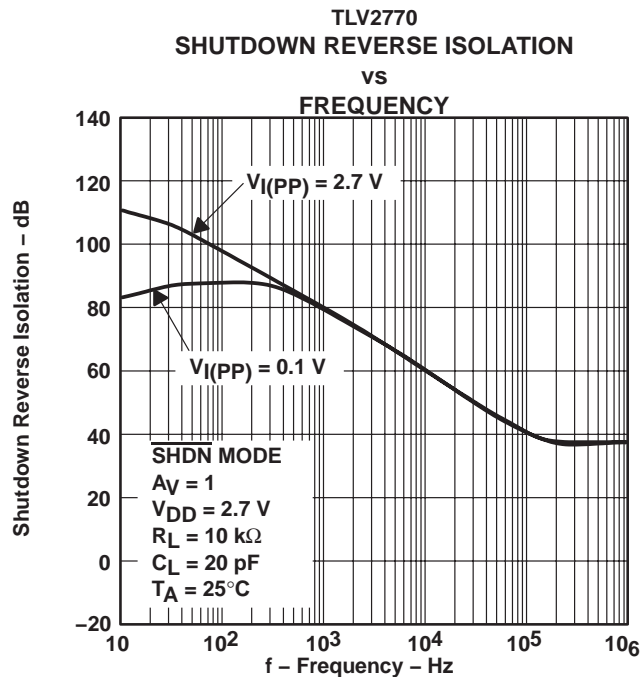

Figure 57

TLV277x-EP, TLV277xA-EP FAMILY OF 2.7-V HIGH-SLEW-RATE RAIL-TO-RAIL OUTPUT OPERATIONAL AMPLIFIERS WITH SHUTDOWN

SGLS317A – OCTOBER 2005 – REVISED SEPTEMBER 2007

PARAMETER MEASUREMENT INFORMATION

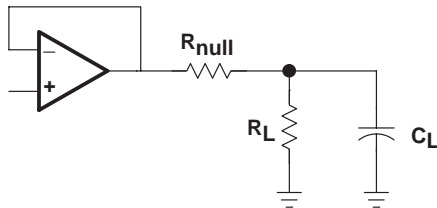

Figure 58

driving a capacitive load

When the amplifier is configured in this manner, capacitive loading directly on the output will decrease the device's phase margin leading to high frequency ringing or oscillations. Therefore, for capacitive loads of greater than 10 pF, it is recommended that a resistor be placed in series (R_{NULL}) with the output of the amplifier (See Figure 59). A minimum value of 20 Ω should work well for most applications.

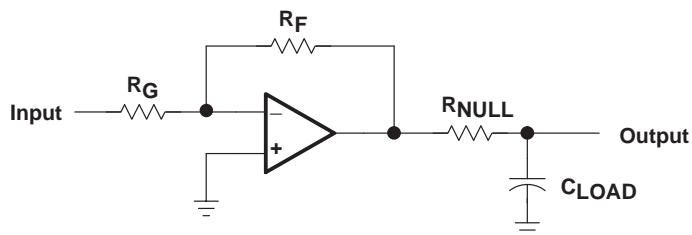

Figure 59. Driving a Capacitive Load

APPLICATION INFORMATION

offset voltage

The output offset voltage, (V_{OO}) is the sum of the input offset voltage (V_{IO}) and both input bias currents (I_{IB}) times the corresponding gains. The following schematic and formula can be used to calculate the output offset voltage:

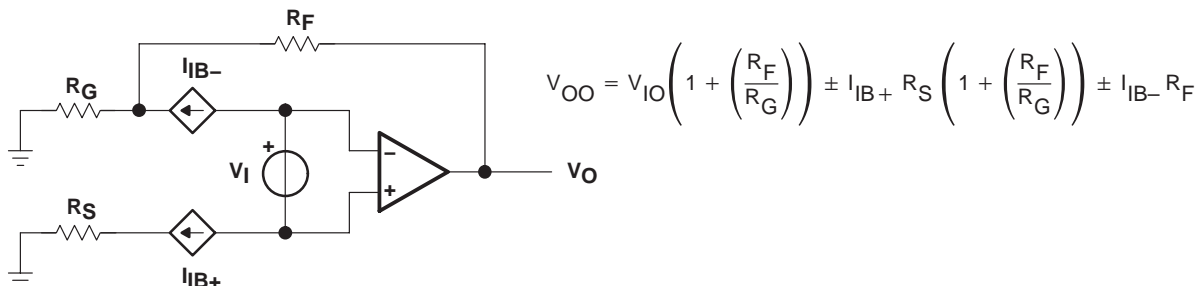

Figure 60. Output Offset Voltage Model

general configurations

When receiving low-level signals, limiting the bandwidth of the incoming signals into the system is often required. The simplest way to accomplish this is to place an RC filter at the noninverting terminal of the amplifier (see Figure 61).

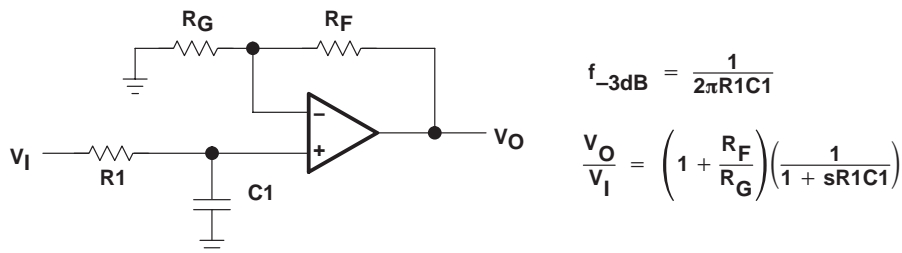

Figure 61. Single-Pole Low-Pass Filter

If even more attenuation is needed, a multiple pole filter is required. The Sallen-Key filter can be used for this task. For best results, the amplifier should have a bandwidth that is eight to ten times the filter frequency bandwidth. Failure to do this can result in phase shift of the amplifier.

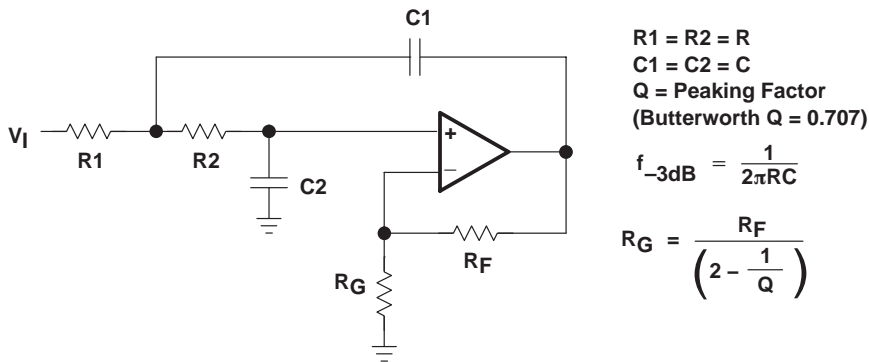

Figure 62. Two Pole Low Pass Sallen Key Filter

TLV277x-EP, TLV277xA-EP FAMILY OF 2.7-V HIGH-SLEW-RATE RAIL-TO-RAIL OUTPUT OPERATIONAL AMPLIFIERS WITH SHUTDOWN

SGLS317A – OCTOBER 2005 – REVISED SEPTEMBER 2007

APPLICATION INFORMATION

using the TLV2772 as an accelerometer interface

The schematic (see Figure 63) shows the ACH04-08-05 interfaced to the TLV1544 10-bit analog-to-digital converter (ADC).

The ACH04-08-05 is a shock sensor designed to convert mechanical acceleration into electrical signals. The sensor contains three piezoelectric sensing elements oriented to simultaneously measure acceleration in three orthogonal, linear axes (x, y, z). The operating frequency is 0.5 Hz to 5 kHz. The output is buffered with an internal JFET and has a typical output voltage of 1.80 mV/g for the x and y axis and 1.35 mV/g for the z axis.

Amplification and frequency shaping of the shock sensor output is done by the TLV2772 rail-to-rail operational amplifier. The TLV2772 is ideal for this application as it offers high input impedance, good slew rate, and excellent dc precision. The rail-to-rail output swing and high output drive are perfect for driving the analog input of the TLV1544 ADC.

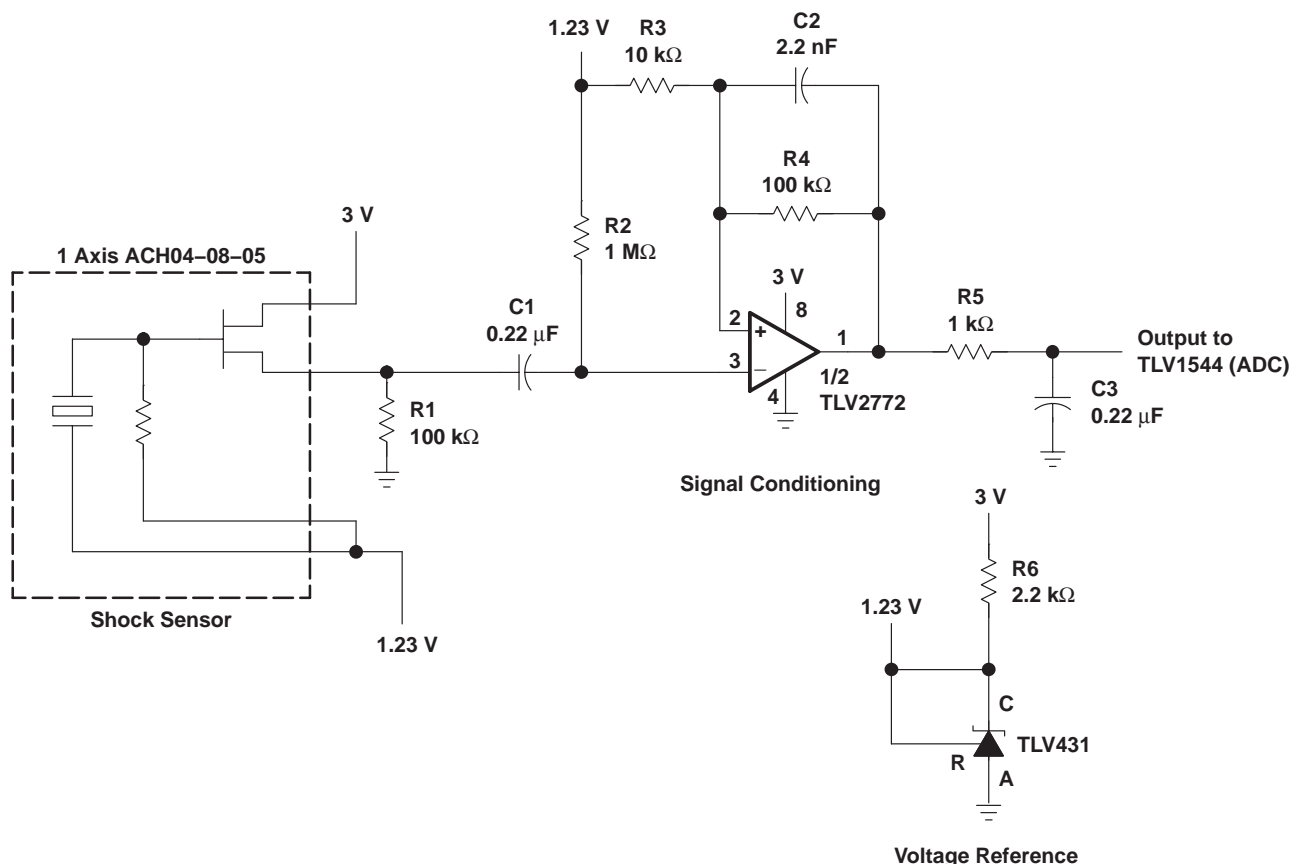

Figure 63. Accelerometer Interface Schematic

The sensor signal must be amplified and frequency-shaped to provide a signal the ADC can properly convert into the digital domain. Figure 63 shows the topology used in this application for one axis of the sensor. This system is powered from a single 3-V supply. Configuring the TLV431 with a 2.2-kΩ resistor produces a reference voltage of 1.23 V. This voltage is used to bias the operational amplifier and the internal JFETs in the shock sensor.

APPLICATION INFORMATION

gain calculation

Since the TLV2772 is capable of rail-to-rail output using a 3-V supply, $V_O = 0$ (min) to 3 V (max). With no signal from the sensor, nominal $V_O =$ reference voltage = 1.23 V. Therefore, the maximum negative swing from nominal is $0\text{ V} - 1.23\text{ V} = -1.23\text{ V}$ and the maximum positive swing is $3\text{ V} - 1.23\text{ V} = 1.77\text{ V}$. By modeling the shock sensor as a low impedance voltage source with output of 2.25 mV/g (max) in the x and y axis and 1.70 mV/g (max) in the z axis, the gain of the circuit is calculated by equation 1.

$$\text{Gain} = \frac{\text{Output Swing}}{\text{Sensor Signal} \times \text{Acceleration}} \quad (1)$$

To avoid saturation of the operational amplifier, the gain calculations are based on the maximum negative swing of -1.23 V and the maximum sensor output of 2.25 mV/g (x and y axis) and 1.70 mV/g (z axis).

$$\text{Gain (x, y)} = \frac{-1.23\text{ V}}{2.25\text{ mV/g} \times -50\text{ g}} = 10.9 \quad (2)$$

and

$$\text{Gain (z)} = \frac{-1.23\text{ V}}{1.70\text{ mV/g} \times -50\text{ g}} = 14.5 \quad (3)$$

By selecting $R_3 = 10\text{ k}\Omega$ and $R_4 = 100\text{ k}\Omega$, in the x and y channels, a gain of 11 is realized. By selecting $R_3 = 7.5\text{ k}\Omega$ and $R_4 = 100\text{ k}\Omega$, in the z channel, a gain of 14.3 is realized. The schematic shows the configuration for either the x or y axis.

bandwidth calculation

To calculate the component values for the frequency shaping characteristics of the signal conditioning circuit, 1 Hz and 500 Hz are selected as the minimum required 3-dB bandwidth.

To minimize the value of the input capacitor (C1) required to set the lower cutoff frequency requires a large value resistor for R2. A 1-M Ω resistor is used in this example. To set the lower cutoff frequency, the required capacitor value for C1 is:

$$C1 = \frac{1}{2\pi f_{\text{LOW}} R_2} = 0.159\text{ }\mu\text{F} \quad (4)$$

Using a value of 0.22 μF , a more common value of capacitor, the lower cutoff frequency is 0.724 Hz.

To minimize the phase shift in the feedback loop caused by the input capacitance of the TLV2772, it is best to minimize the value of the feedback resistor R4. However, to reduce the required capacitance in the feedback loop a large value for R4 is required. Therefore, a compromise for the value of R4 must be made. In this circuit, a value of 100 k Ω has been selected. To set the upper cutoff frequency, the required capacitor value for C2 is:

$$C2 = \frac{1}{2\pi f_{\text{HIGH}} R_4} = 3.18\text{ }\mu\text{F} \quad (5)$$

Using a 2.2-nF capacitor, the upper cutoff frequency is 724 Hz.

R5 and C3 also cause the signal response to roll off. Therefore, it is beneficial to design this roll-off point to begin at the upper cutoff frequency. Assuming a value of 1 k Ω for R5, the value for C3 is calculated to be 0.22 μF .

TLV277x-EP, TLV277xA-EP FAMILY OF 2.7-V HIGH-SLEW-RATE RAIL-TO-RAIL OUTPUT OPERATIONAL AMPLIFIERS WITH SHUTDOWN

SGLS317A – OCTOBER 2005 – REVISED SEPTEMBER 2007

APPLICATION INFORMATION

circuit layout considerations

To achieve the levels of high performance of the TLV277x, follow proper printed-circuit board design techniques. A general set of guidelines is given in the following.

- Ground planes—It is highly recommended that a ground plane be used on the board to provide all components with a low inductive ground connection. However, in the areas of the amplifier inputs and output, the ground plane can be removed to minimize the stray capacitance.
- Proper power supply decoupling—Use a 6.8- μ F tantalum capacitor in parallel with a 0.1- μ F ceramic capacitor on each supply terminal. It may be possible to share the tantalum among several amplifiers depending on the application, but a 0.1- μ F ceramic capacitor should always be used on the supply terminal of every amplifier. In addition, the 0.1- μ F capacitor should be placed as close as possible to the supply terminal. As this distance increases, the inductance in the connecting trace makes the capacitor less effective. The designer should strive for distances of less than 0.1 inches between the device power terminals and the ceramic capacitors.
- Sockets—Sockets can be used but are not recommended. The additional lead inductance in the socket pins will often lead to stability problems. Surface-mount packages soldered directly to the printed-circuit board is the best implementation.
- Short trace runs/compact part placements—Optimum high performance is achieved when stray series inductance has been minimized. To realize this, the circuit layout should be made as compact as possible, thereby minimizing the length of all trace runs. Particular attention should be paid to the inverting input of the amplifier. Its length should be kept as short as possible. This minimizes stray capacitance at the input of the amplifier.
- Surface-mount passive components—Using surface-mount passive components is recommended for high performance amplifier circuits for several reasons. First, because of the extremely low lead inductance of surface-mount components, the problem with stray series inductance is greatly reduced. Second, the small size of surface-mount components naturally leads to a more compact layout thereby minimizing both stray inductance and capacitance. If leaded components are used, it is recommended that the lead lengths be kept as short as possible.

APPLICATION INFORMATION

general power dissipation considerations

For a given θ_{JA} , the maximum power dissipation is shown in Figure 64 and is calculated by the following formula:

$$P_D = \left(\frac{T_{MAX} - T_A}{\theta_{JA}} \right)$$

Where:

- P_D = Maximum power dissipation of TLV277x IC (watts)
- T_{MAX} = Absolute maximum junction temperature (150°C)
- T_A = Free-ambient air temperature (°C)
- $\theta_{JA} = \theta_{JC} + \theta_{CA}$
- θ_{JC} = Thermal coefficient from junction to case
- θ_{CA} = Thermal coefficient from case to ambient air (°C/W)



NOTE A: Results are with no air flow and using JEDEC Standard Low-K test PCB.

Figure 64. Maximum Power Dissipation vs Free-Air Temperature

TLV277x-EP, TLV277xA-EP FAMILY OF 2.7-V HIGH-SLEW-RATE RAIL-TO-RAIL OUTPUT OPERATIONAL AMPLIFIERS WITH SHUTDOWN

SGLS317A – OCTOBER 2005 – REVISED SEPTEMBER 2007

APPLICATION INFORMATION

shutdown function

Three members of the TLV277x family (TLV2770/3/5) have a shutdown terminal for conserving battery life in portable applications. When the shutdown terminal is tied low, the supply current is reduced to $0.8 \mu\text{A}/\text{channel}$, the amplifier is disabled, and the outputs are placed in a high impedance mode. To enable the amplifier, the shutdown terminal can either be left floating or pulled high. When the shutdown terminal is left floating, care must be taken to ensure that parasitic leakage current at the shutdown terminal does not inadvertently place the operational amplifier into shutdown. The shutdown terminal threshold is always referenced to $V_{DD}/2$. Therefore, when operating the device with split supply voltages (e.g. $\pm 2.5 \text{ V}$), the shutdown terminal must be pulled to V_{DD-} (not GND) to disable the operational amplifier.

The amplifier output with a shutdown pulse is shown in Figures 48, 49, and 50. The amplifier is powered with a single 5-V supply and configured as a noninverting configuration with a gain of 5. The amplifier turnon and turnoff times are measured from the 50% point of the shutdown pulse to the 50% point of the output waveform. The times for the single, dual, and quad are listed in the data tables. The bump on the rising edge of the TLV2770 output waveform is due to the start-up circuit on the bias generator. For the dual and quad (TLV2773/5), this bump is attributed to the bias generator's start-up circuit as well as the crosstalk between the other channel(s), which are in shutdown.

Figures 55 and 56 show the amplifier's forward and reverse isolation in shutdown. The operational amplifier is powered by $\pm 1.35\text{-V}$ supplies and configured as a voltage follower ($A_V = 1$). The isolation performance is plotted across frequency for both $0.1 V_{PP}$ and $2.7 V_{PP}$ input signals. During normal operation, the amplifier would not be able to handle a 2.7-V_{PP} input signal with a supply voltage of $\pm 1.35 \text{ V}$ since it exceeds the common-mode input voltage range (V_{ICR}). However, this curve illustrates that the amplifier remains in shutdown even under a worst case scenario.



TLV277x-EP, TLV277xA-EP FAMILY OF 2.7-V HIGH-SLEW-RATE RAIL-TO-RAIL OUTPUT OPERATIONAL AMPLIFIERS WITH SHUTDOWN

SGLS317A – OCTOBER 2005 – REVISED SEPTEMBER 2007

APPLICATION INFORMATION

macromodel information

Macromodel information provided was derived using Microsim *Parts*™ Release 8, the model generation software used with Microsim *PSpice*™. The Boyle macromodel (see Note 5) and subcircuit in Figure 65 are generated using the TLV2772 typical electrical and operating characteristics at $T_A = 25^\circ\text{C}$. Using this information, output simulations of the following key parameters can be generated to a tolerance of 20% (in most cases):

- Maximum positive output voltage swing
- Maximum negative output voltage swing
- Slew rate
- Quiescent power dissipation
- Input bias current
- Open-loop voltage amplification
- Unity-gain frequency
- Common-mode rejection ratio
- Phase margin
- DC output resistance
- AC output resistance
- Short-circuit output current limit

NOTE 5: G. R. Boyle, B. M. Cohn, D. O. Pederson, and J. E. Solomon, "Macromodeling of Integrated Circuit Operational Amplifiers", *IEEE Journal of Solid-State Circuits*, SC-9, 353 (1974).

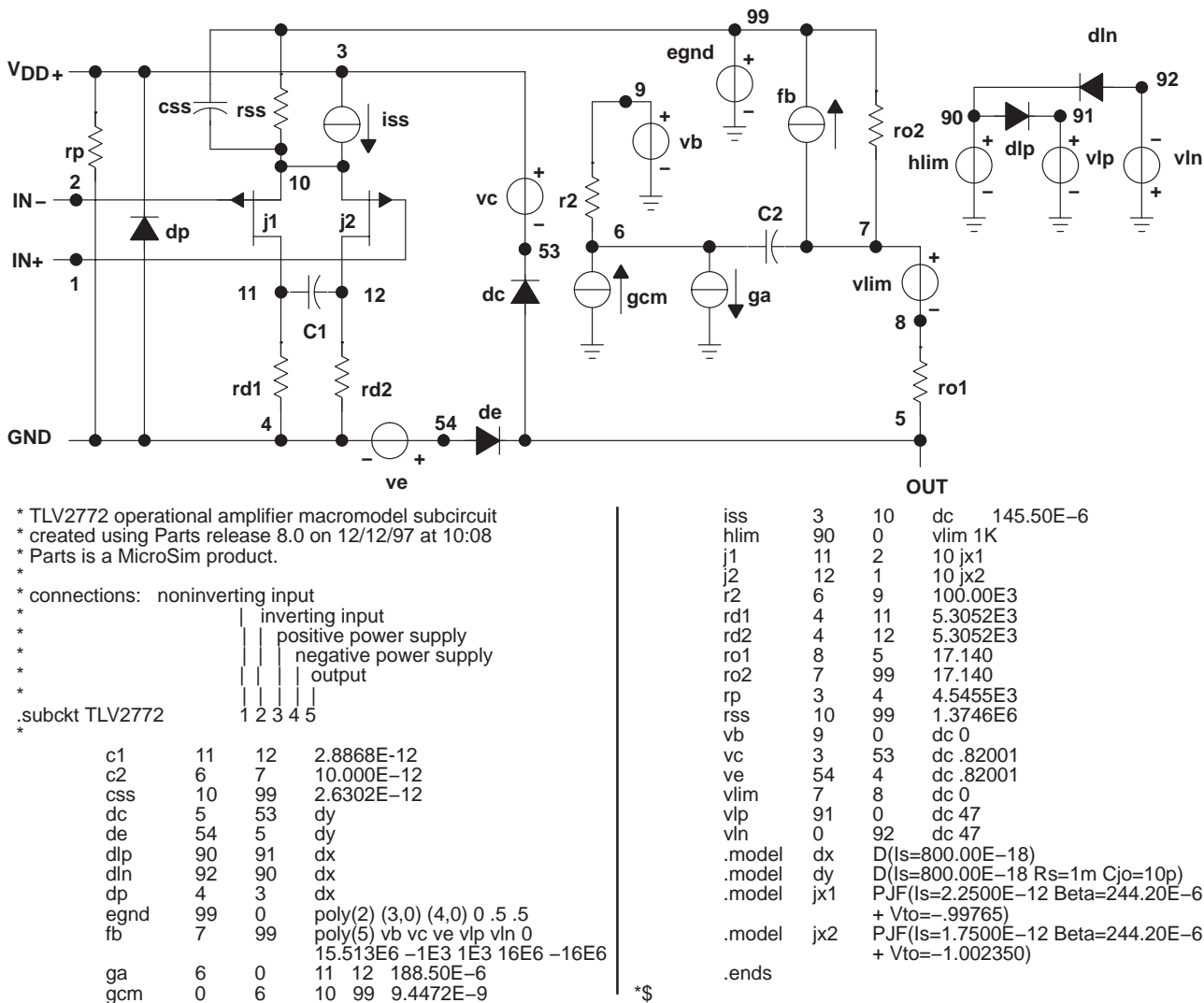

Figure 65. Boyle Macromodel and Subcircuit

PSpice and *Parts* are trademarks of MicroSim Corporation.

PACKAGING INFORMATION

Orderable Device	Status (1)	Package Type	Package Drawing	Pins	Package Qty	Eco Plan (2)	Lead finish/ Ball material (6)	MSL Peak Temp (3)	Op Temp (°C)	Device Marking (4/5)	Samples
TLV2772AMDREP	ACTIVE	SOIC	D	8	2500	RoHS & Green	NIPDAU	Level-1-260C-UNLIM	-55 to 125	2772AE	Samples
TLV2774AMDREP	ACTIVE	SOIC	D	14	2500	RoHS & Green	NIPDAU	Level-1-260C-UNLIM	-55 to 125	2774AEP	Samples
TLV2774AMDREP	ACTIVE	SOIC	D	14	2500	RoHS & Green	NIPDAU	Level-1-260C-UNLIM	-55 to 125	2774EP	Samples
V62/06607-02XE	ACTIVE	SOIC	D	8	2500	RoHS & Green	NIPDAU	Level-1-260C-UNLIM	-55 to 125	2772AE	Samples
V62/06607-03YE	ACTIVE	SOIC	D	14	2500	RoHS & Green	NIPDAU	Level-1-260C-UNLIM	-55 to 125	2774EP	Samples
V62/06607-04YE	ACTIVE	SOIC	D	14	2500	RoHS & Green	NIPDAU	Level-1-260C-UNLIM	-55 to 125	2774AEP	Samples

(1) The marketing status values are defined as follows:

ACTIVE: Product device recommended for new designs.

LIFEBUY: TI has announced that the device will be discontinued, and a lifetime-buy period is in effect.

NRND: Not recommended for new designs. Device is in production to support existing customers, but TI does not recommend using this part in a new design.

PREVIEW: Device has been announced but is not in production. Samples may or may not be available.

OBSOLETE: TI has discontinued the production of the device.

(2) **RoHS:** TI defines "RoHS" to mean semiconductor products that are compliant with the current EU RoHS requirements for all 10 RoHS substances, including the requirement that RoHS substance do not exceed 0.1% by weight in homogeneous materials. Where designed to be soldered at high temperatures, "RoHS" products are suitable for use in specified lead-free processes. TI may reference these types of products as "Pb-Free".

RoHS Exempt: TI defines "RoHS Exempt" to mean products that contain lead but are compliant with EU RoHS pursuant to a specific EU RoHS exemption.

Green: TI defines "Green" to mean the content of Chlorine (Cl) and Bromine (Br) based flame retardants meet JS709B low halogen requirements of <=1000ppm threshold. Antimony trioxide based flame retardants must also meet the <=1000ppm threshold requirement.

(3) MSL, Peak Temp. - The Moisture Sensitivity Level rating according to the JEDEC industry standard classifications, and peak solder temperature.

(4) There may be additional marking, which relates to the logo, the lot trace code information, or the environmental category on the device.

(5) Multiple Device Markings will be inside parentheses. Only one Device Marking contained in parentheses and separated by a "~" will appear on a device. If a line is indented then it is a continuation of the previous line and the two combined represent the entire Device Marking for that device.

(6) Lead finish/Ball material - Orderable Devices may have multiple material finish options. Finish options are separated by a vertical ruled line. Lead finish/Ball material values may wrap to two lines if the finish value exceeds the maximum column width.

Important Information and Disclaimer: The information provided on this page represents TI's knowledge and belief as of the date that it is provided. TI bases its knowledge and belief on information provided by third parties, and makes no representation or warranty as to the accuracy of such information. Efforts are underway to better integrate information from third parties. TI has taken and continues to take reasonable steps to provide representative and accurate information but may not have conducted destructive testing or chemical analysis on incoming materials and chemicals. TI and TI suppliers consider certain information to be proprietary, and thus CAS numbers and other limited information may not be available for release.

In no event shall TI's liability arising out of such information exceed the total purchase price of the TI part(s) at issue in this document sold by TI to Customer on an annual basis.

OTHER QUALIFIED VERSIONS OF TLV2772A-EP, TLV2774-EP, TLV2774A-EP :

- Catalog: [TLV2772A](#), [TLV2774](#), [TLV2774A](#)
- Automotive: [TLV2772A-Q1](#)
- Military: [TLV2772AM](#)

NOTE: Qualified Version Definitions:

- Catalog - TI's standard catalog product
- Automotive - Q100 devices qualified for high-reliability automotive applications targeting zero defects
- Military - QML certified for Military and Defense Applications

TAPE AND REEL INFORMATION

QUADRANT ASSIGNMENTS FOR PIN 1 ORIENTATION IN TAPE

*All dimensions are nominal

Device	Package Type	Package Drawing	Pins	SPQ	Reel Diameter (mm)	Reel Width W1 (mm)	A0 (mm)	B0 (mm)	K0 (mm)	P1 (mm)	W (mm)	Pin1 Quadrant
TLV2772AMDREP	SOIC	D	8	2500	330.0	12.4	6.4	5.2	2.1	8.0	12.0	Q1
TLV2774AMDREP	SOIC	D	14	2500	330.0	16.4	6.5	9.0	2.1	8.0	16.0	Q1
TLV2774MDREP	SOIC	D	14	2500	330.0	16.4	6.5	9.0	2.1	8.0	16.0	Q1

TAPE AND REEL BOX DIMENSIONS

*All dimensions are nominal

Device	Package Type	Package Drawing	Pins	SPQ	Length (mm)	Width (mm)	Height (mm)
TLV2772AMDREP	SOIC	D	8	2500	340.5	338.1	20.6
TLV2774AMDREP	SOIC	D	14	2500	340.5	336.1	32.0
TLV2774AMDREP	SOIC	D	14	2500	353.0	353.0	32.0



D0014A

PACKAGE OUTLINE

SOIC - 1.75 mm max height

SMALL OUTLINE INTEGRATED CIRCUIT



4220718/A 09/2016

NOTES:

1. All linear dimensions are in millimeters. Dimensions in parenthesis are for reference only. Dimensioning and tolerancing per ASME Y14.5M.
2. This drawing is subject to change without notice.
3. This dimension does not include mold flash, protrusions, or gate burrs. Mold flash, protrusions, or gate burrs shall not exceed 0.15 mm, per side.
4. This dimension does not include interlead flash. Interlead flash shall not exceed 0.43 mm, per side.
5. Reference JEDEC registration MS-012, variation AB.

EXAMPLE BOARD LAYOUT

D0014A

SOIC - 1.75 mm max height

SMALL OUTLINE INTEGRATED CIRCUIT



LAND PATTERN EXAMPLE
SCALE:8X

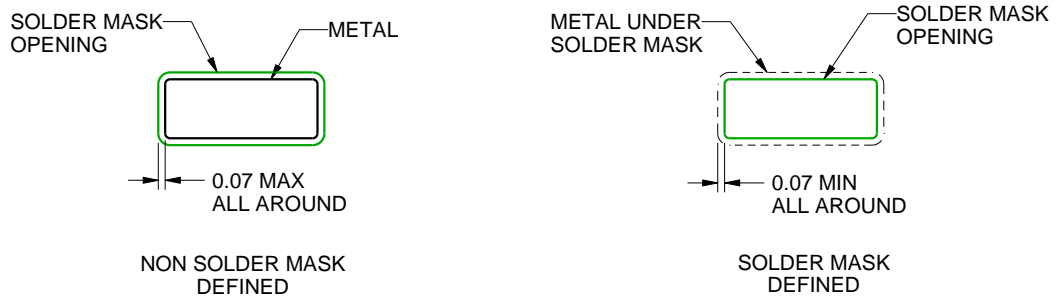

SOLDER MASK DETAILS

4220718/A 09/2016

NOTES: (continued)

- 6. Publication IPC-7351 may have alternate designs.
- 7. Solder mask tolerances between and around signal pads can vary based on board fabrication site.

EXAMPLE STENCIL DESIGN

D0014A

SOIC - 1.75 mm max height

SMALL OUTLINE INTEGRATED CIRCUIT



SOLDER PASTE EXAMPLE
BASED ON 0.125 mm THICK STENCIL
SCALE:8X

4220718/A 09/2016

NOTES: (continued)

8. Laser cutting apertures with trapezoidal walls and rounded corners may offer better paste release. IPC-7525 may have alternate design recommendations.
9. Board assembly site may have different recommendations for stencil design.



D0008A

PACKAGE OUTLINE

SOIC - 1.75 mm max height

SMALL OUTLINE INTEGRATED CIRCUIT



4214825/C 02/2019

NOTES:

1. Linear dimensions are in inches [millimeters]. Dimensions in parenthesis are for reference only. Controlling dimensions are in inches. Dimensioning and tolerancing per ASME Y14.5M.
2. This drawing is subject to change without notice.
3. This dimension does not include mold flash, protrusions, or gate burrs. Mold flash, protrusions, or gate burrs shall not exceed $.006$ [0.15] per side.
4. This dimension does not include interlead flash.
5. Reference JEDEC registration MS-012, variation AA.

EXAMPLE BOARD LAYOUT

D0008A

SOIC - 1.75 mm max height

SMALL OUTLINE INTEGRATED CIRCUIT



LAND PATTERN EXAMPLE
 EXPOSED METAL SHOWN
 SCALE:8X



SOLDER MASK DETAILS

4214825/C 02/2019

NOTES: (continued)

- 6. Publication IPC-7351 may have alternate designs.
- 7. Solder mask tolerances between and around signal pads can vary based on board fabrication site.

EXAMPLE STENCIL DESIGN

D0008A

SOIC - 1.75 mm max height

SMALL OUTLINE INTEGRATED CIRCUIT

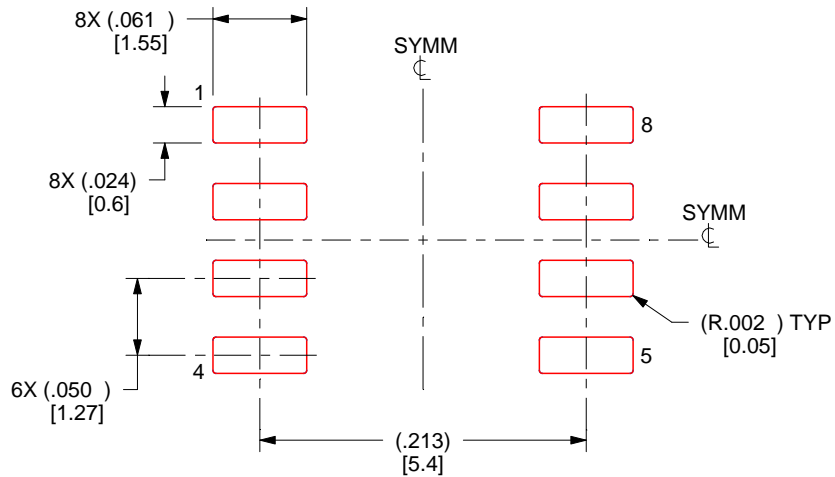

SOLDER PASTE EXAMPLE
BASED ON .005 INCH [0.125 MM] THICK STENCIL
SCALE:8X

4214825/C 02/2019

NOTES: (continued)

8. Laser cutting apertures with trapezoidal walls and rounded corners may offer better paste release. IPC-7525 may have alternate design recommendations.
9. Board assembly site may have different recommendations for stencil design.

IMPORTANT NOTICE AND DISCLAIMER

TI PROVIDES TECHNICAL AND RELIABILITY DATA (INCLUDING DATA SHEETS), DESIGN RESOURCES (INCLUDING REFERENCE DESIGNS), APPLICATION OR OTHER DESIGN ADVICE, WEB TOOLS, SAFETY INFORMATION, AND OTHER RESOURCES "AS IS" AND WITH ALL FAULTS, AND DISCLAIMS ALL WARRANTIES, EXPRESS AND IMPLIED, INCLUDING WITHOUT LIMITATION ANY IMPLIED WARRANTIES OF MERCHANTABILITY, FITNESS FOR A PARTICULAR PURPOSE OR NON-INFRINGEMENT OF THIRD PARTY INTELLECTUAL PROPERTY RIGHTS.

These resources are intended for skilled developers designing with TI products. You are solely responsible for (1) selecting the appropriate TI products for your application, (2) designing, validating and testing your application, and (3) ensuring your application meets applicable standards, and any other safety, security, regulatory or other requirements.

These resources are subject to change without notice. TI grants you permission to use these resources only for development of an application that uses the TI products described in the resource. Other reproduction and display of these resources is prohibited. No license is granted to any other TI intellectual property right or to any third party intellectual property right. TI disclaims responsibility for, and you will fully indemnify TI and its representatives against, any claims, damages, costs, losses, and liabilities arising out of your use of these resources.

TI's products are provided subject to [TI's Terms of Sale](#) or other applicable terms available either on [ti.com](https://www.ti.com) or provided in conjunction with such TI products. TI's provision of these resources does not expand or otherwise alter TI's applicable warranties or warranty disclaimers for TI products.

TI objects to and rejects any additional or different terms you may have proposed.

Mailing Address: Texas Instruments, Post Office Box 655303, Dallas, Texas 75265
Copyright © 2024, Texas Instruments Incorporated