

TPS206xA Two Channel, Current-Limited, Power-Distribution Switches

1 Features

- 70mΩ High-Side MOSFET
- 1A Continuous Current
- Thermal and Short-Circuit Protection
- Accurate Current-Limit (1.2A min, 2A max)
- Operating Range: 2.7V to 5.5V
- 0.6ms Typical Rise Time
- Undervoltage Lockout
- Deglitched Fault Report (\overline{OCx})
- No \overline{OCx} Glitch During Power Up
- 1μA Maximum Standby Supply Current
- Bidirectional Switch
- Ambient Temperature Range: -40°C to 85°C
- Built-in Soft-Start
- UL Listed -- File No. E169910, Both Single and Ganged Channel Configuration

- Short-Circuit Protection

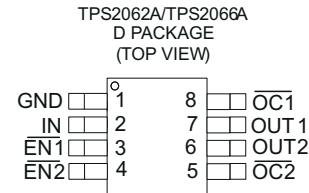

TPS2062A/TPS2066A
DRB PACKAGE
(TOP VIEW)

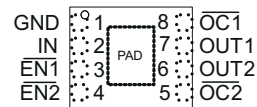

Enable inputs are active low for all TPS2062A and active high for all TPS2066A

2 Applications

- Heavy Capacitive Loads

3 Description

The TPS206xA power-distribution switches are intended for applications where heavy capacitive loads and short-circuits are likely to be encountered. The TPS206xA family is pin-for-pin compatible with the TPS206x family with a tighter overcurrent tolerance. This family of devices incorporates two 70mΩ N-channel MOSFET power switches for power-distribution systems that require multiple power switches in a single package. Each switch is controlled by a logic enable input. Gate drive is provided by an internal charge pump designed to control the power-switch rise and fall times to minimize current surges during switching. The charge pump requires no external components and allows operation from supplies as low as 2.7V.

Each device limits the output current to a safe level by switching into a constant-current mode when the output load exceeds the current-limit threshold or a short is present. Individual channels indicate the presence of an overcurrent condition by asserting its corresponding \overline{OCx} output (active low). Thermal protection circuitry disables the device during overcurrent or short-circuit events to prevent permanent damage. The device recovers from thermal shutdown automatically once the device has cooled sufficiently. The device provides undervoltage lockout to disable the device until the input voltage rises above 2.0V. The TPS206xA is designed to current limit at 1.6A typically per channel.

| GENERAL SWITCH CATALOG | | | | | | |
|--|---|---|--|--|---|--|
| 33 mΩ, single | 80 mΩ, single | 80 mΩ, dual | 80 mΩ, dual | 80 mΩ, triple | 80 mΩ, quad | 80 mΩ, quad |
| TPS201xA 0.2 A - 2 A TPS202x 0.2 A - 2 A TPS203x 0.2 A - 2 A | TPS2014 600 mA TPS2015 1 A TPS2041B 500 mA TPS2051B 500 mA TPS2045A 250 mA TPS2049 100 mA TPS2055A 250 mA TPS2061 1 A TPS2065 1 A TPS2068 1.5 A TPS2069 1.5 A | TPS2042B 500 mA TPS2052B 500 mA TPS2046B 250 mA TPS2056 250 mA TPS2062 1 A TPS2066 1 A TPS2060 1.5 A TPS2064 1.5 A | TPS2080 500 mA TPS2081 500 mA TPS2082 500 mA TPS2090 250 mA TPS2091 250 mA TPS2092 250 mA | TPS2043B 500 mA TPS2053B 500 mA TPS2047B 250 mA TPS2057A 250 mA TPS2063 1 A TPS2067 1 A | TPS2044B 500 mA TPS2054B 500 mA TPS2048A 250 mA TPS2058 250 mA | TPS2085 500 mA TPS2086 500 mA TPS2087 500 mA TPS2095 250 mA TPS2096 250 mA TPS2097 250 mA |



Table of Contents

| | | | |
|--|-----------|---|-----------|
| 1 Features | 1 | 8 Application Information | 15 |
| 2 Applications | 1 | 8.1 Power-Supply Considerations..... | 15 |
| 3 Description | 1 | 8.2 Input and Output Capacitance..... | 15 |
| 4 Pin Configuration and Functions | 3 | 8.3 Power Dissipation and Junction Temperature..... | 15 |
| 5 Specifications | 4 | 8.4 Universal Serial Bus (USB) Applications..... | 16 |
| 5.1 Absolute Maximum Ratings..... | 4 | 8.5 Self-powered and Bus-Powered Hubs..... | 16 |
| 5.2 Recommended Operating Conditions..... | 4 | 8.6 Low-Power Bus-Powered And High-Power Bus- Powered Functions..... | 17 |
| 5.3 Thermal Information..... | 4 | 8.7 USB Power-Distribution Requirements..... | 17 |
| 5.4 Electrical Characteristics..... | 4 | 9 Device and Documentation Support | 18 |
| 5.5 Typical Characteristics..... | 6 | 9.1 Receiving Notification of Documentation Updates.... | 18 |
| 6 Parameter Measurement Information | 9 | 9.2 Support Resources..... | 18 |
| 7 Detailed Description | 12 | 9.3 Trademarks..... | 18 |
| 7.1 Overview..... | 12 | 9.4 Electrostatic Discharge Caution..... | 18 |
| 7.2 Functional Block Diagram..... | 12 | 9.5 Glossary..... | 18 |
| 7.3 Overcurrent..... | 13 | 10 Revision History | 18 |
| 7.4 \overline{OCx} Response..... | 14 | 11 Mechanical, Packaging, and Orderable Information | 18 |
| 7.5 Undervoltage Lockout (UVLO)..... | 14 | | |
| 7.6 Enable (\overline{ENx} or ENx)..... | 14 | | |
| 7.7 Thermal Sense..... | 14 | | |

4 Pin Configuration and Functions

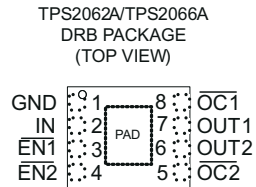
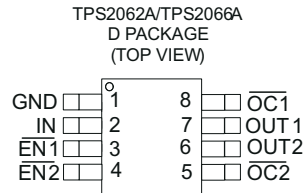

Enable inputs are active low for all TPS2062A
and active high for all TPS2066A

Table 4-1. Terminal Functions

| TERMINAL | | | I/O | DESCRIPTION |
|---------------|----------|----------|-----|---|
| NAME | TPS2062A | TPS2066A | | |
| EN1 | 3 | — | I | Enable input, logic low turns on power switch IN-OUT1 |
| EN2 | 4 | — | I | Enable input, logic low turns on power switch IN-OUT2 |
| EN1 | — | 3 | I | Enable input, logic high turns on power switch IN-OUT1 |
| EN2 | — | 4 | I | Enable input, logic high turns on power switch IN-OUT2 |
| GND | 1 | 1 | | Ground |
| IN | 2 | 2 | I | Input voltage |
| OC1 | 8 | 8 | O | Channel 1 over-current indicator; the output is open-drain, active low type |
| OC2 | 5 | 5 | O | Channel 2 over-current indicator; the output is open-drain, active low type |
| OUT1 | 7 | 7 | O | Power-switch output, IN-OUT1 |
| OUT2 | 6 | 6 | O | Power-switch output, IN-OUT2 |
| PowerPAD™ (1) | PAD | PAD | | Connect PowerPAD to GND for proper operation (DRB package only) |

(1) The PowePad must be connected externally to GND pin to meet qualifying conditions for CB Certificate (DRB package only)

5 Specifications

5.1 Absolute Maximum Ratings

over operating temperature range unless otherwise noted^{(1) (2)}

| | | | VALUE | UNIT |
|------------------|--------------------------------------|-------------------------------|--------------------|------|
| V _I | Input voltage range | IN | -0.3 to 6 | V |
| V _O | Output voltage range | OUTx | -0.3 to 6 | V |
| V _I | Input voltage range | ENx, ENx | -0.3 to 6 | V |
| | Voltage range | OCx | -0.3 to 6 | V |
| I _O | Continuous output current | OUTx | Internally limited | |
| T _J | Operating junction temperature range | | -40 to 125 | °C |
| T _{stg} | Storage temperature range | | -65 to 150 | °C |
| ESD | Electrostatic discharge protection | Human body model MIL-STD-883C | 2 | kV |
| | | Charge device model (CDM) | 500 | V |

- (1) Stresses beyond those listed under *absolute maximum ratings* may cause permanent damage to the device. These are stress ratings only, and functional operation of the device at these or any other conditions beyond those indicated under *recommended operating conditions* is not implied. Exposure to absolute-maximum-rated conditions for extended periods may affect device reliability.
- (2) All voltages are with respect to GND.

5.2 Recommended Operating Conditions

| | | MIN | MAX | UNIT |
|----------------|--|-----|-----|------|
| V _I | Input voltage, IN | 2.7 | 5.5 | V |
| | Input voltage, ENx, ENx | 0 | 5.5 | V |
| I _O | Continuous output current, OUTx | 0 | 1 | A |
| T _J | Operating virtual junction temperature | -40 | 125 | °C |

5.3 Thermal Information

| THERMAL METRIC ⁽¹⁾ | D (SOIC) | DRB (SON) | UNIT |
|--|----------|-----------|-------|
| | 8 PINS | 8 PINS | |
| R _{θJA} Junction-to-ambient thermal resistance | 119.3 | 47.5 | °C/W° |
| R _{θJC(top)} Junction-to-case (top) thermal resistance | 67.6 | 53 | |
| R _{θJB} Junction-to-board thermal resistance | 59.6 | 14.2 | |
| ψ _{JT} Junction-to-top characterization parameter | 20.3 | 1.2 | |
| ψ _{JB} Junction-to-board characterization parameter | 59.1 | 14.2 | |
| R _{θJC(bot)} Junction-to-case (bottom) thermal resistance | N/A | 7.3 | |

- (1) For more information about traditional and new thermal metrics, see the [Semiconductor and IC Package Thermal Metrics](#) application report.

5.4 Electrical Characteristics

over recommended operating junction temperature range, V_I = 5.5 V, I_O = 1 A, V_{ENx} = 0 V (TPS2062A) or V_{ENx} = 5.5 V (unless otherwise noted)

| PARAMETER | TEST CONDITIONS ⁽¹⁾ | MIN | TYP | MAX | UNIT | |
|---------------------|---|--|--------------------------------|-----|------|----|
| POWER SWITCH | | | | | | |
| r _{DS(on)} | Static drain-source on-state resistance | 2.7 V ≤ V _I ≤ 5.5 V, I _O = 1 A | T _J = 25°C | 70 | 100 | mΩ |
| | | | -40°C ≤ T _J ≤ 125°C | | 135 | |

5.4 Electrical Characteristics (continued)

over recommended operating junction temperature range, $V_I = 5.5\text{ V}$, $I_O = 1\text{ A}$, $V_{ENx} = 0\text{ V}$ (TPS2062A) or $V_{ENx} = 5.5\text{ V}$ (unless otherwise noted)

| PARAMETER | | TEST CONDITIONS ⁽¹⁾ | | MIN | TYP | MAX | UNIT |
|---|--|---|--|-------------|-----|---------------|------------------|
| t_r | Rise time, output | $V_I = 5.5\text{ V}$ | $C_L = 1\text{ }\mu\text{F}$, $R_L = 5\text{ }\Omega$, $T_J = 25^\circ\text{C}$ | 0.6 | 1.5 | ms | |
| | | $V_I = 2.7\text{ V}$ | | 0.4 | 1 | | |
| t_f | Fall time, output | $V_I = 5.5\text{ V}$ | | 0.05 | 0.5 | | |
| | | $V_I = 2.7\text{ V}$ | | 0.05 | 0.5 | | |
| ENABLE INPUT \overline{EN} OR EN | | | | | | | |
| V_{IH} | High-level input voltage | $2.7\text{ V} \leq V_I \leq 5.5\text{ V}$ | | 2 | | | V |
| V_{IL} | Low-level input voltage | | | | 0.8 | | |
| I_I | Input current | | | -0.5 | 0.5 | | μA |
| t_{on} | Turnon time | $C_L = 100\text{ }\mu\text{F}$, $R_L = 5\text{ }\Omega$ | | | 3 | ms | |
| t_{off} | Turnoff time | | | | 3 | | |
| CURRENT LIMIT | | | | | | | |
| I_{OS} | Short-circuit output current per channel | $V_I = 5\text{ V}$, OUTx connected to GND, device enabled into short-circuit | $T_J = 25^\circ\text{C}$ $-40^\circ\text{C} \leq T_J \leq 125^\circ\text{C}$ | 1.2 | 1.6 | 2.0 | A |
| | | | | 1.1 | 1.6 | 2.1 | |
| $I_{OC}^{(2)}$ | Overcurrent trip threshold | $V_{IN} = 5\text{ V}$ | TPS2062ADRB, TPS2066AD, TPS2066ADRB | I_{OS} | 2.1 | 2.45 | A |
| I_{OS_G} | Ganged short-circuit output current | $V_I = 5\text{ V}$, OUT1 & OUT2 connected to GND, device enabled into short-circuit | $T_J = 25^\circ\text{C}$ $-40^\circ\text{C} \leq T_J \leq 125^\circ\text{C}$ | 2.4 | 3.2 | 4.0 | A |
| | | | | 2.2 | 3.2 | 4.2 | |
| $I_{OC_G}^{(2)}$ | Ganged overcurrent trip threshold | $V_I = 5\text{ V}$, OUT1 & OUT2 tied together | TPS2062ADRB, TPS2066AD, TPS2066ADRB | I_{OS_G} | 4.2 | 4.9 | |
| SUPPLY CURRENT (All devices excluding TPS2062AD) | | | | | | | |
| I_{IL} | Supply current, device disabled | No load on OUT | $T_J = 25^\circ\text{C}$ $-40^\circ\text{C} \leq T_J \leq 125^\circ\text{C}$ | 0.5 | 1 | μA | |
| | | | | 0.5 | 5 | | |
| I_{IH} | Supply current, device enabled | No load on OUT | $T_J = 25^\circ\text{C}$ $-40^\circ\text{C} \leq T_J \leq 125^\circ\text{C}$ | 50 | 60 | μA | |
| | | | | 50 | 75 | | |
| I_{ikg} | Leakage current, device disabled | OUT connected to ground | $-40^\circ\text{C} \leq T_J \leq 125^\circ\text{C}$ | 1 | | μA | |
| | Reverse leakage current | $V_O = 5.5\text{ V}$, $V_I = 0\text{ V}$ | $T_J = 25^\circ\text{C}$ | 0.2 | | μA | |
| SUPPLY CURRENT (TPS2062AD) | | | | | | | |
| I_{IL} | Supply current, device disabled | No load on OUT | $T_J = 25^\circ\text{C}$ $-40^\circ\text{C} \leq T_J \leq 125^\circ\text{C}$ | 0.5 | 1 | μA | |
| | | | | 0.5 | 5 | | |
| I_{IH} | Supply current, device enabled | No load on OUT | $T_J = 25^\circ\text{C}$ $-40^\circ\text{C} \leq T_J \leq 125^\circ\text{C}$ | 95 | 120 | μA | |
| | | | | 95 | 120 | | |
| I_{ikg} | Leakage current, device disabled | OUT connected to ground | $-40^\circ\text{C} \leq T_J \leq 125^\circ\text{C}$ | 1 | | μA | |
| | Reverse leakage current | $V_O = 5.5\text{ V}$, $V_I = 0\text{ V}$ | $T_J = 25^\circ\text{C}$ | 0.2 | | μA | |
| UNDERVOLTAGE LOCKOUT (All devices excluding TPS2062AD) | | | | | | | |
| | Low-level input voltage, IN | V_I rising | | 2 | 2.5 | | V |
| | Hysteresis, IN | V_I falling | | 75 | | | mV |
| UNDERVOLTAGE LOCKOUT (TPS2062AD) | | | | | | | |
| | Low-level input voltage, IN | V_I rising | | 2 | 2.6 | | V |
| | Hysteresis, IN | V_I falling | | 75 | | | mV |
| OVERCURRENT FLAG | | | | | | | |
| V_{OL} | Output low voltage, \overline{OC} | $I_{IOCx} = 5\text{ mA}$ | | | 0.4 | | V |
| | Off-state current | $V_{IOCx} = 5.0\text{ V}$ or 3.3 V | | | 1 | | μA |
| | \overline{OC} deglitch | \overline{OCx} assertion or de-assertion | | 4 | 8 | 15 | ms |
| THERMAL SHUTDOWN⁽³⁾ | | | | | | | |
| | Thermal shutdown threshold | | | 135 | | | $^\circ\text{C}$ |
| | Recovery from thermal shutdown | | | 125 | | | $^\circ\text{C}$ |

5.4 Electrical Characteristics (continued)

over recommended operating junction temperature range, $V_I = 5.5\text{ V}$, $I_O = 1\text{ A}$, $V_{ENx} = 0\text{ V}$ (TPS2062A) or $V_{ENx} = 5.5\text{ V}$ (unless otherwise noted)

| PARAMETER | TEST CONDITIONS ⁽¹⁾ | MIN | TYP | MAX | UNIT |
|------------|--------------------------------|-----|-----|-----|------|
| Hysteresis | | | 10 | | °C |

- (1) Pulsed load testing used to maintain junction temperature close to ambient
- (2) TPS2062AD does not have an overcurrent trip threshold. The current limit is defined by I_{OS} . See Section 7.3 for more details.
- (3) The thermal shutdown only reacts under overcurrent conditions.

5.5 Typical Characteristics

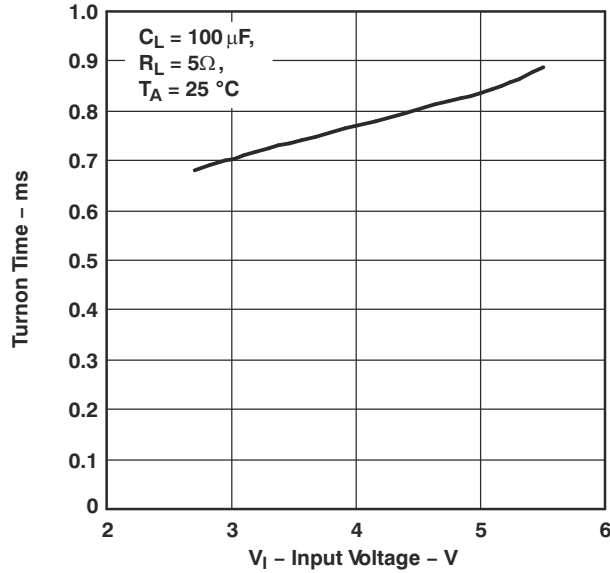

Figure 5-1. Turnon Time vs Input Voltage

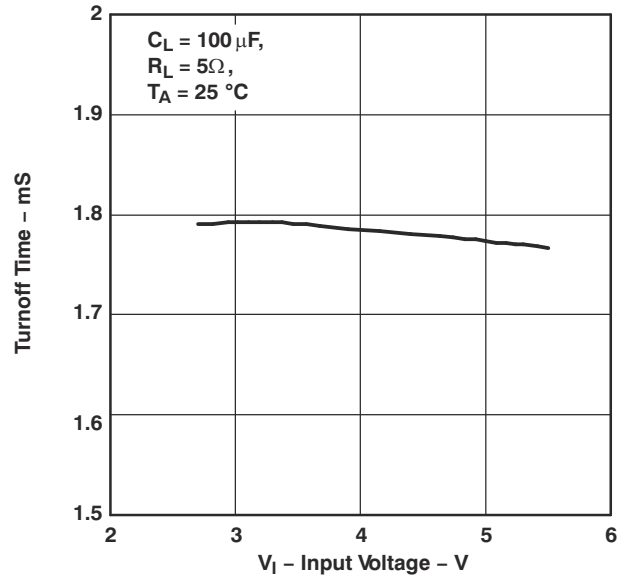

Figure 5-2. Turnoff Time vs Input Voltage

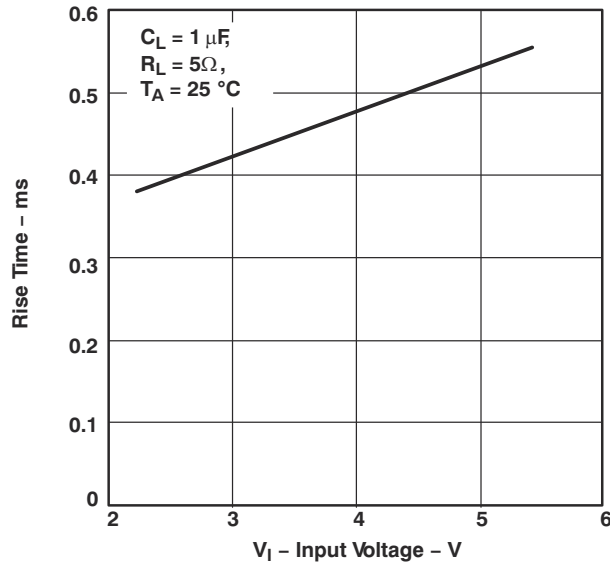

Figure 5-3. Rise Time vs Input Voltage

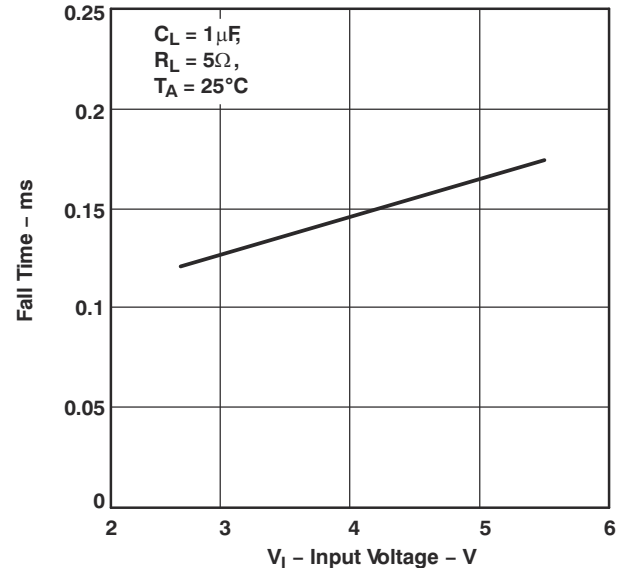

Figure 5-4. Fall Time vs Input Voltage

5.5 Typical Characteristics (continued)

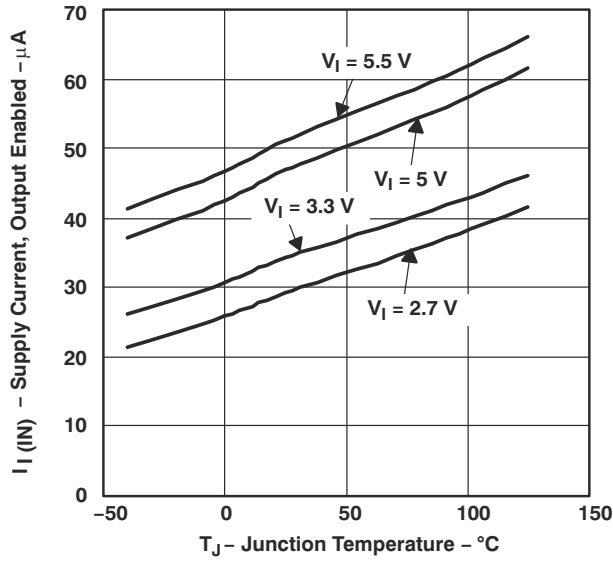

Figure 5-5. TPS2062A, TPS2066A Supply Current, Output Enabled vs Junction Temperature

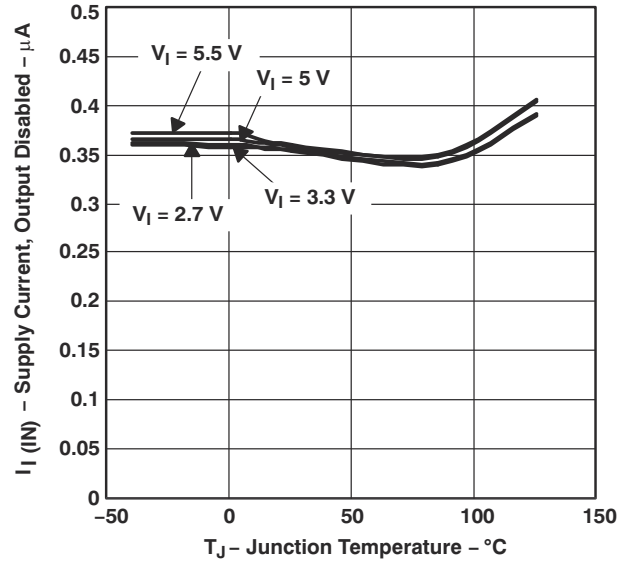

Figure 5-6. TPS2062A, TPS2066A Supply Current, Output Disabled vs Junction Temperature

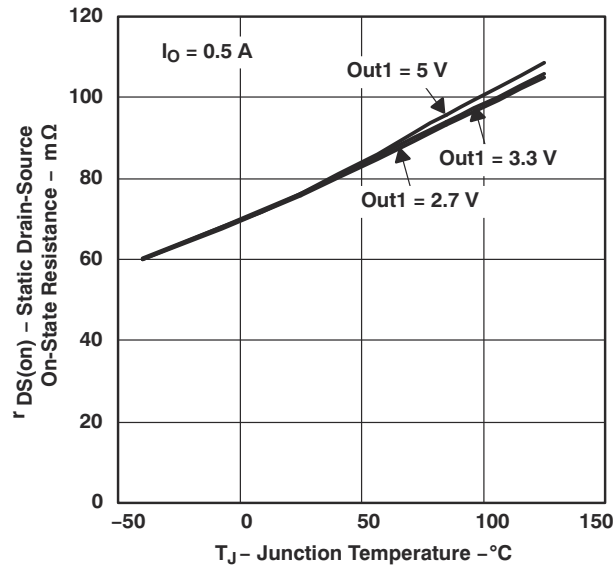

Figure 5-7. Static Drain-Source On-State Resistance vs Junction Temperature

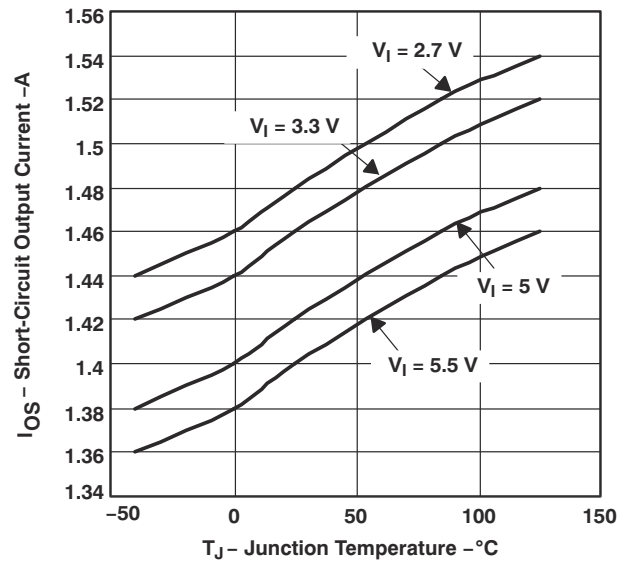

Figure 5-8. Short-Circuit Output Current vs Junction Temperature

5.5 Typical Characteristics (continued)

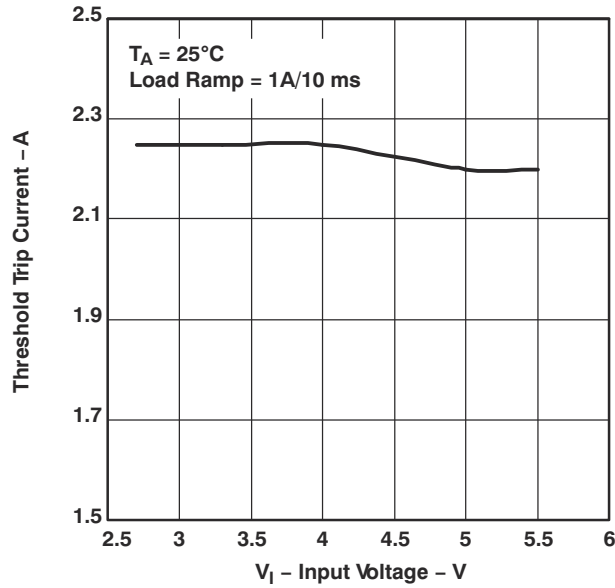

Figure 5-9. Threshold Trip Current vs Input Voltage

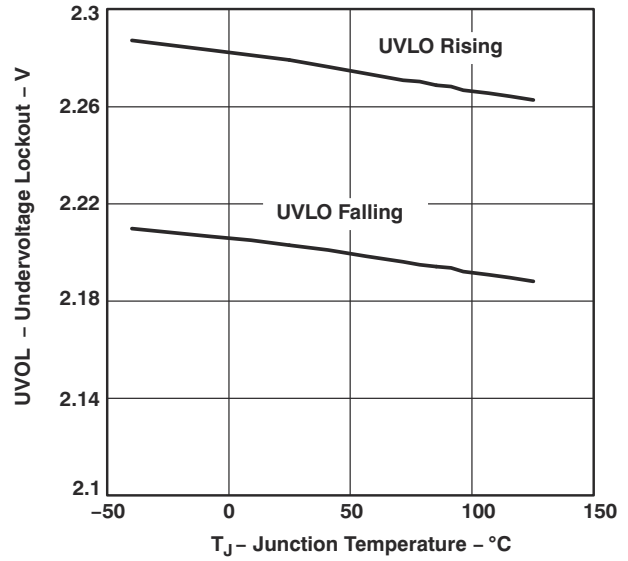

Figure 5-10. Undervoltage Lockout vs Junction Temperature

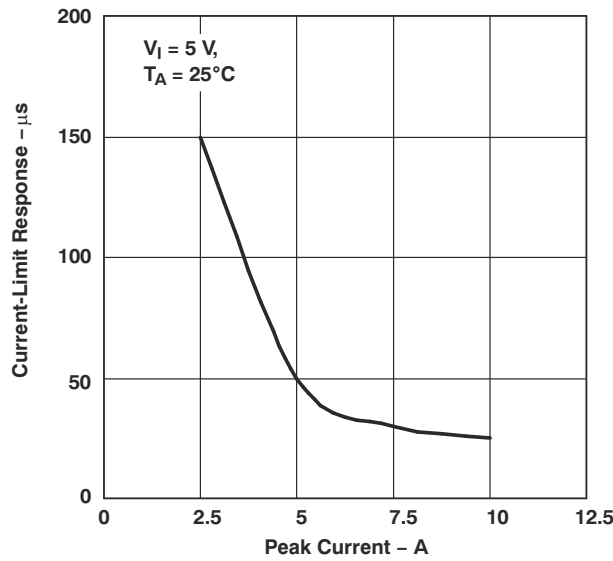

Figure 5-11. Current-Limit Response vs Peak Current

6 Parameter Measurement Information

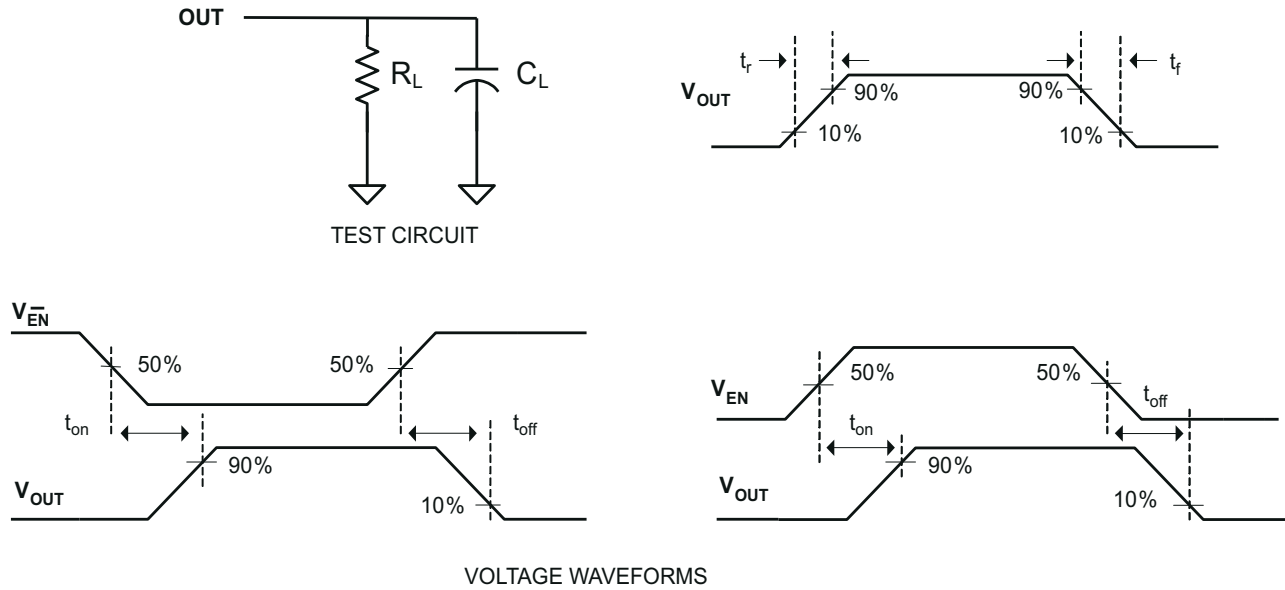

Figure 6-1. Test Circuit and Voltage Waveforms

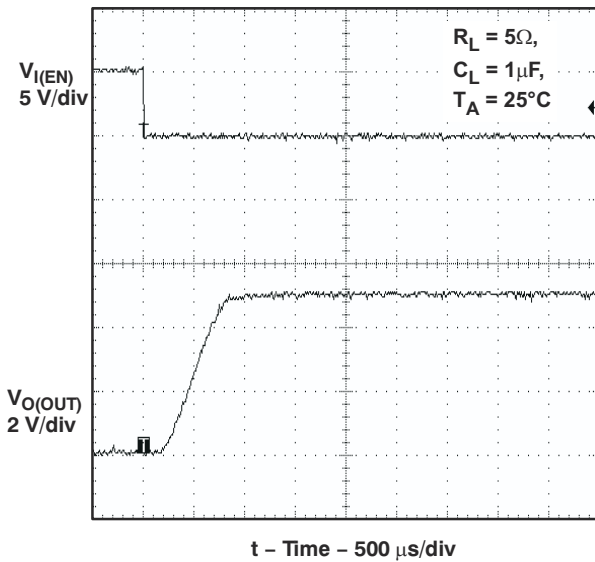

Figure 6-2. Turnon Delay and Rise Time With 1- μ F Load

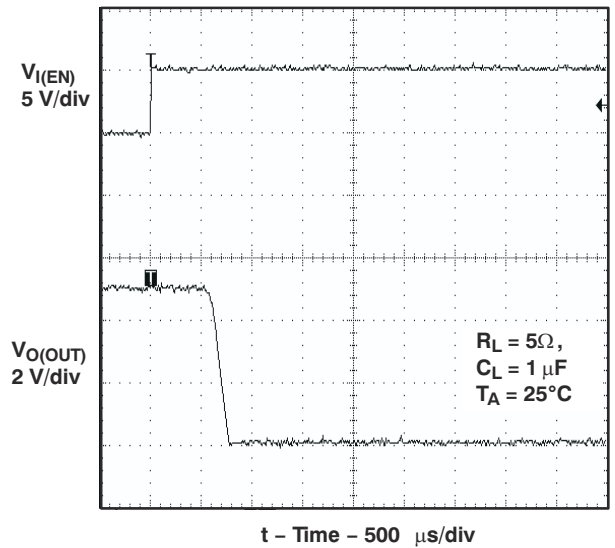

Figure 6-3. Turnoff Delay and Fall Time With 1- μ F Load

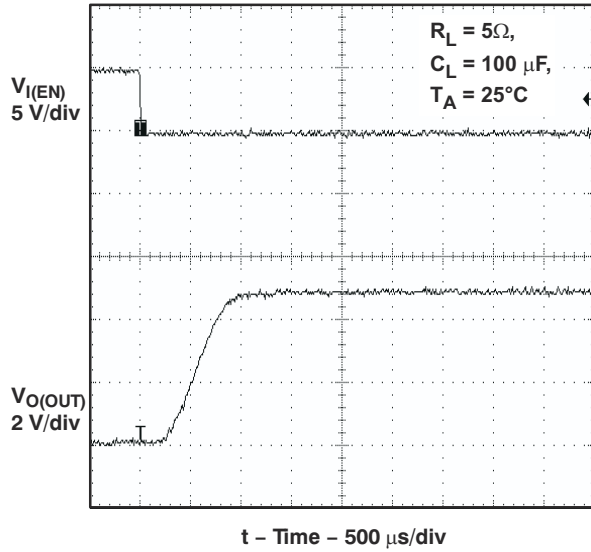

Figure 6-4. Turnon Delay and Rise Time With 100- μF Load

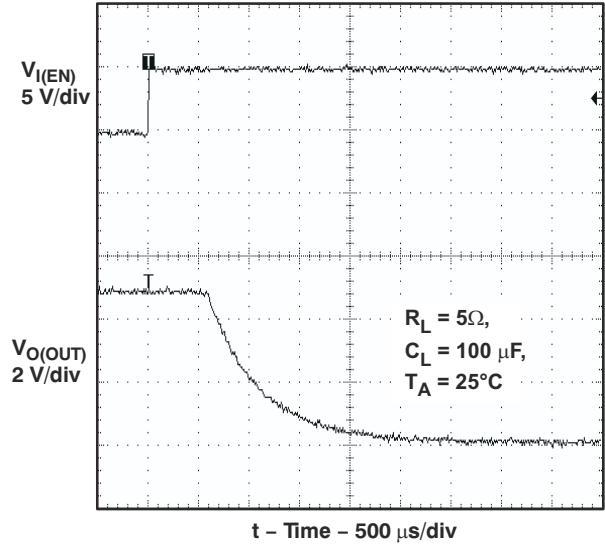

Figure 6-5. Turnoff Delay and Fall Time With 100- μF Load

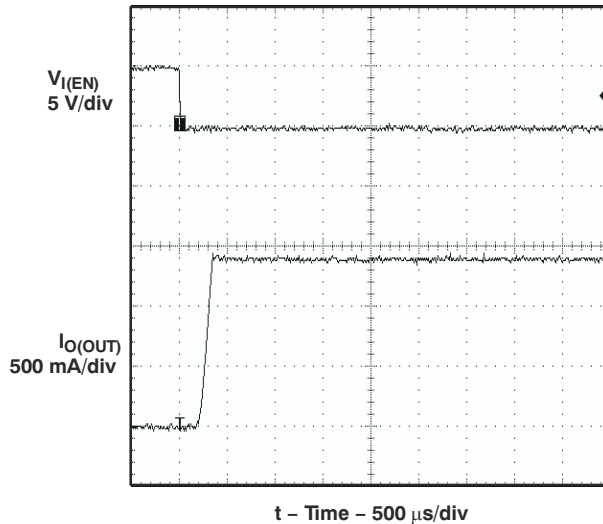

Figure 6-6. Short-Circuit Current, Device Enabled Into Short

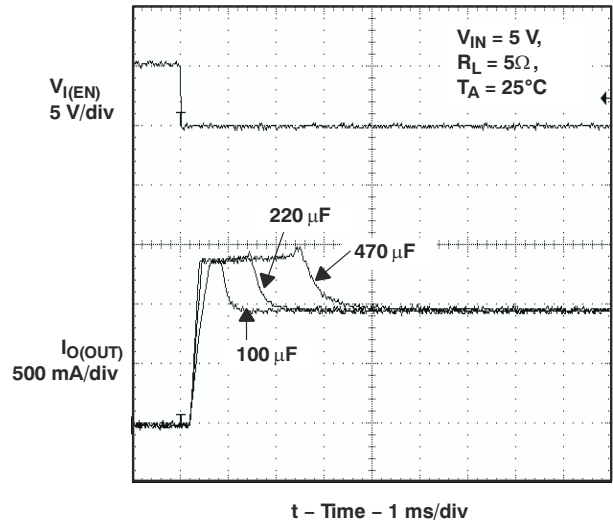

Figure 6-7. Inrush Current With Different Load Capacitance

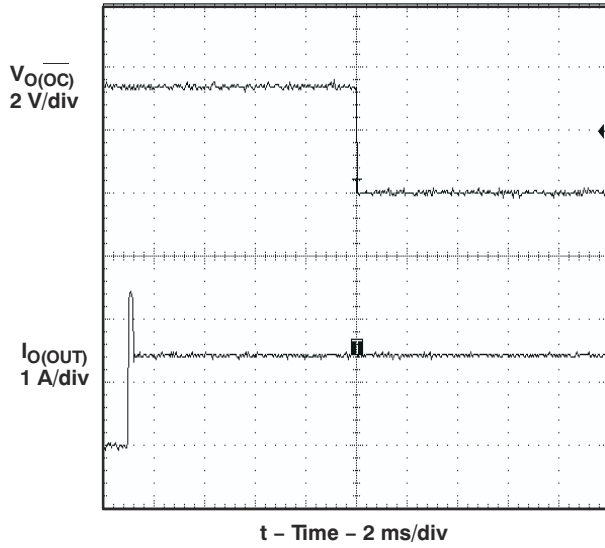

Figure 6-8. 2- Ω Load Connected to Enabled Device

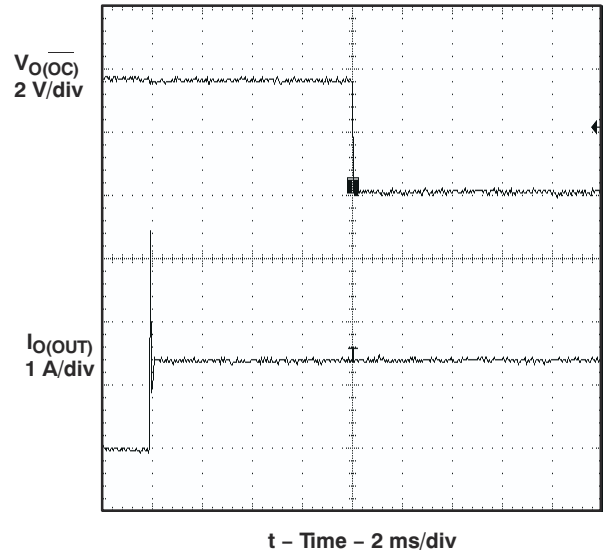

Figure 6-9. 1- Ω Load Connected to Enabled Device

7 Detailed Description

Table 7-1. Package Information

| T _A | ENABLE | RECOMMENDED MAXIMUM CONTINUOUS LOAD CURRENT | TYPICAL SHORT-CIRCUIT LIMIT | PACKAGE ⁽¹⁾ | | | |
|------------------|-------------|--|-----------------------------------|------------------------|-----------|----------------|-----------|
| | | | | D-8 (SOIC) | | DRB-8 (SON) | |
| | | | | PART # | STATUS | PART # | STATUS |
| -40°C to 85°C | Active low | 1 A | 1.6 A | TPS2062AD | AVAILABLE | TPS2062ADRB | AVAILABLE |
| | Active high | | | TPS2066AD | AVAILABLE | TPS2066ADRB | AVAILABLE |

(1) For the most current package and ordering information, see the Package Option Addendum at the end of this document, or see the TI website at www.ti.com.

7.1 Overview

The devices are current-limited, power distribution switches using N-channel MOSFETs for applications where short-circuits or heavy capacitive loads are encountered. These devices have a minimum fixed current-limit threshold above 1.1A allowing for continuous operation up to 1A per channel. Overtemperature protection is an additional device shutdown feature. Each device incorporates an internal charge pump and gate drive circuitry necessary to drive the N-channel MOSFETs. The charge pump supplies power to the driver circuit and provides the necessary voltage to pull the gate of the MOSFET above the source. The charge pump operates from input voltages as low as 2.7V and requires little supply current. The driver controls the gate voltage of the power switch. The driver incorporates circuitry that controls the rise and fall times of the output voltage to provide "soft-start" and to limit large current and voltage surges.

7.2 Functional Block Diagram

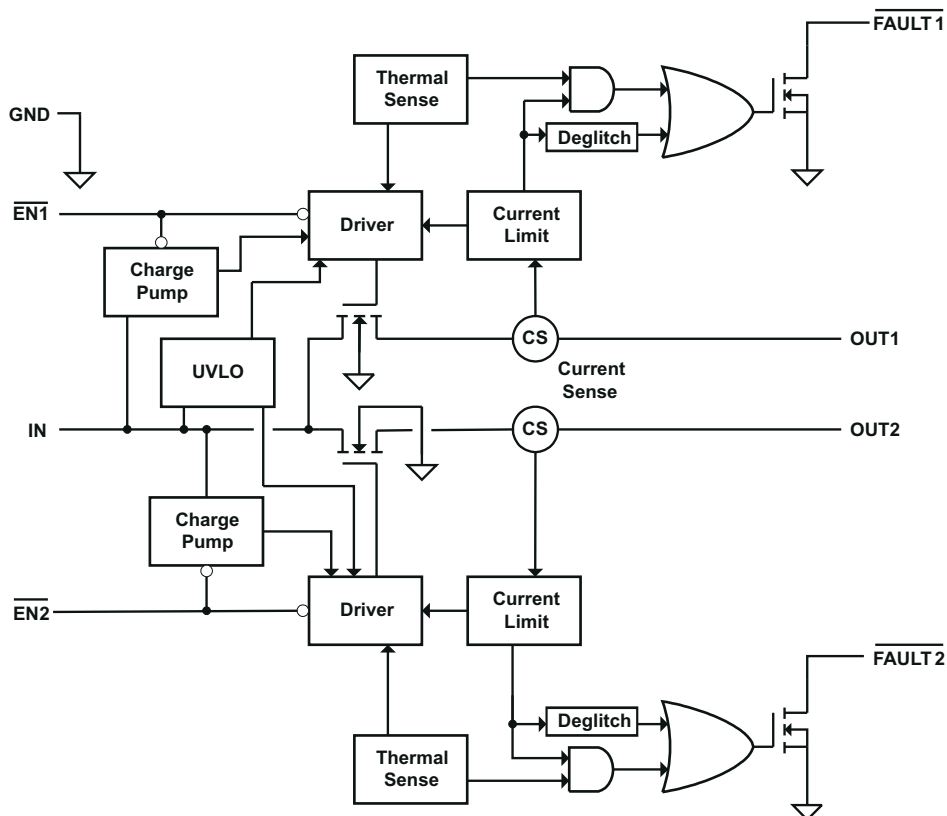

- A. Current sense
- B. Active low ($\overline{\text{ENx}}$) for TPS2062A. Active high (ENx) for TPS2066A.

7.3 Overcurrent

A sense FET is employed to check for overcurrent conditions. Unlike current-sense resistors, sense FETs do not increase the series resistance of the current path. When an overcurrent condition is detected, the device maintains a constant output current and reduces the output voltage accordingly. Complete shutdown occurs only if the fault is present long enough to activate thermal limiting.

There are two kinds of current limit profiles for the TPS206xA devices.

The TPS2062ADRB, TPS2066ADRB, and TPS2066AD have an output I vs V characteristic similar to the plot labeled **Current Limit with Peaking** in Figure 7-1. This type of limiting can be characterized by two parameters, the overcurrent trip threshold (I_{OC}), and the short-circuit output current threshold (I_{OS}).

The TPS2062AD has an output I vs V characteristic similar to the plot labeled **Flat Current Limit** in Figure 7-1. This type of limiting can be characterized by one parameters, the short circuit current (I_{OS}).

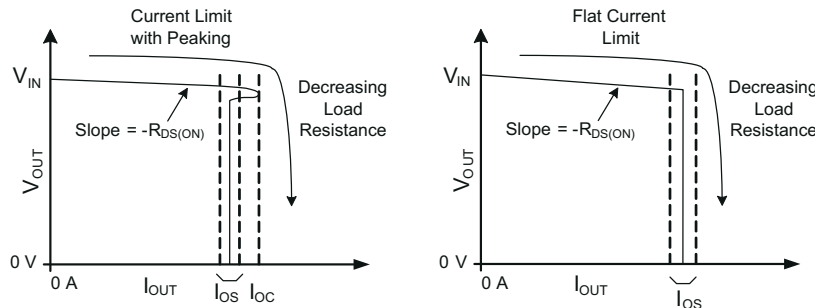

Figure 7-1. Current Limit Profiles

7.3.1 Overcurrent Conditions (TPS2062ADRB, TPS2066ADRB, and TPS2066AD)

Three possible overload conditions can occur for the TPS2062ADRB, TPS2066ADRB, and TPS2066AD. In the first condition, the output has been shorted before the device is enabled or before $V_{I(IN)}$ has been applied (see Figure 6-6 through Figure 6-9). The TPS2062ADRB, TPS2066ADRB, and TPS2066AD senses the short and immediately switches into a constant-current output.

In the second condition, a short or an overload occurs while the device is enabled. At the instant the overload occurs, high currents may flow for a short period of time before the current-limit circuit can react. After the current-limit circuit has tripped (reached the overcurrent trip threshold (I_{OC})), the device switches into constant-current mode and current is limited at the short-circuit output current threshold (I_{OS}).

In the third condition, the load has been gradually increased beyond the recommended operating current. The current is permitted to rise until the overcurrent trip threshold (I_{OC}) is reached or until the thermal limit of the device is exceeded. The TPS2062ADRB, TPS2066ADRB, and TPS2066AD are capable of delivering current up to the current-limit threshold without damaging the device. Once the overcurrent trip threshold (I_{OC}) has been reached, the device switches into its constant-current mode current is limited at the short-circuit output current threshold (I_{OS}).

7.3.2 Overcurrent Conditions (TPS2062AD)

Three possible overload conditions can occur for the TPS2062AD. In the first condition, the output has been shorted before the device is enabled or before $V_{I(IN)}$ has been applied. The TPS2062AD senses the short and immediately switches into a constant-current output.

In the second condition, a short or an overload occurs while the device is enabled. At the instant the overload occurs, high currents may flow for a short period of time before the current-limit circuit can react. After the short-circuit output current threshold (I_{OS}) is reached, the device switches into constant-current mode.

In the third condition, the load has been gradually increased beyond the recommended operating current. After the short-circuit output current threshold (I_{OS}) is reached, the device switches into constant-current mode.

7.4 $\overline{\text{OCx}}$ Response

Each $\overline{\text{OCx}}$ open-drain output is asserted (active low) during an overcurrent or overtemperature condition on that channel. The output remains asserted until the fault condition is removed. The TPS206xA eliminates false $\overline{\text{OCx}}$ reporting by using internal delay circuitry after entering or leaving an overcurrent condition. This "deglitch" time is approximately 8-ms and ensures that $\overline{\text{OCx}}$ is not accidentally asserted due to normal operation such as starting into a heavy capacitive load. Overtemperature conditions are not deglitched and assert and de-assert the $\overline{\text{OCx}}$ signal immediately.

7.5 Undervoltage Lockout (UVLO)

The undervoltage lockout (UVLO) circuit disables the power switch until the input voltage reaches the UVLO turn-on threshold. Built-in hysteresis prevents unwanted on/off cycling due to input voltage drop from large current surges.

7.6 Enable ($\overline{\text{ENx}}$ or ENx)

The logic enable controls the power switch, bias for the charge pump, driver, and other circuits to reduce the supply current. The supply current is reduced to less than 5 μA when a logic high is present on $\overline{\text{ENx}}$, or when a logic low is present on ENx. A logic low input on $\overline{\text{ENx}}$ or a logic high input on ENx enables the driver, control circuits, and power switch for that channel.

7.7 Thermal Sense

The TPS206xA monitors the operating temperature of both power distribution switches with individual thermal sensors. The junction temperature of each channel rises during an overcurrent or short-circuit condition. When the die temperature of a particular channel rises above a minimum of 135°C in an overcurrent condition, the internal thermal sense circuitry disables the individual channel in overtemperature to prevent damage. Hysteresis is built into the thermal sensor and re-enables the power switch individually after it has cooled approximately 10°C. The power switch cycles on and off until the fault is removed. This topology allows one channel to continue normal operation even if the other channel is in an overtemperature condition. The open-drain overcurrent flag ($\overline{\text{OCx}}$) is asserted (active low) corresponding to the channel that is in an overtemperature or overcurrent condition.

8 Application Information

8.1 Power-Supply Considerations

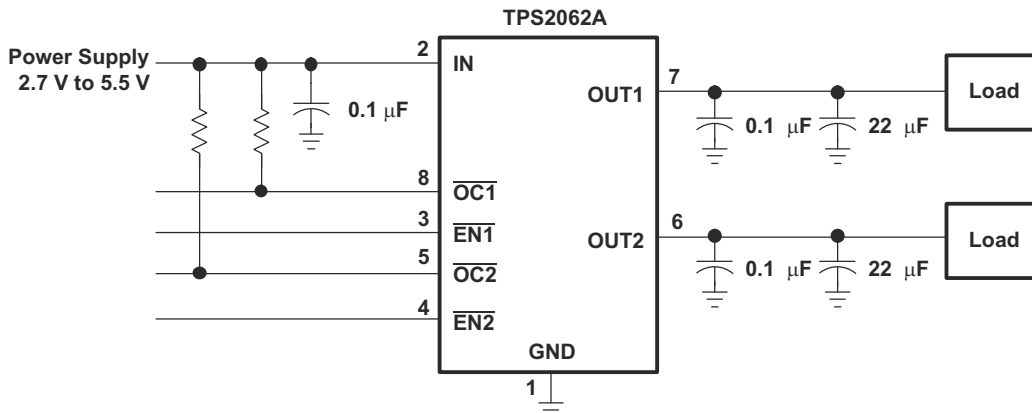

Figure 8-1. Typical Application

8.2 Input and Output Capacitance

Input and output capacitance improve the performance of the device; the actual capacitance must be optimized for the particular application. For all applications, a 0.01 μF to 0.1 μF ceramic bypass capacitor between IN and GND is recommended and must be placed as close to the device as possible for local noise de-coupling. This precaution reduces ringing on the input due to power-supply transients. Additional input capacitance may be needed on the input to reduce voltage overshoot from exceeding the absolute maximum voltage of the device during heavy transients.

Placing a high-value electrolytic capacitor on the output pin is recommended when the output load is heavy. Additionally, bypassing the output with a 0.01 μF to 0.1 μF ceramic capacitor improves the immunity of the device to short-circuit transients.

8.3 Power Dissipation and Junction Temperature

The low on-resistance of the N-channel MOSFETs allows the small surface-mount packages to pass large currents. It is good design practice to check power dissipation to ensure that the junction temperature of the device is within the recommended operating conditions. The below analysis gives an approximation for calculating junction temperature based on the power dissipation in the package. However, it is important to note that thermal analysis is strongly dependent on additional system level factors. Such factors include air flow, board layout, copper thickness and surface area, and proximity to other devices dissipating power. Good thermal design practice must include all system level factors in addition to individual component analysis.

The following procedure shows how to approximate the junction temperature rise due to power dissipation in a single channel. The TPS2062A/66A devices contain two channels, so the total device power must sum the power in each power switch.

Begin by determining the $r_{\text{DS(on)}}$ of the N-channel MOSFET relative to the input voltage and operating temperature. Use the highest operating ambient temperature of interest and read $r_{\text{DS(on)}}$ from the typical characteristics graph as an initial estimate. Power dissipation is calculated by:

$$P_D = r_{\text{DS(on)}} \times I_{\text{OUT}}^2$$

$$P_T = 2 \times P_D$$

Where:

P_D = Power dissipation/channel (W)

P_T = Total power dissipation for both channels (W)

$r_{DS(on)}$ = Power switch on-resistance (Ω)

I_{OUT} = Maximum current-limit threshold (A)

Finally, calculate the junction temperature:

$$T_J = P_T \times R_{\theta JA} + T_A$$

Where:

T_A = Ambient temperature $^{\circ}\text{C}$

$R_{\theta JA}$ = Thermal resistance ($^{\circ}\text{C}/\text{W}$)

P_T = Total power dissipation (W)

Compare the calculated junction temperature with the initial estimate. If they are not within a few degrees, repeat the calculation using the "refined" $r_{DS(on)}$ from the previous calculation as the new estimate. Two or three iterations are generally sufficient to achieve the desired result. The final junction temperature is highly dependent on thermal resistance $R_{\theta JA}$, and thermal resistance is highly dependent on the individual package and board layout. The "Dissipation Rating Table" at the beginning of this document provides example thermal resistances for specific packages and board layouts.

8.4 Universal Serial Bus (USB) Applications

One application for this device is for current-limiting in universal serial bus (USB) applications. The original USB interface was a 12-Mb/s or 1.5-Mb/s, multiplexed serial bus designed for low-to-medium bandwidth PC peripherals (for example, keyboards, printers, scanners, and mice). As the demand for more bandwidth increased, the USB 2.0 standard was introduced increasing the maximum data rate to 480-Mb/s. The four-wire USB interface is conceived for dynamic attach-detach (hot plug-unplug) of peripherals. Two lines are provided for differential data, and two lines are provided for 5-V power distribution.

USB data is a 3.3-V level signal, but power is distributed at 5 V to allow for voltage drops in cases where power is distributed through more than one hub across long cables. Each function must provide its own regulated 3.3 V from the 5-V input or its own internal power supply. The USB specification classifies two different classes of devices depending on its maximum current draw. A device classified as low-power can draw up to 100 mA as defined by the standard. A device classified as high-power can draw up to 500 mA. It is important that the minimum current limit threshold of the current-limiting power switch exceed the maximum current limit draw of the intended application. The latest USB standard must always be referenced when considering the current-limit threshold.

The USB specification defines two types of devices as hubs and functions. A USB hub is a device that contains multiple ports for different USB devices to connect and can be self-powered (SPH) or bus-powered (BPH). A function is a USB device that is able to transmit or receive data or control information over the bus. A USB function can be embedded in a USB hub. A USB function can be one of three types included in the list below.

- Low-power, bus-powered function
- High-power, bus-powered function
- Self-powered function

SPHs and BPHs distribute data and power to downstream functions. The TPS206x6A has higher current capability than required for a single USB port allowing it to power multiple downstream ports.

8.5 Self-powered and Bus-Powered Hubs

A SPH has a local power supply that powers embedded functions and downstream ports. This power supply must provide between 4.75 V to 5.25 V to downstream facing devices under full-load and no-load conditions. SPHs are required to have current-limit protection and must report overcurrent conditions to the USB controller. Typical SPHs are desktop PCs, monitors, printers, and stand-alone hubs.

A BPH obtains all power from an upstream port and often contains an embedded function. The hubs must power up with less than 100 mA. The BPH usually has one embedded function, and power is always available to the

controller of the hub. If the embedded function and hub require more than 100 mA on power up, the power to the embedded function may need to be kept off until enumeration is completed. This is accomplished by removing power or by shutting off the clock to the embedded function. Power switching the embedded function is not necessary if the aggregate power draw for the function and controller is less than 100 mA. The total current drawn by the bus-powered device is the sum of the current to the controller, the embedded function, and the downstream ports, and it is limited to 500 mA from an upstream port.

8.6 Low-Power Bus-Powered And High-Power Bus-Powered Functions

Both low-power and high-power bus-powered functions obtain all power from upstream ports. Low-power functions always draw less than 100 mA; high-power functions must draw less than 100 mA at power up and can draw up to 500 mA after enumeration. If the load of the function is more than the parallel combination of 44 Ω and 10 μF at power up, the device must implement inrush current limiting.

8.7 USB Power-Distribution Requirements

USB can be implemented in several ways regardless of the type of USB device being developed. Several power-distribution features must be implemented.

- SPHs must:
 - Current-limit downstream ports
 - Report overcurrent conditions
- BPHs must:
 - Enable/disable power to downstream ports
 - Power up at <100 mA
 - Limit inrush current (<44 Ω and 10 μF)
- Functions must:
 - Limit inrush currents
 - Power up at <100 mA

The feature set of the TPS2062A/66A meets each of these requirements. The integrated current-limiting and overcurrent reporting is required by self-powered hubs. The logic-level enable and controlled rise times meet the need of both input and output ports on bus-powered hubs and the input ports for bus-powered functions.

9 Device and Documentation Support

TI offers an extensive line of development tools. Tools and software to evaluate the performance of the device, generate code, and develop solutions are listed below.

9.1 Receiving Notification of Documentation Updates

To receive notification of documentation updates, navigate to the device product folder on ti.com. Click on *Notifications* to register and receive a weekly digest of any product information that has changed. For change details, review the revision history included in any revised document.

9.2 Support Resources

TI E2E™ support forums are an engineer's go-to source for fast, verified answers and design help — straight from the experts. Search existing answers or ask your own question to get the quick design help you need.

Linked content is provided "AS IS" by the respective contributors. They do not constitute TI specifications and do not necessarily reflect TI's views; see TI's [Terms of Use](#).

9.3 Trademarks

PowerPAD™ and TI E2E™ are trademarks of Texas Instruments. All trademarks are the property of their respective owners.

9.4 Electrostatic Discharge Caution



This integrated circuit can be damaged by ESD. Texas Instruments recommends that all integrated circuits be handled with appropriate precautions. Failure to observe proper handling and installation procedures can cause damage.

ESD damage can range from subtle performance degradation to complete device failure. Precision integrated circuits may be more susceptible to damage because very small parametric changes could cause the device not to meet its published specifications.

9.5 Glossary

[TI Glossary](#) This glossary lists and explains terms, acronyms, and definitions.

10 Revision History

NOTE: Page numbers for previous revisions may differ from page numbers in the current version.

| Changes from Revision F (November 2008) to Revision G (June 2024) | Page |
|---|-------------|
| • Updated the numbering format for tables, figures, and cross-references throughout the document..... | 1 |
| • Deleted Dissipation Ratings table..... | 1 |
| • Updated Table 4-1 footnote about PowerPad | 3 |
| • Added Section 5.3 | 4 |
| • Updated max UVLO for TPS2062A..... | 4 |
| • Updated max Supply current, high-level output values for TPS2062A..... | 4 |
| • Updated Overcurrent trip threshold to apply only to TPS2062ADRB, TPS2066ADRB, and TPS2066AD..... | 4 |
| • Updated Section 7.3 | 13 |
| • Added Section 7.3.1 | 13 |
| • Added Section 7.3.2 | 13 |

11 Mechanical, Packaging, and Orderable Information

The following pages include mechanical, packaging, and orderable information. This information is the most current data available for the designated devices. This data is subject to change without notice and revision of this document. For browser-based versions of this data sheet, refer to the left-hand navigation.

PACKAGING INFORMATION

| Orderable Device | Status (1) | Package Type | Package Drawing | Pins | Package Qty | Eco Plan (2) | Lead finish/ Ball material (6) | MSL Peak Temp (3) | Op Temp (°C) | Device Marking (4/5) | Samples |
|------------------|---------------|--------------|-----------------|------|-------------|-----------------|--------------------------------------|----------------------|--------------|-------------------------|-------------------------|
| TPS2062AD | ACTIVE | SOIC | D | 8 | 75 | RoHS & Green | NIPDAU | Level-1-260C-UNLIM | -40 to 125 | 2062A | Samples |
| TPS2062ADR | ACTIVE | SOIC | D | 8 | 2500 | RoHS & Green | NIPDAU | Level-1-260C-UNLIM | -40 to 85 | 2062A | Samples |
| TPS2062ADRBR | ACTIVE | SON | DRB | 8 | 3000 | RoHS & Green | NIPDAU | Level-1-260C-UNLIM | -40 to 125 | 2062 | Samples |
| TPS2062ADRBT | ACTIVE | SON | DRB | 8 | 250 | RoHS & Green | NIPDAU | Level-1-260C-UNLIM | -40 to 125 | 2062 | Samples |
| TPS2066AD | OBSOLETE | SOIC | D | 8 | | TBD | Call TI | Call TI | -40 to 125 | 2066A | |
| TPS2066ADR | OBSOLETE | SOIC | D | 8 | | TBD | Call TI | Call TI | -40 to 125 | 2066A | |
| TPS2066ADRBR | OBSOLETE | SON | DRB | 8 | | TBD | Call TI | Call TI | -40 to 125 | 2066 | |
| TPS2066ADRBT | OBSOLETE | SON | DRB | 8 | | TBD | Call TI | Call TI | -40 to 125 | 2066 | |

(1) The marketing status values are defined as follows:

ACTIVE: Product device recommended for new designs.

LIFEBUY: TI has announced that the device will be discontinued, and a lifetime-buy period is in effect.

NRND: Not recommended for new designs. Device is in production to support existing customers, but TI does not recommend using this part in a new design.

PREVIEW: Device has been announced but is not in production. Samples may or may not be available.

OBSOLETE: TI has discontinued the production of the device.

(2) **RoHS:** TI defines "RoHS" to mean semiconductor products that are compliant with the current EU RoHS requirements for all 10 RoHS substances, including the requirement that RoHS substance do not exceed 0.1% by weight in homogeneous materials. Where designed to be soldered at high temperatures, "RoHS" products are suitable for use in specified lead-free processes. TI may reference these types of products as "Pb-Free".

RoHS Exempt: TI defines "RoHS Exempt" to mean products that contain lead but are compliant with EU RoHS pursuant to a specific EU RoHS exemption.

Green: TI defines "Green" to mean the content of Chlorine (Cl) and Bromine (Br) based flame retardants meet JS709B low halogen requirements of <=1000ppm threshold. Antimony trioxide based flame retardants must also meet the <=1000ppm threshold requirement.

(3) MSL, Peak Temp. - The Moisture Sensitivity Level rating according to the JEDEC industry standard classifications, and peak solder temperature.

(4) There may be additional marking, which relates to the logo, the lot trace code information, or the environmental category on the device.

(5) Multiple Device Markings will be inside parentheses. Only one Device Marking contained in parentheses and separated by a "-" will appear on a device. If a line is indented then it is a continuation of the previous line and the two combined represent the entire Device Marking for that device.

⁽⁶⁾ Lead finish/Ball material - Orderable Devices may have multiple material finish options. Finish options are separated by a vertical ruled line. Lead finish/Ball material values may wrap to two lines if the finish value exceeds the maximum column width.

Important Information and Disclaimer:The information provided on this page represents TI's knowledge and belief as of the date that it is provided. TI bases its knowledge and belief on information provided by third parties, and makes no representation or warranty as to the accuracy of such information. Efforts are underway to better integrate information from third parties. TI has taken and continues to take reasonable steps to provide representative and accurate information but may not have conducted destructive testing or chemical analysis on incoming materials and chemicals. TI and TI suppliers consider certain information to be proprietary, and thus CAS numbers and other limited information may not be available for release.

In no event shall TI's liability arising out of such information exceed the total purchase price of the TI part(s) at issue in this document sold by TI to Customer on an annual basis.

TAPE AND REEL INFORMATION

QUADRANT ASSIGNMENTS FOR PIN 1 ORIENTATION IN TAPE

*All dimensions are nominal

| Device | Package Type | Package Drawing | Pins | SPQ | Reel Diameter (mm) | Reel Width W1 (mm) | A0 (mm) | B0 (mm) | K0 (mm) | P1 (mm) | W (mm) | Pin1 Quadrant |
|--------------|--------------|-----------------|------|------|--------------------|--------------------|---------|---------|---------|---------|--------|---------------|
| TPS2062ADR | SOIC | D | 8 | 2500 | 330.0 | 12.4 | 6.4 | 5.2 | 2.1 | 8.0 | 12.0 | Q1 |
| TPS2062ADRBR | SON | DRB | 8 | 3000 | 330.0 | 12.4 | 3.3 | 3.3 | 1.0 | 8.0 | 12.0 | Q2 |
| TPS2062ADRBT | SON | DRB | 8 | 250 | 180.0 | 12.4 | 3.3 | 3.3 | 1.0 | 8.0 | 12.0 | Q2 |

TAPE AND REEL BOX DIMENSIONS

*All dimensions are nominal

| Device | Package Type | Package Drawing | Pins | SPQ | Length (mm) | Width (mm) | Height (mm) |
|--------------|--------------|-----------------|------|------|-------------|------------|-------------|
| TPS2062ADR | SOIC | D | 8 | 2500 | 353.0 | 353.0 | 32.0 |
| TPS2062ADRBR | SON | DRB | 8 | 3000 | 346.0 | 346.0 | 35.0 |
| TPS2062ADRBT | SON | DRB | 8 | 250 | 200.0 | 183.0 | 25.0 |

TUBE

*All dimensions are nominal

| Device | Package Name | Package Type | Pins | SPQ | L (mm) | W (mm) | T (μm) | B (mm) |
|-----------|--------------|--------------|------|-----|--------|--------|--------|--------|
| TPS2062AD | D | SOIC | 8 | 75 | 507 | 8 | 3940 | 4.32 |

DRB 8

GENERIC PACKAGE VIEW

VSON - 1 mm max height

PLASTIC SMALL OUTLINE - NO LEAD



Images above are just a representation of the package family, actual package may vary.
Refer to the product data sheet for package details.

4203482/L

DRB0008B



PACKAGE OUTLINE

VSON - 1 mm max height

PLASTIC SMALL OUTLINE - NO LEAD

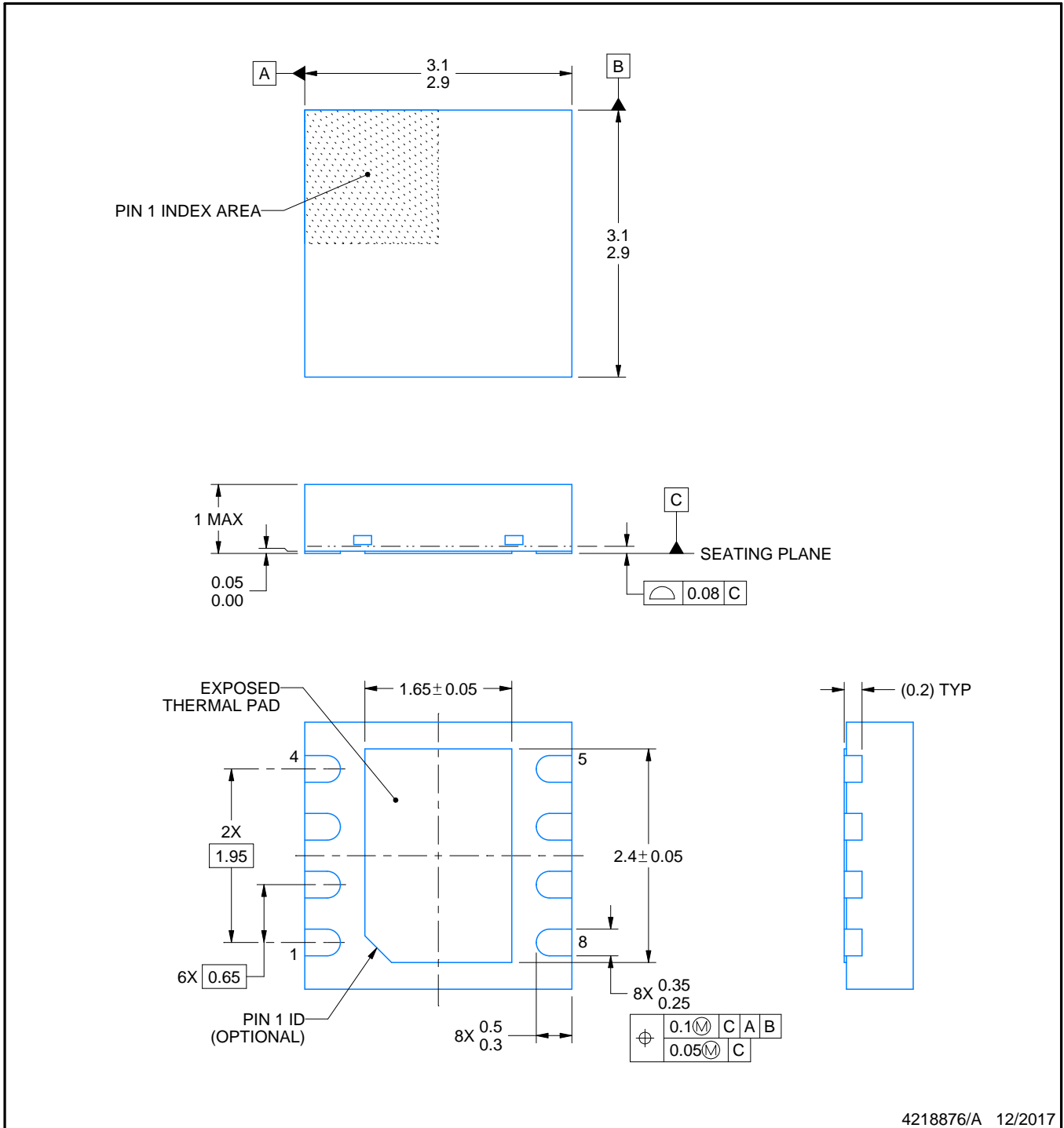

4218876/A 12/2017

NOTES:

1. All linear dimensions are in millimeters. Any dimensions in parenthesis are for reference only. Dimensioning and tolerancing per ASME Y14.5M.
2. This drawing is subject to change without notice.
3. The package thermal pad must be soldered to the printed circuit board for thermal and mechanical performance.

EXAMPLE BOARD LAYOUT

DRB0008B

VSON - 1 mm max height

PLASTIC SMALL OUTLINE - NO LEAD



LAND PATTERN EXAMPLE
SCALE:20X



SOLDER MASK DETAILS

4218876/A 12/2017

NOTES: (continued)

4. This package is designed to be soldered to a thermal pad on the board. For more information, see Texas Instruments literature number SLUA271 (www.ti.com/lit/sluea271).
5. Vias are optional depending on application, refer to device data sheet. If any vias are implemented, refer to their locations shown on this view. It is recommended that vias under paste be filled, plugged or tented.

EXAMPLE STENCIL DESIGN

DRB0008B

VSON - 1 mm max height

PLASTIC SMALL OUTLINE - NO LEAD

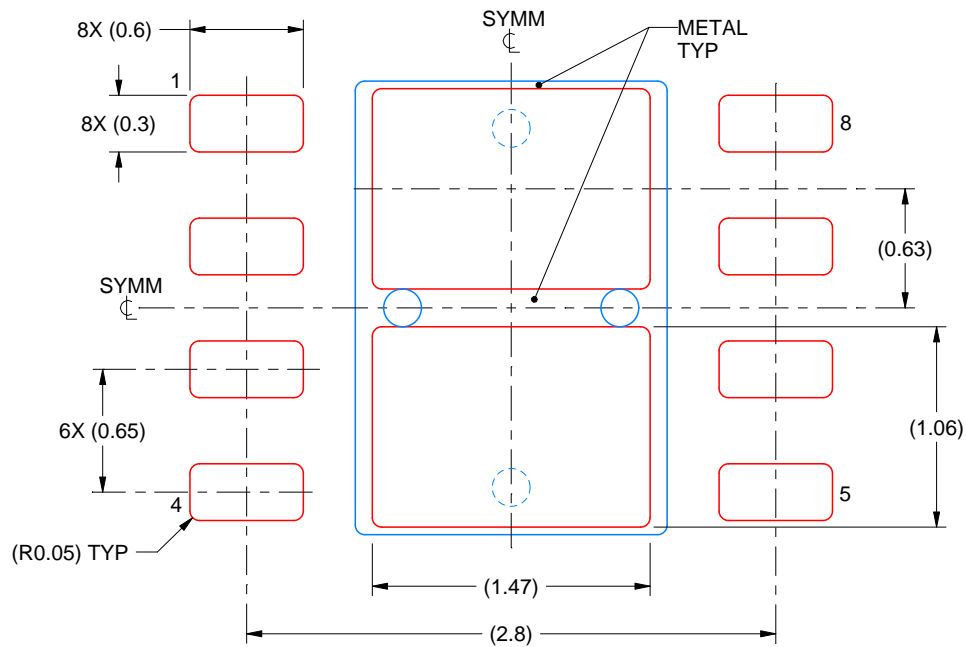

SOLDER PASTE EXAMPLE
BASED ON 0.125 mm THICK STENCIL

EXPOSED PAD
81% PRINTED SOLDER COVERAGE BY AREA
SCALE:25X

4218876/A 12/2017

NOTES: (continued)

6. Laser cutting apertures with trapezoidal walls and rounded corners may offer better paste release. IPC-7525 may have alternate design recommendations.



D0008A

PACKAGE OUTLINE

SOIC - 1.75 mm max height

SMALL OUTLINE INTEGRATED CIRCUIT



4214825/C 02/2019

NOTES:

1. Linear dimensions are in inches [millimeters]. Dimensions in parenthesis are for reference only. Controlling dimensions are in inches. Dimensioning and tolerancing per ASME Y14.5M.
2. This drawing is subject to change without notice.
3. This dimension does not include mold flash, protrusions, or gate burrs. Mold flash, protrusions, or gate burrs shall not exceed $.006$ [0.15] per side.
4. This dimension does not include interlead flash.
5. Reference JEDEC registration MS-012, variation AA.

EXAMPLE BOARD LAYOUT

D0008A

SOIC - 1.75 mm max height

SMALL OUTLINE INTEGRATED CIRCUIT



LAND PATTERN EXAMPLE
EXPOSED METAL SHOWN
SCALE:8X



SOLDER MASK DETAILS

4214825/C 02/2019

NOTES: (continued)

6. Publication IPC-7351 may have alternate designs.

7. Solder mask tolerances between and around signal pads can vary based on board fabrication site.

EXAMPLE STENCIL DESIGN

D0008A

SOIC - 1.75 mm max height

SMALL OUTLINE INTEGRATED CIRCUIT



SOLDER PASTE EXAMPLE
BASED ON .005 INCH [0.125 MM] THICK STENCIL
SCALE:8X

4214825/C 02/2019

NOTES: (continued)

8. Laser cutting apertures with trapezoidal walls and rounded corners may offer better paste release. IPC-7525 may have alternate design recommendations.
9. Board assembly site may have different recommendations for stencil design.

IMPORTANT NOTICE AND DISCLAIMER

TI PROVIDES TECHNICAL AND RELIABILITY DATA (INCLUDING DATA SHEETS), DESIGN RESOURCES (INCLUDING REFERENCE DESIGNS), APPLICATION OR OTHER DESIGN ADVICE, WEB TOOLS, SAFETY INFORMATION, AND OTHER RESOURCES "AS IS" AND WITH ALL FAULTS, AND DISCLAIMS ALL WARRANTIES, EXPRESS AND IMPLIED, INCLUDING WITHOUT LIMITATION ANY IMPLIED WARRANTIES OF MERCHANTABILITY, FITNESS FOR A PARTICULAR PURPOSE OR NON-INFRINGEMENT OF THIRD PARTY INTELLECTUAL PROPERTY RIGHTS.

These resources are intended for skilled developers designing with TI products. You are solely responsible for (1) selecting the appropriate TI products for your application, (2) designing, validating and testing your application, and (3) ensuring your application meets applicable standards, and any other safety, security, regulatory or other requirements.

These resources are subject to change without notice. TI grants you permission to use these resources only for development of an application that uses the TI products described in the resource. Other reproduction and display of these resources is prohibited. No license is granted to any other TI intellectual property right or to any third party intellectual property right. TI disclaims responsibility for, and you will fully indemnify TI and its representatives against, any claims, damages, costs, losses, and liabilities arising out of your use of these resources.

TI's products are provided subject to [TI's Terms of Sale](#) or other applicable terms available either on [ti.com](https://www.ti.com) or provided in conjunction with such TI products. TI's provision of these resources does not expand or otherwise alter TI's applicable warranties or warranty disclaimers for TI products.

TI objects to and rejects any additional or different terms you may have proposed.

Mailing Address: Texas Instruments, Post Office Box 655303, Dallas, Texas 75265
Copyright © 2024, Texas Instruments Incorporated