

# TPS51383 and TPS51384 4.5-V to 24-V Input, 8-A Synchronous Buck Converters With 100-mA LDO PSM/OOA Modes

## 1 Features

- 4.5-V to 24-V input voltage range
- 3.36-V output voltage (TPS51383)
- 3.3-V, 100-mA LDO with switch over (TPS51383)
- 1.82-V output voltage (TPS51384)
- 1.8-V, 100-mA LDO with switch over (TPS51384)
- Integrated 22-mΩ and 11-mΩ MOSFETs
- Support 8-A continuous I<sub>OUT</sub>
- 80-μA low quiescent current
- ±1% reference voltage at 25°C
- ±1.5% reference voltage at -40°C to 125°C
- D-CAP3™ control mode for fast transient response
- Support POSCAP and all MLCC output capacitor
- Output discharge function
- Selectable PSM and OOA mode under light load
- Power-good indicator to monitor output voltage
- Latched output OV and UV protection
- Non-latched UVLO and OT protection
- Cycle-by-cycle overcurrent protection
- Built-in output discharge feature
- Small 2.00-mm × 3.00-mm HotRod™ QFN package

## 2 Applications

- [Notebook and PC computers](#)
- [Ultrabook, tablet computers](#)
- [TV and STB](#), point-of-load (POL)
- Distributed power systems

## 3 Description

The TPS51383 and TPS51384 are monolithic 8-A synchronous buck converters with adaptive on-time D-CAP3 control mode. Integrated low R<sub>DS(on)</sub> power MOSFETs enable high efficiency and offer ease-of-use with minimum external component count for space-constrained power systems. Features include an accurate reference voltage, fast load transient response, auto-skip mode operation for light load efficiency, OOA light load operation with > 25-kHz switching frequency, D-CAP3 control mode with good line, load regulation, and does not require external compensation.

The TPS51383 provides a fixed 3.36-V 8-A<sub>MAX</sub> output and a 3.3-V, 100-mA<sub>MAX</sub> LDO output with switch-over functionality. The TPS51384 provides a fixed 1.82-V 8-A<sub>MAX</sub> output and a 1.8-V, 100-mA<sub>MAX</sub> LDO with switch-over functionality. Both the TPS51383 and TPS51384 have ultra-low quiescent current function for long battery life in system standby mode.

The TPS5138x are available in a thermally enhanced 12-pin QFN package and are designed to operate from -40°C to 125°C junction temperature.

### Package Information

| Part Number | Package <sup>(1)</sup> | Body Size (NOM)   |
|-------------|------------------------|-------------------|
| TPS51383    | RJN (VQFN-HR, 12)      | 2.00 mm × 3.00 mm |
| TPS51384    |                        |                   |

- (1) For all available packages, see the orderable addendum at the end of the data sheet.

### Device Information

| Part Number | FIXED OUTPUT | LDO OUTPUT |
|-------------|--------------|------------|
| TPS51383    | 3.36 V       | 3.3 V      |
| TPS51384    | 1.82 V       | 1.8 V      |

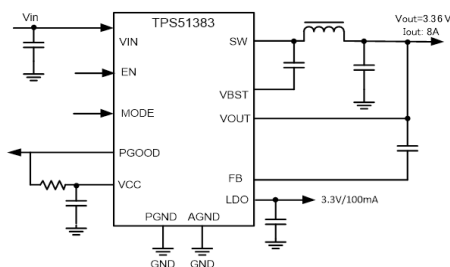

TPS51383 Typical Application

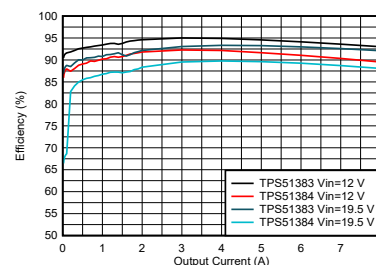

TPS51383 Efficiency Curve



## Table of Contents

|  |    |   |    |
|--|----|---|----|
| <b>1 Features</b> .....                        | 1  | 7.4 Device Functional Modes.....                        | 12 |
| <b>2 Applications</b> .....                    | 1  | <b>8 Application and Implementation</b> .....           | 14 |
| <b>3 Description</b> .....                     | 1  | 8.1 Application Information.....                        | 14 |
| <b>4 Revision History</b> .....                | 2  | 8.2 Typical Application.....                            | 14 |
| <b>5 Pin Configuration and Functions</b> ..... | 3  | 8.3 Power Supply Recommendations.....                   | 17 |
| <b>6 Specifications</b> .....                  | 4  | 8.4 Layout.....   | 18 |
| 6.1 Absolute Maximum Ratings.....              | 4  | <b>9 Device and Documentation Support</b> .....         | 19 |
| 6.2 ESD Ratings.....                           | 4  | 9.1 Device Support.....                                 | 19 |
| 6.3 Recommended Operating Conditions.....      | 4  | 9.2 Receiving Notification of Documentation Updates.... | 19 |
| 6.4 Thermal Information.....                   | 4  | 9.3 Support Resources.....                              | 19 |
| 6.5 Electrical Characteristics.....            | 5  | 9.4 Trademarks.....                                     | 19 |
| 6.6 Typical Characteristics.....               | 7  | 9.5 Electrostatic Discharge Caution.....                | 19 |
| <b>7 Detailed Description</b> .....            | 10 | 9.6 Glossary.....                                       | 19 |
| 7.1 Overview.....                              | 10 | <b>10 Mechanical, Packaging, and Orderable</b>          |    |
| 7.2 Functional Block Diagram.....              | 10 | <b>Information</b> .....                                | 20 |
| 7.3 Feature Description.....                   | 11 |   |    |

## 4 Revision History

| DATE           | REVISION | NOTES           |
|----------------|----------|-----------------|
| September 2022 | *        | Initial release |

## 5 Pin Configuration and Functions

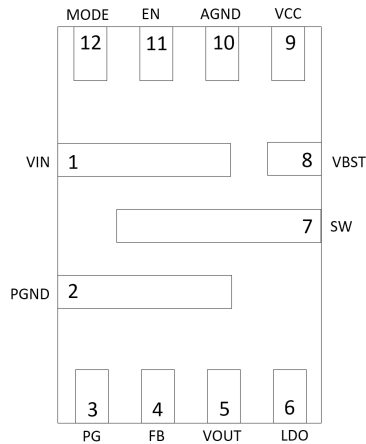

**Figure 5-1. RJN Package 12-Pin VQFN-HR Top View**

**Table 5-1. Pin Functions**

| PIN  |     | I/O | DESCRIPTION   |
|------|-----|-----|---|
| NAME | NO. |     |   |
| VIN  | 1   | P   | Input voltage supply pin for the control circuitry. Connect the input decoupling capacitors between VIN and PGND.   |
| PGND | 2   | G   | Power ground terminal for the internal power FET.   |
| PG   | 3   | O   | Open Drain Power Good Indicator. This pin is asserted low if output voltage is out of PG threshold, overvoltage or if the device is under thermal shutdown, EN shutdown or during soft start. |
| FB   | 4   | I   | FB pin can be used for feedforward compensation to improve load transient performance.  |
| VOUT | 5   | I   | Output voltage sense pin of buck converter. Connect this pin to the positive terminal of the output capacitor that is closest to the load.  |
| LDO  | 6   | O   | 100-mA LDO output pin for powering external devices even when EN is low (but Vin is >UVLO). Decouple with a minimum 4.7- $\mu$ F, 10-V X7R capacitor.   |
| SW   | 7   | O   | Switch node terminal. Connect the output inductor to this pin.  |
| VBST | 8   | I   | Supply input for the high-side MOSFET gate drive. Connect the bootstrap capacitor between VBST and SW.  |
| VCC  | 9   | O   | 5-V internal VCC LDO output. This pin supplies voltage to the internal circuitry and gate driver. Bypass this pin with a 1- $\mu$ F capacitor.  |
| AGND | 10  | G   | Ground of internal analog circuitry. Connect AGND to PGND at a single point close to AGND.  |
| EN   | 11  | I   | Enable pin of buck converter. EN pin is a digital input pin, pull up to enable the converter, pull down to disable. Internal pulldown if EN pin is floating.                                  |
| MODE | 12  | I   | Mode selection pin. Connect MODE pin to VCC, or pull above 0.8 V for OOA mode operation, connect MODE to AGND or float for Power Save Mode. Internal pulldown if MODE pin is floating.        |

## 6 Specifications

### 6.1 Absolute Maximum Ratings

Over operating junction temperature range (unless otherwise noted) <sup>(1)</sup>

|                  |                                | MIN  | MAX | UNIT |
|------------------|--------------------------------|------|-----|------|
| Input voltage    | VIN                            | -0.3 | 28  | V    |
| Input voltage    | VBST                           | -0.3 | 34  | V    |
| Input voltage    | VBST - SW                      | -0.3 | 6   | V    |
| Input voltage    | EN, FB, MODE, VOUT             | -0.3 | 6   | V    |
| Output voltage   | SW (10ns transient)            | -4   | 28  | V    |
| Output voltage   | SW                             | -1.0 | 28  | V    |
| Output voltage   | PG, LDO                        | -0.3 | 6   | V    |
| Output voltage   | VCC                            | 0    | 6   | V    |
| Voltage          | PGND, AGND                     | -0.3 | 0.3 | V    |
| T <sub>J</sub>   | Operating junction temperature | -40  | 150 | °C   |
| T <sub>stg</sub> | Storage temperature            | -55  | 150 | °C   |

- (1) Operation outside the Absolute Maximum Ratings may cause permanent device damage. Absolute Maximum Ratings do not imply functional operation of the device at these or any other conditions beyond those listed under Recommended Operating Conditions. If used outside the Recommended Operating Conditions but within the Absolute Maximum Ratings, the device may not be fully functional, and this may affect device reliability, functionality, performance, and shorten the device lifetime.

### 6.2 ESD Ratings

|                    |                         |   | VALUE | UNIT |
|--------------------|-------------------------|---|-------|------|
| V <sub>(ESD)</sub> | Electrostatic discharge | Human-body model (HBM), per ANSI/ESDA/JEDEC JS-001 <sup>(1)</sup>     | ±2000 | V    |
|                    |                         | Charged device model (CDM), per ANSI/ESDA/JEDEC JS-002 <sup>(2)</sup> | ±500  |      |

- (1) JEDEC document JEP155 states that 500-V HBM allows safe manufacturing with a standard ESD control process.  
 (2) JEDEC document JEP157 states that 250-V CDM allows safe manufacturing with a standard ESD control process.

### 6.3 Recommended Operating Conditions

Over operating junction temperature range (unless otherwise noted)

|                      |                                | MIN  | NOM | MAX  | UNIT |
|----------------------|--------------------------------|------|-----|------|------|
| Input voltage range  | VIN                            | 4.5  |     | 24   | V    |
| Input voltage range  | VBST                           | -0.1 |     | 29.5 | V    |
| Input voltage range  | VBST – SW                      | -0.1 |     | 5.5  | V    |
| Input voltage range  | EN, FB, MODE, VOUT             | -0.3 |     | 5.5  | V    |
| Output voltage range | SW                             | -1.0 |     | 24   | V    |
| Output voltage range | PG, VCC, LDO                   | -0.1 |     | 5.5  | V    |
| Output current range | I <sub>OUT</sub>               |      |     | 8    | A    |
| LDO output current   | LDO (V <sub>VIN</sub> ≥ 5.2 V) |      |     | 100  | mA   |
| T <sub>J</sub>       |                                | -40  |     | 125  | °C   |

### 6.4 Thermal Information

| THERMAL METRIC <sup>(1)</sup> |  | DEVICE            |                               | UNIT |
|-------------------------------|--|-------------------|-------------------------------|------|
|                               |  | RJNR (QFN, JEDEC) | RJNR (QFN, TI EVM)            |      |
|                               |  | 12 PINS           | 12 PINS                       |      |
| R <sub>θJA</sub>              | Junction-to-ambient thermal resistance     | 72.7              | 37.2                          | °C/W |
| R <sub>θJC(top)</sub>         | Junction-to-case (top) thermal resistance  | 50.1              | Not Applicable <sup>(2)</sup> | °C/W |
| R <sub>θJB</sub>              | Junction-to-board thermal resistance       | 18.7              | Not Applicable <sup>(2)</sup> | °C/W |
| ψ <sub>JT</sub>               | Junction-to-top characterization parameter | 1.8               | 3.7                           | °C/W |

## 6.4 Thermal Information (continued)

| THERMAL METRIC <sup>(1)</sup> |  | DEVICE            |                    | UNIT |
|-------------------------------|--|-------------------|--------------------|------|
|                               |  | RJNR (QFN, JEDEC) | RJNR (QFN, TI EVM) |      |
|                               |  | 12 PINS           | 12 PINS            |      |
| $\Psi_{JB}$                   | Junction-to-board characterization parameter | 18.4              | 18.5               | °C/W |

- (1) For more information about traditional and new thermal metrics, see the [Semiconductor and IC Package Thermal Metrics](#) application report.
- (2) The thermal simulation setup is not applicable to a TI EVM layout.

## 6.5 Electrical Characteristics

MODE connected to AGND,  $V_{EN} = 3.3V$ ;  $T_J = -40^{\circ}C$  to  $+125^{\circ}C$ , Typical values are at  $T_J = 25^{\circ}C$  and  $V_{VIN} = 12V$  (unless otherwise noted)

| PARAMETER                               |                                      | TEST CONDITIONS  | MIN   | TYP  | MAX   | UNIT       |
|---|--------------------------------------|--|-------|------|-------|------------|
| <b>INPUT SUPPLY (VIN)</b>               |                                      |  |       |      |       |            |
| VIN                                     | Input voltage range                  | VIN  | 4.5   |      | 24    | V          |
| $I_{VIN}$                               | VIN Supply Current (Quiescent)       | $V_{VIN} = 12V$ , No load, $V_{EN} = 3.3V$ , non-switching |       | 80   |       | $\mu A$    |
| $I_{INSDN}$                             | VIN Shutdown Current                 | $V_{VIN} = 12V$ , No load, $V_{EN} = 0V$ , PG open         |       | 55   |       | $\mu A$    |
| <b>UVLO</b>                             |                                      |  |       |      |       |            |
| $V_{VCC\ UVLO\_R}$                      | $V_{CC}$ Under-Voltage Lockout       | $V_{VCC}$ rising   |       | 4.2  | 4.42  | V          |
| $V_{VCC\ UVLO\_F}$                      | $V_{CC}$ Under-Voltage Lockout       | $V_{VCC}$ falling  | 3.65  | 3.85 |       | V          |
| $V_{VCC\ UVLO\_H}$                      | $V_{CC}$ Under-Voltage Lockout       | Hysteresis $V_{CC}$ voltage                                |       | 450  | 650   | mV         |
| <b>ENABLE (EN), MODE</b>                |                                      |  |       |      |       |            |
| $V_{EN\_R}$                             | EN Threshold High-level              | $V_{EN}$ rising  |       | 1.31 | 1.5   | V          |
| $V_{EN\_F}$                             | EN Threshold Low-level               | $V_{EN}$ falling   | 1.0   | 1.13 |       | V          |
| $V_{EN\_H}$                             | EN Threshold Low-level               | Hysteresis   |       | 180  |       | mV         |
| $I_{EN}$                                | EN Pull down Current                 | $V_{EN} = 0.8V$  | 1.3   | 2.3  |       | $\mu A$    |
| $V_{IL,MODE}$                           | Low-Level Input Voltage at MODE Pin  |  | 0.4   |      |       | V          |
| $V_{IH,MODE}$                           | High-Level Input Voltage at MODE Pin |  |       |      | 0.8   | V          |
| $I_{MODE}$                              | MODE Pull down Current               | $V_{MODE} = 0.8V$  | 1.3   | 2.3  | 3.5   | $\mu A$    |
| <b>VCC</b>                              |                                      |  |       |      |       |            |
| $V_{VCC}$                               | VCC Output Voltage                   | $V_{VIN} > 5.2V$ , $I_{VCC} \leq 1mA$                      | 4.85  | 5    | 5.15  | V          |
| <b>OUTPUT VOLTAGE (VOUT)</b>            |                                      |  |       |      |       |            |
| $V_{VOUT}$                              | VOUT voltage (TPS51384)              | $T_J = 25^{\circ}C$  | 1.802 | 1.82 | 1.838 | V          |
|   | VOUT Voltage (TPS51384)              | $-40^{\circ}C \leq T_J \leq 125^{\circ}C$                  | 1.788 | 1.82 | 1.852 | V          |
| $V_{VOUT}$                              | VOUT Voltage (TPS51383)              | $T_J = 25^{\circ}C$  | 3.326 | 3.36 | 3.394 | V          |
|   | VOUT Voltage (TPS51383)              | $-40^{\circ}C \leq T_J \leq 125^{\circ}C$                  | 3.30  | 3.36 | 3.42  | V          |
| <b>DUTY CYCLE and FREQUENCY CONTROL</b> |                                      |  |       |      |       |            |
| $f_{sw}$                                | Switching frequency                  | CCM operation  | 480   | 600  | 720   | kHz        |
| $t_{ON(min)}$                           | Minimum ON pulse width               | $T_J = 25^{\circ}C$  |       | 65   | 75    | ns         |
| $t_{OFF(min)}$                          | Minimum OFF pulse width              | $T_J = 25^{\circ}C$  |       |      | 190   | ns         |
| $t_{OOA}$                               | OOA operation period                 | $V_{MODE} = V_{VCC}$                                       |       | 30   | 50    | $\mu s$    |
| <b>SOFT-START</b>                       |                                      |  |       |      |       |            |
| $t_{SS}$                                | Internal fixed softstart             |  | 0.55  | 1    | 1.35  | ms         |
| <b>POWER SWITCHES (SW)</b>              |                                      |  |       |      |       |            |
| $R_{DS(on)(HS)}$                        | High-side MOSFET on-resistance       | $T_J = 25^{\circ}C$  |       | 22   |       | m $\Omega$ |
| $R_{DS(on)(LS)}$                        | Low-side MOSFET on-resistance        | $T_J = 25^{\circ}C$  |       | 11   |       | m $\Omega$ |
| <b>BOOT CIRCUIT</b>                     |                                      |  |       |      |       |            |
| <b>CURRENT LIMIT</b>                    |                                      |  |       |      |       |            |
| $I_{OCL}$                               | Low-side valley current limit        | Valley current limit on LS FET                             | 9.5   | 11   | 12.5  | A          |
| $I_{NOCL}$                              | Low-side negative current limit      | Sinking current limit on LS FET                            |       | 3.9  |       | A          |

## 6.5 Electrical Characteristics (continued)

MODE connected to AGND,  $V_{EN} = 3.3V$ ;  $T_J = -40^{\circ}C$  to  $+125^{\circ}C$ , Typical values are at  $T_J = 25^{\circ}C$  and  $V_{VIN} = 12V$  (unless otherwise noted)

| PARAMETER   |   | TEST CONDITIONS   | MIN   | TYP | MAX   | UNIT        |
|---|---|---|-------|-----|-------|-------------|
| <b>OUTPUT UNDERVOLTAGE AND OVERVOLTAGE PROTECTION</b> |   |   |       |     |       |             |
| $V_{OVP}$   | OVP Trip Threshold                            |   | 117   | 120 | 123   | %           |
| $t_{OVPDLY}$  | OVP Prop deglitch                             |   |       | 20  |       | $\mu s$     |
| $t_{OVPDLY}$  | OVP latch-off Prop deglitch                   |   |       | 256 |       | $\mu s$     |
| $V_{UVP}$   | UVP Trip Threshold                            |   | 55    | 60  | 65    | %           |
| $t_{UVPDLY}$  | UVP Prop deglitch                             |   |       | 256 |       | $\mu s$     |
| <b>POWER GOOD (PG)</b>                                |   |   |       |     |       |             |
| $t_{PGDLY}$   | PG Start-Up delay                             | PG from low to high   |       | 500 |       | $\mu s$     |
| $t_{PGDLY}$   | PG delay time when $V_{FB}$ rising (fault)    | PG from high to low   |       | 20  |       | $\mu s$     |
| $t_{PGDLY}$   | PG delay time when $V_{FB}$ falling (fault)   | PG from high to low   |       | 28  |       | $\mu s$     |
| $V_{PGTH}$  | PG Threshold when $V_{FB}$ falling (fault)    | $V_{FB}$ falling (fault), percentage of $V_{FB}$                            | 79    | 85  | 89    | %           |
| $V_{PGTH}$  | PG Threshold when $V_{FB}$ rising (good)      | $V_{FB}$ rising (good), percentage of $V_{FB}$                              | 86    | 90  | 94    | %           |
| $V_{PGTH}$  | PG Threshold when $V_{FB}$ rising (fault)     | $V_{FB}$ rising (fault), percentage of $V_{FB}$                             | 116   | 120 | 124   | %           |
| $V_{PGTH}$  | PG Threshold when $V_{FB}$ falling (good)     | $V_{FB}$ falling (good), percentage of $V_{FB}$                             | 109   | 115 | 119   | %           |
| $I_{PGMAX}$   | PG Sink Current                               | $V_{PG} = 0.5V$   |       | 50  |       | mA          |
| $I_{PGLK}$  | PG Leak Current                               | $V_{PG} = 5.5V$   |       |     | 1     | $\mu A$     |
| <b>OUTPUT DISCHARGE</b>                               |   |   |       |     |       |             |
| $R_{DIS}$   | Discharge resistance                          | $T_J = 25^{\circ}C$ , $V_{EN} = 0V$   |       | 160 |       | $\Omega$    |
| <b>SWITCH-OVER LDO OUTPUT (LDO)</b>                   |   |   |       |     |       |             |
| $V_{LDO}$   | LDO output voltage (TPS51383)                 | $V_{EN} = 0V$ , $V_{IN} \geq 4.5V$  | 3.24  | 3.3 | 3.36  | V           |
| $V_{LDO}$   | LDO output voltage (TPS51384)                 | $V_{EN} = 0V$ , $V_{IN} \geq 4.5V$  | 1.767 | 1.8 | 1.832 | V           |
| $V_{LOADREG}$   | LDO load regulation                           | $V_{EN} = 0V$ , $I_{LDO} = 80mA$ , $V_{IN} \geq 5.2V$                       | -0.5  |     | 0.5   | %           |
| $I_{LDO}$   | LDO current limit                             | $V_{EN} = 0V$ , $V_{IN} \geq 5.2V$  | 100   | 170 | 240   | mA          |
| $R_{LDOSW}$   | VOUT switch-over FET on resistance (TPS51383) | $V_{VIN} \geq 5.2V$ , $V_{EN} = 3.3V$ , $V_{OUT} = 3.3V$ , $I_{LDO} = 50mA$ |       | 0.8 | 2.1   | $\Omega$    |
| $R_{LDOSW}$   | VOUT switch-over FET on resistance (TPS51384) | $V_{VIN} \geq 5.2V$ , $V_{EN} = 3.3V$ , $V_{OUT} = 1.8V$ , $I_{LDO} = 50mA$ |       | 0.5 | 1     | $\Omega$    |
| $R_{LDOSW}$   | VOUT switch-over FET on resistance (TPS51383) | $V_{VIN} = 4.5V$ , $V_{EN} = 3.3V$ , $V_{OUT} = 3.3V$ , $I_{LDO} = 50mA$    |       | 1.7 | 2.65  | $\Omega$    |
| $R_{LDOSW}$   | VOUT switch-over FET on resistance (TPS51384) | $V_{VIN} = 4.5V$ , $V_{EN} = 3.3V$ , $V_{OUT} = 1.8V$ , $I_{LDO} = 50mA$    |       | 0.6 | 1.3   | $\Omega$    |
| $V_{BYPON}$   | VOUT switch-over turn on voltage              | $V_{EN} = 3.3V$   |       | 98  |       | %           |
| $V_{BYPOFF}$  | VOUT switch-over turn off voltage             | $V_{EN} = 3.3V$   |       | 96  |       | %           |
| <b>THERMAL SHUTDOWN</b>                               |   |   |       |     |       |             |
| $T_{J(SD)}$   | Thermal shutdown threshold                    |   |       | 165 |       | $^{\circ}C$ |
| $T_{J(HYS)}$  | Thermal shutdown hysteresis <sup>(1)</sup>    |   |       | 20  |       | $^{\circ}C$ |

- (1) These parameters are provided for reference only, and do not constitute part of TI's published device specifications for purposes of TI's product warranty.

## 6.6 Typical Characteristics

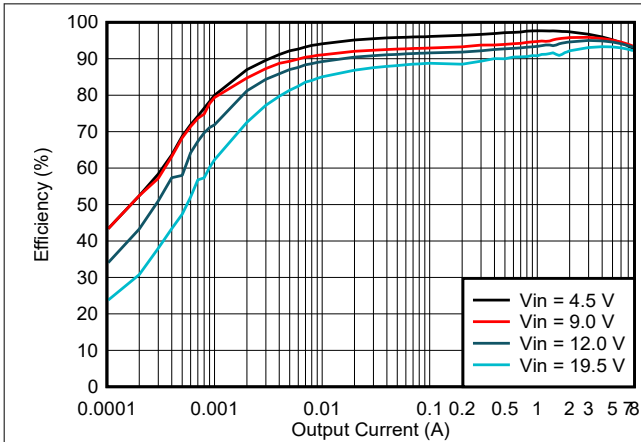

Figure 6-1. TPS51383 PSM Efficiency

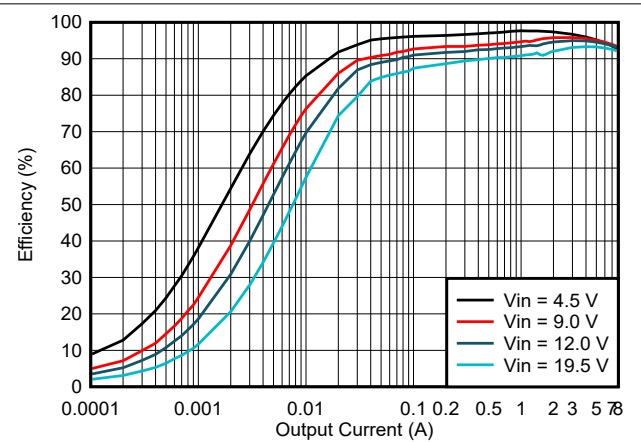

Figure 6-2. TPS51383 OOA Efficiency

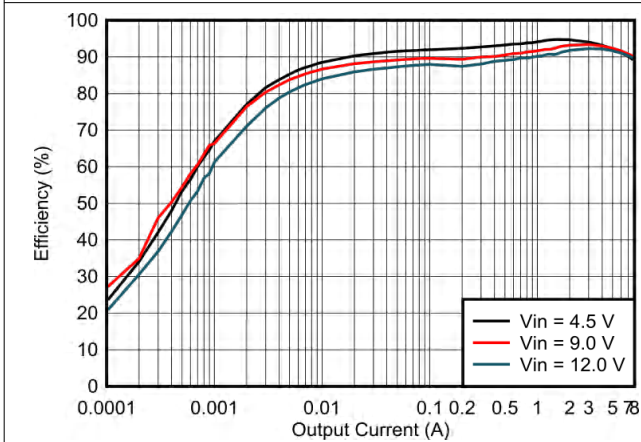

Figure 6-3. TPS51384 PSM Efficiency

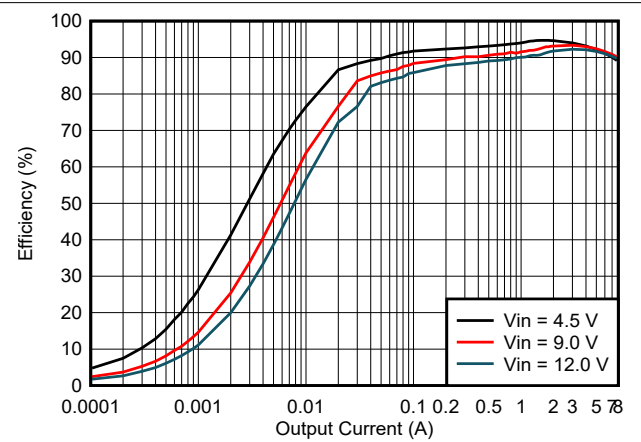

Figure 6-4. TPS51384 OOA Efficiency

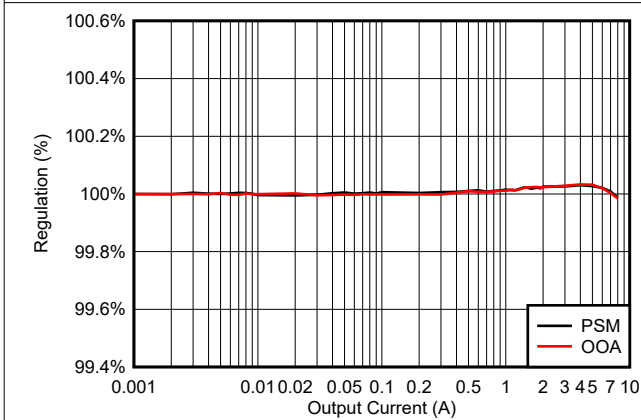

Figure 6-5. TPS51383 Load Regulation

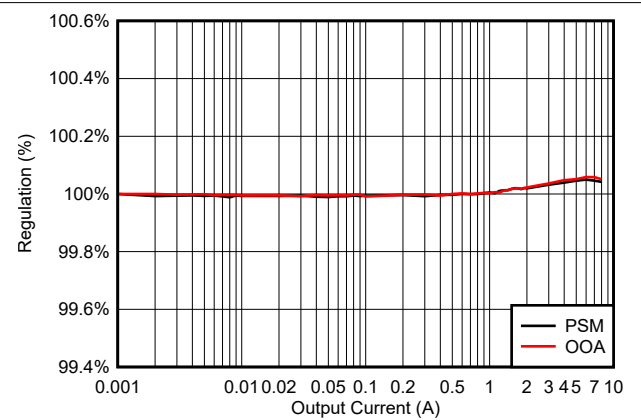

Figure 6-6. TPS51384 Load Regulation

## 6.6 Typical Characteristics (continued)

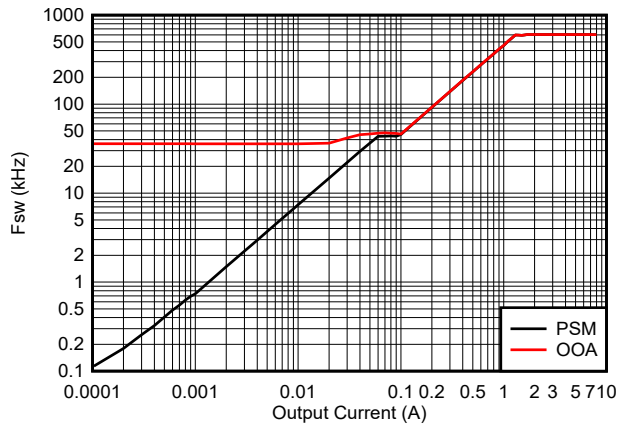

Figure 6-7. TPS51383 Fsw vs Iout

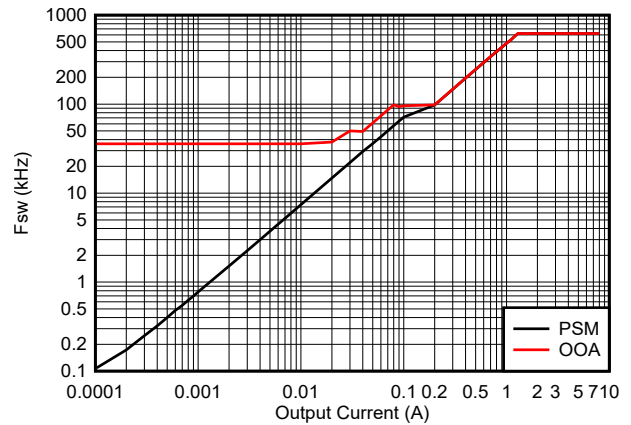

Figure 6-8. TPS51384 Fsw vs Iout

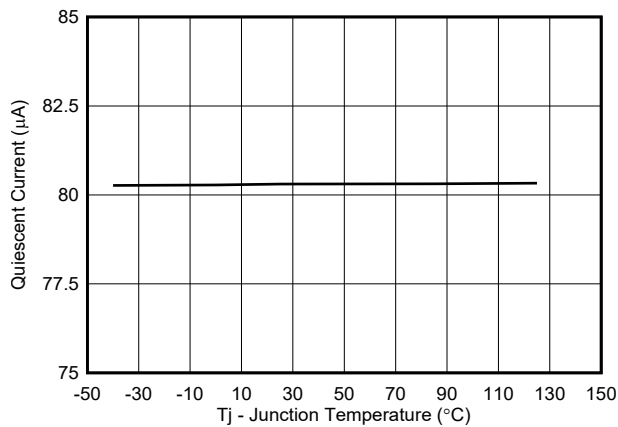

Figure 6-9. Quiescent Current vs Temperature

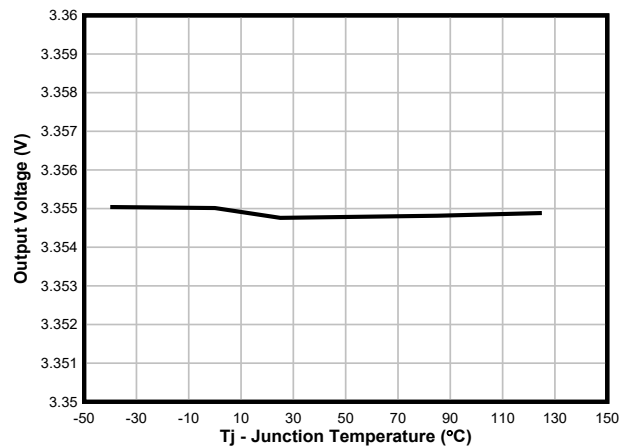

Figure 6-10. Output Voltage vs Temperature

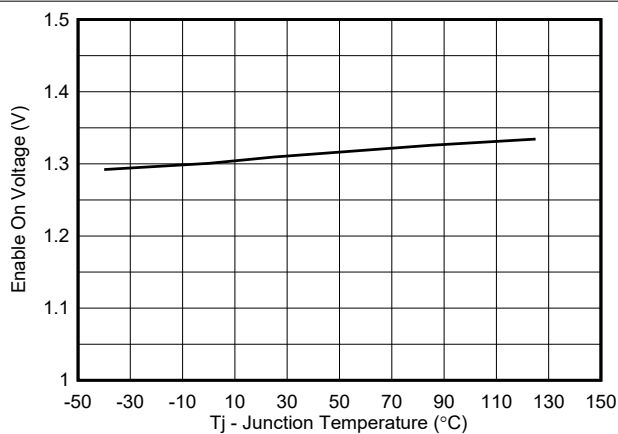

Figure 6-11. Enable On Voltage vs Temperature

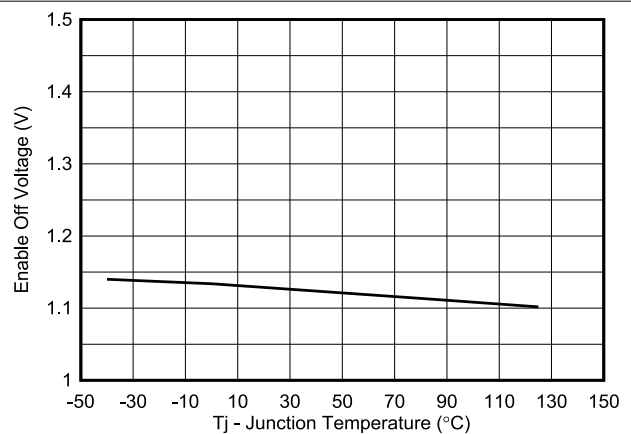
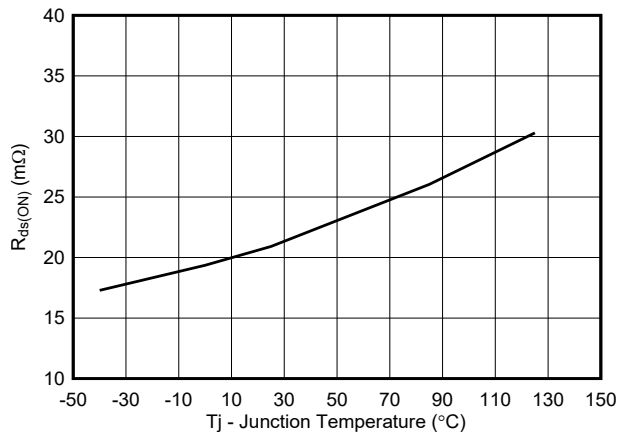

Figure 6-12. Enable Off Voltage vs Temperature



## 6.6 Typical Characteristics (continued)



**Figure 6-13. High-side  $R_{DS(on)}$  vs Temperature**

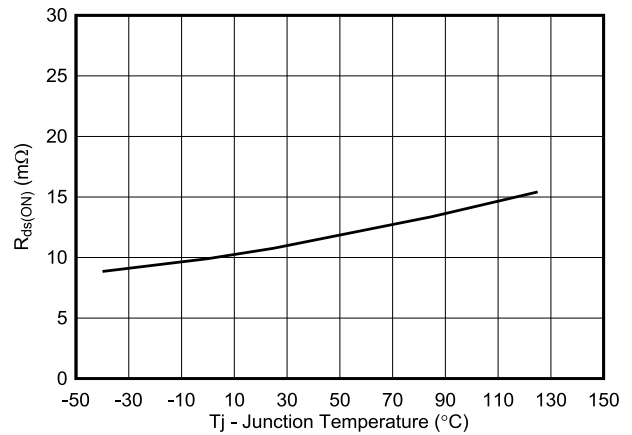

**Figure 6-14. Low-side  $R_{DS(on)}$  vs Temperature**

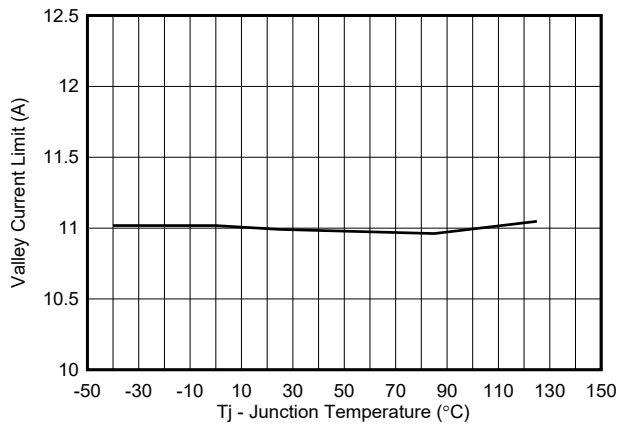

**Figure 6-15. Valley Current Limit vs Temperature**

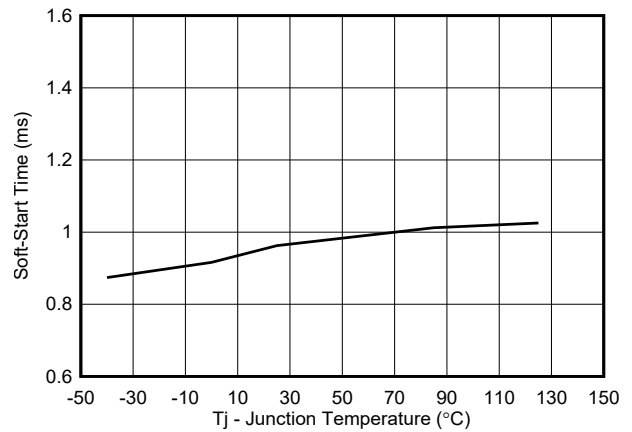

**Figure 6-16. Soft-Start Time vs Temperature**

## 7 Detailed Description

### 7.1 Overview

The TPS51383 and TPS51384 are synchronous step-down buck converters that can operate from 4.5-V to 24-V input voltage ( $V_{IN}$ ). TPS51383 features fixed 3.36-V output, and TPS51384 features fixed 1.82-V output. Both devices have integrated 22-m $\Omega$  and 11-m $\Omega$  integrated MOSFETs enable high efficiency up to 8-A output current. D-CAP3 control mode provides fast transient response without external compensation components and an accurate feedback voltage. The D-CAP3 control mode topology also provides seamless transition between CCM operating mode at higher load condition and DCM operation at lighter load condition. DCM allows the TPS51383 and TPS51384 to maintain high efficiency at light loads, and Out Of Audio (OOA) function maintains a minimum of 25-kHz switching frequency that is above audible range (20 Hz – 20 kHz). D-CAP3 control mode allow the use of low equivalent series resistance (ESR) output capacitors such as POSCAP or SP-CAP, and ultra-low ESR ceramic capacitors.

The TPS51383 and TPS51384 have 5-V internal VCC LDO that creates bias for all internal circuitry. The undervoltage lockout (UVLO) circuit monitors the VCC pin voltage to protect the internal circuitry from low input voltages. Both devices have an internal pulldown current source on the EN pin, require external pullup circuit to enable buck converter. Both devices feature MODE pin dynamic change, which allows the device to change state between OOA Mode and PSM Mode dynamically by toggling MODE pin high or low. TPS51383 and TPS51384 have fixed 600-kHz switching frequency and fixed 1-ms soft start.

TPS51383 features 3.36-V fixed output and a build in 3.3-V, 100-mA LDO. TPS51384 features 1.82-V fixed output and a build in 1.8-V, 100-mA LDO. The LDO is designed for powering external circuits that require constant power even when switching regulator is off ( $V_{in} > UVLO$ , EN = LOW). When the buck converter is ready, PGood is pulled high, and the buck output replaces the LDO output.

### 7.2 Functional Block Diagram

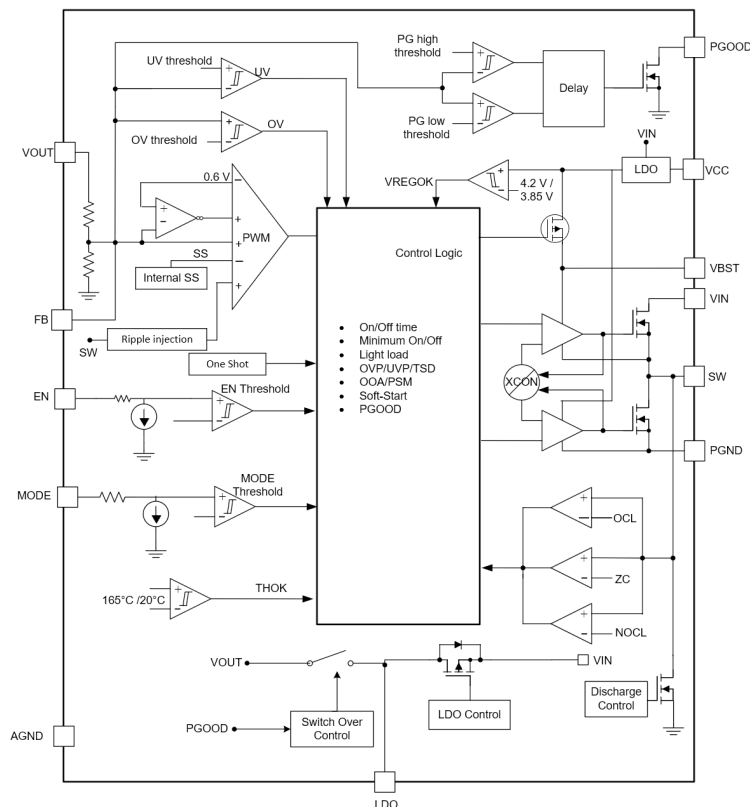

## 7.3 Feature Description

### 7.3.1 PWM Operation and D-CAP3™ Control Mode

The TPS51383 and TPS51384 operates using the adaptive on-time PWM control with a proprietary D-CAP3 control mode which enables low external component count with a fast load transient response while maintaining a good output voltage accuracy. At the beginning of each switching cycle, the high side MOSFET is turned on for an on-time set by an internal one shot timer. This on-time is set based on the converter input voltage, output voltage, and the pseudo-fixed frequency hence this type of control topology is called an adaptive on-time control. The one shot timer resets and turns on again after the feedback voltage ( $V_{FB}$ ) falls below the internal reference voltage ( $V_{REF}$ ). An internal ramp is generated which is fed to the FB pin to simulate the output voltage ripple. This action enables the use of very low-ESR output capacitors such as multi-layered ceramic caps (MLCC). No external current sense network or loop compensation is required for D-CAP3 control mode topology.

The TPS51383 and TPS51384 includes an error amplifier that makes the output voltage very accurate. For any control topology that is compensated internally, there is a range of the output filter it can support. The output filter used is a low pass L-C circuit. This L-C filter has double pole that is described in the following equation.

$$f_P = \frac{1}{2 \times \pi \times \sqrt{L_{OUT} \times C_{OUT}}} \quad (1)$$

At low frequencies, the overall loop gain is set by the output set-point resistor divider network and the internal gain. The low frequency L-C double pole has a 180 degree in phase. At the output filter frequency, the gain rolls off at a  $-40\text{dB}$  per decade rate and the phase drops rapidly. The internal ripple generation network introduces a high-frequency zero that reduces the gain roll off from  $-40\text{dB}$  to  $-20\text{dB}$  per decade and increases the phase to 90 degree one decade above the zero frequency. The internal ripple injection high frequency zero is optimized to provide fast transient response performance and also give an consideration to meet the stability requirement with typical external L-C filter. The inductor and capacitor selected for the output filter must be such that the double pole is located close enough to the high-frequency zero so that the phase boost provided by this high-frequency zero provides adequate phase margin for the stability requirement. The crossover frequency of the overall system must usually be targeted to be less than one-fifth of the switching frequency ( $F_{SW}$ ).

### 7.3.2 VCC LDO

The VCC pin is the output of the internal 5.0-V linear regulator that creates the bias for all the internal circuitry and MOSFET gate drivers. The VCC pin must be bypassed with a minimum 1- $\mu\text{F}$ , 10-V X5R rated capacitor. The UVLO circuit monitors the VCC pin voltage and disables the output when VCC falls below the UVLO threshold.

### 7.3.3 Soft Start

TPS51383 and TPS51384 feature fixed internal 1-ms softstart. When the EN pin becomes high, the internal soft-start function begins ramping up the reference voltage to the PWM comparator.

If the output capacitor is pre-biased at start-up, the device initiates switching and starts ramping up only after the internal reference voltage becomes greater than the feedback voltage  $V_{FB}$ . This scheme ensures that the converters ramp up smoothly into regulation point.

### 7.3.4 Enable Control

The EN pin controls the turn-on and turn-off of the device. When EN pin voltage is above the turn-on threshold which is around 1.31 V, the device starts switching and when the EN pin voltage falls below the turn-off threshold which is around 1.13V it stops switching.

### 7.3.5 Power Good

The Power Good (PGOOD) pin is an open drain output. After the FB pin voltage is between 90% and 115% of the internal reference voltage ( $V_{REF}$ ) the PGOOD is de-asserted and floats after a 500- $\mu\text{s}$  de-glitch time. TI recommends a pullup resistor of 100 k $\Omega$  to pull it up to VCC. The PGOOD pin is pulled low when the FB pin voltage is lower than  $V_{UVP}$  or greater than  $V_{OVP}$  threshold or in an event of thermal shutdown or during the soft-start period.

### 7.3.6 Overcurrent Protection and Undervoltage Protection

The output overcurrent limit (OCL) is implemented using a cycle-by-cycle valley detect control circuit. The switch current is monitored during the OFF state by measuring the low-side FET drain to source voltage. This voltage is proportional to the switch current. During the on time of the high-side FET switch, the switch current increases at a linear rate determined by input voltage, output voltage, the on-time and the output inductor value. During the on time of the low-side FET switch, this current decreases linearly. The average value of the switch current is the load current  $I_{OUT}$ . If the measured drain to source voltage of the low-side FET is above the voltage proportional to current limit, the low side FET stays on until the current level becomes lower than the OCL level which reduces the output current available. When the current is limited the output voltage tends to drop because the load demand is higher than what the converter can support. When the output voltage falls below 60% of the target voltage, the UVP comparator detects it and shuts down the device after a wait time of 256  $\mu$ s. In this type of valley detect control, the load current is higher than the OCL threshold by one half of the peak to peak inductor ripple current. This protection is a latch function, fault latching can be re-set by EN going low or VIN power cycling.

### 7.3.7 100-mA LDO with Switch Over

TPS51383 includes a 3.3-V, 100-mA standby linear regulator. TPS51384 includes a 1.8-V, 100-mA standby linear regulator. The 100-mA LDO is intended mainly as an auxiliary supply for the notebook system during standby mode. When the Buck converter output voltage becomes higher than 98% of  $V_{OUT}$  and the PGOOD is high, the internal LDO is switched over to  $V_{OUT}$  by the internal MOSFET. This action helps reduce the power loss from the LDO. The LDO pin must be bypassed with a 10-V, X5R rated or better ceramic capacitor with minimum 4.7- $\mu$ F capacitance, placed as close to the LDO pin as possible.

### 7.3.8 UVLO Protection

Undervoltage Lock Out protection (UVLO) monitors the internal VCC regulator voltage. When the VCC voltage is lower than UVLO threshold voltage, the device is shut off. This protection is non-latching.

### 7.3.9 Overvoltage Protection

TPS51383 and TPS51384 detect overvoltage and undervoltage conditions by monitoring the feedback voltage (VFB). When the feedback voltage becomes higher than 120% of the target voltage, the OVP comparator output goes high and output is discharged after a wait time of 20  $\mu$ s. When the OV fault comparator has been tripped for 256  $\mu$ s, the part latches off. When the overvoltage condition is removed, output remains latched until EN is toggled to low then high, or the power cycling VIN.

### 7.3.10 Output Voltage Discharge

TPS51383 and TPS51384 have a 160-ohm discharge switch that discharges the output  $V_{OUT}$  through the Vout pin during any event of fault like output overvoltage, output undervoltage, TSD, or if VCC voltage is below the UVLO and when the EN pin voltage ( $V_{EN}$ ) is below the turn-on threshold.

### 7.3.11 Thermal Shutdown

The device monitors the internal die temperature. If this temperature exceeds the thermal shutdown threshold value ( $T_{SDN}$  typically 165°C) the device shuts off. This protection is a non-latch protection. The device re-starts switching when the temperature goes below the thermal shutdown threshold and 20°C hysteresis.

## 7.4 Device Functional Modes

### 7.4.1 MODE Pin

TPS51383 and TPS51384 have a MODE pin that can be used to toggle mode of the device by pulling it high (> 0.8 V) or low (< 0.4 V). When the MODE pin is pulled high, it enables the converter to operate in Out-of-Audio™ (OOA) mode. When the MODE pin is pulled low or float, the converter goes into Power Save Mode (PSM). The MODE pin can be toggled dynamically, even when the converter is in operation.

### **7.4.2 Out-Of-Audio™ Mode**

Out-of-Audio (OOA) mode is a unique control feature that maintains minimum switching frequency of 25 kHz at light load conditions where regular discontinuous conduction mode cause switching frequency to drop into audible range (20 Hz – 20 kHz), to prevent switching frequency to be audible.

### **7.4.3 Power Save Mode (PSM)**

The TPS51383 and TPS51384 can be placed in power save mode by floating the MODE pin or pulling the MODE pin low (< 0.4 V).

## 8 Application and Implementation

### Note

Information in the following applications sections is not part of the TI component specification, and TI does not warrant its accuracy or completeness. TI's customers are responsible for determining suitability of components for their purposes, as well as validating and testing their design implementation to confirm system functionality.

### 8.1 Application Information

The schematic shows a typical application for TPS51383. This design converts an input voltage range of 4.5 V to 24 V down to 3.36 V with a maximum output current of 8 A.

### 8.2 Typical Application

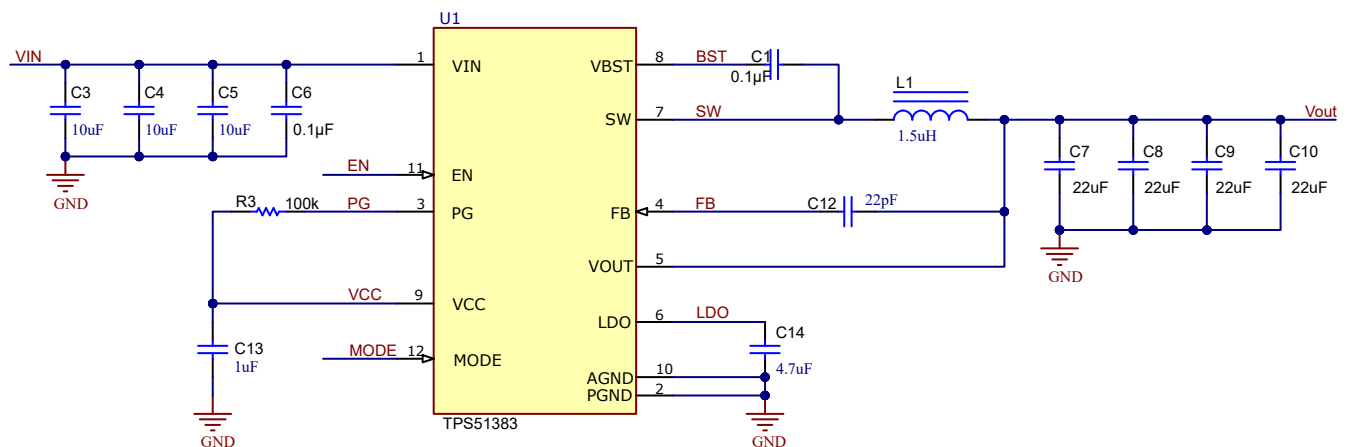

Figure 8-1. Application Schematic

#### 8.2.1 Design Requirements

Table 8-1. Design Parameters

| PARAMETER         | CONDITIONS            | MIN            | TYP  | MAX | UNIT                |
|-------------------|-----------------------|----------------|------|-----|---------------------|
| $V_{OUT}$         | Output voltage        |                | 3.36 |     | V                   |
| $I_{OUT}$         | Output current        |                |      | 8   | A                   |
| $V_{IN}$          | Input voltage         | 4.5            | 19   | 24  | V                   |
| $V_{OUT(ripple)}$ | Output voltage ripple |                | 24   |     | mV <sub>(P-P)</sub> |
| $F_{SW}$          | Switching frequency   |                | 600  |     | kHz                 |
| Operating Mode    |                       | Float MODE pin | PSM  |     |                     |
| $T_A$             | Ambient temperature   |                | 25   |     | °C                  |

#### 8.2.2 Detailed Design Procedure

##### 8.2.2.1 External Component Selection

###### 8.2.2.1.1 Inductor Selection

The inductor ripple current is filtered by the output capacitor. A higher inductor ripple current means the output capacitor must have a ripple current rating higher than the inductor ripple current. See [Table 8-2](#) for recommended inductor values.

The RMS and peak currents through the inductor can be calculated using [Equation 2](#) and [Equation 3](#). Make sure that the inductor is rated to handle these currents.

$$I_{L(\text{rms})} = \sqrt{\left( I_{\text{OUT}}^2 + \frac{1}{12} \times \left( \frac{V_{\text{OUT}} \times (V_{\text{IN}(\text{max})} - V_{\text{OUT}})}{V_{\text{IN}(\text{max})} \times L_{\text{OUT}} \times F_{\text{SW}}} \right)^2 \right)} \quad (2)$$

$$I_{L(\text{peak})} = I_{\text{OUT}} + \frac{I_{\text{OUT}(\text{ripple})}}{2} \quad (3)$$

During transient, short-circuit conditions the inductor current can increase up to the current limit of the device, so choose an inductor with a saturation current higher than the peak current under current limit condition.

#### 8.2.2.1.2 Output Capacitor Selection

After selecting the inductor the output capacitor must be optimized. In D-CAP3 control mode, the regulator reacts within one cycle to the change in the duty cycle so the good transient performance can be achieved without needing large amounts of output capacitance. The recommended output capacitance range is given in [Table 8-2](#)

Ceramic capacitors have very low ESR, otherwise the maximum ESR of the capacitor must be less than  $V_{\text{OUT}(\text{ripple})}/I_{\text{OUT}(\text{ripple})}$

**Table 8-2. Recommended Component Values**

| V <sub>OUT</sub> (V) | C <sub>ff</sub> (pF) | F <sub>sw</sub> (kHz) | L <sub>OUT</sub> (μH) | C <sub>OUT(Range)</sub> (μF) |
|----------------------|----------------------|-----------------------|-----------------------|------------------------------|
| 3.36                 | 22                   | 600                   | 2.2                   | 44-500                       |
|                      |                      | 600                   | 1.5                   | 44-500                       |
| 1.82                 | NA                   | 600                   | 1.5                   | 44-500                       |
|                      |                      | 600                   | 1.0                   | 44-500                       |

#### 8.2.2.1.3 Input Capacitor Selection

The minimum input capacitance required is given in [Equation 4](#).

$$C_{\text{IN}(\text{min})} = \frac{I_{\text{OUT}} \times V_{\text{OUT}}}{V_{\text{IN}(\text{ripple})} \times V_{\text{IN}} \times F_{\text{SW}}} \quad (4)$$

TI recommends using a high quality X5R or X7R input decoupling capacitors of 22 μF on the input voltage pin. The voltage rating on the input capacitor must be greater than the maximum input voltage. The capacitor must also have a ripple current rating greater than the maximum input current ripple of the application. The input ripple current is calculated by [Equation 5](#) below:

$$I_{\text{CIN}(\text{rms})} = I_{\text{OUT}} \times \sqrt{\frac{V_{\text{OUT}}}{V_{\text{IN}(\text{min})}} \times \frac{(V_{\text{IN}(\text{min})} - V_{\text{OUT}})}{V_{\text{IN}(\text{min})}}} \quad (5)$$

### 8.2.3 Application Curves

$V_{IN} = 19\text{ V}$ ,  $T_a = 25^\circ\text{C}$  unless otherwise specified.

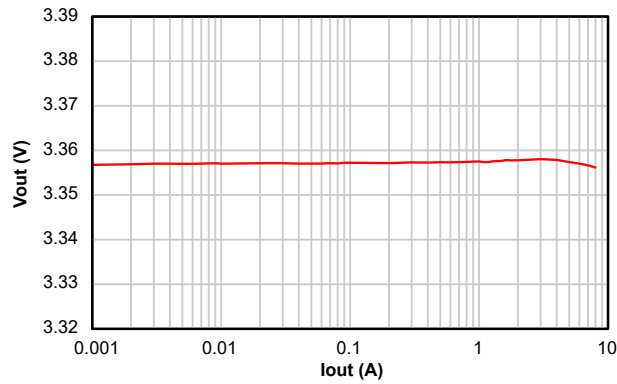

**Figure 8-2. Load Regulation**

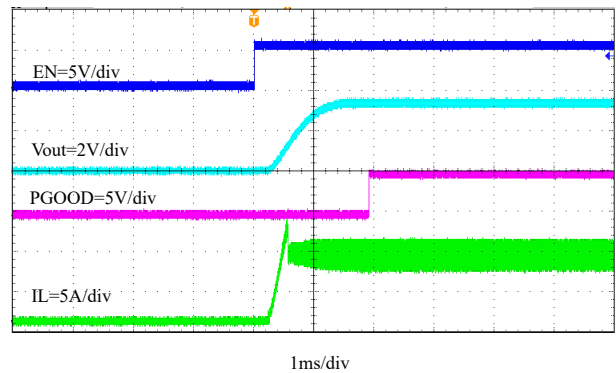

**Figure 8-3. Start-up Relative to EN Rising**

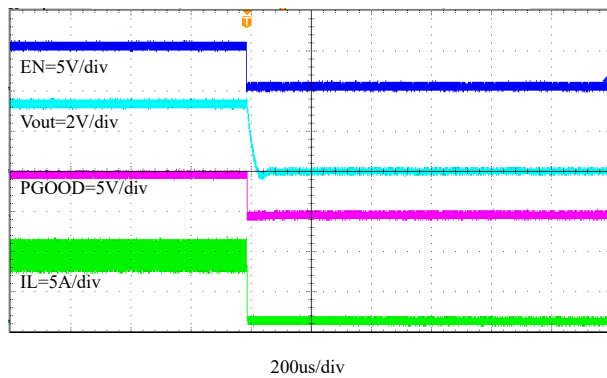

**Figure 8-4. Shutdown Relative to EN Falling**

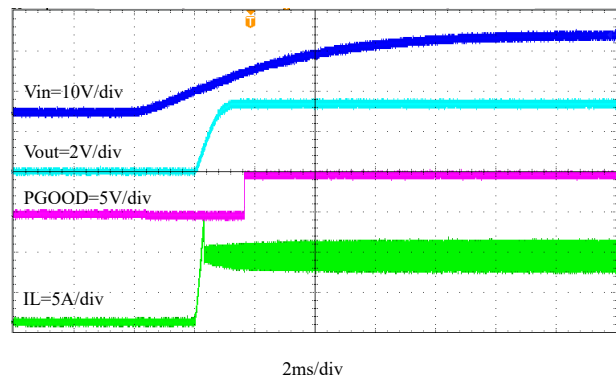

**Figure 8-5. Start-up Relative to Vin Rising**

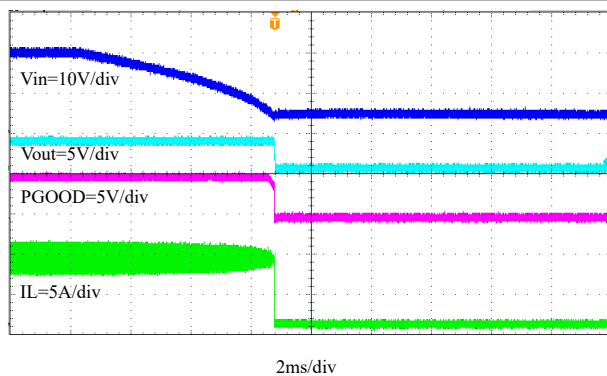

**Figure 8-6. Shutdown Relative to Vin Falling**

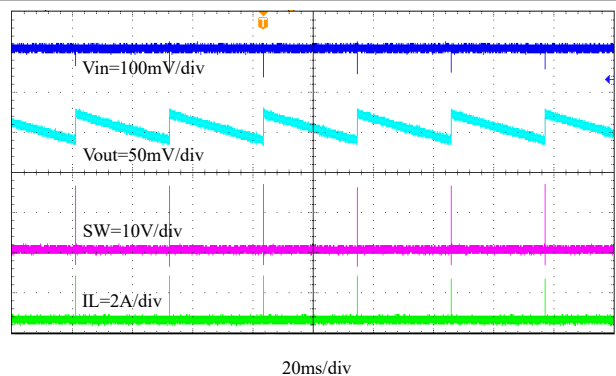

**Figure 8-7. PSM Mode Output Voltage Ripple, I<sub>out</sub> = 0 A**



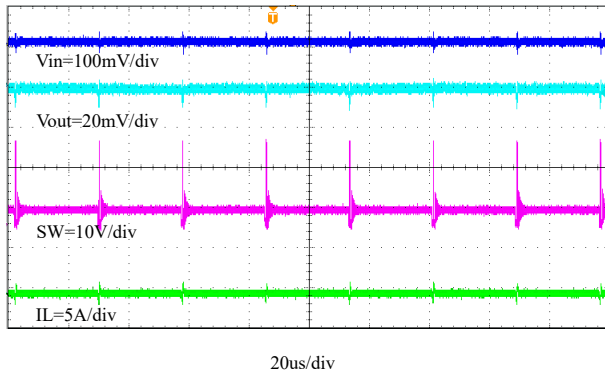

Figure 8-8. OOA Mode Output Voltage Ripple, Iout = 0 A

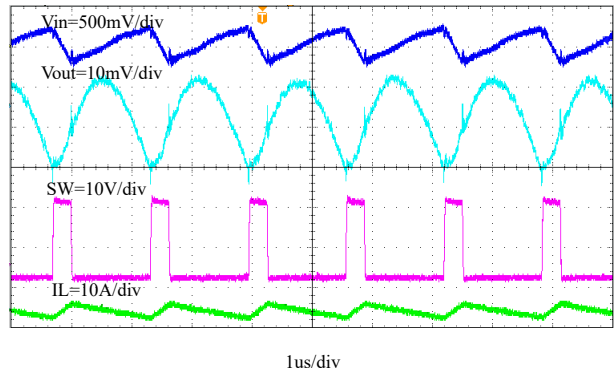

Figure 8-9. Output Voltage Ripple, Iout = 8 A

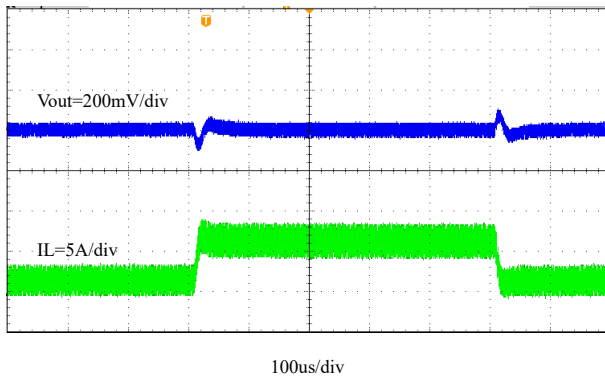

Figure 8-10. Transient Response, 1.6 A to 6.4 A with 2.5 A/us SR

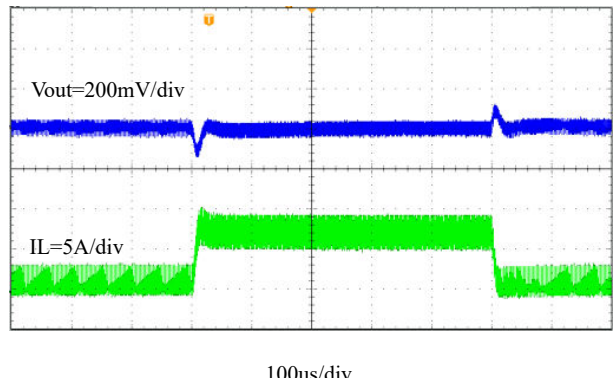

Figure 8-11. Transient Response, 0.8 A to 7.2 A with 2.5 A/us SR

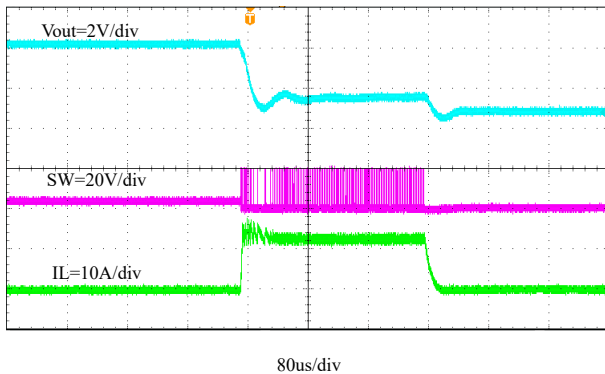

Figure 8-12. Normal Operation to Output Hard Short

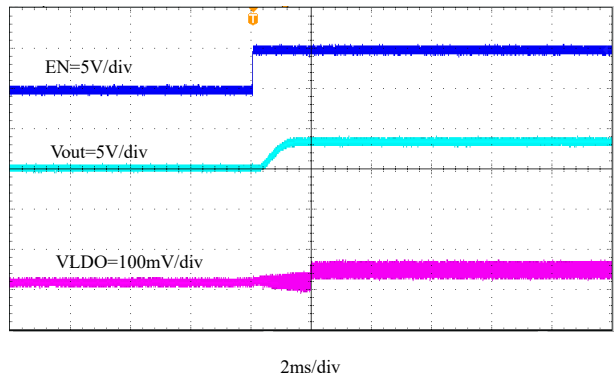

Figure 8-13. LDO Switch Over

### 8.3 Power Supply Recommendations

The TPS51383 and TPS51384 are intended to be powered by a well regulated DC voltage. The input voltage range is 4.5 V to 24 V. TPS51383 and TPS51384 are buck converters. The input supply voltage must be greater than the desired output voltage for proper operation. Input supply current must be appropriate for the desired output current. If the input voltage supply is located far from the TPS51383 and TPS51384 circuit, TI recommends some additional input bulk capacitance. Typical values are 22  $\mu$ F to 88  $\mu$ F.

## 8.4 Layout

### 8.4.1 Layout Guidelines

- Recommend a four-layer PCB for good thermal performance and with maximum ground plane.
- Recommend having a small bypass capacitor on VIN side of the IC. Place the capacitor as close to IC as possible.
- FB and VOUT traces must be routed away from the noisy switch node.
- VIN and VOUT traces must be wide to reduce the trace impedance.

### 8.4.2 Layout Example

Top Side Layout shows the recommended top side layout.

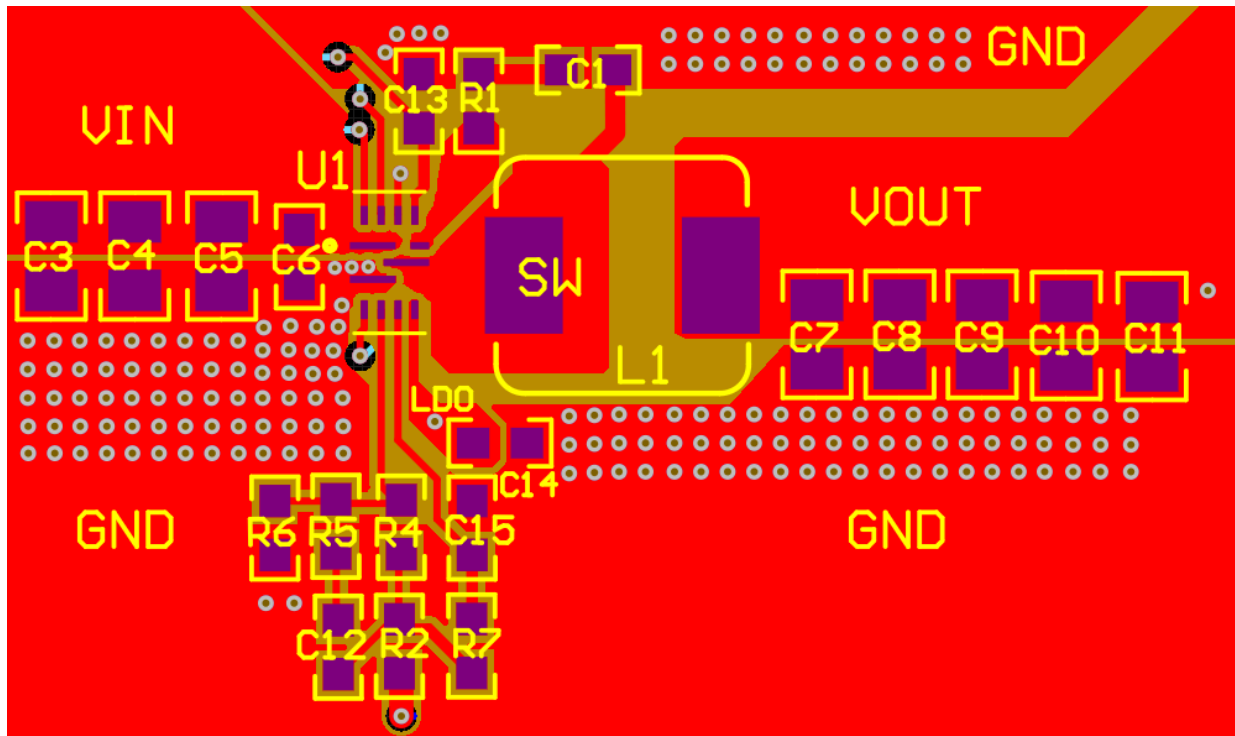

Figure 8-14. Top Side Layout

## 9 Device and Documentation Support

### 9.1 Device Support

#### 9.1.1 Third-Party Products Disclaimer

TI'S PUBLICATION OF INFORMATION REGARDING THIRD-PARTY PRODUCTS OR SERVICES DOES NOT CONSTITUTE AN ENDORSEMENT REGARDING THE SUITABILITY OF SUCH PRODUCTS OR SERVICES OR A WARRANTY, REPRESENTATION OR ENDORSEMENT OF SUCH PRODUCTS OR SERVICES, EITHER ALONE OR IN COMBINATION WITH ANY TI PRODUCT OR SERVICE.

### 9.2 Receiving Notification of Documentation Updates

To receive notification of documentation updates, navigate to the device product folder on [ti.com](http://ti.com). Click on *Subscribe to updates* to register and receive a weekly digest of any product information that has changed. For change details, review the revision history included in any revised document.

### 9.3 Support Resources

[TI E2E™ support forums](#) are an engineer's go-to source for fast, verified answers and design help — straight from the experts. Search existing answers or ask your own question to get the quick design help you need.

Linked content is provided "AS IS" by the respective contributors. They do not constitute TI specifications and do not necessarily reflect TI's views; see TI's [Terms of Use](#).

### 9.4 Trademarks

D-CAP3™, HotRod™, Out-of-Audio™, and TI E2E™ are trademarks of Texas Instruments. All trademarks are the property of their respective owners.

### 9.5 Electrostatic Discharge Caution



This integrated circuit can be damaged by ESD. Texas Instruments recommends that all integrated circuits be handled with appropriate precautions. Failure to observe proper handling and installation procedures can cause damage.

ESD damage can range from subtle performance degradation to complete device failure. Precision integrated circuits may be more susceptible to damage because very small parametric changes could cause the device not to meet its published specifications.

### 9.6 Glossary

[TI Glossary](#) This glossary lists and explains terms, acronyms, and definitions.

## 10 Mechanical, Packaging, and Orderable Information

The following pages include mechanical, packaging, and orderable information. This information is the most current data available for the designated devices. This data is subject to change without notice and revision of this document. For browser-based versions of this data sheet, refer to the left-hand navigation.

**PACKAGING INFORMATION**

| Orderable Device | Status<br>(1) | Package Type | Package Drawing | Pins | Package Qty | Eco Plan<br>(2) | Lead finish/<br>Ball material<br>(6) | MSL Peak Temp<br>(3) | Op Temp (°C) | Device Marking<br>(4/5) | Samples |
|------------------|---------------|--------------|-----------------|------|-------------|-----------------|--------------------------------------|----------------------|--------------|-------------------------|---------|
| TPS51383RJNR     | ACTIVE        | VQFN-HR      | RJN             | 12   | 3000        | RoHS & Green    | SN                                   | Level-2-260C-1 YEAR  | -40 to 125   | 51383                   | Samples |

(1) The marketing status values are defined as follows:

**ACTIVE:** Product device recommended for new designs.

**LIFEBUY:** TI has announced that the device will be discontinued, and a lifetime-buy period is in effect.

**NRND:** Not recommended for new designs. Device is in production to support existing customers, but TI does not recommend using this part in a new design.

**PREVIEW:** Device has been announced but is not in production. Samples may or may not be available.

**OBSELETE:** TI has discontinued the production of the device.

(2) **RoHS:** TI defines "RoHS" to mean semiconductor products that are compliant with the current EU RoHS requirements for all 10 RoHS substances, including the requirement that RoHS substance do not exceed 0.1% by weight in homogeneous materials. Where designed to be soldered at high temperatures, "RoHS" products are suitable for use in specified lead-free processes. TI may reference these types of products as "Pb-Free".

**RoHS Exempt:** TI defines "RoHS Exempt" to mean products that contain lead but are compliant with EU RoHS pursuant to a specific EU RoHS exemption.

**Green:** TI defines "Green" to mean the content of Chlorine (Cl) and Bromine (Br) based flame retardants meet JS709B low halogen requirements of <=1000ppm threshold. Antimony trioxide based flame retardants must also meet the <=1000ppm threshold requirement.

(3) MSL, Peak Temp. - The Moisture Sensitivity Level rating according to the JEDEC industry standard classifications, and peak solder temperature.

(4) There may be additional marking, which relates to the logo, the lot trace code information, or the environmental category on the device.

(5) Multiple Device Markings will be inside parentheses. Only one Device Marking contained in parentheses and separated by a "~" will appear on a device. If a line is indented then it is a continuation of the previous line and the two combined represent the entire Device Marking for that device.

(6) Lead finish/Ball material - Orderable Devices may have multiple material finish options. Finish options are separated by a vertical ruled line. Lead finish/Ball material values may wrap to two lines if the finish value exceeds the maximum column width.

**Important Information and Disclaimer:**The information provided on this page represents TI's knowledge and belief as of the date that it is provided. TI bases its knowledge and belief on information provided by third parties, and makes no representation or warranty as to the accuracy of such information. Efforts are underway to better integrate information from third parties. TI has taken and continues to take reasonable steps to provide representative and accurate information but may not have conducted destructive testing or chemical analysis on incoming materials and chemicals. TI and TI suppliers consider certain information to be proprietary, and thus CAS numbers and other limited information may not be available for release.

In no event shall TI's liability arising out of such information exceed the total purchase price of the TI part(s) at issue in this document sold by TI to Customer on an annual basis.

**TAPE AND REEL INFORMATION**

**QUADRANT ASSIGNMENTS FOR PIN 1 ORIENTATION IN TAPE**



\*All dimensions are nominal

| Device       | Package Type | Package Drawing | Pins | SPQ  | Reel Diameter (mm) | Reel Width W1 (mm) | A0 (mm) | B0 (mm) | K0 (mm) | P1 (mm) | W (mm) | Pin1 Quadrant |
|--------------|--------------|-----------------|------|------|--------------------|--------------------|---------|---------|---------|---------|--------|---------------|
| TPS51383RJNR | VQFN-HR      | RJN             | 12   | 3000 | 180.0              | 8.4                | 2.25    | 3.25    | 1.05    | 4.0     | 8.0    | Q1            |

**TAPE AND REEL BOX DIMENSIONS**

\*All dimensions are nominal

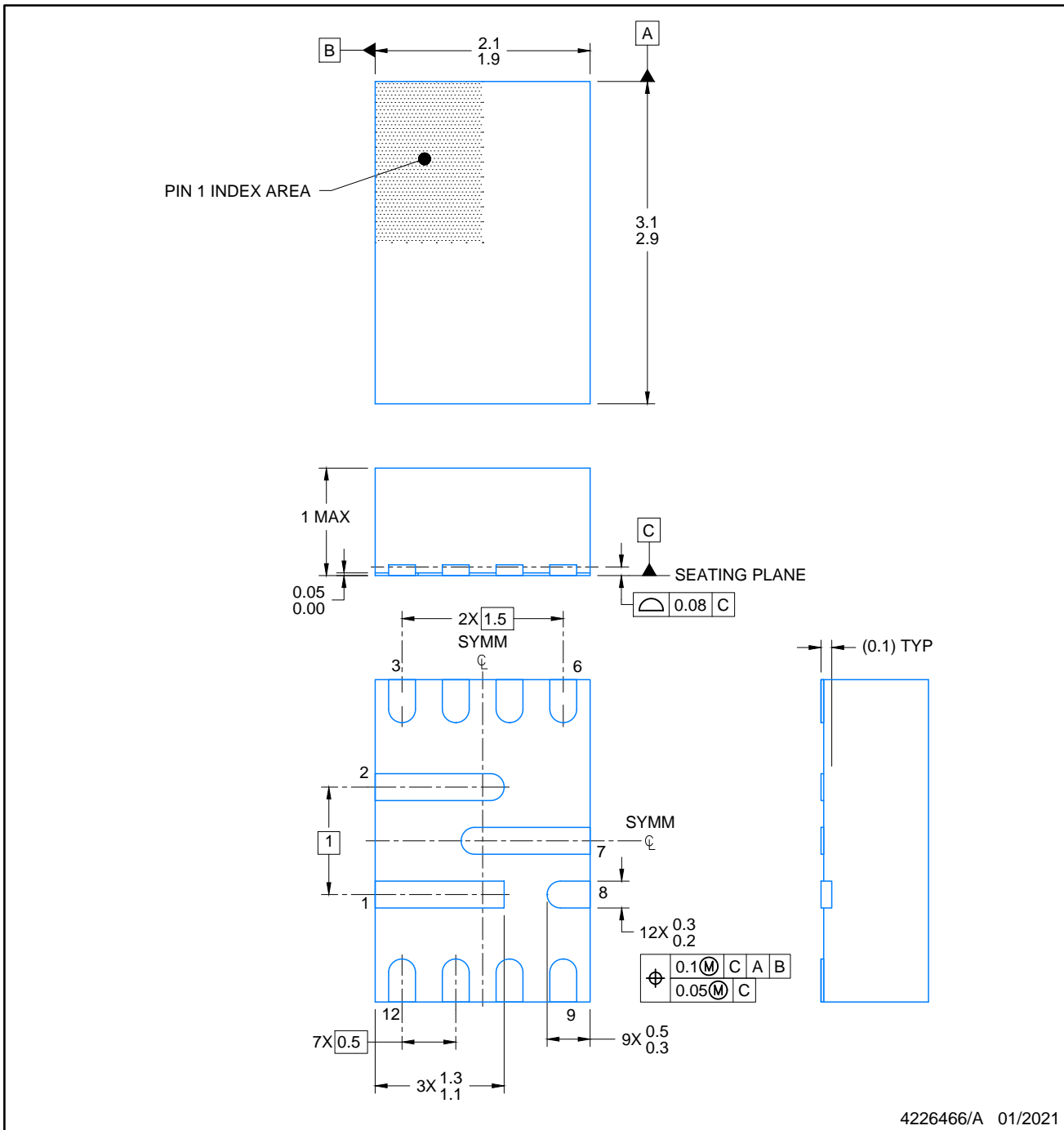
| Device       | Package Type | Package Drawing | Pins | SPQ  | Length (mm) | Width (mm) | Height (mm) |
|--------------|--------------|-----------------|------|------|-------------|------------|-------------|
| TPS51383RJNR | VQFN-HR      | RJN             | 12   | 3000 | 210.0       | 185.0      | 35.0        |



4226466/A 01/2021

NOTES:

1. All linear dimensions are in millimeters. Any dimensions in parenthesis are for reference only. Dimensioning and tolerancing per ASME Y14.5M.
2. This drawing is subject to change without notice.



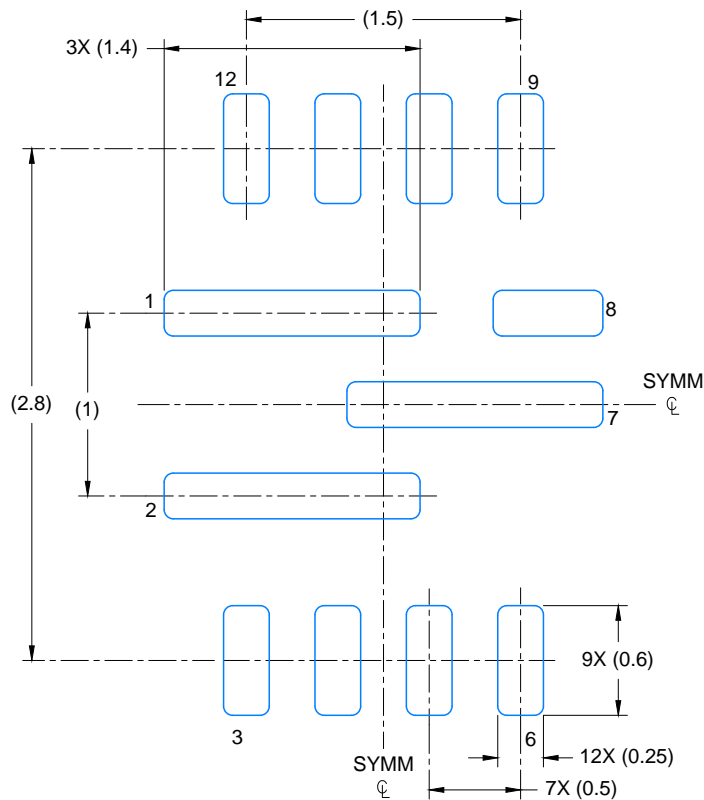

LAND PATTERN EXAMPLE  
EXPOSED METAL SHOWN  
SCALE: 25X

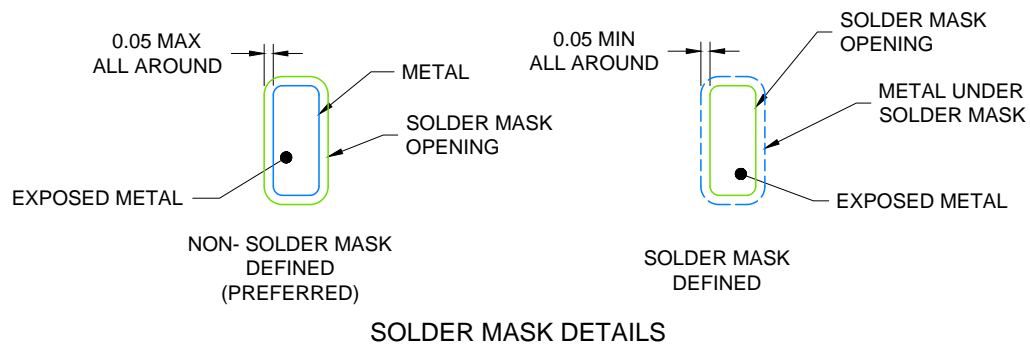

4226466/A 01/2021

NOTES: (continued)

3. For more information, see Texas Instruments literature number SLUA271 ([www.ti.com/lit/slua271](http://www.ti.com/lit/slua271)) .
4. Solder mask tolerances between and around signal pads can vary based on board fabrication site.

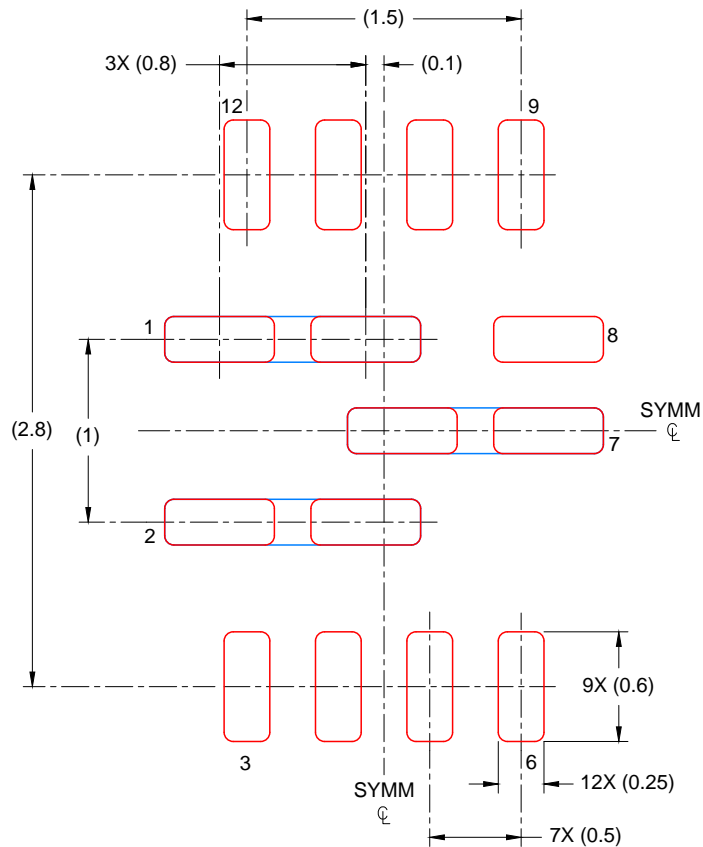

SOLDER PASTE EXAMPLE  
 BASED ON 0.1mm THICK STENCIL

EXPOSED PAD  
 PINS 1,2,7: 86%  
 SCALE: 25X

4226466/A 01/2021

NOTES: (continued)

5. Laser cutting apertures with trapezoidal walls and rounded corners may offer better paste release. IPC-7525 may have alternate design recommendations.

## IMPORTANT NOTICE AND DISCLAIMER

TI PROVIDES TECHNICAL AND RELIABILITY DATA (INCLUDING DATA SHEETS), DESIGN RESOURCES (INCLUDING REFERENCE DESIGNS), APPLICATION OR OTHER DESIGN ADVICE, WEB TOOLS, SAFETY INFORMATION, AND OTHER RESOURCES "AS IS" AND WITH ALL FAULTS, AND DISCLAIMS ALL WARRANTIES, EXPRESS AND IMPLIED, INCLUDING WITHOUT LIMITATION ANY IMPLIED WARRANTIES OF MERCHANTABILITY, FITNESS FOR A PARTICULAR PURPOSE OR NON-INFRINGEMENT OF THIRD PARTY INTELLECTUAL PROPERTY RIGHTS.

These resources are intended for skilled developers designing with TI products. You are solely responsible for (1) selecting the appropriate TI products for your application, (2) designing, validating and testing your application, and (3) ensuring your application meets applicable standards, and any other safety, security, regulatory or other requirements.

These resources are subject to change without notice. TI grants you permission to use these resources only for development of an application that uses the TI products described in the resource. Other reproduction and display of these resources is prohibited. No license is granted to any other TI intellectual property right or to any third party intellectual property right. TI disclaims responsibility for, and you will fully indemnify TI and its representatives against, any claims, damages, costs, losses, and liabilities arising out of your use of these resources.

TI's products are provided subject to [TI's Terms of Sale](#) or other applicable terms available either on [ti.com](https://www.ti.com) or provided in conjunction with such TI products. TI's provision of these resources does not expand or otherwise alter TI's applicable warranties or warranty disclaimers for TI products.

TI objects to and rejects any additional or different terms you may have proposed.

Mailing Address: Texas Instruments, Post Office Box 655303, Dallas, Texas 75265  
Copyright © 2023, Texas Instruments Incorporated