

# TPS560200 4.5-V to 17-V Input, 500-mA Synchronous Step-Down Converter With Advanced Eco-Mode™

## 1 Features

- Integrated Monolithic 0.95- $\Omega$  High-Side and 0.33- $\Omega$  Low-Side MOSFETs
- 500-mA Continuous Output Current
- Output Voltage Range: 0.8 V to 6.5 V
- 0.8-V Voltage Reference With  $\pm 1.3\%$  Accuracy Over Temperature
- Auto-Skip Advanced Eco-Mode™ for High Efficiency at Light Loads
- D-CAP2™ Mode Enables Fast Transient Responses
- No External Compensation Needed
- 600-kHz Switching Frequency
- 2-ms Internal Soft-Start
- Safe Start-Up into Prebiased VOUT
- Thermal Shutdown
- $-40^{\circ}\text{C}$  to  $125^{\circ}\text{C}$  Operating Junction Temperature Range
- Available in 5-Pin SOT-23 Package

## 2 Applications

- Set Top Boxes
- Modems
- DTBs
- ASDLs

## 3 Description

The TPS560200 is an 17-V, 500-mA, low-Iq, adaptive on-time D-CAP2 mode synchronous monolithic buck converter with integrated MOSFETs in easy-to-use 5-pin SOT-23 package.

The TPS560200 lets system designers complete the suite of various end-equipment power bus regulators with a cost-effective, low component count and low standby current solution. The main control loop for the device uses the D-CAP2 mode control that provides a fast transient response with no external compensation components. The adaptive on-time control supports seamless transition between PWM mode at higher load conditions and advanced Eco-Mode operation at light loads.

The TPS560200 also has a proprietary circuit that enables the device to adopt to both low equivalent series resistance (ESR) output capacitors, such as POSCAP or SP-CAP, and ultra-low ESR ceramic capacitors. The device operates from 4.5-V to 17-V VIN input. The output voltage can be programmed between 0.8 V and 6.5 V. The device also features a fixed 2-ms soft-start time. The device is available in the 5-pin SOT-23 package.

### Device Information<sup>(1)</sup>

| PART NUMBER | PACKAGE | BODY SIZE (NOM)   |
|-------------|---------|-------------------|
| TPS560200   | SOT (5) | 2.90 mm x 1.60 mm |

(1) For all available packages, see the orderable addendum at the end of the datasheet.

### Simplified Schematic

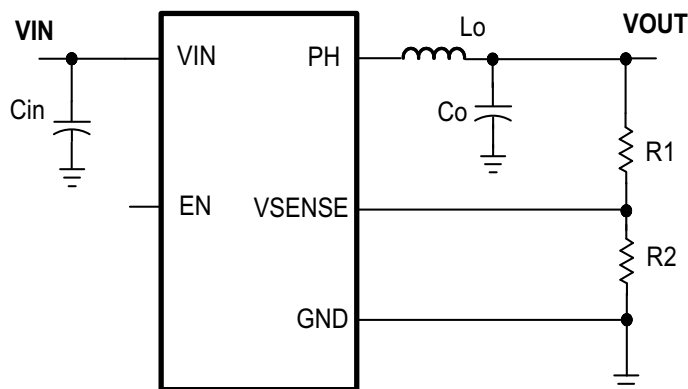

## Table of Contents

|  |          |  |           |
|--|----------|--|-----------|
| <b>1 Features</b> .....                        | <b>1</b> | 7.3 Feature Description .....                                    | <b>7</b>  |
| <b>2 Applications</b> .....                    | <b>1</b> | 7.4 Device Functional Modes .....                                | <b>9</b>  |
| <b>3 Description</b> .....                     | <b>1</b> | <b>8 Application and Implementation</b> .....                    | <b>10</b> |
| <b>4 Revision History</b> .....                | <b>2</b> | 8.1 Application Information .....                                | <b>10</b> |
| <b>5 Pin Configuration and Functions</b> ..... | <b>3</b> | 8.2 Typical Application .....                                    | <b>10</b> |
| <b>6 Specifications</b> .....                  | <b>4</b> | <b>9 Power Supply Recommendations</b> .....                      | <b>14</b> |
| 6.1 Absolute Maximum Ratings .....             | <b>4</b> | <b>10 Layout</b> .....   | <b>14</b> |
| 6.2 ESD Ratings .....                          | <b>4</b> | 10.1 Layout Guidelines .....                                     | <b>14</b> |
| 6.3 Recommended Operating Conditions .....     | <b>4</b> | 10.2 Layout Example .....  | <b>14</b> |
| 6.4 Thermal Information .....                  | <b>4</b> | <b>11 Device and Documentation Support</b> .....                 | <b>15</b> |
| 6.5 Electrical Characteristics .....           | <b>4</b> | 11.1 Device Support .....  | <b>15</b> |
| 6.6 Typical Characteristics .....              | <b>6</b> | 11.2 Trademarks .....  | <b>15</b> |
| <b>7 Detailed Description</b> .....            | <b>7</b> | 11.3 Electrostatic Discharge Caution .....                       | <b>15</b> |
| 7.1 Overview .....                             | <b>7</b> | 11.4 Glossary .....  | <b>15</b> |
| 7.2 Functional Block Diagram .....             | <b>7</b> | <b>12 Mechanical, Packaging, and Orderable Information</b> ..... | <b>15</b> |

## 4 Revision History

| <b>Changes from Revision B (February 2015) to Revision C</b> | <b>Page</b> |
|--|-------------|
| • Deleted SWIFT™ from the data sheet title .....             | <b>1</b>    |

  

| <b>Changes from Revision A (January 2015) to Revision B</b>                                     | <b>Page</b> |
|---|-------------|
| • Removed note from ENABLE (EN PIN) to indicate that the parameters are production tested ..... | <b>5</b>    |

| <b>Changes from Original (September 2013) to Revision A</b>  | <b>Page</b> |
|--|-------------|
| • Added <i>ESD Ratings</i> table, <i>Feature Description</i> section, <i>Device Functional Modes</i> , <i>Application and Implementation</i> section, <i>Power Supply Recommendations</i> section, <i>Layout</i> section, <i>Device and Documentation Support</i> section, and <i>Mechanical, Packaging, and Orderable Information</i> section. .... | <b>1</b>    |

## 5 Pin Configuration and Functions

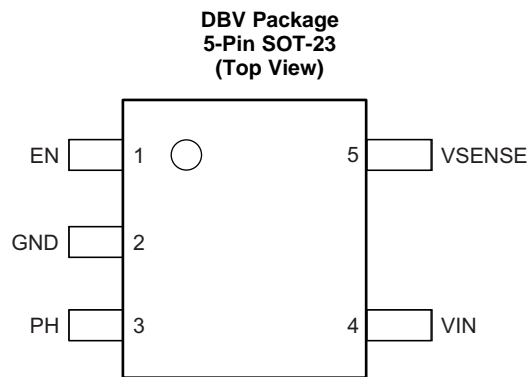

### Pin Functions

| PIN    |     | I/O | DESCRIPTION  |
|--------|-----|-----|--|
| NAME   | NO. |     |  |
| EN     | 1   | I   | Enable pin. Float to enable  |
| GND    | 2   | —   | Return for control circuitry and low-side power MOSFET                             |
| PH     | 3   | O   | The switch node  |
| VIN    | 4   | I   | Supplies the control circuitry of the power converter                              |
| VSENSE | 5   | I   | Converter feedback input. Connect to output voltage with feedback resistor divider |

## 6 Specifications

### 6.1 Absolute Maximum Ratings<sup>(1)</sup>

|                                       |                    | MIN           | MAX | UNIT |
|---------------------------------------|--------------------|---------------|-----|------|
| Input voltage                         | VIN                | -0.3          | 20  | V    |
|                                       | EN                 | -0.3          | 7   |      |
|                                       | VSENSE             | -0.3          | 3   |      |
| Output voltage                        | PH                 | -0.6          | 20  |      |
|                                       | PH 10-ns transient | -2            | 20  |      |
| Source current                        | EN                 | ±100          |     | µA   |
|                                       | PH                 | Current limit |     | A    |
| Sink current                          | PH                 | Current limit |     | A    |
| Operating junction temperature        |                    | -40           | 125 | °C   |
| Storage temperature, T <sub>stg</sub> |                    | -65           | 150 |      |

- (1) Stresses beyond those listed under *Absolute Maximum Ratings* may cause permanent damage to the device. These are stress ratings only, and functional operation of the device at these or any other conditions beyond those indicated under *Recommended Operating Conditions* is not implied. Exposure to absolute-maximum-rated conditions for extended periods may affect device reliability.

### 6.2 ESD Ratings

|  |  | VALUE | UNIT |
|--|--|-------|------|
| V <sub>(ESD)</sub> Electrostatic discharge | Human-body model (HBM), per ANSI/ESDA/JEDEC JS-001 <sup>(1)</sup>              | ±2000 | V    |
|  | Charged-device model (CDM), per JEDEC specification JESD22-C101 <sup>(2)</sup> | ±500  |      |

- (1) JEDEC document JEP155 states that 500-V HBM allows safe manufacturing with a standard ESD control process.  
 (2) JEDEC document JEP157 states that 250-V CDM allows safe manufacturing with a standard ESD control process.

### 6.3 Recommended Operating Conditions

over operating free-air temperature range (unless otherwise noted)

|                |                                | MIN | MAX | UNIT |
|----------------|--------------------------------|-----|-----|------|
| V <sub>I</sub> | Input voltage range            | 4.5 | 17  | V    |
| T <sub>J</sub> | Operating junction temperature | -40 | 125 | °C   |

### 6.4 Thermal Information

| THERMAL METRIC <sup>(1)</sup> |  | TPS560200 | UNIT |
|-------------------------------|--|-----------|------|
|                               |  | DBV       |      |
|                               |  | 5 Pins    |      |
| R <sub>θJA</sub>              | Junction-to-ambient thermal resistance       | 166.8     | °C/W |
| R <sub>θJC(top)</sub>         | Junction-to-case (top) thermal resistance    | 100       |      |
| R <sub>θJB</sub>              | Junction-to-board thermal resistance         | 75.5      |      |
| ψ <sub>JT</sub>               | Junction-to-top characterization parameter   | 29.2      |      |
| ψ <sub>JB</sub>               | Junction-to-board characterization parameter | 3.7       |      |
| R <sub>θJC(bot)</sub>         | Junction-to-case (bottom) thermal resistance | 28.7      |      |

- (1) For more information about traditional and new thermal metrics, see the *Semiconductor and IC Package Thermal Metrics* application report, [SPRA953](#).

### 6.5 Electrical Characteristics

T<sub>J</sub> = -40°C to 125°C, V<sub>IN</sub> = 4.5 V to 17 V (unless otherwise noted)

| PARAMETER                       | TEST CONDITIONS | MIN | TYP  | MAX | UNIT |
|---------------------------------|-----------------|-----|------|-----|------|
| <b>SUPPLY VOLTAGE (VIN PIN)</b> |                 |     |      |     |      |
| VIN Operating input voltage     |                 | 4.5 |      | 17  | V    |
| VIN Internal UVLO threshold     | VIN Rising      | 3.9 | 4.35 | 4.5 | V    |
| VIN Internal UVLO hysteresis    |                 |     | 200  |     | mV   |

**Electrical Characteristics (continued)**
 $T_J = -40^{\circ}\text{C}$  to  $125^{\circ}\text{C}$ ,  $V_{IN} = 4.5\text{ V}$  to  $17\text{ V}$  (unless otherwise noted)

| PARAMETER                                     | TEST CONDITIONS   | MIN   | TYP   | MAX   | UNIT  |
|---|---|-------|-------|-------|-------|
| VIN Shutdown supply current                   | EN = 0 V, VIN = 12 V  | 2.0   | 3.7   | 9     | μA    |
| VIN Operating– non switching supply current   | VSENSE = 850 mV, VIN = 12 V   | 35    | 60    | 95    | μA    |
| <b>ENABLE (EN PIN)</b>                        |   |       |       |       |       |
| Enable threshold                              | Rising  |       | 1.16  | 1.29  | V     |
|   | Falling   | 1.05  | 1.13  |       | V     |
| Internal Soft-Start                           | VSENSE ramps from 0 V to 0.8 V  |       | 2     |       | ms    |
| <b>OUTPUT VOLTAGE</b>                         |   |       |       |       |       |
| Voltage reference                             | 25°C, VIN = 12 V, VOUT = 1.05 V, IOUT = 5 mA, Pulse-Skipping            | 0.796 | 0.804 | 0.812 | V     |
|   | 25°C, VIN = 12 V, VOUT = 1.05 V, IOUT = 100 mA, Continuous current mode | 0.792 | 0.800 | 0.808 | V     |
|   | VIN = 12 V, VOUT = 1.05 V, IOUT = 100 mA, Continuous current mode       | 0.789 | 0.800 | 0.811 | V     |
| <b>MOSFET</b>                                 |   |       |       |       |       |
| High-side switch resistance <sup>(1)(2)</sup> | VIN = 12 V  | 0.50  | 0.95  | 1.50  | Ω     |
| Low-side switch resistance <sup>(1)</sup>     | VIN = 12 V  | 0.20  | 0.33  | 0.55  | Ω     |
| <b>CURRENT LIMIT</b>                          |   |       |       |       |       |
| Low-side switch sourcing current limit        | LOUT = 10 μH, Valley current, VOUT = 1.05 V                             | 550   | 650   | 775   | mA    |
| <b>THERMAL SHUTDOWN</b>                       |   |       |       |       |       |
| Thermal shutdown                              |   |       | 170   |       | °C    |
| Thermal shutdown hysteresis                   |   |       | 10    |       | °C    |
| <b>ON-TIME TIMER CONTROL</b>                  |   |       |       |       |       |
| On time                                       | VIN = 12 V  | 130   | 165   | 200   | ns    |
| Minimum off time                              | 25°C, VSENSE = 0.5 V  |       | 250   | 400   | ns    |
| <b>OUTPUT UNDERVOLTAGE PROTECTION</b>         |   |       |       |       |       |
| Output UVP threshold                          | Falling   | 56    | 63    | 69    | %VREF |
| Hiccup time                                   |   |       | 15    |       | ms    |

(1) Not production tested

(2) Measured at pins

## 6.6 Typical Characteristics

$V_{IN} = 12\text{ V}$ ,  $T_A = 25^\circ\text{C}$  (unless otherwise noted).

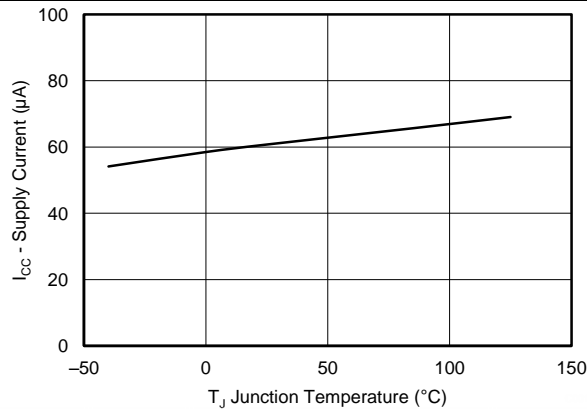

Figure 1. Supply Current vs Junction Temperature

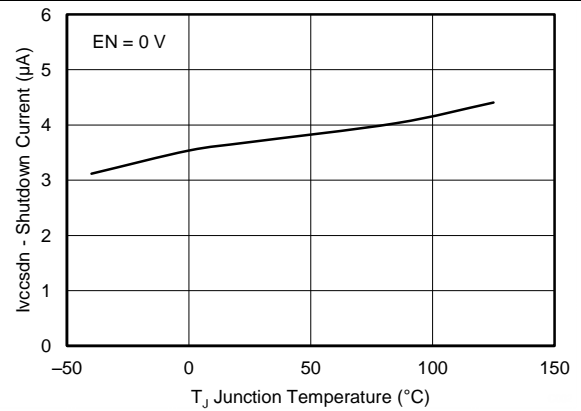

Figure 2. Shutdown Current vs Junction Temperature

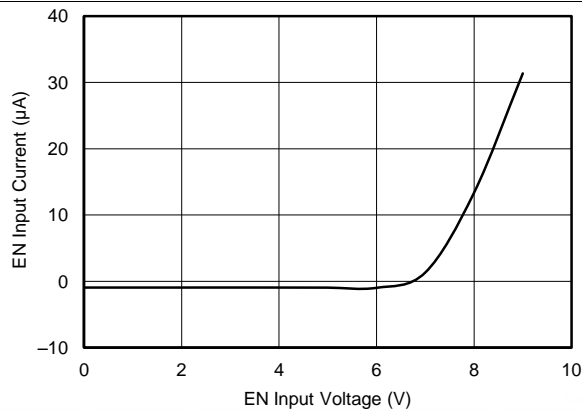

Figure 3. EN Input Current vs EN Input Voltage

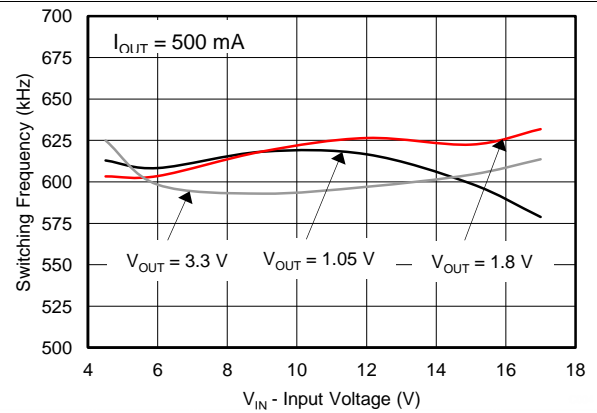

Figure 4. Switching Frequency vs Input Voltage

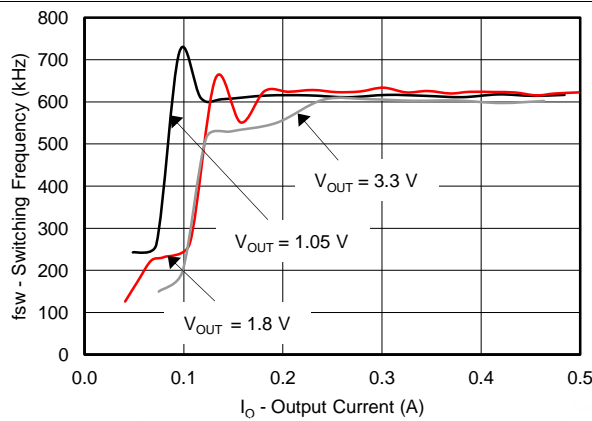

Figure 5. Switching Frequency vs Output Current

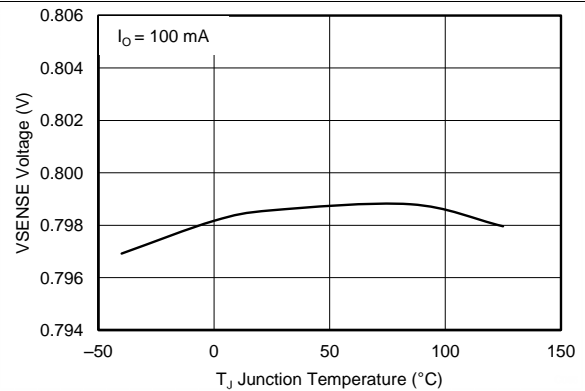

Figure 6. VSENSE Voltage vs Junction Temperature

## 7 Detailed Description

### 7.1 Overview

The TPS560200 is a 500-mA synchronous step-down (buck) converter with two integrated N-channel MOSFETs. It operates using D-CAP2 mode control. The fast transient response of D-CAP2 control reduces the output capacitance required to meet a specific level of performance. Proprietary internal circuitry allows the use of low-ESR output capacitors including ceramic and special polymer types.

### 7.2 Functional Block Diagram

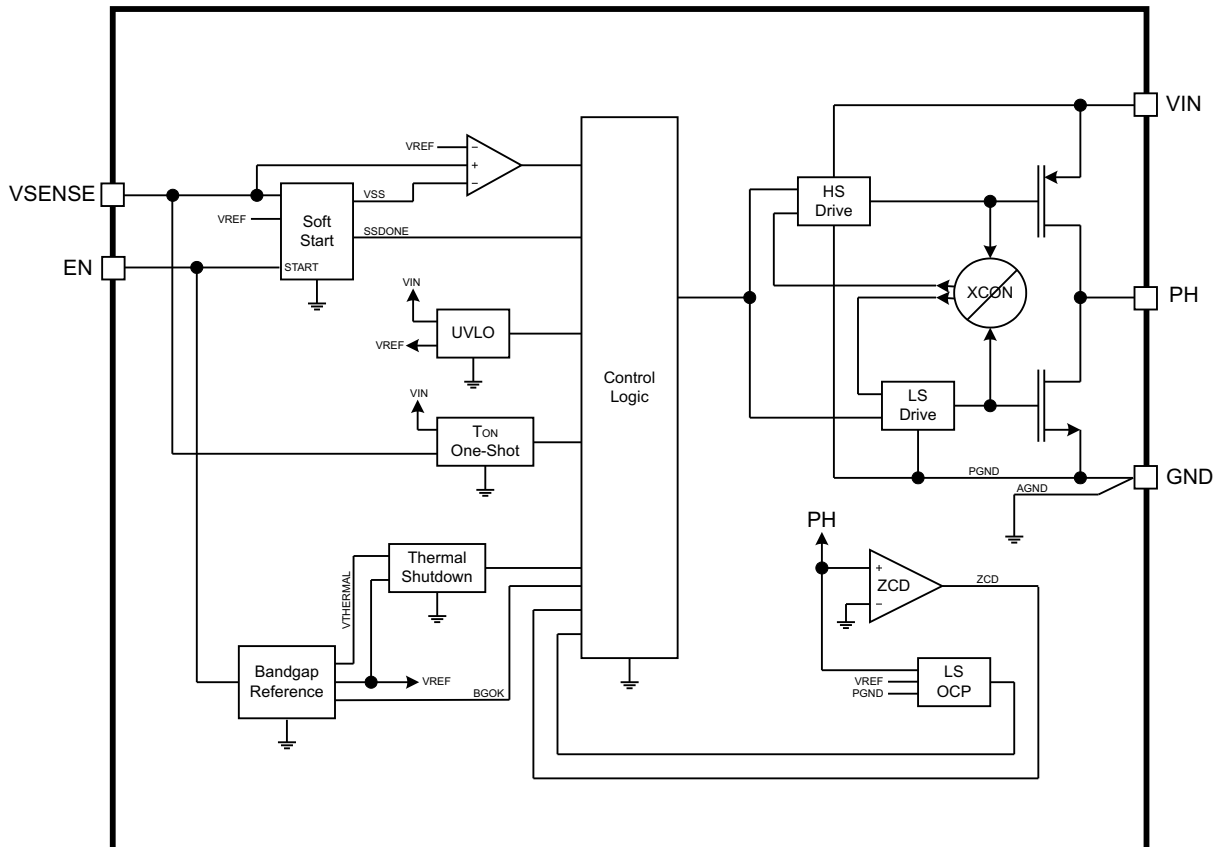

### 7.3 Feature Description

#### 7.3.1 PWM Operation

The main control loop of the TPS560200 is an adaptive on-time pulse width modulation (PWM) controller that supports a proprietary D-CAP2 mode control. D-CAP2 mode control combines constant on-time control with an internal compensation circuit for pseudo-fixed frequency and low external component count configuration with both low-ESR and ceramic output capacitors. It is stable even with virtually no ripple at the output.

At the beginning of each cycle, the high-side MOSFET is turned on. This MOSFET is turned off after internal one-shot timer expires. This one shot is set by the converter input voltage,  $V_{IN}$ , and the output voltage,  $V_{OUT}$ , to maintain a pseudo-fixed frequency over the input voltage range, hence it is called adaptive on-time control. The one-shot timer is reset and the high-side MOSFET is turned on again when the feedback voltage falls below the reference voltage. An internal ramp is added to reference voltage to simulate output ripple, eliminating the need for ESR induced output ripple from D-CAP2 mode control.

## Feature Description (continued)

### 7.3.2 PWM Frequency and Adaptive On-Time Control

TPS560200 uses an adaptive on-time control scheme and does not have a dedicated on board oscillator. The TPS560200 runs with a pseudo-constant frequency of 600 kHz by using the input voltage and output voltage to set the on-time, one-shot timer. The on-time is inversely proportional to the input voltage and proportional to the output voltage; therefore, when the duty ratio is  $V_{OUT}/V_{IN}$ , the frequency is constant.

### 7.3.3 Advanced Auto-Skip Eco-Mode Control

The TPS560200 is designed with advanced auto-skip Eco-Mode to increase higher light-load efficiency. As the output current decreases from heavy-load condition, the inductor current is also reduced. If the output current is reduced enough, the inductor current ripple valley reaches the zero level, which is the boundary between continuous conduction and discontinuous conduction modes. The rectifying low-side MOSFET is turned off when its zero inductor current is detected. As the load current further decreases the converter run into discontinuous conduction mode. The on-time is kept approximately the same as is in continuous conduction mode. The off-time increases as it takes more time to discharge the output capacitor to the level of the reference voltage with smaller load current. The transition point to the light load operation  $I_{OUT(LL)}$  current can be calculated in Equation 1.

$$I_{OUT(LL)} = \frac{1}{2 \times L_{OUT} \times f_{SW}} \times \frac{(V_{IN} - V_{OUT}) \times V_{OUT}}{V_{IN}} \quad (1)$$

### 7.3.4 Soft-Start and Prebiased Soft-Start

The TPS560200 has an internal 2-ms soft-start. When the EN pin becomes high, internal soft-start function begins ramping up the reference voltage to the PWM comparator.

The TPS560200 contains a unique circuit to prevent current from being pulled from the output during start-up if the output is prebiased. When the soft-start commands a voltage higher than the prebias level (internal soft-start becomes greater than feedback voltage  $V_{VSENSE}$ ), the controller slowly activates synchronous rectification by starting the first low-side FET gate driver pulses with a narrow on-time. It then increments that on-time on a cycle-by-cycle basis until it coincides with the time dictated by  $(1-D)$ , where  $D$  is the duty cycle of the converter. This scheme prevents the initial sinking of the prebias output, and ensure that the out voltage ( $V_{OUT}$ ) starts and ramps up smoothly into regulation and the control loop is given time to transition from prebiased start-up to normal mode operation.

### 7.3.5 Current Protection

The output overcurrent protection (OCP) is implemented using a cycle-by-cycle valley detect control circuit. The switch current is monitored by measuring the low-side FET switch voltage between the PH pin and GND. This voltage is proportional to the switch current. To improve accuracy, the voltage sensing is temperature compensated.

During the on-time of the high-side FET switch, the switch current increases at a linear rate determined by  $V_{IN}$ ,  $V_{OUT}$ , the on-time and the output inductor value. During the on time of the low-side FET switch, this current decreases linearly. The average value of the switch current is the load current  $I_{OUT}$ . The TPS560200 constantly monitors the low-side FET switch voltage, which is proportional to the switch current, during the low-side on-time. If the measured voltage is above the voltage proportional to the current limit, an internal counter is incremented per each switching cycle and the converter maintains the low-side switch on until the measured voltage is below the voltage corresponding to the current limit at which time the switching cycle is terminated and a new switching cycle begins. In subsequent switching cycles, the on-time is set to a fixed value and the current is monitored in the same manner.

There are some important considerations for this type of overcurrent protection. The peak current is the average load current plus one half of the peak-to-peak inductor current. The valley current is the average load current minus one half of the peak-to-peak inductor current. Because the valley current is used to detect the overcurrent threshold, the load current is higher than the overcurrent threshold. Also, when the current is being limited, the output voltage tends to fall as the demanded load current may be higher than the current available from the converter. This protection is nonlatching. When the  $V_{SENSE}$  voltage becomes lower than 63% of the target voltage, the UVP comparator detects it. After 7  $\mu$ s detecting the UVP voltage, device shuts down and re-starts after hiccup time.



## Feature Description (continued)

When the overcurrent condition is removed, the output voltage returns to the regulated value.

### 7.3.6 Thermal Shutdown

TPS560200 monitors the temperature of itself. If the temperature exceeds the threshold value (typically 170°C), the device is shut off. This is nonlatch protection.

## 7.4 Device Functional Modes

### 7.4.1 Normal Operation

When the input voltage is above the UVLO threshold and the EN voltage is above the enable threshold, the TPS560200 can operate in its normal switching modes. Normal continuous conduction mode (CCM) occurs when the minimum switch current is above 0 A. In CCM, the TPS560200 operates at a quasi-fixed frequency of 600 kHz.

### 7.4.2 Eco-Mode Operation

When the TPS560200 is in the normal CCM operating mode and the switch current falls to 0 A, the TPS560200 begins operating in pulse-skipping Eco-Mode. Each switching cycle is followed by a period of energy-saving sleep time. The sleep time ends when the VFB voltage falls below the Eco-Mode threshold voltage. As the output current decreases the perceived time between switching pulses increases.

### 7.4.3 Standby Operation

When the TPS560200 is operating in either normal CCM or Eco-Mode, it may be placed in standby by asserting the EN pin low.

## 8 Application and Implementation

### NOTE

Information in the following applications sections is not part of the TI component specification, and TI does not warrant its accuracy or completeness. TI's customers are responsible for determining suitability of components for their purposes. Customers should validate and test their design implementation to confirm system functionality.

### 8.1 Application Information

The TPS560200 is used as a step-down converter which converts a voltage of 4.5 V to 17 V to a lower voltage. WEBENCH<sup>®</sup> software is available to aid in the design and analysis of circuits.

### 8.2 Typical Application

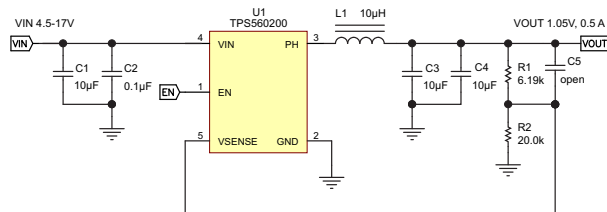

Figure 7. Typical Application Schematic

#### 8.2.1 Design Requirements

To begin the design process, the user must know a few application parameters:

Table 1. Design Parameters

| PARAMETER             | VALUES        |
|-----------------------|---------------|
| Input voltage range   | 4.5 V to 17 V |
| Output voltage        | 1.05 V        |
| Output current        | 500 mA        |
| Output voltage ripple | 10 mV/pp      |

#### 8.2.2 Detailed Design Procedure

##### 8.2.2.1 Output Voltage Resistors Selection

The output voltage is set with a resistor divider from the output node to the VFB pin. TI recommends using 1% tolerance or better divider resistors. Start by using Equation 2 to calculate  $V_{OUT}$ .

To improve efficiency at light loads, consider using larger value resistors, high resistance is more susceptible to noise, and the voltage errors from the VSENSE input current are more noticeable.

$$R2 = \frac{R1 \times 0.8 \text{ V}}{V_{OUT} - 0.8 \text{ V}} \quad (2)$$

##### 8.2.2.2 Output Filter Selection

The output filter used with the TPS560200 is an LC circuit. This LC filter has double pole at:

$$F_P = \frac{1}{2\pi\sqrt{L_{OUT} \times C_{OUT}}} \quad (3)$$

At low frequencies, the overall loop gain is set by the output set-point resistor divider network and the internal gain of the TPS560200. The low frequency phase is 180 degrees. At the output filter pole frequency, the gain rolls off at a –40 dB per decade rate and the phase drops rapidly. D-CAP2 introduces a high frequency zero that reduces the gain roll off to –20 dB per decade and increases the phase to 90 degrees one decade above the zero frequency. The inductor and capacitor selected for the output filter must be selected so that the double pole of Equation 3 is located below the high frequency zero but close enough that the phase boost provided by the high frequency zero provides adequate phase margin for a stable circuit. To meet this requirement use the values recommended in Table 2.

**Table 2. Recommended Component Values**

| Output Voltage<br>(V) | R1<br>(kΩ) | R2<br>(kΩ) | C5<br>(pF) | L1<br>(μH) |     |     | C3 + C4<br>(μF) |
|-----------------------|------------|------------|------------|------------|-----|-----|-----------------|
|                       |            |            |            | MIN        | TYP | MAX |                 |
| 1.0                   | 4.99       | 20.0       |            |            | 10  |     | 10 + 10         |
| 1.05                  | 6.19       | 20.0       |            |            | 10  |     | 10 + 10         |
| 1.2                   | 10.0       | 20.0       |            |            | 10  |     | 10 + 10         |
| 1.5                   | 17.4       | 20.0       |            |            | 10  |     | 10 + 10         |
| 1.8                   | 24.9       | 20.0       | optional   |            | 10  |     | 10 + 10         |
| 2.5                   | 42.2       | 20.0       | optional   |            | 10  |     | 10 + 10         |
| 3.3                   | 61.9       | 20.0       | optional   |            | 10  |     | 10 + 10         |
| 5.0                   | 105        | 20.0       | optional   |            | 10  |     | 10 + 10         |

Because the DC gain is dependent on the output voltage, the required inductor value increases as the output voltage increases. Additional phase boost can be achieved by adding a feed-forward capacitor (C5) in parallel with R1. The feed-forward capacitor is most effective for output voltages at or above 1.8 V.

The inductor peak-to-peak ripple current, peak current, and RMS current are calculated using Equation 4, Equation 5, and Equation 6. The inductor saturation current rating must be greater than the calculated peak current and the RMS or heating current rating must be greater than the calculated RMS current. Use 600 kHz for  $f_{sw}$ .

Use 600 kHz for  $f_{sw}$ . Make sure the chosen inductor is rated for the peak current of Equation 5 and the RMS current of Equation 6.

$$I_{LPP} = \frac{V_{OUT}}{V_{IN(max)}} \times \frac{V_{IN(max)} - V_{OUT}}{L_{OUT} \times f_{sw}} \quad (4)$$

$$I_{LPEAK} = I_{OUT} + \frac{I_{LPP}}{2} \quad (5)$$

$$I_{L_{OUT}(RMS)} = \sqrt{I_{OUT}^2 + \frac{1}{12} I_{LPP}^2} \quad (6)$$

For this design example, the calculated peak current is 0.582 A and the calculated RMS current is 0.502 A. The inductor used is a Würth 744777910 with a peak current rating of 2.6 A and an RMS current rating of 2 A.

The capacitor value and ESR determines the amount of output voltage ripple. The TPS560200 is intended for use with ceramic or other low-ESR capacitors. The recommended values are given in Table 2. Use Equation 7 to determine the required RMS current rating for the output capacitor.

$$I_{C_{OUT}(RMS)} = \frac{V_{OUT} \times (V_{IN} - V_{OUT})}{\sqrt{12} \times V_{IN} \times L_{OUT} \times f_{sw}} \quad (7)$$

For this design two MuRata GRM32DR61E106KA12L 10-μF output capacitors are used. The typical ESR is 2 mΩ each. The calculated RMS current is 0.047 A and each output capacitor is rated for 3 A.

### 8.2.2.3 Input Capacitor Selection

The TPS560200 requires an input decoupling capacitor and a bulk capacitor is needed depending on the application. A ceramic capacitor over 10  $\mu\text{F}$  is recommended for the decoupling capacitor. An additional 0.1- $\mu\text{F}$  capacitor (C2) from pin 4 to ground is optional to provide additional high frequency filtering. The capacitor voltage rating must be greater than the maximum input voltage.

### 8.2.3 Application Curves

$V_{\text{IN}} = 12\text{ V}$ ,  $V_{\text{OUT}} = 1.05\text{ V}$ ,  $T_{\text{A}} = 25^\circ\text{C}$  (unless otherwise noted).

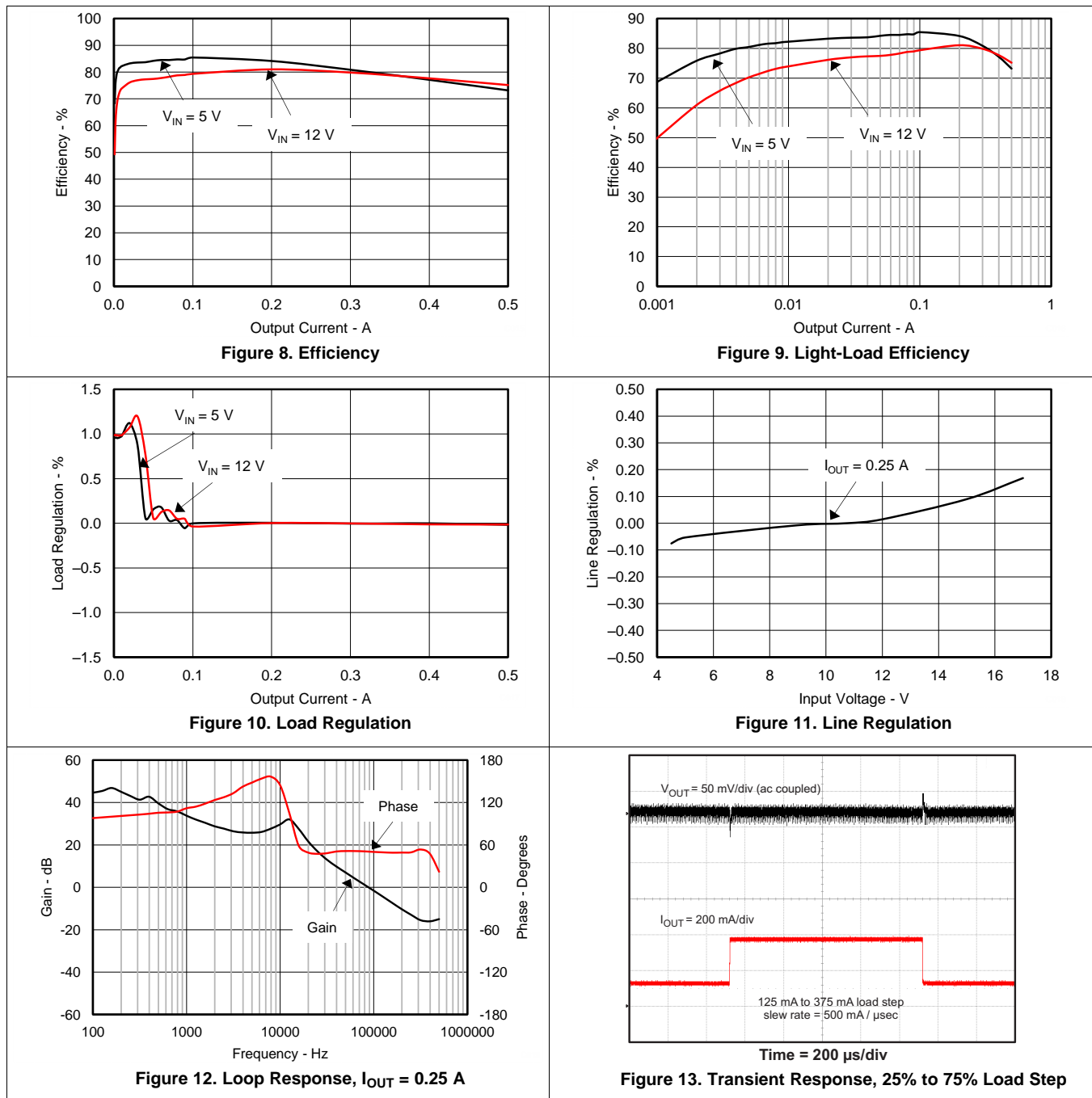

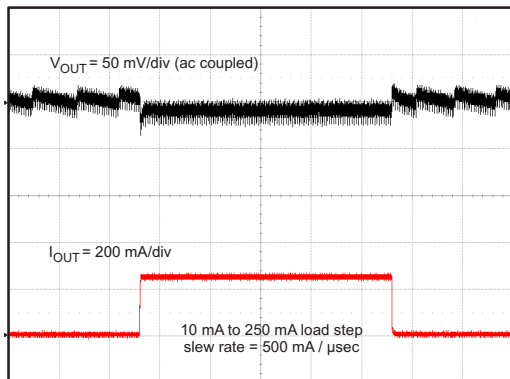

Time = 200  $\mu$ s/div  
**Figure 14. Transient Response, 2% to 50% Load Step**

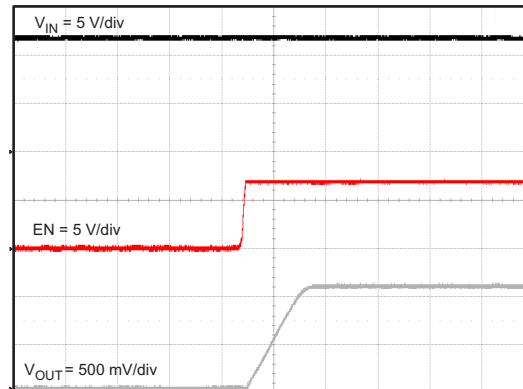

Time = 2 ms/div  
**Figure 15. Start-Up Relative to EN**

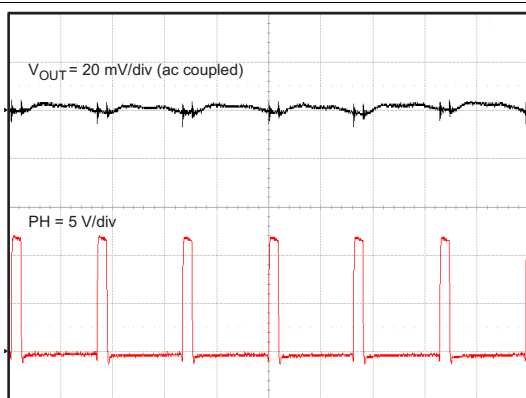

Time = 1  $\mu$ s/div  
**Figure 16. Output Ripple,  $I_{OUT} = 500$  mA**

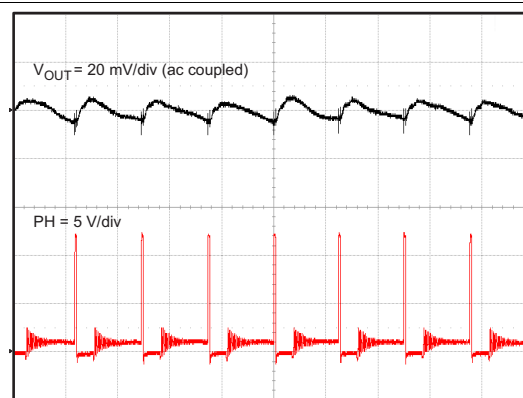

Time = 5  $\mu$ s/div  
**Figure 17. Output Ripple,  $I_{OUT} = 30$  mA**

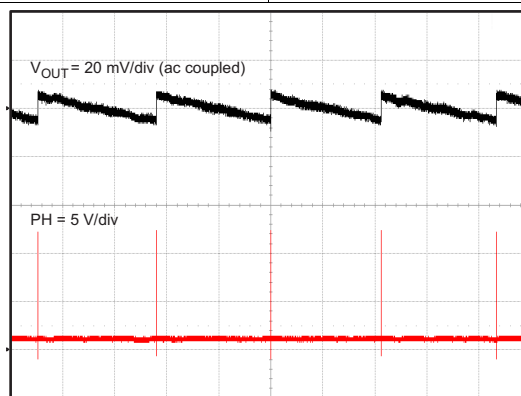

Time = 2 ms/div  
**Figure 18. Output Ripple,  $I_{OUT} = 0$  mA**

## 9 Power Supply Recommendations

The TPS560200 is designed to operate from input supply voltage in the range of 4.5 V to 17 V. Buck converters require the input voltage to be higher than the output voltage for proper operation. The maximum recommended operating duty cycle is 65%. Using that criteria, the minimum recommended input voltage is  $V_O / 0.65$ .

## 10 Layout

### 10.1 Layout Guidelines

The VIN pin should be bypassed to ground with a low-ESR ceramic bypass capacitor. Take care to minimize the loop area formed by the bypass capacitor connection, the VIN pin, and the GND pin of the IC. The typical recommended bypass capacitance is 10- $\mu$ F ceramic with a X5R or X7R dielectric and the optimum placement is closest to the VIN and GND pins of the device. An additional high-frequency bypass capacitor may be added. See Figure 19 for a PCB layout example. The GND pin should be tied to the PCB ground plane at the pin of the IC. The PH pin should be routed to a small copper area directly adjacent to the pin. Make the circulating loop from PH to the output inductor, output capacitors and back to GND as tight as possible while preserving adequate etch width to reduce conduction losses in the copper. Connect the exposed thermal pad to bottom or internal layer ground plane using vias as shown. Additional vias may be used adjacent to the IC to tie top-side copper to the internal or bottom layer copper. The additional external components can be placed approximately as shown. It may be possible to obtain acceptable performance with alternate layout schemes; however, this layout produced good results and is intended as a guideline.

### 10.2 Layout Example

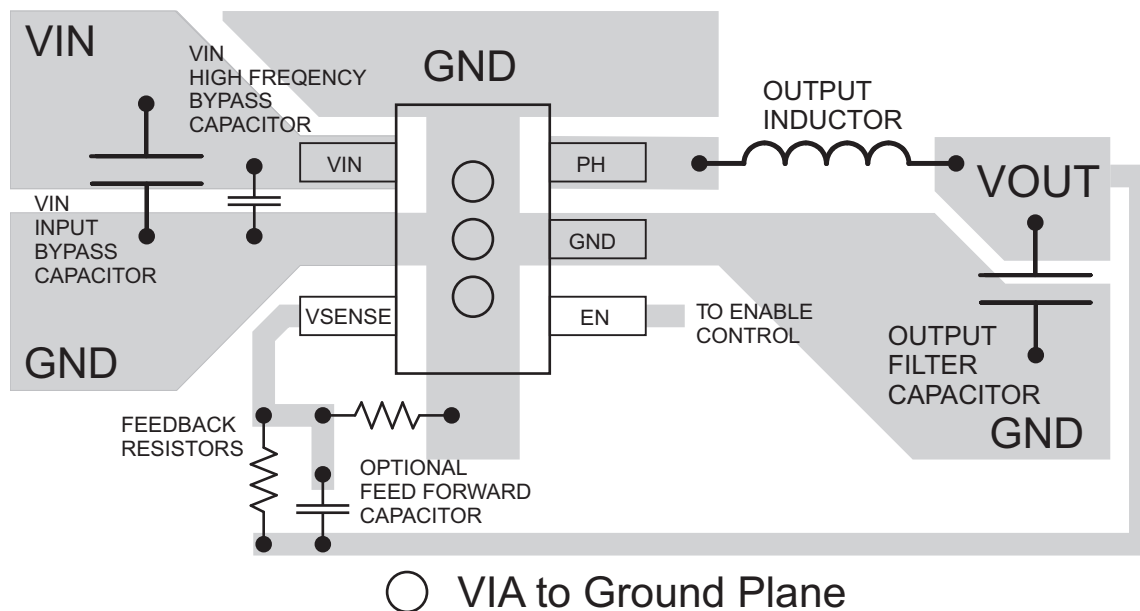

**Figure 19. Layout Schematic**

## 11 Device and Documentation Support

### 11.1 Device Support

#### 11.1.1 Third-Party Products Disclaimer

TI'S PUBLICATION OF INFORMATION REGARDING THIRD-PARTY PRODUCTS OR SERVICES DOES NOT CONSTITUTE AN ENDORSEMENT REGARDING THE SUITABILITY OF SUCH PRODUCTS OR SERVICES OR A WARRANTY, REPRESENTATION OR ENDORSEMENT OF SUCH PRODUCTS OR SERVICES, EITHER ALONE OR IN COMBINATION WITH ANY TI PRODUCT OR SERVICE.

#### 11.2 Trademarks

Eco-Mode, D-CAP2 are trademarks of Texas Instruments.  
WEBENCH is a registered trademark of Texas Instruments.  
All other trademarks are the property of their respective owners.

#### 11.3 Electrostatic Discharge Caution



These devices have limited built-in ESD protection. The leads should be shorted together or the device placed in conductive foam during storage or handling to prevent electrostatic damage to the MOS gates.

#### 11.4 Glossary

[SLYZ022](#) — *TI Glossary*.

This glossary lists and explains terms, acronyms, and definitions.

## 12 Mechanical, Packaging, and Orderable Information

The following pages include mechanical, packaging, and orderable information. This information is the most current data available for the designated devices. This data is subject to change without notice and revision of this document. For browser-based versions of this data sheet, refer to the left-hand navigation.

**PACKAGING INFORMATION**

| Orderable Device | Status<br>(1) | Package Type | Package<br>Drawing | Pins | Package<br>Qty | Eco Plan<br>(2) | Lead finish/<br>Ball material<br>(6) | MSL Peak Temp<br>(3) | Op Temp (°C) | Device Marking<br>(4/5) | Samples        |
|------------------|---------------|--------------|--------------------|------|----------------|-----------------|--------------------------------------|----------------------|--------------|-------------------------|----------------|
| TPS560200DBVR    | ACTIVE        | SOT-23       | DBV                | 5    | 3000           | RoHS & Green    | NIPDAU                               | Level-1-260C-UNLIM   | -40 to 125   | L562                    | <b>Samples</b> |
| TPS560200DBVT    | ACTIVE        | SOT-23       | DBV                | 5    | 250            | RoHS & Green    | NIPDAU                               | Level-1-260C-UNLIM   | -40 to 125   | L562                    | <b>Samples</b> |

(1) The marketing status values are defined as follows:

**ACTIVE:** Product device recommended for new designs.

**LIFEBUY:** TI has announced that the device will be discontinued, and a lifetime-buy period is in effect.

**NRND:** Not recommended for new designs. Device is in production to support existing customers, but TI does not recommend using this part in a new design.

**PREVIEW:** Device has been announced but is not in production. Samples may or may not be available.

**OBSOLETE:** TI has discontinued the production of the device.

(2) **RoHS:** TI defines "RoHS" to mean semiconductor products that are compliant with the current EU RoHS requirements for all 10 RoHS substances, including the requirement that RoHS substance do not exceed 0.1% by weight in homogeneous materials. Where designed to be soldered at high temperatures, "RoHS" products are suitable for use in specified lead-free processes. TI may reference these types of products as "Pb-Free".

**RoHS Exempt:** TI defines "RoHS Exempt" to mean products that contain lead but are compliant with EU RoHS pursuant to a specific EU RoHS exemption.

**Green:** TI defines "Green" to mean the content of Chlorine (Cl) and Bromine (Br) based flame retardants meet JS709B low halogen requirements of <=1000ppm threshold. Antimony trioxide based flame retardants must also meet the <=1000ppm threshold requirement.

(3) MSL, Peak Temp. - The Moisture Sensitivity Level rating according to the JEDEC industry standard classifications, and peak solder temperature.

(4) There may be additional marking, which relates to the logo, the lot trace code information, or the environmental category on the device.

(5) Multiple Device Markings will be inside parentheses. Only one Device Marking contained in parentheses and separated by a "~" will appear on a device. If a line is indented then it is a continuation of the previous line and the two combined represent the entire Device Marking for that device.

(6) Lead finish/Ball material - Orderable Devices may have multiple material finish options. Finish options are separated by a vertical ruled line. Lead finish/Ball material values may wrap to two lines if the finish value exceeds the maximum column width.

**Important Information and Disclaimer:**The information provided on this page represents TI's knowledge and belief as of the date that it is provided. TI bases its knowledge and belief on information provided by third parties, and makes no representation or warranty as to the accuracy of such information. Efforts are underway to better integrate information from third parties. TI has taken and continues to take reasonable steps to provide representative and accurate information but may not have conducted destructive testing or chemical analysis on incoming materials and chemicals. TI and TI suppliers consider certain information to be proprietary, and thus CAS numbers and other limited information may not be available for release.

In no event shall TI's liability arising out of such information exceed the total purchase price of the TI part(s) at issue in this document sold by TI to Customer on an annual basis.



**OTHER QUALIFIED VERSIONS OF TPS560200 :**

- Automotive: [TPS560200-Q1](#)

## NOTE: Qualified Version Definitions:

- Automotive - Q100 devices qualified for high-reliability automotive applications targeting zero defects

## TAPE AND REEL INFORMATION



### QUADRANT ASSIGNMENTS FOR PIN 1 ORIENTATION IN TAPE



\*All dimensions are nominal

| Device        | Package Type | Package Drawing | Pins | SPQ  | Reel Diameter (mm) | Reel Width W1 (mm) | A0 (mm) | B0 (mm) | K0 (mm) | P1 (mm) | W (mm) | Pin1 Quadrant |
|---------------|--------------|-----------------|------|------|--------------------|--------------------|---------|---------|---------|---------|--------|---------------|
| TPS560200DBVR | SOT-23       | DBV             | 5    | 3000 | 178.0              | 9.0                | 3.23    | 3.17    | 1.37    | 4.0     | 8.0    | Q3            |
| TPS560200DBVT | SOT-23       | DBV             | 5    | 250  | 178.0              | 9.0                | 3.23    | 3.17    | 1.37    | 4.0     | 8.0    | Q3            |

**TAPE AND REEL BOX DIMENSIONS**

\*All dimensions are nominal

| Device        | Package Type | Package Drawing | Pins | SPQ  | Length (mm) | Width (mm) | Height (mm) |
|---------------|--------------|-----------------|------|------|-------------|------------|-------------|
| TPS560200DBVR | SOT-23       | DBV             | 5    | 3000 | 180.0       | 180.0      | 18.0        |
| TPS560200DBVT | SOT-23       | DBV             | 5    | 250  | 180.0       | 180.0      | 18.0        |



# EXAMPLE BOARD LAYOUT

DBV0005A

SOT-23 - 1.45 mm max height

SMALL OUTLINE TRANSISTOR



LAND PATTERN EXAMPLE  
EXPOSED METAL SHOWN  
SCALE:15X



SOLDER MASK DETAILS

4214839/K 08/2024

NOTES: (continued)

- 6. Publication IPC-7351 may have alternate designs.
- 7. Solder mask tolerances between and around signal pads can vary based on board fabrication site.

# EXAMPLE STENCIL DESIGN

DBV0005A

SOT-23 - 1.45 mm max height

SMALL OUTLINE TRANSISTOR



SOLDER PASTE EXAMPLE  
BASED ON 0.125 mm THICK STENCIL  
SCALE:15X

4214839/K 08/2024

NOTES: (continued)

8. Laser cutting apertures with trapezoidal walls and rounded corners may offer better paste release. IPC-7525 may have alternate design recommendations.
9. Board assembly site may have different recommendations for stencil design.

## IMPORTANT NOTICE AND DISCLAIMER

TI PROVIDES TECHNICAL AND RELIABILITY DATA (INCLUDING DATA SHEETS), DESIGN RESOURCES (INCLUDING REFERENCE DESIGNS), APPLICATION OR OTHER DESIGN ADVICE, WEB TOOLS, SAFETY INFORMATION, AND OTHER RESOURCES "AS IS" AND WITH ALL FAULTS, AND DISCLAIMS ALL WARRANTIES, EXPRESS AND IMPLIED, INCLUDING WITHOUT LIMITATION ANY IMPLIED WARRANTIES OF MERCHANTABILITY, FITNESS FOR A PARTICULAR PURPOSE OR NON-INFRINGEMENT OF THIRD PARTY INTELLECTUAL PROPERTY RIGHTS.

These resources are intended for skilled developers designing with TI products. You are solely responsible for (1) selecting the appropriate TI products for your application, (2) designing, validating and testing your application, and (3) ensuring your application meets applicable standards, and any other safety, security, regulatory or other requirements.

These resources are subject to change without notice. TI grants you permission to use these resources only for development of an application that uses the TI products described in the resource. Other reproduction and display of these resources is prohibited. No license is granted to any other TI intellectual property right or to any third party intellectual property right. TI disclaims responsibility for, and you will fully indemnify TI and its representatives against, any claims, damages, costs, losses, and liabilities arising out of your use of these resources.

TI's products are provided subject to [TI's Terms of Sale](#) or other applicable terms available either on [ti.com](https://www.ti.com) or provided in conjunction with such TI products. TI's provision of these resources does not expand or otherwise alter TI's applicable warranties or warranty disclaimers for TI products.

TI objects to and rejects any additional or different terms you may have proposed.

Mailing Address: Texas Instruments, Post Office Box 655303, Dallas, Texas 75265  
Copyright © 2024, Texas Instruments Incorporated