

# Fibre Channel and SAN Clock Generation Using the CDCM6100x

Firoj Kabir and Johnny Lau

ICP - Clock Distribution Circuits

## ABSTRACT

This application report is a guide for using Texas Instruments CDCM6100x in a Fibre Channel application as a clock distributor and clock synthesizer along with measured jitter performance results.

## 1 Background

Today's networking boxes require clock generation and buffering. Traditional methods involved a clock oscillator and a clock buffer. For Fibre Channel and Storage Area Network (SAN) applications, a typical 106.25-MHz, 187.5-MHz, 212.5-MHz, or 250-MHz clock is needed. Due to the low jitter and accuracy needed for these clock oscillators, their cost are high. So how does a designer lower cost but maintain low jitter, high accuracy, and clock buffering in a single solution? The CDCM6100x answers this question.

## 2 Functional Description

The CDCM6100x is a highly versatile, low-jitter frequency synthesizer which can generate low jitter clock outputs, selectable among LVPECL, LVDS, or LVCMOS, from a low-frequency crystal or LVCMOS input for a variety of wireline and data communication applications. The CDCM6100x features an on-chip PLL that can be easily configured solely through control pins. The overall output jitter performance is less than 1 ps, rms or 35 ps, pk-pk, thus making these devices a perfect choice to use in demanding applications like Fibre Channel, Ethernet, and SAN. The CDCM6100x is packaged in a small 32-pin, 5-mm × 5-mm QFN package. The CDCM6100x is available in one-, two-, and four-output versions.

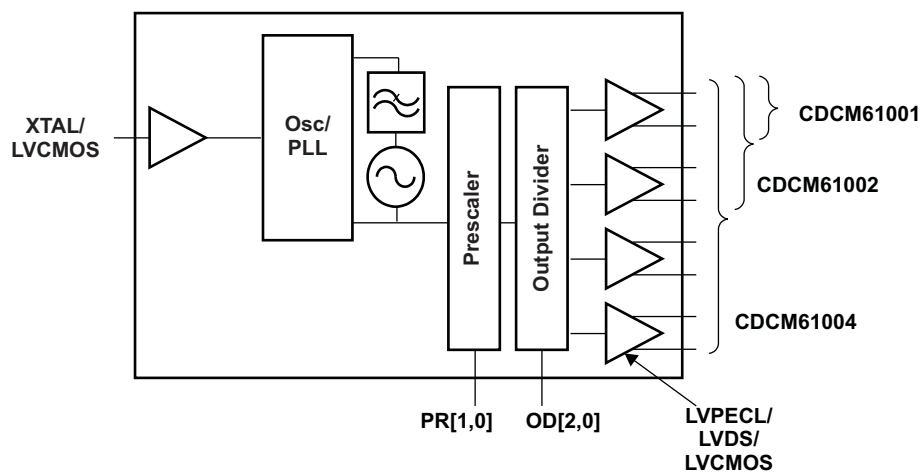

**Figure 1. CDCM6100x Functional Block Diagram**

### 3 Application

Today's Fibre Channel and SAN clocking require low jitter (typ < 1 ps rms or lower). Typical Fibre Channel and SAN clock speeds are 106.25 MHz, 187.5 MHz, 212.5 MHz, or 250 MHz. For these systems, the output signal type needed can be differential (LVPECL or LVDS) or single-ended 3.3-V LVCMOS. This application report demonstrates solutions that can meet these needs while also offering a lower cost solution to today's high-priced oscillators and clock buffers.

### 4 Test Equipment and Setup

All the measurements discussed in this application report were taken under normal operating conditions using a 3.3-V power supply and at room temperature.

Equipment used:

- Agilent E5052A Signal Source Analyzer
- Power supply
- CDCM6100x EVM

### 5 Block Diagram and Jitter Test Results of Fibre Channel Solutions

The two following solutions show how to generate clocks from the CDCM6100x devices and a low-cost, standard 26.5625-MHz crystal. The 26.5625 MHz is fed into the CDCM6100x VCO core to generate a 106.25-MHz or 212.5-MHz frequency available to the output buffer. The output signal type can be native LVPECL, LVDS, or LVCMOS. These examples select LVPECL for the output buffers but also included are some LVDS and LVCMOS measurements at the end of this application report.

#### 5.1 Fibre Channel Solution 1 Block Diagram:

Solution 1 uses the four-output version CDCM61004 to generate 106.25 MHz. If less outputs are needed, the CDCM61001 or CDCM61002 can supply one or two outputs, respectively.



**Figure 2. FC Block Diagram 1**

**5.2 Fibre Channel Solution 1 Jitter Test Results:**

**OUT\_0 = 106.25-MHz LVPECL – RMS Jitter is 485 fsec (10 kHz–20 MHz)**

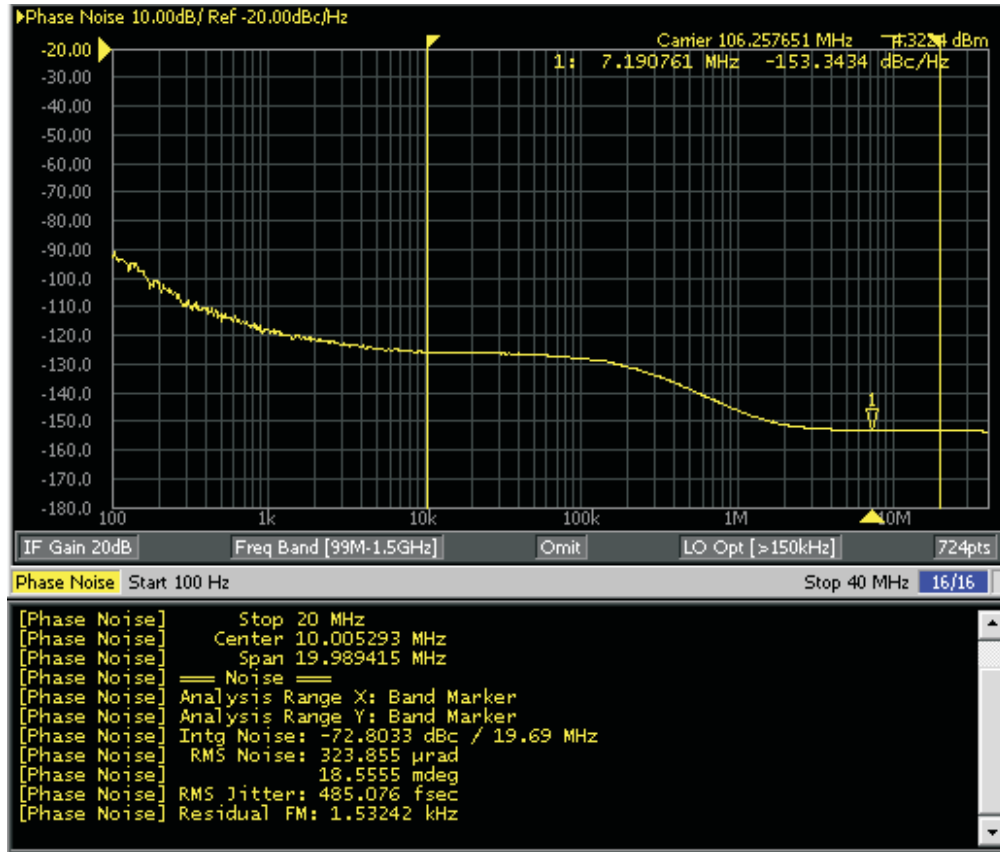

OUT\_1 = 106.25-MHz LVPECL – RMS Jitter is 486 fsec (10 kHz–20 MHz)

www.ti.com

OUT\_1 = 106.25-MHz LVPECL – RMS Jitter is 486 fsec (10 kHz–20 MHz)

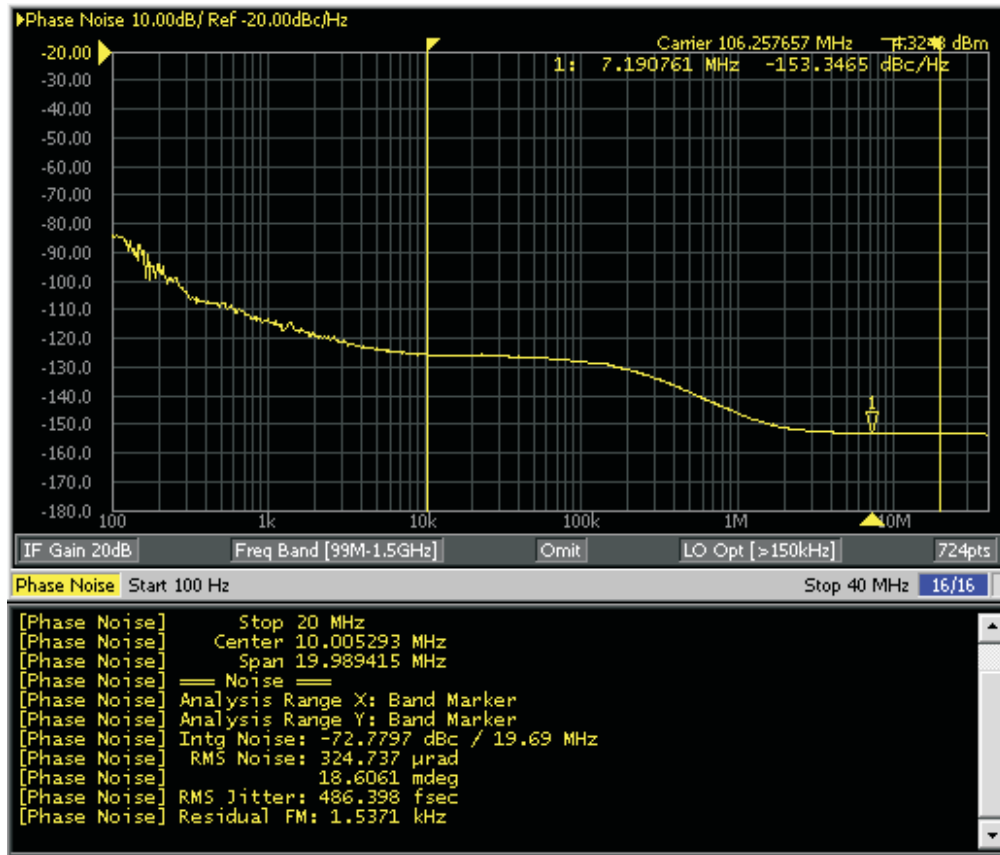

**OUT\_2 = 106.25-MHz LVPECL – RMS Jitter is 487 fsec (10 kHz–20 MHz)**

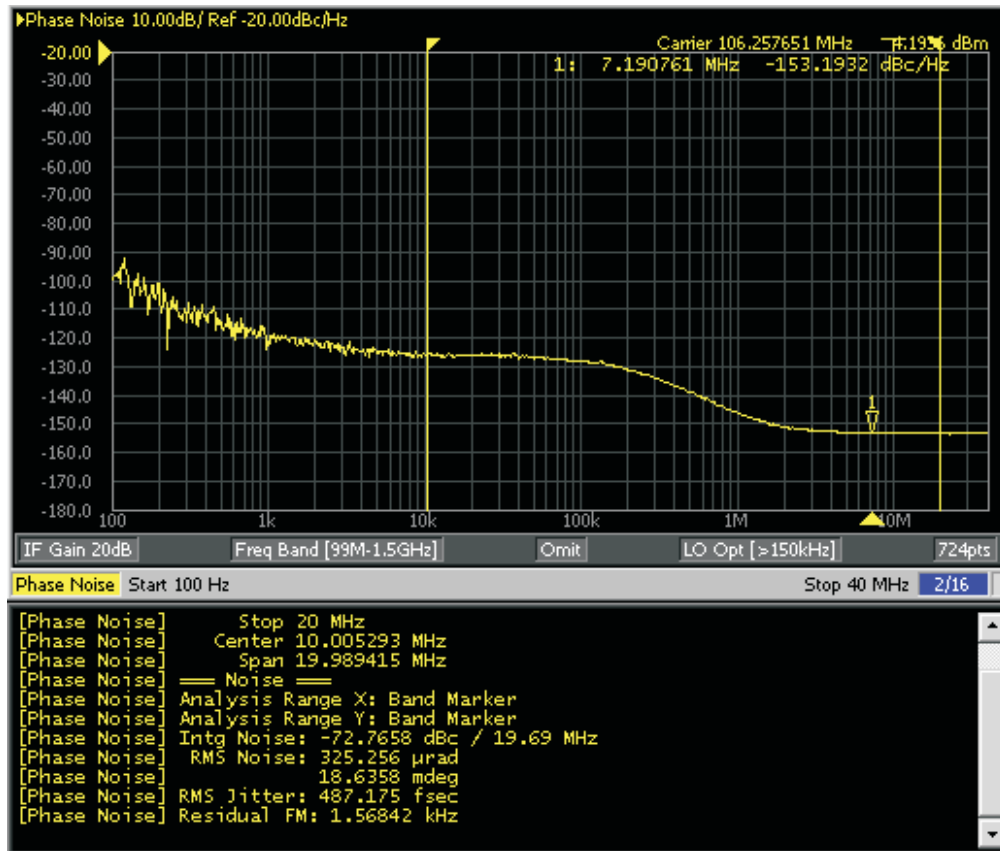

OUT\_3 = 106.25-MHz LVPECL – RMS Jitter is 486 fsec (10 kHz–20 MHz)

www.ti.com

**OUT\_3 = 106.25-MHz LVPECL – RMS Jitter is 486 fsec (10 kHz–20 MHz)**

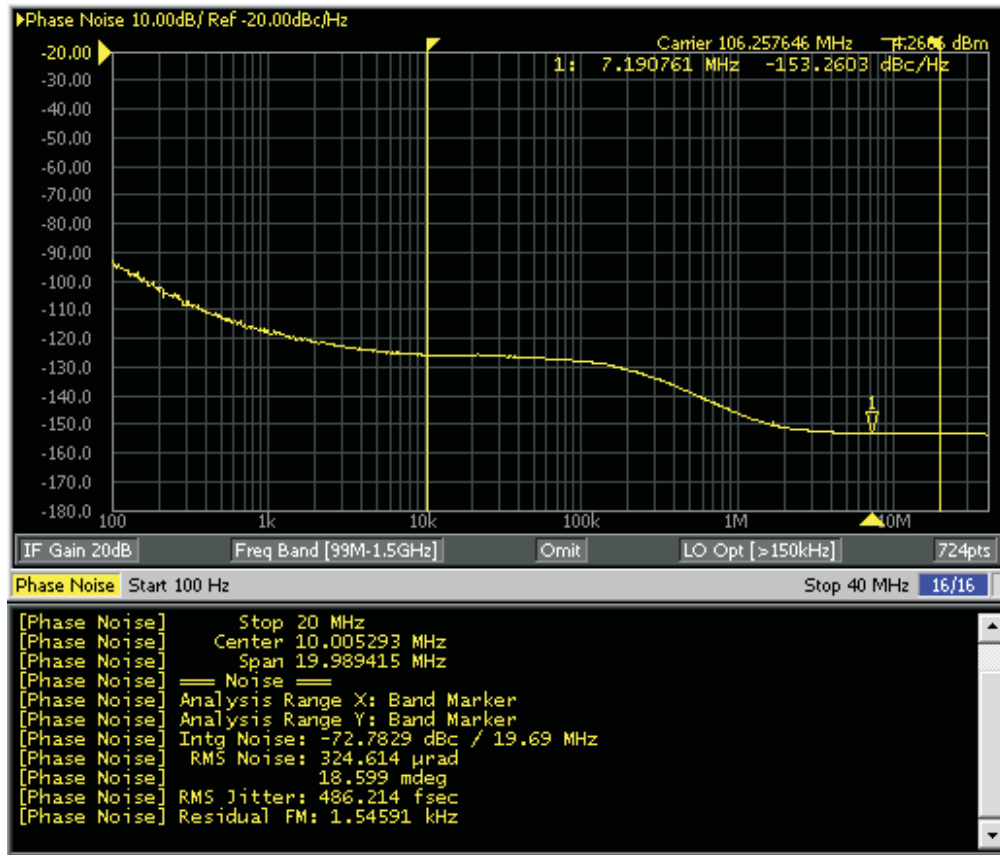

### 5.3 Fibre Channel Solution 2 Block Diagram:

Solution 2 uses the two-outputs version CDCM61002 to generate two copies of 212.5 MHz. If more or less outputs are needed, the CDCM61001 or CDCM61004 supplies one or four outputs, respectively.



Figure 3. FC Block Diagram # 2

### 5.4 Fibre Channel Solution 2 Jitter Test Results:

OUT\_0 = 212.5-MHz LVPECL – RMS Jitter is 468 fsec (10 kHz–20 MHz)

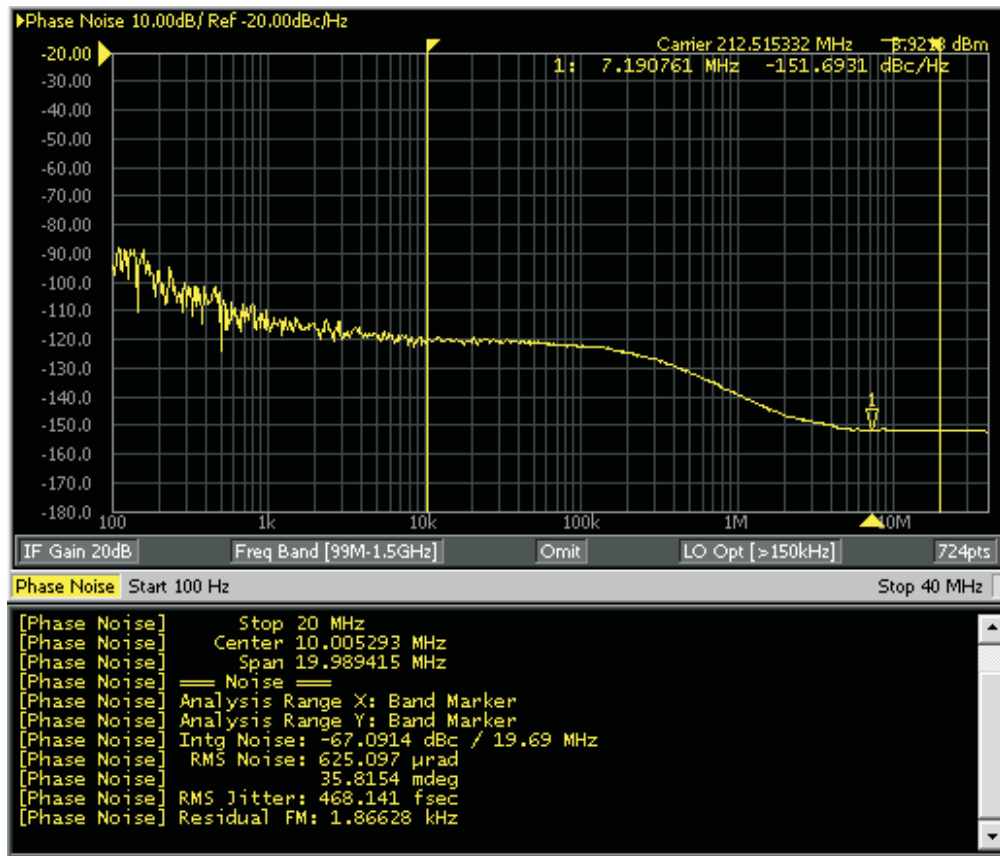

**OUT\_1 = 212.5-MHz LVPECL – RMS Jitter is 470 fsec (10 kHz–20 MHz)**

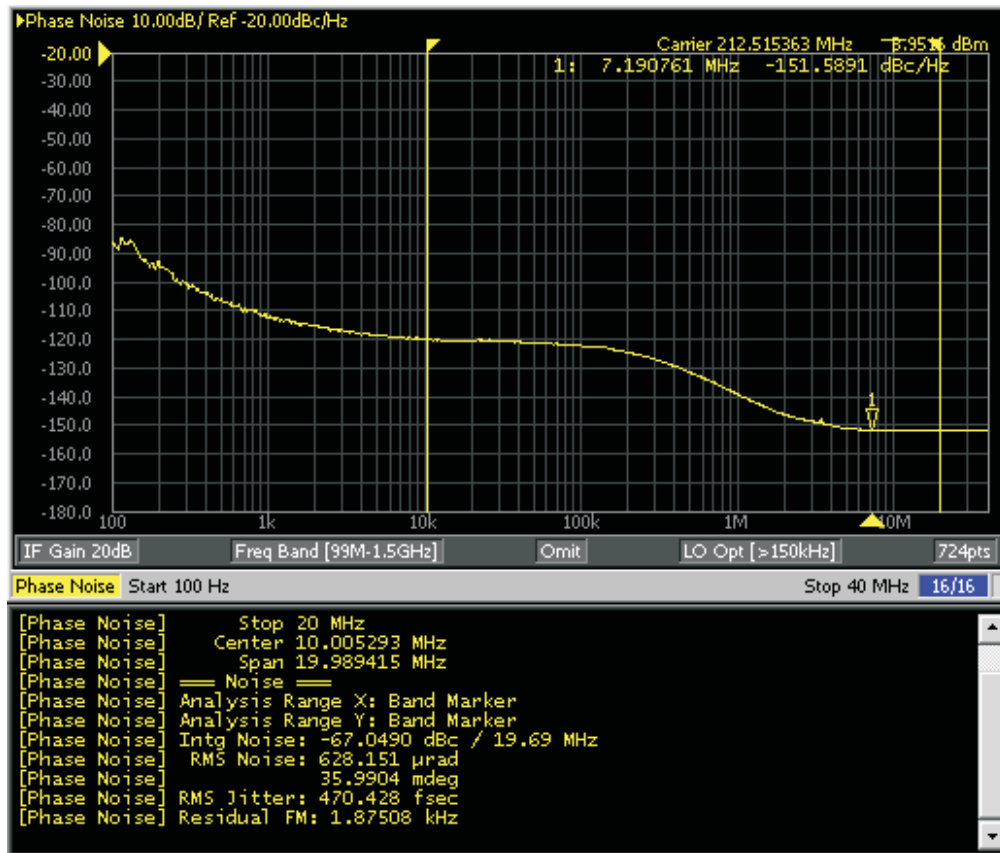

**6 Block Diagram and Jitter Test Results of SAN Solutions**

The following two solutions show how to generate SAN clocks from the CDCM6100x devices and a low-cost, standard, 25-MHz crystal. The 25 MHz is fed into the CDCM6100x VCO core to generate a 187.5-MHz or 250-MHz frequency available to the output buffer. The output signal type can be native LVPECL, LVDS, or LVCMOS. These examples select LVPECL for the output buffers.

**6.1 SAN Solution 1 Block Diagram:**

SAN Solution 1 uses the one-output version CDCM61001 to generate 187.5 MHz. If more outputs are needed the CDCM61002 and CDCM61004 can supply two or four outputs, respectively.

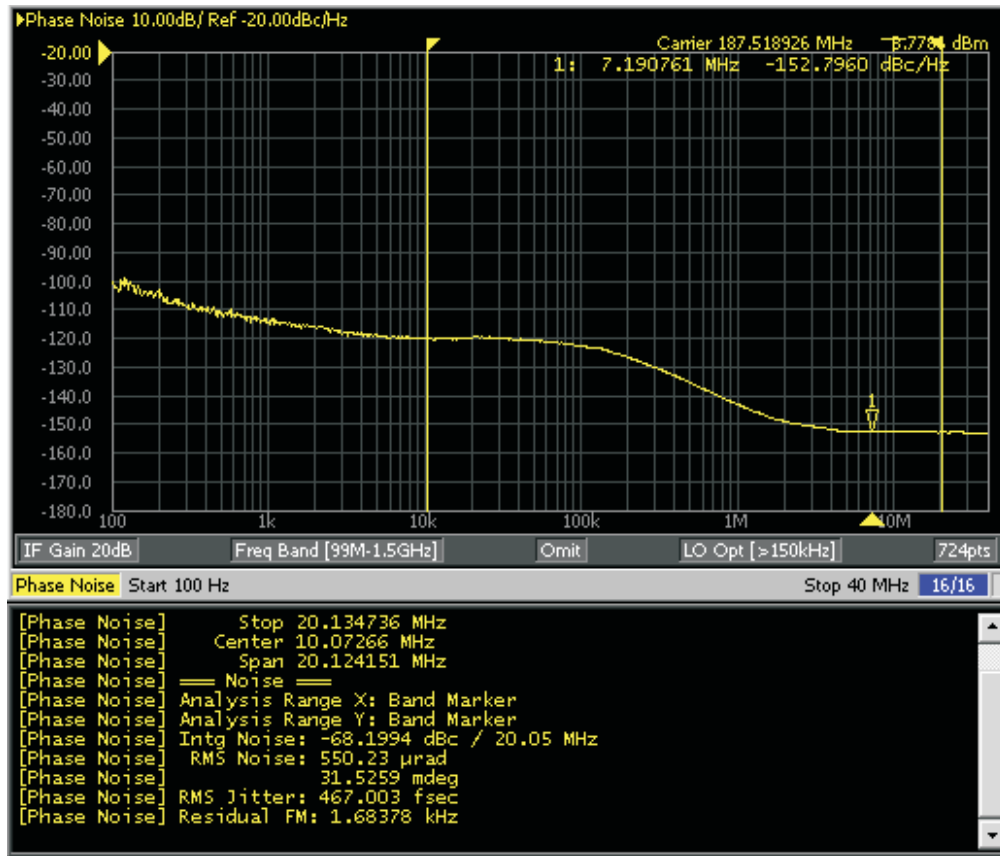

Figure 4. SAN Block Diagram 1



### 6.2 SAN Solution 1 Jitter Test Results:

OUT\_0 = 187.5-MHz LVPECL – RMS Jitter is 467 fsec (10 kHz – 20 MHz)



### 6.3 SAN Solution 2 Block Diagram:

Solution 2 uses the four-output version CDCM61004 to generate four copies of 250 MHz. If less outputs are needed, the CDCM61001 or CDCM61002 supplies one or two outputs, respectively.

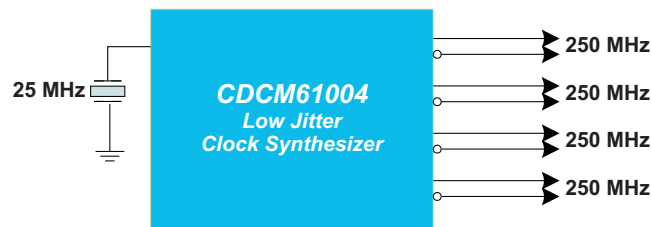
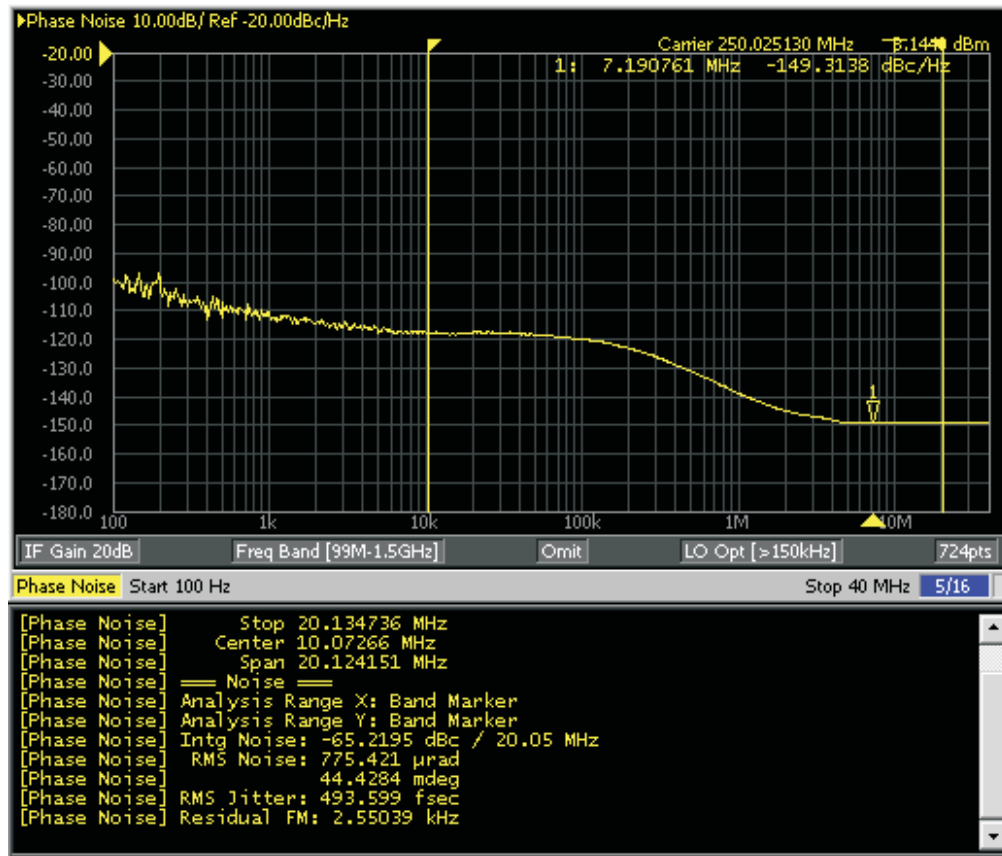

Figure 5. SAN Block Diagram 2

### 6.4 SAN Solution 2 Jitter Test Results:

OUT\_0 = 250-MHz LVPECL – RMS Jitter is 494 fsec (10 kHz – 20 MHz)



OUT\_1 = 250-MHz LVPECL – RMS Jitter is 490 fsec (10 kHz – 20 MHz)

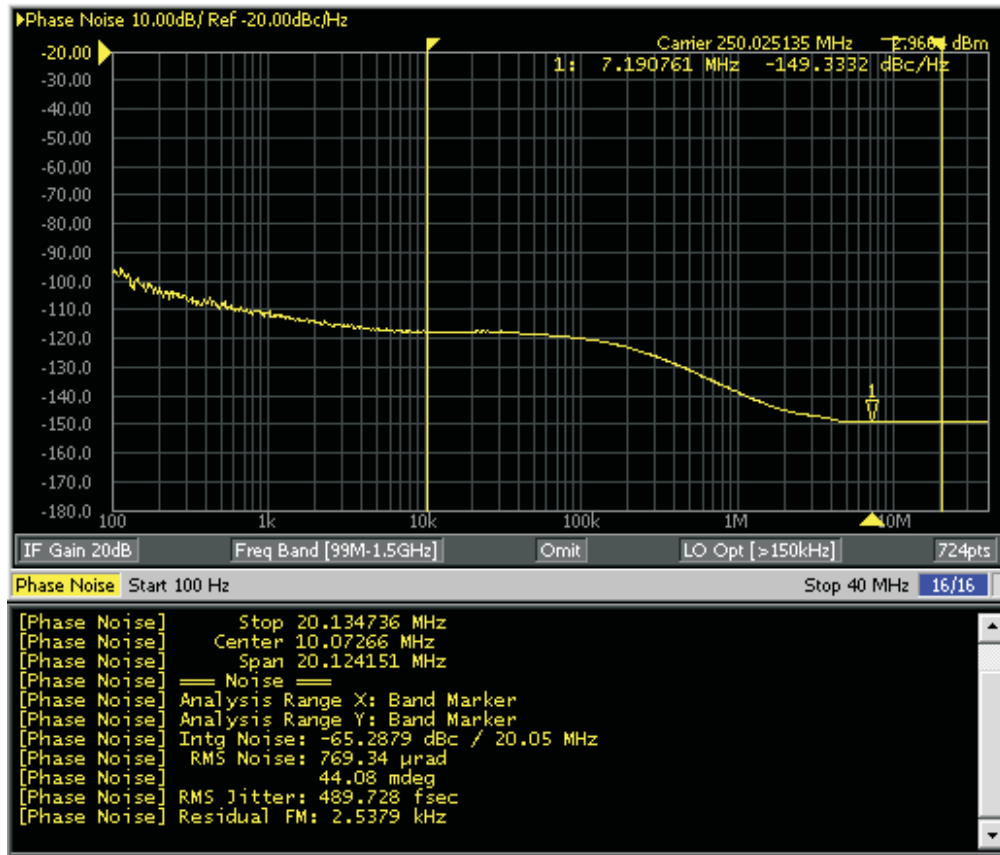

OUT\_2 = 250-MHz LVPECL – RMS Jitter is 496 fsec (10 kHz – 20 MHz)

www.ti.com

**OUT\_2 = 250-MHz LVPECL – RMS Jitter is 496 fsec (10 kHz – 20 MHz)**

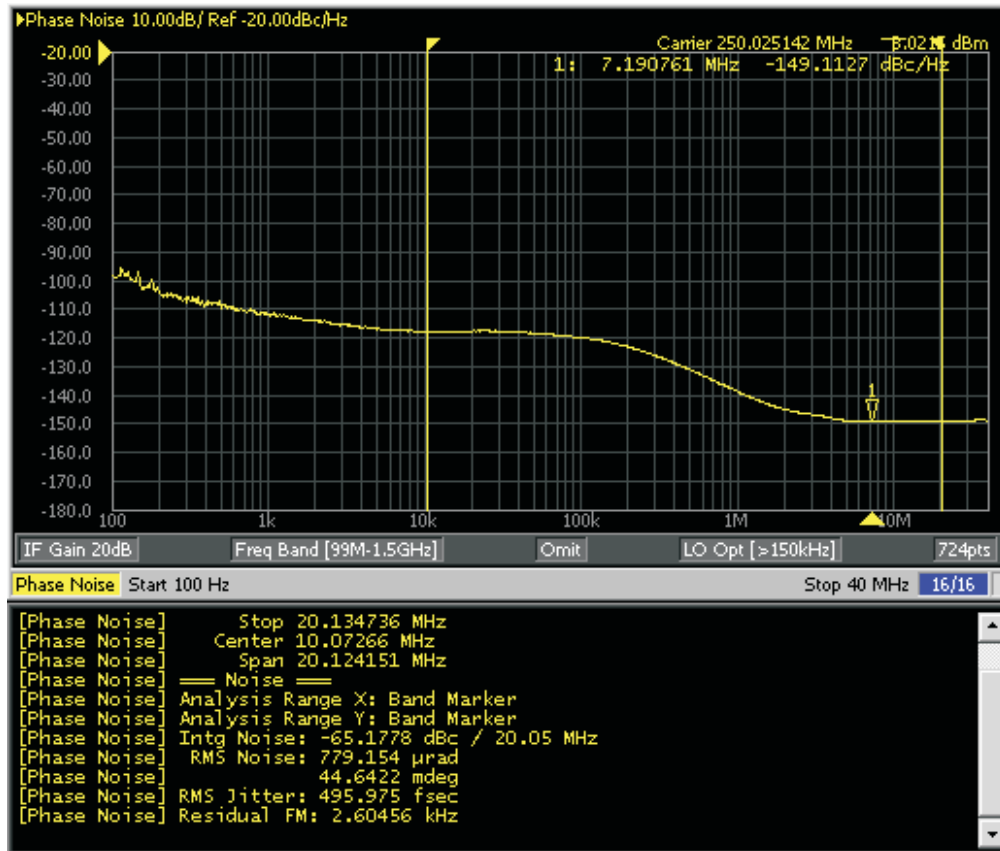

**OUT\_3 = 250-MHz LVPECL – RMS Jitter is 490 fsec (10 kHz – 20 MHz)**

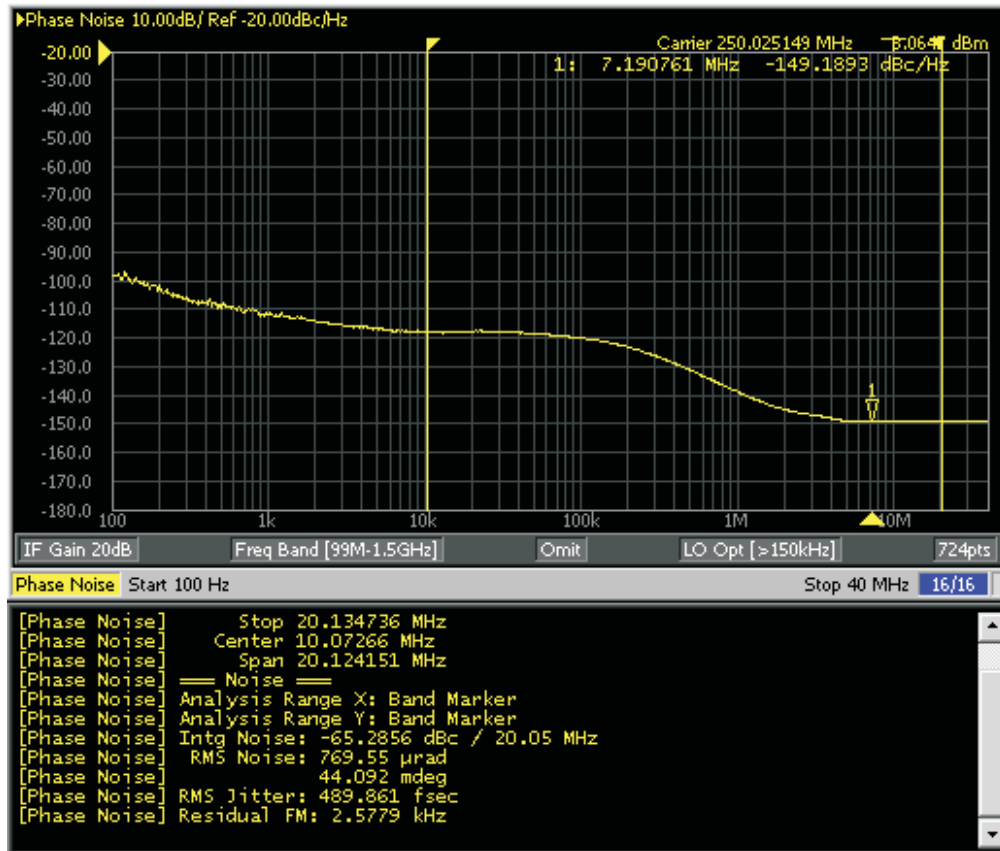

## 7 Performance Summary

### 7.1 Fibre Channel Configurations

Performance results of these Fibre Channel configurations are:

1. **CDCM61004 = 106.25 MHz**
  - OUT\_0 = 106.25-MHz LVPECL – **RMS Jitter is 485 fsec** (10 kHz–20 MHz)
  - OUT\_1 = 106.25-MHz LVPECL – **RMS Jitter is 486 fsec** (10 kHz–20 MHz)
  - OUT\_2 = 106.25-MHz LVPECL – **RMS Jitter is 487 fsec** (10 kHz–20 MHz)
  - OUT\_3 = 106.25-MHz LVPECL – **RMS Jitter is 486 fsec** (10 kHz–20 MHz)
2. **CDCM61002 = 212.5 MHz**
  - OUT\_0 = 212.5-MHz LVPECL – **RMS Jitter is 468 fsec** (10 kHz–20 MHz)
  - OUT\_1 = 212.5-MHz LVPECL – **RMS Jitter is 470 fsec** (10 kHz–20 MHz)

### 7.2 SAN Configurations

Performance results of these SAN configuration are:

1. **CDCM61001 = 187.5 MHz**
  - OUT\_0 = 187.5-MHz LVPECL – **RMS Jitter is 467 fsec** (10 kHz–20 MHz)
2. **CDCM61004 = 250 MHz**
  - OUT\_0 = 250-MHz LVPECL – **RMS Jitter is 494 fsec** (10 kHz–20 MHz)
  - OUT\_1 = 250-MHz LVPECL – **RMS Jitter is 490 fsec** (10 kHz–20 MHz)
  - OUT\_2 = 250-MHz LVPECL – **RMS Jitter is 496 fsec** (10 kHz–20 MHz)
  - OUT\_3 = 250-MHz LVPECL – **RMS Jitter is 490 fsec** (10 kHz–20 MHz)

## 8 Additional Data

As previously mentioned, the CDCM6100x output type can be configured to LVPECL, LVDS, or LVCMOS. The following are some additional jitter measurements with LVDS and LVCMOS outputs

### 106.25-MHz LVDS – RMS Jitter is 537 fsec (10 kHz–20 MHz)

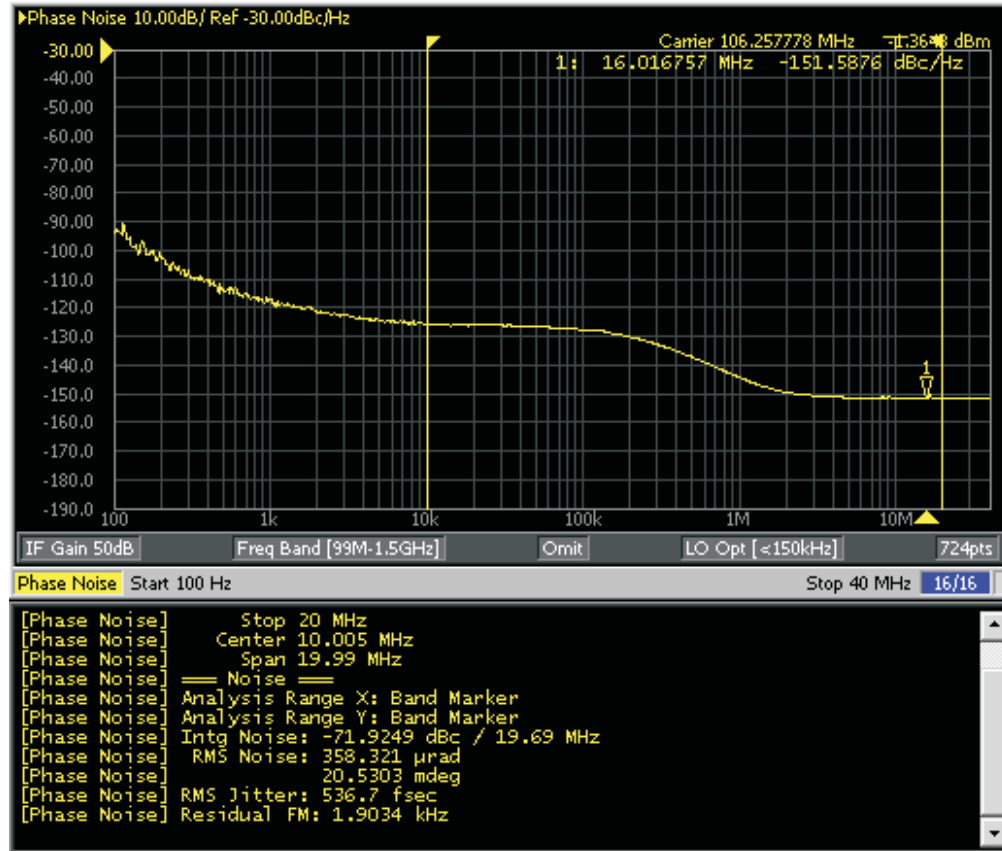

106.25-MHz LVCMOS – RMS Jitter is 505 fsec (10 kHz–20 MHz)

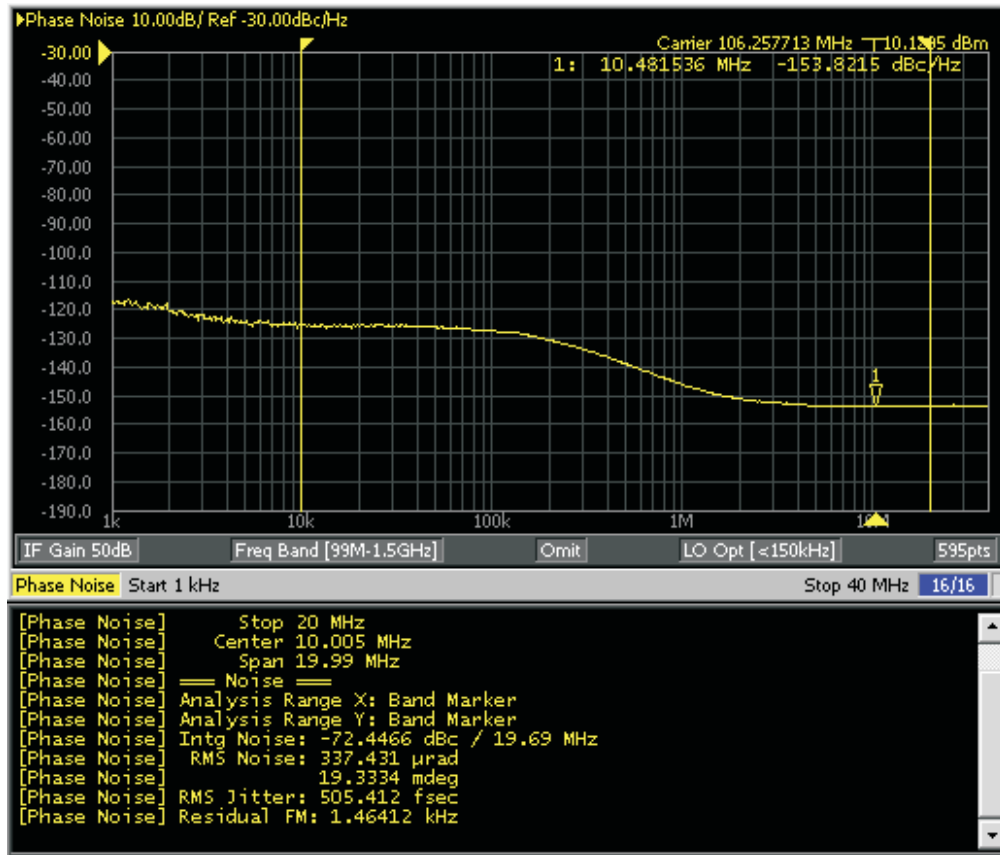

Conclusion

The CDCM6100x performance meets today’s Fibre Channel and SAN frequencies with low-jitter requirements, <1 ps RMS. It is a simple, hardware-configurable device that requires no preprogramming. The CDCM6100x is offered in a 32-pin, 5-mm × 5-mm QFN package. This single, 3.3-V device can replace the functionality of expensive oscillators and buffers. In addition to lowering cost, the CDCM6100x offers additional advanced features like a buffered crystal output for measuring the actual frequency of the input crystal.

## IMPORTANT NOTICE

Texas Instruments Incorporated and its subsidiaries (TI) reserve the right to make corrections, modifications, enhancements, improvements, and other changes to its products and services at any time and to discontinue any product or service without notice. Customers should obtain the latest relevant information before placing orders and should verify that such information is current and complete. All products are sold subject to TI's terms and conditions of sale supplied at the time of order acknowledgment.

TI warrants performance of its hardware products to the specifications applicable at the time of sale in accordance with TI's standard warranty. Testing and other quality control techniques are used to the extent TI deems necessary to support this warranty. Except where mandated by government requirements, testing of all parameters of each product is not necessarily performed.

TI assumes no liability for applications assistance or customer product design. Customers are responsible for their products and applications using TI components. To minimize the risks associated with customer products and applications, customers should provide adequate design and operating safeguards.

TI does not warrant or represent that any license, either express or implied, is granted under any TI patent right, copyright, mask work right, or other TI intellectual property right relating to any combination, machine, or process in which TI products or services are used. Information published by TI regarding third-party products or services does not constitute a license from TI to use such products or services or a warranty or endorsement thereof. Use of such information may require a license from a third party under the patents or other intellectual property of the third party, or a license from TI under the patents or other intellectual property of TI.

Reproduction of TI information in TI data books or data sheets is permissible only if reproduction is without alteration and is accompanied by all associated warranties, conditions, limitations, and notices. Reproduction of this information with alteration is an unfair and deceptive business practice. TI is not responsible or liable for such altered documentation. Information of third parties may be subject to additional restrictions.

Resale of TI products or services with statements different from or beyond the parameters stated by TI for that product or service voids all express and any implied warranties for the associated TI product or service and is an unfair and deceptive business practice. TI is not responsible or liable for any such statements.

TI products are not authorized for use in safety-critical applications (such as life support) where a failure of the TI product would reasonably be expected to cause severe personal injury or death, unless officers of the parties have executed an agreement specifically governing such use. Buyers represent that they have all necessary expertise in the safety and regulatory ramifications of their applications, and acknowledge and agree that they are solely responsible for all legal, regulatory and safety-related requirements concerning their products and any use of TI products in such safety-critical applications, notwithstanding any applications-related information or support that may be provided by TI. Further, Buyers must fully indemnify TI and its representatives against any damages arising out of the use of TI products in such safety-critical applications.

TI products are neither designed nor intended for use in military/aerospace applications or environments unless the TI products are specifically designated by TI as military-grade or "enhanced plastic." Only products designated by TI as military-grade meet military specifications. Buyers acknowledge and agree that any such use of TI products which TI has not designated as military-grade is solely at the Buyer's risk, and that they are solely responsible for compliance with all legal and regulatory requirements in connection with such use.

TI products are neither designed nor intended for use in automotive applications or environments unless the specific TI products are designated by TI as compliant with ISO/TS 16949 requirements. Buyers acknowledge and agree that, if they use any non-designated products in automotive applications, TI will not be responsible for any failure to meet such requirements.

Following are URLs where you can obtain information on other Texas Instruments products and application solutions:

### Products

Amplifiers	<a href="http://amplifier.ti.com">amplifier.ti.com</a>
Data Converters	<a href="http://dataconverter.ti.com">dataconverter.ti.com</a>
DLP® Products	<a href="http://www.dlp.com">www.dlp.com</a>
DSP	<a href="http://dsp.ti.com">dsp.ti.com</a>
Clocks and Timers	<a href="http://www.ti.com/clocks">www.ti.com/clocks</a>
Interface	<a href="http://interface.ti.com">interface.ti.com</a>
Logic	<a href="http://logic.ti.com">logic.ti.com</a>
Power Mgmt	<a href="http://power.ti.com">power.ti.com</a>
Microcontrollers	<a href="http://microcontroller.ti.com">microcontroller.ti.com</a>
RFID	<a href="http://www.ti-rfid.com">www.ti-rfid.com</a>
RF/IF and ZigBee® Solutions	<a href="http://www.ti.com/lprf">www.ti.com/lprf</a>

### Applications

Audio	<a href="http://www.ti.com/audio">www.ti.com/audio</a>
Automotive	<a href="http://www.ti.com/automotive">www.ti.com/automotive</a>
Broadband	<a href="http://www.ti.com/broadband">www.ti.com/broadband</a>
Digital Control	<a href="http://www.ti.com/digitalcontrol">www.ti.com/digitalcontrol</a>
Medical	<a href="http://www.ti.com/medical">www.ti.com/medical</a>
Military	<a href="http://www.ti.com/military">www.ti.com/military</a>
Optical Networking	<a href="http://www.ti.com/opticalnetwork">www.ti.com/opticalnetwork</a>
Security	<a href="http://www.ti.com/security">www.ti.com/security</a>
Telephony	<a href="http://www.ti.com/telephony">www.ti.com/telephony</a>
Video & Imaging	<a href="http://www.ti.com/video">www.ti.com/video</a>
Wireless	<a href="http://www.ti.com/wireless">www.ti.com/wireless</a>

Mailing Address: Texas Instruments, Post Office Box 655303, Dallas, Texas 75265  
Copyright © 2009, Texas Instruments Incorporated