

TLC6A598 Power Logic 8-Bit Shift Register Evaluation Module



ABSTRACT

This user's guide describes the characteristics, setup, and usage of the TLC6A598 evaluation module (EVM). The TLC6A598EVM helps the user to evaluate the features of the Texas Instruments TLC6A598, power logic 8-Bit shift register. This user's guide includes hardware setup instructions, graphical user interface (GUI) instructions, printed-circuit board (PCB) layout drawings, a schematic diagram, and a bill of materials.

Table of Contents

1 Introduction	2
2 Test Setup	4
3 Design Files	10
3.1 Layout.....	10
3.2 Schematic.....	11
3.3 BOM.....	12

List of Figures

Figure 1-1. TLC6A598EVM Kit.....	2
Figure 2-1. TLC6A598EVM Test Bench Setup.....	4
Figure 2-2. USB2ANY Explorer.....	5
Figure 2-3. GPIO and SPI Selection.....	6
Figure 2-4. GPIO3 Configuration.....	7
Figure 2-5. SPI Configuration.....	8
Figure 2-6. Data Write with SPI Interface.....	9
Figure 3-1. TLC6A598EVM Top Layer.....	10
Figure 3-2. TLC6A598EVM Bottom Layer.....	11
Figure 3-3. TLC6A598EVM Schematic.....	12

List of Tables

Table 1-1. TLC6A598EVM Electrical Specifications.....	3
Table 2-1. TLC6A598EVM Connectors and Test Points.....	4
Table 3-1. TLC6A598EVM Bill of Materials (BOM).....	12

Trademarks

All trademarks are the property of their respective owners.

1 Introduction

The TLC6A598 evaluation module (EVM) helps designers evaluate the operation and performance of the TLC6A598 8-Bit Shift Register designed for the high current multi-load application. The TLC6A598 device is a monolithic, high-voltage, high-current power 8-bit shift register designed for systems that require relatively high load power, such as LEDs. The device contains a built-in voltage clamp on the outputs for inductive transient protection. Power driver applications include relays, solenoids, and other high current or high voltage loads. Each open-drain DMOS transistor features an independent chopping current limiting circuit to prevent damage in the case of a short circuit.

The TLC6A598EVM provides an eight-channel relays control example solution. It is designed to operate with two supply power rails, one power rail for the TLC6A598 and another power rail for the relays. This evaluation board is designed to work with the [USB2ANY](#) board and [USB2ANY Explore Software](#). See the [TLC6A598 data sheet](#) for more information about the digital communication.

The LP5860EVM kit is illustrated in [Figure 1-1](#).

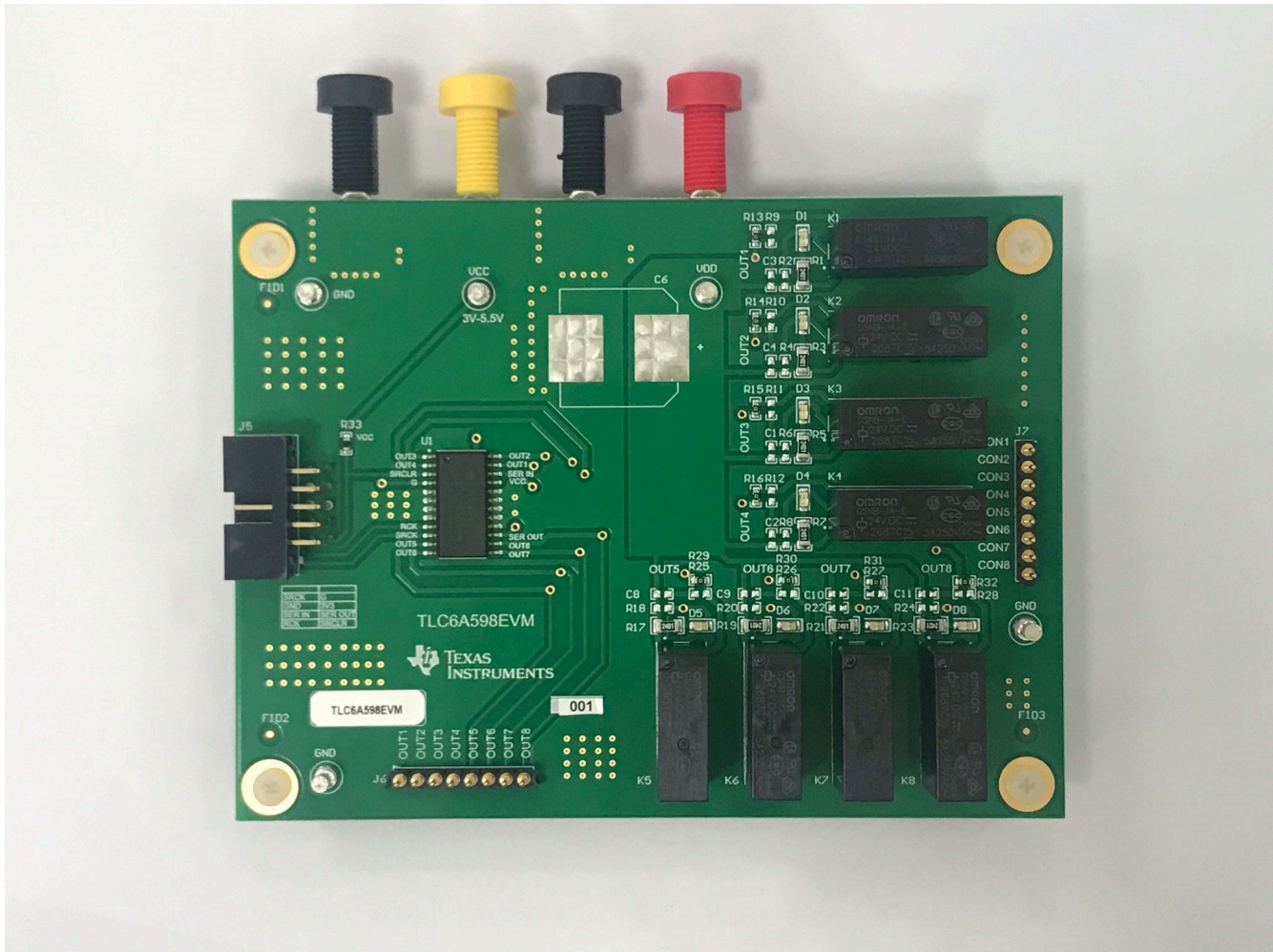

Figure 1-1. TLC6A598EVM Kit

This design describes an application of the TLC6A598 as a relay controller using the specifications shown in [Table 1-1](#). For applications with a different input voltage range or different output voltage and current, please refer to the [TLC6A598 data sheet](#).

Table 1-1. TLC6A598EVM Electrical Specifications

Parameter	Test Conditions	Min.	Typ.	Max.	Unit
Input voltage range, V_{CC}		3		5.5	V
Input voltage range, V_{DD}			24		V
Relay	G5NB-1A-E D24		8.3		mA

2 Test Setup

This section describes the test setup for the evaluation of the TLC6A598EVM board. [Table 2-1](#) shows the EVM connectors and test points.

Table 2-1. TLC6A598EVM Connectors and Test Points

Reference Designator	Function
J1	V_{CC}
J2	GND for V_{CC}
J3	V_{DD}
J4	GND for V_{DD}
J5	USB2ANY Connector
J6	Outputs connector for TLC6A598
J7	Outputs connector for Relays
TP1	Test point for V_{CC}
TP2	Test Point for V_{DD}
TP3, TP4, TP5	GND Test Point

The following equipment are required for the test setup:

- A power supply 1 capable of supplying 5 V @ 0.3 A is required to supply V_{CC} .
- A power supply 2 capable of supplying 24 V @ 1 A is required to supply V_{DD} .

To evaluate the TLC6A598EVM board, the USB2ANY interface adapter provided by TI is recommended here. Please download and install the [USB2ANY Explorer Software](#) on the computer.

[Figure 2-1](#) shows the test bench setup for the evaluation of the TLC6A598EVM board.

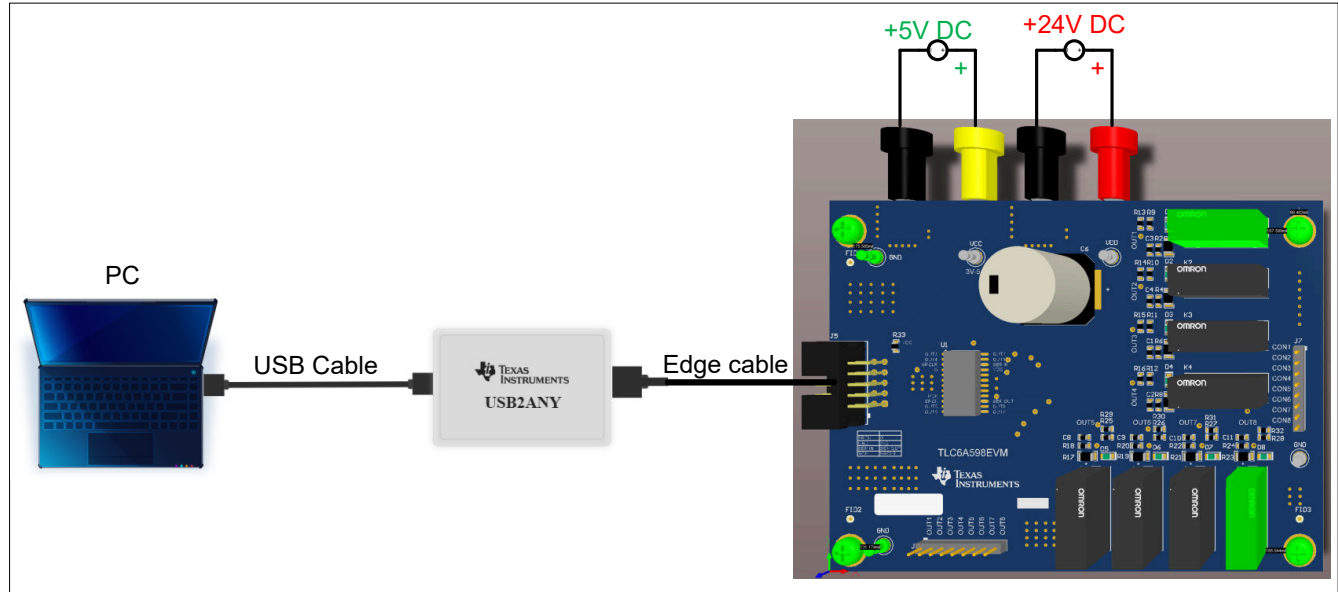

Figure 2-1. TLC6A598EVM Test Bench Setup

Set the input voltage power supply 1 to 5 V and the current limit to 0.3 A. Turn off the power supply 1. Connect the power supply 1 to the J1 and J2 connectors with the positive terminal of the supply connected to V_{CC} (J1) and the negative terminal of the supply connected to GND (J2). Set the input voltage power supply 2 to 24 V and the current limit to 1 A. Turn off the power supply 2. Connect the power supply 2 to the J3 and J4 connectors, with the positive terminal of the supply connected to V_{DD} (J3) and the negative terminal of the supply connected to GND (J4).

Connect the USB2ANY with Edge cable to J5 and connect USB2ANY to the PC with USB cable.

With above setup and connections completed, turn on the power supply 1 and 2. Then open the USB2ANY Explorer Software and the software will show as [Figure 2-2](#).

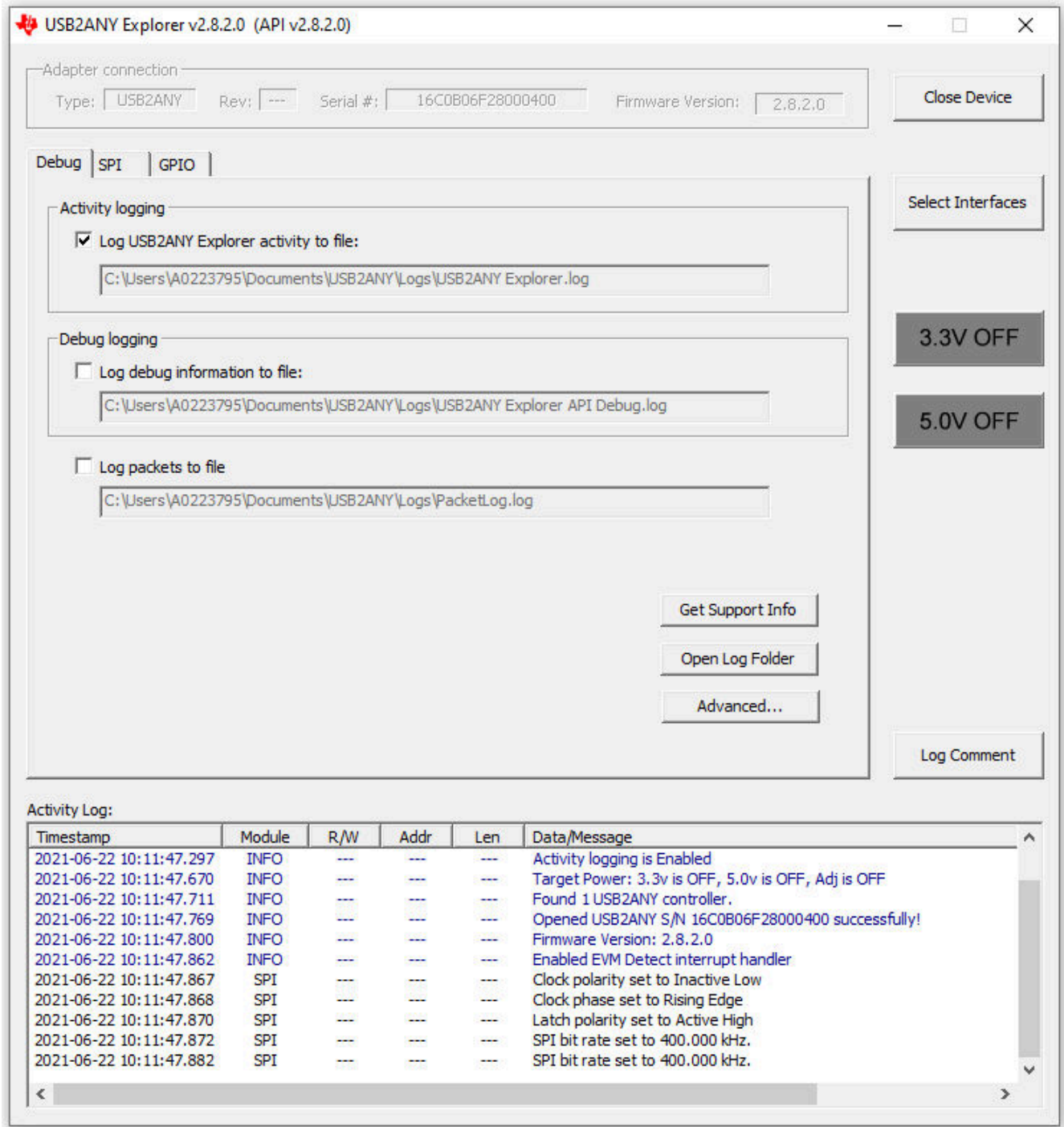

Figure 2-2. USB2ANY Explorer

Click the 'Select Interface' button and choose the 'GPIO' and 'SPI' as [Figure 2-3](#) and click the 'Close' button.

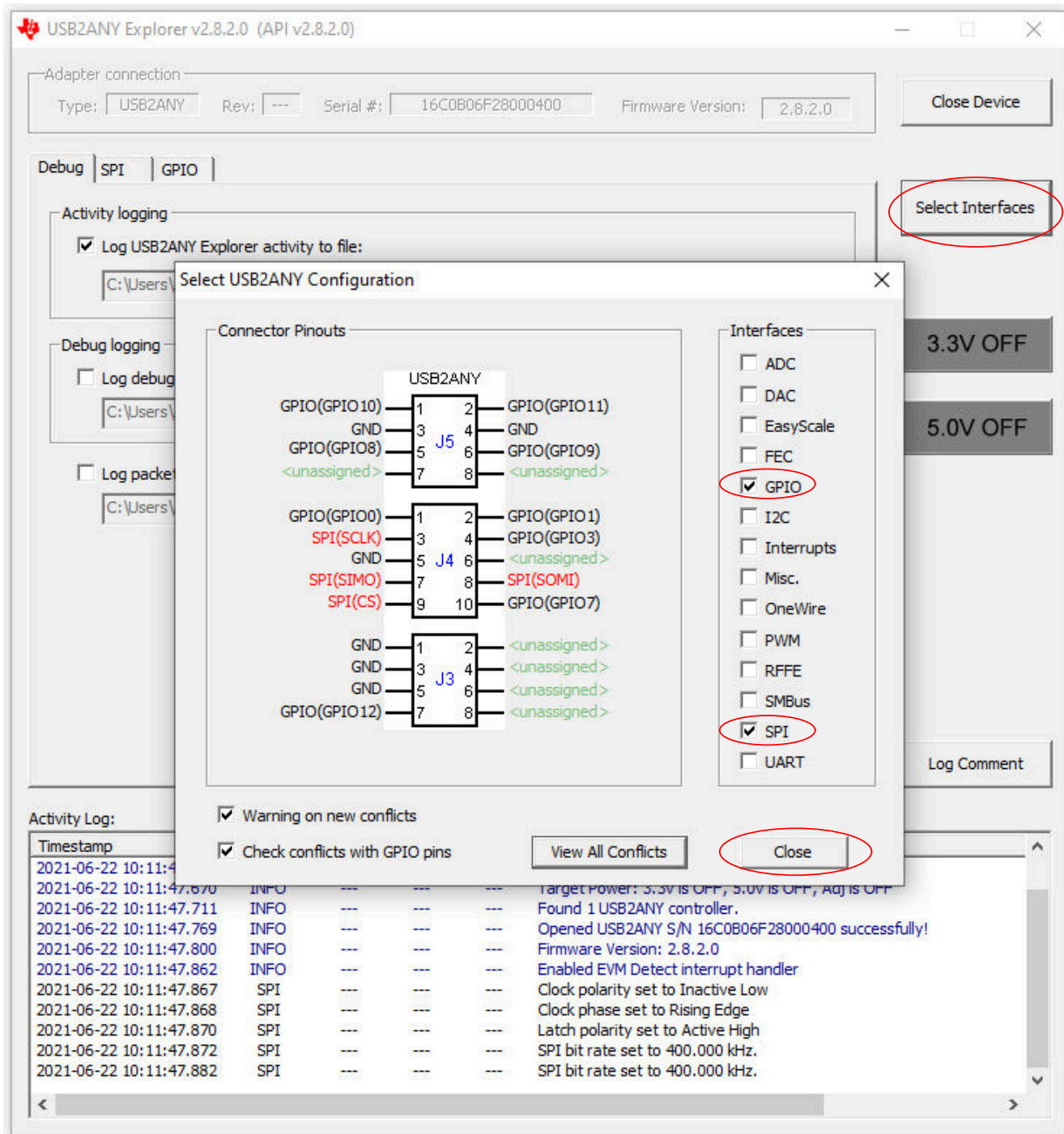

Figure 2-3. GPIO and SPI Selection

Click the 'GPIO' button and configure the GPIO3 as [Figure 2-4](#). If you cannot see the 'GPIO' button, please adjust the display scale of the PC to 100%.

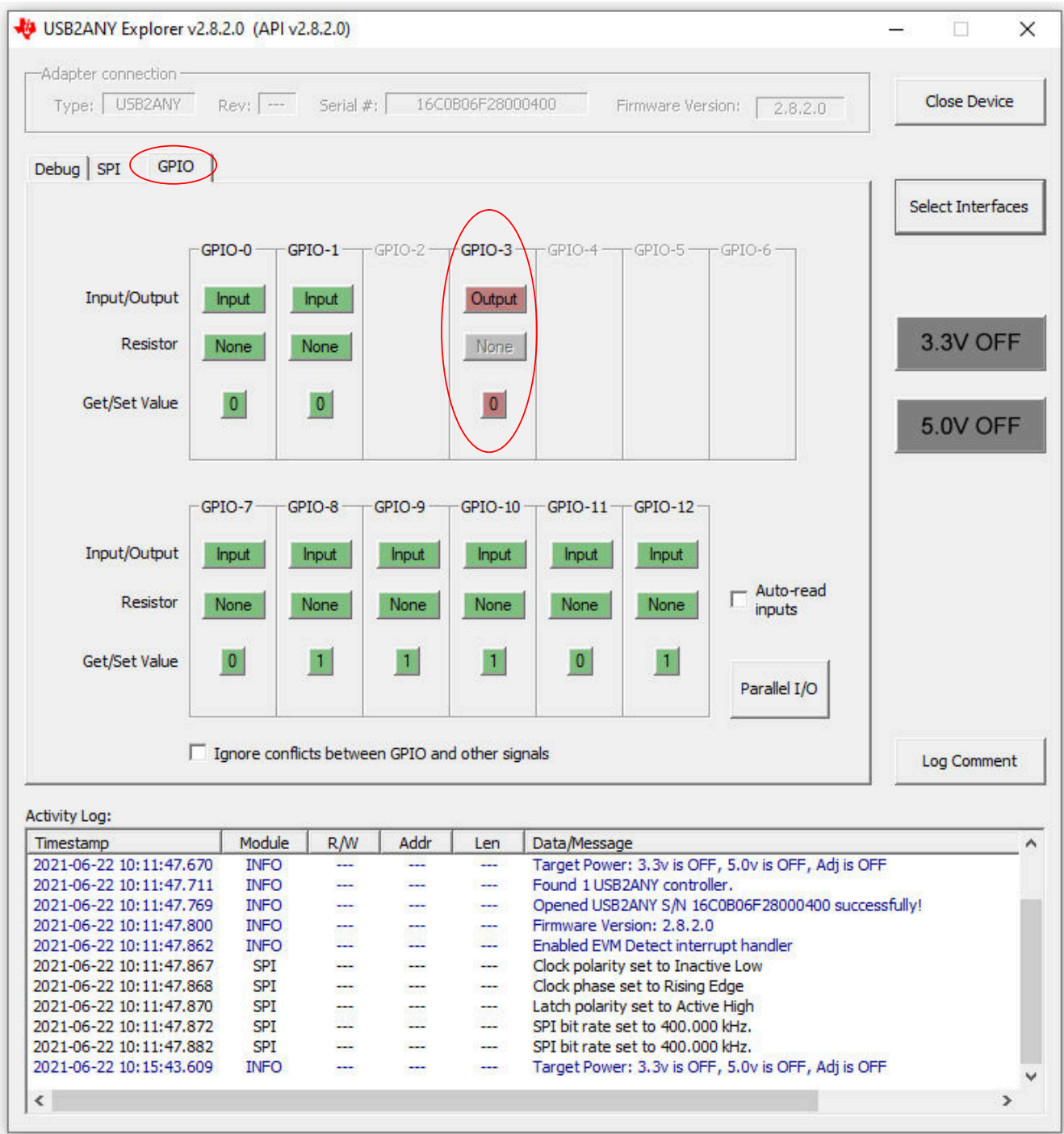

Figure 2-4. GPIO3 Configuration

Click the 'SPI' button and configure the SPI interface as [Figure 2-5](#):

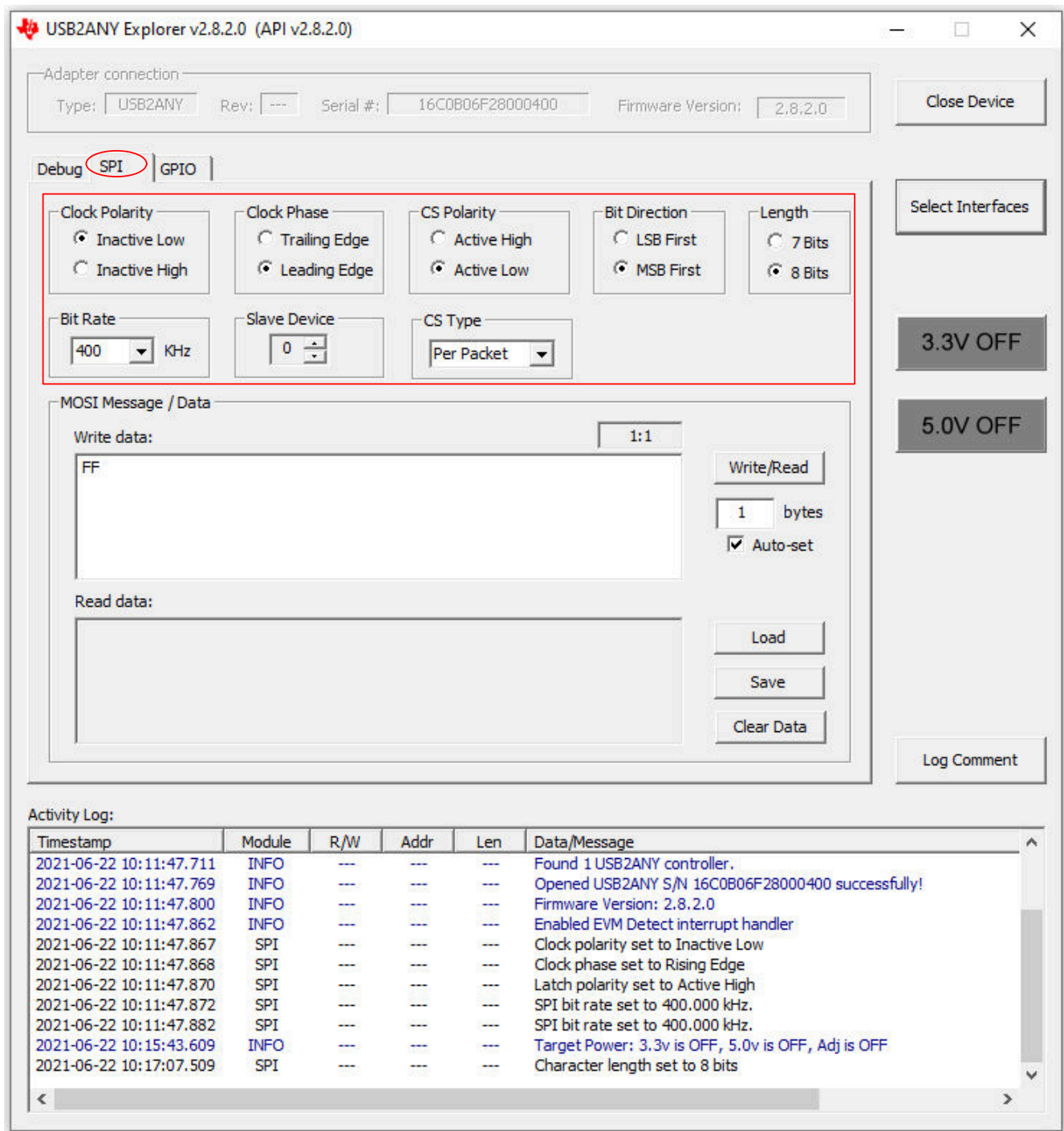

Figure 2-5. SPI Configuration

In the 'Write data' command window, write 'FF' and click 'Write/Read' button as [Figure 2-6](#):

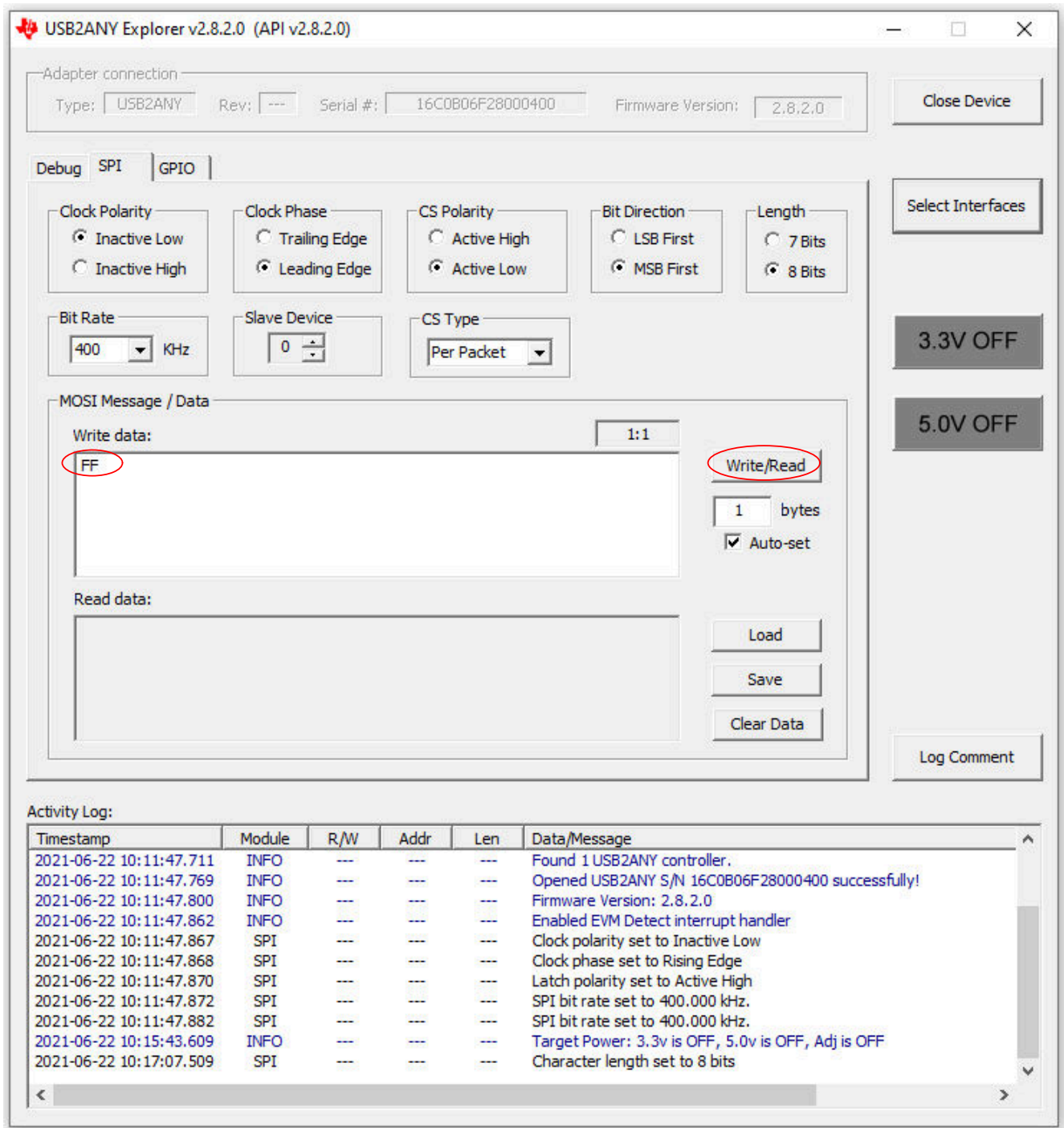

Figure 2-6. Data Write with SPI Interface

Then, the eight relays K1 to K8 will turn on and the eight Green LEDs D1 to D8 will turn on accordingly.

Please refer to the [TLC6A598 data sheet](#) for additional functional tests.

3 Design Files

The layout, schematic, and bill of materials (BOM) of the TLC6A598 EVM board design are included in this section.

3.1 Layout

Figure 3-1 and Figure 3-2 demonstrate the TLC6A598EVM layout images.

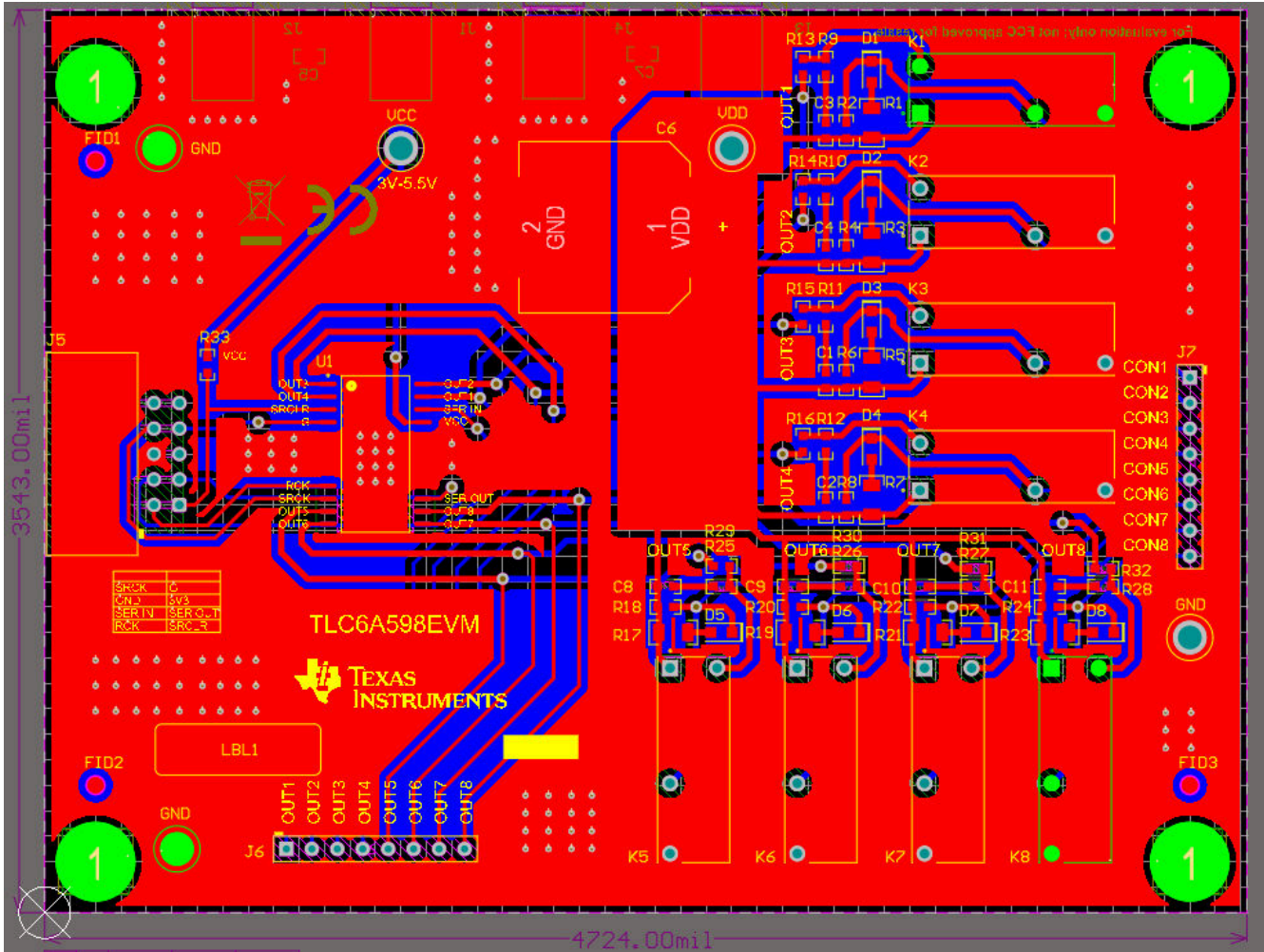

Figure 3-1. TLC6A598EVM Top Layer

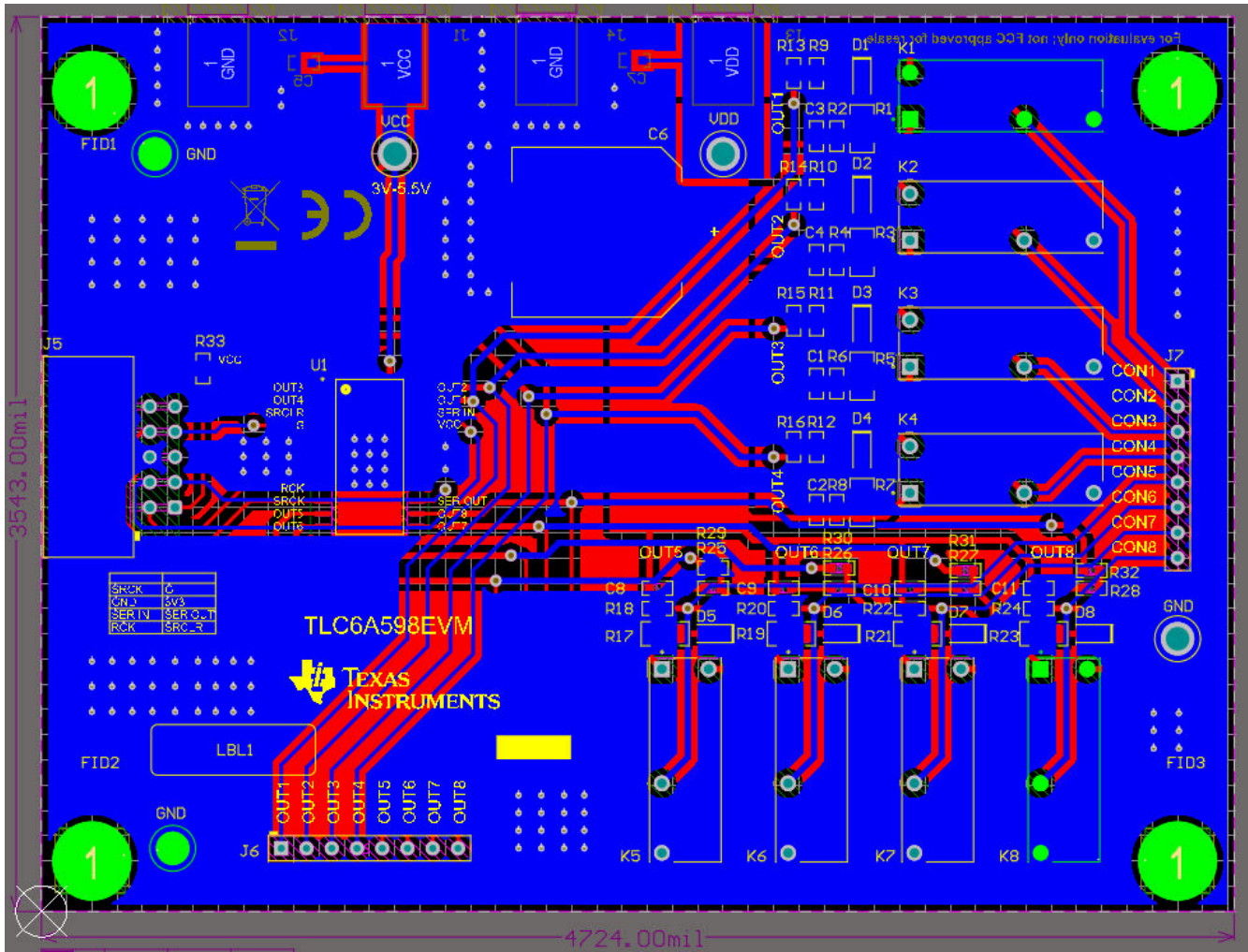

Figure 3-2. TLC6A598EVM Bottom Layer

3.2 Schematic

Figure 3-3 shows the TLC6A598EVM schematic.

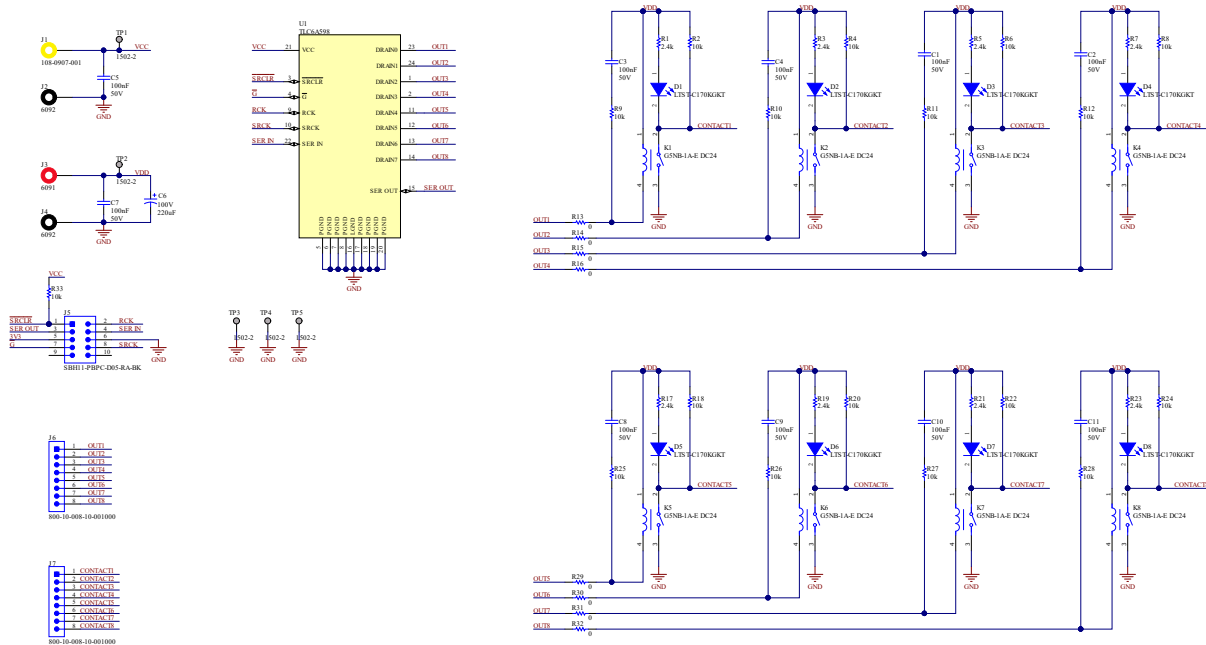

Figure 3-3. TLC6A598EVM Schematic

3.3 BOM

To download the bill of materials (BOM), see the design files at the [TLC6A598EVM tools](#) folder.

Table 3-1. TLC6A598EVM Bill of Materials (BOM)

Designator	Quantity	Description	Part Number	Manufacturer
C5, C7	2	CAP, CERM, 0.1 uF, 50 V, +/- 10%, X7R, 0603	06035C104KAT2A	AVX
D1, D2, D3, D4, D5, D6, D7, D8	8	LED, Green, SMD	LTST-C170KGKT	Lite-On
FID1, FID2, FID3	3	Fiducial mark. There is nothing to buy or mount.	N/A	N/A
H1, H2, H3, H4	4	Machine Screw, Round, #4-40 x 1/4, Nylon, Philips panhead	NY PMS 440 0025 PH	B&F Fastener Supply
H5, H6, H7, H8	4	Standoff, Hex, 0.5"L #4-40 Nylon	1902C	Keystone
J1	1	BANANA JACK, 15A, Insulated, Nylon, Yellow	108-0907-001	Cinch Connectivity
J2, J4	2	Standard Banana Jack, Insulated, Black	6092	Keystone
J3	1	Standard Banana Jack, Insulated, Red	6091	Keystone
J5	1	Header(shrouded), 2.54mm, 5x2, Gold, R/A, TH	SBH11-PBPC-D05-RA-BK	Sullins Connector Solutions
J6, J7	2	Header, 100mil, 8x1, TH	800-10-008-10-001000	Mill-Max

Table 3-1. TLC6A598EVM Bill of Materials (BOM) (continued)

Designator	Quantity	Description	Part Number	Manufacturer
K1, K2, K3, K4, K5, K6, K7, K8	8	General Purpose Relay SPST-NO (1 Form A) 24VDC Coil Through Hole	G5NB-1A-E DC24	Omron
R1, R3, R5, R7, R17, R19, R21, R23	8	RES, 2.4 k, 5%, 0.25 W, AEC-Q200 Grade 0, 1206	CRCW12062K40JNEA	Vishay-Dale
R13, R14, R15, R16, R29, R30, R31, R32	8	RES, 0, 5%, 0.1 W, 0603	RC0603JR-070RL	Yageo
R33	1	RES, 10 k, 5%, 0.1 W, AEC-Q200 Grade 0, 0603	CRCW060310K0JNEA	Vishay-Dale
TP1, TP2, TP3, TP4, TP5	5	Terminal, Turret, TH, Double	1502-2	Keystone
U1	1	50V, 350mA, 8ch Relay/LED Driver	TLC6A598	TI Will Provide Later
C1, C2, C3, C4, C8, C9, C10, C11	0	CAP, CERM, 0.1 uF, 50 V, +/- 10%, X7R, 0603	06035C104KAT2A	AVX
C6	0	CAP, AL, 220 uF, 100 V, +/- 20%, 0.16 ohm, SMD	EMVY101GTR221MLN0S	Chemi-Con
R2, R4, R6, R8, R9, R10, R11, R12, R18, R20, R22, R24, R25, R26, R27, R28	0	RES, 10 k, 5%, 0.1 W, AEC-Q200 Grade 0, 0603	CRCW060310K0JNEA	Vishay-Dale

IMPORTANT NOTICE AND DISCLAIMER

TI PROVIDES TECHNICAL AND RELIABILITY DATA (INCLUDING DATA SHEETS), DESIGN RESOURCES (INCLUDING REFERENCE DESIGNS), APPLICATION OR OTHER DESIGN ADVICE, WEB TOOLS, SAFETY INFORMATION, AND OTHER RESOURCES "AS IS" AND WITH ALL FAULTS, AND DISCLAIMS ALL WARRANTIES, EXPRESS AND IMPLIED, INCLUDING WITHOUT LIMITATION ANY IMPLIED WARRANTIES OF MERCHANTABILITY, FITNESS FOR A PARTICULAR PURPOSE OR NON-INFRINGEMENT OF THIRD PARTY INTELLECTUAL PROPERTY RIGHTS.

These resources are intended for skilled developers designing with TI products. You are solely responsible for (1) selecting the appropriate TI products for your application, (2) designing, validating and testing your application, and (3) ensuring your application meets applicable standards, and any other safety, security, regulatory or other requirements.

These resources are subject to change without notice. TI grants you permission to use these resources only for development of an application that uses the TI products described in the resource. Other reproduction and display of these resources is prohibited. No license is granted to any other TI intellectual property right or to any third party intellectual property right. TI disclaims responsibility for, and you will fully indemnify TI and its representatives against, any claims, damages, costs, losses, and liabilities arising out of your use of these resources.

TI's products are provided subject to [TI's Terms of Sale](#) or other applicable terms available either on ti.com or provided in conjunction with such TI products. TI's provision of these resources does not expand or otherwise alter TI's applicable warranties or warranty disclaimers for TI products.

TI objects to and rejects any additional or different terms you may have proposed.

Mailing Address: Texas Instruments, Post Office Box 655303, Dallas, Texas 75265
Copyright © 2022, Texas Instruments Incorporated