

bq3055

Technical Reference



Literature Number: SLUU440
January 2012

Preface	7
1 Detailed Description	9
1.1 JEITA Temperature Ranges	9
1.2 1st Level Protection Features	10
1.2.1 Cell Overvoltage (COV) and Cell Undervoltage (CUV)	10
1.2.2 Charge and Discharge Overcurrent	13
1.2.3 Short-Circuit Protection	18
1.2.4 Overtemperature Protection	19
1.2.5 AFE Watchdog	20
1.3 2nd-Level Protection Features	20
1.3.1 2nd-Level (Permanent) Failure Actions	21
1.3.2 Time Limit Based Protection	23
1.3.3 Limit Based Protection	24
1.3.4 Clearing Permanent Failure	26
1.4 Gas Gauging	26
1.4.1 CEDV Gas Gauging Operational Overview	26
1.4.2 Main Gas Gauge Registers	27
1.4.3 Capacity Learning (FCC Update) and Qualified Discharge	27
1.4.4 End-of-Discharge Thresholds and Capacity Correction	28
1.4.5 EDV Discharge Rate and Temperature Compensation	29
1.4.6 EDV Age Factor	30
1.4.7 Self-Discharge	30
1.4.8 Battery Electronic Load Compensation	31
1.4.9 CEDV Configuration	31
1.4.10 Initial Battery Capacity at Device Reset	31
1.4.11 Gas Gauge Operating Modes	32
1.4.12 Qmax	33
1.5 Charge Control	33
1.5.1 Charge Control SMBus Broadcasts	33
1.5.2 Charging and Temperature Ranges	34
1.5.3 Charge-Inhibit Mode	37
1.5.4 Charge-Suspend Mode	39
1.5.5 Pre-Charge Cfg	41
1.5.6 Primary Charge Termination	42
1.5.7 Discharge and Charge Alarms	43
1.5.8 Cell Balancing	44
1.5.9 Charging Faults	45
1.6 Device Operating Mode	48
1.6.1 Normal Mode	48
1.6.2 Battery Pack Removed Mode/System Present Detection	48
1.6.3 Sleep Mode	48
1.6.4 Wake Function	49
1.6.5 Shutdown Mode	50
1.7 Security (Enables and Disables Features)	51
1.8 Calibration	53

1.8.1	Cell Voltage Calibration	54
1.8.2	BAT Voltage Calibration	55
1.8.3	PACK Voltage Calibration	56
1.8.4	Current Calibration	57
1.8.5	Temperature Calibration	58
1.9	Communications	60
1.9.1	SMBus On and Off State	61
1.9.2	Packet Error Checking	61
1.9.3	bq3055 Slave Address	61
1.9.4	Broadcasts to Smart Charger and Smart Battery Host	61
A	Standard SBS Commands	63
A.1	ManufacturerAccess(0x00)	63
A.1.1	System Data	63
A.1.2	System Control	65
A.1.3	Extended SBS Commands	68
A.2	RemainingCapacityAlarm(0x01)	69
A.3	RemainingTimeAlarm(0x02)	69
A.4	BatteryMode(0x03)	69
A.5	AtRate(0x04)	71
A.6	AtRateTimeToFull(0x05)	72
A.7	AtRateTimeToEmpty(0x06)	72
A.8	AtRateOK(0x07)	72
A.9	Temperature(0x08)	73
A.10	Voltage(0x09)	73
A.11	Current(0x0a)	73
A.12	AverageCurrent(0x0b)	74
A.13	MaxError(0x0c)	74
A.14	RelativeStateOfCharge(0x0d)	75
A.15	AbsoluteStateOfCharge(0x0e)	75
A.16	RemainingCapacity(0x0f)	75
A.17	FullChargeCapacity(0x10)	76
A.18	RunTimeToEmpty(0x11)	76
A.19	AverageTimeToEmpty(0x12)	76
A.20	AverageTimeToFull(0x13)	77
A.21	ChargingCurrent(0x14)	77
A.22	ChargingVoltage(0x15)	77
A.23	BatteryStatus(0x16)	78
A.24	CycleCount(0x17)	79
A.25	DesignCapacity(0x18)	79
A.26	DesignVoltage(0x19)	80
A.27	SpecificationInfo(0x1a)	80
A.28	ManufactureDate(0x1b)	81
A.29	SerialNumber(0x1c)	81
A.30	ManufacturerName(0x20)	82
A.31	DeviceName(0x21)	82
A.32	DeviceChemistry(0x22)	82
A.33	ManufacturerData/CalibrationData(0x23)	83
A.34	Authenticate/ManufacturerInput(0x2f)	85
A.35	CellVoltage4..1(0x3c..0x3f)	85
A.36	SBS Command Values	86
B	Extended SBS Commands	89
B.1	AFEData(0x45)	89
B.2	FETControl(0x46)	89

B.3	PendingEDV(0x47)	90
B.4	StateOfHealth(0x4f)	90
B.5	SafetyAlert(0x50)	90
B.6	SafetyStatus(0x51)	91
B.7	PFAAlert(0x52)	92
B.8	PFStatus(0x53)	92
B.9	OperationStatus(0x54)	93
B.10	ChargingStatus(0x55)	94
B.11	FETStatus(0x56)	94
B.12	ResetData(0x57)	95
B.13	WDRResetData(0x58)	95
B.14	PackVoltage(0x5a)	95
B.15	AverageVoltage(0x5d)	96
B.16	TS1Temperature (0x5E)	96
B.17	TS2Temperature (0x5F)	96
B.18	UnSealKey(0x60)	96
B.19	FullAccessKey(0x61)	96
B.20	PFKey(0x62)	97
B.21	AuthenKey3(0x63)	97
B.22	AuthenKey2(0x64)	97
B.23	AuthenKey1(0x65)	98
B.24	AuthenKey0(0x66)	98
B.25	ManufacturerInfo(0x70)	98
B.26	SenseResistor(0x71)	98
B.27	TempRange(0x72)	99
B.28	ManufacturerStatus(0x74)	99
B.29	Extended SBS Command Values	99
C	Data Flash	101
C.1	Accessing Data Flash	101
C.1.1	Data Flash Interface	101
C.1.2	Reading a Data Flash Row	101
C.1.3	Writing a Data Flash Row	102
C.2	Calibration	102
C.2.1	Data	102
C.2.2	Config	105
C.2.3	Temp Model	107
C.2.4	Current	108
C.3	System Data	109
C.3.1	Manufacturer Data	109
C.3.2	Manufacturer Info	110
C.3.3	Lifetime Data	111
C.4	SBS Configuration	112
C.4.1	Data	112
C.4.2	Configuration	117
C.5	PF Status	119
C.5.1	Device Status Data	119
C.5.2	AFE Regs	123
C.6	Gas Gauging	124
C.6.1	CEDV Cfg	124
C.6.2	Current Thresholds	128
C.6.3	State	129
C.7	Charge Control	130
C.7.1	Charge Control SMBus Broadcasts	130

C.7.2	Charge Temperature Cfg	130
C.7.3	Pre-Charge Cfg	133
C.7.4	Charge Cfg	134
C.7.5	Termination Cfg.	140
C.7.6	Cell Balancing Cfg	142
C.7.7	Charging Faults	142
C.8	Configuration	147
C.8.1	Registers	147
C.8.2	AFE	154
C.9	Power	155
C.9.1	Power	155
C.10	1st Level Safety Class	159
C.10.1	Voltage	159
C.10.2	Current	162
C.10.3	Temperature	170
C.11	2nd-Level Safety	173
C.11.1	Voltage	173
C.11.2	Current	177
C.11.3	Temperature	178
C.11.4	FET Verification	180
C.11.5	AFE Verification	181
C.12	Data Flash Values	182
D	Glossary	193

Preface

Read this First

This manual discusses modules and peripherals of the bq3055 device, and its use to build a complete battery pack gas gauge and protection solution.

Notational Conventions

The following notation is used, if SBS commands and Data Flash values are mentioned within a text block:

- SBS commands are set in italic, e.g., *Voltage*
- SBS bits and flags are capitalized, set in italic and enclosed with square brackets, e.g., *[TCA]*
- Data Flash values are set in bold italic e.g., ***CUV Threshold***
- All Data Flash bits and flags are capitalized, set in bold italic and enclosed with square brackets, e.g., ***[NR]***

All SBS commands, Data Flash values and flags mentioned in a chapter are listed at the end of each chapter for reference.

The reference format for SBS commands is: SBS:Command Name(Command No.):Manufacturer Access(MA No.)[Flag], for example:

SBS:Voltage(0x09), or SBS:ManufacturerAccess(0x00):Seal Device(0x0020)

The reference format for Data Flash values is: DF:Class Name:Subclass Name:Value Name[Flag], for example:

DF:1st Level Safety:Voltage:CUV Threshold, or

DF:Configuration:Registers:Operation A Cfg[SLEEP].

Detailed Description

1.1 JEITA Temperature Ranges

The bq3055 follows the JEITA guidelines, which specify that charging voltage and charging current depend on the temperature. Temperature ranges are used for specifying both what the charging voltage and charging current should be.

There are three temperature ranges in which charging is allowed and they are defined as:

- T1 – T2: Low charging temperature range ($T1 \leq \text{Temperature} < T2$)
- T2 – T3: Standard charging temperature range ($T2 \leq \text{Temperature} < T3$)
- T3 – T4: High charging temperature range ($T3 \leq \text{Temperature} < T4$)

For added flexibility the standard temperature range is divided into 2 sub-ranges: standard range 1 and standard range 2. An additional temperature value (T2a) is needed to specify these 2 ranges. These temperature ranges will be configurable in the gas gauge through the following data flash constants.

- **JT1**: Lower bound of low charging temperature range, in °C.
- **JT2**: Upper bound of low charging temperature range and lower bound of standard charging temperature range 1, in °C.
- **JT2a**: Upper bound of standard charging temperature range 1 and lower bound of standard charging temperature range 2, in °C
- **JT3**: Upper bound of standard charging temperature range 2 and lower bound of high charging temperature range, in °C.
- **JT4**: Upper bound of high charging temperature range, in °C.

The bq3055 implements hysteresis for the temperature ranges above using the DF variable (**Temp Hys**). This variable specifies the number of degrees of hysteresis that should be used before switching charging temperature ranges.

The active temperature range is indicated using a set of flags. Since hysteresis is implemented for the temperature ranges, determining the active temperature range depends on the previous state, in addition to the actual temperature. These flags reside in a status register called *TempRange*.

Table 1-1. Temperature Ranges in bq3055

Flag	JEITA Temperature Range	Charging Mode
TR1	Temp < JT1	Charge Suspend or Charge Inhibit
TR2	JT1 < Temp < JT2	Low Temp Charge
TR2A	JT2 < Temp < JT2a	Standard Temp Charge 1
TR3	JT2a < Temp < JT3	Standard Temp Charge 2
TR4	JT3 < Temp < JT4	High Temp Charge or Charge Inhibit
TR5	JT4 < Temp	Charge Suspend or Charge Inhibit

Related Variables:

- DF:Charge Temperature Cfg:JT1
- DF:Charge Temperature Cfg:JT2
- DF:Charge Temperature Cfg:JT2a
- DF:Charge Temperature Cfg:JT3

- DF:Charge Temperature Cfg:JT4
- DF:Charge Temperature Cfg:Temp Hys
- SBS:Temperature

1.2 1st Level Protection Features

The bq3055 supports a wide range of battery and system protection features that are easily configured or enabled via the integrated data flash.

1.2.1 Cell Overvoltage (COV) and Cell Undervoltage (CUV)

The bq3055 can detect cell overvoltage/undervoltage and protect battery cells from damage from battery cell overvoltage/undervoltage. If the over/undervoltage remains over a period of 2 s, the bq3055 goes into overvoltage/undervoltage condition and switches off the CHG/DSG FET. The bq3055 recovers from a cell overvoltage condition if all the cell voltages drop below the cell overvoltage recovery threshold. The bq3055 recovers from cell undervoltage condition if all the cell voltages rise above the cell undervoltage recovery threshold.

Per JEITA guidelines, the cell overvoltage threshold changes depending on the temperature. A separate cell overvoltage threshold is specified for each operating temperature range.

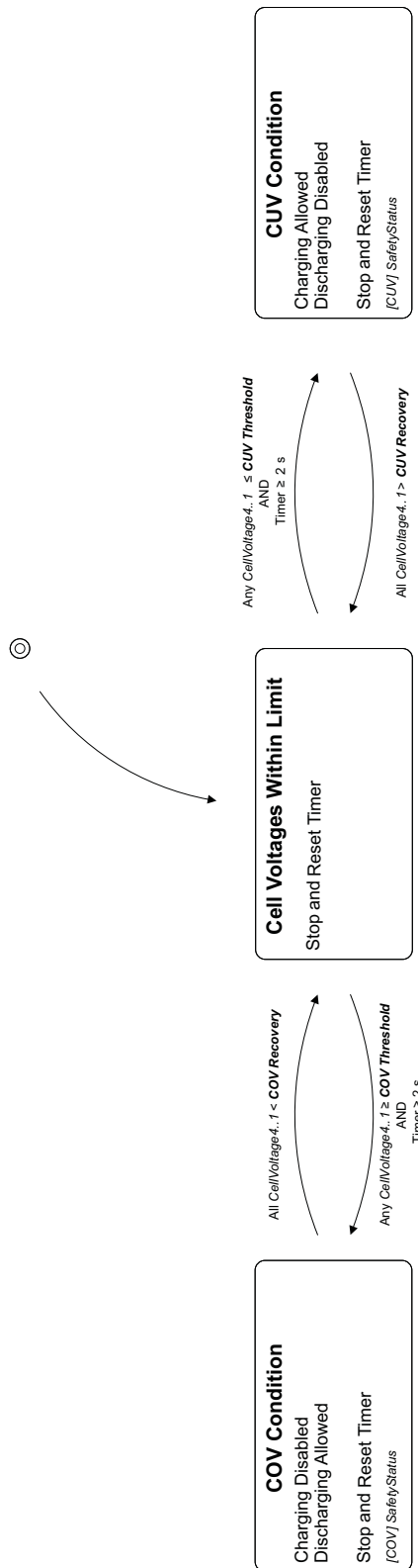

Figure 1-1. COV and CUV

Table 1-2. COV and CUV

Condition:		COV Condition	Normal	CUV Condition
Flags:	BatteryStatus	[TCA]		[TDA], [FD]
	SafetyStatus	[COV]		[CUV]
	OperationStatus			[XDSG]
FET:		CHG FET disabled, enabled during discharge	Normal	DSG FET disabled, enabled during charge
SBS Command:	ChargingCurrent	0	Charging algorithm	Charging algorithm
	ChargingVoltage	0	Charging algorithm	Charging algorithm

The bq3055 indicates cell overvoltage condition by setting the [COV] flag in *SafetyStatus* if any *CellVoltage4..1* reaches or surpasses the cell overvoltage limit (**LT COV Threshold**, **ST COV Threshold**, or **HT COV Threshold**, depending on the current temperature range) and stays above the threshold for period of 2 s.

In cell overvoltage condition charging is disabled and CHG FET and ZVCHG FET (if used) are turned off, *ChargingCurrent* and *ChargingVoltage* are set to zero, [TCA] flag in *BatteryStatus* and [COV] flag in *SafetyStatus* are set.

The bq3055 recovers from a cell overvoltage condition if all *CellVoltages4..1* are equal to or lower than the appropriate COV Recovery limit (**LT COV Recovery**, **ST COV Recovery**, or **HT COV Recovery**). On recovery the [COV] and [TCA] flags are reset, and *ChargingCurrent* and *ChargingVoltage* are set back to appropriate values per the charging algorithm.

In a cell overvoltage condition, the CHG FET is turned on during discharging to prevent overheating of the CHG FET body diode.

The bq3055 indicates cell undervoltage by setting the [CUV] flag in *SafetyStatus* if any *CellVoltage4..1* reaches or drops below the **CUV Threshold** limit during discharging and stays below the threshold for a period of 2 s.

In a cell undervoltage condition, discharging is disabled and DSG FET is turned off, the [TDA] and [FD] flags in *BatteryStatus* and the [CUV] flag in *SafetyStatus* are set.

The bq3055 recovers from cell undervoltage condition if all *CellVoltages4..1* are equal to or higher than **CUV Recovery** limit. On recovery, the [CUV] flag in *SafetyStatus* is reset, [XDSG] flag is reset, the [TDA] and [FD] flags are reset, and *ChargingCurrent* and *ChargingVoltage* are set back to appropriate values per the charging algorithm.

In cell undervoltage condition, the DSG FET is turned on during charging to prevent overheating of the DSG FET body diode.

Related Variables:

- DF:1st Level Safety:Voltage:LT COV Threshold
- DF:1st Level Safety:Voltage:ST COV Threshold
- DF:1st Level Safety:Voltage:HT COV Threshold
- DF:1st Level Safety:Voltage:LT COV Recovery
- DF:1st Level Safety:Voltage:ST COV Recovery
- DF:1st Level Safety:Voltage:HT COV Recovery
- DF:1st Level Safety:Voltage:CUV Threshold
- DF:1st Level Safety:Voltage:CUV Recovery
- SBS:ChargingCurrent
- SBS:ChargingVoltage
- SBS:BatteryStatus[TCA],[TDA],[FD],[DSG]
- SBS:CellVoltage4
- SBS:CellVoltage3

- SBS:CellVoltage2
- SBS:CellVoltage1
- SBS:SafetyStatus[CUV],[COV]
- SBS:OperationStatus[XDSG]

1.2.2 Charge and Discharge Overcurrent

The bq3055 has two independent levels of recoverable overcurrent protection, the tier-1 (firmware overcurrent protection, charge and discharge directions) and AFE (hardware overcurrent protection, for discharge only) overcurrent protection. Both levels require the *Current* value to be greater than or equal to a programmed OC Threshold in either charge or discharge current for a period greater than OC Time Limit. In tier-1 only, however, if the OC Time Limit is set to 0, that specific feature is disabled.

Table 1-3. Recoverable Charge and Discharge Overcurrent

Protection	OC Threshold	OC Time Limit	OC Recovery Threshold	SafetyAlert Flag	SafetyStatus Flag
Tier-1 Charge	<i>OC (1st Tier)Chg</i>	<i>OC(1st Tier) Chg Time</i>	<i>OC Chg Recovery for Current Recovery Time</i>	[OCC]	[OCC]
Tier-1 Discharge	<i>OC (1st Tier) Dsg</i>	<i>OC (1st Tier) Dsg Time</i>	<i>OC Dsg Recovery for Current Recovery Time</i>	[OCD]	[OCD]
AFE Hardware Discharge	<i>AFE OC Dsg</i>	<i>AFE OC Dsg Time</i>	<i>AFE OC Dsg Recovery for Current Recovery Time</i>	—	[AOCD]

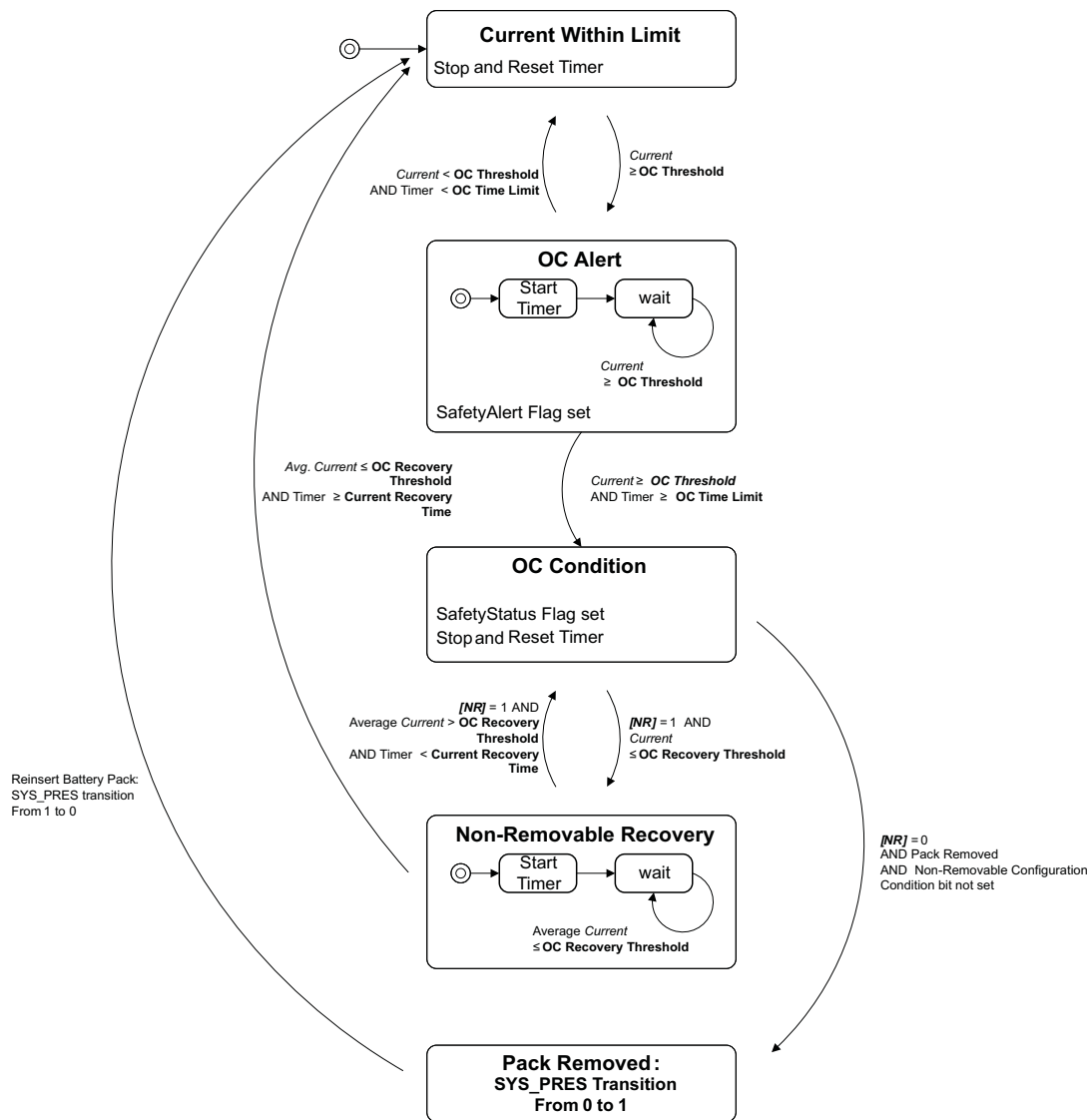

Figure 1-2. Recoverable OC Protection

For the tier-1 overcurrent protection, the specific flag in *SafetyAlert* is set if *Current* exceeds the OC Threshold. The bq3055 changes the specific flag in *SafetyAlert* to the specific flag in *SafetyStatus* if the *Current* stays above the OC Threshold limit for at least OC Time Limit period. This function is disabled if the OC Time Limit is set to zero. The *SafetyStatus* flag is reset if the *Current* falls below the OC Recovery Threshold.

If the tier-1 timer expires during charging, the CHG FET is turned off. When this occurs, the internal current fault timer is reset, *ChargingCurrent* and *ChargingVoltage* are set to 0, *[TCA]* flag is set and the *[OCC]* flag is set in *SafetyStatus*.

However, when the bq3055 has the *[OCC]* flag in *SafetyStatus* set, the CHG FET is turned on again during discharge ($Current \leq (-) \text{ Dsg Current Threshold}$). This prevents overheating of the CHG FET body diode during discharge. No other flags change state until full recovery is reached. This action is not affected by the setting of *[NR]* bit.

If the tier-1 timer expires during discharging, the DSG FET is turned off and the ZVCHG FET is turned on if used. When this occurs the internal current fault timer is reset, *ChargingCurrent* is set to **Pre-chg Current**, *[PCHG]*, *[XDSG]*, *[XDSGI]*, and *[TDA]* flag are set, and the *[OCD]* flag is set in *SafetyStatus*.

When the current measured by the AFE exceeds the **AFE OC Dsg** for longer than **AFE OC Dsg Time**, the integrated AFE detects a discharge-overcurrent fault, the CHG and DSG FETs are turned off, the internal XALERT signal triggers an interrogation by the bq3055. When the bq3055 identifies the overcurrent condition, the CHG FET is re-enabled, *[TDA]* flag is set, *ChargingCurrent* is set to 0, and *[AOCD]* is set.

However, when either *[OCD]* or *[AOCD]* is set, the discharge-FET is turned on again during charging ($Current \geq \mathbf{Chg\ Current\ Threshold}$). This prevents overheating of the discharge-FET body diode during charge. No other flags change state until full recovery is reached. This action is not affected by the state of *[NR]* bit.

Table 1-4. Overcurrent Conditions

Protection	Condition	Flags					FET	Charging Current	Charging Voltage
		Safety Alert	Safety Status	Battery Status	Operation Status	Charging Status			
Tier-1 Charge	OC Alert	<i>[OCC]</i>					normal	charging algorithm	charging algorithm
	OC Condition		<i>[OCC]</i>	<i>[TCA]</i>			CHG FET disabled, enabled during discharge	0	0
Tier-1 Discharge	OC Alert	<i>[OCD]</i>					normal	charging algorithm	charging algorithm
	OC Condition		<i>[OCD]</i>	<i>[TDA]</i>	<i>[XDMSG],[XDMSG]</i>	<i>[PCHG]</i>	DSG FET disabled, enabled during charge	Pre-chg Current	charging algorithm
AFE Discharge	OC Condition		<i>[AOCD]</i>	<i>[TDA]</i>	<i>[XDMSG]</i>		CHG FET and DSG FET disabled; CHG FET will be re-enabled	0	charging algorithm

The bq3055 can individually configure each recoverable overcurrent-protection to recover via two different methods based on *[NR]* bit.

Standard Recovery, where *[NR]* = 0 and the overcurrent tier is not selected in **Non-Removable Cfg** register. When the pack is removed and reinserted the condition is cleared. Pack removal and reinsertion is detected by a low-to-high-to-low transition on the $\overline{\text{PRES}}$ input. When the overcurrent tier is selected in **Non-Removable Cfg**, that particular feature uses the Non-Removable Battery Mode recovery.

Non-Removable Battery Mode Recovery where *[NR]* = 1. The state of **Non-Removable Cfg** has no consequence. This recovery requires *AverageCurrent* to be \leq the respective recovery threshold, and for the *Current_Fault* timer \geq **Current Recovery Time**.

When a charging-fault recovery condition is detected, then the CHG FET is allowed to be turned on, if other safety and configuration states permit, *[TCA]* is reset, *ChargingCurrent* and *ChargingVoltage* are set to the appropriate value per the charging algorithm, and the appropriate *SafetyStatus* flag is reset.

When a discharging-fault recovery condition is detected, the DSG FET is allowed to be turned on if other safety and configuration states permit, *[TDA]* flag is reset, *ChargingCurrent* and *ChargingVoltage* are set to the appropriate value per the charging algorithm, and the *[PCHG],[XDMSG],[XDMSG]*, and the appropriate *SafetyStatus* flag are reset.

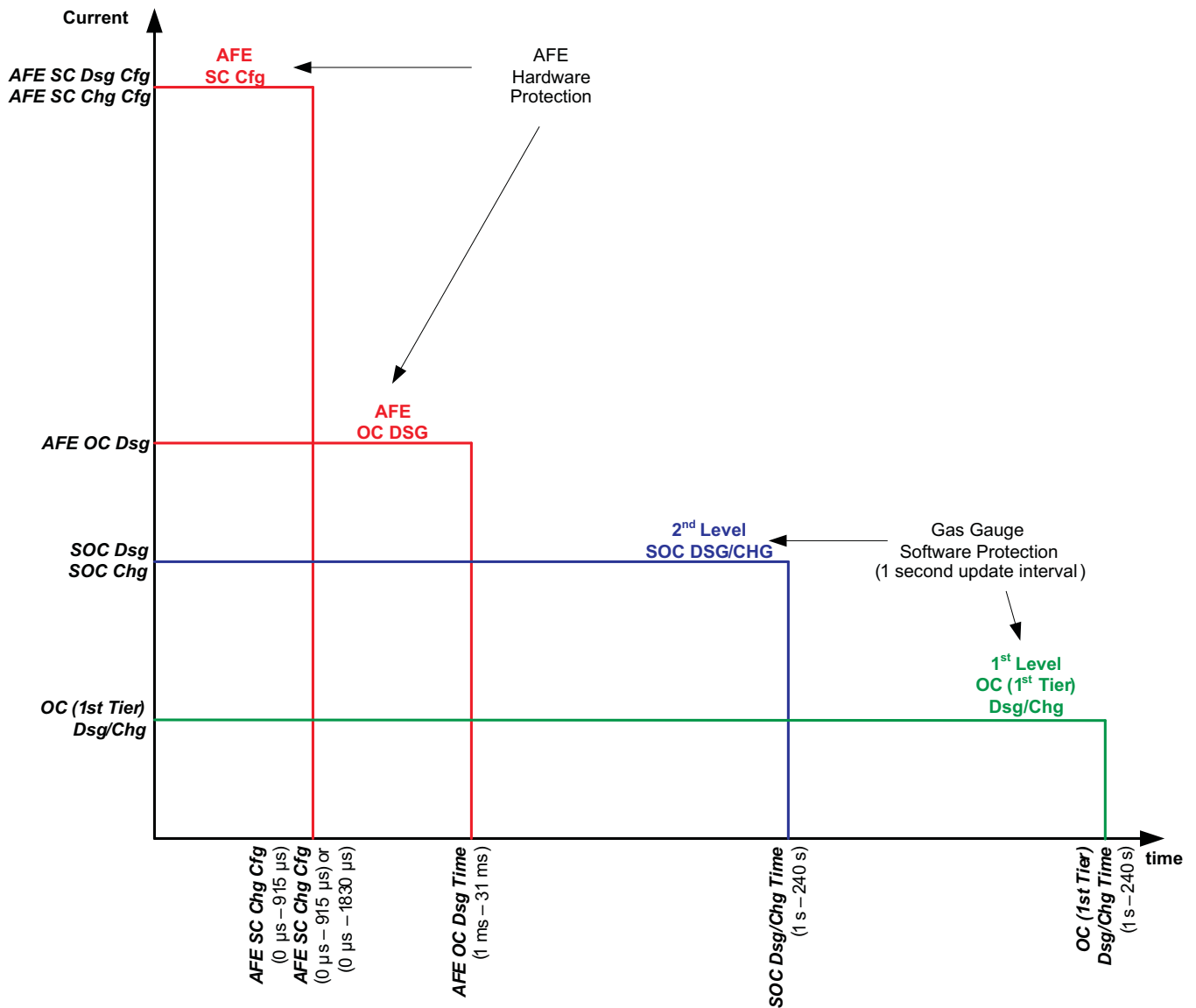

Figure 1-3. Overcurrent Protection Levels

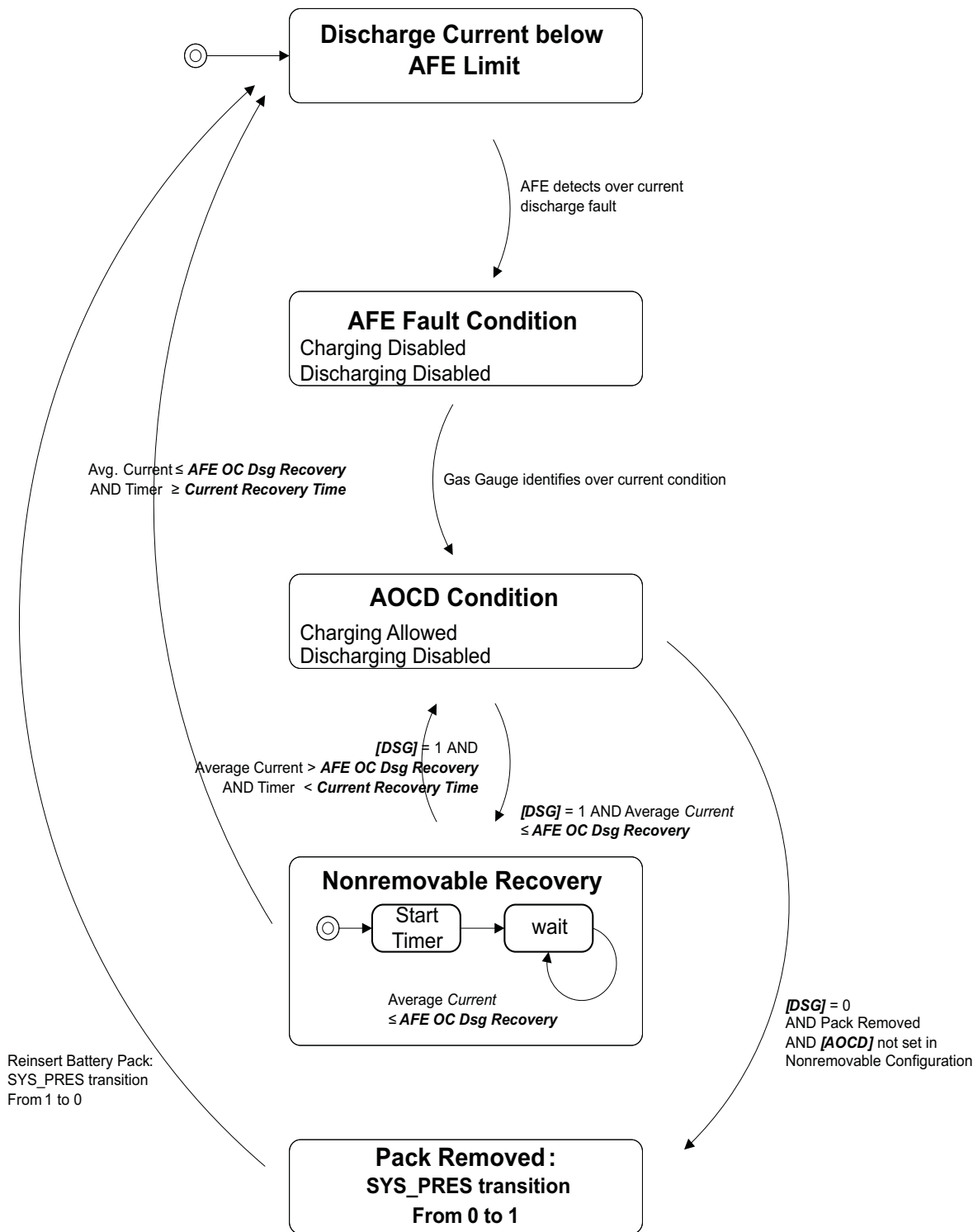

Figure 1-4. AFE Discharge Overcurrent Protection

Related Variables:

- DF:1st Level Safety:Current:OC(1st Tier) Chg
- DF:1st Level Safety:Current:OC(1st Tier) Chg Time
- DF:1st Level Safety:Current:OC Chg Recovery

- DF:1st Level Safety:Current:OC(1st Tier) Dsg
- DF:1st Level Safety:Current:OC(1st Tier) Dsg Time
- DF:1st Level Safety:Current:OC Dsg Recovery
- DF:1st Level Safety:Current:Current Recovery Time
- DF:1st Level Safety:Current:AFE OC Dsg
- DF:1st Level Safety:Current:AFE OC Dsg Time
- DF:1st Level Safety:Current:AFE OC Dsg Recovery
- DF:Charge Control:Pre-Charge Cfg:Pre-chg Current
- DF:Configuration:Registers:Operation Cfg B[*NR*]
- DF:Configuration:Registers:Non-Removable Cfg
- SBS:Current
- SBS:AverageCurrent
- SBS:ChargingCurrent
- SBS:ChargingVoltage
- SBS:BatteryStatus[*TCA*],[*TDA*]
- SBS:SafetyAlert
- SBS:SafetyStatus
- SBS:OperationStatus[*XDSG*][*XDSGI*]
- SBS:ChargingStatus[*PCHG*]

1.2.3 Short-Circuit Protection

The bq3055 short-circuit protection is executed by the integrated AFE, but is recovered by the bq3055. This allows different recovery methods to accommodate various applications.

The integrated AFE charge short-circuit and discharge short-circuit protection are configured by the bq3055 data flash **AFE SC Chg Cfg** and **AFE SC Dsg Cfg** registers, respectively.

When the integrated AFE detects a short circuit in charge (in discharge) fault, the charge (discharge) FET is turned off, the internal XALERT signal is driven low by the integrated AFE and the bq3055 starts interrogation of the AFE. When the bq3055 identifies the short-circuit in charge (discharge) condition, discharge-FET (charge-FET) is re-enabled, the internal AFE current fault timer is reset, [*TCA*] ([*TDA*]) in battery status is set, *ChargingCurrent* and *ChargingVoltage* is set to 0 and [*SCC*] ([*SCD*]) is set. If the short-circuit condition is in discharge, then [*XDSG*] flag is also set.

Each bq3055 short-circuit protection feature can be individually configured to recover via two different methods, based on [*NR*] bit.

Standard Recovery is where [*NR*] = 0 and the overcurrent tier is not selected in **Non-Removable Cfg**. When the pack is removed and re-inserted, the condition is cleared. Pack removal and re-insertion is detected by transition on the *PRES* input from low to high to low. When the overcurrent tier is selected in **Non-Removable Cfg**, that particular feature uses the Non-removable Battery Mode recovery.

Non-Removable Battery Mode Recovery is where [*NR*] = 1. The state of **Non-Removable Cfg** has no consequence when [*NR*] bit is set to 1. This recovery requires that *AverageCurrent* be \leq **AFE SC Recovery** threshold and that the internal AFE current recovery timer \geq **Current Recovery Time**.

When the recovery condition for a charging fault is detected, the CHG FET is allowed to be turned on if other safety and configuration states permit. The ZVCHG FET also returns to previous state. When this occurs, [*TCA*] is reset, *ChargingCurrent* and *ChargingVoltage* are set to the appropriate values per the charging algorithm, and the appropriate *SafetyStatus* flag is reset.

When the recovery condition for a discharging fault is detected, the DSG FET is allowed to be turned on if other safety and configuration states permit. The ZVCHG FET also returns to previous state. When this occurs [*TDA*] is reset, *ChargingCurrent* and *ChargingVoltage* are set to the appropriate value per the charging algorithm, and [*XDSG*] and the appropriate *SafetyStatus* flags are reset.

Table 1-5. Short Circuit Protection

Short Circuit	Condition	Flags Set	FET	Charging Current	Charging Voltage	Clear Threshold
Charge	AFE SC Chg Cfg	[SCC] <i>SafetyStatus</i> , [TCA]	CHG FET disabled, enabled during discharge	0	0	AFE SC Recovery
Discharge	AFE SC Dsg Cfg	[SCD] <i>SafetyStatus</i> , [TDA], [XDSG]	DSG FET disabled, enabled during charge	0	0	

Related Variables:

- DF:1st Level Safety:Current:AFE SC Chg Cfg
- DF:1st Level Safety:Current:AFE SC Dsg Cfg
- DF:1st Level Safety:Current:AFE SC Recovery
- DF:Configuration:Registers:Operation Cfg B[NR]
- DF:Configuration:Registers:Non-Removable Cfg
- SBS:AverageCurrent
- SBS:BatteryStatus[TCA],[TDA]
- SBS:SafetyStatus[SCC],[SCD]
- SBS:OperationStatus[XDSG]

1.2.4 Overtemperature Protection

The bq3055 has overtemperature protection for both charge and discharge conditions.

The bq3055 sets the over temperature charging [OTC] *SafetyAlert* flag, if pack temperature reaches or surpasses **Over Temp Chg** limit during charging. The bq3055 changes [OTC] *SafetyAlert* to over temperature condition, if pack temperature stays above **Over Temp Chg** limit for a time period of **OT Chg Time**. This function is disabled if **OT Chg Time** is set to zero.

If [OTFET] is set and bq3055 is in [OTC] condition, charging is disabled and CHG FET is turned off, ZVCHG FET is turned off if configured for use, *ChargingCurrent* and *ChargingVoltage* are set to zero, the [OTC] flag in *SafetyAlert* is reset, [TCA] and [OTC] in *SafetyStatus* are set.

The bq3055 recovers from an [OTC] condition if *Temperature* is equal to or below **OTC Chg Recovery** limit. On recovery the [OTC] flag in *SafetyStatus* is reset, [TCA] is reset, *ChargingCurrent* and *ChargingVoltage* are set back to their appropriate value per the charging algorithm, and the CHG FET returns to previous state.

In an [OTC] condition, the CHG FET is turned on during discharging to prevent overheating of the CHG FET body diode.

The bq3055 sets the over temperature discharging [OTD] *SafetyAlert* flag, if pack temperature reaches or surpasses **Over Temp Dsg** limit during discharging. The bq3055 changes [OTD] *SafetyAlert* to over temperature condition, if pack temperature stays above **Over Temp Dsg** limit for a time period of **OT Dsg Time**. This function is disabled if **OT Dsg Time** is set to zero.

If [OTFET] is set and bq3055 is in [OTD] condition, discharging is disabled and DSG FET is turned off, *ChargingCurrent* is set to zero, the [OTD] *SafetyAlert* flag is reset, [TDA] is set, [XDSG] flag is set and the [OTD] flag in *SafetyStatus* is set.

The bq3055 recovers from an [OTD] condition if pack temperature is equal to or below **OTD Chg Recovery** limit. On recovery [OTD] in *SafetyStatus* is reset, [TDA] is reset, *ChargingCurrent* is set back to the appropriate value per the charging algorithm, and the DSG FET is allowed to switch on again.

In an [OTD] condition, the DSG FET is turned on during charging to prevent overheating of the DSG FET body diode.

Table 1-6. Overtemperature Protection

	Alert Threshold	Alert Time Limit	SafetyAlert Flags Set	Overtemp Condition	Recovery Threshold
Charge	Over Temp Chg	OT Chg Time	[OTC]	[OTC] SafetyStatus Flag, [TCA] set, ChargingCurrent =0, ChargingVoltage = 0, (CHG FET off if [OTFET] set)	OT Chg Recovery
Discharge	Over Temp Dsg	OT Dsg Time	[OTD]	[OTD] SafetyStatus Flag, [TDA] Set, ChargingCurrent =0, ([XDSG] set and DSG FET off if [OTFET] flag set)	OT Dsg Recovery

Related Variables:

- DF:1st Level Safety:Temperature:Over Temp Chg
- DF:1st Level Safety:Temperature:OT Chg Time
- DF:1st Level Safety:Temperature:OT Chg Recovery
- DF:1st Level Safety:Temperature:Over Temp Dsg
- DF:1st Level Safety:Temperature:OT Dsg Time
- DF:1st Level Safety:Temperature:OT Dsg Recovery
- DF:Configuration:Registers:Operation Cfg B[OTFET]
- SBS:Temperature
- SBS:ChargingCurrent
- SBS:ChargingVoltage
- SBS:BatteryStatus[TCA],[TDA]
- SBS:SafetyAlert[OTC],[OTD]
- SBS:SafetyStatus[OTC],[OTD]
- SBS:OperationStatus[XDSG]

1.2.5 AFE Watchdog

The integrated AFE automatically turns off the CHG FET, DSG FET and ZVCHG FET (if used), if the integrated AFE does not receive the appropriate frequency on the internal watchdog input (WDI) signal from bq3055. The bq3055 has no warning that this is about to happen, but it can report the occurrence once the bq3055 is able to interrogate the integrated AFE.

When the internal XALERT input of the bq3055 is triggered by the integrated AFE, the bq3055 reads the STATUS register of the integrated AFE. If [WDF] is set, the bq3055 also sets [WDF] in *SafetyStatus* and periodic verification of the integrated AFE RAM is undertaken. If verification of the integrated AFE RAM fails then the FETs will turn off. Verification of the integrated AFE RAM will continue once every second. If the periodic verification passes, then [WDF] in *SafetyStatus* is cleared and the FETs return to normal operation.

Related Variables:

- SBS:SafetyStatus[WDF]

1.3 2nd-Level Protection Features

The bq3055 provides features that can be used to indicate a more serious fault via the FUSE output. These outputs can be used to blow an in-line fuse to permanently disable the battery pack from charge or discharge activity.

If any PF Threshold condition is met, the appropriate flag is set in *PFAAlert*. If the PF Threshold condition is cleared within the PF time limit, the appropriate PFAAlert flag is cleared in *PFAAlert*. But if the PF Threshold condition continues over the PF Time Limit or Alert Limit, then the bq3055 goes into permanent failure condition and the appropriate flag is set in *PFStatus* and reset in *PFAAlert*.

When any NEW cause of a permanent failure is set in *PFStatus* function, the NEW cause is added to **PF Flags 1** register. This allows **PF Flags 1** register to show ALL permanent failure conditions that have occurred.

On the first occasion of a permanent failure indicated by *PFStatus* change from 0x00, the *PFStatus* value is stored in **PF Flags 2**.

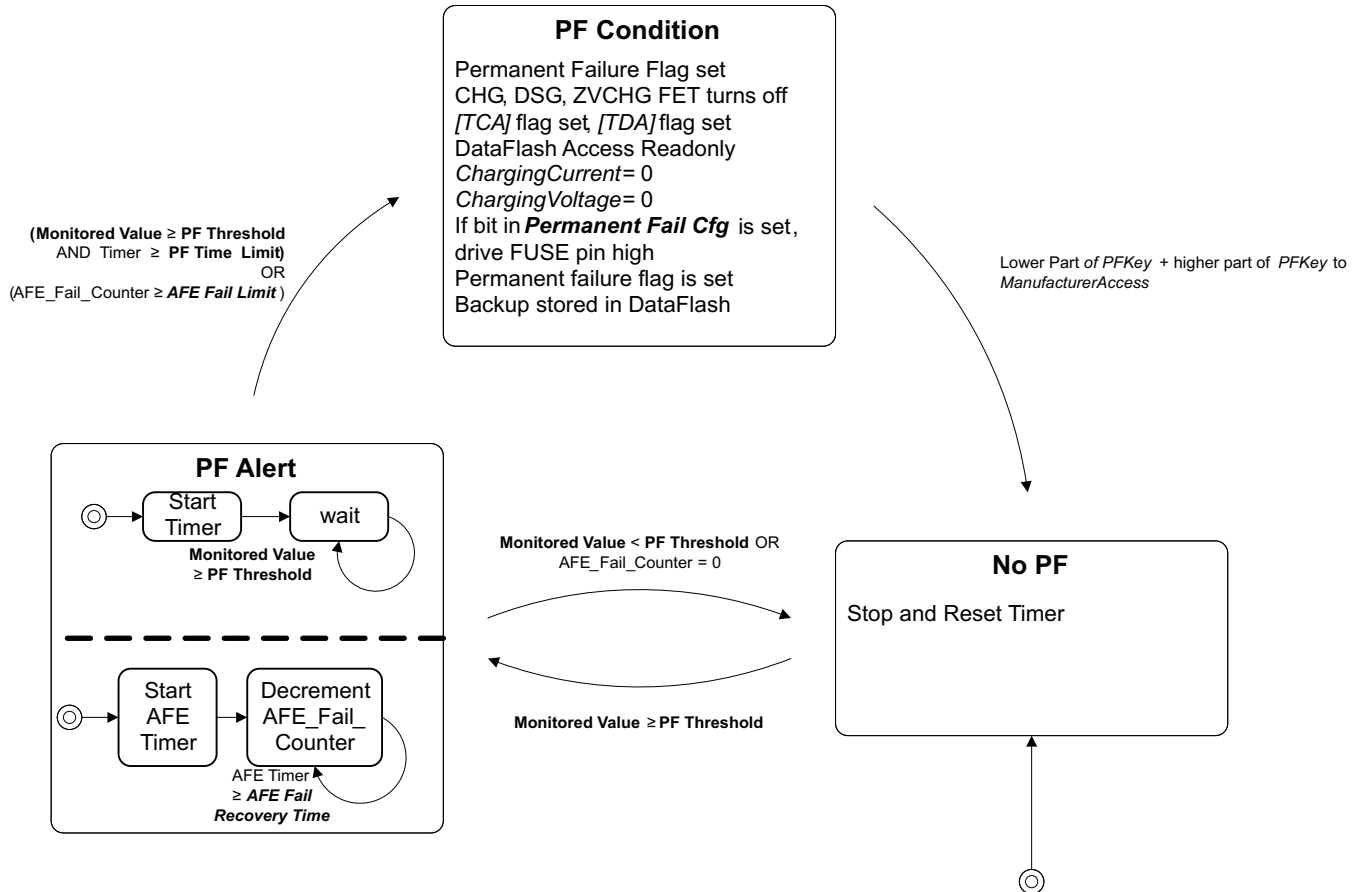

Figure 1-5. 2nd-Level Protection

1.3.1 2nd-Level (Permanent) Failure Actions

When the *PFStatus* register changes from 0x00 to indicate a permanent failure then the following actions are taken in sequence.

- CHG, DSG, and ZVCHG FETs are turned OFF.
- [TCA], [TDA] flags in *BatteryStatus* are set.
- A backup of SBS data and the complete memory map of the integrated AFE is stored to data flash (if [LTPF] is set in *OperationStatus*).
- Data Flash write access is disabled, but the data flash can be read (if [LTPF] is set in *OperationStatus*).
- *ChargingCurrent* and *ChargingVoltage* are set to 0.
- The appropriate bit in *PF Flags 1* is set (if [LTPF] is set in *OperationStatus*).
- If the appropriate bit in **Permanent Fail Cfg** is set, then 0x3672 is programmed to **Fuse Flag**, and the FUSE pin is driven and latched high. The [PF] flag in *SafetyStatus* is also set (if [LTPF] is set in *OperationStatus*).

For the convenience of production test, if *[LTPF]* is cleared in *OperationStatus*, when permanent failures occur, data flash write is still allowed, there is no PF data logging in DF:PF Status, and the PF can be cleared by resetting the bq3055. *[LTPF]* is set by the *LTPF Enable* ManufacturerAccess command. If *[LTPF]* in *OperationStatus* is already set, to clear this bit and disable PF data logging, clear the DF:Configuration:Registers(64):Operation Cfg C(4)[PROD_LTPF_EN], and then reset the bq3055.

Table 1-7. Permanent Fail Backup

SBS Value	Data Flash Backup
SBS:Voltage(0x09)	DF:PF Status:Device Status Data(96):PF Voltage(4)
SBS:CellVoltage4(0x3c)	DF:PF Status:Device Status Data(96):PF C4 Voltage(6)
SBS:CellVoltage3(0x3d)	DF:PF Status:Device Status Data(96):PF C3 Voltage(8)
SBS:CellVoltage2(0x3e)	DF:PF Status:Device Status Data(96):PF C2 Voltage(10)
SBS:CellVoltage1(0x3f)	DF:PF Status:Device Status Data(96):PF C1 Voltage(12)
SBS:Current(0x0a)	DF:PF Status:Device Status Data(96):PF Current(14)
SBS:Temperature(0x08)	DF:PF Status:Device Status Data(96):PF Temperature(16)
SBS:BatteryStatus(0x16)	DF:PF Status:Device Status Data(96):PF Batt Stat(18)
SBS:RemainingCapacity(0x0f)	DF:PF Status:Device Status Data(96):PF RC-mAh(20)
SBS:FullChargeCapacity(0x10)	DF:PF Status:Device Status Data(96):PF FCC(22)
SBS:ChargingStatus(0x55)	DF:PF Status:Device Status Data(96):PF Chg Status(24)
SBS:SafetyStatus(0x51)	DF:PF Status:Device Status Data(96):PF Safety Status(26)
DOD at EDV2	DF:PF Status:Device Status Data(96):PF DOD(28)
Integrated AFE Memory Map	
	DF:PF Status:AFE Regs(97):AFE Status(0)
	DF:PF Status:AFE Regs(97):AFE State(1)
	DF:PF Status:AFE Regs(97):AFE Output(2)
	DF:PF Status:AFE Regs(97):AFE Output Status(3)
	DF:PF Status:AFE Regs(97):AFE Cell Select(5)
	DF:PF Status:AFE Regs(97):AFE OLV(6)
	DF:PF Status:AFE Regs(97):AFE OLT(7)
	DF:PF Status:AFE Regs(97):AFE SCC(8)
	DF:PF Status:AFE Regs(97):AFE SCD(9)
	DF:PF Status:AFE Regs(97):AFE Function(10)

Related Variables:

- SBS:ManufacturerAccess:LTPF Enable
- DF:Configuration:Registers:Operation Cfg C[PROD_LTPF_EN]
- DF:Configuration:Registers:Permanent Fail Cfg
- DF:PF Status:Device Status Data:PF Flags 1
- DF:PF Status:Device Status Data:Fuse Flag
- DF:PF Status:Device Status Data:PF Flags 2
- SBS:ChargingCurrent
- SBS:ChargingVoltage
- SBS:BatteryStatus[TCA],[TDA]
- SBS:SafetyStatus[PF]
- SBS:PFStatus

1.3.2 Time Limit Based Protection

bq3055 reports a 2nd level protection alert by setting the appropriate flag in the *PFAIert* function if the monitored value reaches or rises above the Protection Threshold. If the monitored value stays above the Protection Threshold over the Max Alert duration, the bq3055 reports a 2nd level permanent failure, clears the appropriate *PFAIert* flag, and sets the appropriate *PFStatus* flag. See [Table 1-8](#) for all Protection Thresholds and Max Alert durations.

Safety Overvoltage Protection — The bq3055 monitors the individual cell voltages for extreme values. Depending on the temperature range the battery is operating in, either LT, ST, or HT Safety Overvoltage is activated when cells go above these thresholds.

Cell Imbalance Fault — The bq3055 starts cell imbalance fault detection when *Current* is lesser or equal to **Cell Imbalance Current** for **Battery Rest Time** period AND All (*CellVoltage4..1*) > **Min CIM-check voltage**. The difference between highest cell voltage and lowest cell voltage is monitored. If **Battery Rest Time** is set to zero or **Cell Imbalance Time** is set to zero, this function is disabled.

2nd-Level Protection IC Input — The FUSE pin of the bq3055 can be used to determine the output state of an external protection device such as the bq294xx. The bq3055 watches for FUSE pin level when the 2nd level voltage protection IC outputs high.

Safety Overcurrent Protection — The bq3055 monitors the current during charging and discharging. The overcurrent thresholds and time limits can be set independently for charging and discharging.

Safety Overtemperature Protection — The bq3055 monitors the pack temperature during charging and discharging. The overtemperature thresholds and time limits can be set independently for charging and discharging.

Open Thermistor — The bq3055 can detect an open thermistor condition if the temperature function reports extreme temperature values.

CHG and ZVCHG FET Fault Protection — The bq3055 monitors if there is, at any time, an attempt to turn off the CHG FET or ZVCHG FET, or the CHG bit in the *FETStatus* register is clear and the current continues to flow.

Discharge FET Fault Protection — The bq3055 monitors if there is, at any time, an attempt to turn off the DSG FET, or the DSG bit in the *FETStatus* register is clear and the current continues to flow.

Table 1-8. Time Limit-Based 2nd-Level Protection

Protection	Monitored Value	Requirement	PF Threshold	PF Time Limit (Set to 0 to Disable Protection)	<i>PFAIert</i> and <i>PFStatus</i> Flag	<i>Permanent Fail Cfg Flag</i>
Safety Cell Overvoltage	Cell voltage	—	LT SOV Threshold , ST SOV Threshold, or HT SOV Threshold	SOV Time	[SOV]	[XSOV]
Cell Imbalance Fault	Difference of highest and lowest of <i>CellVoltage4..1</i>	$Current \leq$ Cell Imbalance Current for Battery Rest Time AND All (<i>CellVoltage4..1</i>) > Min CIM-check voltage	Cell Imbalance Fail Voltage	Cell Imbalance Time	[CIM]	[XCIM]
2nd-Level Protection IC Input	FUSE pin voltage	—	FUSE pin voltage > 2V (typical)	PFIN Detect Time	[PFIN]	[XPFIN]
Safety Overcurrent Charge	<i>Current</i>	$Current > 0$	SOC Chg	SOC Chg Time	[SOCC]	[XSOCC]
Safety Overcurrent Discharge	(-) <i>Current</i>	$Current < 0$	SOC Dsg	SOC Dsg Time	[SOCD]	[XSOCD]
Safety Overtemperature Chg	<i>Temperature</i>	$Current > 0$	SOT Chg	SOT Chg Time	[SOTC]	[XSOTC]
Safety Overtemperature Dsg	<i>Temperature</i>	$Current < 0$	SOT Dsg	SOT Dsg Time	[SOTD]	[XSOTD]
Open Thermistor	<i>Temperature</i>	—	Open Thermistor	Open Time	[OTS]	[XOTS]

Table 1-8. Time Limit-Based 2nd-Level Protection (continued)

Protection	Monitored Value	Requirement	PF Threshold	PF Time Limit (Set to 0 to Disable Protection)	PFAAlert and PFStatus Flag	Permanent Fail Cfg Flag
Charge and ZVCHG FET Fault	Current	(CHG FET or ZVCHG FET turn off attempt or CHG Flag in <i>FETStatus</i> clear) and <i>Current</i> > 0	<i>FET Fail Limit</i>	<i>FET Fail Time</i>	[CFETF]	[XCFETF]
Discharge FET Fault	(-)Current	(DSG FET turn off attempt or DSG Flag in <i>FETStatus</i> clear) and <i>Current</i> < 0	<i>FET Fail Limit</i>	<i>FET Fail Time</i>	[DFETF]	[XDFETF]

Related Variables:

- DF:2nd Level Safety:Voltage:LT SOV Threshold
- DF:2nd Level Safety:Voltage:ST SOV Threshold
- DF:2nd Level Safety:Voltage:HT SOV Threshold
- DF:2nd Level Safety:Voltage:SOV Time
- DF:2nd Level Safety:Voltage:Cell Imbalance Current
- DF:2nd Level Safety:Voltage:Cell Imbalance Fail Voltage
- DF:2nd Level Safety:Voltage:Cell Imbalance Time
- DF:2nd Level Safety:Voltage:Battery Rest Time
- DF:2nd Level Safety:Voltage:Min CIM-check voltage
- DF:2nd Level Safety:Voltage:PFIN Detect Time
- DF:2nd Level Safety:Current:SOC Chg
- DF:2nd Level Safety:Current:SOC Chg Time
- DF:2nd Level Safety:Current:SOC Dsg
- DF:2nd Level Safety:Current:SOC Dsg Time
- DF:2nd Level Safety:Temperature:SOT Chg
- DF:2nd Level Safety:Temperature:SOT Chg Time
- DF:2nd Level Safety:Temperature:SOT Dsg
- DF:2nd Level Safety:Temperature:SOT Dsg Time
- DF:2nd Level Safety:Temperature:Open Thermistor
- DF:2nd Level Safety:Temperature:Open Time
- DF:2nd Level Safety:FET Verification:FET Fail Limit
- DF:2nd Level Safety:FET Verification:FET Fail Time
- DF:Configuration:Registers:Permanent Fail Cfg
- DF:PF Status:Device Status Data:PF Flags 1
- SBS:Temperature
- SBS:Voltage
- SBS:Current
- SBS:CellVoltage4..1
- SBS:PFStatus

1.3.3 Limit Based Protection

The bq3055 reports a 2nd level permanent failure and sets the appropriate *PFStatus* flag if the internal error counter reaches the max error limit. The internal error counter is incremented by one if the error happens and decremented by one each fail recovery period.

Integrated AFE Communication Fault Protection — The bq3055 periodically validates its read and write communications with the integrated AFE. If either a read or write verify fails, an internal `AFE_Fail_Counter` is incremented. If the `AFE_Fail_Counter` reaches **AFE Fail Limit**, the bq3055 reports a `[AFE_C]` permanent failure. If the **AFE Fail Limit** is set to 0, this feature is disabled. An `[AFE_C]` fault can also be declared if, after a full reset, the initial gain and offset values read from the AFE cannot be verified. These values are A/D readings of the integrated AFE VCELL output. The integrated AFE offset values are verified by reading the values twice and confirming that the readings are within acceptable limits. The max difference between 2 readings is set with **AFE Init Limit**. The maximum number of read retries, if offset and gain value verification fails and `[AFE_C]` fault is declared, is set in **AFE Fail Limit**.

Periodic AFE Verification — The bq3055 periodically (**AFE Check Time**) compares certain RAM content of the integrated AFE with that of the bq3055 data flash and the expected control-bit states. This function is disabled if **AFE Check Time** is set to 0. If an error is detected, the internal `AFE_Fail_Counter` is incremented. If the internal `AFE_Fail_Counter` reaches the **AFE Fail Limit**, the bq3055 reports a permanent failure.

Integrated AFE Init Verification — After a full reset the bq3055 and the AFE offset and gain values are read twice and compared. The **AFE Init Limit** sets the maximum difference in A/D counts of two successful readings of offset and gain, which the bq3055 still considers as the same value. If the gain and offset values are still not considered the same after **AFE Init Retry Limit** comparison retries, the bq3055 reports a permanent failure error.

Data Flash Failure — The bq3055 can detect if the data flash is not operating correctly. A permanent failure is reported when either: (i) After a full reset the instruction flash checksum does not verify; (ii) if any data flash write does not verify; or (iii) if any data flash erase does not verify.

Table 1-9. Limit Based-2nd Level Protection

Protection	Monitored Value	Fail Recovery	Max Error Limit (Set to 0 to Disable Protection)	PFAAlert Flag, PFStatus Flag	Permanent Fail Cfg Flag
AFE Communication Fault	Periodic Communication with integrated AFE	Decrement of internal <code>AFE_Fail_Counter</code> by one per AFE Fail Recovery Time period	AFE Fail Limit	<code>[AFE_C]</code>	<code>[XAFE_C]</code>
Periodic AFE Verification	Check RAM of integrated AFE with AFE Check Time period	Decrement of internal <code>AFE_Fail_Counter</code> by one per AFE Fail Recovery Time period	AFE Fail Limit	<code>[AFE_P]</code>	<code>[XAFE_P]</code>
AFE Initialization	Initial gain and offset values from integrated AFE after full reset	—	AFE Init Retry Limit	<code>[AFE_C]</code>	<code>[XAFE_C]</code>
Data Flash Failure	Data Flash	—	False flash checksum after reset, data flash write not verified, data flash erase not verified	<code>[DFF]</code>	<code>[XDFF]</code>

Related Variables:

- DF:2nd Level Safety:FET Verification:FET Fail Limit
- DF:2nd Level Safety:FET Verification:FET Fail Time
- DF:2nd Level Safety:AFE Verification:AFE Check Time
- DF:2nd Level Safety:AFE Verification:AFE Fail Limit
- DF:2nd Level Safety:AFE Verification:AFE Fail Recovery Time
- DF:2nd Level Safety:AFE Verification:AFE Init Retry Limit
- DF:2nd Level Safety:AFE Verification:AFE Init Limit
- DF:Configuration:Registers:Permanent Fail Cfg
- DF:PF Status:Device Status Data:PF Flags 1
- SBS:PFStatus

1.3.4 Clearing Permanent Failure

The bq3055 permanent failure can be cleared by sending two *ManufacturerAccess* commands in sequence: the first word of the *PFKey* followed by the second word of the *PFKey*. After sending these two commands in sequence, *PFStatus* flags are cleared. Refer to Permanent Fail Clear (*PFKey*) Manufacturer access for further details.

Related Variables:

- SBS:ManufacturerAccess
- SBS:PFStatus

1.4 Gas Gauging

The bq3055 features the Compensated End of Discharge Voltage (CEDV) gauging algorithm, capable of gauging a maximum capacity of 32 Ah.

The operational overview in Figure 1-6 illustrates the gas gauge operation of the bq3055.

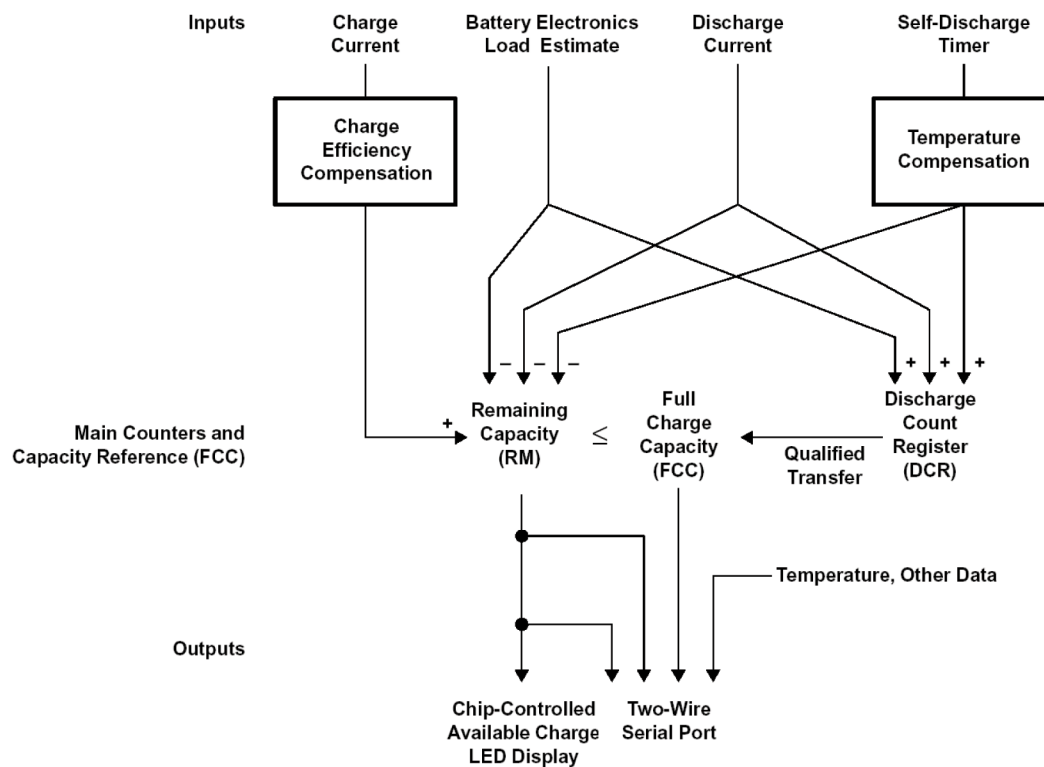

Figure 1-6. bq3055 Gas Gauging Operational Overview

1.4.1 CEDV Gas Gauging Operational Overview

The bq3055 accumulates the measured quantities of charge and discharge and estimates self-discharge of the battery. The bq3055 compensates the charge current measurement for temperature and state-of-charge of the battery. The bq3055 also adjusts the self-discharge estimation based on temperature.

The main charge counter *RemainingCapacity* (RM) represents the available capacity or energy in the battery at any given time. The bq3055 adjusts RM for charge, self-discharge, and other compensation factors. The information in the RM register is accessible through the SMBus interface. The *FullChargeCapacity* (FCC) register represents the initial or last measured full discharge of the battery. It is used as the battery full-charge reference for relative capacity indication. The bq3055 updates FCC after the battery undergoes a qualified discharge from nearly full to a low battery level. FCC is accessible through the SMBus interface.

The Discharge Count Register (DCR) is a non-accessible register that tracks discharge of the battery. The bq3055 uses the DCR register to update the FCC register if the battery undergoes a qualified discharge from nearly full to a low battery level. In this way, the bq3055 learns the true discharge capacity of the battery under system use conditions.

1.4.2 Main Gas Gauge Registers

RemainingCapacity (RM) — Remaining capacity in the battery

RM represents the remaining capacity in the battery. The bq3055 computes RM in units of either mAh or 10 mWh depending on the selected capacity mode. See [Section A.4](#) for unit configuration.

RM counts up during charge to a maximum value of *FCC* and down during discharge and self-discharge to a minimum of 0. In addition to charge and self-discharge compensation, the bq3055 calibrates RM at three low-battery-voltage thresholds, EDV2, EDV1, and EDV0. This provides a voltage-based calibration to the RM counter.

DesignCapacity (DC) — User-specified battery full capacity

DC is the user-specified battery full capacity. It is calculated from **Design Capacity** and is represented in units of mAh or 10 mWh. It also represents the full-battery reference for the absolute display mode.

FullChargeCapacity (FCC) — Last measured discharge capacity of the battery

FCC is the last measured discharge capacity of the battery. It is represented in units of either mAh or 10 mWh, depending on the selected capacity mode. On initialization, the bq3055 sets *FullChargeCapacity* to the data flash value stored in **Full Charge Capacity (FCC)**. During subsequent discharges, the bq3055 updates *FullChargeCapacity* with the last measured discharge capacity of the battery. The last measured discharge of the battery is based on the value in the DCR register after a qualified discharge occurs. Once updated, the bq3055 writes the new *FullChargeCapacity* value to data flash in mAh to **Full Charge Capacity**. *FullChargeCapacity* represents the full battery reference for the relative display mode and relative state of charge calculations.

Discharge Count Register (DCR) —

The DCR register counts up during discharge, independent of RM. DCR counts discharge activity, battery load estimation, and self-discharge increment. The bq3055 initializes DCR, at the beginning of a discharge, to $FCC - RM$ when RM is within the programmed value in **Near Full**. The DCR initial value of $FCC - RM$ is reduced by $FCC/128$ if *SC* = 1 (bit 5 in **CEdV Config**) and is not reduced if *SC* = 0. DCR stops counting when the battery voltage reaches the EDV2 threshold on discharge.

1.4.3 Capacity Learning (FCC Update) and Qualified Discharge

The bq3055 updates *FCC* with an amount based on the value in DCR if a qualified discharge occurs. The new value for *FCC* equals the DCR value plus the programmable nearly full and low battery levels, according to the following equation:

$$FCC \text{ (new)} = DCR \text{ (final)} = DCR \text{ (initial)} + \text{Measured Discharge to EDV2} + (FCC \times \text{Battery_Low}\%)$$

$$\text{Where Battery_Low \%} = (\text{Battery Low \% value in data flash}) \div 2.56$$

A qualified discharge occurs if the battery discharges from $RM \geq FCC$ —**Near Full** to the EDV2 voltage threshold with the following conditions:

- No valid charge activity occurs during the discharge period. A valid charge is defined as a charge of 10 mAh into the battery.
- No more than 256 mAh of self-discharge or battery load estimation occurs during the discharge period.
- The temperature does not drop below the low temperature thresholds programmed in **Low Temp** during the discharge period.
- The battery voltage reaches the EDV2 threshold during the discharge period and the voltage is greater than or equal to the EDV2 threshold minus 256 mV when the bq3055 detected EDV2.
- Current remains $\geq 3C/32$ when EDV2 is reached.

- No overload condition exists when EDV2 threshold is reached, or if RM has dropped to Battery_Low % x FCC.

The bq3055 sets $[VDQ] = 1$ in **Operation Status** when a qualified discharge begins. The bq3055 sets $[VDQ] = 0$ if any disqualifying condition occurs. One complication may arise regarding the state of $[VDQ]$ if **[CSYNC]** is set in **Operation Cfg B**. When **[CSYNC]** is enabled, *RemainingCapacity* is written to equal *FullChargeCapacity* on valid primary charge termination and the charge deficit (difference between FCC and RM) is stored; and when discharge begins, the charge deficit is subtracted from RM. This capacity synchronization is done even if the condition $RM \geq FCC - \text{Near Full}$ is NOT satisfied at charge termination.

FCC cannot be reduced by more than 256 mAh or increased by more than 512 mAh during any single update cycle. The bq3055 saves the new FCC value to the data flash within 4 seconds of being updated.

Related Variables:

- DF:Configuration:Registers:Operation Cfg B[CSYNC]
- DF:SBS Configuration:Full Charge Capacity
- SBS:FullChargeCapacity
- SBS.RemainingCapacity
- SBS:OperationStatus[VDQ]

1.4.4 End-of-Discharge Thresholds and Capacity Correction

The bq3055 monitors the battery for three low-voltage thresholds, EDV0, EDV1, and EDV2. The **[EDVV]** bit in **CEDV Config** configures the bq3055 for single-cell EDV thresholds.

If the **[CEDV]** bit in **CEDV Config** is clear, fixed EDV thresholds may be programmed in **Fixed EDV0**, **Fixed EDV1**, and **Fixed EDV2** in mV.

If the **[CEDV]** bit in **CEDV Config** is set, automatic EDV compensation is enabled and the bq3055 computes the EDV0, EDV1, and EDV2 thresholds based on values stored in the CEDV subclass data-flash from address offsets of 1 through 13 and the battery's current discharge rate and temperature.

The bq3055 disables EDV detection if Current exceeds the **Overload Current** threshold. The bq3055 resumes EDV threshold detection after Current drops below the **Overload Current** threshold. Any EDV threshold detected is reset after charge is applied and $[VDQ]$ is cleared after 10 mAh of charge.

The bq3055 uses the EDV thresholds to apply voltage-based corrections to the RM register according to [Table 1-10](#).

Table 1-10. State of Charge Based on Low Battery Voltage

THRESHOLD	RELATIVE STATE OF CHARGE
EDV0	0%
EDV1	3%
EDV2	Battery Low %

The bq3055 performs EDV-based RM adjustments with $Current \geq C/32$. No EDVs are set if $Current < C/32$. The bq3055 adjusts RM as it detects each threshold. If the voltage threshold is reached before the corresponding capacity on discharge, the bq3055 reduces RM to the appropriate amount as shown in [Table 1-10](#).

If an RM % level is reached on discharge before the voltage reaches the corresponding threshold, then RM is held at that % level until the threshold is reached. RM is only held if $[VDQ] = 1$, indicating a valid learning cycle is in progress. If **Battery Low %** is set to zero, EDV1 and EDV0 corrections are disabled.

Related Variables:

- DF:Gas Gauging:CEDV Cfg:CEDV Config[EDVV],[CEDV]
- DF:Gas Gauging:CEDV Cfg:Fixed EDV0
- DF:Gas Gauging:CEDV Cfg:Fixed EDV1

- DF:Gas Gauging:CEDV Cfg:Fixed EDV0
- SBS:OperationStatus[VDQ]

1.4.5 EDV Discharge Rate and Temperature Compensation

If EDV compensation is enabled, the bq3055 calculates battery voltage to determine EDV0, EDV1, and EDV2 thresholds as a function of battery capacity, temperature, and discharge load. The general equation for EDV0, EDV1, and EDV2 calculation is

$$EDV_{0,1,2} = n (EMF \times FBL - |ILOAD| \times R0 \times FTZ) \quad (1)$$

- EMF is a no-load cell voltage higher than the highest cell EDV threshold computed. EMF is programmed in mV in **EMF**.
- ILOAD is the current discharge load magnitude.
- n = the number of series cells. In the bq3055 case n = 1.
- FBL is the factor that adjusts the EDV voltage for battery capacity and temperature to match the no-load characteristics of the battery.

$$FBL = f (C0, C + C1, T) \quad (2)$$

- C (either 0%, 3%, or Battery Low % for EDV0, EDV1, and EDV2, respectively) and C0 are the capacity related EDV adjustment factors. C0 is programmed in **EDV C0 Factor**. C1 is the desired residual battery capacity remaining at EDV0 (RM = 0). The C1 factor is stored in **EDV C1 Factor**.
- T is the current temperature in °K.
- R0•FTZ represents the resistance of a cell as a function of temperature and capacity.

$$FTZ = f (R1, T0, C + C1, TC) \quad (3)$$

- R0 is the first order rate dependency factor stored in **EDV R0 Factor** (DF).
- T is the current temperature; C is the battery capacity relating to EDV0, EDV1, and EDV2.
- R1 adjusts the variation of impedance with battery capacity. R1 is programmed in **EDV R1 Rate Factor**.
- T0 adjusts the variation of impedance with battery temperature. T0 is programmed in **EDV T0 Rate Factor**.
- TC adjusts the variation of impedance for cold temperatures (T < 23°C). TC is programmed in **EDV TC Factor**.
- Typical values for the EDV compensation factors, based on overall pack voltages for a 3s2p Li-Ion 18650 pack, are
 - EMF = 11550/3
 - T0 = 4475
 - C0 = 235
 - C1 = 0
 - R0 = 5350/3
 - R1 = 250
 - TC = 3

The graphs below show the calculated EDV0, EDV1, and EDV2 thresholds versus capacity using the typical compensation values for different temperatures and loads for a Li-Ion 18650 cell. The compensation values vary widely for different cell types and manufacturers and must be matched exactly to the unique characteristics for optimal performance.

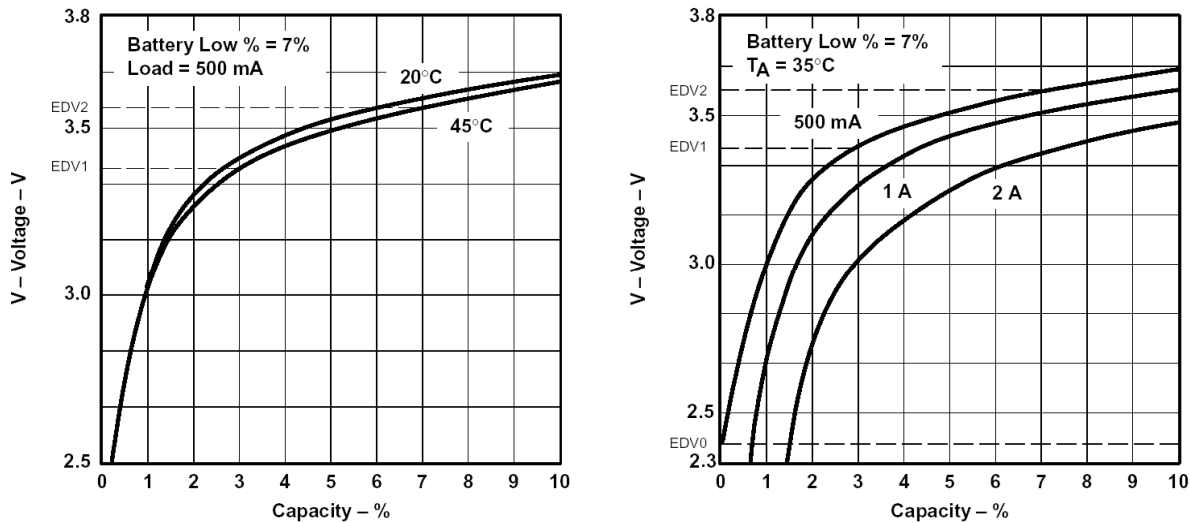

Figure 1-7. (a) EDV Calculations vs Capacity for Various Temperatures, (b) EDV Calculations vs Capacity for Various Loads

1.4.6 EDV Age Factor

EDV Age Factor allows the bq3055 to correct the EDV detection algorithm to compensate for cell aging. This parameter scales cell impedances as the cycle count increases. This new factor is used to accommodate for much higher impedances observed in larger capacity and/or aged cells. For most applications the default value of zero is sufficient. However, for some very specific applications, this new aging factor may be required. In those cases, experimental data must be taken at the 0, 100, 200, and 300 cycle read points using a typical discharge rate while at ambient temperature. Entering this data into a TI provided MathCAD™ program will yield the appropriate **EDV Age Factor** value. Contact TI Applications Support @ <http://www-k.ext.ti.com/sc/technical-support/email-tech-support.asp?AAP> for more detailed information.

1.4.7 Self-Discharge

The bq3055 estimates the self-discharge of the battery to maintain an accurate measure of the battery capacity during periods of inactivity. The bq3055 makes self-discharge adjustments to RM every 1/4 second when awake and periodically when in sleep mode. The period is determined by **Sleep Time**.

The self-discharge estimation rate for 25°C is doubled for each 10 degrees above 25°C or halved for each 10 degrees below 25°C. [Table 1-11](#) shows the relation of the self-discharge estimation at a given temperature to the rate programmed for 25°C.

Table 1-11. Self Discharge for Rate Programmed

TEMPERATURE (°C)	SELF-DISCHARGE RATE
Temp < 10	¼Y% per day
10 ≤ Temp <20	½Y% per day
20 ≤ Temp <30	Y% per day
30 ≤ Temp <40	2Y% per day
40 ≤ Temp <50	4Y% per day
50 ≤ Temp <60	8Y% per day
60 ≤ Temp <70	16Y% per day
70 ≤ Temp	32Y% per day

The nominal self-discharge rate, %PERDAY (% per day), is programmed in an 8-bit value **Self-Discharge Rate** by the following relation:

$$\text{Self-Discharge Rate} = \%PERDAY / 0.01$$

1.4.8 Battery Electronic Load Compensation

The bq3055 can be configured to compensate for a constant load (as from battery electronics) present in the battery pack at all times. The bq3055 applies the compensation continuously when the charge or discharge is below the digital filter. The bq3055 applies the compensation in addition to self-discharge. The compensation occurs at a rate determined by the value stored in *Electronics Load*. The compensation range is 0 μA –765 μA in steps of approximately 3 μA .

The amount of internal battery electronics load estimate in μA , BEL, is stored as follows:

$$\text{Electronics Load} = \text{BEL} / 3$$

1.4.9 CEDV Configuration

Various gas gauging features can be configured by the **CEDV Config** register.

Table 1-12. CEDV Configuration

Feature	Description
SC	The SC bit enables learning cycle optimization for a Smart Charger or independent charge. 1 Learning cycle optimized for independent charger 0 Learning cycle optimized for Smart Charger
CEDV	The CEDV bit determines whether the bq3055 implements automatic EDV compensation to calculate the EDV0, EDV1, and EDV2 thresholds base on rate, temperature, and capacity. If the bit is cleared, the bq3055 uses the fixed values programmed in data flash for EDV0, EDV1, and EDV2. If the bit is set, the bq3055 calculates EDV0, EDV1, and EDV2. 0 EDV compensation disabled 1 EDV compensation enabled
EDVV	The EDVV bit selects whether EDV termination is to be done with regard to voltage or the lowest single-cell voltage. 0 EDV conditions determined on the basis of the lowest single-cell voltage 1 EDV conditions determined on the basis of <i>Voltage</i>

1.4.10 Initial Battery Capacity at Device Reset

The bq3055 estimates the initial capacity of a battery pack at device reset, which is the case when battery cells are first attached to the application circuit. The initial *FullChargeCapacity* (FCC) is a direct copy of the data flash parameter **Full Charge Capacity**. The initial RM and RSOC are estimated using the open-circuit voltage (OCV) characteristics of the programmed Li-ion chemistry (default ID0100), **DOD at EDV2**, and **Qmax Pack**. This gives a reasonably accurate RM and RSOC, however, battery capacity learning is required in order to find the accurate FCC, RM and RSOC. During battery capacity learning, **Full Charge Capacity** and **DOD at EDV2** will be learned and updated.

The data flash parameter *Full Charge Capacity* should be initialized to the **DesignCapacity**. **DOD at EDV2** should be initialized to $(1 - \text{Battery_Low\%}) \times 16384$, where $\text{Battery_Low\%} = \text{Battery Low \%} \div 2.56$.

Related Variables:

- DF:SBS Configuration:Data:Full Charge Capacity
- DF:SBS Configuration:Data:DOD at EDV2
- DF:Gas Gauging:State:Qmax Pack
- DF:Gas Gauging:CEDV Cfg:Battery Low %
- SBS:RelativeStateOfCharge
- SBS:FullChargeCapacity
- SBS.RemainingCapacity

- SBS:DesignCapacity

1.4.11 Gas Gauge Operating Modes

Entry and exit of each mode is controlled by data flash parameters in the subclass "Gas Gauging: Current Thresholds" section. In Relaxation Mode or Discharge Mode, the DSG flag in *BatteryStatus* is set.

Charge mode is exited and Relaxation mode is entered when *Current* goes below **Quit Current** for a period of **Chg Relax Time**. Discharge mode is entered when *Current* goes below **(-)Dsg Current Threshold**. Discharge mode is exited and Relaxation mode is entered when *Current* goes above **(-)Quit Current** threshold for a period of **Dsg Relax Time**. Charge mode is entered when *Current* goes above **Chg Current Threshold**.

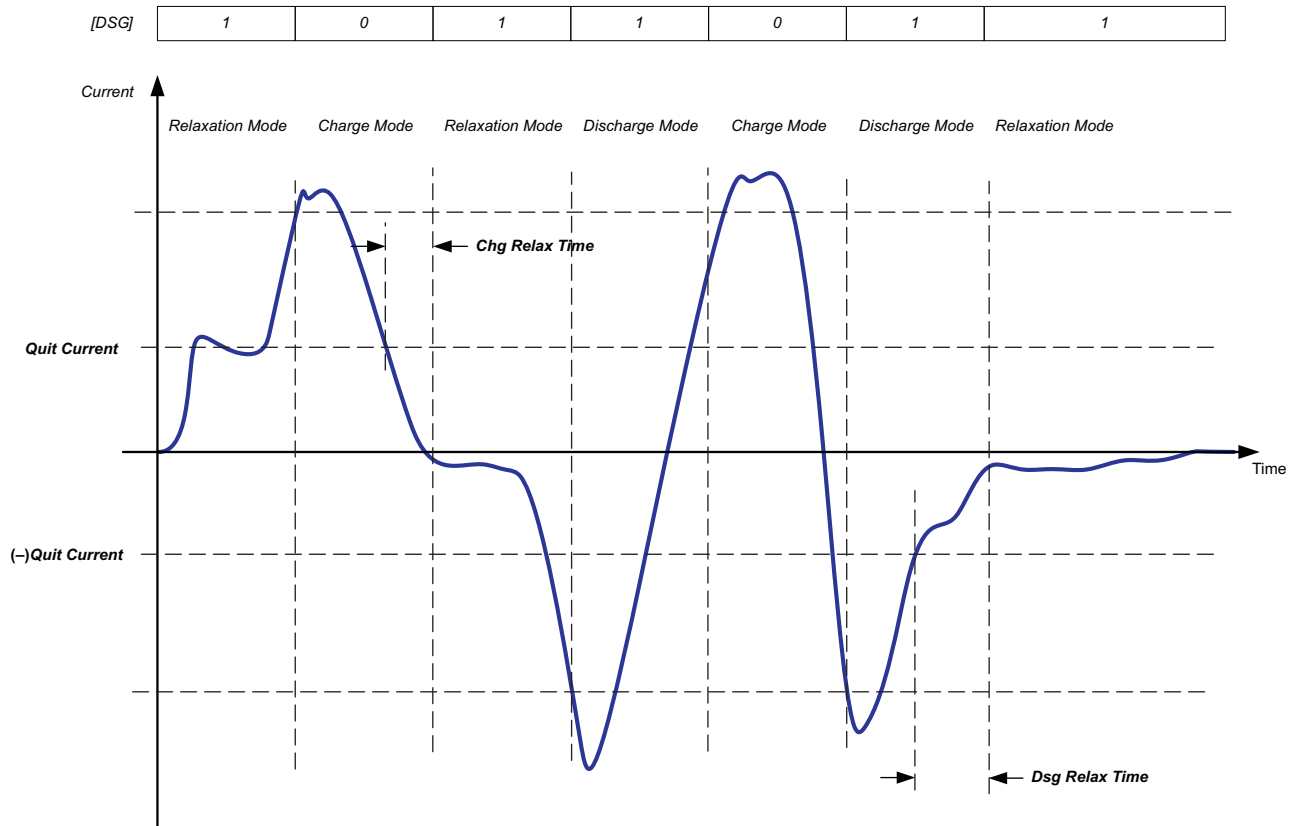

Figure 1-8. Gas Gauge Operating Mode Example

Related Variables:

- DF:Gas Gauging:Current Thresholds:Dsg Current Threshold
- DF:Gas Gauging:Current Thresholds:Chg Current Threshold
- DF:Gas Gauging:Current Thresholds:Quit Current
- DF:Gas Gauging:Current Thresholds:Dsg Relax Time
- DF:Gas Gauging:Current Thresholds:Chg Relax Time
- SBS:Current
- SBS:BatteryStatus[DSG]

1.4.12 Qmax

Qmax is used for initial capacity (RM and RSOC) estimate in conjunction with the cell voltages and programmed chemistry information when device resets. The **Qmax Pack**, **Qmax Cell 0**, **Qmax Cell 1**, **Qmax Cell 2**, and **Qmax Cell 3** values should be taken from the cell manufacturers' data sheet multiplied by the number of parallel cells. This is also used for the *DesignCapacity* function and the **Design Capacity** data flash value.

Related Variables:

- DF:SBS Configuration:Data:Design Capacity
- DF:Gas Gauging:State:Qmax Cell 0
- DF:Gas Gauging:State:Qmax Cell 1
- DF:Gas Gauging:State:Qmax Cell 2
- DF:Gas Gauging:State:Qmax Cell 3
- DF:Gas Gauging:State:Qmax Pack
- SBS:CellVoltage4
- SBS:CellVoltage3
- SBS:CellVoltage2
- SBS:CellVoltage1
- SBS:RelativeStateOfCharge
- SBS:FullChargeCapacity
- SBS.RemainingCapacity
- SBS:DesignCapacity

1.5 Charge Control

The bq3055 can report the appropriate charging current needed for the constant charging current and the charging voltage needed for constant voltage charging per charging algorithm to a smart charger using the *ChargingCurrent* and the *ChargingVoltage* functions. The actual charging status of bq3055 is indicated with flags and can be read out with the *ChargingStatus* function.

- SBS:ChargingCurrent(0x14)
- SBS:ChargingVoltage(0x15)
- SBS:ChargingStatus(0x55)

1.5.1 Charge Control SMBus Broadcasts

All broadcasts to a host or a smart charger are enabled by the **[BCAST]** bit. If the **[HPE]** bit is enabled, Master-Mode broadcasts to the Host address are PEC enabled. If the **[CPE]** bit is enabled, Master-Mode broadcasts to the Smart-Charger address are PEC enabled. When broadcast is enabled, the following broadcasts are sent:

- *ChargingVoltage* and *ChargingCurrent* broadcasts are sent to the Smart-Charger device address (0x12) every 10 to 60 seconds.
- If any of the **[OCA]**, **[TCA]**, **[OTA]**, **[TDA]**, **[RCA]**, **[RTA]** flags are set, the *AlarmWarning* broadcast is sent to the host device address (0x14) every 10 seconds. Broadcasts stop when all flags above have been cleared.
- If any of the **[OCA]**, **[TCA]**, **[OTA]** or **[TDA]** flags are set, the *AlarmWarning* broadcast is sent to Smart-Charger device address every 10 seconds. Broadcasts stop when all flags above have been cleared.

Related Variables:

- DF:Configuration:Registers:Operation Cfg B[CPE],[HPE],[BCAST]
- SBS:ChargingCurrent
- SBS:ChargingVoltage
- SBS:BatteryStatus[OCA],[TCA],[OTA],[TDA],[RCA],[RTA]

1.5.2 Charging and Temperature Ranges

The bq3055 requests different charging current and charging voltage for each of the temperature ranges defined in [Section 1.1](#), through the *ChargingVoltage* and *ChargingCurrent* commands.

Additionally, the charging current can be set differently depending on the cell voltage. Three ranges of cell voltage are defined using two cell voltage thresholds: **Cell Voltage Threshold 1** and **Cell Voltage Threshold 2** (see [Table 1-13](#)). During charging, as cell voltage increases *ChargingCurrent* is set to the appropriate value when cell voltage crosses one of the cell voltage thresholds. However, if cell voltage decreases below the threshold *ChargingCurrent* is not set back to the previous value unless discharge or relax state is detected. This is done to avoid the situation where charging current being changed back and forth due to the voltage drop that results from changing the charging current value. In addition, **Cell Voltage Thresh Hys** is used to make sure that transitions between cell voltage ranges are not affected by small transients.

Table 1-13. Cell Voltage Ranges

Condition	Cell Voltage Range
$\max(\text{CellVoltage4..1}) < \text{Cell Voltage Threshold 1}$	CVR1
$\text{Cell Voltage Threshold 1} < \max(\text{CellVoltage4..1}) < \text{Cell Voltage Threshold 2}$	CVR2
$\text{Cell Voltage Threshold 2} < \max(\text{CellVoltage4..1})$	CVR3

The dependency of the *Charging Voltage* and *Charging Current* on temperature range and cell voltage range is summarized in [Table 1-14](#) and illustrated in [Figure 1-9](#) and [Figure 1-10](#).

Table 1-14. Charging Voltage and Charging Current Dependency on Temperature Range and Cell Voltage Range

Temp Range	Cell Voltage	Charging Voltage	Charging Current
TR1	—	0	0
TR2	CVR1	<i>LT Chg Voltage</i>	<i>LT Chg Current 1</i>
	CVR2		<i>LT Chg Current 2</i>
	CVR3		<i>LT Chg Current 3</i>
TR2A	CVR1	<i>ST1 Chg Voltage</i>	<i>ST1 Chg Current 1</i>
	CVR2		<i>ST1 Chg Current 2</i>
	CVR3		<i>ST1 Chg Current 3</i>
TR3	CVR1	<i>ST2 Chg Voltage</i>	<i>ST2 Chg Current 1</i>
	CVR2		<i>ST2 Chg Current 2</i>
	CVR3		<i>ST2 Chg Current 3</i>
TR4	CVR1	<i>HT Chg Voltage</i>	<i>HT Chg Current 1</i>
	CVR2		<i>HT Chg Current 2</i>
	CVR3		<i>HT Chg Current 3</i>
TR5	—	0	0

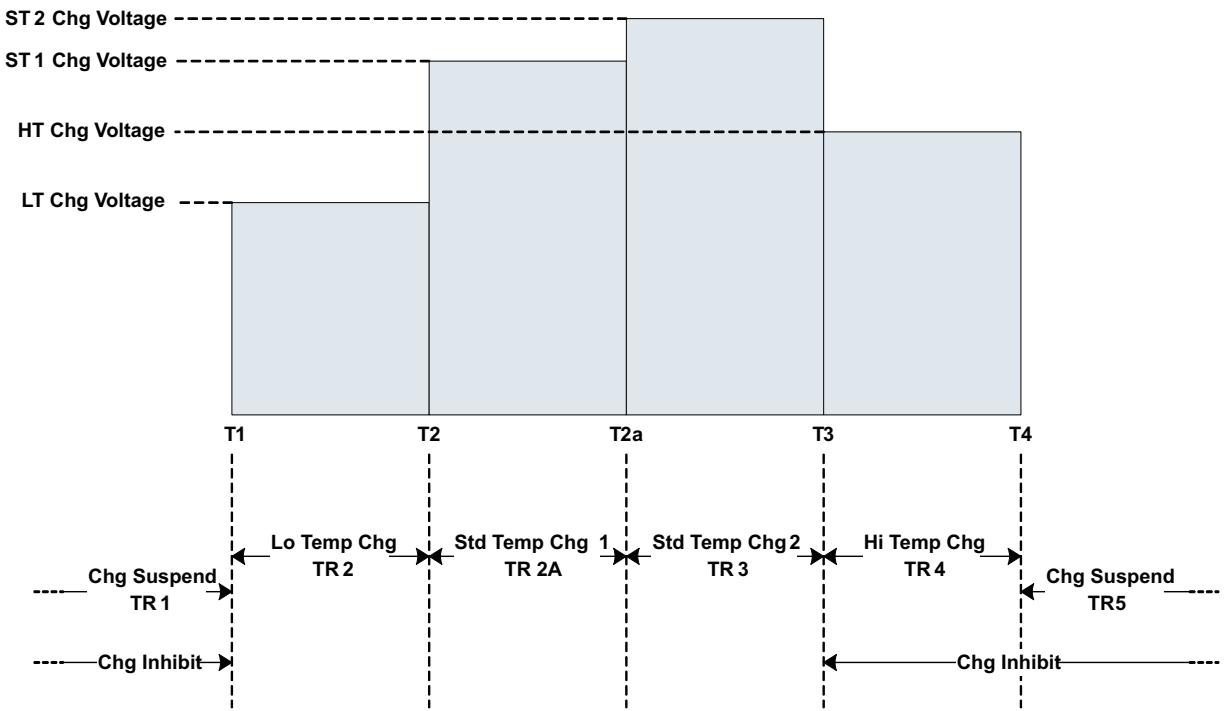

Figure 1-9. Temp Ranges and Charge Voltage for JEITA with Enhancements for More Complex Charging Profiles

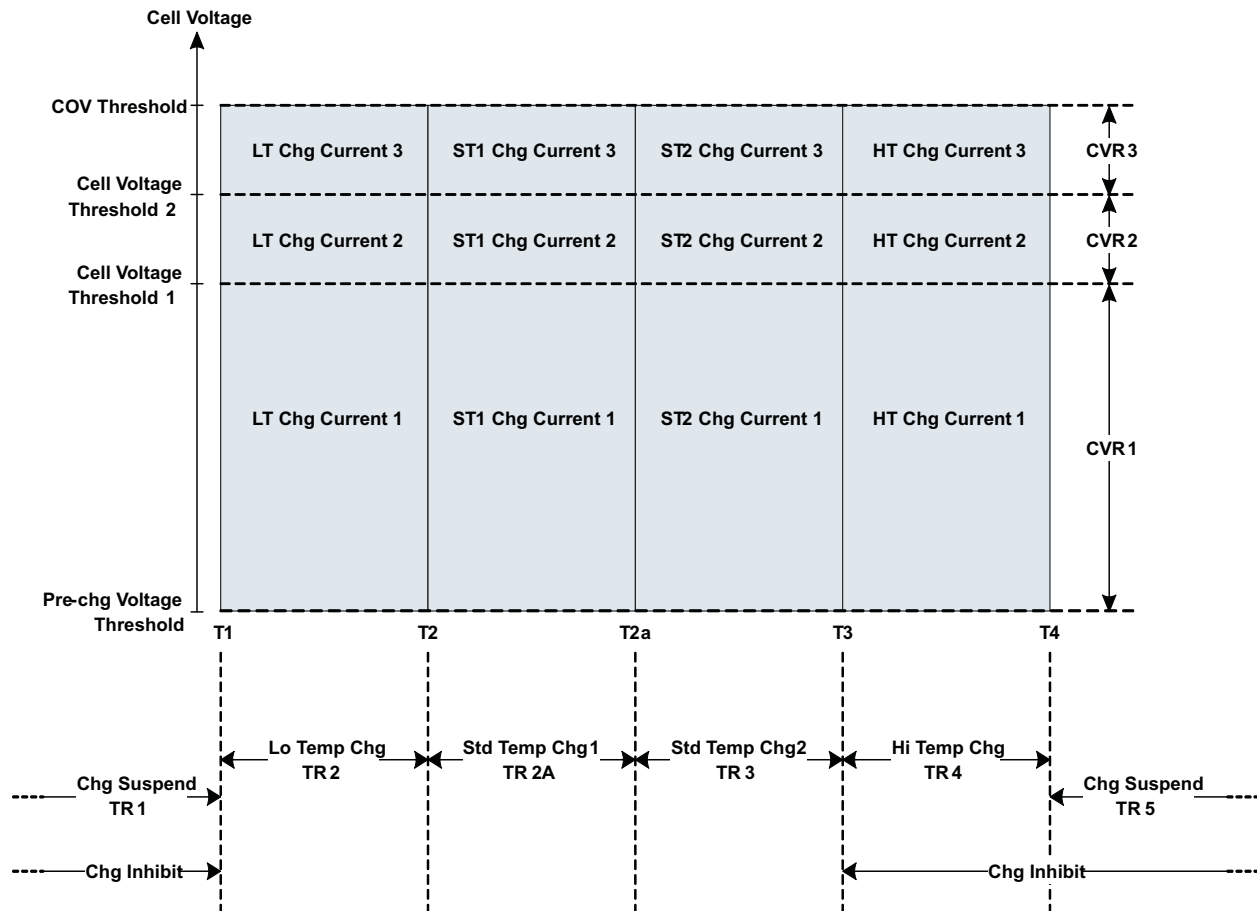

Figure 1-10. Temp Ranges and Charge Current for JEITA with Enhancements for More Complex Charging Profiles

1.5.2.1 Low Temperature Charging

The bq3055 enters this mode when the *Temperature* function reports a temperature in the TR2 range ($JT1 < Temperature < JT2$). In this mode the $[LTCHG]$ flag in *ChargingStatus* is set, the *ChargingVoltage* is set to *LT Chg Voltage*, and the *ChargingCurrent* is set to **LT Chg Current 1**, **LT Chg Current 2**, or **LT Chg Current 3** depending on the active cell voltage range. The charging current dataflash values for low temp charging should be set to low current values similar to precharge mode. The bq3055 leaves this mode and clears the $[LTCHG]$ flag if the *Temperature* goes below $JT1$ or above $JT2 + Temp Hys$.

1.5.2.2 Standard Temperature Charging 1

The bq3055 enters this mode when the *Temperature* function reports a temperature in the TR2A range ($JT2 < Temperature < JT2a$). In this mode the $[ST1CHG]$ flag in *ChargingStatus* is set, *ChargingVoltage* is set to **ST1 Chg Voltage**, and the *ChargingCurrent* is set to **ST1 Chg Current**, **ST1 Chg Current 2**, or **ST1 Chg Current 3** depending on the active cell voltage range. The bq3055 leaves this mode and clears the $[ST1CHG]$ flag if the *Temperature* goes below $JT2$ or above $JT2a$.

1.5.2.3 Standard Temperature Charging 2

The bq3055 enters this mode when the *Temperature* function reports a temperature in the TR3 range ($JT2a < Temperature < JT3$). In this mode the $[ST2CHG]$ flag in *ChargingStatus* is set, *ChargingVoltage* is set to **ST2 Chg Voltage**, and the *ChargingCurrent* is set to **ST2 Chg Current 1** or **ST2 Chg Current 2** or **ST2 Chg Current 3** depending on the active cell voltage. The bq3055 leaves this mode and clears the $[ST2CHG]$ flag if the *Temperature* goes below $JT2a - Temp Hys$ or above $JT3$.

1.5.2.4 High Temperature Charging

The bq3055 enters this mode when the *Temperature* function reports a temperature in the TR4 range ($JT3 < Temperature < JT4$). In this mode the *[HTCHG]* flag in *ChargingStatus* is set, *ChargingVoltage* is set to **HT Chg Voltage**, and the *ChargingCurrent* is set to **HT Chg Current 1**, **HT Chg Current 2**, or **HT Chg Current 3** depending on the active cell voltage. The bq3055 leaves this mode and clears the *[HTCHG]* flag if the *Temperature* goes below $JT3 - Temp Hys$ or above $JT4$.

Related Variables:

- DF:Charge Control:Charge Temperature Cfg:JT1
- DF:Charge Control:Charge Temperature Cfg:JT2
- DF:Charge Control:Charge Temperature Cfg:JT2a
- DF:Charge Control:Charge Temperature Cfg:JT3
- DF:Charge Control:Charge Temperature Cfg:JT4
- DF:Charge Control:Charge Temperature Cfg:Temp Hys
- DF:Charge Control:Charge Cfg:LT Chg Voltage
- DF:Charge Control:Charge Cfg:LT Chg Current 1
- DF:Charge Control:Charge Cfg:LT Chg Current 2
- DF:Charge Control:Charge Cfg:LT Chg Current 3
- DF:Charge Control:Charge Cfg:ST1 Chg Voltage
- DF:Charge Control:Charge Cfg:ST1 Chg Current 1
- DF:Charge Control:Charge Cfg:ST1 Chg Current 2
- DF:Charge Control:Charge Cfg:ST1 Chg Current 3
- DF:Charge Control:Charge Cfg:ST2 Chg Voltage
- DF:Charge Control:Charge Cfg:ST2 Chg Current 1
- DF:Charge Control:Charge Cfg:ST2 Chg Current 2
- DF:Charge Control:Charge Cfg:ST2 Chg Current 3
- DF:Charge Control:Charge Cfg:HT Chg Voltage
- DF:Charge Control:Charge Cfg:HT Chg Current 1
- DF:Charge Control:Charge Cfg:HT Chg Current 2
- DF:Charge Control:Charge Cfg:HT Chg Current 3
- DF:Charge Control:Charge Cfg:Cell Voltage Threshold 1
- DF:Charge Control:Charge Cfg:Cell Voltage Threshold 2
- DF:Charge Control:Charge Cfg:Cell Voltage Thresh Hys
- SBS:Temperature
- SBS:ChargingCurrent
- SBS:ChargingVoltage
- SBS:ChargingStatus[LTCHG] , [ST1CHG] , [ST2CHG], [HTCHG]

1.5.3 Charge-Inhibit Mode

If the bq3055 is in discharge mode or relaxation mode ($[DSG] = 1$), the bq3055 goes into charge-inhibit mode and sets the *ChargingCurrent* and *ChargingVoltage* values to 0 to inhibit charging if:

- $Temperature < JT1$ limit OR
- $Temperature > JT3$ limit

In charge-inhibit mode, the *[XCHG]* flag in *ChargingStatus* is set. If the *[CHGIN]* bit in **Operation Cfg B** is set, the CHG FET and ZVCHG FET (if used) are also turned off when the bq3055 is in charge-inhibit mode.

The bq3055 allows charging to resume when:

- $Temperature \geq JT1 + Temp Hys$ AND

- $Temperature \leq JT3 - Temp Hys$

The FETs also return to their previous states at that time. The $[XCHG]$ flag is cleared when the foregoing conditions are met, when a charge fault condition is detected, or when the battery is removed if in removable mode ($[NR] = 0$).

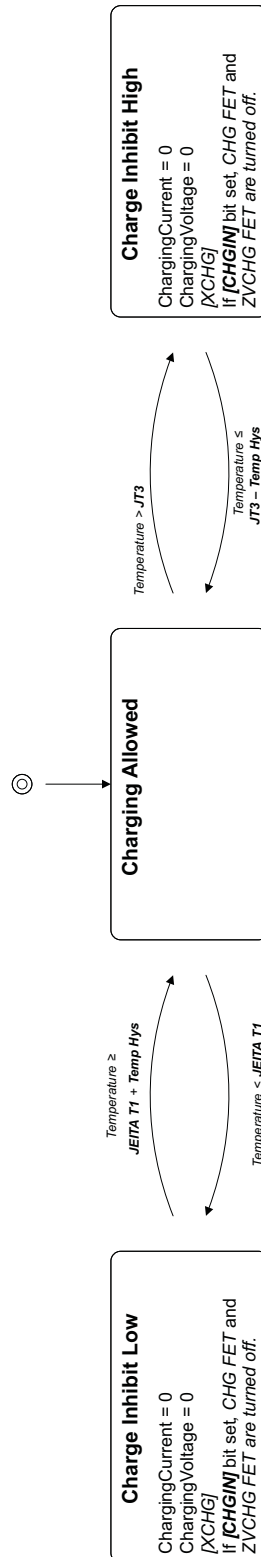

Figure 1-11. Charge Inhibit

Related Variables:

- DF:Charge Control:Charge Temperature Cfg:JT1
- DF:Charge Control:Charge Temperature Cfg:JT3
- DF:Charge Control:Charge Temperature Cfg:Temp Hys
- DF:Configuration:Registers:Operation Cfg B[CHGIN],[NR]
- SBS:Temperature
- SBS:ChargingCurrent
- SBS:ChargingVoltage
- SBS:BatteryStatus[DSG]
- SBS:ChargingStatus[XCHG]

1.5.4 Charge-Suspend Mode

The bq3055 suspends charging when:

- $Temperature < JT1$, OR
- $Temperature > JT4$

In charge-suspend mode, the *[CHGSUSP]* flag in *ChargingStatus* is set and *ChargingCurrent* is set to 0. The CHG FET and ZVCHG FET (if used) are also turned off if the *[CHGSUSP]* bit in the **Operation Cfg B** register is set.

The bq3055 resumes charging if:

- $Temperature \geq JT1 + Temp\ Hys$, AND
- $Temperature \leq JT3 - Temp\ Hys$.

On resuming, the bq3055 clears the *[CHGSUSP]* status flag and sets *ChargingCurrent* according to the appropriate charging mode entered, and the CHG and ZVCHG FETs (if used) return to their previous state.

The bq3055 also leaves the charge-suspend mode and clears the *[CHGSUSP]* flag when a protection condition is detected or when the battery is removed in removable battery mode (*[NR]* = 0).

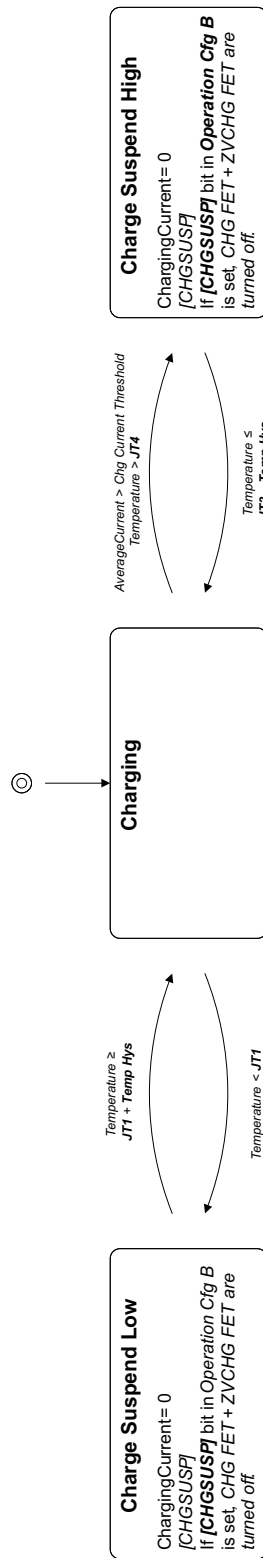

Figure 1-12. Charge Suspend

Related Variables:

- DF:Charge Control:Charge Temperature Cfg:JT1
- DF:Charge Control:Charge Temperature Cfg:JT3
- DF:Charge Control:Charge Temperature Cfg:JT4
- DF:Charge Control:Charge Temperature Cfg:Temp Hys
- DF:Configuration:Registers:Operation Cfg B[CHGSUSP],[NR]
- DF:Gas Gauging:Current Thresholds:Chg Current Threshold
- SBS:Temperature
- SBS:AverageCurrent
- SBS:ChargingCurrent
- SBS:BatteryStatus[DSG]
- SBS:ChargingStatus[CHGSUSP]

1.5.5 Pre-Charge Cfg

The bq3055 enters precharge mode during charging if any cell voltage goes below **Pre-chg Voltage** limit or if any of the *SafetyStatus* flags, [CUV] or [OCD], is set.

Depending on the setting of the [PCHG1] and [PCHG0] bits, PCHG FET can be enabled or disabled in pre-charge mode.

Table 1-15. Precharge FET

PCHG1	PCHG0	FET Used	Functions Supported
0	0	Not defined	No precharge, both CHG and PCHG FET disabled
0	1	CHG FET	Precharge: Requires smart charger that can output precharge current autonomously, or by receiving broadcast charging current/charging voltage from the bq3055; Does not support zero-volt charge
1	0	PCHG FET	Precharge using the PCHG FET
1	1	Not defined	No precharge, both CHG and PCHG FET disabled

In precharge mode the *[PCHG]* flag is set and *ChargingCurrent* is set to **Pre-chg Current**.

The bq3055 leaves Pre-charge mode and clears the *[PCHG]* flag if all cell voltages reach or rise above **Recovery Voltage**. Pre-charge mode is also exited if charge suspend mode is entered, any charge fault condition is detected, or the pack is removed in removable mode.

Related Variables:

- DF:Charge Control:Pre-Charge Cfg:Pre-chg Current
- DF:Charge Control:Pre-Charge Cfg:Pre-chg Voltage
- DF:Charge Control:Pre-Charge Cfg:Recovery Voltage
- DF:Configuration:Registers:Operation Cfg A(0)[PCHG1],[PCHG0]
- SBS:Temperature
- SBS:ChargingCurrent
- SBS:ChargingVoltage
- SBS:CellVoltage4..1
- SBS:SafetyStatus[CUV],[OCD]
- SBS:ChargingStatus[PCHG]

1.5.6 Primary Charge Termination

The bq3055 determines charge termination if:

- Average Charge Current < **Taper Current** during 2 consecutive **Current Taper Window** time periods, AND
- the accumulated change in capacity must be > 0.25 mAh per period during two consecutive **Current Taper Window** time periods, AND
- $Voltage + \text{Taper Voltage} \geq \text{Charging Voltage}$

NOTE: To make sure that the charge terminates properly, it is recommend that **Taper Current** be set to a value greater than **Quit Current**.

The following parameters change the behavior of bq3055 on charge termination:

Table 1-16. Primary Charge Termination

Parameter	Behavior on Primary Charge Termination
<i>TCA Set %</i> = -1	<i>[TCA]</i> flag set, <i>ChargingCurrent</i> = 0
<i>FC Set %</i> = -1	<i>[FC]</i> flag set
<i>[CHGFET]</i> set	CHG FET turned off
<i>[CSYNC]</i> set	<i>RemainingCapacity</i> = <i>FullChargeCapacity</i> regardless of <i>TCA Set %</i> value

Table 1-16. Primary Charge Termination (continued)

Parameter	Behavior on Primary Charge Termination
[RSOCL] set	If the [RSOCL] bit in Operation Cfg C is set then <i>RelativeStateOfCharge</i> and <i>RemainingCapacity</i> are held at 99% until primary charge termination occurs and only displays 100% upon entering primary charge termination.
[RSOCL] clear	If the [RSOCL] bit in Operation Cfg C is cleared then <i>RelativeStateOfCharge</i> and <i>RemainingCapacity</i> are not held at 99% until primary charge termination occurs. Fractions of % greater than 99% are rounded up to display 100%.

Related Variables:

- DF:Charge Control:Fast Charge Cfg:Charging Voltage
- DF:Charge Control:Termination Cfg.:Taper Current
- DF:Charge Control:Termination Cfg.:Taper Voltage
- DF:Charge Control:Termination Cfg.:Current Taper Window
- DF:Charge Control:Termination Cfg.:TCA Set %
- DF:Charge Control:Termination Cfg.:FC Set %
- DF:Configuration:Registers:Operation Cfg B[CHGFET],[CSYNC]
- DF:Configuration:Registers:Operation Cfg C[RSOCL]
- DF:Gas Gauging:Current Thresholds:Quit Current
- SBS:Voltage
- SBS:Current
- SBS:RemainingCapacity
- SBS:FullChargeCapacity
- SBS:ChargingCurrent
- SBS:BatteryStatus[TCA],[FC]

1.5.7 Discharge and Charge Alarms

The bq3055 enables *[TDA]*, *[FD]*, *[TCA]* and *[FC]* flags in *BatteryStatus* to be set or cleared on the following thresholds based on *RelativeStateOfCharge*. All thresholds can be disabled by setting them to -1. **FC Clear** % should not be disabled by setting to -1.

	Threshold	<i>BatteryStatus</i> Flag
<i>RelativeStateOfCharge</i>	\leq TDA Set %	<i>[TDA]</i> is set
	\geq TDA Clear %	<i>[TDA]</i> is cleared
	\leq FD Set %	<i>[FD]</i> is set
	\geq FD Clear %	<i>[FD]</i> is cleared
	\geq TCA Set %	<i>[TCA]</i> is set
	\leq TCA Clear %	<i>[TCA]</i> is cleared
	\geq FC Set %	<i>[FC]</i> is set
	\leq FC Clear %	<i>[FC]</i> is cleared

The *[TDA]* and *[FD]* flags in *BatteryStatus* can also be set or cleared based on *Voltage*. If the voltage settings are not used then they should be set to extreme range values.

	Threshold	<i>BatteryStatus</i> Flag
<i>Voltage</i>	\leq TDA Volt Threshold for a period of TDA Volt Time	<i>[TDA]</i> is set
	\geq TDA Clear Volt	<i>[TDA]</i> is cleared
	\leq FD Volt Threshold for a period of FD Volt Time	<i>[FD]</i> is set
	\geq FD Clear Volt	<i>[FD]</i> is cleared

Related Variables:

- DF:Charge Control:Termination Cfg.:TCA Set %
- DF:Charge Control:Termination Cfg.:TCA Clear %
- DF:Charge Control:Termination Cfg.:FC Set %
- DF:Charge Control:Termination Cfg.:FC Clear %
- DF:SBS Configuration:Configuration:TDA Set %
- DF:SBS Configuration:Configuration:TDA Clear %
- DF:SBS Configuration:Configuration:FD Set %
- DF:SBS Configuration:Configuration:FD Clear %
- DF:SBS Configuration:Configuration:TDA Set Volt Threshold
- DF:SBS Configuration:Configuration:TDA Set Volt Time
- DF:SBS Configuration:Configuration:TDA Clear Volt
- DF:SBS Configuration:Configuration:FD Set Volt Threshold
- DF:SBS Configuration:Configuration:FD Volt Time
- DF:SBS Configuration:Configuration:FD Clear Volt
- SBS:Voltage
- SBS:RelativeStateOfCharge

1.5.8 Cell Balancing

Cell balancing in bq3055 is accomplished by connecting an external parallel bypass load to each cell, and enable the bypass load depending on each individual cell's charge state. The bypass load is typically formed by a P-ch MOSFET and a resistor connected in series across each battery cell. The filter resistors that connect the cell tabs to VC1~VC4 pins of the bq3055 are required to be 1k ohms. Using this circuit, the bq3055 balances the cells during charge by discharging those cells above the threshold set in *Cell Balance Threshold*, if the maximum difference in cell voltages exceeds the value programmed in *Cell Balance Min.* During cell balancing, the bq3055 measures the cell voltages at an interval set in *Cell Balance Interval*. On the basis of the cell voltages, the bq3055 either selects the appropriate cell to discharge or adjusts the cell balance threshold up by the value programmed in *Cell Balance Window* when all cells exceed the cell balance threshold or the highest cell exceeds the cell balance threshold by the cell balance window.

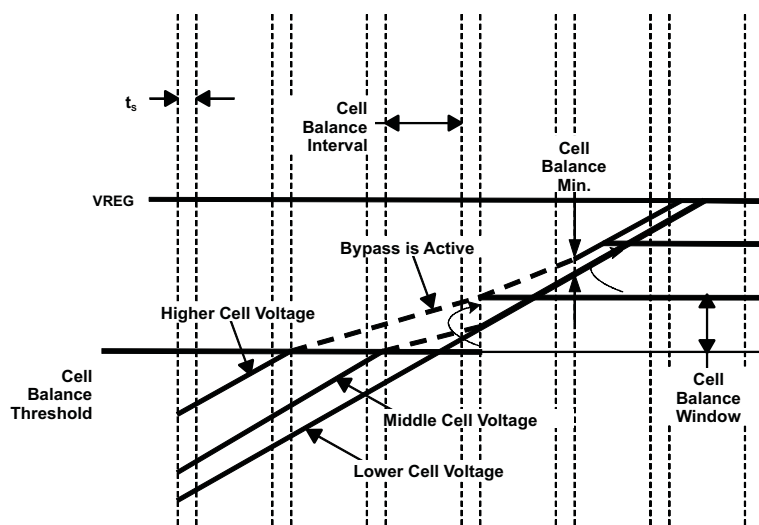

Figure 1-13. Cell Balancing

Cell balancing only occurs when charging current is detected. The cell balance threshold is reset to the value in *Cell Balance Threshold* at the start of every charge cycle. The threshold is only adjusted once during any balance interval.

Related Variables:

- DF:Charge Control:Cell Balancing:Cell Balance Threshold
- DF:Charge Control:Cell Balancing:Cell Balance Window
- DF:Charge Control:Cell Balancing:Cell Balance Min
- DF:Charge Control:Cell Balancing:Cell Balance Interval
- SBS:CellVoltage4
- SBS:CellVoltage3
- SBS:CellVoltage2
- SBS:CellVoltage1
- SBS:ChargingStatus[CB]

1.5.9 Charging Faults

The bq3055 can report charging faults in the *ChargingStatus* register.

On occurrence of a FCMTO, PCMTO, OCHGV, and OC charging fault the bq3055 sets:

- The appropriate *ChargingStatus* flag
- If the flags in **Charge Fault Cfg** and *ChargingStatus* match, the CHG FET (or the ZVCHG FET if in precharge) is turned off.
- *ChargingCurrent* = 0, *ChargingVoltage* = 0.
- [TCA] flag in *BatteryStatus*
- [OC] flag in *BatteryStatus* if it's an Overcharge fault

On occurrence of a OCHGI charging fault the bq3055 sets:

- The [OCHGI] *ChargingStatus* flag
- If the [OCHGI] bit in **Charge Fault Cfg** is set, the CHG FET is turned off and the ZVCHG FET (if enabled, i.e. [ZVCHG1]:[ZVCHG2] = 0:0 in **Operation Cfg A**) is turned on. If ZVCHG FET is not enabled in **Operation Cfg A**, CHG FET remains on, regardless of this bit.
- *ChargingCurrent* = 0, *ChargingVoltage* = 0.
- [TCA] flag in *BatteryStatus*

On occurrence of a XCHGLV charging fault the bq3055 sets:

- The [XCHGLV] *ChargingStatus* flag
- If the [CS_XCHGLV] bit in **Charge Fault Cfg** is set, the DSG FET is turned off (if not already turned off by cell under voltage protection); the ZVCHG FET remains on. If the ZVCHG FET is not enabled in **Operation Cfg A**, CHG FET remains on.
- *ChargingCurrent* = 0; *ChargingVoltage* is not set to zero since it is a Battery Depleted fault.
- [TCA] flag in *BatteryStatus*

On Recovery the bq3055:

- Resets the appropriate *ChargingStatus* flags
- CHG FET and ZVCHG FET (if used) return to previous states. In PCMTO, if the bq3055 recovers by discharge current and the discharge current sustains, the CHG FET is turned on even if the device is still in precharge mode. DSG FET is also allowed to turn on again on recovery from Battery Depleted fault.
- Sets *ChargingCurrent* and *ChargingVoltage* back to previous state according to charging algorithm.
- Resets [TCA] flag in *BatteryStatus*

Precharge Mode Timeout

When *Current* is \geq **Chg Current Threshold** the bq3055 starts the Precharge Timer. The Precharge Timer is suspended when precharge mode is not active ($[PCHG] = 0$), or when $[DSG] = 1$. The precharge Timer is reset when an amount of discharge greater than **Over Charge Recovery** is detected or the pack is removed and reinserted when $NR = 0$. Set **PC-MTO** to zero to disable this feature.

The bq3055 goes into precharge mode charging timeout if:

- Precharge timer \geq **PC-MTO**

The bq3055 suspends the precharge timer if:

- $Current \leq (-)Dsg\ Current\ Threshold$

The bq3055 recovers (i.e. timer resets) if:

- **PC-MTO** is set, OR
- An amount of discharge greater than **Over Charge Recovery** is detected, OR
- Pack is removed and reinserted, if $[NR] = 0$

Fast Charge Mode Timeout

When *Current* is \geq **Chg Current Threshold**, the bq3055 starts the Fast Charge timer. The Fast Charge Timer is suspended when fast charge is not active ($[FCHG] = 0$), or when $[DSG] = 1$. The Fast Charge Timer is reset when an amount of discharge greater than **Over Charge Recovery** is detected or the pack is removed and reinserted when $NR = 0$. Set **FC-MTO** to 0 to disable this feature.

The bq3055 goes into fast charge mode charging timeout if:

- Fast charge timer \geq **FC-MTO**

The bq3055 suspends the fast charge timer if:

- $Current \leq (-)Dsg\ Current\ Threshold$

The bq3055 recovers (i.e. timer resets) if:

- **FC-MTO** is set, OR
- An amount of discharge greater than **Over Charge Recovery** is detected, OR
- Pack is removed and reinserted if $[NR] = 0$

Overcharging Voltage

The bq3055 goes into overcharging voltage mode if:

- $Voltage \geq Charging\ Voltage + Over\ Charging\ Voltage$ for min. **Over Charging Volt Time** period.

The bq3055 recovers, if:

- $Voltage \leq Charging\ Voltage$

Overcharging Current

The bq3055 goes into overcharging current mode if:

- $Current \geq ChargingCurrent + Over\ Charging\ Current$ for min. **Over Charging Curr Time** period.

The bq3055 recovers, if:

- $AverageCurrent \leq Over\ Charging\ Curr\ Recov$

Overcharge

The bq3055 goes into overcharge mode if the battery pack is charged in excess of *FullChargeCapacity* by **Over Charge Capacity**:

The bq3055 recovers if any of the following conditions are met:

- Pack removed and reinserted ($[NR] = 0$)
- Continuous amount of discharge over **Over Charge Recovery** and $AverageCurrent < 0$, when $[NR] = 1$
- $RemainingCapacity \leq FC\ Clear\ \%$

Battery Depleted

The bq3055 goes into battery depleted mode if:

- $Voltage \leq \text{Depleted Voltage}$ for **Depleted Voltage Time** and charger is present

The bq3055 recovers, if:

- $Voltage > \text{Depleted Voltage Recovery}$

Table 1-17. Charging Faults

Charge Fault	Fault Condition	Recovery Condition	ChargingStatus Flag, Charge Fault Configuration Flag
Precharge Timeout	Precharge Timer \geq PC-MTO	$Current \leq (-)Dsg \text{ Current Threshold}$, OR Pack removed and reinserted if [NR] = 0	[PCMTO]
Fast charge Timeout	Fast charge Timer \geq FC-MTO		[FCMTO]
Overcharging Voltage	$Voltage \geq \text{Charging Voltage} + \text{Over Charging Voltage}$ for min. Over Charging Volt Time	$Voltage \leq \text{Charging Voltage}$	[OCHGV]
Overcharging Current	$Current \geq \text{ChargingCurrent} + \text{Over Charging Current}$ for min. Over Charging Curr Time	$AverageCurrent \leq \text{Over Charging Curr Recov}$	[OCHGI]
Overcharge	$RemainingCapacity - FullChargeCapacity \geq \text{Over Charge Capacity}$	Pack removed and reinserted if [NR] = 0, OR continuous amount of discharge of Over Charge Recovery if [NR] = 1, OR $RemainingCapacity \leq \text{FC Clear \%}$	[OC]
Battery Depleted	$Voltage \leq \text{Depleted Voltage}$ for min Depleted Voltage Time	$Voltage > \text{Depleted Voltage Recovery}$	[XCHGLV], [CS_XCHGLV]

Related Variables:

- DF:Charge Control:Fast Charge Cfg:Charging Voltage
- DF:Charge Control:Termination Cfg.:FC Clear %
- DF:Charge Control:Charging Faults:Over Charging Voltage
- DF:Charge Control:Charging Faults:Over Charging Volt Time
- DF:Charge Control:Charging Faults:Over Charging Current
- DF:Charge Control:Charging Faults:Over Charging Curr Time
- DF:Charge Control:Charging Faults:Over Charging Curr Recov
- DF:Charge Control:Charging Faults:Depleted Voltage
- DF:Charge Control:Charging Faults:Depleted Voltage Time
- DF:Charge Control:Charging Faults:Depleted Recovery
- DF:Charge Control:Charging Faults:Over Charge Capacity
- DF:Charge Control:Charging Faults:Over Charge Recovery
- DF:Charge Control:Charging Faults:FC-MTO
- DF:Charge Control:Charging Faults:PC-MTO
- DF:Charge Control:Charging Faults:Charge Fault Cfg
- DF:Configuration:Registers:Operation Cfg B[**NR**]
- SBS:Voltage
- SBS:Current
- SBS:AverageCurrent
- SBS:ChargingCurrent
- SBS:ChargingVoltage
- SBS:BatteryStatus[TDA],[TCA],[OCA]
- SBS:ChargingStatus[FCHG]

1.6 Device Operating Mode

The bq3055 has several device power modes. During these modes, the bq3055 modifies its operation to minimize power consumption from the battery.

1.6.1 Normal Mode

During normal operation, the bq3055 takes *Current*, *Voltage*, and *Temperature* measurements, performs calculations, updates SBS data, and makes protection and status decisions at one-second intervals. Between these periods of activity, the bq3055 is in a reduced power state.

\overline{PRES} is sampled once per second and if \overline{PRES} is high, the *OperationStatus [PRES]* flag is cleared. If \overline{PRES} is low, the *OperationStatus [PRES]* flag is set indicating the system is present (the battery is inserted).

If the **[NR]** bit is set, the \overline{PRES} input can be left floating as it is not monitored.

Related Variables:

- DF:Configuration:Registers:Operation Cfg B[NR]
- SBS:OperationStatus[PRES]

1.6.2 Battery Pack Removed Mode/System Present Detection

1.6.2.1 Battery Pack Removed

The bq3055 detects the Battery Pack Removed state if **[NR]** bit is set to 0 AND the \overline{PRES} input is high ($[PRES] = 0$).

On entry to the Battery Pack Removed state, *[TCA]* and *[TDA]* flags are set, *ChargingCurrent* and *ChargingVoltage* are set to 0, the CHG and DSG FETs are turned off, and the ZVCHG FET is turned off (if used).

Polling of the \overline{PRES} pin continues at a rate of once every 1 s.

The bq3055 exits the Battery Pack Removed state if **[NR]** flag is set to 0, AND the \overline{PRES} input is low ($[PRES] = 1$). When this occurs, *[TCA]* and *[TDA]* flags are reset.

Related Variables:

- DF:Configuration:Registers:Operation Cfg B[NR]
- SBS:BatteryStatus[TCA],[TDA]
- SBS:OperationStatus[PRES]

1.6.2.2 System Present

\overline{PRES} is sampled once per second and if \overline{PRES} is high, the *OperationStatus [PRES]* flag is cleared. If \overline{PRES} is low, the *OperationStatus [PRES]* flag is set indicating the system is present (the battery is inserted). If the **[NR]** bit is set, the \overline{PRES} input is ignored and can be left floating. The bq3055 turns on both CHG and DSG FET when the *OperationStatus [PRES]* flag is set and the device is operating in the normal mode with no safety conditions.

Related Variables:

- DF:Configuration:Registers:Operation Cfg B[NR]
- SBS:OperationStatus[PRES]

1.6.3 Sleep Mode

In Sleep mode the bq3055 measures Voltage and Temperature in **Sleep Voltage Time** intervals and *Current* at **Sleep Current Time** intervals. At each interval the bq3055 performs calculations, updates SBS data, and makes protection and status decisions. Between these periods of activity, the bq3055 is in a reduced-power state.

The bq3055 enters Sleep mode when the following conditions exist:

- If **[NR]** bit is set to 0, **[PRES]** must also be cleared for the bq3055 to enter sleep.
AND one of the following conditions:
 - ($|Current| \leq \text{Sleep Current}$) AND (SMBus is low for **Bus Low Time**) AND (**[SLEEP]** bit is set)
 - OR
 - ($|Current| \leq \text{Sleep Current}$) AND (*ManufacturerAccess* Sleep command is received) AND (**[SLEEP]** is set).

Entry to Sleep mode is blocked if any of the *PFStatus* flags are set. If **Sleep Voltage Time** = 0 or **Sleep Current Time** = 0, sleep mode is not entered, and the bq3055 remains in Normal mode.

On entry to sleep, if **[NR]** = 0, the CHG and DSG FETs are turned off, and the ZVCHG FET is turned off (if used) regardless of **[NRCHG]** setting. If **[NR]** = 1, the CHG FET is turned off, and the ZVCHG FET is turned off (if used). However, if **[NRCHG]** is set then the CHG FET remains on.

Typically, on entry to Sleep mode, the auto calibration of the A/DC begins. However, if *Temperature* is \leq **Cal Inhibit Temp Low** or *Temperature* \geq **Cal Inhibit Temp High**, or if the Sleep is caused by the *ManufacturerAccess* Sleep command, Auto Calibration is not started on entry to sleep mode. The activation of auto calibration is not affected by the state of **[SLEEP]**, **Sleep Voltage Time**, **Sleep Current Time**, or *Current*.

The bq3055 exits Sleep mode when one or more of the following conditions exist:

- If the **[NR]** bit is set to 0 and **[PRES]** is set to 1.
- ($|Current| > \text{Sleep Current}$)
- SMBC or SMBD inputs transition high
- *OperationStatus*, *ChargingStatus* or *SafetyStatus* are set
- Wake function enabled by setting **Wake Current Reg** and a voltage across SRP and SRN is detected

The bq3055 exits Sleep mode if absolute value of *Current* is greater than **Sleep Current**, OR the SMBC or SMBD inputs transition high, OR any *OperationStatus*, *ChargingStatus*, or *SafetyStatus* flags change state.

In addition, if **[NR]** is cleared, the bq3055 exits Sleep mode when **[PRES]** = 1.

Related Variables:

- DF:Configuration:Registers:Operation Cfg A[SLEEP]
- DF:Configuration:Registers:Operation Cfg B[NR],[NRCHG]
- DF:Power:Power:Sleep Current
- DF:Power:Power:Bus Low Time
- DF:Power:Power:Cal Inhibit Temp Low
- DF:Power:Power:Cal Inhibit Temp Low
- DF:Power:Power:Sleep Voltage Time
- DF:Power:Power:Sleep Current Time
- DF:Power:Power:Wake Current Reg
- SBS:ManufacturerAccess:Sleep
- SBS:Current
- SBS:SafetyStatus
- SBS:OperationStatus[PRES]

1.6.4 Wake Function

The bq3055 can exit sleep mode, if enabled, by the presence of a voltage across SRP and SRN. The level of the current signal needed is programmed in **Wake Current Reg**.

	bit 7	bit 6	bit 5	bit 4	bit 3	bit 2	bit 1	bit 0
Low Byte	RSVD	RSVD	RSVD	RSVD	RSVD	IWAKE	RSNS1	RSNS0

LEGEND: RSVD = Reserved and **must** be programmed to 0

Figure 1-14. Wake Current Reg

IWAKE — This bit sets the current threshold for the Wake function.

0 = 0.5A (or if RSNS0=RSNS1=0 then this function is disabled)

1 = 1.0A (or if RSNS0=RSNS1=0 then this function is disabled)

Table 1-18. Wake Current Reg

RSNS1	RSNS0	Resistance
0	0	Disabled (default)
0	1	2.5 mΩ
1	0	5 mΩ
1	1	10 mΩ

Related Variables:

- DF:Configuration:Registers:Operation Cfg A[SLEEP]
- DF:Power:Power:Wake Current Reg
- SBS:Current

1.6.5 Shutdown Mode

The bq3055 enters Shutdown mode if the following conditions are met:

- **[SHUTV]** in **Operation Cfg C** is set to 0 AND $Voltage \leq \text{Shutdown Voltage}$ AND $Current \leq 0$ for a period of **Cell Shutdown Time** AND $PackVoltage < \text{AFE Shutdown Voltage}$ threshold.
OR
- **[SHUTV]** in **Operation Cfg C** is set to 1 AND $\text{Min}(CellVoltage4..1) \leq \text{Cell Shutdown Voltage}$ AND $Current \leq 0$ for a period of **Shutdown Time** AND $PackVoltage < \text{AFE Shutdown Voltage}$ threshold.
OR
- (*ManufacturerAccess* shutdown command received AND $Current = 0$) AND $PackVoltage < \text{AFE Shutdown Voltage}$ threshold.

When the bq3055 meets these conditions, the CHG, DSG, and ZVCHG FETs are turned off, and the integrated AFE is commanded to shut down. In Shutdown mode, the bq3055 is completely powered down because its supply is removed.

To exit Shutdown mode the voltage at the PACK pin must be greater than the startup voltage specified in bq3055 datasheet. When this happens, the integrated AFE returns power to the bq3055, the **[WAKE]** flag is set, and the integrated AFE is configured by the AGG. The **[WAKE]** flag is cleared and the **[INIT]** flag is set after approximately 1 s when all SBS parameters have been measured and updated.

Related Variables:

- DF:Power:Power:Shutdown Voltage
- DF:Power:Power:Shutdown Time
- DF:Power:Power:Cell Shutdown Voltage
- DF:Power:Power:Cell Shutdown Time
- DF:Power:Power:AFE Shutdown Voltage
- DF:Configuration:Registers:Operation Cfg B[NR]
- DF:Configuration:Registers:Operation Cfg C[SHUTV]
- SBS:Voltage

- SBS:Current
- SBS:BatteryStatus(0x16)[INIT]
- SBS:CellVoltage4..1
- SBS:OperationStatus[PRES],[WAKE]
- SBS:PackVoltage

1.7 Security (Enables and Disables Features)

There are three levels of secured operation within the bq3055. To switch between the levels, different operations are needed with different codes. The three levels are Sealed, Unsealed, and Full Access.

- 1. Full Access or Unsealed to Sealed** — The use of the *Seal Device* command instructs the bq3055 to limit access to the SBS functions and data flash space and sets the *[SS]* flag. In sealed mode, standard SBS functions have access per the Smart Battery Data Specification—Appendix A. Extended SBS Functions and data flash are not accessible. Once in sealed mode, the part can never permanently return to Unsealed or Full Access modes.
- 2. Sealed to Unsealed** — Instructs the bq3055 to extend access to the SBS and data flash space and clears the *[SS]* flag. In unsealed mode, all data, SBS, and DF have read/write access. Unsealing is a two-step command performed by writing the 1st word of the *UnSealKey* to *ManufacturerAccess* followed by the second word of the *UnSealKey* to *ManufacturerAccess*. The unseal key can be read and changed via the extended SBS block command *UnSealKey* when in Full Access Mode. To return to the Sealed mode, either a hardware reset is needed, or the *ManufacturerAccess* seal device command is needed to transit from Full Access or Unsealed to Sealed.
- 3. Unsealed to Full Access** — Instructs the bq3055 to allow Full Access to all SBS commands and data flash. The bq3055 is shipped from TI in this mode. The keys for Unsealed to Full Access can be read and changed via the extended SBS block command *FullAccessKey* when in Full Access mode. Changing from Unsealed to Full Access is performed by using the *ManufacturerAccess* command, by writing the 1st word of the *FullAccessKey* to *ManufacturerAccess* followed by the second word of the *FullAccessKey* to *ManufacturerAccess*. The full access key can be read and changed via the extended SBS block command *FullAccessKey* when in Full Access Mode. In Full Access mode, the command to go to Boot ROM can be sent.

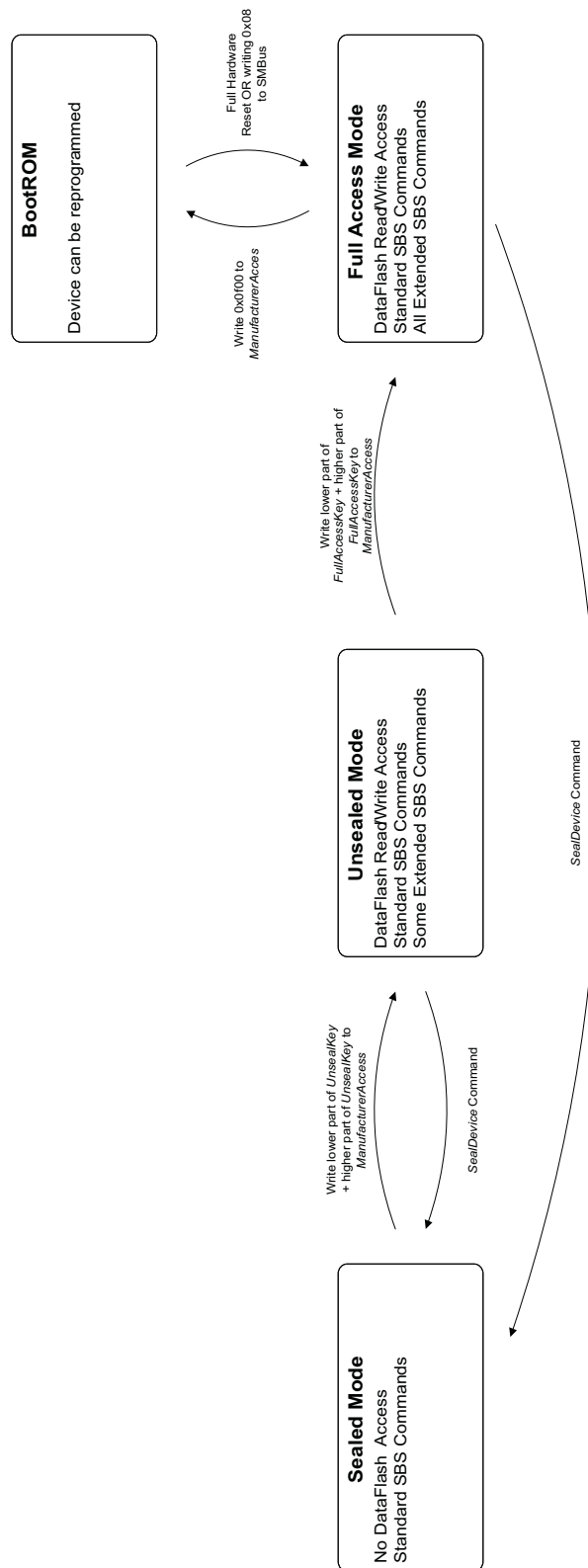

Figure 1-15. Security

Related Variables:

- SBS:ManufacturerAccess:Seal Device

- SBS:OperationStatus[SS],[FAS]
- SBS:UnSealKey
- SBS:FullAccessKey

1.8 Calibration

The bq3055 has integrated routines that support calibration of current, voltage, and temperature readings, accessible after writing 0xF081 or 0xF082 to ManufacturerAccess().

When the calibration routines are activated, the raw ADC data is available through the ManufacturerData() command, which returns a 26-byte data block.

ManufacturerAccess()	Description
0x002D	Enable/Disable Calibration Mode in ManufacturingStatus()
0xF080	Exit Calibration Mode
0xF081	Output raw ADC data of voltage, current, and temperature on ManufacturerData()
0xF082	Output raw ADC data of voltage, current, and temperature on ManufacturerData(). This mode includes a shunt of the Coulomb Counter input.

The calibration procedure requires writing to the following DF constants:

Table 1-19. Calibration Data Flash Constants

Class	SubClass	Name	Data Type	Min	Max	Default	Unit
Calibration	Voltage	Cell Scale 0	I2	0	32767	20500	—
Calibration	Voltage	Cell Scale 1	I2	0	32767	20500	—
Calibration	Voltage	Cell Scale 2	I2	0	32767	20500	—
Calibration	Voltage	Cell Scale 3	I2	0	32767	20500	—
Calibration	Voltage	PACK Gain	U2	0	65535	44100	—
Calibration	Voltage	BAT Gain	U2	0	65535	44100	—
Calibration	Current	CC Gain	F4	1.00E-01	4.00E+00	0.9419	—
Calibration	Current	Capacity Gain	F4	2.98E+04	1.19E+06	280932.625	—
Calibration	Current Offset	CC Offset	I2	-32767	32767	-7744	—
Calibration	Current Offset	Coulomb Counter Offset Samples	U2	0	65535	64	—
Calibration	Current Offset	Board Offset	I2	-32767	32767	0	—
Calibration	Temperature	Internal Temp Offset	I1	-128	127	0	0.1°C
Calibration	Temperature	External 1 Temp Offset	I1	-128	127	0	0.1°C
Calibration	Temperature	External 2 Temp Offset	I1	-128	127	0	0.1°C
Calibration	Temperature	External 3 Temp Offset	I1	-128	127	0	0.1°C
Calibration	Temperature	External 4 Temp Offset	I1	-128	127	0	0.1°C
Calibration	Internal Temp Model	Int Coeff 1	I2	-32768	32767	0	—
Calibration	Internal Temp Model	Int Coeff 2	I2	-32768	32767	0	—

Table 1-19. Calibration Data Flash Constants (continued)

Class	SubClass	Name	Data Type	Min	Max	Default	Unit
Calibration	Internal Temp Model	Int Coeff 3	I2	-32768	32767	-11136	—
Calibration	Internal Temp Model	Int Coeff 4	I2	-32768	32767	5754	—
Calibration	External Temp Model	Ext Coeff a1	I2	-32768	32767	-14520	—
Calibration	External Temp Model	Ext Coeff a2	I2	-32768	32767	23696	—
Calibration	External Temp Model	Ext Coeff a3	I2	-32768	32767	-20298	—
Calibration	External Temp Model	Ext Coeff a4	I2	-32768	32767	28073	—
Calibration	External Temp Model	Ext Coeff a5	I2	-32768	32767	865	—
Calibration	External Temp Model	Ext Coeff b1	I2	-32768	32767	-694	—
Calibration	External Temp Model	Ext Coeff b2	I2	-32768	32767	1326	—
Calibration	External Temp Model	Ext Coeff b3	I2	-32768	32767	-3880	—
Calibration	External Temp Model	Ext Coeff b4	I2	-32768	32767	5127	—

The ManufacturerData() output format is: ZZYYaaAAAbbBBccCCddDDeeEEffFFggGGhhHHiiiJJkkKKllL, where:

VALUE	FORMAT	DESCRIPTION
ZZ	Byte	8-bit counter, increments when raw ADC values are refreshed, typically every 250 ms
YY	Byte	Output status: 0x01 when ManufacturerAccess() = 0xF081 0x02 when ManufacturerAccess() = 0xF082
AAaa	2's Complement	Coulomb Counter
BBbb	2's Complement	Cell Voltage 1
CCcc	2's Complement	Cell Voltage 2
DDdd	2's Complement	Cell Voltage 3
EEee	2's Complement	Cell Voltage 4
FFff	2's Complement	Internal Temperature
GGgg	2's Complement	External Temperature 1 (TS1)
HHhh	2's Complement	External Temperature 2 (TS2)
Iiii	2's Complement	Reserved
JJjj	2's Complement	Reserved
KKkk	2's Complement	PACK Voltage
LLll	2's Complement	BAT Voltage

1.8.1 Cell Voltage Calibration

1. Apply known voltages in mV to the cell voltage inputs:

- V_{CELL1} between VC4 pin and VSS pin
- V_{CELL2} between VC3 pin and VC4 pin
- V_{CELL3} between VC2 pin and VC3 pin

- V_{CELL4} between VC1 pin and VC2 pin
2. Send 0xF081 or 0xF082 to ManufacturerAccess() to enable raw cell voltage output on ManufacturerData().
 3. Poll ManufacturerData() until ZZ increments by 2 before reading data.
 4. Grab ADC conversion readings of cell voltages from ManufacturerData():
 - ADC_{CELL1} = AAaa of ManufacturerData(): Is $ADC_{CELL1} < 0x8000$? If yes, use ADC_{CELL1} ; otherwise, $ADC_{CELL1} = AAaa - 0xFFFF + 0x0001$.
 - ADC_{CELL2} = BBbb of ManufacturerData(): Is $ADC_{CELL2} < 0x8000$? If yes, use ADC_{CELL2} ; otherwise, $ADC_{CELL2} = BBbb - 0xFFFF + 0x0001$.
 - ADC_{CELL3} = CCcc of ManufacturerData(): Is $ADC_{CELL3} < 0x8000$? If yes, use ADC_{CELL3} ; otherwise, $ADC_{CELL3} = CCcc - 0xFFFF + 0x0001$.
 - ADC_{CELL4} = DDdd of ManufacturerData(): Is $ADC_{CELL4} < 0x8000$? If yes, use ADC_{CELL4} ; otherwise, $ADC_{CELL4} = DDdd - 0xFFFF + 0x0001$.
 5. Average several readings for higher accuracy. Poll ManufacturerData() until ZZ increments, which indicates updated values.
 6. Calculate gain values:

$$Alt\ Cell\ Scale1 = \frac{V_{CELL1}}{ADC_{CELL1}} * 2^{16}$$

$$Alt\ Cell\ Scale2 = \frac{V_{CELL1} + V_{CELL2}}{ADC_{CELL1} + ADC_{CELL2}} * 2^{16}$$

$$Alt\ Cell\ Scale3 = \frac{V_{CELL1} + V_{CELL2} + V_{CELL3}}{ADC_{CELL1} + ADC_{CELL2} + ADC_{CELL3}} * 2^{16}$$

$$Alt\ Cell\ Scale4 = \frac{V_{CELL1} + V_{CELL2} + V_{CELL3} + V_{CELL4}}{ADC_{CELL1} + ADC_{CELL2} + ADC_{CELL3} + ADC_{CELL4}} * 2^{16}$$

7. Update Data Flash with Cell Scale 1, Cell Scale 2, Cell Scale 3, Cell Scale 4.
8. Re-check the voltage reading. Repeat the steps if the reading is not accurate.

1.8.2 BAT Voltage Calibration

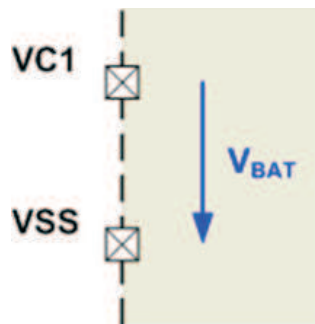

1. Apply known voltages in mV to the voltage input:
 - V_{BAT} between VC4 pin and VSS pin
2. Enter calibration mode if ManufacturerStatus()[CAL] = 0; send 0x002d to ManufacturerAccess().
3. Send 0xF081 or 0xF082 to ManufacturerAccess() to enable raw cell voltage output on ManufacturerData().
4. Poll ManufacturerData() until ZZ increments by 2 before reading data.
5. Grab ADC conversion readings of the cell stack voltage from ManufacturerData():
 - ADC_{BAT} = LLll of ManufacturerData(): Is $ADC_{BAT} < 0x8000$? If yes, use ADC_{BAT} ; otherwise, ADC_{BAT}

$$= - (0xFFFF - LLII + 0x0001).$$

- Average several readings for higher accuracy. Poll ManufacturerData() until ZZ increments, which indicates updated values.

- $ADC_{BAT} = [ADC_{BAT}(\text{reading } n) + \dots + ADC_{BAT}(\text{reading } 1)]/n$

- Calculate gain value, using the following formula:

$$BAT \text{ Gain} = \frac{V_{BAT}}{ADC_{BAT}} * 2^{16}$$

- Update the Data Flash with BAT Gain.
- Re-check the voltage reading. Repeat the steps if the readings are not accurate.
- Exit calibration mode by sending 0x002d to ManufacturerAccess() or continue with calibration.

1.8.3 PACK Voltage Calibration

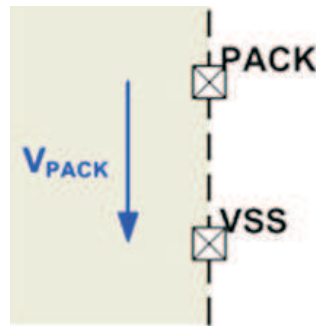

- Apply known voltages in mV to the voltage input:
 - V_{BAT} between PACK pin and VSS pin
- Enter calibration mode if ManufacturerStatus()[CAL] = 0; send 0x002d to ManufacturerAccess().
- Send 0x0081 or 0x0082 to ManufacturerAccess() to enable raw cell voltage output on ManufacturerData().
- Poll ManufacturerData() until ZZ increments by 2 before reading data.
- Grab ADC conversion readings of pack voltage from ManufacturerData():
 - $ADC_{PACK} = KKkk$ of ManufacturerData(): Is $ADC_{PACK} < 0x8000$? If yes, use ADC_{PACK} ; otherwise, $ADC_{PACK} = - (0xFFFF - KKkk + 0x0001)$.
- Average several readings for higher accuracy. Poll ManufacturerData() until ZZ increments, which indicates updated values.
 - $ADC_{PACK} = [ADC_{PACK}(\text{reading } n) + \dots + ADC_{PACK}(\text{reading } 1)]/n$
- Calculate gain value:

$$PACK \text{ Gain} = \frac{V_{PACK}}{ADC_{PACK}} * 2^{16}$$

- Update Data Flash with PACK Gain.
- Re-check the voltage reading. Repeat the steps if the readings are not accurate.
- Exit calibration mode by sending 0x002d to ManufacturerAccess() or continue with calibration.

1.8.4 Current Calibration

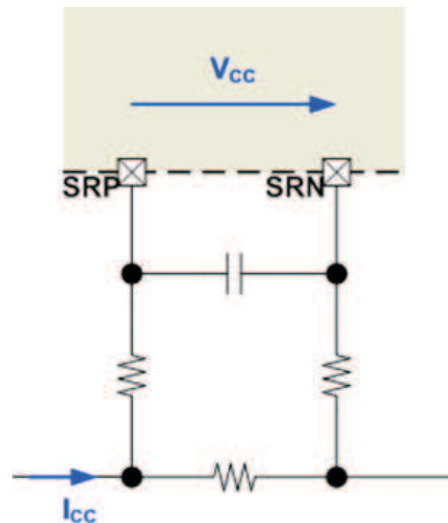

1.8.4.1 Offset Calibration

1. Apply a known current of 0 mA:
 - Make sure no current is flowing through the sense resistor connected between the SRP and SRN pins.
2. Send 0xF082 to ManufacturerAccess() to enable raw CC output on ManufacturerData() with CC shunt.
3. Read *Coulomb Counter Offset Samples* from Data Flash.
4. Poll ManufacturerData() until ZZ increments by 2 before reading data.
5. Grab ADC conversion readings of current from ManufacturerData():
 - $ADC_{CC} = AAaa$ of ManufacturerData(): Is $ADC_{CC} < 0x8000$? If yes, use ADC_{CC} ; otherwise, $ADC_{CC} = AAaa - 0xFFFF + 0x0001$.
6. Average several readings for higher accuracy. Poll ManufacturerData() until ZZ increments, which indicates updated values.
 - $ADC_{CC} = [ADC_{CC}(\text{reading } n) + \dots + ADC_{CC}(\text{reading } 1)]/n$
7. Calculate offset value:
 $CC\ offset = ADC_{CC} * (\text{Coulomb Counter Offset Samples})$
8. Update Data Flash with *CC Offset*.
9. Re-check the current reading. Repeat the steps if the reading is not accurate.

1.8.4.2 Board Offset Calibration

1. Apply a known current of 0 mA:
 - Make sure no current is flowing through the sense resistor connected between SRP pin and SRN pin.
2. Send 0xF081 to ManufacturerAccess() to enable raw CC output on ManufacturerData().
3. Read *Coulomb Counter Offset Samples* from Data Flash.
4. Poll ManufacturerData() until ZZ increments by 2 before reading data.
5. Grab ADC conversion readings of current from ManufacturerData():
 - $ADC_{CC} = AAaa$ of ManufacturerData(): Is $ADC_{CC} < 0x8000$? If yes, use ADC_{CC} ; otherwise, $ADC_{CC} = AAaa - 0xFFFF + 0x0001$.
6. Average several readings for higher accuracy. Poll ManufacturerData() until ZZ increments, which indicates updated values.
 - $ADC_{CC} = [ADC_{CC}(\text{reading } n) + \dots + ADC_{CC}(\text{reading } 1)]/n$

7. Calculate offset value:

$$\text{Board offset} = (\text{ADC}_{\text{CC}} - \text{CC Offset} / (\text{Coulomb Counter Offset Samples})) * (\text{Coulomb Counter Offset Samples})$$
8. Update Data Flash with *Board Offset*.
9. Re-check the current reading. Repeat the steps if the reading is not accurate.

1.8.4.3 Gain Calibration

1. Apply a known current in mA to the current input.
 - Make sure current I_{CC} is flowing through the sense resistor connected between SRP pin and SRN pin.
2. Send 0xF081 to ManufacturerAccess() to enable raw CC output on ManufacturerData().
3. Read *Coulomb Counter Offset Samples* from Data Flash.
4. Poll ManufacturerData() until ZZ increments by 2 before reading data.
5. Grab ADC conversion readings of current from ManufacturerData():
 - $\text{ADC}_{\text{CC}} = \text{AAaa}$ of ManufacturerData(): Is $\text{ADC}_{\text{CC}} < 0x8000$? If yes, use ADC_{CC} ; otherwise, $\text{ADC}_{\text{CC}} = \text{AAaa} - 0xFFFF + 0x0001$.
6. Average several readings for higher accuracy. Poll ManufacturerData() until ZZ increments, which indicates updated values.
 - $\text{ADC}_{\text{CC}} = [\text{ADC}_{\text{CC}}(\text{reading } n) + \dots + \text{ADC}_{\text{CC}}(\text{reading } 1)]/n$
7. Calculate gain values:

$$\text{CC Gain} = \frac{I_{\text{CC}}}{(\text{Board Offset}) + (\text{CC Offset})}$$

$$\text{ADC}_{\text{CC}} - \frac{\text{ADC}_{\text{CC}}}{(\text{Coulomb Counter Offset Samples})}$$

$$\text{Capacity Gain} = \text{CC Gain} * 298261.6178$$

8. Update Data Flash with CC Gain, *Capacity Gain*.
9. Re-check the current reading. Repeat the steps if the reading is not accurate.

1.8.5 Temperature Calibration

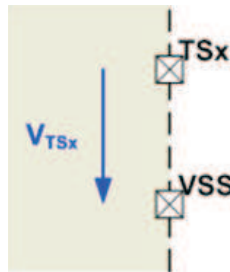

1.8.5.1 Internal Temperature Sensor Calibration (OPTION 1)

1. Apply a known temperature in 0.1°C.
 - Make sure temperature $\text{Temp}_{\text{TINT}}$ is applied to the device.
2. Enable TINT as the SBS temperature source by setting the Misc Configuration bit 7 to 1.
3. Grab the reported temperature from the SBS temperature.
4. Calculate temperature offset:

$$\text{TINT offset} = \text{TEMP}_{\text{TINT}} - \text{TINT}$$
5. Update Data Flash with the calculated value.
6. Re-check the current reading. Repeat the steps if the reading is not accurate.

1.8.5.2 Internal Temperature Sensor Calibration (OPTION 2)

1. Apply a known temperature in 0.1°C.
 - Make sure temperature $Temp_{TINT}$ is applied to the device.
2. Read *Int Coeff 1*, *Int Coeff 2*, *Int Coeff 3*, *Int Coeff 4* from Data Flash.
3. Send 0xF081 or 0xF082 to `ManufacturerAccess()` to enable raw cell voltage output on `ManufacturerData()`.
4. Poll `ManufacturerData()` until ZZ increments by 2 before reading data.
5. Grab ADC conversion readings of temperature from `Temperature()`:
 - $ADC_{TINT} = \text{FFFF of ManufacturerData()}: \text{Is } ADC_{TINT} < 0x8000?$ If yes, use ADC_{TINT} ; otherwise, $ADC_{TINT} = \text{FFFF} - 0xFFFF + 0x0001$.
6. Average several readings for higher accuracy. Poll `ManufacturerData()` until ZZ increments, which indicates updated values.
 - $ADC_{TINT} = [ADC_{TINT}(\text{reading } n) + \dots + ADC_{TINT}(\text{reading } 1)]/n$
7. Calculate temperature offset:

$$A = ADC_{TINT} / 2^{16}$$

$$T_{TINT} = ((INT\ Coeff\ 1) * A^3 + (INT\ Coeff\ 2) * A^2 + (INT\ Coeff\ 3) * A + (INT\ Coeff\ 4)) * 0.1 - 273.15$$

$$Internal\ Temperature\ Offset = TEMP_{TINT} - T_{TINT}$$
8. Update Data Flash with Internal Temperature Offset.
9. Re-check the temperature reading. Repeat the steps if the reading is not accurate.

1.8.5.3 TS1 Calibration (OPTION 1)

1. Apply a known temperature in 0.1°C.
 - Make sure temperature $Temp_{TS1}$ is applied to the thermistor connected to the TS1 pin.
2. Enable TS1 as the SBS temperature source by setting the Misc Configuration bit 7 to 0.
3. Grab the reported temperature from the SBS temperature.
4. Calculate temperature offset:

$$TS1\ offset = TEMP_{TS1} - TS1$$
5. Update Data Flash with calculated value.
6. Re-check the current reading. Repeat the steps if the reading is not accurate.

1.8.5.4 TS1 Calibration (OPTION 2)

1. Apply a known temperature in 0.1°C.
 - Make sure temperature $Temp_{TS1}$ is applied to the thermistor connected to the TS1 pin.
2. Read Coeff a1, Coeff a2, Coeff a3, Coeff a4, Coeff b1, Coeff b2, Coeff b3, Coeff b4 from Data Flash.
3. Send 0xF081 or 0xF082 to `ManufacturerAccess()` to enable raw cell voltage output on `ManufacturerData()`.
4. Poll `ManufacturerData()` until ZZ increments by 2 before reading data.
5. Grab the ADC conversion readings of temperature from `ManufacturerData()`:
 - $ADC_{TS1} = \text{GGgg of ManufacturerData()}: \text{Is } ADC_{TS1} < 0x8000?$ If yes, use ADC_{TS1} ; otherwise, $ADC_{TS1} = \text{GGgg} - 0xFFFF + 0x0001$.
6. Average several readings for higher accuracy. Poll `ManufacturerData()` until ZZ increments, which indicates updated values.
 - $ADC_{TS1} = [ADC_{TS1}(\text{reading } n) + \dots + ADC_{TS1}(\text{reading } 1)]/n$
7. Calculate temperature offset:

$$A = \frac{ADC_{TS1}}{2^{15}}$$

$$B = \frac{A}{(\text{Coeff } A1) * A^4 + (\text{Coeff } A2) * A^3 + (\text{Coeff } A3) * A^2 + (\text{Coeff } A4) * A + (\text{Coeff } A5)} * 2^{14}$$

$$T_{TS1} = ((\text{Coeff } B1) * B^3 + (\text{Coeff } B2) * B^2 + (\text{Coeff } B3) * B^1 + (\text{Coeff } B4)) * 0.1 - 273.15$$

$$\text{External1 Temperature Offset} = TEMP_{TS1} - T_{TS1}$$

8. Update Data Flash with calculated with *External 1 Temperature Offset*.
9. Re-check the temperature reading. Repeat the steps if the reading is not accurate.

1.8.5.5 TS2 Calibration (OPTION 1)

1. Apply a known temperature in 0.1°C.
 - Make sure temperature $Temp_{TS2}$ is applied to the thermistor connected to the TS2 pin.
2. Enable TS2 by setting the Secondary Thermistor to 1.
3. Grab the reported temperature from the extended command 0x7D.
4. Calculate temperature offset:
 $TS2 \text{ offset} = TEMP_{TS2} - TS2$
5. Update Data Flash with the calculated value.
6. Re-check the current reading. Repeat the steps if the reading is not accurate.

1.8.5.6 TS2 Calibration (OPTION 2)

1. Apply a known temperature in 0.1°C.
 - Make sure temperature $Temp_{TS2}$ is applied to the thermistor connected to the TS2 pin.
2. Read *Coeff a1*, *Coeff a2*, *Coeff a3*, *Coeff a4*, *Coeff b1*, *Coeff b2*, *Coeff b3*, and *Coeff b4* from Data Flash.
3. Send 0xF081 or 0xF082 to `ManufacturerAccess()` to enable raw cell voltage output on `ManufacturerData()`.
4. Poll `ManufacturerData()` until ZZ increments by 2 before reading data.
5. Grab ADC conversion readings of temperature from `ManufacturerData()`:
 - $ADC_{TS2} = \text{HHhh}$ of `ManufacturerData()`: Is $ADC_{TS2} < 0x8000$? If yes, use ADC_{TS2} ; otherwise, $ADC_{TS2} = \text{HHhh} - 0xFFFF + 0x0001$.
6. Average several readings for higher accuracy. Poll `ManufacturerData()` until ZZ increments, which indicates updated values.
 - $ADC_{TS2} = [ADC_{TS2}(\text{reading } n) + \dots + ADC_{TS2}(\text{reading } 1)]/n$
7. Calculate temperature offset:

$$A = \frac{ADC_{TS2}}{2^{15}}$$

$$B = \frac{A}{(\text{Coeff}A1) * A^4 + (\text{Coeff}A2) * A^3 + (\text{Coeff}A3) * A^2 + (\text{Coeff}A4) * A + (\text{Coeff}A5)} * 2^{14}$$

$$T_{TS2} = ((\text{Coeff}B1) * B^3 + (\text{Coeff}B2) * B^2 + (\text{Coeff}B3) * B^1 + (\text{Coeff}B4)) * 0.1 - 273.15$$

$$\text{External2 Temperature Offset} = TEMP_{TS2} - T_{TS2}$$

8. Update the Data Flash with the calculated External 2 Temperature Offset.
9. Re-check the temperature reading. Repeat the steps if the reading is not accurate.

1.9 Communications

The bq3055 uses SMBus v1.1 with Master Mode and packet error checking (PEC) options per the SBS specification.

1.9.1 SMBus On and Off State

The bq3055 detects an SMBus off state when SMBC and SMBD are logic-low for ≥ 2 seconds. Clearing this state requires either SMBC or SMBD to transition high. Within 1 ms, the communication bus is available.

1.9.2 Packet Error Checking

The bq3055 can receive or transmit data with or without PEC.

In the write-word protocol, if the host does not support PEC, the last byte of data is followed by a stop condition. If the host does not support PEC, the **[HPE]** bit should be set to 0 (default).

In the write-word protocol, the bq3055 receives the PEC after the last byte of data from the host. If the host does not support PEC, the last byte of data is followed by a stop condition. After receipt of the PEC, the bq3055 compares the value to its calculation. If the PEC is correct, the bq3055 responds with an ACKNOWLEDGE. If it is not correct, the bq3055 responds with a NOT ACKNOWLEDGE and sets an error code. If the host supports PEC, the **[HPE]** bit should be set to 1.

In the read-word and block-read in master mode, the host generates an ACKNOWLEDGE after the last byte of data sent by the bq3055. The bq3055 then sends the PEC, and the host, acting as a master-receiver, generates a NOT ACKNOWLEDGE and a stop condition.

Related Variables:

- DF:Configuration:Registers:Operation Cfg B[HPE]

1.9.3 bq3055 Slave Address

The bq3055 uses the address 0x16 on SMB for communication.

1.9.4 Broadcasts to Smart Charger and Smart Battery Host

The bq3055 can broadcast messages to the smart battery charger and smart battery host. This can be enabled with the **[BCAST]** bit.

PEC byte for alarm transmissions in master-mode to charger can be enabled with the **[CPE]** bit.

PEC byte for alarm transmissions in master-mode to smart battery host and the PEC byte for receiving communications from all sources in slave-mode can be enabled with the **[HPE]** bit.

Related Variables:

- DF:Configuration:Registers:Operation Cfg B[CPE],[HPE],[BCAST]

Standard SBS Commands

The bq3055 SBS command set meets the SBD v1.1 specification. All SBS Values are updated in 1-second intervals.

A.1 ManufacturerAccess(0x00)

This read- or write-word function provides battery-system level data, access to test controls, and security features.

Table A-1. ManufacturerAccess

SBS Cmd.	Mode	Name	Format	Size in Bytes	Min Value	Max Value	Default Value	Unit
0x00	R/W	ManufacturerAccess	hex	2	0x0000	0xffff	—	

A.1.1 System Data

The results of these commands need to be read from *ManufacturerAccess* after a write with the command word to *ManufacturerAccess*.

A.1.1.1 Device Type(0x0001)

Returns the IC part number.

Table A-2. Device Type

Manufacturer Access	Mode	Name	Format	Size in Bytes	Min Value	Max Value	Default Value	Unit
0x0001	R	Device Type	hex	2	—	—	0x0900	

A.1.1.2 Firmware Version(0x0002)

Returns the firmware version. The format is most-significant byte (MSB) = Decimal integer, and the least-significant byte (LSB) = sub-decimal integer, e.g.: 0x0120 = version 01.20.

Table A-3. Firmware Version

Manufacturer Access	Mode	Name	Format	Size in Bytes	Min Value	Max Value	Default Value	Unit
0x0002	R	Firmware Version	hex	2	—	—	0x0102	

A.1.1.3 Hardware Version(0x0003)

Returns the hardware version stored in a single byte of reserved data flash. e.g.: 0x00a7 = Version A7.

Table A-4. Hardware Version

Manufacturer Access	Mode	Name	Format	Size in Bytes	Min Value	Max Value	Default Value	Unit
0x0003	R	Hardware Version	hex	2	—	—	0x00a7	

A.1.1.4 DF Checksum(0x0004)

This function is only available when the bq3055 is in unsealed mode or full access mode, indicated by the *[SS]* and *[FAS]* flag. A write to this command forces the bq3055 to generate a checksum of the full Data Flash (DF) array. The generated checksum is then returned within 45 ms.

NOTE: If another SMBus command is received while the checksum is generated, the DF Checksum is generated but the response may be time out (<25 ms).

Table A-5. DF Checksum

Manufacturer Access	Mode	Name	Format	Size in Bytes	Min Value	Max Value	Default Value	Unit
0x0004	R	DF Checksum	hex	2	—	—	—	

A.1.1.5 Pending EDV Threshold Voltage(0x0005)

The read-word function returns the predicted EDV2 until EDV2 is reached, then the predicted EDV1 until EDV1 is reached, and then the predicted EDV0. Format is big endian.

Table A-6. Pending EDV Threshold Voltage

Manufacturer Access	Mode	Name	Format	Size in Bytes	Min Value	Max Value	Default Value	Unit
0x0005	R	Pending EDV Threshold Voltage	hex	2	—	—	—	mV

A.1.1.6 Manufacturer Status (0x0006)

This function is available while the bq3055 is in normal operation. This 16-bit word reports the battery status.

	Bit 7	Bit 6	Bit 5	Bit 4	Bit 3	Bit 2	Bit 1	Bit 0
High Byte	FET1	FET0	PF1	PF0	STATE3	STATE2	STATE1	STATE0
Low Byte	0	0	0	0	1	0	1	0

LEGEND: All bits are read-only.

Figure A-1. Manufacturer Status

FET1, FET0 — Indicates the state of the charge and discharge FETs

- 0,0 = Both charge and discharge FETs are on.
- 0,1 = CHG FET is off, DSG FET is on.
- 1,0 = Both charge and discharge FETs are off.
- 1,1 = CHG FET is on, DSG FET is off.

PF1, PF0 — Indicates permanent failure cause when permanent failure is indicated by STATE3..STATE0

- 0,0 = Fuse is blown if enabled via DF:Configuration:Register(64):Permanent Fail Cfg
- 0,1 = Cell imbalance failure
- 1,0 = Safety voltage failure
- 1,1 = FET failure

STATE3, STATE2, STATE1, STATE0 — Indicates the battery state.

0,0,0,0 = Wake Up
 0,0,0,1 = Normal Discharge
 0,0,1,1 = Pre-Charge
 0,1,0,1 = Charge
 0,1,1,1 = Charge Termination
 1,0,0,0 = Fault Charge Terminate
 1,0,0,1 = Permanent Failure
 1,0,1,0 = Overcurrent
 1,0,1,1 = Overtemperature
 1,1,0,0 = Battery Failure
 1,1,0,1 = Sleep
 1,1,1,0 = Discharge Prohibited
 1,1,1,1 = Battery Removed

A.1.1.7 Chemistry ID(0x0008)

Returns the OCV table chemistry ID of the battery. The default table ID is 0x0100. For a list of OCV chemistry IDs, refer to the application note, *Support of Multiple Li-Ion Chemistries w/Impedance Track(TM) Gas Gauges* ([SLUA372](#)).

Table A-7. Chemistry ID

Manufacturer Access	Mode	Name	Format	Size in Bytes	Min Value	Max Value	Default Value	Unit
0x0008	R	Chemistry ID	hex	2	0x0000	0xffff	0x0100	

A.1.2 System Control

The commands in this section cause the bq3055 to take actions when written. No data is returned.

A.1.2.1 Shutdown(0x0010)

Instructs the bq3055 to verify and enter shutdown mode. This command is only available when the bq3055 is in Unsealed or Full Access mode. Shutdown will not be entered unless the *PackVoltage* < **Charger Present** and *Current* ≤ 0.

Related Variables:

- DF:Power:Power:AFE Shutdown Voltage
- SBS:Current
- SBS:OperationStatus[SS],[FAS]
- SBS:PackVoltage

A.1.2.2 Sleep(0x0011)

Instructs the bq3055 to verify and enter sleep mode if no other command is sent after the *Sleep* command. Any SMB transition will wake up the bq3055. It takes about 1 min. before the device will go to sleep. This command is only available when the bq3055 is in Unsealed or Full Access mode.

Related Variables:

- DF:Configuration:Registers:Operation Cfg A[SLEEP]
- SBS:OperationStatus[SS],[FAS]

A.1.2.3 Seal Device(0x0020)

Instructs the bq3055 to limit access to the extended SBS functions and data flash space, sets the [SS] flag, and clears the [FAS] flag.

This command is only available when the bq3055 is in Unsealed or Full Access mode.

See [Section 1.7](#) in this document for detailed information.

Related Variables:

- SBS:OperationStatus[SS],[FAS]

A.1.2.4 LTPF Enable(0x0021)

This command clears any existing PF flags, enables Lifetime Data and PF and sets the [LTPF] flag in *Operation Status* and the [PROD_LTPF_EN] bit in **Operation Cfg C**. See the description in *Operation Cfg C*.

This command is only available when the bq3055 is in Unsealed or Full Access mode.

Related Variables:

- SBS:OperationStatus[LTPF],[SS],[FAS]

A.1.2.5 Calibration Mode(0x002d)

This command sets or clears permissions to allow the bq3055 to enter calibration mode.

Related Variables:

- SBS:ManufacturerData
- SBS:ManufacturerStatus[CAL STATUS]
- SBS:OperationStatus[GAUGE STATUS]

A.1.2.6 FUSE Activation(0x0030)

This command drives the FUSE pin high.

This command is only available when the bq3055 is in Unsealed or Full Access mode.

Related Variables:

- SBS:OperationStatus[SS],[FAS]

A.1.2.7 FUSE Clear(0x0031)

This command sets the FUSE pin back to low.

This command is only available when the bq3055 is in Unsealed or Full Access mode.

Related Variables:

- SBS:OperationStatus[SS],[FAS]

A.1.2.8 Reset(0x0041)

The bq3055 undergoes a full reset. The bq3055 holds the clock line down for a few milliseconds to complete the reset.

This command is only available when the bq3055 is in Unsealed or Full Access mode.

Related Variables:

- SBS:OperationStatus[SS],[FAS]

A.1.2.9 DFRowAddress(0x01yy)

This command sets the current data flash row address (based on yy) prior to block reading or writing.

Related Variables:

- SBS:ManufacturerInput

A.1.2.10 BootRom(0x0f00)

The bq3055 goes into BootRom mode.

This command is only available when the bq3055 is in Full Access mode.

Related Variables:

- SBS:OperationStatus[FAS]

A.1.2.11 Exit Calibration(0xf080)

This command instructs the bq3055 to exit calibration mode.

Related Variables:

- SBS:ManufacturerData
- SBS:ManufacturerStatus[CAL STATUS]
- SBS:OperationStatus[GAUGE STATUS]

A.1.2.12 Output Calibration Data(0xf081)

This command instructs the bq3055 to output 26 bytes of raw ADC and Coulomb Counter data on ManufacturerData(0x23) while in calibration mode.

Related Variables:

- SBS:ManufacturerData
- SBS:ManufacturerStatus[CAL STATUS]
- SBS:OperationStatus[GAUGE STATUS]

A.1.2.13 Output Calibration Data(0xf082)

This command instructs the bq3055 to output 26 bytes of raw ADC and Coulomb Counter data on ManufacturerData(0x23) while in calibration mode. This mode also includes an internal short of the Coulomb Counter inputs.

Related Variables:

- SBS:ManufacturerData
- SBS:ManufacturerStatus[CAL STATUS]
- SBS:OperationStatus[GAUGE STATUS]

A.1.2.14 Permanent Fail Clear(PFKey)

This two-step command needs to be written to *ManufacturerAccess* in following order: 1st word of the *PFKey* first followed by the 2nd word of the *PFKey*. If the command fails 4 seconds must pass before the command can be reissued.

It instructs the bq3055 to clear the *PFStatus*, clear the *[PF]* flag, clear the **Fuse Flag**, reset the FUSE pin, and unlock the data flash for writes.

This command is only available when the bq3055 is in Unsealed or Full Access mode.

Related Variables:

- DF:PF Status:Device Status Data:PF Flags 1
- DF:PF Status:Device Status Data:Fuse Flag
- SBS:SafetyStatus[PF]
- SBS:PFStatus
- SBS:OperationStatus[SS],[FAS]

- SBS:PFKey

NOTE: Higher word must be immediately followed by lower word. If clear command fails, command can only be repeated 4 seconds after previous attempt. If communication other than the lower word occurs after the first word is sent, the *Permanent Fail Clear* command fails.

A.1.2.15 Unseal Device (*UnsealKey*)

Instructs the bq3055 to enable access to the SBS functions and data flash space and clear the [SS] flag. This two-step command needs to be written to *ManufacturerAccess* in the following order: 1st word of the *UnSealKey* first followed by the 2nd word of the *UnSealKey*. If the command fails 4 seconds must pass before the command can be reissued.

This command is only available when the bq3055 is in Sealed mode.

See [Section 1.7](#) in this document for detailed information.

Related Variables:

- SBS:OperationStatus[SS]
- SBS:UnSealKey

A.1.2.16 Full Access Device (*FullAccessKey*)

Instructs the bq3055 to enable full access to all SBS functions and data flash space and set the [FAS] flag. This two-step command needs to be written to *ManufacturerAccess* in the following order: 1st word of the *FullAccessKey* first followed by the 2nd word of the *FullAccessKey*.

This command is only available when the bq3055 is in Unsealed mode.

See [Section 1.7](#) in this document for detailed information.

Related Variables:

- SBS:OperationStatus[SS],[FAS]
- SBS:FullAccessKey

A.1.3 Extended SBS Commands

Also available via *ManufacturerAccess* in sealed mode are some of the extended SBS commands. The commands available are listed below.

The result of these commands need to be read from *ManufacturerAccess* after a write to *ManufacturerAccess*.

- 0x0050 = SBS:SafetyAlert(0x50)
- 0x0051 = SBS:SafetyStatus(0x51)
- 0x0052 = SBS:PFAlert(0x52)
- 0x0053 = SBS:PFStatus(0x53)
- 0x0054 = SBS:OperationStatus(0x54)
- 0x0055 = SBS:ChargingStatus(0x55)
- 0x0057 = SBS:ResetData(0x57)
- 0x0058 = SBS:WDRResetData(0x58)
- 0x005a = SBS:PackVoltage(0x5a)
- 0x005d = SBS:AverageVoltage(0x5d)
- 0x0072 = SBS:TempRange(0x72)

A.2 RemainingCapacityAlarm(0x01)

This read- or write-word function sets or gets a low-capacity alarm threshold unsigned integer value with a range of 0 to 65535 and units of either mAh (*CapM* = 0) or 10 mWh (*CapM* = 1). The default value for *RemainingCapacityAlarm* is stored in **Rem Cap Alarm**. If *RemainingCapacityAlarm* is set to 0, the alarm is disabled.

If $RemainingCapacity < RemainingCapacityAlarm$, the *[RCA]* flag is set and the bq3055 sends an *AlarmWarning* message to the SMBUS host.

If $RemainingCapacity \geq RemainingCapacityAlarm$ and *[DSG]* is set, the *[RCA]* flag is cleared.

- 0 = Remaining capacity alarm is disabled
- 1..700 = Remaining capacity limit for *[RCA]* flag

Table A-8. RemainingCapacityAlarm

SBS Cmd.	Mode	Name	Format	Size in Bytes	Min Value	Max Value	Default Value	Unit
0x01	R/W	RemainingCapacityAlarm	unsigned integer	2	0	700	300	mAh or 10 mWh

Related Variables:

- DF:SBS Configuration:Data:Rem Cap Alarm
- SBS:BatteryMode[CapM]
- SBS:RemainingCapacity
- SBS:BatteryStatus[RCA],[DSG]

A.3 RemainingTimeAlarm(0x02)

This read- or write-word function sets or gets the *RemainingTimeAlarm* unsigned integer value in minutes with a range of 0 to 65535. The default value of *RemainingTimeAlarm* is stored in **Rem Time Alarm**. If *RemainingTimeAlarm* = 0, this alarm is disabled.

If $AverageTimeToEmpty < RemainingTimeAlarm$, the *[RTA]* flag is set and the bq3055 sends an *AlarmWarning* message to the SMBus host.

If $AverageTimeToEmpty \geq RemainingTimeAlarm$, the *[RTA]* flag is reset

- 0 = Remaining time alarm is disabled
- 1..30 = Remaining time limit for *[RTA]* flag

Table A-9. RemainingTimeAlarm

SBS Cmd.	Mode	Name	Format	Size in Bytes	Min Value	Max Value	Default Value	Unit
0x02	R/W	RemainingTimeAlarm	unsigned integer	2	0	30	10	min

Related Variables:

- DF:SBS Configuration:Data:Rem Time Alarm
- SBS:AverageTimeToEmpty
- SBS:BatteryStatus[RTA]

A.4 BatteryMode(0x03)

This read- or write-word function selects the various battery operational modes and reports the battery's capabilities and modes and flags minor conditions requiring attention.

	bit 7	bit 6	bit 5	bit 4	bit 3	bit 2	bit 1	bit 0
High Byte	CapM	ChgM	AM	RSVD	RSVD	RSVD	PB	CC
Low Byte	CF	RSVD	RSVD	RSVD	RSVD	RSVD	PBS	ICC

LEGEND: High Byte is Read/Write, Low Byte is Read Only; RSVD = Reserved and **must** be programmed to 0

Figure A-2. BatteryMode

CapM — Sets the units used for capacity information and internal calculation.

0 = Reports in mA or mAh (default)

1 = Reports in 10 mW or 10 mWh

Following functions are instantaneously updated after [*CapM*] change:

SBS:RemainingCapacityAlarm(0x01)

SBS:AtRate(0x04)

SBS:RemainingCapacity(0x0f)

SBS:FullChargeCapacity(0x10)

SBS:DesignCapacity(0x18)

Following functions are recalculated within 1 second after [*CapM*] change:

SBS:RemainingTimeAlarm(0x02)

SBS:AtRateTimeToEmpty(0x06)

SBS:AtRateOK(0x07)

SBS:RunTimeToEmpty(0x11)

SBS:AverageTimeToEmpty(0x12)

SBS:BatteryStatus(0x16)

ChgM: — Enables or disables the bq3055 's transmission of *ChargingCurrent* and *ChargingVoltage* messages to the Smart Battery Charger.

0 = Enable *ChargingVoltage* and *ChargingCurrent* broadcasts to the Smart Battery Charger by setting the [**BCAST**] bit in **Operation Cfg B** when charging is desired.

1 = Disable *ChargingVoltage* and *ChargingCurrent* broadcasts to the Smart Battery Charger. (default)

Related Variables:

DF:Configuration:Registers:Operation Cfg B[BCAST]

SBS:ChargingCurrent

SBS:ChargingVoltage

AM: — Enables or disables *AlarmWarning* broadcasts to the host and Smart Battery Charger

- 0 = Enable *AlarmWarning* broadcast to host and Smart Battery Charger by setting the **[BCAST]** bit in **Operation Cfg B** (default). The bq3055 sends the *AlarmWarning* messages to the SMBus Host and the Smart Battery Charger any time an alarm condition is detected
- 1 = Disable *AlarmWarning* broadcast to host and Smart Battery Charger. The bq3055 does not master the SMBus, and *AlarmWarning* messages are not sent to the SMBus Host and the Smart Battery Charger for a period of no more than 65 seconds and no less than 45 seconds. *[AM]* is automatically cleared by the bq3055 60 seconds after being set to 1, independent of the **[BCAST]** bit.

Related Variables:

DF:Configuration:Registers:Operation Cfg B[BCAST]

NOTE: The system, as a minimum, is required to poll the Smart Battery Charger every 10 seconds if the *[AM]* flag is set.

PB: — Sets the role of the battery pack. This flag is not used by bq3055 and should be set to 0.

CC: — Enable or disable internal charge controller. This flag is not used by bq3055 and should be set to 0.

CF: — This flag is set if *MaxError* > **CF MaxError Limit**

- 0 = Battery OK
- 1 = Condition cycle requested

Related Variables:

DF:SBS Configuration:Data:CF MaxError Limit

SBS:MaxError

PBS: — Primary battery support is not supported by bq3055 and is fixed to 0.

ICC: — This flag indicates if internal charge controller function is supported or not. This value is fixed to 1.

A.5 AtRate(0x04)

This read- or write-word function is the first half of a two-function call set used to set the *AtRate* value used in calculations made by the *AtRateTimeToFull*, *AtRateTimeToEmpty*, and *AtRateOK* functions. The *AtRate* units are in either mA (*[CapM]* = 0) or 10 mW (*[CapM]* = 1).

When the *AtRate* value is positive, the *AtRateTimeToFull* function returns the predicted time to full-charge at the *AtRate* value of charge. When the *AtRate* value is negative, the *AtRateTimeToEmpty* function returns the predicted operating time at the *AtRate* value of discharge. When the *AtRate* value is negative, the *AtRateOK* function returns a Boolean value that predicts the battery's ability to supply the *AtRate* value of additional discharge energy (current or power) for 10 seconds.

The default value for *AtRate* is zero.

Table A-10. AtRate

SBS Cmd.	Mode	Name	Format	Size in Bytes	Min Value	Max Value	Default Value	Unit
0x04	R/W	AtRate	signed integer	2	-32768	32767	0	mA or 10 mW

Related Variables:

- SBS:AtRateTimeToFull
- SBS:AtRateTimeToEmpty
- SBS:AtRateOK
- SBS:BatteryMode[CapM]

A.6 AtRateTimeToFull(0x05)

This read-word function returns an unsigned integer value of the predicted remaining time to fully charge the battery using a CC-CV method at the *AtRate* value in minutes, with a range of 0 to 65534. A value of 65535 indicates that the *AtRate* = 0.

AtRateTimeToFull can report time based on constant current ($[CapM] = 0$) or constant power ($[CapM] = 1$), and updates within one second after the SMBus host sets the *AtRate* value. The bq3055 automatically updates *AtRateTimeToFull* based on the *AtRate* function at one-second intervals.

- 0..65534 = predicted time to full charge, based on *AtRate*
- 65535 = no charge or discharge (*AtRate* is 0)

Table A-11. AtRateTimeToFull

SBS Cmd.	Mode	Name	Format	Size in Bytes	Min Value	Max Value	Default Value	Unit
0x05	R	AtRateTimeToFull	unsigned integer	2	0	65535	—	min

Related Variables:

- SBS:AtRate
- SBS:BatteryMode[CapM]

A.7 AtRateTimeToEmpty(0x06)

This read-word function returns an unsigned integer value of the predicted remaining operating time in minutes with a range of 0 to 65534, if the battery is discharged at the *AtRate* value. A value of 65535 indicates that *AtRate* = 0.

AtRateTimeToEmpty can report time based on constant current ($[LDMD] = 0$), or constant power ($[LDMD] = 1$), and is updated within one second after the SMBus host sets the *AtRate* value. The bq3055 updates *AtRateTimeToEmpty* at one-second intervals.

- 0..65534 = predicted remaining operating time, based on *AtRate*
- 65535 = no charge or discharge (*AtRate* is 0)

Table A-12. AtRateTimeToEmpty

SBS Cmd.	Mode	Name	Format	Size in Bytes	Min Value	Max Value	Default Value	Unit
0x06	R	AtRateTimeToEmpty	unsigned integer	2	0	65535	—	min

Related Variables:

- SBS:AtRate
- SBS:OperationStatus[LDMD]

A.8 AtRateOK(0x07)

This read-word function returns a boolean value that indicates whether or not the battery can deliver the *AtRate* value of energy for 10 seconds.

The bq3055 updates this value within one second after the SMBus host sets the *AtRate* function value. The bq3055 updates *AtRateOK* at one-second intervals.

If *AtRate* function returns ≥ 0 , *AtRateOK* always returns TRUE.

- 0 = FALSE bq3055 can **not** deliver energy for 10 seconds based on discharge rate indicated in *AtRate*
- 1..65535 = TRUE bq3055 deliver can energy for 10 seconds based on discharge rate indicated in *AtRate*

Table A-13. AtRateOK

SBS Cmd.	Mode	Name	Format	Size in Bytes	Min Value	Max Value	Default Value	Unit
0x07	R	AtRateOK	unsigned integer	2	0	65535	—	min

Related Variables:

- SBS:AtRate

A.9 Temperature(0x08)

This read-word function returns an unsigned integer value of the temperature in units of 0.1°K, as measured by the bq3055. It has a range of 0 to 6553.5°K.

The source of the measured temperature is configured by *[TEMP1]*, *[TEMP0]* bits in the **Operation Cfg A** register.

Table A-14. Temperature

SBS Cmd.	Mode	Name	Format	Size in Bytes	Min Value	Max Value	Default Value	Unit
0x08	R	Temperature	unsigned integer	2	0	65535	—	0.1°K

Related Variables:

- DF:Configuration:Register:Operation Cfg A

A.10 Voltage(0x09)

This read-word function returns an unsigned integer value of the sum of the individual cell voltage measurements in mV with a range of 0 to 20000 mV.

Table A-15. Voltage

SBS Cmd.	Mode	Name	Format	Size in Bytes	Min Value	Max Value	Default Value	Unit
0x09	R	Voltage	unsigned integer	2	0	20000	—	mV

A.11 Current(0x0a)

This read-word function returns a signed integer value of the measured current being supplied (or accepted) by the battery in mA, with a range of -32,768 to 32,767. A positive value indicates charge current and a negative value indicates discharge.

Any current value within the **Deadband** will be reported as 0 mA by the *Current* function.

Table A-16. Current

SBS Cmd.	Mode	Name	Format	Size in Bytes	Min Value	Max Value	Default Value	Unit
0x0a	R	Current	signed integer	2	-32768	32767	—	mA

Related Variables:

- DF:Calibration:Current:Deadband

NOTE: *Current* function is the average of 4 internal current measurements over a one-second period.

A.12 AverageCurrent(0x0b)

This read-word function returns a signed integer value that approximates a one-minute rolling average of the current being supplied (or accepted) through the battery terminals in mA, with a range of –32,768 to 32,767.

AverageCurrent is calculated by a rolling IIR filtered average of *Current* function data with a period of 14.5 s. During the time after a reset and before 14.5 s has elapsed the reported *AverageCurrent* = *Current* function value.

Table A-17. AverageCurrent

SBS Cmd.	Mode	Name	Format	Size in Bytes	Min Value	Max Value	Default Value	Unit
0x0b	R	AverageCurrent	signed integer	2	–32768	32767	—	mA

Related Variables:

- DF:Calibration:Current:Filter
- SBS:Current

A.13 MaxError(0x0c)

This read-word function returns an unsigned integer value of the expected margin of error, in %, in the state-of-charge calculation with a range of 1 to 100%.

For example, when *MaxError* returns 10% and *RelativeStateOfCharge* returns 50%, the *RelativeStateOfCharge* is more likely between 50% and 60%. The bq3055 sets *MaxError* to 100% on a full reset. The bq3055 sets *MaxError* to 2% on completion of a learning cycle, unless the bq3055 limits the learning cycle to the +512/–356 mAh maximum adjustment values. If the learning cycle is limited, the bq3055 sets *MaxError* to 8% unless *MaxError* was already below 8%. In this case, *MaxError* does not change. The bq3055 increments *MaxError* by 1% after four increments of *CycleCount* without a learning cycle.

Event	<i>MaxError</i> Setting
Full Reset	set to 100%
Completion of a learning cycle without limit	set to 2%
Completion of a limited learning cycle	set to a maximum of 8%
Without a learning cycle	Increment by 1% every four cycle

Table A-18. MaxError

SBS Cmd.	Mode	Name	Format	Size in Bytes	Min Value	Max Value	Default Value	Unit
0x0c	R	MaxError	unsigned integer	1	0	100	—	%

Related Variables:

- SBS:CycleCount

A.14 RelativeStateOfCharge(0x0d)

This read-word function returns an unsigned integer value of the predicted remaining battery capacity expressed as a percentage of *FullChargeCapacity* with a range of 0 to 100%, with fractions of % rounded up.

If the **[RSOCL]** bit in **Operation Cfg C** is set then *RelativeStateofCharge* and *RemainingCapacity* are held at 99% until primary charge termination occurs and only displays 100% upon entering primary charge termination.

If the **[RSOCL]** bit in **Operation Cfg C** is cleared then *RelativeStateofCharge* and *RemainingCapacity* are **not** held at 99% until primary charge termination occurs. Fractions of % greater than 99% are rounded up to display 100%.

Table A-19. RelativeStateOfCharge

SBS Cmd.	Mode	Name	Format	Size in Bytes	Min Value	Max Value	Default Value	Unit
0x0d	R	RelativeStateOfCharge	unsigned integer	1	0	100	—	%

Related Variables:

- DF:Configuration:Registers:Operation Cfg C[RSOCL]
- SBS:FullChargeCapacity

A.15 AbsoluteStateOfCharge(0x0e)

This read-word function returns an unsigned integer value of the predicted remaining battery capacity expressed in %, with a range of 0 to 100%, with any fractions of % rounded up. The table below shows the calculation used depending on the **[CapM]** flag.

CapM AbsoluteStateOfCharge Calculation

0 = *RemainingCapacity/Design Capacity*

1 = *RemainingCapacity/ Design Energy*

NOTE: *AbsoluteStateOfCharge* can return values > 100%.

Table A-20. AbsoluteStateOfCharge

SBS Cmd.	Mode	Name	Format	Size in Bytes	Min Value	Max Value	Default Value	Unit
0x0e	R	AbsoluteStateOfCharge	unsigned integer	1	0	100+	—	%

Related Variables:

- DF:SBS Configuration:Data:Design Capacity
- DF:SBS Configuration:Data:Design Energy
- SBS:BatteryMode[CapM]
- SBS:RemainingCapacity

A.16 RemainingCapacity(0x0f)

This read- or write-word function returns an unsigned integer value, with a range of 0 to 65535, of the predicted charge or energy remaining in the battery. This value is expressed in either charge (mAh) or energy (10 mWh), depending on the setting of the **[CapM]** flag.

Table A-21. RemainingCapacity

SBS Cmd.	Mode	Name	Format	Size in Bytes	Min Value	Max Value	Default Value	Unit
0x0f	R/W	RemainingCapacity	unsigned integer	2	0	65535	—	mAh or 10 mWh

Related Variables:

- SBS:BatteryMode[CapM]

A.17 FullChargeCapacity(0x10)

This read-word function returns an unsigned integer value, with a range of 0 to 65535, of the predicted pack capacity when it is fully charged. This value is expressed in either charge (mAh) or power (10 mWh) depending on setting of *[CapM]* flag.

Table A-22. FullChargeCapacity

SBS Cmd.	Mode	Name	Format	Size in Bytes	Min Value	Max Value	Default Value	Unit
0x10	R	FullChargeCapacity	unsigned integer	2	0	65535	—	mAh or 10 mWh

Related Variables:

- SBS:BatteryMode[CapM]

A.18 RunTimeToEmpty(0x11)

This read-word function returns an unsigned integer value of the predicted remaining battery life at the present rate of discharge, in minutes, with a range of 0 to 65534 min. A value of 65535 indicates that the battery is not being discharged.

This value is calculated and updated based on current or power, depending on the setting of the *[CapM]* flag.

- 0..65534 = predicted remaining battery life, based on *Current*
- 65535 = battery is not being discharged

Table A-23. RunTimeToEmpty

SBS Cmd.	Mode	Name	Format	Size in Bytes	Min Value	Max Value	Default Value	Unit
0x11	R	RunTimeToEmpty	unsigned integer	2	0	65535	—	min

Related Variables:

- SBS:BatteryMode[CapM]

A.19 AverageTimeToEmpty(0x12)

This read-word function returns an unsigned integer value of the predicted remaining battery life, in minutes, based upon *AverageCurrent*, with a range of 0 to 65534. A value of 65535 indicates that the battery is not being discharged.

This value is calculated based on current or power, depending on the setting of the *[CapM]* flag.

- 0..65534 = predicted remaining battery life, based on *AverageCurrent*
- 65535 = battery is not being discharged

Table A-24. AverageTimeToEmpty

SBS Cmd.	Mode	Name	Format	Size in Bytes	Min Value	Max Value	Default Value	Unit
0x12	R	AverageTimeToEmpty	unsigned integer	2	0	65535	—	min

Related Variables:

- SBS:BatteryMode[CapM]
- SBS:AverageCurrent

A.20 AverageTimeToFull(0x13)

This read-word function returns an unsigned integer value of predicted remaining time until the battery reaches full charge, in minutes, based on *AverageCurrent*, with a range of 0 to 65534. A value of 65535 indicates that the battery is not being charged.

- 0..65534 = predicted remaining time until full charge
- 65535 = battery is not being charged

Table A-25. AverageTimeToFull

SBS Cmd.	Mode	Name	Format	Size in Bytes	Min Value	Max Value	Default Value	Unit
0x13	R	AverageTimeToFull	unsigned integer	2	0	65535	—	min

Related Variables:

- SBS:AverageCurrent

A.21 ChargingCurrent(0x14)

This read-word function returns an unsigned integer value of the desired charging current, in mA, with a range of 0 to 65534. A value of 65535 indicates that a charger should operate as a voltage source outside its maximum regulated current range.

- 0..65534 = desired charging current in mA
- 65535 = charger should operate as voltage source outside its maximum regulated current range

Table A-26. ChargingCurrent

SBS Cmd.	Mode	Name	Format	Size in Bytes	Min Value	Max Value	Default Value	Unit
0x14	R	ChargingCurrent	unsigned integer	2	0	65535	—	mA

A.22 ChargingVoltage(0x15)

This read-word function returns an unsigned integer value of the desired charging voltage, in mV, where the range is 0 to 6553. A value of 65535 indicates that the charger should operate as a current source outside its maximum regulated voltage range.

- 0..65534 = desired charging voltage in mV
- 65535 = charger should operate as current source outside its maximum regulated voltage range

Table A-27. ChargingVoltage

SBS Cmd.	Mode	Name	Format	Size in Bytes	Min Value	Max Value	Default Value	Unit
0x15	R	ChargingVoltage	unsigned integer	2	0	65535	—	mV

A.23 BatteryStatus(0x16)

This read-word function returns the status of the battery.

	bit 7	bit 6	bit 5	bit 4	bit 3	bit 2	bit 1	bit 0
High Byte	OCA	TCA	RSVD	OTA	TDA	RSVD	RCA	RTA
Low Byte	INIT	DSG	FC	FD	EC3	EC2	EC1	EC0

LEGEND: All Values Read Only; RSVD = Reserved

Figure A-3. BatteryStatus

OCA — 1 = Over Charged Alarm

TCA — 1 = Terminate Charge Alarm

OTA — 1 = Over Temperature Alarm

TDA — 1 = Terminate Discharge Alarm

RCA — Remaining Capacity Alarm

1 = Remaining Capacity Alarm is set

see:

SBS:RemainingCapacityAlarm(0x01)

RTA — Remaining Time Alarm

1 = Remaining Time Alarm is set

see:

SBS:RemainingTimeAlarm(0x02)

INIT — 1 = Initialization. This flag is cleared approx. 1 second after device reset, after all SBS parameters have been measured and updated

DSG — Discharging

0 = bq3055 is in charging mode

1 = bq3055 is in discharging mode, relaxation mode, or valid charge termination has occurred

see:

[Section 1.4](#)

FC — 1 = Fully Charged

FD — 1 = Fully Discharged

EC3, EC2, EC1, EC0 — Error Code, returns status of processed SBS function

0,0,0,0 = OK	bq3055 processed the function code with no errors detected.
0,0,0,1 = BUSY	bq3055 is unable to process the function code at this time.
0,0,1,0 = Reserved	bq3055 detected an attempt to read or write to a function code reserved by this version of the specification or bq3055 detected an attempt to access an unsupported optional manufacturer function code.
0,0,1,1 = Unsupported	bq3055 does not support this function code as defined in this version of the specification.
0,1,0,0 = AccessDenied	bq3055 detected an attempt to write to a read-only function code.
0,1,0,1 = Over/Underflow	bq3055 detected a data overflow or underflow.
0,1,1,0 = BadSize	bq3055 detected an attempt to write to a function code with an incorrect data block.
0,1,1,1 = UnknownError	bq3055 detected an unidentifiable error.

A.24 CycleCount(0x17)

This read-word function returns, as an unsigned integer value, the number of cycles the battery has experienced, with a range of 0 to 65535. The default value is stored in the data flash value **Cycle Count**, which is updated each time this variable is incremented. There are 2 different cycle calculations depending on the **[CCT]** bit.

When the bq3055 is in Unsealed or higher security mode, this block is R/W.

CCT Cycle Count Calculation

0 = one cycle count is the accumulated discharge of **CC Threshold**

1 = one cycle count is the accumulated discharge of **CC % x FullChargeCapacity**. If **CC Threshold** is greater than **CC % x FullChargeCapacity**, **CC Threshold** is used for the calculation

Table A-28. CycleCount

SBS Cmd.	Mode	Name	Format	Size in Bytes	Min Value	Max Value	Default Value	Unit
0x17	R/W	CycleCount	unsigned integer	2	0	65535	0	

Related Variables:

- DF:SBS Configuration:Data Cycle Count
- DF:SBS Configuration:Data CC Threshold
- DF:SBS Configuration:Data CC %
- DF:Configuration:Registers:Operation Cfg B[CCT]
- SBS:FullChargeCapacity
- SBS:OperationStatus[SS],[FAS]

A.25 DesignCapacity(0x18)

This read-word function returns, as an unsigned integer value, the theoretical or nominal capacity of a new pack, stored in **Design Capacity** or in **Design Energy**.

The *DesignCapacity* value is expressed in either current (mAh at a C/5 discharge rate) or power, (10 mWh at a P/5 discharge rate) depending on the setting of the **[CapM]** bit.

When the bq3055 is in unsealed or higher security mode, this block is R/W.

Table A-29. DesignCapacity

SBS Cmd.	Mode	Name	CapM	Format	Size in Bytes	Min Value	Max Value	Default Value	Unit
0x18	R/W	DesignCapacity	0	unsigned integer	2	0	65535	4400	mAh
			1	unsigned integer	2	0	65535	6336	10 mWh

Related Variables:

- DF:SBS Configuration:Data:Design Capacity
- DF:SBS Configuration:Data:Design Energy
- SBS:BatteryMode[CapM]
- SBS:OperationStatus[SS],[FAS]

A.26 DesignVoltage(0x19)

This read-word function returns an unsigned integer value of the theoretical voltage of a new pack, in mV, with a range of 0 to 65535. The default value is stored in **Design Voltage**.

When the bq3055 is in Unsealed or higher security mode, this block is R/W.

Table A-30. DesignVoltage

SBS Cmd.	Mode	Name	Format	Size in Bytes	Min Value	Max Value	Default Value	Unit
0x19	R/W	DesignVoltage	unsigned integer	2	7000	18000	14400	mV

Related Variables:

- DF:SBS Configuration:Data:Design Voltage
- SBS:OperationStatus[SS],[FAS]

A.27 SpecificationInfo(0x1a)

This read-word function returns, as an unsigned integer value, the version number of the Smart Battery Specification the battery pack supports, as well as voltage- and current-scaling information.

Power-scaling is the product of the voltage-scaling times the current-scaling. The data is packed in the following fashion:

$$\text{IPScale} \times 0x1000 + \text{VScale} \times 0x0100 + \text{SpecID_H} \times 0x0010 + \text{SpecID_L}$$

VScale (voltage scaling) and IPScale (current scaling) should always be set to zero. The default setting is stored in **Spec Info**.

When the bq3055 is in Unsealed or higher security mode, this block is R/W.

Table A-31. SpecificationInfo

SBS Cmd.	Mode	Name	Format	Size in Bytes	Min Value	Max Value	Default Value	Unit
0x1a	R/W	SpecificationInfo	hex	2	0x0000	0xffff	0x0031	

15	14	13	12	11	10	9	8	7	6	5	4	3	2	1	0
IPScale (0) (multiplies current by $10^{IPScale}$)				VScale (0) (multiplies voltage by 10^{VScale})				SpecID_H (0..15)				SpecID_L (0..15)			

LEGEND: R/W = Read/Write; R = Read only; -n = value after reset

Figure A-4. SpecificationInfo

Related Variables:

- DF:SBS Configuration:Data:Spec Info
- SBS:OperationStatus[SS],[FAS]

A.28 ManufactureDate(0x1b)

This read-word function returns the date the pack was manufactured in a packed integer. The date is packed in the following fashion:

$$(\text{year}-1980) \times 512 + \text{month} \times 32 + \text{day}$$

The default value for this function is stored in **Manuf Date**.

When the bq3055 is in Unsealed or higher security mode, this block is R/W.

Table A-32. ManufactureDate

SBS Cmd.	Mode	Name	Format	Size in Bytes	Min Value	Max Value	Default Value	Unit
0x1b	R/W	ManufacturerDate	unsigned integer	2	0	65535	0	

15	14	13	12	11	10	9	8	7	6	5	4	3	2	1	0
Year biased by 1980 (0..127)							Month (1..12)				Date (0..31)				
MSB						LSB	MSB			LSB	MSB				LSB

Figure A-5. ManufacturerDate

Related Variables:

- DF:SBS Configuration:Data:Manuf Date
- SBS:OperationStatus[SS],[FAS]

A.29 SerialNumber(0x1c)

This read-word function is used to return an unsigned integer serial number. The default value of this function is stored in **Ser. Num.**

When the bq3055 is in Unsealed or higher security mode, this block is R/W.

Table A-33. SerialNumber

SBS Cmd.	Mode	Name	Format	Size in Bytes	Min Value	Max Value	Default Value	Unit
0x1c	R/W	SerialNumber	hex	2	0x0000	0xffff	0x0001	

Related Variables:

- DF:SBS Configuration:Data:Ser. Num.
- SBS:OperationStatus[SS],[FAS]

A.30 ManufacturerName(0x20)

This read-block function returns a character string containing the battery manufacturer's name with a maximum length of 11 characters (11 data + length byte).

The default setting of this function is stored in data flash **Manuf Name**.

When the bq3055 is in Unsealed or higher security mode, this block is R/W.

Table A-34. ManufacturerName

SBS Cmd.	Mode	Name	Format	Size in Bytes	Min Value	Max Value	Default Value	Unit
0x20	R/W	ManufacturerName	String	11+1	—	—	Texas Inst.	ASCII

Related Variables:

- DF:SBS Configuration:Data:Manuf Name
- SBS:OperationStatus[SS],[FAS]

A.31 DeviceName(0x21)

This read-block function returns a character string that contains the battery name with a maximum length of 7 characters (7 data + length byte).

The default setting of this function is stored in data flash **Device Name**.

When the bq3055 is in Unsealed or higher security mode, this block is R/W.

Table A-35. DeviceName

SBS Cmd.	Mode	Name	Format	Size in Bytes	Min Value	Max Value	Default Value	Unit
0x21	R/W	DeviceName	String	7+1	—	—	bq3055	ASCII

Related Variables:

- DF:SBS Configuration:Data:Device Name
- SBS:OperationStatus[SS],[FAS]

A.32 DeviceChemistry(0x22)

This read-block function returns a character string that the manufacturer uses to identify the battery chemistry with a maximum length of 4 characters (4 data + length byte).

The default setting of this function is stored in data flash **Device Chemistry**, although it has no use for internal charge control or fuel gauging.

When the bq3055 is in Unsealed or higher security mode, this block is R/W.

Table A-36. DeviceChemistry

SBS Cmd.	Mode	Name	Format	Size in Bytes	Min Value	Max Value	Default Value	Unit
0x22	R/W	DeviceChemistry	String	4+1	—	—	LION	ASCII

Related Variables:

- DF:SBS Configuration:Data:Device Chemistry
- SBS:OperationStatus[SS],[FAS]

A.33 ManufacturerData/CalibrationData(0x23)

This read-block function returns several configuration data flash elements with an absolute maximum length of 14 Data + 1 length byte (stored in Manufacturer Data Length). The Manufacturing data elements shown below are stored in the Manufacturer Data subclass. When the bq3055 is in unsealed or higher security mode, this block is R/W.

Table A-37. ManufacturerData

Data	Byte	Name	Format
Manufacturer Data	0	Pack Lot Code	Hex
	1		
	2	PCB Lot Code	
	3		
	4	Firmware Version	
	5		
	6	Hardware Revision	
	7		
	8	Cell Revision	
9			
bq3055 Counter	10	Partial Reset Counter	
	11	Full Reset Counter	
	12	Watchdog Reset Counter	
	13	Check Sum	
Length	14	String Length Byte	

Related Variables:

- DF:System Data:Manufacturer Data:Pack Lot Code
- DF:System Data:Manufacturer Data:PCB Lot Code
- DF:System Data:Manufacturer Data:Firmware Version
- DF:System Data:Manufacturer Data:Hardware Revision
- DF:System Data:Manufacturer Data:Cell Revision
- SBS:OperationStatus[SS],[FAS]

While in calibration mode, this read-block function returns raw ADC and Coulomb Counter data with an absolute maximum length of 26 bytes.

Table A-38. CalibrationData

Data	Byte	Name	Format
Calibration Data	0	8-bit counter, refreshes after every ADC sample, 250 ms	Hex
	1	Output Calibration Data Status, 0x01 if ManufacturerData() = 0xF081 or 0x02 if ManufacturerData() = 0xF082	
	2	Coulomb Counter	2's Complement
	3		
	4	Cell Voltage 1	
	5		
	6	Cell Voltage 2	
	7		
	8	Cell Voltage 3	
	9		
	10	Cell Voltage 4	
	11		
	12	Internal Temperature	
	13		
	14	External Temperature 1 (TS1)	
	15		
	16	External Temperature 2 (TS2)	
	17		
	18	Reserved	
	19		
	20	Reserved	
	21		
	22	PACK Voltage	
	23		
	24	BAT Voltage	
25			

Related Variables:

- SBS:ManufacturerData
- SBS:ManufacturerStatus[CAL STATUS]
- SBS:OperationStatus[GAUGE STATUS]
- DF:Calibration:Voltage:Cell Scale 0
- DF:Calibration:Voltage:Cell Scale 1
- DF:Calibration:Voltage:Cell Scale 2
- DF:Calibration:Voltage:Cell Scale 3
- DF:Calibration:Voltage:PACK Gain
- DF:Calibration:Voltage:BAT Gain
- DF:Calibration:Current:CC Gain
- DF:Calibration:Current:Capacity Gain
- DF:Calibration:Current Offset:CC Offset
- DF:Calibration:Current Offset:CC Offset Samples
- DF:Calibration:Current Offset:Board Offset
- DF:Calibration:Temperature:Internal Temp Offset
- DF:Calibration:Temperature:External 1 Temp Offset
- DF:Calibration:Temperature:External 2 Temp Offset

- DF:Calibration:Temperature:External 3 Temp Offset
- DF:Calibration:Temperature:External 4 Temp Offset
- DF:Calibration:Temperature:External 1 Temp Offset
- DF:Calibration:Internal Temp Model:Int Coeff 1
- DF:Calibration:Internal Temp Model:Int Coeff 2
- DF:Calibration:Internal Temp Model:Int Coeff 3
- DF:Calibration:Internal Temp Model:Int Coeff 4
- DF:Calibration:External Temp Model:Ext Coeff a1
- DF:Calibration:External Temp Model:Ext Coeff a2
- DF:Calibration:External Temp Model:Ext Coeff a3
- DF:Calibration:External Temp Model:Ext Coeff a4
- DF:Calibration:External Temp Model:Ext Coeff a5
- DF:Calibration:External Temp Model:Ext Coeff b1
- DF:Calibration:External Temp Model:Ext Coeff b2
- DF:Calibration:External Temp Model:Ext Coeff b3
- DF:Calibration:External Temp Model:Ext Coeff b4

A.34 Authenticate/ManufacturerInput(0x2f)

This read- or write-block function allows the host to authenticate the bq3055 -based battery using a SHA-1 authentication transform with a length of 20 data bytes + 1 length byte. See *SHA-1 Authentication* chapter and *Using SHA-1 in bq20zxx Family of Gas Gauges* application report ([SLUA359](#)) for detailed information.

Table A-39. Authenticate

SBS Cmd.	Mode	Name	Format	Size in Bytes	Min Value	Max Value	Default Value	Unit
0x2f	R/W	Authenticate	String	20+1	—	—	—	

While in data flash access mode, this read- or write-block function stores a 32-byte block in data flash at the data flash row address pointed to by ManufacturerAccess(0x01yy).

Similarly, a read to this command will return a 32-byte block from data flash based on Manufacturer Access(0x01yy).

Table A-40. ManufacturerInput

SBS Cmd.	Mode	Name	Format	Size in Bytes	Min Value	Max Value	Default Value	Unit
0x2f	R/W	ManufacturerInput	Hex	32	—	—	—	

A.35 CellVoltage4..1(0x3c..0x3f)

These read-word functions return an unsigned value of the calculated individual cell voltages, in mV, with a range of 0 to 65535. *CellVoltage1* corresponds to the bottom most series cell element, while *CellVoltage4* corresponds to the top most series cell element.

Table A-41. CellVoltage4..1

SBS Cmd.	Mode	Name	Format	Size in Bytes	Min Value	Max Value	Default Value	Unit
0x3c	R	CellVoltage4	unsigned integer	2	0	65535	—	mV
0x3d		CellVoltage3					—	
0x3e		CellVoltage2					—	
0x3f		CellVoltage1					—	

A.36 SBS Command Values
Table A-42. SBS COMMANDS

SBS Cmd	Mode	Name	Format	Size in Bytes	Min Value	Max Value	Default Value	Unit
0x00	R/W	ManufacturerAccess	hex	2	0x0000	0xffff	—	
0x01	R/W	RemainingCapacityAlarm	unsigned int	2	0	65535	300	mAh or 10 mWh
0x02	R/W	RemainingTimeAlarm	unsigned int	2	0	65535	10	min
0x03	R/W	BatteryMode	hex	2	0x0000	0xe383	—	
0x04	R/W	AtRate	signed int	2	-32768	32767	—	mA or 10 mW
0x05	R	AtRateTimeToFull	unsigned int	2	0	65534	—	min
0x06	R	AtRateTimeToEmpty	unsigned int	2	0	65534	—	min
0x07	R	AtRateOK	unsigned int	2	0	65535	—	
0x08	R	Temperature	unsigned int	2	0	65535	—	0.1°K
0x09	R	Voltage	unsigned int	2	0	65535	—	mV
0x0a	R	Current	signed int	2	-32768	32767	—	mA
0x0b	R	AverageCurrent	signed int	2	-32768	32767	—	mA
0x0c	R	MaxError	unsigned int	1	0	100	—	%
0x0d	R	RelativeStateOfCharge	unsigned int	1	0	100	—	%
0x0e	R	AbsoluteStateOfCharge	unsigned int	1	0	100+	—	%
0x0f	R/W	RemainingCapacity	unsigned int	2	0	65535	—	mAh or 10 mWh
0x10	R	FullChargeCapacity	unsigned int	2	0	65535	—	mAh or 10 mWh
0x11	R	RunTimeToEmpty	unsigned int	2	0	65534	—	min
0x12	R	AverageTimeToEmpty	unsigned int	2	0	65534	—	min
0x13	R	AverageTimeToFull	unsigned int	2	0	65534	—	min
0x14	R	ChargingCurrent	unsigned int	2	0	65534	—	mA
0x15	R	ChargingVoltage	unsigned int	2	0	65534	—	mV
0x16	R	BatteryStatus	unsigned int	2	0x0000	0xdbff	—	
0x17	R/W	CycleCount	unsigned int	2	0	65535	—	
0x18	R/W	DesignCapacity	unsigned int	2	0	65535	4400	mAh or 10 mWh
0x19	R/W	DesignVoltage	unsigned int	2	0	65535	14400	mV
0x1a	R/W	SpecificationInfo	hex	2	0x0000	0xffff	0x0031	
0x1b	R/W	ManufactureDate	unsigned int	2	—	—	01-Jan-1980	ASCII
0x1c	R/W	SerialNumber	hex	2	0x0000	0xffff	0x0001	
0x20	R/W	ManufacturerName	String	11+1	—	—	Texas Inst.	ASCII
0x21	R/W	DeviceName	String	7+1	—	—	bq3055	ASCII
0x22	R/W	DeviceChemistry	String	4+1	—	—	LION	ASCII
0x23	R/W	ManufacturerData/ Calibration Data	String/Hex and 2's Complement	14+1/2 6	—	—	—	ASCII / -
0x2f	R/W	Authenticate/Manufacturer Input	String/Hex	20+1/3 2	—	—	—	ASCII /-
0x3c	R	CellVoltage4	unsigned int	2	0	65535	—	mV
0x3d	R	CellVoltage3	unsigned int	2	0	65535	—	mV
0x3e	R	CellVoltage2	unsigned int	2	0	65535	—	mV
0x3f	R	CellVoltage1	unsigned int	2	0	65535	—	mV

Extended SBS Commands

The extended SBS commands are only available when the bq3055 device is in unsealed or full access mode.

Related Variables:

- SBS:ManufacturerAccess:Seal Access
- SBS:OperationStatus[SS],[FAS]
- SBS:UnSealKey
- SBS:FullAccessKey

B.1 AFEData(0x45)

This read-block function returns a string of 11 data bytes + 1 length byte. The first 9 bytes are the integrated AFE memory map followed by 2 bytes of the internal bq3055 AFE_Fail_Counter.

Table B-1. AFEData

Data	Byte	Name	Format
Integrated AFE	0	AFE Status	hex
	1	AFE State	
	2	AFE Output	
	3	AFE Output Status	
	5	AFE Cell Select	
	6	AFE OLV	
	7	AFE OLT	
	8	AFE SCC	
	9	AFE SCD	
bq3055	9	Internal AFE_Fail_Counter high byte	
	10	Internal AFE_Fail_Counter low byte	
	11	String Length Byte	

Related Variables:

- DF:2nd Level Safety:AFE Verification:AFE Fail Limit
- DF:PF Status:AFE Regs

B.2 FETControl(0x46)

This read- or write-word function allows direct control of the FETs for test purposes only. If this command was used to alter current state of the FETs, the gauge can overwrite the FET state depending on gauging and safety conditions. If the FUSE pin is not used in the application circuit, it should be connected to ground directly or the FETs will not be able to turn on.

	bit 7	bit 6	bit 5	bit 4	bit 3	bit 2	bit 1	bit 0
FETControl	RSVD	RSVD	RSVD	RSVD	ZVCHG	CHG	DSG	RSVD

LEGEND: RSVD = Reserved and **must** be programmed to 0

Figure B-1. FETControl

ZVCHG — (Pre-Charge) charge FET Control

0 = Turn OFF pre-charge FET

1 = Turn ON pre-charge FET

CHG — Charge FET Control

0 = Turn OFF CHG FET. CHG FET doesn't turn off in discharge mode to protect the FET body diode.

1 = Turn ON CHG FET

DSG — Discharge FET Control

0 = Turn OFF DSG FET. DSG FET doesn't turn of in charge mode to protect the FET body diode.

1 = Turn ON DSG FET

B.3 PendingEDV(0x47)

This read-word function returns the predicted EDV2 until EDV2 is reached, then the predicted EDV1 until EDV1 is reached, and then the predicted EDV0. Format is little endian.

Table B-2. PendingEDV

SBS Cmd.	Mode	Name	Format	Size in Bytes	Min Value	Max Value	Default Value	Unit
0x47	R	PendingEDV	unsigned integer	2	0	65535	—	mV

B.4 StateOfHealth(0x4f)

This read-word function returns the state of health of the battery in %. The calculation formula depends on the *[CapM]* flag.

CapM StateOfHealth

0 = $FullChargeCapacity / Design Capacity$

1 = $FullChargeCapacity / Design Energy$

Related Variables:

- DF:SBS Configuration:Data:Design Capacity
- DF:SBS Configuration:Data:Design Energy
- SBS:FullChargeCapacity
- SBS:BatteryMode[CapM]

B.5 SafetyAlert(0x50)

This read-word function returns indications of pending safety issues, such as running safety timers, or fail counters that are nonzero but have not reached the required time or value to trigger a *SafetyStatus* failure.

See the "1st Level Protection Features" chapter for further details.

Related Variables:

- SBS:SafetyStatus

	bit 7	bit 6	bit 5	bit 4	bit 3	bit 2	bit 1	bit 0
High Byte	OTD	OTC	OCD	OCC	RSVD	RSVD	RSVD	RSVD
Low Byte	CUV	COV	PF	RSVD	WDF	AOCD	SCC	SCD

LEGEND: All Values Read-Only

Figure B-2. SafetyAlert

OTD — 1 = Discharge overtemperature alert

OTC — 1 = Charge overtemperature alert

OCD — 1 = Discharge overcurrent alert

OCC — 1 = Charge overcurrent alert

WDF — 1 = AFE watchdog alert

AOCD — 1 = AFE discharge overcurrent alert

SCC — 1 = Charge short-circuit alert

SCD — 1 = Discharge short-circuit alert

B.6 SafetyStatus(0x51)

This read-word function returns the status of the 1st level safety features.

See the "1st Level Protection Features" chapter for further details.

Related Variables:

- SBS:SafetyAlert

	bit 7	bit 6	bit 5	bit 4	bit 3	bit 2	bit 1	bit 0
High Byte	OTD	OTC	OCD	OCC	RSVD	RSVD	RSVD	RSVD
Low Byte	CUV	COV	PF	RSVD	WDF	AOCD	SCC	SCD

LEGEND: All Values Read-Only

Figure B-3. SafetyStatus

OTD — 1 = Discharge overtemperature condition

OTC — 1 = Charge overtemperature condition

OCD — 1 = Discharge overcurrent condition

OCC — 1 = Charge overcurrent condition

CUV — 1 = Cell undervoltage condition

COV — 1 = Cell overvoltage condition

PF — 1 = Permanent failure and FUSE pin has been driven high.

WDF — 1 = AFE watchdog condition

AOCD — 1 = AFE discharge overcurrent condition

SCC — 1 = Charge short-circuit condition

SCD — 1 = Discharge short-circuit condition

B.7 PFAAlert(0x52)

This read-word function returns indications of pending safety issues, such as running safety timers that have not reached the required time to trigger a *PFAAlert* failure.

See [Section 1.3](#) for further details.

Related Variables:

- DF:Configuration:Registers:Permanent Fail Cfg
- DF:PF Status:Device Status Data:Fuse Flag
- DF:PF Status:Device Status Data:PF Flags 2
- SBS:Current
- SBS:Voltage
- SBS:PFStatus

	bit 7	bit 6	bit 5	bit 4	bit 3	bit 2	bit 1	bit 0
High Byte	RSVD	VSHUT	RSVD	SOPT	SOCD	SOCC	AFE_P	ACE_C
Low Byte	DFF	DFETF	CFETF	CIM	SOTD	SOTC	SOV	PFIN

LEGEND: All Values Read-Only; RSVD = Reserved

Figure B-4. PFAAlert

VSHUT — = 1: A permanent failure has occurred AND the device went into shutdown after that event.

SOPT — = 1: Open Thermistor permanent failure alert

SOCD — = 1: Discharge Safety Overcurrent permanent failure alert

SOCC — = 1: Charge Safety-Overcurrent permanent failure alert

AFE_P — = 1: Periodic AFE Communications permanent failure alert

AFE_C — = 1: Permanent AFE Communications failure alert

DFF — 1 = Data Flash Fault permanent failure alert

DFETF — = 1: Discharge-FET-Failure permanent failure alert

CFETF — = 1: Charge-FET-Failure permanent failure alert

CIM — = 1: Cell-Imbalance permanent failure alert

SOTD — = 1: Discharge Safety Overtemperature permanent failure alert

SOTC — = 1: Charge Safety Overtemperature permanent failure alert

SOV — = 1: Safety-Overvoltage permanent failure alert

PFIN — = 1: External Input Indication of permanent failure alert

B.8 PFStatus(0x53)

The permanent failure status register indicates the source of the bq3055 permanent-failure condition.

Any new permanent failure is added to **PF Flags 1** register to show all permanent failures that have occurred.

See [Section 1.3](#) for further details.

Related Variables:

- DF:Configuration:Registers:Permanent Fail Cfg
- DF:PF Status:Device Status Data:Fuse Flag
- DF:PF Status:Device Status Data:PF Flags 1

- DF:PF Status:Device Status Data:PF Flags 2
- SBS:PFAAlert

	bit 7	bit 6	bit 5	bit 4	bit 3	bit 2	bit 1	bit 0
High Byte	RSVD	VSHUT	RSVD	SOPT	S OCD	SOCC	AFE_P	AFE_C
Low Byte	DFF	DFETF	CFETF	CIM	SOTD	SOTC	SOV	PFIN

LEGEND: All Values Read-Only; RSVD = Reserved

Figure B-5. PFStatus

VSHUT — = 1: A permanent failure has occurred AND the device went into shutdown after that event

SOPT — 1 = Open Thermistor permanent failure

S OCD — 1 = Discharge Safety Overcurrent permanent failure

SOCC — 1 = Charge Safety-Overcurrent permanent failure

AFE_P — 1 = Periodic AFE Communications permanent failure

AFE_C — 1 = Permanent AFE Communications failure

DFF — 1 = Data Flash Fault permanent failure

DFETF — 1 = Discharge-FET-Failure permanent failure

CFETF — 1 = Charge-FET-Failure permanent failure

CIM — 1 = Cell-Imbalance permanent failure

SOTD — 1 = Discharge Safety Overtemperature permanent failure

SOTC — 1 = Charge Safety Overtemperature permanent failure

SOV — 1 = Safety-Overvoltage permanent failure

PFIN — 1 = External Input Indication of permanent failure

B.9 OperationStatus(0x54)

This read-word function returns the current operation status of the bq3055.

	bit 7	bit 6	bit 5	bit 4	bit 3	bit 2	bit 1	bit 0
High Byte	PRES	FAS	SS	CSV	LTPF	RSVD	RSVD	STATUS
Low Byte	WAKE	DSG	XDSG	XDSGI	EDV2	VDQ	RSVD	RSVD

LEGEND: All Values Read-Only; RSVD = Reserved

Figure B-6. OperationStatus

PRES — 1 = $\overline{\text{PRES}}$ is low, indicating that the system is present (battery inserted).

FAS — 0 = Full access security mode

SS — 1 = Sealed security mode

CSV — 1 = Data Flash checksum value has been generated

LTPF — The LTPF flag indicates if Lifetime Data and PF are enabled

0 = Lifetime Data and PF are not enabled (default)

1 = Lifetime Data and PF enabled

STATUS — The STATUS flag indicates if the gauge is in normal mode or calibration mode

0 = Gauge is in normal data acquisition mode

1 = Gauge is in calibration data acquisition mode

WAKE — 1 = bq3055 WAKE mode

DSG — Replica of the SBS:BatteryStatus(0x16)[DSG] flag.

XDSG — 1 = Discharge fault

XDSGI — 1 = Discharge disabled due to a current issue

EDV2 — indicates that cell voltage is less than the EDV2 threshold

0 = Voltage > EDV2 threshold (discharging)

1 = Voltage < EDV2 threshold

VDQ — indicates if the present discharge cycle is valid for an FCC update.

0 = Discharge cycle not valid

1 = Discharge cycle valid

B.10 ChargingStatus(0x55)

This read-word function returns the current status of the charging functions.

	bit 7	bit 6	bit 5	bit 4	bit 3	bit 2	bit 1	bit 0
High Byte	XCHG	CHGSUS P	PCHG	RSVD	LTCHG	ST1CHG	ST2CHG	HTCHG
Low Byte	RSVD	CB	PCMTO	FCMTO	OCHGV	OCHGI	OC	XCHGLV

LEGEND: All Values Read-Only

Figure B-7. ChargingStatus

XCHG — 1 = Charging disabled

CHGSUSP — 1 = Charging suspended

PCHG — 1 = Precharging conditions exist

LTCHG — 1 = Low temperature charging

ST1CHG — 1 = Standard temperature charging 1

ST2CHG — 1 = Standard temperature charging 2

HTCHG — 1 = Low temperature charging

CB — 1 = Cell balancing in progress

PCMTO — 1 = Precharge timeout fault

FCMTO — 1 = Fast-charge timeout fault

OCHGV — 1 = Overcharge voltage fault

OCHGI — 1 = Overcharge current fault

OC — 1 = Overcharge fault

XCHGLV — 1 = Battery is depleted

B.11 FETStatus(0x56)

This read-word function allows display of the FET status in either unsealed or sealed mode.

	bit 7	bit 6	bit 5	bit 4	bit 3	bit 2	bit 1	bit 0
FETControl	RSVD	RSVD	RSVD	RSVD	ZVCHG	CHG	DSG	RSVD

LEGEND: RSVD = Reserved

Figure B-8. FETStatus**ZVCHG** — (Pre-Charge) charge FET Status

0 = Pre-charge FET is OFF

1 = Pre-charge FET is ON

CHG — Charge FET Status

0 = CHG FET is OFF

1 = CHG FET is ON

DSG — Discharge FET Status

0 = DSG FET is OFF

1 = DSG FET is ON

B.12 ResetData(0x57)

This read-word function returns the number of partial resets (low byte) and full resets (high byte) the device has experienced.

Table B-3. ResetData

SBS Cmd.	Mode	Name			Format	Size in Bytes	Min Value	Max Value	Default Value	Unit
0x57	R	ResetData	partial resets	low byte	unsigned integer	1	0	255	—	
			full resets	high byte	unsigned integer	1	0	255	—	

B.13 WDRResetData(0x58)

This read-word function returns the number of watchdog resets the device has experienced.

Table B-4. WDRResetData

SBS Cmd.	Mode	Name	Format	Size in Bytes	Min Value	Max Value	Default Value	Unit
0x58	R	WDRResetData	unsigned integer	2	0	65535	—	

B.14 PackVoltage(0x5a)

This read-word function returns an unsigned integer value representing the measure voltage from the PACK pin, in mV, with a range of 0 to 65535. **AFE Pack Gain** is the scale factor for the *PackVoltage*.

Table B-5. PackVoltage

SBS Cmd.	Mode	Name	Format	Size in Bytes	Min Value	Max Value	Default Value	Unit
0x5a	R	PackVoltage	unsigned integer	2	0	65535	—	mV

Related Variables:

- Calibration:Data:AFE Pack Gain

B.15 AverageVoltage(0x5d)

This read-word function returns an unsigned integer value that approximates a one-minute rolling average of the sum of the cell voltages in mV, with a range of 0 to 65535.

Table B-6. AverageVoltage

SBS Cmd.	Mode	Name	Format	Size in Bytes	Min Value	Max Value	Default Value	Unit
0x5d	R	AverageVoltage	unsigned integer	2	0	65535	—	mV

Related Variables:

- SBS:Voltage

B.16 TS1Temperature (0x5E)

This read-block function returns the TS1 temperature reading.

Table B-7. TS1Temperature

SBS Cmd.	Mode	Name	Format	Size in Bytes	Min Value	Max Value	Default Value	Unit
0x5E	R	TS1Temperature	Integer	2	-400	1200	—	0.1°C

B.17 TS2Temperature (0x5F)

This read-block function returns the TS2 temperature reading.

Table B-8. TS2Temperature

SBS Cmd.	Mode	Name	Format	Size in Bytes	Min Value	Max Value	Default Value	Unit
0x5F	R	TS2Temperature	Integer	2	-400	1200	—	0.1°C

B.18 UnSealKey(0x60)

This read- or write-block command allows the user to change the Unseal key for the Sealed-to-Unsealed security-state transition. This function is only available when the bq3055 is in the Full-Access mode, indicated by a cleared *[FAS]* flag.

The order of the bytes, when entered in *ManufacturerAccess*, is the reverse of what is written to or read from the part. For example, if the 1st and 2nd word of the *UnSealKey* block read returns 0x1234 and 0x5678, then in *ManufacturerAccess*, 0x3412 and 0x7856 should be entered to unseal the part.

Table B-9. UnSealKey

SBS Cmd.	Mode	Name	Format	Size in Bytes	Min Value	Max Value	Default Value	Unit
0x60	R/W	UnSealKey	hex	4	0x00000000	0xffffffff	—	

Related Variables:

- SBS:OperationStatus[FAS]

B.19 FullAccessKey(0x61)

This read- or write-block command allows the user to change the Full-Access security key for the Unsealed-to-Full-Access security-state transition. This function is only available when the bq3055 is in the Full-Access mode, indicated by a cleared *[FAS]* flag.

The order of the bytes, when entered in *ManufacturerAccess*, is the reverse of what is written to or read from the part. For example, if the 1st and 2nd word of the *FullAccessKey* block read returns 0x1234 and 0x5678, then in *ManufacturerAccess*, 0x3412 and 0x7856 should be entered to put the part in full access mode.

Table B-10. FullAccessKey

SBS Cmd.	Mode	Name	Format	Size in Bytes	Min Value	Max Value	Default Value	Unit
0x61	R/W	FullAccessKey	hex	4	0x00000000	0xffffffff	—	

Related Variables:

- SBS:OperationStatus[FAS]

B.20 PFKey(0x62)

This read- or write-block command allows the user to change the Permanent-Failure-Clear key. This function is only available when the bq3055 is in the Full Access mode, indicated by a cleared *[FAS]* flag.

The order of the bytes, when entered in *ManufacturerAccess*, is the reverse of what is written to or read from the part. For example, if the 1st and 2nd word of the *PFKey* block read returns 0x1234 and 0x5678, then in *ManufacturerAccess*, 0x3412 and 0x7856 should be entered to clear a permanent failure.

Table B-11. PFKey

SBS Cmd.	Mode	Name	Format	Size in Bytes	Min Value	Max Value	Default Value	Unit
0x62	R/W	PFKey	hex	4	0x00000000	0xffffffff	—	

Related Variables:

- SBS:OperationStatus[FAS]

B.21 AuthenKey3(0x63)

This read- or write-block command stores Byte 12–Byte 15 of the 16 Byte long authentication key. This function is only available when the bq3055 is in the Full Access mode, indicated by a cleared *[FAS]* flag.

Table B-12. AuthenKey3

SBS Cmd.	Mode	Name	Format	Size in Bytes	Min Value	Max Value	Default Value	Unit
0x63	R/W	AuthenKey3	hex	4	0x00000000	0xffffffff	0x10325476	

Related Variables:

- SBS:AuthenKey2
- SBS:AuthenKey1
- SBS:AuthenKey0

B.22 AuthenKey2(0x64)

This read- or write-block command stores Byte 8–Byte 11 of the 16 Byte long authentication key. This function is only available when the bq3055 is in the Full Access mode, indicated by a cleared *[FAS]* flag.

Table B-13. AuthenKey2

SBS Cmd.	Mode	Name	Format	Size in Bytes	Min Value	Max Value	Default Value	Unit
0x64	R/W	AuthenKey2	hex	4	0x00000000	0xffffffff	0x98abdcfe	

Related Variables:

- SBS:AuthenKey3
- SBS:AuthenKey1
- SBS:AuthenKey0

B.23 AuthenKey1(0x65)

This read- or write-block command stores Byte 4–Byte 7 of the 16 Byte long authentication key. This function is only available when the bq3055 is in the Full Access mode, indicated by a cleared *[FAS]* flag.

Table B-14. AuthenKey1

SBS Cmd.	Mode	Name	Format	Size in Bytes	Min Value	Max Value	Default Value	Unit
0x65	R/W	AuthenKey1	hex	4	0x00000000	0xffffffff	0xdfceab89	

Related Variables:

- SBS:AuthenKey3
- SBS:AuthenKey2
- SBS:AuthenKey0

B.24 AuthenKey0(0x66)

This read- or write-block command stores Byte 0–Byte 3 of the 16 Byte long authentication key. This function is only available when the bq3055 is in the Full Access mode, indicated by a cleared *[FAS]* flag.

Table B-15. AuthenKey0

SBS Cmd.	Mode	Name	Format	Size in Bytes	Min Value	Max Value	Default Value	Unit
0x66	R/W	AuthenKey0	hex	4	0x00000000	0xffffffff	0x67452301	

Related Variables:

- SBS:AuthenKey3
- SBS:AuthenKey2
- SBS:AuthenKey1

B.25 ManufacturerInfo(0x70)

This read/write block function returns the data stored in **Manuf. Info** where byte 0 is the MSB with a maximum length of 31 data + 1 length byte. When the bq3055 is in Unsealed or Full Access mode, this block is read/write. When the bq3055 is in Sealed mode, this block is read only.

Table B-16. ManufacturerInfo

SBS Cmd.	Mode	Name	Format	Size in Bytes	Min Value	Max Value	Default Value	Unit
0x70	R/W	ManufacturerInfo	String	31+1	—	—	—	

Related Variables:

- DF:System Data:Manufacturer Info:Manuf. Info
- SBS:OperationStatus[SS],[FAS]

B.26 SenseResistor(0x71)

This read- or write-word command allows the user to change the sense resistor value used in $\mu\Omega$. The bq3055 automatically updates the respective calibration data on receipt of a new sense resistor value.

Table B-17. SenseResistor

SBS Cmd.	Mode	Name	Format	Size in Bytes	Min Value	Max Value	Default Value	Unit
0x71	R/W	SenseResistor	unsigned integer	2	0	65535	10000	μΩ

B.27 TempRange(0x72)

This read-word function returns the present temperature range in effect.

	Bit 7	Bit 6	Bit 5	Bit 4	Bit 3	Bit 2	Bit 1	Bit 0
High Byte	RSVD	RSVD	RSVD	RSVD	RSVD	RSVD	RSVD	RSVD
Low Byte	RSVD	RSVD	TR5	TR4	TR3	TR2A	TR2	TR1

LEGEND: All values read-only. RSVD = Reserved

Figure B-9. TempRange

- **TR1 – 1** = temperature range 1: *Temperature < JT1*
- **TR2 – 1** = temperature range 2: *JT1 < Temperature < JT2*
- **TR2A – 1** = temperature range 3: *JT2 < Temperature < JT2a*
- **TR3 – 1** = temperature range 4: *JT2a < Temperature < JT3*
- **TR4 – 1** = temperature range 5: *JT3 < Temperature < JT4*
- **TR5 – 1** = temperature range 6: *JT4 < Temperature*

B.28 ManufacturerStatus(0x74)

This read-word function returns the current operation status of the bq3055.

	bit 7	bit 6	bit 5	bit 4	bit 3	bit 2	bit 1	bit 0
High Byte	RSVD	RSVD	RSVD	RSVD	RSVD	RSVD	RSVD	RSVD
Low Byte	RSVD	RSVD	RSVD	RSVD	RSVD	RSVD	RSVD	CAL STATUS

LEGEND: All Values Read-Only; RSVD = Reserved

Figure B-10. ManufacturerStatus

CAL STATUS — indicates if permissions are enabled or disabled to allow gauge to enter calibration mode

0 = Calibration mode not allowed

1 = Calibration mode allowed

B.29 Extended SBS Command Values

Table B-18. EXTENDED SBS COMMANDS

SBS Cmd	Mode	Name	Format	Size in Bytes	Min Value	Max Value	Default Value	Unit
0x45	R	AFEDData	String	11+1	—	—	—	ASCII
0x46	R/W	FETControl	hex	1	0x00	0x1e	—	
0x47	R	PendingEDV	unsigned int	2	0	65535	—	mV
0x4f	R	StateOfHealth	unsigned int	1	0	100	—	%
0x50	R	SafetyAlert	hex	2	0x0000	0xffff	—	
0x51	R	SafetyStatus	hex	2	0x0000	0xffff	—	
0x52	R	PFAAlert	hex	2	0x0000	0x9fff	—	
0x53	R	PFStatus	hex	2	0x0000	0x9fff	—	
0x54	R	OperationStatus	hex	2	0x0000	0xffff	—	
0x55	R	ChargingStatus	hex	2	0x0000	0xffff	—	

Table B-18. EXTENDED SBS COMMANDS (continued)

SBS Cmd	Mode	Name	Format	Size in Bytes	Min Value	Max Value	Default Value	Unit
0x57	R	ResetData	hex	2	0x0000	0xffff	—	
0x58	R	WDRResetData	unsigned int	2	0	65535	—	
0x5a	R	PackVoltage	unsigned int	2	0	65535	—	mV
0x5d	R	AverageVoltage	unsigned int	2	0	65535	—	mV
0x60	R/W	UnSealKey	hex	4	0x00000000	0xffffffff	—	
0x61	R/W	FullAccessKey	hex	4	0x00000000	0xffffffff	—	
0x62	R/W	PFKey	hex	4	0x00000000	0xffffffff	—	
0x63	R/W	AuthenKey3	hex	4	0x00000000	0xffffffff	—	
0x64	R/W	AuthenKey2	hex	4	0x00000000	0xffffffff	—	
0x65	R/W	AuthenKey1	hex	4	0x00000000	0xffffffff	—	
0x66	R/W	AuthenKey0	hex	4	0x00000000	0xffffffff	—	
0x70	R/W	ManufacturerInfo	String	8+1	—	—	—	ASCII
0x71	R/W	SenseResistor	unsigned int	2	0	65535	—	$\mu\Omega$
0x72	R	TempRange	unsigned int	2	0	65535	—	0.1°K
0x74	R	ManufacturerStatus	hex	2	0x0000	0x0001	—	

Data Flash

CAUTION

Care should be taken when mass programming the data flash space using previous versions of data flash memory map files (such as *.gg files) to make sure that all public locations are updated correctly.

Data Flash can only be updated if $Voltage \geq \text{Flash Update OK Voltage}$ or $PackVoltage \geq \text{Flash Update OK Voltage}$. Data flash reads and writes are verified according to the method detailed in [Section 1.3](#).

Note: Data Flash updates are disabled when the *[PF] SafetyStatus* flag is set.

C.1 Accessing Data Flash

In different security modes, the data flash access conditions change. See [Section A.1](#) and [Section 1.7](#) for further details.

SECURITY MODE	NORMAL DATA FLASH ACCESS
BootROM	N/A
Full Access	R/W
Unsealed	R/W
Sealed	N/A

C.1.1 Data Flash Interface

The bq3055 data flash is organized into rows where each data flash variable is assigned an offset within its row.

Note: Data Flash commands are NACKed if the bq3055 is in sealed mode (*[SS]* flag is set).

Reading and writing data flash row data are block operations, which are each 32 bytes long.

None of the values written are bounded by the bq3055 and the values are not rejected by the gas gauge.

Writing an incorrect value may result in hardware failure due to firmware program interpretation of the invalid data. The data written is persistent, so a Power On Reset does resolve the fault.

Related Variables:

- ManufacturerAccess
- SBS:ManufacturerInput

C.1.2 Reading a Data Flash Row

Information required:

- DFRowAddress
- Variable Offset

Procedure:

1. Write the data flash row address to bq3055 using *DFRowAddress(0x01yy)* command to *ManufacturerAccess(0x00)*.

2. Read a block of data using *ManufacturerInput(0x2f)* command. Each row can hold up to 32 bytes of data.
3. Specific bytes within the block can be parsed or accessed using the correct variable offset.

C.1.3 Writing a Data Flash Row

Information required:

- DFRowAddress
- Variable Offset
- 32- byte data block

Procedure:

1. Write the data flash row address to bq3055 using *DFRowAddress(0x01yy)* command to *ManufacturerAccess(0x00)*.
2. Read a block of data using *ManufacturerInput(0x2f)* command and store in local memory. Each row can hold up to 32 bytes of data.
3. Modify specific bytes within the 32-byte block based on the variable offset noted earlier.
4. Write the modified block of data from local memory back to data flash using *ManufacturerInput(0x2ff)* command. A full 32-byte block of data must be written to the selected data flash row address.

C.2 Calibration

C.2.1 Data

C.2.1.1 CC Gain

CC Gain sets the mA current scale factor for the Coulomb Counter. Use calibration routines to set this value.

Table C-1. CC Gain

Subclass Name	Name	Format	Size in Bytes	Min Value	Max Value	Default Value	Unit
Data	CC Gain	floating point	4	0.1	4	0.9419	

Related Variables:

- SBS:Current

C.2.1.2 CC Delta

CC Delta sets the mAh capacity scale factor for the Coulomb Counter. Use calibration routines to set this value.

Table C-2. CC Delta

Subclass Name	Name	Format	Size in Bytes	Min Value	Max Value	Default Value	Unit
Data	CC Delta	floating point	4	29826	1193046	280932.6	

Related Variables:

- SBS:RemainingCapacity
- SBS:FullChargeCapacity

C.2.1.3 VC1 K-factor

This register value stores the ADC voltage translation factor for the bottom cell (Cell 1), which is connected between the VC4 and VSS pins. By default, this value is not used and the factory calibration are in effective. This value overrides the factory calibration when **K-factor Override Flag** is set to 0x9669 by the software voltage calibration process.

Table C-3. VC1 K-factor

Subclass Name	Name	Format	Size in Bytes	Min Value	Max Value	Default Value	Unit
Data	VC1 K-factor	signed integer	2	0	32767	20500	

Related Variables:

- SBS:CellVoltage4

C.2.1.4 VC2 K-factor

This register value stores the ADC voltage translation factor for Cell 2, which is connected between the VC3 and VC4 pins. By default, this value is not used and the factory calibration are in effective. This value overrides the factory calibration when **K-factor Override Flag** is set to 0x9669 by the software voltage calibration process.

Table C-4. VC2 K-factor

Subclass Name	Name	Format	Size in Bytes	Min Value	Max Value	Default Value	Unit
Data	VC2 K-factor	signed integer	2	0	32767	20500	

Related Variables:

- SBS:CellVoltage3

C.2.1.5 VC3 K-Factor

This register value stores the ADC voltage translation factor for Cell 3, which is connected between the VC2 and VC3 pins. By default, this value is not used and the factory calibration are in effective. This value overrides the factory calibration when **K-factor Override Flag** is set to 0x9669 by the software voltage calibration process.

Table C-5. VC3 K-factor

Subclass Name	Name	Format	Size in Bytes	Min Value	Max Value	Default Value	Unit
Data	VC3 K-factor	signed integer	2	0	32767	20500	

Related Variables:

- SBS:CellVoltage2

C.2.1.6 VC4 K-factor

This register value stores the ADC voltage translation factor for the top cell (Cell 4), which is connected between the VC1 and VC2 pins. By default, this value is not used and the factory calibration are in effective. This value overrides the factory calibration when **K-factor Override Flag** is set to 0x9669 by the software voltage calibration process.

Table C-6. VC4 K-factor

Subclass Name	Name	Format	Size in Bytes	Min Value	Max Value	Default Value	Unit
Data	VC4 K-factor	signed integer	2	0	32767	20500	

Related Variables:

- SBS:CellVoltage1

C.2.1.7 K-factor Override Flag

This register value is by default 0, indicating that the factory calibrated K-factors are being used. If this register is set to 0x9669, VC1~VC4 K-factors in the data flash are used for voltage translation.

Table C-7. K-factor Override Flag

Subclass Name	Name	Format	Size in Bytes	Min Value	Max Value	Default Value	Unit
Data	K-factor Override Flag	Hex	2	0	0xFFFF	0	

Related Variables:

- Calibration:Data:VC1 K-factor
- Calibration:Data:VC2 K-factor
- Calibration:Data:VC3 K-factor
- Calibration:Data:VC4 K-factor

C.2.1.8 AFE Pack Gain

This register value stores the scale factor for the *PackVoltage*, voltage measured at the PACK pin of the bq3055.

Table C-8. AFE Pack Gain

Subclass Name	Name	Format	Size in Bytes	Min Value	Max Value	Default Value	Unit
Data	AFE Pack Gain	unsigned integer	2	0	32767	24500	μV/cnt

Related Variables:

- SBS:PackVoltage

C.2.1.9 CC Offset

This register value stores the Coulomb Counter offset compensation. It is set during CC Offset calibration, or by automatic calibration of the bq3055 before the gauge enters sleep. It is not recommended to manually change this value.

Table C-9. CC Offset

Subclass Name	Name	Format	Size in Bytes	Min Value	Max Value	Default Value	Unit
Data	CC Offset	signed integer	2	-32768	32767	-1667	

C.2.1.10 Board Offset

This register value stores the compensation for the PCB dependant Coulomb Counter offset. It is recommended to use characterization data of the actual PCB to set this value.

Table C-10. Board Offset

Subclass Name	Name	Format	Size in Bytes	Min Value	Max Value	Default Value	Unit
Data	Board Offset	signed integer	2	-32768	32767	0	

Related Variables:

- Calibration:Data:CC Offset

C.2.1.11 Int Temp Offset

This register value stores the internal temperature sensor offset compensation. Use calibration routines to set this value.

Table C-11. Int Temp Offset

Subclass Name	Name	Format	Size in Bytes	Min Value	Max Value	Default Value	Unit
Data	Int Temp Offset	signed integer	1	-128	127	0	

Related Variables:

- DF:Configuration:Registers:Operation Cfg A[TEMP1], [TEMP0]
- SBS:Temperature

C.2.1.12 Ext1 Temp Offset

This register value stores the temperature sensor offset compensation for the external temperature sensor 1 connected at the TS1 pin of the bq3055. Use calibration routines to set this value.

Table C-12. Ext1 Temp Offset

Subclass Name	Name	Format	Size in Bytes	Min Value	Max Value	Default Value	Unit
Data	Ext1 Temp Offset	signed integer	1	-128	127	0	

Related Variables:

- DF:Configuration:Registers:Operation Cfg A[TEMP1], [TEMP0]
- SBS:Temperature

C.2.1.13 Ext2 Temp Offset

This register value stores the temperature sensor offset compensation for the external temperature sensor 2 connected at the TS2 pin of the bq3055. Use calibration routines to set this value.

Table C-13. Ext2 Temp Offset

Subclass Name	Name	Format	Size in Bytes	Min Value	Max Value	Default Value	Unit
Data	Ext2 Temp Offset	signed integer	1	-128	127	0	

Related Variables:

- DF:Configuration:Registers:Operation Cfg A[TEMP1], [TEMP0]
- SBS:Temperature

C.2.2 Config**C.2.2.1 CC Current**

This value sets the current used for the CC calibration when in calibration mode.

Table C-14. CC Current

Subclass Name	Name	Format	Size in Bytes	Min Value	Max Value	Default Value	Unit
Config	CC Current	unsigned integer	2	0	32767	3000	mA

Related Variables:

- SBS:Current

C.2.2.2 Voltage Signal

This value sets the voltage used for calibration when in calibration mode.

Table C-15. Voltage Signal

Subclass Name	Name	Format	Size in Bytes	Min Value	Max Value	Default Value	Unit
Config	Voltage Signal	unsigned integer	2	0	32767	12600	mV

Related Variables:

- SBS:Voltage

C.2.2.3 Temp Signal

This value sets the temperature used for the temperature calibration in calibration mode.

Table C-16. Temp Signal

Subclass Name	Name	Format	Size in Bytes	Min Value	Max Value	Default Value	Unit
Config	Temp Signal	unsigned integer	2	0	32767	2980	0.1K

Related Variables:

- SBS:Temperature

C.2.2.4 CC Offset Time

This value sets the time used for the CC Offset calibration in calibration mode. More time means more accuracy. The legitimate values for this constant are integer multiples of 250. Numbers less than 250 will cause a CC offset calibration error. Numbers greater than 250 will be rounded down to the nearest multiple of 250.

Table C-17. CC Offset Time

Subclass Name	Name	Format	Size in Bytes	Min Value	Max Value	Default Value	Unit
Config	CC Offset Time	unsigned integer	2	0	65535	250	ms

Related Variables:

- Calibration:Data:CC Offset

C.2.2.5 ADC Offset Time

This constant defines the time for the ADC Offset calibration in calibration mode. More time means more accuracy. The legitimate values for this constant are integer multiples of 32. Numbers less than 32 will cause an ADC offset calibration error. Numbers greater than 32 will be rounded down to the nearest multiple of 32.

Table C-18. ADC Offset Time

Subclass Name	Name	Format	Size in Bytes	Min Value	Max Value	Default Value	Unit
Config	ADC Offset Time	unsigned integer	2	0	65535	32	ms

C.2.2.6 CC Gain Time

This constant defines the time for the CC Gain calibration in calibration mode. More time means more accuracy. The legitimate values for this constant are integer multiples of 250. Numbers less than 250 will cause a CC gain calibration error. Numbers greater than 250 will be rounded down to the nearest multiple of 250.

Table C-19. CC Gain Time

Subclass Name	Name	Format	Size in Bytes	Min Value	Max Value	Default Value	Unit
Config	CC Gain Time	unsigned integer	2	0	65535	250	ms

Related Variables:

- Calibration:Data:CC Gain

C.2.2.7 Voltage Time

This constant defines the time for the voltage calibration in calibration mode. More time means more accuracy. The legitimate values for this constant are integer multiples of 1984. Numbers less than 1984 will cause a voltage calibration error. Numbers greater than 1984 will be rounded down to the nearest multiple of 1984.

Table C-20. Voltage Time

Subclass Name	Name	Format	Size in Bytes	Min Value	Max Value	Default Value	Unit
Config	Voltage Time	unsigned integer	2	0	65535	1888	ms

Related Variables:

- SBS:Voltage

C.2.2.8 Temperature Time

This constant defines the time for the temperature calibration in calibration mode. More time means more accuracy. The legitimate values for this constant are integer multiples of 32. Numbers less than 32 will cause a temperature calibration error. Numbers greater than 32 will be rounded down to the nearest multiple of 32.

Table C-21. Temperature Time

Subclass Name	Name	Format	Size in Bytes	Min Value	Max Value	Default Value	Unit
Config	Temperature Time	unsigned integer	2	0	65535	32	ms

Related Variables:

- Calibration:Data:Int Temp Offset
- Calibration:Data:Ext1 Temp Offset
- Calibration:Data:Ext2 Temp Offset
- SBS:Temperature

C.2.2.9 Cal Mode Timeout

The bq3055 will exit calibration mode automatically after a **Cal Mode Timeout** period.

Table C-22. Cal Mode Timeout

Subclass Name	Name	Format	Size in Bytes	Min Value	Max Value	Default Value	Unit
Config	Cal Mode Timeout	unsigned integer	2	0	65535	38400	s/128

Related Variables:

- SBS:ManufacturerAccess:Calibration Mode

C.2.3 Temp Model**C.2.3.1 Ext Coef a1..a5, b1..b4, Ext rc0, Ext adc0**

These values characterize the external thermistor connected to the TS1 pin or the TS2 pin of the bq3055. The default values characterize the Semitec 103AT NTC thermistor. Do not modify these values without consulting TI.

Table C-23. Ext Coef a1..a5, b1..b4, Ext rc0, Ext adc0

Subclass Name	Name	Format	Size in Bytes	Min Value	Max Value	Default Value	Unit
Temp Model	Ext Coef a1	signed integer	2	-32768	32767	-11130	num
	Ext Coef a2					19142	
	Ext Coef a3					-19262	
	Ext Coef a4					28203	
	Ext Coef a5					892	
	Ext Coef b1					328	
	Ext Coef b2					-605	
	Ext Coef b3					-3443	
	Ext Coef b4					4696	
	Ext rc0					87	
	Ext adc0					17740	

C.2.3.2 Rpad, Rint

These values characterize the pad and the internal resistance of the bq3055. Do not modify these values without consulting TI.

Table C-24. Pad Resistance and Int Resistance

Subclass Name	Name	Format	Size in Bytes	Min Value	Max Value	Default Value	Unit
Temp Model	Rpad	signed integer	2	-32768	32767	87	num
	Rint					17740	

C.2.3.3 Int Coef 1..4, Int Min AD, Int Max Temp

These values characterize the internal thermistor of the bq3055. Do not modify these values without consulting TI.

Table C-25. Int Coef 1..4, Int Min AD, Int Max Temp

Subclass Name	Name	Format	Size in Bytes	Min Value	Max Value	Default Value	Unit
Temp Model	Int Coef 1	signed integer	2	-32768	32767	0	s
	Int Coef 2					0	
	Int Coef 3					-11136	
	Int Coef 4					5754	
	Int Min AD					0	
	Int Max Temp					5754	

C.2.4 Current

C.2.4.1 Filter

Filter defines the filter constant used in the *AverageCurrent* calculation:

$$AverageCurrent_{new} = a \times AverageCurrent_{old} + (1-a) \times Current$$

with:

$$a = \langle Filter \rangle / 256; \text{ the time constant} = 1 \text{ sec} / \ln(1/a) \text{ (default 14.5 s)}$$

Table C-26. Filter

Subclass Name	Name	Format	Size in Bytes	Min Value	Max Value	Default Value	Unit
Current	Filter	unsigned integer	1	0	255	239	mA

Related Variables:

- SBS:Current
- SBS:AverageCurrent

C.2.4.2 Deadband

Any current within \pm **Deadband** will be reported as 0 mA by the *Current* function.

Table C-27. Deadband

Subclass Name	Name	Format	Size in Bytes	Min Value	Max Value	Default Value	Unit
Current	Deadband	unsigned integer	1	0	255	3	mA

Related Variables:

- SBS:Current

C.2.4.3 CC Deadband

This constant defines the deadband voltage for the measured voltage between the SR1 and SR2 pins used for capacity accumulation in units of 294 nV. Any voltages within \pm **CC Deadband** do not contribute to capacity accumulation.

Table C-28. CC Deadband

Subclass Name	Name	Format	Size in Bytes	Min Value	Max Value	Default Value	Unit
Current	CC Deadband	unsigned integer	1	0	255	34	294 nV

Related Variables:

- SBS:RemainingCapacity

C.3 System Data**C.3.1 Manufacturer Data****C.3.1.1 Pack Lot Code**

The *ManufacturerData* function reports **Pack Lot Code** as part of its return value.

Table C-29. Pack Lot Code

Subclass Name	Name	Format	Size in Bytes	Min Value	Max Value	Default Value	Unit
Manufacturer Data	Pack Lot Code	hex	2	0x0000	0xffff	0x0000	

Related Variables:

- SBS:ManufacturerData

C.3.1.2 PCB Lot Code

The *ManufacturerData* function reports **PCB Lot Code** as part of its return value.

Table C-30. PCB Lot Code

Subclass Name	Name	Format	Size in Bytes	Min Value	Max Value	Default Value	Unit
Manufacturer Data	PCB Lot Code	hex	2	0x0000	0xffff	0x0000	

Related Variables:

- SBS:ManufacturerData

C.3.1.3 Firmware Version

The *ManufacturerData* function reports **Firmware Version** as part of its return value.

Table C-31. Firmware Version

Subclass Name	Name	Format	Size in Bytes	Min Value	Max Value	Default Value	Unit
Manufacturer Data	Firmware Version	hex	2	0x0000	0xffff	0x0000	

Related Variables:

- SBS:ManufacturerData

C.3.1.4 Hardware Revision

The *ManufacturerData* function reports **Hardware Version** as part of its return value.

Table C-32. Hardware Revision

Subclass Name	Name	Format	Size in Bytes	Min Value	Max Value	Default Value	Unit
Manufacturer Data	Hardware Revision	hex	2	0x0000	0xffff	0x0000	

Related Variables:

- SBS:ManufacturerData

C.3.1.5 Cell Revision

The *ManufacturerData* function reports **Cell Revision** as part of its return value.

Table C-33. Cell Revision

Subclass Name	Name	Format	Size in Bytes	Min Value	Max Value	Default Value	Unit
Manufacturer Data	Cell Revision	hex	2	0x0000	0xffff	0x0000	

Related Variables:

- SBS:ManufacturerData

C.3.2 Manufacturer Info**C.3.2.1 Manuf. Info**

The *ManufacturerInfo* function returns the string stored in **Manuf. Info**. The maximum text length is 31 characters.

Table C-34. Manuf. Info

Subclass Name	Name	Format	Size in Bytes	Min Value	Max Value	Default Value	Unit
Manufacturer Info	Manuf. Info	string	31 + 1	—	—	0123456789ab cdef012345678 9abcde	

Related Variables:

- SBS:ManufacturerInfo

C.3.3 Lifetime Data

C.3.3.1 Lifetime Max Temp

If the [LTPF] flag is set **Lifetime Max Temp** value is updated if one of the following conditions are met:

- internal measurement temperature – **Lifetime Max Temp** > 1 °C.
- internal measurement temperature > **Lifetime Max Temp** for a period > 60 seconds
- internal measurement temperature > **Lifetime Max Temp** AND any other lifetime value is updated.

Table C-35. Lifetime Max Temp

Subclass Name	Name	Format	Size in Bytes	Min Value	Max Value	Default Value	Unit
Lifetime Data	Lifetime Max Temp	signed integer	2	0	1400	300	0.1°C

Related Variables:

- SBS:ManufacturerAccess:LTPF Enable
- SBS:OperationStatus[LTPF]

C.3.3.2 Lifetime Min Temp

If the [LTPF] flag is set **Lifetime Min Temp** is updated if one of the following conditions are met:

- **Lifetime Min Temp** – internal measurement temperature > 1 °C.
- **Lifetime Min Temp** > internal measurement temperature for a period > 60 seconds
- **Lifetime Min Temp** > internal measurement temperature > AND any other lifetime value is updated.

Table C-36. Lifetime Min Temp

Subclass Name	Name	Format	Size in Bytes	Min Value	Max Value	Default Value	Unit
Lifetime Data	Lifetime Min Temp	signed integer	2	-600	1400	200	0.1°C

Related Variables:

- SBS:ManufacturerAccess:LTPF Enable
- SBS:OperationStatus[LTPF]

C.3.3.3 Lifetime Max Cell Voltage

If the [LTPF] flag is set **Lifetime Max Cell Voltage** is updated if one of the following conditions are met:

- Any internally measured cell voltage–**Lifetime Max Cell Voltage** > 25 mV
- Any internally measured cell voltage > **Lifetime Max Cell Voltage** for a period > 60 seconds
- Any internally measured cell voltage **Lifetime Max Cell Voltage** AND any other lifetime value is updated.

Table C-37. Lifetime Max Cell Voltage

Subclass Name	Name	Format	Size in Bytes	Min Value	Max Value	Default Value	Unit
Lifetime Data	Lifetime Max Cell Voltage	signed integer	2	-32768	32767	3500	mV

Related Variables:

- SBS:ManufacturerAccess:LTPF Enable
- SBS:OperationStatus[LTPF]

C.3.3.4 Lifetime Min Cell Voltage

If the [LTPF] flag is set **Lifetime Min Cell Voltage** is updated if one of the following conditions are met:

- **Lifetime Min Cell Voltage** – any internally measured cell voltage > 25 mV
- **Lifetime Min Cell Voltage** > any internally measured cell voltage for a period > 60 seconds
- **Lifetime Min Cell Voltage** > any internally measured cell voltage AND any other lifetime value is updated.

Table C-38. Lifetime Min Cell Voltage

Subclass Name	Name	Format	Size in Bytes	Min Value	Max Value	Default Value	Unit
Lifetime Data	Lifetime Min Cell Voltage	signed integer	2	-32768	32767	3200	mV

Related Variables:

- SBS:ManufacturerAccess:LTPF Enable
- SBS:OperationStatus[LTPF]

C.4 SBS Configuration
C.4.1 Data
C.4.1.1 Rem Cap Alarm

When [CapM] in *BatteryStatus* is set to 0, the default value of *RemainingCapacityAlarm* is stored in **Rem Cap Alarm** and copied to the SBS value upon bq3055 initialization.

Table C-39. Rem Cap Alarm

Subclass Name	Name	Format	Size in Bytes	Min Value	Max Value	Default Value	Unit
Data	Rem Cap Alarm	unsigned integer	2	0	700	300	mAh

Related Variables:

- SBS:RemainingCapacityAlarm

C.4.1.2 Rem Energy Alarm

When [CapM] in *BatteryStatus* is set to 1, the default value of *RemainingCapacityAlarm* is stored in **Rem Energy Alarm** and copied to the SBS value upon the bq3055 initialization.

Table C-40. Rem Energy Alarm

Subclass Name	Name	Format	Size in Bytes	Min Value	Max Value	Default Value	Unit
Data	Rem Energy Alarm	unsigned integer	2	0	1000	432	10 mWh

Related Variables:

- SBS:RemainingCapacityAlarm

C.4.1.3 Rem Time Alarm

The default value of *RemainingTimeAlarm* is stored in **Rem Time Alarm** and copied to the SBS value upon bq3055 initialization.

Table C-41. Rem Time Alarm

Subclass Name	Name	Format	Size in Bytes	Min Value	Max Value	Default Value	Unit
Data	Rem Time Alarm	unsigned integer	2	0	30	10	min

Related Variables:

- SBS:RemainingTimeAlarm

C.4.1.4 Init Battery Mode

The default value of *BatteryMode* is stored in **Init Battery Mode** and copied to the SBS value upon bq3055 initialization.

Table C-42. Init Battery Mode

Subclass Name	Name	Format	Size in Bytes	Min Value	Max Value	Default Value	Unit
Data	Init Battery Mode	hex	2	0	0xffff	0x0081	

Related Variables:

- SBS:BatteryMode

C.4.1.5 Design Voltage

The default value of *DesignVoltage* is stored in **Design Voltage** and copied to the SBS value upon bq3055 initialization.

Table C-43. Design Voltage

Subclass Name	Name	Format	Size in Bytes	Min Value	Max Value	Default Value	Unit
Data	Design Voltage	unsigned integer	2	7000	18000	10800	mV

Related Variables:

- SBS:DesignVoltage

C.4.1.6 Spec Info

The default value of *SpecificationInfo* is stored in **Spec Info** and copied to the SBS value upon bq3055 initialization.

Table C-44. Spec Info

Subclass Name	Name	Format	Size in Bytes	Min Value	Max Value	Default Value	Unit
Data	Spec Info	hex	2	0x0000	0xffff	0x0031	

Related Variables:

- SBS:SpecificationInfo

C.4.1.7 Manuf Date

The default value of *ManufacturerDate* is stored in **Manuf Date** and copied to the SBS value upon bq3055 initialization.

Table C-45. Manuf Date

Subclass Name	Name	Format	Size in Bytes	Min Value	Max Value	Default Value	Unit
Data	Manuf Date	unsigned integer	2	0	65535	0	Day + Mo*32 + (Yr-1980)*512

Related Variables:

- SBS:ManufactureDate

C.4.1.8 Ser. Num.

The default value of *SerialNumber* is stored in **Ser. Num.** and copied to the SBS value upon bq3055 initialization.

Table C-46. Ser. Num.

Subclass Name	Name	Format	Size in Bytes	Min Value	Max Value	Default Value	Unit
Data	Ser. Num.	hex	2	0x0000	0xffff	0x0001	

Related Variables:

- SBS:SerialNumber

C.4.1.9 Cycle Count

The default value of *CycleCount* is stored in **Cycle Count** and copied to the SBS value upon bq3055 initialization. When the SBS value changes **Cycle Count** is also updated.

Table C-47. Cycle Count

Subclass Name	Name	Format	Size in Bytes	Min Value	Max Value	Default Value	Unit
Data	Cycle Count	unsigned integer	2	0	65535	0	Count

Related Variables:

- DF:Configuration:Registers:Operation Cfg B[CCT]
- DF:SBS Configuration:Data:CC Threshold
- DF:SBS Configuration:Data:CC %
- SBS:CycleCount

C.4.1.10 CC Threshold

If the *[CCT]* bit is cleared the cycle count function counts the accumulated discharge of the **CC Threshold** value as one cycle.

Table C-48. CC Threshold

Subclass Name	Name	Format	Size in Bytes	Min Value	Max Value	Default Value	Unit
Data	CC Threshold	signed integer	2	100	32767	4400	mAh

Related Variables:

- DF:Configuration:Registers:Operation Cfg B[CCT]
- SBS:CycleCount

C.4.1.11 CC %

If the *[CCT]* bit is set the cycle count function counts the accumulated discharge of (*FullChargeCapacity* x **CC %**) as one cycle. If (*FullChargeCapacity* x **CC %**) is smaller than **CC Threshold**, **CC Threshold** is used for counting.

Table C-49. CC %

Subclass Name	Name	Format	Size in Bytes	Min Value	Max Value	Default Value	Unit
Data	CC %	unsigned integer	1	0	100	90	%

Related Variables:

- DF:Configuration:Registers:Operation Cfg B[CCT]
- DF:SBS Configuration:Data:CC Threshold
- SBS:FullChargeCapacity
- SBS:CycleCount

C.4.1.12 CF Max Error Limit

If *MaxError* function value is greater than **CF Max Error Limit**, [CF] in *BatteryMode* is set.

Table C-50. CF Max Error Limit

Subclass Name	Name	Format	Size in Bytes	Min Value	Max Value	Default Value	Unit
Data	CF Max Error Limit	unsigned integer	1	0	100	100	%

Related Variables:

- SBS:BatteryMode[CF]
- SBS:MaxError

C.4.1.13 Design Capacity

If [CapM] in *BatteryMode* is set to 0, the *DesignCapacity* function reports **Design Capacity**.

Table C-51. Design Capacity

Subclass Name	Name	Format	Size in Bytes	Min Value	Max Value	Default Value	Unit
Data	Design Capacity	unsigned integer	2	0	65535	4400	mAh

Related Variables:

- DF:Gas Gauging:IT Config:Load Select
- SBS:BatteryMode[CapM]
- SBS:DesignCapacity
- SBS:StateOfHealth

C.4.1.14 Design Energy

If [CapM] in *BatteryMode* is set to 1, the *DesignCapacity* function reports **Design Energy**.

Table C-52. Design Energy

Subclass Name	Name	Format	Size in Bytes	Min Value	Max Value	Default Value	Unit
Data	Design Energy	unsigned integer	2	0	65535	4752	0.1 Wh

Related Variables:

- DF:Gas Gauging:IT Config:Load Select
- SBS:BatteryMode[CapM]
- SBS:DesignCapacity
- SBS:StateOfHealth

C.4.1.15 Full Charge Capacity

This value is used as the *Full Charge Capacity* at device reset. This value is updated by the CEDV gauging algorithm when battery voltage reaches EDV2. Initialize this value to Design Capacity.

Table C-53. Full Charge Capacity

Subclass Name	Name	Format	Size in Bytes	Min Value	Max Value	Default Value	Unit
Data	Full Charge Capacity	unsigned integer	2	0	65535	4400	mAh

Related Variables:

- SBS:FullChargeCapacity

C.4.1.16 DOD at EDV2

This value is updated by the CEDV gauging algorithm when battery voltage reaches EDV2. If **Battery Low %** is altered, the **DOD at EDV2** value should be set to $(1 - \text{Battery_Low\%}) \times 16384$, where $\text{Battery_Low\%} = \text{Battery Low \%} \div 2.56$. The firmware default value is 15232, which corresponds to a **Battery Low % = 18 (%/2.56)** (saved to the DF as 18 in unit of %/2.56).

Table C-54. DOD at EDV2

Subclass Name	Name	Format	Size in Bytes	Min Value	Max Value	Default Value	Unit
Data	DOD at EDV2	unsigned integer	2	0	16384	15232	

- DF:Gas Gauging:CEDV Cfg:Battery Low %

C.4.1.17 Manuf Name

The *ManufacturerName* function returns a string stored in **Manuf Name**. The maximum text length is 11 characters.

Table C-55. Manuf Name

Subclass Name	Name	Format	Size in Bytes	Min Value	Max Value	Default Value	Unit
Data	Manuf Name	string	11 + 1	—	—	Texas Inst.	ASCII

Related Variables:

- SBS:ManufacturerName

C.4.1.18 Device Name

The *DeviceName* function returns a string stored in **Device Name**. The maximum text length is 7 characters.

Table C-56. Device Name

Subclass Name	Name	Format	Size in Bytes	Min Value	Max Value	Default Value	Unit
Data	Device Name	string	7 + 1	—	—	bq3055	ASCII

Related Variables:

- SBS:DeviceName

C.4.1.19 Device Chemistry

The *DeviceChemistry* function returns a string stored in **Device Chemistry**. The maximum text length is 4 characters.

Table C-57. Device Chemistry

Subclass Name	Name	Format	Size in Bytes	Min Value	Max Value	Default Value	Unit
Data	Device Chemistry	string	4+1	—	—	LION	ASCII

Related Variables:

- SBS:DeviceChemistry

C.4.2 Configuration

C.4.2.1 TDA Set %

If set between 0% and 100% the bq3055 sets the *[TDA]* flag in *BatteryStatus* if the *RelativeStateOfCharge* reaches or falls below **TDA Set %**. Set to -1 to disable this function.

Table C-58. TDA Set %

Subclass Name	Name	Format	Size in Bytes	Min Value	Max Value	Default Value	Unit
Configuration	TDA Set %	signed integer	1	-1	100	6	%

Related Variables:

- SBS:RelativeStateOfCharge
- SBS:BatteryStatus[TDA]

C.4.2.2 TDA Clear %

If set between 0% and 100% the bq3055 clears the *[TDA]* flag in *BatteryStatus* if the *RelativeStateOfCharge* reaches or rises above **TDA Clear %**. Set to -1 to disable this function.

Table C-59. TDA Clear %

Subclass Name	Name	Format	Size in Bytes	Min Value	Max Value	Default Value	Unit
Configuration	TDA Clear %	signed integer	1	-1	100	8	%

Related Variables:

- SBS:RelativeStateOfCharge
- SBS:BatteryStatus[TDA]

C.4.2.3 FD Set %

If set between 0% and 100%, the bq3055 sets the *[FD]* flag in *BatteryStatus* if the *RelativeStateOfCharge* reaches or falls below **FD Set %**. Set to -1 to disable this function.

Table C-60. FD Set %

Subclass Name	Name	Format	Size in Bytes	Min Value	Max Value	Default Value	Unit
Configuration	FD Set %	signed integer	1	-1	100	2	%

Related Variables:

- SBS:RelativeStateOfCharge
- SBS:BatteryStatus[FD]

C.4.2.4 FD Clear %

If set between 0% and 100% the bq3055 clears the *[FD]* flag in *BatteryStatus* if the *RelativeStateOfCharge* reaches or rises above **FD Clear %**. Set to -1 to disable this function.

Table C-61. FD Clear %

Subclass Name	Name	Format	Size in Bytes	Min Value	Max Value	Default Value	Unit
Configuration	FC Clear %	signed integer	1	-1	100	5	%

Related Variables:

- SBS:RelativeStateOfCharge
- SBS:BatteryStatus[FD]

C.4.2.5 TDA Set Volt Threshold

The bq3055 sets the *[TDA]* flag in *BatteryStatus* if *Voltage* is equal to or lower than **TDA Set Volt Threshold** for a period equal to or greater than **TDA Set Volt Time**.

Table C-62. TDA Set Volt Threshold

Subclass Name	Name	Format	Size in Bytes	Min Value	Max Value	Default Value	Unit
Configuration	TDA Set Volt Threshold	unsigned integer	2	0	16800	3750	mV

Related Variables:

- DF:SBS Configuration:Configuration:TDA Set Volt Time
- SBS:Voltage
- SBS:BatteryStatus[TDA]

C.4.2.6 TDA Set Volt Time

The bq3055 sets the *[TDA]* flag in *BatteryStatus* if *Voltage* is equal to or lower than **TDA Set Volt Threshold** for a period equal to or greater than **TDA Set Volt Time**. Set to 0 to disable this feature.

Table C-63. TDA Set Volt Time

Subclass Name	Name	Format	Size in Bytes	Min Value	Max Value	Default Value	Unit
Configuration	TDA Set Volt Time	unsigned integer	1	0	240	5	s

Related Variables:

- DF:SBS Configuration:Configuration:TDA Set Volt Threshold
- SBS:Voltage
- SBS:BatteryStatus[TDA]

C.4.2.7 TDA Clear Volt

The bq3055 clears the *[TDA]* flag if *Voltage* is equal to or greater than **TDA Clear Volt**. **TDA Clear Volt** clears *[TDA]* only if *[TDA]* is set by **TDA Set Volt Threshold**. It will not clear *[TDA]* if *[TDA]* is set by **TDA Set %** or any other function.

Table C-64. TDA Clear Volt

Subclass Name	Name	Format	Size in Bytes	Min Value	Max Value	Default Value	Unit
Configuration	TDA Clear Volt	unsigned integer	2	0	16800	4125	mV

Related Variables:

- DF:SBS Configuration:Configuration:TDA Set Volt Threshold
- DF:SBS Configuration:Configuration:TDA Set Volt Time
- SBS:Voltage
- SBS:BatteryStatus[TDA]

C.4.2.8 FD Set Volt Threshold

The bq3055 sets the *[FD]* flag if *Voltage* is equal to or lower than **FD Set Volt Threshold** for a period equal to or greater than **FD Volt Time**.

Table C-65. FD Set Volt Threshold

Subclass Name	Name	Format	Size in Bytes	Min Value	Max Value	Default Value	Unit
Configuration	FD Set Volt Threshold	unsigned integer	2	0	16800	3750	mV

Related Variables:

- DF:SBS Configuration:Configuration:FD Volt Time
- SBS:Voltage
- SBS:BatteryStatus[FD]

C.4.2.9 FD Volt Time

The bq3055 sets the *[FD]* flag if *Voltage* is equal to or lower than **FD Set Volt Threshold** for a period equal to or greater than **FD Volt Time**. Set to 0 to disable this feature.

Table C-66. FD Volt Time

Subclass Name	Name	Format	Size in Bytes	Min Value	Max Value	Default Value	Unit
Configuration	FD Volt Time	unsigned integer	1	0	240	5	s

Related Variables:

- DF:SBS Configuration:Configuration:FD Set Volt Threshold
- SBS:Voltage
- SBS:BatteryStatus[FD]

C.4.2.10 FD Clear Volt

The bq3055 clears the *[FD]* flag if *Voltage* is equal to or greater than **FD Clear Volt**.

Table C-67. FD Clear Volt

Subclass Name	Name	Format	Size in Bytes	Min Value	Max Value	Default Value	Unit
Configuration	FD Clear Volt	unsigned integer	2	0	16800	4125	mV

Related Variables:

- DF:SBS Configuration:Configuration:FD Set Volt Threshold
- SBS:Voltage
- SBS:BatteryStatus[FD]

C.5 PF Status**C.5.1 Device Status Data****C.5.1.1 PF Flags 1**

The flags in the **PF Flags 1** register indicate the reason that the bq3055 has entered permanent failure. If the failure flag in **PF Flags 1** matches the bit in **Permanent Fail Cfg** the FUSE pin is driven high and the **Fuse Flags** is set to 0x3672. The FUSE pin can be used to blow an optional fuse in a severe failure condition to prevent more damage of the system.

All permanent failure flags in the failure sequence are stored in **PF Flags 1**. Only the first permanent failure flag in a failure sequence is stored in **PF Flags 2** to indicate the cause of the permanent failure.

Table C-68. PF Flags 1

Subclass Name	Name	Format	Size in Bytes	Min Value	Max Value	Default Value	Unit
Device Status Data	PF Flags 1	hex	2	0x0000	0x8000	0x0000	

Related Variables:

- DF:PF Status:Device Status Data:PF Flags 2
- SBS:PFStatus

C.5.1.2 Fuse Flag

The **Fuse Flag** is set to 0x3672 when a 2nd level protection failure occurs and the matching bit is set in the **Permanent Fail Cfg** register. The FUSE pin is driven high

0x0000 = No Failure(default)

0x3672 = **Permanent Fail Cfg** flag matches **PF Flags 1** flag and FUSE pin is driven low

Table C-69. Fuse Flag

Subclass Name	Name	Format	Size in Bytes	Min Value	Max Value	Default Value	Unit
Device Status Data	Fuse Flag	hex	2	0x0000	0xffff	0x0000	

Related Variables:

- DF:Configuration:Registers:Permanent Fail Cfg
- DF:PF Status:Device Status Data:PF Flags 1

C.5.1.3 PF Voltage

When a permanent failure is detected *Voltage* is captured and stored into in **PF Voltage**.

Table C-70. PF Voltage

Subclass Name	Name	Format	Size in Bytes	Min Value	Max Value	Default Value	Unit
Device Status Data	PF Voltage	unsigned integer	2	0	32767	0	mV

Related Variables:

- SBS:Voltage

C.5.1.4 PF C4 Voltage

When a permanent failure is detected *CellVoltage4* is captured and stored in **PF C4 Voltage**.

Table C-71. PF C4 Voltage

Subclass Name	Name	Format	Size in Bytes	Min Value	Max Value	Default Value	Unit
Device Status Data	PF C4 Voltage	unsigned integer	2	0	9999	0	mV

Related Variables:

- SBS:CellVoltage4

C.5.1.5 PF C3 Voltage

When a permanent failure is detected *CellVoltage3* is captured and stored in **PF C3 Voltage**.

Table C-72. PF C3 Voltage

Subclass Name	Name	Format	Size in Bytes	Min Value	Max Value	Default Value	Unit
Device Status Data	PF C3 Voltage	unsigned integer	2	0	9999	0	mV

Related Variables:

- SBS:CellVoltage3

C.5.1.6 PF C2 Voltage

When a permanent failure is detected *CellVoltage2* is captured and stored in **PF C2 Voltage**.

Table C-73. PF C2 Voltage

Subclass Name	Name	Format	Size in Bytes	Min Value	Max Value	Default Value	Unit
Device Status Data	PF C2 Voltage	unsigned integer	2	0	9999	0	mV

Related Variables:

- SBS:CellVoltage2

C.5.1.7 PF C1 Voltage

When a permanent failure is detected *CellVoltage1* is captured and stored in **PF C1 Voltage**.

Table C-74. PF C1 Voltage

Subclass Name	Name	Format	Size in Bytes	Min Value	Max Value	Default Value	Unit
Device Status Data	PF C1 Voltage	unsigned integer	2	0	9999	0	mV

Related Variables:

- SBS:CellVoltage1

C.5.1.8 PF Current

When a permanent failure is detected the pack *Current* is captured and stored in **PF Current**.

Table C-75. PF Current

Subclass Name	Name	Format	Size in Bytes	Min Value	Max Value	Default Value	Unit
Device Status Data	PF Current	signed integer	2	-32768	32767	0	mA

Related Variables:

- SBS:Current

C.5.1.9 PF Temperature

When a permanent failure is detected the pack *Temperature* is captured and stored in **PF Temperature**.

Table C-76. PF Temperature

Subclass Name	Name	Format	Size in Bytes	Min Value	Max Value	Default Value	Unit
Device Status Data	PF Temperature	signed integer	2	-9999	9999	0	0.1 K

Related Variables:

- SBS:Temperature

C.5.1.10 PF Batt Stat

When a permanent failure is detected the *BatteryStatus* flags are captured and stored in **PF Batt Stat**.

Table C-77. PF Batt Stat

Subclass Name	Name	Format	Size in Bytes	Min Value	Max Value	Default Value	Unit
Device Status Data	PF Batt Stat	unsigned integer	2	0x0000	0xffff	0x0000	

Related Variables:

- SBS:BatteryStatus

C.5.1.11 PF RC-mAh

When a permanent failure is detected *RemainingCapacity*, in mAh, is captured and stored into in **PF RC-mAh**.

Table C-78. PF RC-mAh

Subclass Name	Name	Format	Size in Bytes	Min Value	Max Value	Default Value	Unit
Device Status Data	PF RC-mAh	unsigned integer	2	0	32767	0	mAh

Related Variables:

- SBS:BatteryMode[CapM]
- SBS:RemainingCapacity

C.5.1.12 PF FCC

When a permanent failure is detected FullChargeCapacity, in mAh, is captured and stored in **PF FCC**.

Table C-79. PF FCC

Subclass Name	Name	Format	Size in Bytes	Min Value	Max Value	Default Value	Unit
Device Status Data	PF FCC	unsigned integer	2	0	32767	0	mAh

Related Variables:

- SBS:BatteryMode[CapM]
- SBS:RemainingCapacity

C.5.1.13 PF Chg Status

When a permanent failure is detected the *ChargingStatus* flags are captured and stored in **PF Chg Status**.

Table C-80. PF Chg Status

Subclass Name	Name	Format	Size in Bytes	Min Value	Max Value	Default Value	Unit
Device Status Data	PF Chg Status	hex	2	0x0000	0xffff	0x0000	

Related Variables:

- SBS:ChargingStatus

C.5.1.14 PF Safety Status

When a permanent failure is detected, the *SafetyStatus* flags are captured and stored in **PF Safety Status**.

Table C-81. PF Safety Status

Subclass Name	Name	Format	Size in Bytes	Min Value	Max Value	Default Value	Unit
Device Status Data	PF Safety Status	hex	2	0x0000	0xffff	0x0000	

Related Variables:

- SBS:SafetyStatus

C.5.1.15 PF DOD

When a permanent failure is detected, DOD (Depth of Discharge), is captured and stored into **PF DOD**.

Table C-82. PF DOD

Subclass Name	Name	Format	Size in Bytes	Min Value	Max Value	Default Value	Unit
Device Status Data	PF DOD	signed integer	2	0	32767	0	

C.5.1.16 PF Flags 2

On the first occurrence of a permanent failure, when PFStatus changes from 0x0000, the *PFStatus* flags will be captured and stored in this value. Only the first permanent failure flag in a failure sequence is stored in **PF Flags 2** to indicate the cause of the permanent failure. All permanent failure flags in the failure sequence are stored in **PF Flags 1**.

Table C-83. PF Flags 2

Subclass Name	Name	Format	Size in Bytes	Min Value	Max Value	Default Value	Unit
Device Status Data	PF Flags 2	hex	2	0x0000	0x8000	0x0000	

Related Variables:

- DF:PF Status:Device Status Data:PF Flags 1
- SBS:PFStatus

C.5.2 AFE Regs

When the bq3055 detects a permanent failure a complete copy of the integrated AFE register values is stored **AFE Regs**.

Table C-84. AFE Regs

Subclass Name	Name	Format	Size in Bytes	Min Value	Max Value	Default Value	Unit
AFE Regs	AFE Status	hex	1	0x00	0xff	0x00	
	AFE State						
	AFE Output						
	AFE Output Status						
	AFE Cell Select						
	AFE OLV						
	AFE OLT						
	AFE SCC						
	AFE SCD						
AFE Function							

C.6 Gas Gauging

C.6.1 CEDV Cfg

C.6.1.1 CEDV Config

This register configures various features of the CEDV gauging.

Table C-85. CEDV Config

Subclass Name	Name	Format	Size in Bytes	Min Value	Max Value	Default Value	Unit
Gas Gauging	CEDV Config	hex	1	0x00	0x70	0x00	

	bit 7	bit 6	bit 5	bit 4	bit 3	bit 2	bit 1	bit 0
CEDV Config	0	RSVD	SC	CEDV	EDVV	RSVD	RSVD	RSVD

LEGEND: RSVD = Reserved and **must** be programmed to 0

Figure C-1. CEDV Config

SC — This bit enables learning cycle optimization for a Smart Charger or independent charge.

0 (default) = Learning cycle optimized for Smart Charger.

1 = Learning cycle optimized for independent charger.

CEDV — This bit determines whether the bq3055 implements automatic EDV compensation to calculate the EDV0, EDV1, and EDV2 thresholds base on rate, temperature, and capacity. If the bit is cleared, the bq3055 uses the fixed values programmed in data flash for EDV0, EDV1, and EDV2. If the bit is set, the bq3055 calculates EDV0, EDV1, and EDV2.

0 (default) = EDV compensation disabled.

1 = EDV compensation enabled.

EDVV — This bit selects whether EDV termination is to be done with regard to voltage or the lowest single-cell voltage.

0 (default) = EDV conditions determined on the basis of the lowest single-cell voltage.

1 = EDV conditions determined on the basis of Voltage.

C.6.1.2 EMF

This value is the no-load cell voltage higher than the highest cell EDV threshold computed.

Table C-86. EMF

Subclass Name	Name	Format	Size in Bytes	Min Value	Max Value	Default Value	Unit
CEDV Cfg	EMF	unsigned integer	2	0	65535	3743	mV

C.6.1.3 EDV C0 Factor

This value is the no-load, capacity related EDV adjustment factor.

Table C-87. C0

Subclass Name	Name	Format	Size in Bytes	Min Value	Max Value	Default Value	Unit
CEDV Cfg	C0	unsigned integer	2	0	65535	149	

C.6.1.4 EDV R0 Factor

This value is the first order rate dependency factor, accounting for battery impedance adjustment.

Table C-88. R0

Subclass Name	Name	Format	Size in Bytes	Min Value	Max Value	Default Value	Unit
CEDV Cfg	R0	unsigned integer	2	0	65535	867	

C.6.1.5 EDV T0 Rate Factor

This value adjusts the variation of impedance with battery temperature.

Table C-89. T0

Subclass Name	Name	Format	Size in Bytes	Min Value	Max Value	Default Value	Unit
CEDV Cfg	T0	unsigned integer	2	0	65535	4030	

C.6.1.6 EDV R1 Rate Factor

This value adjusts the variation of impedance with battery capacity.

Table C-90. R1

Subclass Name	Name	Format	Size in Bytes	Min Value	Max Value	Default Value	Unit
CEDV Cfg	R1	unsigned integer	2	0	65535	316	

C.6.1.7 EDV TC Factor

This value adjusts the variation of impedance for cold temperatures ($T < 23^{\circ}\text{C}$).

Table C-91. TC

Subclass Name	Name	Format	Size in Bytes	Min Value	Max Value	Default Value	Unit
CEDV Cfg	TC	unsigned integer	1	0	255	9	

C.6.1.8 EDV C1 Factor

This value is the desired reserved battery capacity remaining at EDV0.

Table C-92. C1

Subclass Name	Name	Format	Size in Bytes	Min Value	Max Value	Default Value	Unit
CEDV Cfg	C1	unsigned integer	1	0	255	0	

C.6.1.9 EDV Age Factor

This value allows the bq3055 to correct the EDV detection algorithm to compensate for cell aging.

Table C-93. Age Factor

Subclass Name	Name	Format	Size in Bytes	Min Value	Max Value	Default Value	Unit
CEDV Cfg	Age Factor	unsigned integer	1	0	255	0	

C.6.1.10 Fixed EDV0

This value is the EDV0 threshold if **[CEDV]** is clear in **CEDV Config**.

Table C-94. Fixed EDV0

Subclass Name	Name	Format	Size in Bytes	Min Value	Max Value	Default Value	Unit
CEDV Cfg	Fixed EDV0	unsigned integer	2	0	65535	3031	mV

C.6.1.11 Fixed EDV1

This value is the EDV1 threshold if **[CEDV]** is clear in **CEDV Config**.

Table C-95. Fixed EDV1

Subclass Name	Name	Format	Size in Bytes	Min Value	Max Value	Default Value	Unit
CEDV Cfg	Fixed EDV1	unsigned integer	2	0	65535	3385	mV

C.6.1.12 Fixed EDV2

This value is the EDV2 threshold if **[CEDV]** is clear in **CEDV Config**.

Table C-96. Fixed EDV2

Subclass Name	Name	Format	Size in Bytes	Min Value	Max Value	Default Value	Unit
CEDV Cfg	Fixed EDV2	unsigned integer	2	0	65535	3501	mV

C.6.1.13 Low Temp

This value specifies the minimum temperature above which a discharge must maintain to qualify for capacity learning.

Table C-97. Low Temp

Subclass Name	Name	Format	Size in Bytes	Min Value	Max Value	Default Value	Unit
CEDV Cfg	Low Temp	unsigned integer	1	0	255	119	0.1C

C.6.1.14 Overload Current

This value sets the upper current range for EDV detection, beyond which EDV detection is halted.

Table C-98. Overload Current

Subclass Name	Name	Format	Size in Bytes	Min Value	Max Value	Default Value	Unit
CEDV Cfg	Overload Current	unsigned integer	2	0	65535	5000	mA

C.6.1.15 Self Discharge Rate

This value is the estimated self-discharge rate of the battery.

Table C-99. Self Discharge Rate

Subclass Name	Name	Format	Size in Bytes	Min Value	Max Value	Default Value	Unit
CEDV Cfg	Self Discharge Rate	unsigned integer	1	0	255	20	0.01%/day

C.6.1.16 Electronics Load

This value should be set to a discharge rate determined by the battery electronics current consumption.

Table C-100. Electronics Load

Subclass Name	Name	Format	Size in Bytes	Min Value	Max Value	Default Value	Unit
CEDV Cfg	Electronics Load	unsigned integer	1	0	255	0	3 μ A

C.6.1.17 Battery Low %

This value should be set to be corresponding to a capacity value that correspond to the first or highest voltage point, EDV2. It should be chosen where the capacity sensitivity to voltage is very detectable. It is a non-measured portion of the overall learned *FullChargeCapacity*. This value is an unsigned integer when programmed into the data flash memory, and has a unit of %/2.56/256. When reading/writing this value in the evaluation software, it is in a unit of %/2.56. If the target **Battery Low %** is changed in your design, make sure that the initial value of **DOD at EDV2** is also adjusted accordingly. See [Section C.4.1.16](#) for more information.

Table C-101. Battery Low %

Subclass Name	Name	Format	Size in Bytes	Min Value	Max Value	Default Value	Unit
CEDV Cfg	Battery Low %	unsigned integer	2	0	65535	4608	%/2.56/256

- DF:SBS Configuration:Data(48):DOD at EDV2(28)

C.6.1.18 Near Full

This value sets the start of discharge condition for qualified capacity learning.

Table C-102. Near Full

Subclass Name	Name	Format	Size in Bytes	Min Value	Max Value	Default Value	Unit
CEDV Cfg	Near Full	unsigned integer	2	0	65535	200	mAh

C.6.2 Current Thresholds

C.6.2.1 Dsg Current Threshold

The bq3055 enters discharge mode from relaxation mode or charge mode if *Current* < (-) **Dsg Current Threshold**.

Table C-103. Dsg Current Threshold

Subclass Name	Name	Format	Size in Bytes	Min Value	Max Value	Default Value	Unit
Current Thresholds	Dsg Current Threshold	unsigned integer	2	0	2000	100	mA

Related Variables:

- SBS:Current
- SBS:BatteryStatus[DSG]

C.6.2.2 Chg Current Threshold

The bq3055 enters charge mode from relaxation mode or discharge mode if *Current* > **Chg Current Threshold**.

Table C-104. Chg Current Threshold

Subclass Name	Name	Format	Size in Bytes	Min Value	Max Value	Default Value	Unit
Current Thresholds	Chg Current Threshold	unsigned integer	2	0	2000	50	mA

Related Variables:

- SBS:Current
- SBS:BatteryStatus[DSG]

C.6.2.3 Quit Current

The bq3055 enters relaxation mode from charge mode if *Current* goes below **Quit Current** for **Chg Relax Time**. The bq3055 enters relaxation mode from discharge mode if *Current* goes above (-)**Quit Current** for **Dsg Relax Time**.

Table C-105. Quit Current

Subclass Name	Name	Format	Size in Bytes	Min Value	Max Value	Default Value	Unit
Current Thresholds	Quit Current	unsigned integer	2	0	1000	10	mA

Related Variables:

- DF:Gas Gauging:Current Thresholds:Dsg Relax Time
- DF:Gas Gauging:Current Thresholds:Chg Relax Time
- SBS:Current
- SBS:BatteryStatus[DSG]

C.6.2.4 Dsg Relax Time

The bq3055 enters relaxation mode from discharge mode if *Current* goes above (-)**Quit Current** for at least **Dsg Relax Time**.

Table C-106. Dsg Relax Time

Subclass Name	Name	Format	Size in Bytes	Min Value	Max Value	Default Value	Unit
Current Thresholds	Dsg Relax Time	unsigned integer	1	0	255	1	s

Related Variables:

- DF:Gas Gauging:Current Thresholds:Quit Current
- SBS:Current
- SBS:BatteryStatus[DSG]

C.6.2.5 Chg Relax Time

The bq3055 enters relaxation mode from charge mode if *Current* goes below **Quit Current** for at least **Chg Relax Time**.

Table C-107. Chg Relax Time

Subclass Name	Name	Format	Size in Bytes	Min Value	Max Value	Default Value	Unit
Current Thresholds	Chg Relax Time	unsigned integer	1	0	255	60	s

Related Variables:

- DF:Gas Gauging:Current Thresholds:Quit Current
- SBS:Current
- SBS:BatteryStatus[DSG]

C.6.3 State**C.6.3.1 Qmax Cell 0..3**

These values define the maximum chemical capacity for each cell used for the capacity calculation. The value should be set to be equal or slightly greater than **Full Charge Capacity**. Typically, set these values to a room temperature, low-rate (0.2 C ~ 0.5 C) discharge capacity, usually available from the battery cell datasheet. If the data is not available, set this to **Full Charge Capacity**.

Table C-108. Qmax Cell 0..3

Subclass Name	Name	Format	Size in Bytes	Min Value	Max Value	Default Value	Unit
State	Qmax Cell 0	unsigned integer	2	0	32767	4400	mAh
	Qmax Cell 1		2	0	32767	4400	mAh
	Qmax Cell 2		2	0	32767	4400	mAh
	Qmax Cell 3		2	0	32767	4400	mAh

Related Variables:

- DF:SBS Configuration:Data:Full Charge Capacity
- DF:Gas Gauging:State:Qmax Pack

C.6.3.2 Qmax Pack

This value defines the maximum chemical capacity of the battery pack. Set this value to the smallest value of **Qmax Cell 0 .. 3**. This value is used to calculate the initial remaining capacity of the battery pack upon a full reset.

Table C-109. Qmax Pack

Subclass Name	Name	Format	Size in Bytes	Min Value	Max Value	Default Value	Unit
State	Qmax Pack	unsigned integer	2	0	32767	4400	mAh

Related Variables:

- DF:Gas Gauging:State:Qmax Cell 0
- DF:Gas Gauging:State:Qmax Cell 1
- DF:Gas Gauging:State:Qmax Cell 2
- DF:Gas Gauging:State:Qmax Cell 3

C.7 Charge Control

C.7.1 Charge Control SMBus Broadcasts

All broadcasts to a host or a smart charger are enabled by the **[BCAST]** bit. If the **[HPE]** bit is enabled, master-mode broadcasts to the host address are PEC enabled. If the **[CPE]** bit is enabled, master-mode broadcasts to the Smart-Charger address are PEC enabled. When broadcast is enabled, the following broadcasts are sent:

- *ChargingVoltage* and *ChargingCurrent* broadcasts are sent to the Smart-Charger device address (0x12) every 10 to 60 seconds.
- If any of the **[OCA]**, **[TCA]**, **[OTA]**, **[TDA]**, **[RCA]**, **[RTA]** flags are set, the *AlarmWarning* broadcast is sent to the host device address (0x14) every 10 seconds. Broadcasts stop when all flags above have been cleared.
- If any of the **[OCA]**, **[TCA]**, **[OTA]** or **[TDA]** flags are set, the *AlarmWarning* broadcast is sent to Smart-Charger device address every 10 seconds. Broadcasts stop when all flags above have been cleared.

Related Variables:

- DF:Configuration:Registers:Operation Cfg B[CPE],[HPE],[BCAST]
- SBS:ChargingCurrent
- SBS:ChargingVoltage
- SBS:BatteryStatus[OCA],[TCA],[OTA],[TDA],[RCA],[RTA]

C.7.2 Charge Temperature Cfg

C.7.2.1 JT1

JT1 is the lower bound of the low temperature charging range. If *Temperature* is below the **JT1** threshold, then **[TR1]** flag in *TempRange* is set and charging is inhibited from starting. If bq3055 is in charge mode (**[DSG]** = 0), then charging is suspended, **[CHGSUSP]** flag in *ChargingStatus* is set, and *ChargingCurrent* and *ChargingVoltage* are set to 0.

Table C-110. JT1

Subclass Name	Name	Format	Size in Bytes	Min Value	Max Value	Default Value	Unit
Charge Temperature Cfg	JT1	Integer	2	-400	1200	0	0.1°C

Related Variables:

- SBS:Temperature
- SBS:ChargingCurrent
- SBS:ChargingVoltage
- SBS:BatteryStatus[DSG]

- SBS:ChargingStatus[CHGSUSP]
- SBS:TempRange[TR1]

C.7.2.2 JT2

JT2 is the upper bound of the low temperature charging range and the lower bound of standard temperature charging range 1. If *Temperature* is between **JT1** and **JT2**, then *[TR2]* flag in *TempRange* is set, *Charging Voltage* is set to **LT Chg Voltage** and *ChargingCurrent* is set to **LT Chg Current 1**, **LT Chg Current 2**, or **LT Chg Current 3**, depending on cell voltage (see [Section 1.5.2](#)).

Table C-111. JT2

Subclass Name	Name	Format	Size in Bytes	Min Value	Max Value	Default Value	Unit
Charge Temperature Cfg	JT2	Integer	2	-400	1200	120	0.1°C

Related Variables

- DF:Charge Control:Charge Temperature Cfg:JT1
- DF:Charge Control:Charge Cfg:LT Chg Voltage
- DF:Charge Control:Charge Cfg:LT Chg Current1..3
- SBS:Temperature
- SBS:ChargingCurrent
- SBS:ChargingVoltage
- SBS:TempRange[TR2]

C.7.2.3 JT2a

JT2a is the upper bound of the standard temperature charging range1 and the lower bound of standard temperature charging range 2. If *Temperature* is between **JT2** and **JT2a**, then *[TR2A]* flag in *TempRange* is set, *Charging Voltage* is set to **ST1 Chg Voltage** and *ChargingCurrent* is set to **ST1 Chg Current 1**, **ST1 Chg Current 2**, or **ST1 Chg Current 3**, depending on cell voltage (see [Section 1.5.2](#)).

Table C-112. JT2a

Subclass Name	Name	Format	Size in Bytes	Min Value	Max Value	Default Value	Unit
Charge Temperature Cfg	JT2a	Integer	2	-400	1200	300	0.1°C

Related Variables:

- DF:Charge Control:Charge Temperature Cfg:JT2
- DF:Charge Control:Charge Cfg:ST1 Chg Voltage
- DF:Charge Control:Charge Cfg:ST1 Chg Current1..3
- SBS:Temperature
- SBS:ChargingCurrent
- SBS:ChargingVoltage
- SBS:TempRange[TR2A]

C.7.2.4 JT3

JT3 is the upper bound of the standard temperature charging range 2, and the lower bound of high temperature charging range. If *Temperature* is between **JT2a** and **JT3**, then *[TR3]* flag in *TempRange* is set, *Charging Voltage* is set to **ST2 Chg Voltage** and *ChargingCurrent* is set to **ST2 Chg Current 1**, **ST2 Chg Current 2**, or **ST2 Chg Current 3**, depending on cell voltage (see [Section 1.5.2](#)).

If *Temperature* is greater than **JT3** and charging did not start ([DSG] = 1), then charging is inhibited from starting.

Table C-113. JT3

Subclass Name	Name	Format	Size in Bytes	Min Value	Max Value	Default Value	Unit
Charge Temperature Cfg	JT3	Integer	2	-400	1200	450	0.1°C

Related Variables:

- DF:Charge Control:Charge Temperature Cfg:JT2a
- DF:Charge Control:Charge Cfg:ST2 Chg Voltage
- DF:Charge Control:Charge Cfg:ST2 Chg Current1..3
- SBS:Temperature
- SBS:ChargingCurrent
- SBS:ChargingVoltage
- SBS:BatteryStatus[DSG]
- SBS:TempRange[TR3]

C.7.2.5 JT4

JT4 is the upper bound of the high temperature charging range. If *Temperature* is between **JT3** and **JT4**, then *[TR4]* flag in *TempRange* is set, *Charging Voltage* is set to **HT Chg Voltage** and *Charging Current* is set to **HT Chg Current 1**, **HT Chg Current 2**, or **HTChg Current 3**, depending on cell voltage (see [Section 1.5.2](#)).

If *Temperature* is greater than **JT4** then *[TR5]* flag in *TempRange* is set. If bq3055 is in charge mode (*[DSG]* = 0), then charging is suspended, *[CHGSUSP]* flag in *ChargingStatus* is set, and *ChargingCurrent* and *ChargingVoltage* are set to 0.

Table C-114. JT4

Subclass Name	Name	Format	Size in Bytes	Min Value	Max Value	Default Value	Unit
Charge Temperature Cfg	JT4	Integer	2	-400	1200	550	0.1°C

Related Variables:

- DF:Charge Control:Charge Temperature Cfg:JT3
- DF:Charge Control:Charge Cfg:HT Chg Voltage
- DF:Charge Control:Charge Cfg:HT Chg Current1..3
- SBS:Temperature
- SBS:ChargingCurrent
- SBS:ChargingVoltage
- SBS:BatteryStatus[DSG]
- SBS:ChargingStatus[CHGSUSP]
- SBS:TempRange[TR4][TR5]

C.7.2.6 Temp Hys

If, in charge inhibit mode, the *Temperature* rises above **JT1 + Temp Hys** or falls below **JT3–Temp Hys** charging is allowed to be resumed and *[XCHG]* in *ChargingStatus* is cleared. If the *[NR]* flag is cleared the fault condition can be cleared by removing and reinserting the battery pack.

Table C-115. Temp Hys

Subclass Name	Name	Format	Size in Bytes	Min Value	Max Value	Default Value	Unit
Charge Temperature Cfg	Temp Hys	signed integer	2	0	100	10	0.1°C

Related Variables:

- DF:Charge Control:Charge Temperature Cfg:JT1
- DF:Charge Control:Charge Temperature Cfg:JT3
- DF:Configuration:Registers:Operation Cfg B[NR],[CHGIN]
- SBS:Temperature
- SBS:ChargingStatus[XCHG]

C.7.3 Pre-Charge Cfg**C.7.3.1 Pre-chg Current**

The bq3055 sets the *ChargingCurrent* to the **Pre-chg Current** value when in pre-charge mode.

Table C-116. Pre-chg Current

Subclass Name	Name	Format	Size in Bytes	Min Value	Max Value	Default Value	Unit
Pre-Charge Cfg	Pre-chg Current	unsigned integer	2	0	2000	250	mA

Related Variables:

- SBS:ChargingCurrent

C.7.3.2 Pre-chg Voltage

The bq3055 enters pre-charge mode and sets the *[PCHG]* flag in *ChargingStatus* if any *CellVoltage4..1* drops below the **Pre-chg Voltage** threshold. In this mode, *Charging Voltage* is set to **LT Chg Voltage**, and *Charging Current* is set to **Pre-chg Current**.

Table C-117. Pre-chg Voltage

Subclass Name	Name	Format	Size in Bytes	Min Value	Max Value	Default Value	Unit
Pre-Charge Cfg	Pre-chg Voltage	unsigned integer	2	0	20000	3000	mV

Related Variables:

- SBS:CellVoltage4
- SBS:CellVoltage3
- SBS:CellVoltage2
- SBS:CellVoltage1
- SBS:ChargingStatus[PCHG]

C.7.3.3 Recovery Voltage

The bq3055 enters fast charge mode from pre-charge mode and sets either the *[LTCHG]*, *[ST1CHG]*, *[ST2CHG]*, or *[HTCHG]* flag in *ChargingStatus* if all *CellVoltage4..1* are equal to or higher than the **Recovery Voltage**.

Table C-118. Recovery Voltage

Subclass Name	Name	Format	Size in Bytes	Min Value	Max Value	Default Value	Unit
Pre-Charge Cfg	Recovery Voltage	unsigned integer	2	0	20000	3100	mV

Related Variables:

- DF:Pre-Charge Cfg:Pre-chg Voltage
- SBS:Temperature
- SBS:CellVoltage4
- SBS:CellVoltage3

- SBS:CellVoltage2
- SBS:CellVoltage1
- SBS:ChargingStatus[FCHG]

C.7.4 Charge Cfg

C.7.4.1 LT Chg Voltage

The bq3055 sets *ChargingVoltage* to the **LT Chg Voltage** value when *Temperature* is in the low temperature charging range ($[TR2] = 1$).

Table C-119. LT Chg Voltage

Subclass Name	Name	Format	Size in Bytes	Min Value	Max Value	Default Value	Unit
Charge Cfg	LT Chg Voltage	Integer	2	0	20,000	12,000	mV

Related Variables:

- SBS: Temperature
- SBS: ChargingVoltage
- SBS:TempRange[TR2]

C.7.4.2 LT Chg Current 1

The bq3055 sets *ChargingCurrent* to the **LT Chg Current 1** value when *Temperature* is in the low temperature charging range ($[TR2] = 1$) and $\max(\text{CellVoltage4..1})$ is in the CVR1 range.

Table C-120. LT Chg Current 1

Subclass Name	Name	Format	Size in Bytes	Min Value	Max Value	Default Value	Unit
Charge Cfg	LT Chg Current 1	Integer	2	0	20,000	2,000	mA

Related Variables:

- SBS:Temperature
- SBS:ChargingCurrent
- SBS:CellVoltage4..1
- SBS:TempRange[TR2]

C.7.4.3 LT Chg Current 2

The bq3055 sets *ChargingCurrent* to the **LT Chg Current 2** value when *Temperature* in the low temperature charging range ($[TR2] = 1$) and $\max(\text{CellVoltage4..1})$ is in the CVR2 range.

Table C-121. LT Chg Current 2

Subclass Name	Name	Format	Size in Bytes	Min Value	Max Value	Default Value	Unit
Charge Cfg	LT Chg Current 2	Integer	2	0	20,000	2,000	mA

Related Variables:

- SBS:Temperature
- SBS:ChargingCurrent
- SBS:CellVoltage4..1
- SBS:TempRange[TR2]

C.7.4.4 LT Chg Current 3

The bq3055 sets *ChargingCurrent* to the **LT Chg Current 3** value when *Temperature* in the low temperature charging range ($[TR2] = 1$) and $\max(\text{CellVoltage4..1})$ is in the CVR3 range.

Table C-122. LT Chg Current 3

Subclass Name	Name	Format	Size in Bytes	Min Value	Max Value	Default Value	Unit
Charge Cfg	LT Chg Current 3	Integer	2	0	20,000	2,000	mA

Related Variables:

- SBS:Temperature
- SBS:ChargingCurrent
- SBS:CellVoltage4..1
- SBS:TempRange[TR2]

C.7.4.5 ST1 Chg Voltage

The bq3055 sets *ChargingVoltage* to the **ST1 Chg Voltage** value when *Temperature* is in the standard temperature charging range 1 ($[TR2A] = 1$).

Table C-123. ST1 Chg Voltage

Subclass Name	Name	Format	Size in Bytes	Min Value	Max Value	Default Value	Unit
Charge Cfg	ST1 Chg Voltage	Integer	2	0	20,000	12,600	mV

Related Variables:

- SBS:Temperature
- SBS:ChargingVoltage
- SBS:TempRange[TR2A]

C.7.4.6 ST1 Chg Current 1

The bq3055 sets *ChargingCurrent* to the **ST1 Chg Current 1** value when *Temperature* is in the standard temperature charging range 1 ($[TR2A] = 1$) and $\max(\text{CellVoltage4..1})$ is in the CVR1 range.

Table C-124. ST1 Chg Current 1

Subclass Name	Name	Format	Size in Bytes	Min Value	Max Value	Default Value	Unit
Charge Cfg	ST1 Chg Current 1	Integer	2	0	20,000	4,000	mA

Related Variables:

- SBS:Temperature
- SBS:ChargingCurrent
- SBS:CellVoltage4..1
- SBS:TempRange[TR2A]

C.7.4.7 ST1 Chg Current 2

The bq3055 sets *ChargingCurrent* to the **ST1 Chg Current 2** value when *Temperature* is in the standard temperature charging range 1 ($[TR2A] = 1$) and $\max(\text{CellVoltage4..1})$ is in the CVR2 range.

Table C-125. ST1 Chg Current 2

Subclass Name	Name	Format	Size in Bytes	Min Value	Max Value	Default Value	Unit
Charge Cfg	ST1 Chg Current 2	Integer	2	0	20,000	4,000	mA

Related Variables:

- SBS:Temperature
- SBS:ChargingCurrent
- SBS:CellVoltage4..1
- SBS:TempRange[TR2A]

C.7.4.8 ST1 Chg Current 3

The bq3055 sets *ChargingCurrent* to the **ST1 Chg Current 3** value when *Temperature* is in the standard temperature charging range 1 ($[TR2A] = 1$) and $\max(\text{CellVoltage4..1})$ is in the CVR3 range.

Table C-126. ST1 Chg Current 3

Subclass Name	Name	Format	Size in Bytes	Min Value	Max Value	Default Value	Unit
Charge Cfg	ST1 Chg Current 3	Integer	2	0	20,000	4,000	mA

Related Variables:

- SBS:Temperature
- SBS:ChargingCurrent
- SBS:CellVoltage4..1
- SBS:TempRange[TR2A]

C.7.4.9 ST2 Chg Voltage

The bq3055 sets *ChargingVoltage* to the **ST2 Chg Voltage** value when *Temperature* is in the standard temperature charging range 2 ($[TR3] = 1$).

Table C-127. ST2 Chg Voltage

Subclass Name	Name	Format	Size in Bytes	Min Value	Max Value	Default Value	Unit
Charge Cfg	ST2 Chg Voltage	Integer	2	0	20,000	12,600	mA

Related Variables:

- SBS:Temperature
- SBS:ChargingVoltage
- SBS:TempRange[TR3]

C.7.4.10 ST2 Chg Current 1

The bq3055 sets *ChargingCurrent* to the **ST2 Chg Current 1** value when *Temperature* is in the standard temperature charging range 2 ($[TR3] = 1$) and $\max(\text{CellVoltage4..1})$ is in the CVR1 range.

Table C-128. ST2 Chg Current 1

Subclass Name	Name	Format	Size in Bytes	Min Value	Max Value	Default Value	Unit
Charge Cfg	ST2 Chg Current 1	Integer	2	0	20,000	4,000	mA

Related Variables:

- SBS:Temperature
- SBS:ChargingCurrent
- SBS:CellVoltage4..1
- SBS:TempRange[TR3]

C.7.4.11 ST2 Chg Current 2

The bq3055 sets *ChargingCurrent* to the **ST2 Chg Current 2** value when *Temperature* is in the standard temperature charging range 2 ($[TR3] = 1$) and $\max(\text{CellVoltage4..1})$ is in the CVR2 range.

Table C-129. ST2 Chg Current 2

Subclass Name	Name	Format	Size in Bytes	Min Value	Max Value	Default Value	Unit
Charge Cfg	ST2 Chg Current 2	Integer	2	0	20,000	4,000	mA

Related Variables:

- SBS:Temperature
- SBS:ChargingCurrent
- SBS:CellVoltage4..1
- SBS:TempRange[TR3]

C.7.4.12 ST2 Chg Current 3

The bq3055 sets *ChargingCurrent* to the **ST2 Chg Current 3** value when *Temperature* is in the standard temperature charging range 2 ($[TR3] = 1$) and $\max(\text{CellVoltage4..1})$ is in the CVR3 range.

Table C-130. ST2 Chg Current 3

Subclass Name	Name	Format	Size in Bytes	Min Value	Max Value	Default Value	Unit
Charge Cfg	ST2 Chg Current 3	Integer	2	0	20,000	4,000	mA

Related Variables:

- SBS:Temperature
- SBS:ChargingCurrent
- SBS:CellVoltage4..1
- SBS:TempRange[TR3]

C.7.4.13 HT Chg Voltage

The bq3055 sets *ChargingVoltage* to the **HT Chg Voltage** value when *Temperature* is in the high temperature charging range ($[TR4] = 1$).

Table C-131. HT Chg Voltage

Subclass Name	Name	Format	Size in Bytes	Min Value	Max Value	Default Value	Unit
Charge Cfg	HT Chg Voltage	Integer	2	0	20,000	12,570	mV

Related Variables:

- SBS:Temperature
- SBS:ChargingVoltage
- SBS:TempRange[TR4]

C.7.4.14 HT Chg Current 1

The bq3055 sets *ChargingCurrent* to the **HT Chg Current 1** value when *Temperature* is in the high temperature charging range ($[TR4] = 1$) and $\max(\text{CellVoltage4..1})$ is in the CVR1 range.

Table C-132. HT Chg Current 1

Subclass Name	Name	Format	Size in Bytes	Min Value	Max Value	Default Value	Unit
Charge Cfg	HT Chg Current 1	Integer	2	0	20,000	3,800	mA

Related Variables:

- SBS:Temperature
- SBS:ChargingCurrent
- SBS:CellVoltage4..1
- SBS:TempRange[TR4]

C.7.4.15 HT Chg Current 2

The bq3055 sets *ChargingCurrent* to the **HT Chg Current 2** value when *Temperature* is in the high temperature charging range ($[TR4] = 1$) and $\max(\text{CellVoltage4..1})$ is in the CVR2 range.

Table C-133. HT Chg Current 2

Subclass Name	Name	Format	Size in Bytes	Min Value	Max Value	Default Value	Unit
Charge Cfg	HT Chg Current 2	Integer	2	0	20,000	3,800	mA

Related Variables:

- SBS:Temperature
- SBS:ChargingCurrent
- SBS:CellVoltage4..1
- SBS:TempRange[TR4]

C.7.4.16 HT Chg Current 3

The bq3055 sets *ChargingCurrent* to the **HT Chg Current 3** value when *Temperature* is in the high temperature charging range ($[TR4] = 1$) and $\max(\text{CellVoltage4..1})$ is in the CVR3 range.

Table C-134. HT Chg Current 3

Subclass Name	Name	Format	Size in Bytes	Min Value	Max Value	Default Value	Unit
Charge Cfg	HT Chg Current 3	Integer	2	0	20,000	3,800	mA

Related Variables:

- SBS:Temperature
- SBS:ChargingCurrent
- SBS:CellVoltage4..1
- SBS:TempRange[TR4]

C.7.4.17 Cell Voltage Threshold 1

The bq3055 is in cell voltage range 1 (CVR1) when $\max(\text{CellVoltage4..1}) < \text{Cell Voltage Threshold 1}$.

Table C-135. Cell Voltage Threshold 1

Subclass Name	Name	Format	Size in Bytes	Min Value	Max Value	Default Value	Unit
Charge Cfg	Cell Voltage Threshold 1	Integer	2	0	5,000	3,900	mV

Related Variables:

- SBS:CellVoltage4..1

C.7.4.18 Cell Voltage Threshold 2

The bq3055 enters cell voltage range 2 (CVR2) when $\text{Cell Voltage Threshold 1} < \max(\text{CellVoltage4..1}) < \text{Cell Voltage Threshold 2}$. The bq3055 enters cell voltage range 3 (CVR3) when $\max(\text{CellVoltage4..1}) > \text{Cell Voltage Threshold 2}$.

Table C-136. Cell Voltage Threshold 2

Subclass Name	Name	Format	Size in Bytes	Min Value	Max Value	Default Value	Unit
Charge Cfg	Cell Voltage Threshold 2	Integer	2	0	5,000	4,000	mV

Related Variables:

- DF:Charge Control:Charge Cfg:Cell Voltage Threshold 1
- SBS:CellVoltage4..1

C.7.4.19 Cell Voltage Thresh Hys

Cell Voltage Thresh Hys is used to make sure that transitions between cell voltage ranges are not affected by small transients. For example, if the current cell voltage range is CVR2 and cell voltage goes above **Cell Voltage Threshold 2** then CVR3 is entered. Cell voltage has to fall below **Cell Voltage Threshold 2 – Cell Voltage Thresh Hys** for the bq3055 to go back to CVR2 range.

Table C-137. Cell Voltage Thresh Hys

Subclass Name	Name	Format	Size in Bytes	Min Value	Max Value	Default Value	Unit
Charge Cfg	Cell Voltage Thresh Hys	Integer	2	0	1,000	10	mV

Related Variables:

- SBS:CellVoltage4..1
- DF:Charge Control:Charge Cfg:Cell Voltage Threshold 1
- DF:Charge Control:Charge Cfg:Cell Voltage Threshold 2

C.7.5 Termination Cfg.

C.7.5.1 Taper Current

If battery *Current* falls below **Taper Current** for 2 consecutive **Current Taper Window** time periods during charging and *Voltage* is equal to or higher than **Charging Voltage–Taper Voltage** the bq3055 recognizes valid primary charge termination.

Table C-138. Taper Current

Subclass Name	Name	Format	Size in Bytes	Min Value	Max Value	Default Value	Unit
Termination Cfg.	Taper Current	unsigned integer	2	0	1000	250	mA

Related Variables:

- DF:Charge Control:Fast Charge Cfg:Charging Voltage
- DF:Charge Control:Termination Cfg.:Taper Voltage
- DF:Charge Control:Termination Cfg.:Current Taper Window
- SBS:Voltage
- SBS:Current

C.7.5.2 Taper Voltage

For valid primary charge termination, pack *Voltage* must be equal to or higher than **Charging Voltage–Taper Voltage**.

Table C-139. Taper Voltage

Subclass Name	Name	Format	Size in Bytes	Min Value	Max Value	Default Value	Unit
Termination Cfg.	Taper Voltage	unsigned integer	2	0	1000	300	mV

Related Variables:

- DF:Charge Control:Fast Charge Cfg:Charging Voltage
- SBS:Voltage

C.7.5.3 Current Taper Window

For a valid primary charge termination, *Current* must fall below **Taper Current** threshold for 2 consecutive **Current Taper Window** time periods.

Table C-140. Current Taper Window

Subclass Name	Name	Format	Size in Bytes	Min Value	Max Value	Default Value	Unit
Termination Cfg.	Current Taper Window	unsigned integer	1	0	240	40	s

Related Variables:

- DF:Charge Control:Fast Charge Cfg:Charging Voltage
- DF:Charge Control:Termination Cfg.:Taper Current
- SBS:Current

C.7.5.4 TCA Set %

When set between 0% and 100%, *[TCA]* in *BatteryStatus* is set if *RelativeStateOfCharge* is equal to or above **TCA Set %**. Set to -1 to disable this function. If set to -1, the *[TCA]* flag is set on primary charge termination and *ChargingCurrent* is set to 0.

Table C-141. TCA Set %

Subclass Name	Name	Format	Size in Bytes	Min Value	Max Value	Default Value	Unit
Termination Cfg.	TCA Set %	signed integer	1	-1	100	-1	%

Related Variables:

- DF:Charge Control:Termination Cfg.:TCA Clear %
- SBS:RelativeStateOfCharge
- SBS:ChargingCurrent
- SBS:BatteryStatus[TCA]

C.7.5.5 TCA Clear %

When set between 0% and 100%, *[TCA]* in *BatteryStatus* is cleared if *RelativeStateOfCharge* is below **TCA Clear %**. Set to -1 to disable this function.

Table C-142. TCA Clear %

Subclass Name	Name	Format	Size in Bytes	Min Value	Max Value	Default Value	Unit
Termination Cfg.	TCA Clear %	signed integer	1	-1	100	95	%

Related Variables:

- DF:Charge Control:Termination Cfg.:TCA Set %
- SBS:RelativeStateOfCharge
- SBS:BatteryStatus[TCA]

C.7.5.6 FC Set %

When set between 0% and 100%, *[FC]* in *BatteryStatus* is set if *RelativeStateOfCharge* is equal to or above **FC Set %**. Set to -1 to disable this function.

Table C-143. FC Set %

Subclass Name	Name	Format	Size in Bytes	Min Value	Max Value	Default Value	Unit
Termination Cfg.	FC Set %	signed integer	1	-1	100	-1	%

Related Variables:

- DF:Charge Control:Termination Cfg.:FC Clear %
- SBS:RelativeStateOfCharge
- SBS:BatteryStatus[FC]

C.7.5.7 FC Clear %

When set between 0% and 100%, *[FC]* in *BatteryStatus* is cleared if *RelativeStateOfCharge* reaches or falls below **FC Clear %**. Set to -1 to disable this function. It is recommended, however, not to set **FC Clear %** to -1.

Table C-144. FC Clear %

Subclass Name	Name	Format	Size in Bytes	Min Value	Max Value	Default Value	Unit
Termination Cfg.	FC Clear %	signed integer	1	-1	100	98	%

Related Variables:

- DF:Charge Control:Termination Cfg.:FC Set %
- SBS:RelativeStateOfCharge
- SBS:BatteryStatus[FC]

C.7.6 Cell Balancing Cfg

C.7.6.1 Cell Balance Threshold

This value sets the minimum voltage in mV that each cell must achieve to initiate cell balancing.

Table C-145. Cell Balance Threshold

Subclass Name	Name	Format	Size in Bytes	Min Value	Max Value	Default Value	Unit
Cell Balancing Cfg	Cell Balance Threshold	integer	2	0	5000	3900	mV

C.7.6.2 Cell Balance Window

This value sets in mV the amount that the cell balance threshold increases during cell balancing.

Table C-146. Cell Balance Window

Subclass Name	Name	Format	Size in Bytes	Min Value	Max Value	Default Value	Unit
Cell Balancing Cfg	Cell Balance Window	integer	2	0	5000	100	mV

C.7.6.3 Cell Balance Min

This value sets in mV the cell differential that must exist to initiate cell balancing.

Table C-147. Cell Balance Min

Subclass Name	Name	Format	Size in Bytes	Min Value	Max Value	Default Value	Unit
Cell Balancing Cfg	Cell Balance Min	unsigned integer	1	0	5000	40	mV

C.7.6.4 Cell Balance Interval

This value sets the cell balancing time interval in seconds.

Table C-148. Cell Balance Interval

Subclass Name	Name	Format	Size in Bytes	Min Value	Max Value	Default Value	Unit
Cell Balancing Cfg	Cell Balance Interval	unsigned integer	1	0	240	20	s

C.7.7 Charging Faults

C.7.7.1 Over Charging Voltage

If the battery pack *Voltage* is equal to or greater than *ChargingVoltage* + **Over Charging Voltage** for a time period greater than **Over Charging Volt Time**, the *[OCHGV]* flag is set and the CHG FET and ZVCHG FET (if used) are turned off if *[OCHGV]* is also set in **Charge Fault Cfg**.

Table C-149. Over Charging Voltage

Subclass Name	Name	Format	Size in Bytes	Min Value	Max Value	Default Value	Unit
Charging Faults	Over Charging Voltage	unsigned integer	2	0	3000	500	mV

Related Variables:

- DF:Charge Control:Charging Faults:Over Charging Volt Time
- DF:Charge Control:Charging Faults:Charge Fault Cfg[OCHGV]
- SBS:Voltage
- SBS:ChargingVoltage
- SBS:BatteryStatus[TCA]
- SBS:ChargingStatus[OCHGV]

C.7.7.2 Over Charging Volt Time

If the battery pack *Voltage* is equal to or greater than *ChargingVoltage* + **Over Charging Voltage** for a time period greater than **Over Charging Volt Time** the [OCHGV] flag is set and the CHG FET and ZVCHG FET (if used) are turned off if [OCHGV] is also set in **Charge Fault Cfg**. The bq3055 recovers if the battery pack *Voltage* is equal to or below **Charging Voltage**.

Table C-150. Over Charging Volt Time

Subclass Name	Name	Format	Size in Bytes	Min Value	Max Value	Default Value	Unit
Charging Faults	Over Charging Volt Time	unsigned integer	1	0	240	2	s

Related Variables:

- DF:Charge Control:Fast Charge Cfg:Charging Voltage
- DF:Charge Control:Charging Faults:Over Charging Volt Time
- DF:Charge Control:Charging Faults:Charge Fault Cfg[OCHGV]
- SBS:Voltage
- SBS:ChargingVoltage
- SBS:BatteryStatus[TCA]
- SBS:ChargingStatus[OCHGV]

C.7.7.3 Over Charging Current

If the current is equal to or greater than the sum of *ChargingCurrent* and **Over Charging Current** for a time period greater than **Over Charging Curr Time** the bq3055 goes into an over charging current error, [OCHGI] in *ChargingStatus* set and, if [OCHGI] in **Charge Fault Cfg** is set, the CHG FET turns off and the ZVCHG FET (if used) is turned on. If the ZVCHG FET is not used the CHG FET remains on, regardless of the bits set in **Charge Fault Cfg**, because it acts as the ZVCHG FET.

Table C-151. Over Charging Current

Subclass Name	Name	Format	Size in Bytes	Min Value	Max Value	Default Value	Unit
Charging Faults	Over Charging Current	unsigned integer	2	0	2000	500	mA

Related Variables:

- DF:Charge Control:Charging Faults:Over Charging Curr Time
- DF:Charge Control:Charging Faults:Charge Fault Cfg[OCHGI]
- SBS:Current
- SBS:ChargingCurrent
- SBS:BatteryStatus[TCA]
- SBS:ChargingStatus[OCHGI]

C.7.7.4 Over Charging Curr Time

If the *Current* is equal to or greater than the sum of *ChargingCurrent* and **Over Charging Current** for a

time period greater than **Over Charging Curr Time** the bq3055 goes into over charging current error, **[OCHGI]** in **ChargingStatus** set and, if **[OCHGI]** in **Charge Fault Cfg** is set, the CHG FET turns off and the ZVCHG FET (if enabled, i.e. **[ZVCHG1]:[ZVCHG2] = 0:0** in **Operation Cfg A**) is turned on. If the ZVCHG FET is not used the CHG FET remains on, regardless of the bits set in **Charge Fault Cfg**. The bq3055 recovers if **AverageCurrent** is equal to or lower than the **Over Charging Curr Recov** value.

Table C-152. Over Charging Curr Time

Subclass Name	Name	Format	Size in Bytes	Min Value	Max Value	Default Value	Unit
Charging Faults	Over Charging Curr Time	unsigned integer	1	0	240	2	s

Related Variables:

- DF:Charge Control:Charging Faults:Over Charging Current
- DF:Charge Control:Charging Faults:Over Charging Curr Recov
- DF:Charge Control:Charging Faults:Charge Fault Cfg[OCHGI]
- SBS:Current
- SBS:AverageCurrent
- SBS:ChargingCurrent
- SBS:BatteryStatus[TCA]
- SBS:ChargingStatus[OCHGI]

C.7.7.5 Over Charging Curr Recov

The bq3055 recovers from an over charging current fault if **AverageCurrent** is equal to or lower than **Over Charging Curr Recov**. On recovery, **[OCHGI]** in **ChargingStatus** is reset and the CHG and ZVCHG FETs return to their previous states.

Table C-153. Over Charging Curr Recov

Subclass Name	Name	Format	Size in Bytes	Min Value	Max Value	Default Value	Unit
Charging Faults	Over Charging Curr Recov	unsigned integer	2	0	2000	100	mA

Related Variables:

- DF:Charge Control:Charging Faults:Over Charging Current
- DF:Charge Control:Charging Faults:Over Charging Curr Time
- SBS:Current
- SBS:ChargingCurrent
- SBS:BatteryStatus[TCA]
- SBS:ChargingStatus[OCHGI]

C.7.7.6 Depleted Voltage

The bq3055 goes into a depleted voltage fault and sets **[XCHGLV]** if the charger is present (**PackVoltage** > **AFE Shutdown Voltage**) and **Voltage** is equal to or lower than **Depleted Voltage** for a period equal to or greater than **Depleted Voltage Time**. The DSG FET is turned off and the CHG and ZVCHG FETs are set according to **[ZVCHG1,ZVCHG0]** bits if **[CS_XCHGLV]** is set in **Charge Fault Cfg**.

Table C-154. Depleted Voltage

Subclass Name	Name	Format	Size in Bytes	Min Value	Max Value	Default Value	Unit
Charging Faults	Depleted Voltage	unsigned integer	2	0	16000	6000	mV

Related Variables:

- DF:Charge Control:Charging Faults:Depleted Voltage Time
- DF:Charge Control:Charging Faults:Charge Fault Cfg[CS_XCHGLV]
- DF:Power:Power:AFE Shutdown Voltage
- SBS:Voltage
- SBS:PackVoltage
- SBS:ChargingStatus[XCHGLV]

C.7.7.7 Depleted Voltage Time

The bq3055 goes into a depleted voltage fault and sets *[XCHGLV]* if the charger is present and pack *Voltage* is equal to or lower than **Depleted Voltage** for a period equal to or greater than **Depleted Voltage Time**. If *[CS_XCHGLV]* is set in **Charge Fault Cfg** the DSG FET is turned off and the CHG and ZVCHG FETs are set according to their pre-charge settings.

Table C-155. Depleted Voltage Time

Subclass Name	Name	Format	Size in Bytes	Min Value	Max Value	Default Value	Unit
Charging Faults	Depleted Voltage Time	unsigned integer	1	0	240	2	s

Related Variables:

- DF:Charge Control:Charging Faults:Depleted Voltage
- DF:Charge Control:Charging Faults:Depleted Recovery
- DF:Charge Control:Charging Faults:Charge Fault Cfg[CS_XCHGLV]
- SBS:Voltage
- SBS:ChargingStatus[XCHGLV]

C.7.7.8 Depleted Recovery

The bq3055 recovers from a depleted voltage fault if pack *Voltage* is equal to or higher than the **Depleted Recovery** threshold. On recovery, *[OCHGLV]* is reset and the DSG FET, CHG FET and ZVCHG FET return to their previous states.

Table C-156. Depleted Recovery

Subclass Name	Name	Format	Size in Bytes	Min Value	Max Value	Default Value	Unit
Charging Faults	Depleted Recovery	unsigned integer	2	0	16000	6500	mV

Related Variables:

- DF:Charge Control:Charging Faults:Depleted Voltage Time
- SBS:Voltage
- SBS:ChargingStatus[XCHGLV]

C.7.7.9 Over Charge Capacity

The bq3055 goes into an overcharge fault and sets the *[OC]* flag in *ChargingStatus* if the internal counted remaining capacity exceeds *FullChargeCapacity* + **Over Charge Capacity**. The CHG FET and ZVCHG FET (if used) are also turned off if the *[OC]* bit is set in **Charge Fault Cfg**.

Table C-157. Over Charge Capacity

Subclass Name	Name	Format	Size in Bytes	Min Value	Max Value	Default Value	Unit
Charging Faults	Over Charge Capacity	unsigned integer	2	0	4000	300	mAh

Related Variables:

- DF:Charge Control:Charging Faults:Over Charge Recovery
- DF:Charge Control:Charging Faults:Charge Fault Cfg[OC]
- SBS:FullChargeCapacity
- SBS:ChargingStatus[OC]

C.7.7.10 Over Charge Recovery

The bq3055 recovers from an over charge in non-removable battery mode ($[NR] = 1$) if it is continuously discharged by an amount of **Over Charge Recovery** charge.

Table C-158. Over Charge Recovery

Subclass Name	Name	Format	Size in Bytes	Min Value	Max Value	Default Value	Unit
Charging Faults	Over Charge Recovery	unsigned integer	2	0	100	2	mAh

Related Variables:

- DF:Charge Control:Charging Faults:Over Charge Capacity
- DF:Configuration:Registers:Operation B Cfg[NR]
- SBS:RemainingCapacity
- SBS:FullChargeCapacity
- SBS:ChargingStatus[OC]

C.7.7.11 FC-MTO

If charge *Current* is equal to or greater than **Chg Current Threshold** for **FC-MTO** time period the bq3055 generates a fast charge mode time out fault and sets the $[FCMTO]$ flag. The CHG FET and ZVCHG FET (if used) are also turned of if $[FCMTO]$ is set in **Charge Fault Cfg**. Set to 0 to disable **FC-MTO**.

Table C-159. FC-MTO

Subclass Name	Name	Format	Size in Bytes	Min Value	Max Value	Default Value	Unit
Charging Faults	FC-MTO	unsigned integer	2	0	65535	10800	s

Related Variables:

- DF:Gas Gauging:Current Thresholds:Chg Current Threshold
- DF:Charge Control:Charging Faults:Charge Fault Cfg[FCMTO]
- SBS:Current
- SBS:ChargingStatus[FCMTO]

C.7.7.12 PC-MTO

If charge *Current* is equal to or greater than **Chg Current Threshold** for **PC-MTO** time period the bq3055 generates a precharge mode-time out error and sets the $[PCMTO]$ flag. The CHG FET and ZVCHG FET (if used) are also turned of if $[PCMTO]$ is set in **Charge Fault Cfg**. Set to 0 to disable **PC-MTO**.

Table C-160. PC-MTO

Subclass Name	Name	Format	Size in Bytes	Min Value	Max Value	Default Value	Unit
Charging Faults	PC-MTO	unsigned integer	2	0	65535	3600	s

Related Variables:

- DF:Gas Gauging:Current Thresholds:Chg Current Threshold
- DF:Charge Control:Charging Faults:Charge Fault Cfg[PCMTO]
- SBS:Current

- SBS:ChargingStatus[PCMTO]

C.7.7.13 Charge Fault Cfg

This register sets the behavior of the charge, discharge, and precharge FETs in fault conditions.

Table C-161. Charge Fault Cfg

Subclass Name	Name	Format	Size in Bytes	Min Value	Max Value	Default Value	Unit
Charging Faults	Charge Fault Cfg	hex	1	0	0x3f	0x00	

7	6	5	4	3	2	1	0
RSVD	RSVD	PCMTO	FCMTO	OCHGV	OCHGI	OC	CS_XCHGLV
R	R	R/W	R/W	R/W	R/W	R/W	R/W

LEGEND: R/W = Read/Write; R = Read only; -n = value after reset; RSVD = Reserved and **must** be programmed to 0

Figure C-2. Charge Fault Cfg Register

PCMTO — If set, CHG FET and ZVCHG FET (if used as the precharge FET) are turned off when pre-charge time out fault occurs.

FCMTO — If set, CHG FET and ZVCHG FET (if used as the precharge FET) are turned off when fast charge time out fault occurs.

OCHGV — If set, CHG FET and ZVCHG FET (if used as the precharge FET) are turned off when charge voltage fault occurs.

OCHGI — If set, CHG FET is turned off and ZVCHG FET (if used as the precharge FET) is turned on when charge current fault occurs. If ZVCHG FET is not used as the precharge FET, CHG FET remains on, regardless of this bit.

OC — If set, CHG FET and ZVCHG FET (if used as the precharge FET) are turned off when over charge fault occurs.

CS_XCHGLV — If set, DSG FET is turned off when battery depleted fault occurs.

Related Variables:

- DF:Charge Control:Charging Faults:Over Charging Volt Time
- DF:Charge Control:Charging Faults:Over Charging Curr Time
- DF:Charge Control:Charging Faults:Depleted Voltage Time
- DF:Charge Control:Charging Faults:Over Charge Capacity
- DF:Charge Control:Charging Faults:FC-MTO
- DF:Charge Control:Charging Faults:PC-MTO

C.8 Configuration

C.8.1 Registers

C.8.1.1 Operation Cfg A

This register enables, disables or configures various features of the bq3055.

Table C-162. Operation Cfg A

Subclass Name	Name	Format	Size in Bytes	Min Value	Max Value	Default Value	Unit
Configuration	Operation Cfg A	hex	2	0x0000	0xffff	0x0228	

	bit 7	bit 6	bit 5	bit 4	bit 3	bit 2	bit 1	bit 0
High Byte	RSVD	RSVD	RSVD	RSVD	RSVD	RSVD	CC1	CC0
Low Byte	RSVD	RSVD	SLEEP	TEMP1	TEMP0	RSVD	PCHG1	PCHG0

LEGEND: RSVD = Reserved and **must** be programmed to 0

Figure C-3. Operation Cfg A

CC1, CC0 — These bits configure the bq3055 for the number of series cells in the battery stack.

- 0,0 = Reserved
- 0,1 = 2 cell
- 1,0 = 3 cell (default)
- 1,1 = 4 cell

SLEEP — Enables the bq3055 to enter Sleep mode if the SMBus lines are low.

- 0 = The bq3055 never enters Sleep mode
- 1 = The bq3055 enters Sleep mode under normal Sleep entry criteria (default)

Related Variables:

SBS:ManufacturerAccess:Sleep

TEMP1, TEMP0 — These bits configure the source of the *Temperature* function

- 0,0 = Internal Temperature Sensor
- 0,1 = TS1 Input (default)
- 1,0 = Greater Value of TS1 or TS2 Inputs
- 1,1 = Average of TS1 and TS2 Inputs

Related Variables:

SBS:Temperature
SBS:TS1Temperature
SBS:TS2Temperature

PCHG1, PCHG0 — These bits enable or disable Precharge.

- 0,0 = Not defined, both CHG and PCHG FET are disabled
- 0,1 = Precharge: Requires smart charger that can output precharge current autonomously, or by receiving broadcast *Charging Current/Charging Voltage* from the bq3055; Does not support zero-volt charge; PCHG FET is disabled
- 1,0 = Precharge using PCHG FET is enabled (default)
- 1,1 = Not defined, both CHG and PCHG FET are disabled

C.8.1.2 Operation Cfg B

This register enables, disables, or configures various features of the bq3055.

Table C-163. Operation Cfg B

Subclass Name	Name	Format	Size in Bytes	Min Value	Max Value	Default Value	Unit
Configuration	Operation Cfg B	hex	2	0x0000	0xffff	0x0440	

	bit 7	bit 6	bit 5	bit 4	bit 3	bit 2	bit 1	bit 0
High Byte	RSVD	RSVD	RSVD	NCSMB	NRCHG	CSYNC	CHGTERM	CCT
Low Byte	CHGSUSP	OTFET	CHGFET	CHGIN	NR	CPE	HPE	BCAST

Figure C-4. Operation Cfg B

NCSMB — Disables extended SMBUS t_{TIMEOUT} feature. Use this bit with caution.

- 0 = Normal SMBUS t_{TIMEOUT} (default)
- 1 = Extended SMBUS t_{TIMEOUT}

NRCHG — Enables the CHG FET to remain on during sleep when the bq3055 is in non-removable battery mode.

- 0 = CHG FET turns off in Sleep Mode if the **[NR]** bit is set (default)
- 1 = CHG FET remains on in Sleep Mode if the **[NR]** bit is set

Related Variables:

DF:Configuration:Registers:Operation Cfg B[NR]

CSYNC — Enables the bq3055 to write *RemainingCapacity* equal to *FullChargeCapacity* when a valid charge termination is detected.

- 0 = *RemainingCapacity* is not modified on valid primary charge termination
- 1 = *RemainingCapacity* is written to equal *FullChargeCapacity* on valid primary charge termination. (default)

Related Variables:

SBS:RemainingCapacity
SBS:FullChargeCapacity

CHGTERM — This bit enables or disables the **[TCA]** and **[FC]** flags in *BatteryStatus* to be cleared after charge termination is confirmed.

- 0 = **[TCA]** and **[FC]** are not cleared by primary charge termination confirmation, but are cleared by other means. (default)
- 1 = **[TCA]** and **[FC]** flags are cleared on valid primary charge termination. Note: This does not disable clearing the flags by **TCA Clear %** and **FC Clear %**.

Related Variables:

DF:Charge Control:Termination Cfg:Taper Current
DF:Charge Control:Termination Cfg:Current Taper Window
DF:Charge Control:Termination Cfg:TCA Clear %
DF:Charge Control:Termination Cfg:FC Clear %
SBS:Current
SBS:BatteryStatus[FC],[TCA]

CCT — This bit sets the formula for updating *Cycle Count*.

- 0 = The bq3055 uses the **CC Threshold** value. (default)
- 1 = The bq3055 uses **CC %** of *FullChargeCapacity*.

Related Variables:

DF:SBS Configuration:Data:Cycle Count
DF:SBS Configuration:Data:CC Threshold
DF:SBS Configuration Data:CC %

SBS:FullChargeCapacity

CHGSUSP — This bit enables the bq3055 to turn off the CHG FET (and ZVCHG FET) when in charge suspend mode.

0 = No FETs change in Charge Suspend mode. (default)

1 = CHG FET and ZVCHG FET (if used) turn off in Charge Suspend mode.

OTFET — This bit enables or disables FET actions from reacting to an overtemperature fault.

0 = There is NO FET action when an overtemperature condition is detected.

1 = When the [OTC] flag is set, then the CHG FET is turned off, and when the [OTD] flag is set, then the DSG FET is turned off. (default)

Related Variables:

SBS:SafetyStatus[OTC],[OTD]

CHGFET — This bit enables or disables the CHG FET from reacting to a valid charge termination.

0 = CHG FET stays on at charge termination([TCA] is set). (default)

1 = CHG FET turns off at charge termination.

Related Variables:

SBS:BatteryStatus[TCA]

CHGIN — This bit enables the CHG FET and ZVCHG FET (if used) to turn off when the bq3055 is in charge-inhibit mode.

0 = No FET change in charge-inhibit mode. (default)

1 = CHG and ZVCHG FETs, if used, turn off in charge-inhibit mode.

Related Variables:

SBS:ChargingStatus[XCHG]

NR — This bit configures the bq3055 to be in removable or non-removable battery mode and determines the recovery method for current based Primary Protection features.

0 = Removable battery mode. (default)

1 = Non-removable battery mode.

Related Variables:

DF:Configuration:Registers: Non-Removable Cfg

CPE — This bit enables or disables PEC transmissions to the smart-battery charger for master-mode alarm messages.

0 = No PEC byte on alarm warning to charger (default)

1 = PEC byte on alarm warning to charger

HPE — This bit enables or disables PEC transmissions to the smart-battery host for master-mode alarm messages and prevents receiving communications from all sources in slave mode. If the host uses PEC this bit should be set.

- 0 = No PEC byte on alarm warning to host and receiving communications from all sources in slave mode (default)
- 1 = PEC byte on alarm warning to host and receiving communications from all sources in slave mode. If host uses PEC this bit should be set.

BCAST — This bit enables or disables SBS broadcasts to the smart-battery charger and host.

- 0 = Broadcasts to host and charger disabled (default)
- 1 = Broadcasts to host and charger enabled

C.8.1.3 Operation Cfg C

This register enables, disables, or configures various features of the bq3055.

Table C-164. Operation Cfg C

Subclass Name	Name	Format	Size in Bytes	Min Value	Max Value	Default Value	Unit
Configuration	Operation Cfg C	hex	2	0x0000	0xffff	0x0040	

	bit 7	bit 6	bit 5	bit 4	bit 3	bit 2	bit 1	bit 0
High Byte	RSVD	RSVD	RSVD	RSVD	RSVD	RSVD	RSVD	RSVD
Low Byte	RSVD	CUV_REC OV_CHG	RSVD	RSVD	RSVD	SHUTV	PROD_LTPF_ EN	RSOCL

LEGEND: RSVD = Reserved and **must** be programmed to 0

Figure C-5. Operation Cfg C

CUV_RECOV_CHG — This bit configures the cell undervoltage recovery condition.

- 0 (default) = CUV recovery uses voltage criteria only
- 1 = In addition to the voltage criteria, gas gauge must also be in charge mode for CUV recovery; see [Section 1.4.11](#) for more information on gas gauge operating modes.

SHUTV — This bit configures the voltage threshold used when entering Shutdown mode.

- 0 = Shutdown occurs when $Voltage \leq \text{Shutdown Voltage}$ AND $Current \leq 0$ for a period greater than **Shutdown Time**.
- 1 (default) = Shutdown occurs when $\text{Min}(CellVoltage_{4..1}) \leq \text{Cell Shutdown Voltage}$ and $Current \leq 0$ for a period greater than **Cell Shutdown Time**.

PROD_LTPF_EN — .Production Lifetime Data and PF enable bit; this bit enables or disables Lifetime Data and permanent failures from occurring; This bit can be directly set by the LTPF Enable command (See MAC command 0x0021).

- 0 (default) = All Lifetime Data logging and PFs (except DFF) are prevented from occurring.
NOTE: If this bit is set to 0, and a Permanent Failure does occur, PFStatus will still report that the failure has occurred. Also, if the FETs have been turned on, they will turn off if a failure occurs. However, dataflash write access is still granted and the Permanent Failure is NOT logged in the PF Status section of dataflash. The PFStatus indicator will clear and the FETs will turn on once ManufacturerAccess(0x00) has received the *LTPF Enable* (0x0021) command or the Reset (0x0041) command if the Permanent Failure condition no longer exists.
- 1 = All Lifetime Data logging and PFs are allowed

RSOCL — This bit determines the method in which *RelativeStateOfCharge* and *RemainingCapacity* are updated to 100% when charging is complete.

0 (default) = If the **[RSOCL]** bit in **Operation Cfg C** is cleared then *RelativeStateOfCharge* and *RemainingCapacity* are **not** held at 99% until primary charge termination occurs. Fractions of % greater than 99% are rounded up to display 100%.

1 = If the **[RSOCL]** bit in **Operation Cfg C** is set then *RelativeStateOfCharge* and *RemainingCapacity* are held at 99% until primary charge termination occurs and only displays 100% upon entering primary charge termination.

NOTE: PROD_LTPF_EN—If this bit is set to 0, and a Permanent Failure does occur, *PFStatus* would still report that the failure has occurred. Also, if the FETs have been turned on, they will turn off if a failure occurs. However, dataflash write access is still granted and the Permanent Failure is NOT logged in the PF Status section of dataflash. The *PFStatus* indicator will clear and the FETs will turn back on once *ManufacturerAccess(0x00)* has received the *LTPF Enable (0x0021)* command or the *Reset (0x0041)* command, assuming the Permanent Failure condition no longer exists.

C.8.1.4 Permanent Fail Cfg

The **Permanent Fail Cfg** register enables or disables the use of the FUSE pin when the corresponding permanent fail error occurs. If the FUSE pin is driven high **Fuse Flag** is set to 0x3672.

Table C-165. Permanent Fail Cfg

Subclass Name	Name	Format	Size in Bytes	Min Value	Max Value	Default Value	Unit
Configuration	Permanent Fail Cfg	hex	2	0x0000	0x5fff	0x0000	

Related Variables:

- DF:PF Status:Device Status Data:PF Flags1
- DF:PF Status:Device Status Data:Fuse Flag

	bit 7	bit 6	bit 5	bit 4	bit 3	bit 2	bit 1	bit 0
High Byte	RSVD	XPFVSHU T	RSVD	XSOPT	XSOCD	XSOCC	XAFE_P	XAFE_C
Low Byte	XDFE	XDFETF	XCFETF	XCIM	XSOTD	XSOTC	XSOV	XPFIN

LEGEND: RSVD = Reserved and **must** be programmed to 0

Figure C-6. Permanent Fail Cfg

XPFVSHUT — If this bit is set AND any permanent failure happens AND the bq3055 goes into shutdown the FUSE pin is driven high.

Related Variables:

DF:PF Status:Device Status Data:PF Flags1[SOPT]

XSOPT — If this bit is set AND an open thermistor permanent failure occurs the FUSE pin is driven high.

Related Variables:

DF:PF Status:Device Status Data:PF Flags1[SOPT]

XSOCD — If this bit is set AND a discharge safety overcurrent permanent failure occurs the FUSE pin is driven high.

Related Variables:

DF:PF Status:Device Status Data:PF Flags1[SOCD]

XSOCC — If this bit is set AND a charge safety overcurrent failure occurs the FUSE pin is driven high.

Related Variables:

DF:PF Status:Device Status Data:PF Flags1[SOCC]

XAFE_P — If this bit is set AND a periodic AFE-communications permanent failure occurs the FUSE pin is driven high.

Related Variables:

DF:PF Status:Device Status Data:PF Flags1[AFE_P]

XAFE_C — If this bit is set AND an AFE-communications permanent failure occurs the FUSE pin is driven high.

Related Variables:

DF:PF Status:Device Status Data:PF Flags1[AFE_C]

XDFF — If this bit is set AND a Data Flash fault permanent failure occurs the FUSE pin is driven high.

Related Variables:

DF:PF Status:Device Status Data:PF Flags1[DFFF]

XDFETF — If this bit is set AND a DSG FET permanent failure occurs the FUSE pin is driven high.

Related Variables:

DF:PF Status:Device Status Data:PF Flags1[DFETF]

XCFETF — If this bit is set AND a CHG FET permanent failure occurs the FUSE pin is driven high.

Related Variables:

DF:PF Status:Device Status Data:PF Flags1[CFETF]

XCIM — If this bit is set AND a cell imbalance permanent failure occurs the FUSE pin is driven high.

Related Variables:

DF:PF Status:Device Status Data:PF Flags1[CIM]

XSOTD — If this bit is set AND a discharge overtemperature permanent failure occurs the FUSE pin is driven high.

Related Variables:

DF:PF Status:Device Status Data:PF Flags1[SOTD]

XSOTC — If this bit is set AND a charge overtemperature permanent failure occurs the FUSE pin is driven high.

Related Variables:

DF:PF Status:Device Status Data:PF Flags1[SOTC]

XSOV — If this bit is set AND a safety cell overvoltage permanent failure occurs the FUSE pin is driven high.

Related Variables:

DF:PF Status:Device Status Data:PF Flags1[SOV]

XPFIN — If this bit is set AND an external input indication permanent failure occurs the FUSE pin is driven high.

Related Variables:

DF:PF Status:Device Status Data:PF Flags1[PFIN]

C.8.1.5 Non-Removable Cfg

If the bq3055 is in removable battery mode ($[NR] = 0$) these bits sets the recovery method from 1st level security errors. If the corresponding bit is set it gives an additional recovery option for the particular fault. If $[NR]$ is set to 1 this register has no effect.

Table C-166. Non Removable Cfg

Subclass Name	Name	Format	Size in Bytes	Min Value	Max Value	Default Value	Unit
Configuration	Non-Removable Cfg	hex	2	0x0000	0x3b17	0x0000	

Related Variables:

- DF:Configuration:Registers:Operation Cfg B[NR]

	bit 7	bit 6	bit 5	bit 4	bit 3	bit 2	bit 1	bit 0
High Byte	RSVD	RSVD	OCD	OCC	RSVD	RSVD	RSVD	RSVD
Low Byte	RSVD	RSVD	OC	RSVD	RSVD	AOCD	SCC	SCD

 LEGEND: RSVD = Reserved and **must** be programmed to 0

Figure C-7. Non-Removable Cfg

OCD — Overcurrent in Discharge

OCC — Overcurrent in Charge

OC — Overcharge

AOCD — AFE Overcurrent in Discharge

SCC — Short Circuit in Charge

SCD — Short Circuit in Discharge

C.8.2 AFE

C.8.2.1 AFE State_Ctl

This register adjusts the AFE hardware overcurrent and short circuit protection thresholds and delay.

Table C-167. AFE State_Ctl

Subclass Name	Name	Format	Size in Bytes	Min Value	Max Value	Default Value	Unit
AFE	AFE State_Ctl	hex	1	0x00	0x30	0x00	

Related Variables:

- DF:1st Level Safety:Current:AFE OC Dsg
- DF:1st Level Safety:Current:AFE SC Chg Cfg
- DF:1st Level Safety:Current:AFE SC Dsg Cfg

Low Byte	bit 7	bit 6	bit 5	bit 4	bit 3	bit 2	bit 1	bit 0
	RSVD	RSVD	SCDDX2	RSNS	RSVD	RSVD	RSVD	RSVD

LEGEND: RSVD = Reserved and **must** be programmed to 0

Figure C-8. AFE State_Ctl

SCDDX2 — Set this bit to double the SCD delay periods

0 (default) = Short Circuit current protection delay is as programmed

1 = Short Circuit current protection delay is twice that programmed

RSNS — This bit, if set, configures the OCD, SCC, and SCD thresholds into a range suitable for a low sense resistor value by dividing the OCDV, SCCV, and SCDV selected voltage thresholds by 2

0 (default) = Current protection voltage thresholds as programmed

1 = Current protection voltage thresholds divided by 2 as programmed

C.9 Power**C.9.1 Power****C.9.1.1 Flash Update OK Voltage**

This value sets the minimum allowed battery pack voltage for a flash update. If the battery pack *Voltage* is below this threshold no flash update will be made. However, if *PackVoltage* \geq **Flash Update OK Voltage** then the flash can be updated.

Table C-168. Flash Update OK Voltage

Subclass Name	Name	Format	Size in Bytes	Min Value	Max Value	Default Value	Unit
Power	Flash Update OK Voltage	unsigned integer	2	6000	20000	7500	mV

Related Variables:

- DF:Power:Power:AFE Shutdown Voltage
- SBS:Voltage

C.9.1.2 Shutdown Voltage

The bq3055 goes into shutdown mode if the battery pack *Voltage* is equal to or less than **Shutdown Voltage** for **Shutdown Time** and has been out of shutdown mode for at least **Shutdown Time**.

Table C-169. Shutdown Voltage

Subclass Name	Name	Format	Size in Bytes	Min Value	Max Value	Default Value	Unit
Power	Shutdown Voltage	unsigned integer	2	5000	20000	5250	mV

Related Variables:

- DF:Power:Power:Shutdown Time
- SBS:Voltage

C.9.1.3 Shutdown Time

The bq3055 goes into shutdown mode if the battery pack *Voltage* is equal to or less than **Shutdown Voltage** for **Shutdown Time** and has been out of shutdown mode for at **Shutdown Time**.

Table C-170. Shutdown Time

Subclass Name	Name	Format	Size in Bytes	Min Value	Max Value	Default Value	Unit
Power	Shutdown Time	unsigned integer	1	0	240	10	s

Related Variables:

- DF:Power:Power:Shutdown Voltage
- SBS:Voltage

C.9.1.4 Cell Shutdown Voltage

The bq3055 goes into shutdown mode if Min (*CellVoltage4..1*) is equal to or less than **Cell Shutdown Voltage** for 10s and has been out of shutdown mode for at least **Cell Shutdown Time**.

Table C-171. Shutdown Voltage

Subclass Name	Name	Format	Size in Bytes	Min Value	Max Value	Default Value	Unit
Power	Cell Shutdown Voltage	unsigned integer	2	0	5000	1750	mV

Related Variables:

- DF:Power:Power:Cell Shutdown Time
- SBS:CellVoltage4
- SBS:CellVoltage3
- SBS:CellVoltage2
- SBS:CellVoltage1

C.9.1.5 Cell Shutdown Time

The bq3055 goes into shutdown mode if Min (*CellVoltage4..1*) is equal to or less than **Cell Shutdown Voltage** for 10s and has been out of shutdown mode for at least **Cell Shutdown Time**.

Table C-172. Shutdown Time

Subclass Name	Name	Format	Size in Bytes	Min Value	Max Value	Default Value	Unit
Power	Cell Shutdown Time	unsigned integer	1	0	240	10	s

Related Variables:

- DF:Power:Power:Cell Shutdown Voltage
- SBS:CellVoltage4
- SBS:CellVoltage3

- SBS:CellVoltage2
- SBS:CellVoltage1

C.9.1.6 AFE Shutdown Voltage

The bq3055 detects a charger when the *PackVoltage*, measured by the bq3055 at the PACK pin is above the **AFE Shutdown Voltage** threshold. If either *Voltage* or *PackVoltage* is greater than the **Flash Update OK Voltage** the data flash can be updated. Recommended setting for this value is 4000 mV.

Table C-173. AFE Shutdown Voltage

Subclass Name	Name	Format	Size in Bytes	Min Value	Max Value	Default Value	Unit
Power	AFE Shutdown Voltage	unsigned integer	2	0	5000	4000	mV

Related Variables:

- DF:Power:Power:Flash Update OK Voltage
- SBS:Voltage
- SBS:PackVoltage

C.9.1.7 Sleep Current

The bq3055 is allowed to go into sleep mode if the charge or discharge current is below **Sleep Current**. Sleep mode can be enabled with the **[SLEEP]** bit. If the absolute value of *Current* is above **Sleep Current** the bq3055 will return to normal mode.

Table C-174. Sleep Current

Subclass Name	Name	Format	Size in Bytes	Min Value	Max Value	Default Value	Unit
Power	Sleep Current	unsigned integer	2	0	100	10	mA

Related Variables:

- DF:Configuration:Registers:Operation Cfg A[SLEEP]
- DF:Power:Power:Bus Low Time
- SBS:ManufacturerAccess:Sleep
- SBS:Current

C.9.1.8 Bus Low Time

The bq3055 is allowed to go into sleep mode if it is enabled with the **[SLEEP]** bit if the SMBus lines are low for a period greater than **Bus Low Time**.

Table C-175. Bus low Time

Subclass Name	Name	Format	Size in Bytes	Min Value	Max Value	Default Value	Unit
Power	Bus Low Time	unsigned integer	1	0	255	5	s

Related Variables:

- DF:Configuration:Registers:Operation Cfg A[SLEEP]
- DF:Power:Power:Sleep Current

C.9.1.9 Cal Inhibit Temp Low

The bq3055 does not perform auto-calibration on entry to sleep mode if *Temperature* is below **Cal Inhibit Temp Low** or above **Cal Inhibit Temp High**.

Table C-176. Cal Inhibit Temp Low

Subclass Name	Name	Format	Size in Bytes	Min Value	Max Value	Default Value	Unit
Power	Cal Inhibit Temp Low	signed integer	2	-400	1200	50	0.1°C

Related Variables:

- DF:Power:Power:Cal Inhibit Temp High
- SBS:Temperature

C.9.1.10 Cal Inhibit Temp High

The bq3055 does not perform auto-calibration on entry to sleep mode if *Temperature* is below **Cal Inhibit Temp Low** or above **Cal Inhibit Temp High**

Table C-177. Cal Inhibit Temp High

Subclass Name	Name	Format	Size in Bytes	Min Value	Max Value	Default Value	Unit
Power	Cal Inhibit Temp High	signed integer	2	-400	1200	450	0.1°C

Related Variables:

- DF:Power:Power:Cal Inhibit Temp Low
- SBS:Temperature

C.9.1.11 Sleep Voltage Time

During sleep mode temperature and voltage measurements will be taken in **Sleep Voltage Time** intervals.

Table C-178. Sleep Voltage Time

Subclass Name	Name	Format	Size in Bytes	Min Value	Max Value	Default Value	Unit
Power	Sleep Voltage Time	unsigned integer	1	1	240	5	s

Related Variables:

- DF:Configuration:Registers:Operation Cfg A[SLEEP]
- SBS:Temperature
- SBS:Voltage
- SBS:CellVoltage4
- SBS:CellVoltage3
- SBS:CellVoltage2
- SBS:CellVoltage1

C.9.1.12 Sleep Current Time

During sleep mode current will be measured in **Sleep Current Time** intervals.

Table C-179. Sleep Current Time

Subclass Name	Name	Format	Size in Bytes	Min Value	Max Value	Default Value	Unit
Power	Sleep Current Time	unsigned integer	1	1	255	20	s

Related Variables:

- DF:Configuration:Registers:Operation Cfg A[SLEEP]
- SBS:Current

C.9.1.13 Wake Current Reg

Wake Current Reg configures the current threshold required to wake the bq3055 from sleep mode by detecting voltage across SRP and SRN.

Table C-180. Wake Current Reg

Subclass Name	Name	Format	Size in Bytes	Min Value	Max Value	Default Value	Unit
Power	Wake Current Reg	hex	1	0x00	0x07	0x00	

	bit 7	bit 6	bit 5	bit 4	bit 3	bit 2	bit 1	bit 0
Low Byte	RSVD	RSVD	RSVD	RSVD	RSVD	IWAKE	RSNS1	RSNS0

LEGEND: RSVD = Reserved and **must** be programmed to 0

Figure C-9. Wake Current Reg

IWAKE — This bit sets the current threshold for the Wake function.

0 = 0.5A (or if RSNS0=RSNS1=0 then this function is disabled)

1 = 1.0A (or if RSNS0=RSNS1=0 then this function is disabled)

Table C-181. Wake Current Reg

RSNS1	RSNS0	Resistance
0	0	Disabled (default)
0	1	2.5 mΩ
1	0	5 mΩ
1	1	10mΩ

Related Variables:

- DF:Configuration:Registers:Operation Cfg A[SLEEP]
- SBS:Current

C.10 1st Level Safety Class**C.10.1 Voltage****C.10.1.1 LT COV Threshold**

When the bq3055 is operating in the low temperature range (see [Section 1.1](#)), it sets the [COV] flag in *SafetyStatus* if any *CellVoltage4..1* is equal to or higher than the **LT COV Threshold** for a period of 2 s.

Table C-182. LT COV Threshold

Subclass Name	Name	Format	Size in Bytes	Min Value	Max Value	Default Value	Unit
Voltage	LT COV Threshold	Integer	2	3700	5000	4300	mV

Related Variables:

- DF:1st Level Safety:Voltage:LT COV Recovery
- SBS:CellVoltage4
- SBS:CellVoltage3
- SBS:CellVoltage2
- SBS:CellVoltage1
- SBS:SafetyStatus[COV]
- SBS:TempRange

C.10.1.2 LT COV Recovery

When the bq3055 is operating in the low temperature range it recovers from a cell overvoltage condition if all cell voltages are lower than the **LT COV Recovery** threshold level.

Table C-183. LT COV Recovery

Subclass Name	Name	Format	Size in Bytes	Min Value	Max Value	Default Value	Unit
Voltage	LT COV Recovery	Integer	2	0	4400	3900	mV

Related Variables:

- DF:1st Level Safety:Voltage:LT COV Threshold
- SBS:CellVoltage4
- SBS:CellVoltage3
- SBS:CellVoltage2
- SBS:CellVoltage1
- SBS:SafetyStatus[COV]
- SBS:TempRange

C.10.1.3 ST COV Threshold

When the bq3055 is operating in the standard temperature range 1 or 2 (see [Section 1.1](#)), it sets the [COV] flag in *SafetyStatus* if any *CellVoltage4..1* is equal to or higher than the **ST COV Threshold** for a period of 2 s.

Table C-184. ST COV Threshold

Subclass Name	Name	Format	Size in Bytes	Min Value	Max Value	Default Value	Unit
Voltage	ST COV Threshold	Integer	2	3700	5000	4500	mV

Related Variables:

- DF:1st Level Safety:Voltage:ST COV Recovery
- SBS:CellVoltage4
- SBS:CellVoltage3
- SBS:CellVoltage2
- SBS:CellVoltage1
- SBS:SafetyStatus[COV]
- SBS:TempRange

C.10.1.4 ST COV Recovery

When the bq3055 is operating in the standard temperature range 1 or 2, it recovers from a cell overvoltage condition if all cell voltages are lower than the **ST COV Recovery** threshold level.

Table C-185. ST COV Recovery

Subclass Name	Name	Format	Size in Bytes	Min Value	Max Value	Default Value	Unit
Voltage	ST COV Recovery	Unsigned integer	2	0	4400	4100	mV

Related Variables:

- DF:1st Level Safety:Voltage:ST COV Threshold
- SBS:CellVoltage4
- SBS:CellVoltage3
- SBS:CellVoltage2
- SBS:CellVoltage1
- SBS:SafetyStatus[COV]
- SBS:TempRange

C.10.1.5 HT COV Threshold

When the bq3055 is operating in the high temperature range (see [Section 1.1](#)), it sets the [COV] flag in *SafetyStatus* if any *CellVoltage4..1* is equal to or higher than the **HT COV Threshold** for a period of 2 s.

Table C-186. HT COV Threshold

Subclass Name	Name	Format	Size in Bytes	Min Value	Max Value	Default Value	Unit
Voltage	HT COV Threshold	Integer	2	3700	5000	4400	mV

Related Variables:

- DF:1st Level Safety:Voltage:HT COV Recovery
- SBS:CellVoltage4
- SBS:CellVoltage3
- SBS:CellVoltage2
- SBS:CellVoltage1
- SBS:SafetyStatus[COV]
- SBS:TempRange

C.10.1.6 HT COV Recovery

When the bq3055 is operating in the high temperature range, it recovers from a cell overvoltage condition if all cell voltages are lower than the **HT COV Recovery** threshold level.

Table C-187. HT COV Recovery

Subclass Name	Name	Format	Size in Bytes	Min Value	Max Value	Default Value	Unit
Voltage	HT COV Recovery	Integer	2	0	4400	4000	mV

Related Variables:

- DF:1st Level Safety:Voltage:HT COV Threshold
- SBS:CellVoltage4
- SBS:CellVoltage3
- SBS:CellVoltage2
- SBS:CellVoltage1
- SBS:SafetyStatus[COV]
- SBS:TempRange

C.10.1.7 CUV Threshold

The bq3055 sets the [CUV] *SafetyAlert* if any *CellVoltage4..1* is equal to or lower than the **CUV Threshold** for a period of 2 s.

Table C-188. CUV Threshold

Subclass Name	Name	Format	Size in Bytes	Min Value	Max Value	Default Value	Unit
Voltage	CUV Threshold	unsigned integer	2	0	3500	2200	mV

Related Variables:

- SBS:CellVoltage4
- SBS:CellVoltage3
- SBS:CellVoltage2
- SBS:CellVoltage1
- SBS:SafetyAlert[CUV]

C.10.1.8 CUV Recovery

The bq3055 recovers from a cell under voltage condition, if all *CellVoltage4..1* are higher than the **CUV Recovery** threshold. On recovery, the *ChargingCurrent* and *ChargingVoltage* are set to their appropriate value per the charging algorithm, the [TDA] and [FD] flags are reset, the [CUV] in *SafetyStatus* is reset, and the [XDSG] flag in *OperationStatus* is reset.

Table C-189. CUV Recovery

Subclass Name	Name	Format	Size in Bytes	Min Value	Max Value	Default Value	Unit
Voltage	CUV Recovery	unsigned integer	2	0	3600	3000	mV

Related Variables:

- DF:1st Level Safety:Voltage:CUV Threshold
- SBS:Charging Current
- SBS:Charging Voltage
- SBS:BatteryStatus[TDA],[FD]
- SBS:CellVoltage4
- SBS:CellVoltage3
- SBS:CellVoltage2
- SBS:CellVoltage1
- SBS:SafetyStatus[CUV]
- SBS:OperationStatus[XDSG]

C.10.2 Current

C.10.2.1 OC (1st Tier) Chg

The bq3055 sets the [OCC] *SafetyAlert* if charge *Current* is equal to or higher than the **OC (1st Tier) Chg** threshold.

Table C-190. OC (1st Tier) Chg

Subclass Name	Name	Format	Size in Bytes	Min Value	Max Value	Default Value	Unit
Current	OC (1st Tier) Chg	unsigned integer	2	0	20000	6000	mA

Related Variables:

- DF:1st Level Safety:Current:OC (1st Tier) Chg Time
- SBS:Current
- SBS:SafetyAlert[OCC]

C.10.2.2 OC (1st Tier) Chg Time

If the [OCC] in *SafetyAlert* time period exceeds the **OC (1st Tier) Chg Time** time the bq3055 goes into an overcurrent charge condition. This function is disabled if **OC (1st Tier) Chg Time** is set to 0.

In an overcurrent while charging condition the CHG FET is turned off, the *ChargeCurrent* and *ChargeVoltage* are set to 0, the [TCA] flag is set, the [OCC] flag in *SafetyAlert* is cleared, and the [OCC] flag in *SafetyStatus* is set.

Table C-191. OC (1st Tier) Chg Time

Subclass Name	Name	Format	Size in Bytes	Min Value	Max Value	Default Value	Unit
Current	OC (1st Tier) Chg Time	unsigned integer	1	0	240	2	s

Related Variables:

- DF:1st Level Safety:Current:OC (1st Tier) Chg
- SBS:Charging Current
- SBS:Charging Voltage
- SBS:BatteryStatus[TCA]
- SBS:SafetyAlert[OCC]
- SBS:SafetyStatus[OCC]

C.10.2.3 OC Chg Recovery

The bq3055 recovers from an overcurrent charge condition in non-removable battery mode if the *AverageCurrent* is equal to or lower than the **OC Chg Recovery** threshold for a length of **Current Recovery Time**. The bq3055 recovers in removable battery mode by removing and reinserting the battery pack. On recovery, the *ChargingCurrent* and *ChargingVoltage* are set to appropriate their values per the charging algorithm, [TCA] is reset, and the [OCC] flag in *SafetyStatus* is reset.

Table C-192. OC Chg Recovery

Subclass Name	Name	Format	Size in Bytes	Min Value	Max Value	Default Value	Unit
Current	OC Chg Recovery	signed integer	2	-1000	1000	200	mA

Related Variables:

- DF:1st Level Safety:Current:OC (1st Tier) Chg
- DF:1st Level Safety:Current Recovery Time
- DF:Configuration:Registers:Operation Cfg B[NR]
- SBS:AverageCurrent
- SBS:BatteryStatus[TCA]
- SBS:SafetyStatus[OCC]

C.10.2.4 OC (1st Tier) Dsg

The bq3055 sets the [OCD] *SafetyAlert* if the discharge *Current* is equal to or higher than the **OC (1st Tier) Dsg** threshold.

Table C-193. OC (1st Tier) Dsg

Subclass Name	Name	Format	Size in Bytes	Min Value	Max Value	Default Value	Unit
Current	OC (1st Tier) Dsg	unsigned integer	2	0	20000	6000	mA

Related Variables:

- DF:1st Level Safety:Current:OC (1st Tier) Dsg Time
- SBS:Current
- SBS:SafetyAlert[OCD]

C.10.2.5 OC (1st Tier) Dsg Time

If the [OCD] in *SafetyAlert* time period exceeds the **OC (1st Tier) Dsg Time** bq3055 goes into an overcurrent discharge condition. This function is disabled if **OC (1st Tier) Dsg Time** is set to 0.

In an overcurrent discharge condition the DSG FET is turned off, the *ChargeCurrent* is set to **Pre-chg Current**, the [TDA] flag is set, the [OCD] flag in *SafetyAlert* is reset, the [OCD] flag in *SafetyStatus* is set, and the [XDSG] flag is set.

Table C-194. OC (1st Tier) Dsg Time

Subclass Name	Name	Format	Size in Bytes	Min Value	Max Value	Default Value	Unit
Current	OC (1st Tier) Dsg Time	unsigned integer	1	0	240	2	s

Related Variables:

- DF:1st Level Safety:Current:OC (1st Tier) Dsg
- DF:Charge Control:Pre-Charge Cfg:Pre-chg Current
- SBS:ChargingCurrent
- SBS:ChargingVoltage
- SBS:BatteryStatus[TDA]
- SBS:SafetyAlert[OCD]
- SBS:SafetyStatus[OCD]
- SBS:OperationStatus[XDSG]

C.10.2.6 OC Dsg Recovery

The bq3055 recovers from an overcurrent discharge condition in non-removable battery mode if the *AverageCurrent* is equal to or lower than the **OC Dsg Recovery** current level for a length of **Current Recovery Time**. On recovery, the *ChargingCurrent* and *ChargingVoltage* are set to their appropriate values per the charging algorithm, [TDA] is reset, the [OCD] *SafetyStatus* flag is reset, and the [XDSG] flag is reset

Table C-195. OC Dsg Recovery

Subclass Name	Name	Format	Size in Bytes	Min Value	Max Value	Default Value	Unit
Current	OC Dsg Recovery	signed integer	2	0	1000	200	mA

Related Variables:

- DF:1st Level Safety:Current:OC (1st Tier) Dsg
- DF:1st Level Safety:Current Recovery Time
- DF:Configuration:Registers:Operation Cfg B[NR]
- SBS:AverageCurrent

- SBS:ChargingCurrent
- SBS:ChargingVoltage
- SBS:BatteryStatus[TDA]
- SBS:SafetyStatus[OCD]
- SBS:OperationStatus[XDSG]

C.10.2.7 Current Recovery Time

The **Current Recovery Time** sets the minimum time period where the *AverageCurrent* need to be below the overcurrent charge/discharge recovery threshold to recover from an overcurrent charge/discharge condition.

Table C-196. Current Recovery Time

Subclass Name	Name	Format	Size in Bytes	Min Value	Max Value	Default Value	Unit
Current	Current Recovery Time	unsigned integer	1	0	240	8	s

Related Variables:

- DF:1st Level Safety:Current:OC Chg Recovery
- DF:1st Level Safety:Current:OC Dsg Recovery
- SBS:AverageCurrent

C.10.2.8 AFE OC Dsg

The **AFE OC Dsg** threshold sets the OCDV register of the integrated AFE device. Changes to this data flash value requires a software full reset or a power reset of the bq3055 to take effect.

Table C-197. AFE OC Dsg

Subclass Name	Name	Format	Size in Bytes	Min Value	Max Value	Default Value	Unit
Current	AFE OC Dsg	hex	1	0x00	0x0f	0x07	

	bit 7	bit 6	bit 5	bit 4	bit 3	bit 2	bit 1	bit 0
AFE OCDV Register	RSVD	RSVD	RSVD	RSVD	OCDV3	OCDV2	OCDV1	OCDV0

LEGEND: RSVD = Reserved and must be programmed to 0.

Figure C-10. OCDV Register

OCDV3, OCDV2, OCDV1, OCDV0 — Sets the overload voltage threshold

[RSNS] = 0, sets the voltage threshold between 50 mV and 200 mV in 10-mV steps.
0x00–0x0f =

[RSNS] = 1, sets the voltage threshold between 20 mV and 100 mV in 5-mV steps.
0x00–0x0f =

Table C-198. OCDV (b3–b0) Configuration Bits with Corresponding Voltage Threshold When STATE_CTL[RSNS] = 0

OCDV (b3–b0) configuration bits with corresponding voltage threshold			
0x00	0.050 V	0x08	0.130 V
0x01	0.060 V	0x09	0.140 V
0x02	0.070 V	0x0a	0.150 V
0x03	0.080 V	0x0b	0.160 V
0x04	0.090 V	0x0c	0.170 V

Table C-198. OCDV (b3-b0) Configuration Bits with Corresponding Voltage Threshold When STATE_CTL[RSNS] = 0 (continued)

OCDV (b3-b0) configuration bits with corresponding voltage threshold			
0x05	0.100 V	0x0d	0.180 V
0x06	0.110 V	0x0e	0.190 V
0x07	0.120 V	0x0f	0.200 V

Table C-199. OCDV (b3-b0) Configuration Bits with Corresponding Voltage Threshold When STATE_CTL[RSNS] = 1

OCDV (b3-b0) configuration bits with corresponding voltage threshold(1)			
0x00	0.025 V	0x08	0.065 V
0x01	0.030 V	0x09	0.070 V
0x02	0.035 V	0x0a	0.075 V
0x03	0.040 V	0x0b	0.080 V
0x04	0.045 V	0x0c	0.085 V
0x05	0.050 V	0x0d	0.090 V
0x06	0.055 V	0x0e	0.095 V
0x07	0.060 V	0x0f	0.100 V

Related Variables:

- DF:1st Level Safety:Current:AFE OC Dsg Time
- SBS:ChargingCurrent
- SBS:BatteryStatus[TDA]
- SBS:SafetyStatus[AOCD]

C.10.2.9 AFE OC Dsg Time

The **AFE OC Discharge Time** is programmed into the OCDD register of the integrated AFE device. If an overcurrent discharge condition is detected, *ChargingCurrent* is set to 0, [TDA] in **BatteryStatus** is set, and [AOCD] in **SafetyStatus** is set. Changes to this data flash value requires a software full reset or a power reset of the bq3055 to take effect.

Table C-200. AFE OC Time

Subclass Name	Name	Format	Size in Bytes	Min Value	Max Value	Default Value	Unit
Current	AFE OC Dsg Time	hex	1	0x00	0x0f	0x0f	

	bit 7	bit 6	bit 5	bit 4	bit 3	bit 2	bit 1	bit 0
AFE OCDD Register	RSVD	RSVD	RSVD	RSVD	OCDD3	OCDD2	OCDD1	OCDD0

LEGEND: RSVD = Reserved and **must** be programmed to 0

Figure C-11. OCDD Register

OCDD3, OCDD2, OCDD1, OCDD0 — Sets the overload voltage delay

0x00–0x0f = sets the overvoltage trip delay between 1 ms–31 ms in 2-ms steps

Table C-201. OCDD (b3-b0) Configuration Bits with Corresponding OC Dsg Delay Time

Setting	Time	Setting	Time	Setting	Time	Setting	Time
0x00	1 ms	0x04	9 ms	0x08	17 ms	0x0c	25 ms
0x01	3 ms	0x05	11 ms	0x09	19 ms	0x0d	27 ms

Table C-201. OCDD (b3-b0) Configuration Bits with Corresponding OC Dsg Delay Time (continued)

Setting	Time	Setting	Time	Setting	Time	Setting	Time
0x02	5 ms	0x06	13 ms	0x0a	21 ms	0x0e	29 ms
0x03	7 ms	0x07	15 ms	0x0b	23 ms	0x0f	31 ms

Related Variables:

- DF:1st Level Safety:Current:AFE OC Dsg
- SBS:ChargingCurrent
- SBS:BatteryStatus[TDA]
- SBS:SafetyStatus[AOCD]

C.10.2.10 AFE OC Dsg Recovery

The bq3055 recovers from an overcurrent discharge condition in non-removable battery mode if the *AverageCurrent* is equal to or lower than the **(-)AFE OC Dsg Recovery** current level for the length of **Current Recovery Time**. On recovery, the *ChargingCurrent* and *ChargingVoltage* are set to their appropriate values per the charging algorithm, [TDA] is reset, the [AOCD] flag in *SafetyStatus* is reset, and [XDMSG] is reset

Table C-202. AFE OC Dsg Recovery

Subclass Name	Name	Format	Size in Bytes	Min Value	Max Value	Default Value	Unit
Current	AFE OC Dsg Recovery	signed integer	2	10	1000	5	mA

Related Variables:

- DF:1st Level Safety:Current:AFE OC Dsg
- DF:1st Level Safety:Current Recovery Time
- DF:Configuration:Registers:Operation Cfg B[NR]
- SBS:AverageCurrent
- SBS:BatteryStatus[TCA]
- SBS:SafetyStatus[AOCD]
- SBS:OperationStatus[XDMSG]

C.10.2.11 AFE SC Chg Cfg

The **AFE SC Charge Cfg** is programmed into the SCC register of the integrated AFE device. **AFE SC Charge Cfg** sets the short circuit in charging voltage threshold and the short circuit in charging delay of the integrated AFE. Changes to this data flash value requires a software full reset or a power reset of the bq3055 to take effect.

If the bq3055 identifies a charge in short circuit situation, *ChargingCurrent* and *ChargingVoltage* are set to 0, [TCA] in *BatteryStatus* is set, and [SCC] in *SafetyStatus* is set.

Table C-203. AFE SC Chg Cfg

Subclass Name	Name	Format	Size in Bytes	Min Value	Max Value	Default Value	Unit
Current	AFE SC Chg Cfg	hex	1	0x00	0xf7	0x73	

	bit 7	bit 6	bit 5	bit 4	bit 3	bit 2	bit 1	bit 0
AFE SCC Register	SCCD3	SCCD2	SCCD1	SCCD0	—	SCCV2	SCCV1	SCCV0

Figure C-12. SCC Register

SCCD3, SCCD2, SCCD1, SCCD0 — Sets the short circuit delay in charging

0x0–0xf = Sets the short circuit delay in charging between 0 μ s–915 μ s in 61- μ s steps. Exceeding the short circuit in charge voltage threshold for longer than this period turns off the CHG and DSG outputs. 0000 is the AFE power on reset default.

SCCV2, SCCV1, SCCV0 — Sets the short circuit voltage threshold in charging

[RSNS] = 0, Sets the short circuit voltage threshold between 100 mV and 300 mV in 50-mV steps.
0x0–0x4 = Note: Settings for 0x05 to 0x07 are not supported.

[RSNS] = 1, Sets the short circuit voltage threshold between 50 mV and 225 mV in 25-mV steps
0x0–0x7 =

SCC (b3) — Not used.

Table C-204. SCCV (b2-b0) Configuration Bits with Corresponding Voltage Threshold When STATE_CTL[RSNS] = 0

Setting	Threshold	Setting	Threshold
0x00	–0.100 V	0x04	–0.300 V
0x01	–0.150 V	0x05	N/A
0x02	–0.200 V	0x06	N/A
0x03	–0.250 V	0x07	N/A

Table C-205. SCCV (b2-b0) Configuration Bits with Corresponding Voltage Threshold When STATE_CTL[RSNS] = 1

Setting	Threshold	Setting	Threshold
0x00	–0.050 V	0x04	–0.150 V
0x01	–0.075 V	0x05	–0.175 V
0x02	–0.100 V	0x06	–0.200 V
0x03	–0.125 V	0x07	–0.225 V

Table C-206. SCCD (b7-b4) Configuration Bits with Corresponding SC Chg Delay Time

Setting	Time	Setting	Time	Setting	Time	Setting	Time
0x00	0 μ s	0x04	244 μ s	0x08	488 μ s	0x0c	732 μ s
0x01	61 μ s	0x05	305 μ s	0x09	549 μ s	0x0d	793 μ s
0x02	122 μ s	0x06	366 μ s	0x0a	610 μ s	0x0e	854 μ s
0x03	183 μ s	0x07	427 μ s	0x0b	671 μ s	0x0f	915 μ s

Related Variables:

- DF:1st Level Safety:Current:AFE SC Recovery
- SBS:ChargingCurrent
- SBS:ChargingVoltage
- SBS:BatteryStatus[TCA]
- SBS:SafetyStatus[SCC]

C.10.2.12 AFE SC Dsg Cfg

The **AFE SC Dsg Cfg** is programmed into the SCD register of the integrated AFE device. The **AFE SC Dsg Cfg** sets the short circuit in discharging voltage threshold and the short circuit in discharging delay of the integrated AFE. Changes to this data flash value requires a software full reset or a power reset of the bq3055 to take effect.

If the bq3055 identifies a discharge in short circuit situation from the integrated AFE *ChargingCurrent* and *ChargingVoltage* are set to 0, *[TDA]* in *BatteryStatus* is set, *[SCD]* in *SafetyStatus* is set, and *[XDSG]* in *OperationStatus* is set.

Table C-207. AFE SC Dsg Cfg

Subclass Name	Name	Format	Size in Bytes	Min Value	Max Value	Default Value	Unit
Current	AFE SC Dsg Cfg	hex	1	0x00	0xff	0x77	

	bit 7	bit 6	bit 5	bit 4	bit 3	bit 2	bit 1	bit 0
AFE SCD Register	SCDD3	SCDD2	SCDD1	SCDD0	—	SCDV2	SCDV1	SCDV0

Figure C-13. SCD Register

SCDD3, SCDD2, SCDD1, SCDD0 — Sets the short circuit delay in discharging of the integrated AFE

0x0–0xf = Sets the short circuit in discharging delay between 0 μ s–915 μ s in 61- μ s steps. Exceeding the short circuit in discharge voltage threshold for longer than this period turns off the CHG and DSG outputs. 0000 is the AFE power on reset default. If STATE_CTL[SCDDx2] is set, the delay time is double of that programmed in this register.

SCDV2, SCDV1, SCDV0 — Sets the short circuit voltage threshold in discharging of the integrated AFE

[RSNS] = 0, Sets the short circuit voltage threshold between 100 mV and 450 mV in 50-mV steps
0x0–0x7 =

[RSNS] = 1, Sets the short circuit voltage threshold between 50 mV and 475 mV in 25-mV steps
0x0–0x7 =

SCD (b3) — Not used.

Table C-208. SCDV (b2-b0) Configuration Bits with Corresponding Voltage Threshold When STATE_CTL[RSNS] = 0

Setting	Threshold	Setting	Threshold
0x00	0.100 V	0x04	0.300 V
0x01	0.150 V	0x05	0.350 V
0x02	0.200 V	0x06	0.400 V
0x03	0.250 V	0x07	0.450 V

Table C-209. SCDV (b2-b0) Configuration Bits with Corresponding Voltage Threshold When STATE_CTL[RSNS] = 1

Setting	Threshold	Setting	Threshold
0x00	0.050 V	0x04	0.150 V
0x01	0.075 V	0x05	0.175 V
0x02	0.100 V	0x06	0.200 V
0x03	0.125 V	0x07	0.225 V

Table C-210. SCDD (b7-b4) Configuration Bits with Corresponding SC Dsg Delay Time

Setting	Time	Setting	Time	Setting	Time	Setting	Time
0x00	0 μ s	0x04	244 μ s	0x08	488 μ s	0x0c	732 μ s
0x01	61 μ s	0x05	305 μ s	0x09	549 μ s	0x0d	793 μ s
0x02	122 μ s	0x06	366 μ s	0x0a	610 μ s	0x0e	854 μ s

Table C-210. SCDD (b7-b4) Configuration Bits with Corresponding SC Dsg Delay Time (continued)

Setting	Time	Setting	Time	Setting	Time	Setting	Time
0x03	183 μ s	0x07	427 μ s	0x0b	671 μ s	0x0f	915 μ s

Related Variables:

- DF:1st Level Safety:Current:AFE SC Recovery
- SBS:ChargingCurrent
- SBS:ChargingVoltage
- SBS:BatteryStatus[TDA]
- SBS:SafetyStatus[SCD]
- SBS:OperationStatus[XDSG]

C.10.2.13 AFE SC Recovery

The bq3055 recovers from a short circuit in charging or discharging condition in non-removable battery mode if the absolute value of *AverageCurrent* is equal to or lower than the **AFE SC Recovery** current level for the length of **Current Recovery Time**. On recovery, the *ChargingCurrent* and *ChargingVoltage* are set to their appropriate values per the charging algorithm, [TDA] and [TCA] in *BatteryStatus* are reset, [SCC] and [SCD] in *SafetyStatus* are reset, and [XDSG] is reset

Table C-211. AFE SC Recovery

Subclass Name	Name	Format	Size in Bytes	Min Value	Max Value	Default Value	Unit
Current	AFE SC Recovery	unsigned integer	2	0	200	1	mA

Related Variables:

- DF:1st Level Safety:Current Recovery Time
- DF:1st Level Safety:Current:AFE SC Chg Cfg
- DF:1st Level Safety:Current:AFE SC Dsg Cfg
- DF:Configuration:Registers:Operation Cfg B[NR]
- SBS:AverageCurrent
- SBS:BatteryStatus[TCA],[TDA]
- SBS:SafetyStatus[SCC],[SCD]
- SBS:OperationStatus[XDSG]

C.10.3 Temperature
C.10.3.1 Over Temp Chg

The bq3055 sets the [OTC] flag in *SafetyAlert* if the pack *Temperature* is equal to or higher than the **Over Temp Chg** threshold.

Table C-212. Over Temp Chg

Subclass Name	Name	Format	Size in Bytes	Min Value	Max Value	Default Value	Unit
Temperature	Over Temp Chg	unsigned integer	2	0	1200	550	0.1°C

Related Variables:

- DF:1st Level Safety:Temperature:OT Chg Time
- SBS:Temperature
- SBS:SafetyAlert[OTC]

C.10.3.2 OT Chg Time

If the [OTC] in *SafetyAlert* time period exceeds the **OT Chg Time** period the bq3055 goes into an over temperature charge condition. This function is disabled if **OT Chg Time** is set to 0.

In and over temperature charge condition the *ChargingVoltage* and *ChargingCurrent* are set to 0, the [OTA] flag in *BatteryStatus* is set, [TCA] is set, the [OTC] flag in *SafetyAlert* is reset, and the [OTC] flag in *SafetyStatus* is set. If the [OTFET] bit is enabled the CHG FET also turns off.

Table C-213. OT Chg Time

Subclass Name	Name	Format	Size in Bytes	Min Value	Max Value	Default Value	Unit
Temperature	OT Chg Time	unsigned integer	1	0	240	2	s

Related Variables:

- DF:1st Level Safety:Temperature:Over Temp Chg
- DF:Configuration:Registers:Operation Cfg B[OTFET]
- SBS:ChargingCurrent
- SBS:ChargingVoltage
- SBS:BatteryStatus[OTA],[TCA]
- SBS:SafetyAlert[OTC]
- SBS:SafetyStatus[OTC]

C.10.3.3 OT Chg Recovery

The bq3055 recovers from an over temperature charge condition if the *Temperature* is equal to or lower than the **OT Chg Recovery** level. On recovery, the CHG FET returns to its normal operating state, the *ChargingCurrent* and *ChargingVoltage* are set to their appropriate values per the charging algorithm, the [OTA] flag is reset, and the [OTC] flag in *SafetyStatus* is reset.

Table C-214. OT Chg Recovery

Subclass Name	Name	Format	Size in Bytes	Min Value	Max Value	Default Value	Unit
Temperature	OT Chg Recovery	unsigned integer	2	0	1200	500	0.1°C

Related Variables:

- DF:1st Level Safety:Temperature:Over Temp Chg
- SBS:ChargingCurrent
- SBS:ChargingVoltage
- SBS:BatteryStatus[OTA]
- SBS:SafetyStatus[OTC]

C.10.3.4 Over Temp Dsg

The bq3055 sets the [OTD] in *SafetyAlert* if the pack *Temperature* is equal to or higher than the **Over Temp Dsg** threshold.

Table C-215. Over Temp Dsg

Subclass Name	Name	Format	Size in Bytes	Min Value	Max Value	Default Value	Unit
Temperature	Over Temp Dsg	unsigned integer	2	0	1200	600	0.1°C

Related Variables:

- DF:1st Level Safety:Temperature:OT Dsg Time
- SBS:Temperature
- SBS:SafetyAlert[OTD]

C.10.3.5 OT Dsg Time

If the *[OTD]* in *SafetyAlert* time period exceeds the **OT Dsg Time** the bq3055 goes into an over temperature discharge condition. This function is disabled if **OT Dsg Time** is set to 0.

In an over temperature discharge condition the *ChargingCurrent* is set to 0, *[OTA]* is set, the *[OTD]* flag in *SafetyAlert* is reset, and the *[OTD]* *SafetyStatus* flag is set. If the *[OTFET]* bit is enabled, the DSG FET also turns off and *[XDsg]* in *OperationStatus* is set.

Table C-216. OT Dsg Time

Subclass Name	Name	Format	Size in Bytes	Min Value	Max Value	Default Value	Unit
Temperature	OT Dsg Time	unsigned integer	1	0	240	2	s

Related Variables:

- DF:1st Level Safety:Temperature:Over Temp Dsg
- DF:Configuration:Registers:Operation Cfg B[OTFET]
- SBS:ChargingCurrent
- SBS:ChargingVoltage
- SBS:BatteryStatus[OTA]
- SBS:SafetyAlert[OTD]
- SBS:SafetyStatus[OTD]
- SBS:OperationStatus[XDsg]

C.10.3.6 OT Dsg Recovery

The bq3055 recovers from an over temperature discharge condition if the *Temperature* is equal to or lower than the **OT Dsg Recovery** level. On recovery, the DSG FET returns to its normal operating state, the *ChargingCurrent* and *ChargingVoltage* are set to their appropriate values per the charging algorithm, the *[OTA]* flag is reset, the *[OTD]* *SafetyStatus* flag is reset, and the *[XDsg]* flag in *OperationStatus* is reset.

Table C-217. OT Dsg Recovery

Subclass Name	Name	Format	Size in Bytes	Min Value	Max Value	Default Value	Unit
Temperature	OT Dsg Recovery	unsigned integer	2	0	1200	550	0.1°C

Related Variables:

- DF:1st Level Safety:Temperature:Over Temp Dsg
- SBS:ChargingCurrent
- SBS:ChargingVoltage
- SBS:BatteryStatus[OTA]
- SBS:SafetyStatus[OTD]
- SBS:OperationStatus[XDsg]

C.11 2nd-Level Safety

C.11.1 Voltage

C.11.1.1 LT SOV Threshold

When the bq3055 is operating in the low temperature charging range ($[TR2] = 1$), it sets the $[SOV]$ flag in $PFStatus$ if any $CellVoltage4..1$ is equal to or higher than the **LT SOV Threshold** for a period of **SOV Time**.

Table C-218. LT SOV Threshold

Subclass Name	Name	Format	Size in Bytes	Min Value	Max Value	Default Value	Unit
Voltage	LT SOV Threshold	Integer	2	0	20000	4400	mV

Related Variables:

- DF:2nd Level Safety:Voltage:SOV Time
- SBS:CellVoltage4
- SBS:CellVoltage3
- SBS:CellVoltage2
- SBS:CellVoltage1
- SBS:PFStatus[SOV]
- SBS:TempRange[TR2]

C.11.1.2 ST SOV Threshold

When the bq3055 is operating in the standard temperature charging range 1 or 2 ($[TR2A] = 1$, or $[TR3] = 1$), it sets the $[SOV]$ flag in $PFStatus$ if any $CellVoltage4..1$ is equal to or higher than the **ST SOV Threshold** for a period of **SOV Time**.

Table C-219. ST SOV Threshold

Subclass Name	Name	Format	Size in Bytes	Min Value	Max Value	Default Value	Unit
Voltage	ST SOV Threshold	Integer	2	0	20000	4600	mV

Related Variables:

- DF:2nd Level Safety:Voltage:SOV Time
- SBS:CellVoltage4
- SBS:CellVoltage3
- SBS:CellVoltage2
- SBS:CellVoltage1
- SBS:PFStatus[SOV]
- SBS:TempRange[TR2A][TR3]

C.11.1.3 HT SOV Threshold

When the bq3055 is operating in the high temperature charging range ($[TR4] = 1$), it sets the $[SOV]$ flag in $PFStatus$ if any $CellVoltage4..1$ is equal to or higher than the **HT SOV Threshold** for a period of **SOV Time**.

Table C-220. HT SOV Threshold

Subclass Name	Name	Format	Size in Bytes	Min Value	Max Value	Default Value	Unit
Voltage	HT SOV Threshold	Integer	2	0	20000	4500	mV

Related Variables:

- DF:2nd Level Safety:Voltage:SOV Time
- SBS:CellVoltage4
- SBS:CellVoltage3
- SBS:CellVoltage2
- SBS:CellVoltage1
- SBS:PFStatus[SOV]
- SBS:TempRange[TR4]

C.11.1.4 SOV Time

The bq3055 sets the [SOV] flag in *PFStatus* and goes into a safety overvoltage condition if any *CellVoltage4..1* is equal to or higher than the appropriate SOV threshold (depending on temperature range) for a period of **SOV Time**. If the [XSOV] bit in **Permanent Fail Cfg 1** is set, the SAFE pin is driven high. This function is disabled if **SOV Time** is set to 0.

Table C-221. SOV Time

Subclass Name	Name	Format	Size in Bytes	Min Value	Max Value	Default Value	Unit
Voltage	SOV Time	Unsigned integer	1	0	240	0	s

Related Variables:

- DF:2nd Level Safety:Voltage:LT SOV Threshold
- DF:2nd Level Safety:Voltage:ST SOV Threshold
- DF:2nd Level Safety:Voltage:HT SOV Threshold
- DF:Configuration:Registers:Permanent Fail Cfg 1[XSOV]
- SBS:CellVoltage4
- SBS:CellVoltage3
- SBS:CellVoltage2
- SBS:CellVoltage1
- SBS:PFStatus[SOV]

C.11.1.5 PF SOV Fuse Blow Delay

In case of a safety overvoltage permanent failure condition, the assertion of the FUSE output (to blow a fuse) can be delayed to allow the battery to discharge to a safe level before blowing the fuse. A PF timer is started once an SOV PF event occurs (i.e. **when SOV Time** has passed and the [SOV] flag has been set). The FUSE output will be driven high (thus blowing the fuse) once this timer reaches **PF SOV Fuse Blow Delay**, or as soon as all cell voltages go below the **COV Recovery threshold** for the current temperature range, whichever comes first.

Table C-222. PF SOV Fuse Blow Delay

Subclass Name	Name	Format	Size in Bytes	Min Value	Max Value	Default Value	Unit
Voltage	PF SOV Fuse Blow Delay	Unsigned integer	2	0	65,535	0	s

Related Variables:

- DF:2nd Level Safety:Voltage:LT SOV Threshold
- DF:2nd Level Safety:Voltage:ST SOV Threshold
- DF:2nd Level Safety:Voltage:HT SOV Threshold
- DF:Configuration:Registers:Permanent Fail Cfg 1[XSOV]
- SBS:CellVoltage4
- SBS:CellVoltage3

- SBS:CellVoltage2
- SBS:CellVoltage1
- SBS:PFStatus[SOV]

C.11.1.6 Cell Imbalance Current

The battery pack *Current* must be below the **Cell Imbalance Current** limit for **Cell Imbalance Time** before the bq3055 starts detecting cell imbalance.

Table C-223. Cell Imbalance Current

Subclass Name	Name	Format	Size in Bytes	Min Value	Max Value	Default Value	Unit
Voltage	Cell Imbalance Current	unsigned integer	1	0	200	5	mA

Related Variables:

- DF:2nd Level Safety:Voltage:Cell Imbalance Fail Voltage
- DF:2nd Level Safety:Voltage:Cell Imbalance Time
- DF:2nd Level Safety:Voltage:Battery Rest Time
- SBS:Current

C.11.1.7 Cell Imbalance Fail Voltage

If the *Current* goes below **Cell Imbalance Current** for **Battery Rest Time** the bq3055 starts cell imbalance measurements. The bq3055 sets the *[CIM]* flag in *PFAlert* if the bq3055 measures a difference between any *CellVoltage4..1* equal to or higher than the **Cell Imbalance Fail Voltage** threshold.

Table C-224. Cell Imbalance Fail Voltage

Subclass Name	Name	Format	Size in Bytes	Min Value	Max Value	Default Value	Unit
Voltage	Cell Imbalance Fail Voltage	unsigned integer	2	0	5000	1000	mV

Related Variables:

- DF:2nd Level Safety:Voltage:Cell Imbalance Current
- DF:2nd Level Safety:Voltage:Cell Imbalance Time
- DF:2nd Level Safety:Voltage:Battery Rest Time
- SBS:CellVoltage4
- SBS:CellVoltage3
- SBS:CellVoltage2
- SBS:CellVoltage1
- SBS:PFAlert[CIM]

C.11.1.8 Cell Imbalance Time

If the *[CIM]* *PFAlert* time period exceeds the **Cell Imbalance Time** limit the bq3055 goes into a cell imbalance condition, *[CIM]* in *PFAlert* is cleared, *[CIM]* in *PFStatus* is set and, if *[XCIM]* in **Permanent Fail Cfg** is set, the FUSE pin is also driven high. This function is disabled if **Cell Imbalance Time** is set to 0.

Table C-225. Cell Imbalance Time

Subclass Name	Name	Format	Size in Bytes	Min Value	Max Value	Default Value	Unit
Voltage	Cell Imbalance Time	unsigned integer	1	0	240	0	s

Related Variables:

- DF:2nd Level Safety:Voltage:Cell Imbalance Current
- DF:2nd Level Safety:Voltage:Cell Imbalance Fail Voltage
- DF:2nd Level Safety:Voltage:Battery Rest Time
- DF:Configuration:Registers:Permanent Fail Cfg[XSOV]
- SBS:PFAlert[CIM]
- SBS:PFStatus[CIM]

C.11.1.9 Battery Rest Time

The battery *Current* must be below **Cell Imbalance Current** limit for at least **Battery Rest Time** period before the bq3055 starts detecting a cell imbalance. Cell imbalance detection is disabled if **Battery Rest Time** is set to 0.

Table C-226. Battery Rest Time

Subclass Name	Name	Format	Size in Bytes	Min Value	Max Value	Default Value	Unit
Voltage	Battery Rest Time	unsigned integer	2	0	65535	1800	s

Related Variables:

- DF:2nd Level Safety:Voltage:Cell Imbalance Current
- DF:2nd Level Safety:Voltage:Cell Imbalance Fail Voltage
- DF:2nd Level Safety:Voltage:Cell Imbalance Time
- SBS:Current

C.11.1.10 Min CIM-Check Voltage

The battery *Current()* must be below **Cell Imbalance Current** limit for at least **Battery Rest Time** AND all **CellVoltage4...1()** must be greater than Min CIM-check voltage before the bq3055 initiates cell imbalance detection.

Table C-227. Min CIM-Check Voltage

Subclass Name	Name	Format	Size in Bytes	Min Value	Max Value	Default Value	Unit
Voltage	Min CIM-check voltage	unsigned integer	2	0	65535	3000	mV

Related Variables:

- DF:2nd Level Safety:Voltage:Cell Imbalance Current
- DF:2nd Level Safety:Voltage:Cell Imbalance Fail Voltage
- DF:2nd Level Safety:Voltage:Cell Imbalance Time
- DF:2nd Level Safety:Voltage:Battery Rest Time
- SBS:Current
- SBS:CellVoltage4..1

C.11.1.11 PFIN Detect Time

If the FUSE pin is driven logic high externally then **[PFIN]** in **PFAlert** is set. If the **[PFIN]** PF alert time period exceeds **PFIN Detect Time** **[PFIN]** in **PFAlert** is reset, **[PFIN]** in **PFStatus** is set, and both DSG- and CHG-FET are turned OFF. If **[XPFIN]** in **Permanent Fail Cfg** is set, the FUSE pin is also driven high by the bq3055. This function is disabled if **PFIN Detect Time** is set to 0.

Regardless of PFIN being disabled or not, however, when the FUSE pin is driven high externally, both DSG- and CHG-FET are turned OFF by the AFE hardware.

Table C-228. PFIN Detect Time

Subclass Name	Name	Format	Size in Bytes	Min Value	Max Value	Default Value	Unit
Voltage	PFIN Detect Time	unsigned integer	1	0	240	0	s

Related Variables:

- DF:Configuration:Registers:Permanent Fail Cfg[XPFIN]
- SBS:PFAlert[PFIN]
- SBS:PFStatus[PFIN]

C.11.2 Current**C.11.2.1 SOC Chg**

The bq3055 sets the [SOCC] in *PFAlert* if *Current* is equal to or higher than the **SOC Chg** threshold.

Table C-229. SOC Chg

Subclass Name	Name	Format	Size in Bytes	Min Value	Max Value	Default Value	Unit
Current	SOC Chg	unsigned integer	2	0	30000	10000	mA

Related Variables:

- DF:2nd Level Safety:Current:SOC Chg Time
- DF:Configuration:Registers:Permanent Fail Cfg[XSOCC]
- SBS:Current
- SBS:PFAlert[SOCC]

C.11.2.2 SOC Chg Time

If the [SOCC] in *PFAlert* time period exceeds the **SOC Chg Time** the bq3055 goes into a SOCC condition [SOCC] in *PFAlert* is cleared, [SOCC] in *PFStatus* is set and, if [XSOCC] in **Permanent Fail Cfg** is set, the FUSE pin is driven high. This function is disabled if **SOC Chg Time** is set to 0.

Table C-230. SOC Chg Time

Subclass Name	Name	Format	Size in Bytes	Min Value	Max Value	Default Value	Unit
Current	SOC Chg Time	unsigned integer	1	0	240	0	s

Related Variables:

- DF:2nd Level Safety:Current:SOC Chg
- DF:Configuration:Registers:Permanent Fail Cfg[XSOCC]
- SBS:Current
- SBS:PFAlert[SOCC]
- SBS:PFStatus[SOCC]

C.11.2.3 SOC Dsg

The bq3055 sets the [SOCD] *PFAlert* if discharge *Current* is equal to or higher than the (–)**SOC Dsg** threshold.

Table C-231. SOC Dsg

Subclass Name	Name	Format	Size in Bytes	Min Value	Max Value	Default Value	Unit
Current	SOC Dsg	unsigned integer	2	0	30000	10000	mA

Related Variables:

- DF:2nd Level Safety:Current:SOC Dsg Time
- DF:Configuration:Registers:Permanent Fail Cfg[XSOCC]
- SBS:Current
- SBS:PFAlert[SOCD]

C.11.2.4 SOC Dsg Time

If the [SOCD] PFAlert time period exceeds the safety overcurrent charge time the bq3055 goes into a SOCD condition, [SOCD] in PFAlert is cleared, [SOCD] in PFStatus is set and, if the [XSOCD] bit in **Permanent Fail Cfg** is set, the FUSE pin is driven high. This function is disabled if **SOCD Dsg Time** is set to 0.

Table C-232. SOC Dsg Time

Subclass Name	Name	Format	Size in Bytes	Min Value	Max Value	Default Value	Unit
Current	SOC Dsg Time	unsigned integer	1	0	240	0	s

Related Variables:

- DF:2nd Level Safety:Current:SOC Dsg
- DF:Configuration:Registers:Permanent Fail Cfg[XSOCD]
- SBS:Current
- SBS:PFAlert[SOCD]
- SBS:PFStatus[SOCD]

C.11.3 Temperature
C.11.3.1 SOT Chg

The bq3055 sets the [SOTC] PFAlert if *Temperature* is equal to or higher than the **SOT Chg** threshold during charging ([DSG] = 0).

Table C-233. SOT Chg

Subclass Name	Name	Format	Size in Bytes	Min Value	Max Value	Default Value	Unit
Temperature	SOT Chg	unsigned integer	2	0	1200	650	0.1°C

Related Variables:

- DF:2nd Level Safety:Temperature:SOT Chg Time
- SBS:Temperature
- SBS:BatteryStatus[DSG]
- SBS:PFAlert[SOTC]

C.11.3.2 SOT Chg Time

If the [SOT] flag in PFAlert time period exceeds **SOT Chg Time** the bq3055 goes into a SOTC condition, [SOTC] in PFAlert is cleared, [SOTC] in PFStatus is set and, if [XSOTC] in **Permanent Fail Cfg** is set, the FUSE pin is driven high. This function is disabled if **SOT Chg Time** is set to 0.

Table C-234. SOT Chg Time

Subclass Name	Name	Format	Size in Bytes	Min Value	Max Value	Default Value	Unit
Temperature	SOT Chg Time	unsigned integer	1	0	240	0	s

Related Variables:

- DF:2nd Level Safety:Temperature:SOT Chg
- DF:Configuration:Registers:Permanent Fail Cfg[XSOTC]
- SBS:Temperature
- SBS:PFAlert[SOTC]
- SBS:PFStatus[SOTC]

C.11.3.3 SOT Dsg

The bq3055 sets the [SOTD] *PFAlert* if *Temperature* is equal to or higher than the *SOT Dsg* threshold during discharging ([DSG] = 1).

Table C-235. SOT Dsg

Subclass Name	Name	Format	Size in Bytes	Min Value	Max Value	Default Value	Unit
Temperature	SOT Dsg	unsigned integer	2	0	1200	750	0.1°C

Related Variables:

- DF:2nd Level Safety:Temperature:SOT Dsg Time
- SBS:Temperature
- SBS:BatteryStatus[DSG]
- SBS:PFAlert[SOTD]

C.11.3.4 SOT Dsg Time

If the [SOTD] in *PFAlert* time period exceeds **SOT Dsg Time** the bq3055 goes into a *SOTD* condition, [SOTD] in *PFAlert* is reset, [SOTD] in *PFStatus* is set and, if [XSOTD] in **Permanent Fail Cfg** is set, the FUSE pin is driven high. This function is disabled if **SOT Dsg Time** is set to 0.

Table C-236. SOT Dsg Time

Subclass Name	Name	Format	Size in Bytes	Min Value	Max Value	Default Value	Unit
Temperature	SOT Dsg Time	unsigned integer	1	0	240	0	s

Related Variables:

- DF:2nd Level Safety:Temperature:SOT Dsg
- DF:Configuration:Registers:Permanent Fail Cfg[XSOTD]
- SBS:Temperature
- SBS:PFAlert[SOTD]
- SBS:PFStatus[SOTD]

C.11.3.5 Open Thermistor

The bq3055 sets the [SOPT] flag in *PFAlert* if the thermistor *Temperature* is equal to or lower than the **Open Thermistor** threshold.

Table C-237. Open Thermistor

Subclass Name	Name	Format	Size in Bytes	Min Value	Max Value	Default Value	Unit
Temperature	Open Thermistor	signed integer	2	-1000	1200	-333	0.1°C

Related Variables:

- DF:2nd Level Safety:Temperature:Open Time
- SBS:Temperature
- SBS:PFAlert[SOPT]

C.11.3.6 Open Time

If the [SOPT] PFAAlert time period exceeds **Open Time** period the bq3055 goes into a safety open thermistor condition, [SOPT] in PFAAlert is reset, [SOPT] in PFStatus is set and, if [XSOPT] in **Permanent Fail Cfg** is set, the FUSE pin is driven high. This function is disabled if **Open Time** is set to 0.

Table C-238. Open Time

Subclass Name	Name	Format	Size in Bytes	Min Value	Max Value	Default Value	Unit
Temperature	Open Time	unsigned integer	1	0	240	0	s

Related Variables:

- DF:2nd Level Safety:Temperature:Open Thermistor
- DF:Configuration:Registers:Permanent Fail Cfg[XSOPT]
- SBS:Temperature
- SBS:PFAAlert[SOPT]
- SBS:PFStatus[SOPT]

C.11.4 FET Verification

C.11.4.1 FET Fail Limit

The bq3055 sets the [CFETF] PFAAlert if the bq3055 detects charge *Current* equal to or higher than the **FET Fail Limit** threshold when the CHG FET is supposed to be off.

The bq3055 sets the [DFETF] PFAAlert if the bq3055 detects discharge *Current* equal to or lower than the **(-)FET Fail Limit** threshold when the DSG FET is supposed to be off.

Table C-239. FET Fail Limit

Subclass Name	Name	Format	Size in Bytes	Min Value	Max Value	Default Value	Unit
FET Verification	FET Fail Limit	unsigned integer	2	0	500	20	mA

Related Variables:

- DF:2nd Level Safety:FET Verification:FET Fail Time
- SBS:Current
- SBS:PFAAlert[CFETF],[DFETF]

C.11.4.2 FET Fail Time

If the [CFETF] alert time period exceeds **FET Fail Time** the bq3055 goes into a CHG FET failure condition, [CFETF] in PFAAlert is reset, [CFETF] in PFStatus is set and, if [XCFETF] in **Permanent Fail Cfg** is set, the FUSE pin is driven high. This function is disabled if **FET Fail Time** is set to 0.

If the [DFETF] alert time period exceeds **FET Fail Time** the bq3055 goes into a DSG FET failure condition, [DFETF] in PFAAlert is reset, [DFETF] in PFStatus is set and, if [XDFETF] in **Permanent Fail Cfg** is set, the FUSE pin is driven high. This function is disabled if **FET Fail Time** is set to 0.

Table C-240. FET Fail Time

Subclass Name	Name	Format	Size in Bytes	Min Value	Max Value	Default Value	Unit
AFE Verification	FET Fail Time	unsigned integer	1	0	240	0	s

Related Variables:

- DF:2nd Level Safety:FET Verification:FET Fail Limit
- DF:Configuration:Registers:Permanent Fail Cfg[XCFETF],[XDFETF]
- SBS:Current
- SBS:PFAAlert[CFETF],[DFETF]

- SBS:PFStatus[CFETF],[DFETF]

C.11.5 AFE Verification

C.11.5.1 AFE Check Time

The bq3055 compares periodically, with a period of **AFE Check Time**, certain RAM content and expected control bit states of the integrated AFE with the values stored in data flash. If an error is detected, the internal AFE fail counter is incremented. Set to 0 to disable [AFE_P] faults.

Table C-241. AFE Check Time

Subclass Name	Name	Format	Size in Bytes	Min Value	Max Value	Default Value	Unit
FET Verification	AFE Check Time	unsigned integer	1	0	255	0	s

Related Variables:

- DF:2nd Level Safety:AFE Verification:AFE Fail Limit
- DF:2nd Level Safety:AFE Verification:AFE Fail Recovery Time
- SBS:SafetyStatus[WDF]
- SBS:PFStatus[AFE_P]

C.11.5.2 AFE Fail Limit

If the internal AFE fail counter reaches the **AFE Fail Limit** the bq3055 reports a [AFE_C] permanent failure and, if [XAFE_C] in **Permanent Fail Cfg** is set, the FUSE pin is driven high. This function is disabled if **AFE Fail Limit** is set to zero.

Table C-242. AFE Fail Limit

Subclass Name	Name	Format	Size in Bytes	Min Value	Max Value	Default Value	Unit
AFE Verification	AFE Fail Limit	unsigned integer	1	0	255	10	

Related Variables:

- DF:2nd Level Safety:AFE Verification:AFE Check Time
- DF:2nd Level Safety:AFE Verification:AFE Fail Recovery Time
- DF:Configuration:Registers:Permanent Fail Cfg[XAFE_C]
- SBS:AFEData
- SBS:PFStatus[AFE_C]

C.11.5.3 AFE Fail Recovery Time

The bq3055 decrements the internal AFE fail counter by one each **AFE Fail Recovery Time** period to a minimum of zero.

Table C-243. AFE Fail Recovery Time

Subclass Name	Name	Format	Size in Bytes	Min Value	Max Value	Default Value	Unit
AFE Verification	AFE Fail Recovery Time	unsigned integer	1	0	255	20	s

Related Variables:

- DF:2nd Level Safety:AFE Verification:AFE Check Time
- DF:2nd Level Safety:AFE Verification:AFE Fail Limit

C.11.5.4 AFE Init Retry Limit

After a full reset the AFE offset and gain values are read twice and then compared. **AFE Init Retry Limit** is the maximum number of times that the initial AFE offset and gain values will be read—if they are not considered the same—until the [AFE_C] permanent failure occurs.

Table C-244. AFE Init Retry Limit

Subclass Name	Name	Format	Size in Bytes	Min Value	Max Value	Default Value	Unit
AFE Verification	AFE Init Retry Limit	unsigned integer	1	0	255	6	

Related Variables:

- DF:2nd Level Safety:AFE Verification:AFE Init Limit
- SBS:PFStatus[AFE_C]

C.11.5.5 AFE Init Limit

AFE Init Limit is the difference in A/D counts that two successive readings of AFE offset and gain can be and still considered the be same value, after a full reset.

Table C-245. AFE Init Limit

Subclass Name	Name	Format	Size in Bytes	Min Value	Max Value	Default Value	Unit
AFE Verification	AFE Init Limit	unsigned integer	1	0	255	20	

Related Variables:

- DF:2nd Level Safety:AFE Verification:AFE Init Retry Limit
- SBS:PFStatus[AFE_C]

C.12 Data Flash Values
Table C-246. DATA FLASH VALUES

Class	SubClass	Name	Data Type	Min	Max	Default	Unit
Calibration	Voltage	Cell Scale 0	I2	0	32767	20500	—
Calibration	Voltage	Cell Scale 1	I2	0	32767	20500	—
Calibration	Voltage	Cell Scale 2	I2	0	32767	20500	—
Calibration	Voltage	Cell Scale 3	I2	0	32767	20500	—
Calibration	Voltage	Pack Gain	U2	0	65535	44100	—
Calibration	Voltage	BAT Gain	U2	0	65535	44100	—
Calibration	Current	CC Gain	F4	1.00E-01	4.00E+00	0.9419	—
Calibration	Current	Capacity Gain	F4	2.98E+04	1.19E+06	280932.625	—
Calibration	Current Offset	CC Offset	I2	-32767	32767	-7744	—
Calibration	Current Offset	Coulomb Counter Offset Samples	U2	0	65535	64	—
Calibration	Current Offset	Board Offset	I2	-32768	32767	0	—
Calibration	Temperature	Internal Temp Offset	I1	-128	127	0	—
Calibration	Temperature	Ext1 Temp Offset	I1	-128	127	0	0.1 °C

Table C-246. DATA FLASH VALUES (continued)

Class	SubClass	Name	Data Type	Min	Max	Default	Unit
Calibration	Temperature	Ext2 Temp Offset	I1	-128	127	0	0.1 °C
Calibration	Temperature	Ext3 Temp Offset	I1	-128	127	0	0.1 °C
Calibration	Temperature	Ext4 Temp Offset	I1	-128	127	0	0.1 °C
Calibration	Internal Temp Model	Int Coeff 1	I2	-32768	32767	0	—
Calibration	Internal Temp Model	Int Coeff 2	I2	-32768	32767	0	—
Calibration	Internal Temp Model	Int Coeff 3	I2	-32768	32767	-11136	—
Calibration	Internal Temp Model	Int Coeff 4	I2	-32768	32767	5754	—
Calibration	Internal Temp Model	Int Min AD	I2	-32768	32767	0	—
Calibration	Internal Temp Model	Int Max Temp	I2	-32768	32767	5754	0.1 °K
Calibration	External Temp Model	Ext Coef a1	I2	-32768	32767	-14520	—
Calibration	External Temp Model	Ext Coef a2	I2	-32768	32767	23696	—
Calibration	External Temp Model	Ext Coef a3	I2	-32768	32767	-30298	—
Calibration	External Temp Model	Ext Coef a4	I2	-32768	32767	28073	—
Calibration	External Temp Model	Ext Coef a5	I2	-32768	32767	865	—
Calibration	External Temp Model	Ext Coef b1	I2	-32768	32767	-694	—
Calibration	External Temp Model	Ext Coef b2	I2	-32768	32767	1326	—
Calibration	External Temp Model	Ext Coef b3	I2	-32768	32767	-3880	—
Calibration	External Temp Model	Ext Coef b4	I2	-32768	32767	5127	—
Calibration	External Temp Model	Ext rc0	I2	-32768	32767	11703	—
Calibration	External Temp Model	Ext adc0	I2	-32768	32767	11703	—
Calibration	External Temp Model	Rpad	I2	-32768	32767	0	—
Calibration	External Temp Model	Rint	I2	-32768	32767	0	—
Calibration	Current Deadband	Deadband	U1	0	255	3	mA
Calibration	Current Deadband	CC Deadband	U1	0	255	34	294 nV
Calibration	Current Deadband	Filter	U1	0	255	239	—
System Data	Manufacturer Data	Pack Lot Code	H2	0x0	0xffff	0x0	
System Data	Manufacturer Data	PCB Lot Code	H2	0x0	0xffff	0x0	
System Data	Manufacturer Data	Firmware Version	H2	0x0	0xffff	0x0	

Table C-246. DATA FLASH VALUES (continued)

Class	SubClass	Name	Data Type	Min	Max	Default	Unit
System Data	Manufacturer Data	Hardware Revision	H2	0x0	0xffff	0x0	
System Data	Manufacturer Data	Cell Revision	H2	0x0	0xffff	0x0	
SBS Configuration	Data	Rem Cap Alarm	I2	0	700	300	mAh
SBS Configuration	Data	Rem Energy Alarm	I2	0	1000	432	10 mW
SBS Configuration	Data	Rem Time Alarm	U2	0	30	10	min
SBS Configuration	Data	Init Battery Mode	H2	0x0	0xffff	0x81	hex
SBS Configuration	Data	Design Voltage	I2	7000	18000	10800	mV
SBS Configuration	Data	Spec Info	H2	0x0	0xffff	0x31	hex
SBS Configuration	Data	Manuf Date	U2	0	65535	0	Day + Mo*32 + (Yr -1980)*256
SBS Configuration	Data	Ser. Num.	H2	0x0000	0xffff	0x1	hex
SBS Configuration	Data	Cycle Count	U2	0	65535	0	Count
SBS Configuration	Data	CC Threshold	I2	100	32767	4400	mAh
SBS Configuration	Data	CC %	U1	0	100	90	%
SBS Configuration	Data	CF MaxError Limit	U1	0	100	100	%
SBS Configuration	Data	Design Capacity	I2	0	65535	4400	mAh
SBS Configuration	Data	Design Energy	I2	0	65535	4752	10 mW
SBS Configuration	Data	Full Charge Capacity	I2	0	65535	4400	mAh
SBS Configuration	Data	DOD at EDV2	I2	0	16384	15232	
SBS Configuration	Data	Manuf Name	S21	x	x	Texas Instruments	
SBS Configuration	Data	Device Name	S21	x	x	bq3055	
SBS Configuration	Data	Device Chemistry	S5	x	x	LION	
SBS Configuration	Configuration	TDA Set %	I1	-1	100	6	%
SBS Configuration	Configuration	TDA Clear %	I1	-1	100	8	%
SBS Configuration	Configuration	FD Set %	I1	-1	100	2	%
SBS Configuration	Configuration	FD Clear %	I1	-1	100	5	%
SBS Configuration	Configuration	TDA Set Volt Threshold	I2	0	16800	3750	mV
SBS Configuration	Configuration	TDA Set Volt Time	U1	0	240	5	s

Table C-246. DATA FLASH VALUES (continued)

Class	SubClass	Name	Data Type	Min	Max	Default	Unit
SBS Configuration	Configuration	TDA Clear Volt	I2	0	16800	4125	mV
SBS Configuration	Configuration	FD Set Volt Threshold	I2	0	16800	3750	mV
SBS Configuration	Configuration	FD Volt Time	U1	0	240	5	s
SBS Configuration	Configuration	FD Clear Volt	I2	0	16800	4125	mV
System Data	Manufacturer Info	Manuf. Info	S32	x	x	0123456789A BCDEF01234 56789ABCDE	
PF Status	Device Status Data	PF Flags 1	H2	0x0	0xffff	0x0	
PF Status	Device Status Data	Fuse Flag	H2	0x0	0xffff	0x0	
PF Status	Device Status Data	PF Voltage	I2	0	32767	0	mV
PF Status	Device Status Data	PF C4 Voltage	I2	0	9999	0	mV
PF Status	Device Status Data	PF C3 Voltage	I2	0	9999	0	mV
PF Status	Device Status Data	PF C2 Voltage	I2	0	9999	0	mV
PF Status	Device Status Data	PF C1 Voltage	I2	0	9999	0	mV
PF Status	Device Status Data	PF Current	I2	-32768	32767	0	mA
PF Status	Device Status Data	PF Temperature	I2	-9999	9999	0	0.1 °K
PF Status	Device Status Data	PF Batt Stat	H2	0x0	0xffff	0x0	
PF Status	Device Status Data	PF RC-mAh	I2	0	32767	0	mAh
PF Status	Device Status Data	PF FCC	I2	0	65535	0	mAh
PF Status	Device Status Data	PF Chg Status	H2	0x0	0xffff	0x0	
PF Status	Device Status Data	PF Safety Status	H2	0x0	0xffff	0x0	
PF Status	Device Status Data	PF DOD	I2	0	32767	0	
PF Status	Device Status Data	PF Flags 2	H2	0x0	0xffff	0x0	
PF Status	AFE Regs	AFE Status	H1	0x0	0xff	0x0	
PF Status	AFE Regs	AFE State Control	H1	0x0	0xff	0x0	
PF Status	AFE Regs	AFE Control	H1	0x0	0xff	0x0	
PF Status	AFE Regs	AFE Output Status	H1	0x0	0xff	0x0	
PF Status	AFE Regs	AFE Function Control	H1	0x0	0xff	0x0	
PF Status	AFE Regs	AFE Cell Select	H1	0x0	0xff	0x0	
PF Status	AFE Regs	AFE OLV	H1	0x0	0xff	0x0	
PF Status	AFE Regs	AFE OLT	H1	0x0	0xff	0x0	
PF Status	AFE Regs	AFE SCC	H1	0x0	0xff	0x0	

Table C-246. DATA FLASH VALUES (continued)

Class	SubClass	Name	Data Type	Min	Max	Default	Unit
PF Status	AFE Regs	AFE SCD	H1	0x0	0xff	0x0	
PF Status	AFE Regs	AFE SCD2	H1	0x0	0xff	0x0	
Gas Gauging	State	Qmax Cell 0	I2	0	32767	4400	mAh
Gas Gauging	State	Qmax Cell 1	I2	0	32767	4400	mAh
Gas Gauging	State	Qmax Cell 2	I2	0	32767	4400	mAh
Gas Gauging	State	Qmax Cell 3	I2	0	32767	4400	mAh
Gas Gauging	State	Qmax Pack	I2	0	32767	4400	mAh
Gas Gauging	CEDV Cfg	CEDV Config	H1	0x0	0xff	0x0	
Gas Gauging	CEDV Cfg	EMF	U2	0	65535	3743	mV
Gas Gauging	CEDV Cfg	C0	U2	0	65535	149	
Gas Gauging	CEDV Cfg	R0	U2	0	65535	867	
Gas Gauging	CEDV Cfg	T0	U2	0	65535	4030	
Gas Gauging	CEDV Cfg	R1	U2	0	65535	316	
Gas Gauging	CEDV Cfg	TC	U1	0	255	9	
Gas Gauging	CEDV Cfg	C1	U1	0	255	0	
Gas Gauging	CEDV Cfg	Age Factor	U1	0	255	0	
Gas Gauging	CEDV Cfg	Fixed EDV 0	U2	0	65535	3031	mV
Gas Gauging	CEDV Cfg	Fixed EDV 1	U2	0	65535	3385	mV
Gas Gauging	CEDV Cfg	Fixed EDV 2	U2	0	65535	3501	mV
Gas Gauging	CEDV Cfg	Low Temp	U1	0	255	119	0.1 °C
Gas Gauging	CEDV Cfg	Overload Current	U2	0	65535	5000	mA
Gas Gauging	CEDV Cfg	Self Discharge Rate	U1	0	255	20	0.01%/day
Gas Gauging	CEDV Cfg	Electronics Load	U1	0	255	0	3 µA
Gas Gauging	CEDV Cfg	Battery Low %	U2	0	65535	4608	%/2.56
Gas Gauging	CEDV Cfg	Near Full	U2	0	65535	200	mAH
Charge Control	Charge Temperature Cfg	JT1	I2	-400	1200	0	0.1 °C
Charge Control	Charge Temperature Cfg	JT2	I2	-400	1200	120	0.1 °C
Charge Control	Charge Temperature Cfg	JT2a	I2	-400	1200	300	0.1 °C
Charge Control	Charge Temperature Cfg	JT3	I2	-400	1200	450	0.1 °C
Charge Control	Charge Temperature Cfg	JT4	I2	-400	1200	550	0.1 °C
Charge Control	Charge Temperature Cfg	Temp Hys	I2	0	100	10	0.1 °C
Charge Control	Pre-Charge Cfg	Pre-chg Current	I2	0	2000	250	mA
Charge Control	Pre-Charge Cfg	Pre-chg Voltage	I2	0	20000	3000	mV
Charge Control	Pre-Charge Cfg	Recovery Voltage	I2	0	20000	3100	mV

Table C-246. DATA FLASH VALUES (continued)

Class	SubClass	Name	Data Type	Min	Max	Default	Unit
Charge Control	Charge Cfg	LT Chg Voltage	I2	0	20000	9000	mV
Charge Control	Charge Cfg	LT Chg Current1	I2	0	20000	250	mA
Charge Control	Charge Cfg	LT Chg Current2	I2	0	20000	250	mA
Charge Control	Charge Cfg	LT Chg Current3	I2	0	20000	250	mA
Charge Control	Charge Cfg	ST1 Chg Voltage	I2	0	20000	12600	mV
Charge Control	Charge Cfg	ST1 Chg Current1	I2	0	20000	4000	mA
Charge Control	Charge Cfg	ST1 Chg Current2	I2	0	20000	4000	mA
Charge Control	Charge Cfg	ST1 Chg Current3	I2	0	20000	4000	mA
Charge Control	Charge Cfg	ST2 Chg Voltage	I2	0	20000	12600	mV
Charge Control	Charge Cfg	ST2 Chg Current1	I2	0	20000	4000	mA
Charge Control	Charge Cfg	ST2 Chg Current2	I2	0	20000	4000	mA
Charge Control	Charge Cfg	ST2 Chg Current3	I2	0	20000	4000	mA
Charge Control	Charge Cfg	HT Chg Voltage	I2	0	20000	12570	mV
Charge Control	Charge Cfg	HT Chg Current1	I2	0	20000	3800	mA
Charge Control	Charge Cfg	HT Chg Current2	I2	0	20000	3800	mA
Charge Control	Charge Cfg	HT Chg Current3	I2	0	20000	3800	mA
Charge Control	Charge Cfg	Cell Voltage Threshold1	I2	0	5000	3900	mV
Charge Control	Charge Cfg	Cell Voltage Threshold2	I2	0	5000	4000	mV
Charge Control	Charge Cfg	Cell Voltage Thresh Hys	I2	0	1000	10	mV
Charge Control	Termination Cfg	Taper Current	I2	0	1000	250	mA
Charge Control	Termination Cfg	Taper Voltage	I2	0	1000	300	mV
Charge Control	Termination Cfg	Current Taper Window	U1	0	240	40	s
Charge Control	Termination Cfg	TCA Set %	I1	-1	100	-1	%
Charge Control	Termination Cfg	TCA Clear %	I1	-1	100	95	%
Charge Control	Termination Cfg	FC Set %	I1	-1	100	-1	%
Charge Control	Termination Cfg	FC Clear %	I1	-1	100	98	%
Charge Control	Cell Balancing Cfg	Cell Balance Threshold	I2	0	5000	3900	mV
Charge Control	Cell Balancing Cfg	Cell Balance Window	I2	0	5000	100	mV

Table C-246. DATA FLASH VALUES (continued)

Class	SubClass	Name	Data Type	Min	Max	Default	Unit
Charge Control	Cell Balancing Cfg	Cell Balance Min	U1	0	5000	40	mV
Charge Control	Cell Balancing Cfg	Cell Balance Interval	U1	0	240	20	s
Charge Control	Charging Faults	Over Charging Voltage	I2	0	3000	500	mV
Charge Control	Charging Faults	Over Charging Volt Time	U1	0	240	2	s
Charge Control	Charging Faults	Over Charging Current	I2	0	2000	500	mA
Charge Control	Charging Faults	Over Charging Curr Time	U1	0	240	2	s
Charge Control	Charging Faults	Over Charging Curr Recov	I2	0	2000	100	mA
Charge Control	Charging Faults	Depleted Voltage	I2	0	16000	6000	mV
Charge Control	Charging Faults	Depleted Voltage Time	U1	0	240	2	s
Charge Control	Charging Faults	Depleted Recovery	I2	0	16000	6500	mV
Charge Control	Charging Faults	Over Charge Capacity	I2	0	4000	300	mAh
Charge Control	Charging Faults	Over Charge Recovery	I2	0	100	2	mAh
Charge Control	Charging Faults	FC-MTO	U2	0	65535	10800	s
Charge Control	Charging Faults	PC-MTO	U2	0	65535	3600	s
Charge Control	Charging Faults	Charge Fault Cfg	H1	0x0	0xffff	0x0	
Configuration	Registers	Operation Cfg A	H2	0x0	0xffff	0x228	
Configuration	Registers	Operation Cfg B	H2	0x0	0xffff	0x440	
Configuration	Registers	Operation Cfg C	H2	0x0	0xffff	0x40	
Configuration	Registers	Permanent Fail Cfg	H2	0x0	0xffff	0x0	
Configuration	Registers	Non-Removable Cfg	H2	0x0	0xffff	0x0	
Configuration	Registers	Manufacturing Status	H2	0x0	0xffff	0x01	
Configuration	AFE	AFE State_CTL	H1	0x0	0xff	0x0	
Power	Power	Flash Update OK Voltage	I2	6000	20000	7500	mV
Power	Power	Shutdown Voltage	I2	5000	20000	5250	mV
Power	Power	Shutdown Time	U1	0	240	10	s
Power	Power	Cell Shutdown Voltage	I2	0	5000	1750	mV
Power	Power	Cell Shutdown Time	U1	0	240	10	s

Table C-246. DATA FLASH VALUES (continued)

Class	SubClass	Name	Data Type	Min	Max	Default	Unit
Power	Power	AFE Shutdown Voltage	I2	0	5500	3000	mV
Power	Power	Sleep Current	I2	0	100	10	mA
Power	Power	Bus Low Time	U1	0	255	5	s
Power	Power	Cal Inhibit Temp Low	I2	-400	1200	50	0.1 °C
Power	Power	Cal Inhibit Temp High	I2	-400	1200	450	0.1 °C
Power	Power	Sleep Voltage Time	U1	1	240	5	s
Power	Power	Sleep Current Time	U1	1	255	20	s
Power	Power	Wake Current Reg	H1	0x0	0xff	0x0	
Gas Gauging	Current Thresholds	Dsg Current Threshold	I2	0	2000	100	mA
Gas Gauging	Current Thresholds	Chg Current Threshold	I2	0	2000	50	mA
Gas Gauging	Current Thresholds	Quit Current	I2	0	1000	10	mA
Gas Gauging	Current Thresholds	Dsg Relax Time	U1	0	240	1	s
Gas Gauging	Current Thresholds	Chg Relax Time	U1	0	240	60	s
1st Level Safety	Voltage	LT COV Threshold	I2	3700	5000	4300	mV
1st Level Safety	Voltage	LT COV Recovery	I2	0	4400	4100	mV
1st Level Safety	Voltage	ST COV Threshold	I2	3700	5000	4500	mV
1st Level Safety	Voltage	ST COV Recovery	I2	0	4400	4300	mV
1st Level Safety	Voltage	HT COV Threshold	I2	3700	5000	4200	mV
1st Level Safety	Voltage	HT COV Recovery	I2	0	4400	4000	mV
1st Level Safety	Voltage	CUV Threshold	I2	0	3500	2200	mV
1st Level Safety	Voltage	CUV Recovery	I2	0	3600	3000	mV
1st Level Safety	Current	OC (1st Tier) Chg	I2	0	20000	6000	mA
1st Level Safety	Current	OC (1st Tier) Chg Time	U1	0	240	2	mA
1st Level Safety	Current	OC Chg Recovery	I2	-1000	1000	200	mA
1st Level Safety	Current	OC (1st Tier) Dsg	I2	0	20000	6000	mA
1st Level Safety	Current	OC (1st Tier) Dsg Time	U1	0	240	2	mA
1st Level Safety	Current	OC Dsg Recovery	I2	0	1000	200	mA
1st Level Safety	Current	Current Recovery Time	U1	0	240	8	s

Table C-246. DATA FLASH VALUES (continued)

Class	SubClass	Name	Data Type	Min	Max	Default	Unit
1st Level Safety	Current	AFE OC Dsg	H1	0x0	0xf	0x7	
1st Level Safety	Current	AFE OC Dsg Time	H1	0x0	0xf	0x7	
1st Level Safety	Current	AFE OC Dsg Recovery	I2	5	1000	5	mA
1st Level Safety	Current	AFE SC Chg Cfg	H1	0x0	0xf7	0x73	
1st Level Safety	Current	AFE SC Dsg Cfg	H1	0x0	0xf7	0x73	
1st Level Safety	Current	AFE SC Dsg Cfg 2	H1	0x0	0xf7	0xe3	
1st Level Safety	Current	AFE SC Recovery	I2	0	200	1	mA
1st Level Safety	Temperature	Over Temp Chg	I2	0	1200	550	0.1 °C
1st Level Safety	Temperature	OT Chg Time	U1	0	240	2	s
1st Level Safety	Temperature	OT Chg Recovery	I2	0	1200	500	0.1 °C
1st Level Safety	Temperature	Over Temp Dsg	I2	0	1200	600	0.1 °C
1st Level Safety	Temperature	OT Dsg Time	U1	0	240	2	s
1st Level Safety	Temperature	OT Dsg Recovery	I2	0	1200	550	0.1 °C
2nd Level Safety	Voltage	LT SOV Threshold	I2	0	20000	4400	mV
2nd Level Safety	Voltage	ST SOV Threshold	I2	0	20000	4600	mV
2nd Level Safety	Voltage	HT SOV Threshold	I2	0	20000	4500	mV
2nd Level Safety	Voltage	SOV Time	U1	0	240	0	S
2nd Level Safety	Voltage	PF SOV Fuse Blow Delay	U2	0	240	0	S
2nd Level Safety	Voltage	Cell Imbalance Current	I1	0	127	5	mA
2nd Level Safety	Voltage	Cell Imbalance Fail Voltage	I2	0	5000	1000	mV
2nd Level Safety	Voltage	Cell Imbalance Time	U1	0	240	0	s
2nd Level Safety	Voltage	Battery Rest Time	U2	0	65535	1800	s
2nd Level Safety	Voltage	Min CIM-check voltage	U2	0	65535	3000	mV
2nd Level Safety	Voltage	PFIN Detect Time	U1	0	240	0	s
2nd Level Safety	Current	SOC Chg	I2	0	30000	10000	mA
2nd Level Safety	Current	SOC Chg Time	U1	0	240	0	s
2nd Level Safety	Current	SOC Dsg	I2	0	30000	10000	mA

Table C-246. DATA FLASH VALUES (continued)

Class	SubClass	Name	Data Type	Min	Max	Default	Unit
2nd Level Safety	Current	SOC Dsg Time	U1	0	240	0	s
2nd Level Safety	Temperature	SOT Chg	I2	0	1200	650	0.1 °C
2nd Level Safety	Temperature	SOT Chg Time	U1	0	240	0	s
2nd Level Safety	Temperature	SOT Dsg	I2	0	1200	750	0.1 °C
2nd Level Safety	Temperature	SOT Dsg Time	U1	0	240	0	s
2nd Level Safety	Temperature	Open Thermistor	I2	-1000	1200	-333	0.1 °C
2nd Level Safety	Temperature	Open Time	I1	0	240	0	s
2nd Level Safety	FET Verification	FET Fail Limit	I2	0	500	20	mA
2nd Level Safety	FET Verification	FET Fail Time	U1	0	240	0	s
2nd Level Safety	AFE Verification	AFE Check Time	U1	0	255	0	s
2nd Level Safety	AFE Verification	AFE Fail Limit	U1	0	255	10	
2nd Level Safety	AFE Verification	AFE Fail Recovery Time	U1	0	255	20	s
2nd Level Safety	AFE Verification	AFE Init Retry Limit	U1	0	255	6	
2nd Level Safety	AFE Verification	AFE Init Limit	U1	0	255	20	
System Data	Lifetime Data	Lifetime Max Temp	I2	0	1400	300	0.1 °C
System Data	Lifetime Data	Lifetime Min Temp	I2	-600	1400	200	0.1 °C
System Data	Lifetime Data	Lifetime Max Cell Voltage	I2	0	32767	3500	mV
System Data	Lifetime Data	Lifetime Min Cell Voltage	I2	0	32767	3200	mV

Glossary

ADC	Analog to Digital Converter
AFE	Analog Front End
alert	A warning set by the bq3055
bit	A single bit in an SBS command or Data Flash value, which can be changed by the user
CC	Coulomb Counter
CHG FET	Charge FET, connected to the CHG pin of the integrated AFE; used by the integrated AFE to enable or disable charging
COV	Cell Over Voltage
CPU	Central Processing Unit
CUV	Cell Under Voltage
DF	Data Flash
DSG	Flag set by the bq3055 to indicate charge (DSG= 0) or discharge (DSG=1)
DSG FET	Discharge FET, connected to the DSG pin of the integrated AFE; used by the integrated AFE to enable or disable discharging
FAS	Full Access Security
FC	Fully Charged
FCHG	Fast Charge
FCMTO	Fast Charge Timeout
FD	Fully Discharged
flag	A single bit in an SBS command or Data Flash value, which is set by the bq3055 or the integrated AFE and indicates a status change
IC	Integrated Circuit
Li-Ion	Lithium-Ion
NR	Non-Removable
OC	Overcurrent
OCA	Over Charge Alarm
OCV	Open Circuit Voltage
OTC	Over Temperature Charging
OTD	Over Temperature Discharging
PCHG	Pre-Charge
PCMTO	Pre-Charge Timeout
PEC	Packet Error Checking
PF	Permanent Fail
PRES	System Present Flag
Qmax	Maximum Chemical Capacity
RCA	Remaining Capacity Alarm
RSOC	Relative State of Charge
SBS	Smart Battery System
SCC	Short Circuit Charge

SCD	Short Circuit Discharge
SMBus	System Management Bus
SOC	Safety overcurrent
SOT	Safety Over Temperature
SS	Sealed mode flag
SYS_PRES	System present terminal
TCA	Terminate Charge Alarm
TDA	Terminate Discharge Alarm
Zero-volt charge	The action of charging a totally depleted battery, i.e. the battery cell's voltage is 0 V
ZVCHG FET	Precharge FET, connected to the ZVCHG pin; it is used for pre-charging only in bq3055
XDSG	Discharge Fault flag

IMPORTANT NOTICE

Texas Instruments Incorporated and its subsidiaries (TI) reserve the right to make corrections, modifications, enhancements, improvements, and other changes to its products and services at any time and to discontinue any product or service without notice. Customers should obtain the latest relevant information before placing orders and should verify that such information is current and complete. All products are sold subject to TI's terms and conditions of sale supplied at the time of order acknowledgment.

TI warrants performance of its hardware products to the specifications applicable at the time of sale in accordance with TI's standard warranty. Testing and other quality control techniques are used to the extent TI deems necessary to support this warranty. Except where mandated by government requirements, testing of all parameters of each product is not necessarily performed.

TI assumes no liability for applications assistance or customer product design. Customers are responsible for their products and applications using TI components. To minimize the risks associated with customer products and applications, customers should provide adequate design and operating safeguards.

TI does not warrant or represent that any license, either express or implied, is granted under any TI patent right, copyright, mask work right, or other TI intellectual property right relating to any combination, machine, or process in which TI products or services are used. Information published by TI regarding third-party products or services does not constitute a license from TI to use such products or services or a warranty or endorsement thereof. Use of such information may require a license from a third party under the patents or other intellectual property of the third party, or a license from TI under the patents or other intellectual property of TI.

Reproduction of TI information in TI data books or data sheets is permissible only if reproduction is without alteration and is accompanied by all associated warranties, conditions, limitations, and notices. Reproduction of this information with alteration is an unfair and deceptive business practice. TI is not responsible or liable for such altered documentation. Information of third parties may be subject to additional restrictions.

Resale of TI products or services with statements different from or beyond the parameters stated by TI for that product or service voids all express and any implied warranties for the associated TI product or service and is an unfair and deceptive business practice. TI is not responsible or liable for any such statements.

TI products are not authorized for use in safety-critical applications (such as life support) where a failure of the TI product would reasonably be expected to cause severe personal injury or death, unless officers of the parties have executed an agreement specifically governing such use. Buyers represent that they have all necessary expertise in the safety and regulatory ramifications of their applications, and acknowledge and agree that they are solely responsible for all legal, regulatory and safety-related requirements concerning their products and any use of TI products in such safety-critical applications, notwithstanding any applications-related information or support that may be provided by TI. Further, Buyers must fully indemnify TI and its representatives against any damages arising out of the use of TI products in such safety-critical applications.

TI products are neither designed nor intended for use in military/aerospace applications or environments unless the TI products are specifically designated by TI as military-grade or "enhanced plastic." Only products designated by TI as military-grade meet military specifications. Buyers acknowledge and agree that any such use of TI products which TI has not designated as military-grade is solely at the Buyer's risk, and that they are solely responsible for compliance with all legal and regulatory requirements in connection with such use.

TI products are neither designed nor intended for use in automotive applications or environments unless the specific TI products are designated by TI as compliant with ISO/TS 16949 requirements. Buyers acknowledge and agree that, if they use any non-designated products in automotive applications, TI will not be responsible for any failure to meet such requirements.

Following are URLs where you can obtain information on other Texas Instruments products and application solutions:

Products

Audio	www.ti.com/audio
Amplifiers	amplifier.ti.com
Data Converters	dataconverter.ti.com
DLP® Products	www.dlp.com
DSP	dsp.ti.com
Clocks and Timers	www.ti.com/clocks
Interface	interface.ti.com
Logic	logic.ti.com
Power Mgmt	power.ti.com
Microcontrollers	microcontroller.ti.com
RFID	www.ti-rfid.com
OMAP Mobile Processors	www.ti.com/omap
Wireless Connectivity	www.ti.com/wirelessconnectivity

Applications

Automotive and Transportation	www.ti.com/automotive
Communications and Telecom	www.ti.com/communications
Computers and Peripherals	www.ti.com/computers
Consumer Electronics	www.ti.com/consumer-apps
Energy and Lighting	www.ti.com/energy
Industrial	www.ti.com/industrial
Medical	www.ti.com/medical
Security	www.ti.com/security
Space, Avionics and Defense	www.ti.com/space-avionics-defense
Video and Imaging	www.ti.com/video

TI E2E Community Home Page

e2e.ti.com

Mailing Address: Texas Instruments, Post Office Box 655303, Dallas, Texas 75265
Copyright © 2012, Texas Instruments Incorporated