

EVM User's Guide: BQ51013C-Q1EVM

BQ51013C-Q1 Evaluation Module



Description

The BQ51013C-Q1EVM is a Wireless Power Receiver based on the Qi standard from Wireless Power Consortium. The device complies with Baseline Power Profile (BPP) of 5W. Output voltage is 5V up to 1A. The BQ51013C-Q1EVM contains the BQ51013C IC and support circuits needed operate the evaluation board. An external Qi Transmitter is needed to power the EVM.

The receiver coil is a 48mm × 32mm coil mounted to the plastic frame below PCB. The case thickness below coil to interface surface is 2mm.

Features

- Support WPC v2.0, BPP
- Output voltage 5V at 1A
- Supports USB external input
- Adjustable output current limit
- Adjustable foreign object detection

Applications

- [True wireless headsets](#)
- [Wearable accessories, smart band](#)
- [Beauty and grooming](#)
- [Electric toothbrush](#)

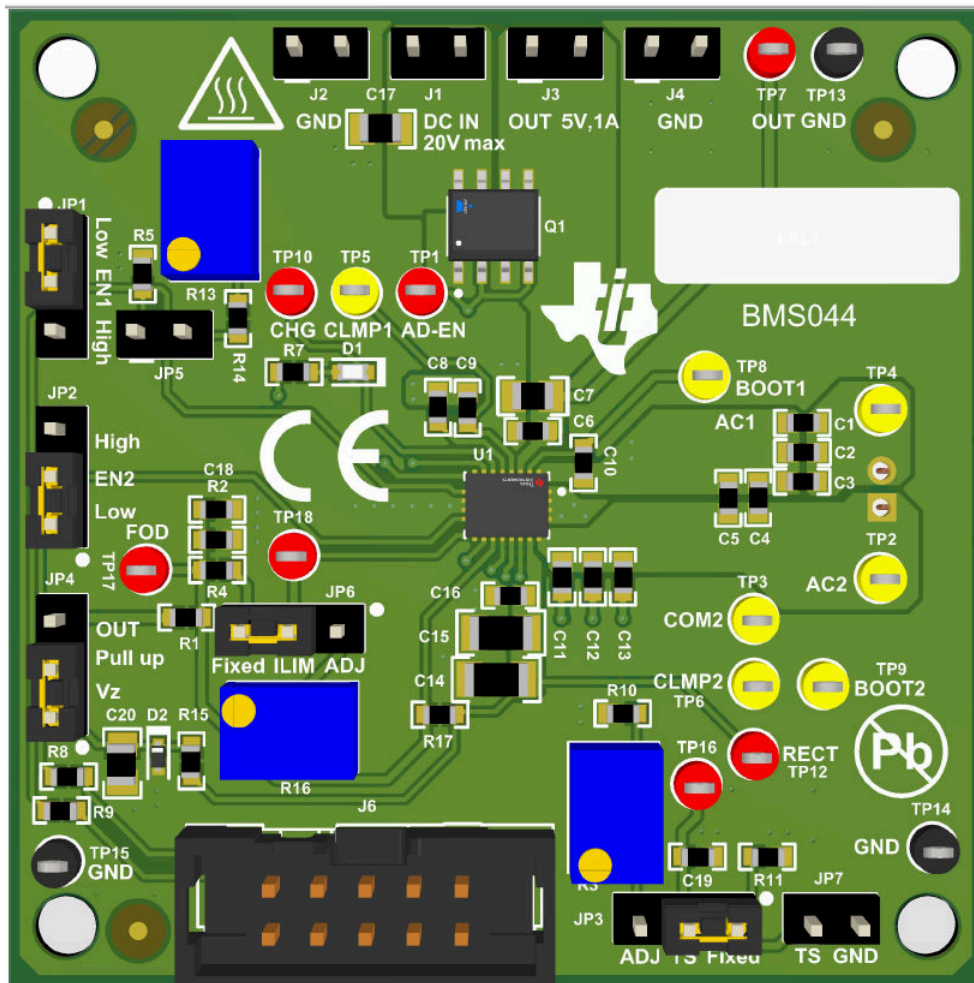

1 Evaluation Module Overview

1.1 Introduction

The BQ51013C is a wireless power supply and produces 5V out at up to 1A for a 5W design. The device supports Qi version 2.0 and is a 5W Baseline Power Profile (BPP). The receiver is powered by a Qi compliant transmitter using the planer coil at the base of EVM. Communication protocols and safety features are incorporated into the BQ51013C-Q1 making the device simple to use.

The USB-optional input feature is provided by Q1; this automatically switches from wireless power to external power when present. The NTC is simulated by a 10k resistor and has the option to be adjusted by a trim pot. Output current can be adjusted using R16 or fixed value can be selected.

This user's guide describes the characteristics, operation, and use of the BQ51013C-Q1 EVM evaluation module (EVM). This EVM is designed to help the user evaluate and test the various operating modes. This user's guide includes setup instructions for the hardware, a schematic diagram, a bill of materials (BOM), and PCB layout drawings for the evaluation module.

Throughout this user's guide, the abbreviations *EVM*, *BQ51013C-Q1 EVM*, *BMS044-002* and the term *evaluation module* are synonymous with the BQ51013C-Q1 evaluation module, unless otherwise noted.

1.2 Kit Contents

The package includes:

- (1) BQ51013C evaluation module (EVM) that has BQ51013C and supporting circuits.

1.3 Specification

[Table 1-1](#) provides a summary of the BQ51013C-Q1 EVM performance specifications. All specifications are given for an ambient temperature of 25°C.

Table 1-1. BQ51013C-Q1 EVM Electrical Performance Specifications

Parameter		Test Condition	MIN	TYPE	MAX	UNIT
V _{IN}	Input voltage range	Typical Vrect Voltage at TP12	4.0	5.5	8	V
V _{adapter}	Adapter input voltage		4.0	5	20	V
OVP	Input overvoltage protection	Voltage at V-rectified			15	V
I _{OUT}	Output current range	Current limit programming range			1.5	A
V _{OUT}	Output voltage	I _{LOAD} = 1000mA		5		V
F _s	Switching frequency		110		205	kHz
Efficiency	AC-DC	Load = 1000mA at 5V		65		%

1.4 Device Information

The BQ51013C-Q1 device is a wireless power receiver (RX) for portable applications capable of providing up to 5W, 1A at 5V. The BQ51013C-Q1 devices provide the RX AC-to-DC power conversion and regulation while integrating the digital control required to comply with the Wireless Power Consortium (WPC) Qi v2.0 communication protocol. Together with the BQ500212A primary-side controller (or other Qi transmitter), the BQ51013C-Q1 enables a complete contactless power transfer system for a wireless power supply design. Global feedback is established from the secondary to the primary to control the power transfer process using the Qi v2.0 protocol.

2 Hardware

2.1 I/O Descriptions

Table 2-1 lists the input and output connections available on this EVM and the respective descriptions.

Table 2-1. EVM I/O Connections

I/O Connector	Description
J1 – AD external adapter input J2-GND	Power can be provided to simulate an external adapter applied, max voltage 20V.
J3 – Output voltage J4-GND	Output voltage is 5V in wireless power mode up to 1A.
J5 – TS and return connector	External connection for temperature sense resistor, see the data sheet for additional information.
JP1 – EN1 Enable 1 JP2 – EN2 Enable 2	Enable signal input that allows the system to enable or disable wireless charging or AD input.
JP3 – TS Fixed or ADJ	Enables the TS adjustment feature using R3. The Fixed position sets voltage at the TS pin to a safe value.
JP4 – Pull-up to out or Vz	EN1 / 2 pull-up can be powered from OUT or RECT. Vz is derived from RECT through a resistor and Zener diode D2.
JP5 – DNP	Not used, do not install.
JP6 – ILIM Fix or ADJ	Max output current is set by ILIM pin. In the FIX position, the current is set to a fixed value. In the ADJ position the current is set by R16.

2.2 Printed Circuit Board Assembly

The BQ51013C-Q1 EVM PCB contains the BQ51013C-Q1 EVM IC and support circuits. This board contains several jumpers and connectors. R16 provides the option to adjust current limit. EN1 / EN2 can be used to enable / disable the wireless power or AD external power input.

PCB is a two layer board and optimized for evaluation with larger parts and wide spacing. Smaller layout is possible. Power dissipation on the BQ51013C-Q1 can be high and good thermal management is recommended. Large thermal plane and thermal vias.

2.3 Best Practices



WARNING

Hot surface! Contact can cause burns. Do not touch!

Some components can reach high temperatures >55°C when the board is powered on. The user must not touch the board at any point during operation or immediately after operating, as high temperatures can be present.

2.4 Test Summary

This section describes the jumpers and connectors on the EVM as well as how to properly connect, setup. See Table 2-2 for Jumper Factory Setting for default jumper setting of headers.

2.4.1 Equipment

This section includes a list of supplies required to perform tests on this EVM.

1. Power supply, 5V 2A input. Connect to Wireless Power transmitter.
2. Load, resistive load or electronic load set to 10Ω at 500mA. The load is connected between J3 - OUT and J4 - GND of the UUT. A DC ammeter is connected between UUT and Load. Set the load for 10Ω at 500mA.
3. Meters – Two DC voltmeter and two DC ammeters.
4. Wireless Power Transmitter, can be the BQ50212A EVM or similar Qi certified unit.
 - Connect ammeter to measure 5V input current to transmitter.
 - Connect voltmeter to monitor input voltage at J1 and J2 of TX unit.

- On UUT, a voltmeter is used to measure output voltage at J3 with ground at J4.
 - Connect ammeter to measure load current.
5. Configure all EVM jumpers to factory setting and refer to [Table 2-2](#).

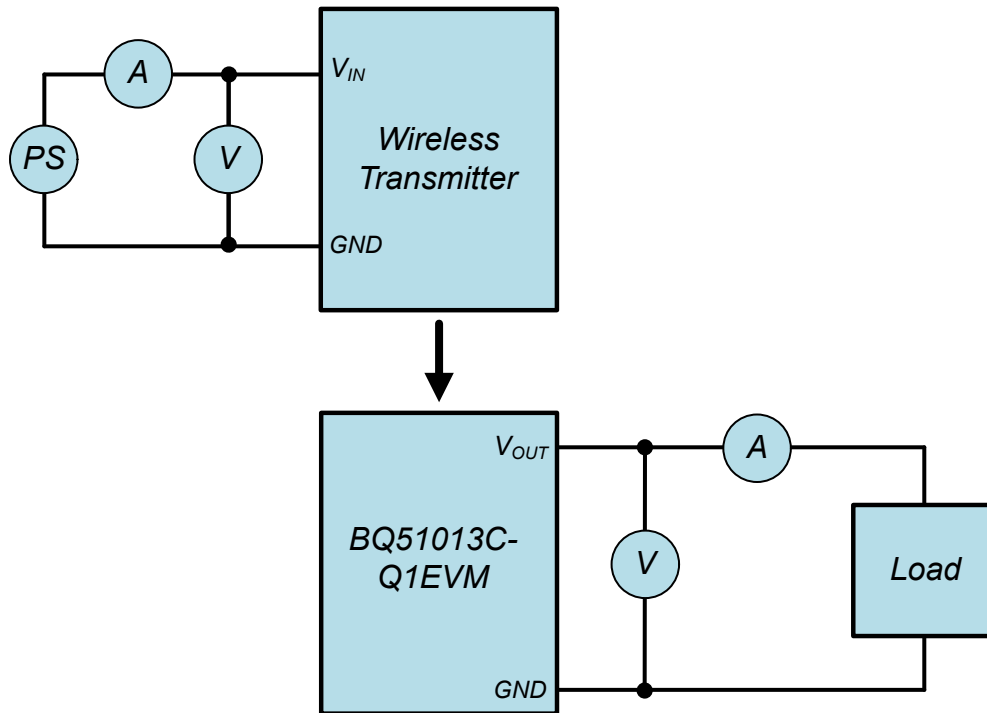

2.4.2 Cautions

Device can get hot during high output current conditions, use caution when handling the board.

2.4.3 Test Instructions

For the EVM to operate properly, the following components must be connected and properly configured.

1. Connect system as above, UUT on transmitter.
2. Input voltage connected to Transmitter J1 (+), J2 (-).
3. Set load to 500mA and connected to UUT BQ51013C-Q1EVM (Receiver) J3 (+) and J4 (-).
4. Turn ON transmitter Power Supply (5V), after 5 seconds, verify that:
 - a. Transmitter – status LED D5 is flashing Green at 1 second rate indicating power transfer.
 - b. UUT Receiver – LED D1 is ON. Also indicating power transfer.
5. UUT Receiver – Verify that VOUT is 4.9V to 5.1V (Between J3 or TP7 and J4).
6. UUT Receiver – Verify that rectified voltage is 5V to 5.2V (between TP12 and TP13)

Note

A modulation signal is present on the voltage every 250 milliseconds and can cause fluctuation in the reading use lower value or base line.

Table 2-2. Jumper Factory Setting

I/O Connector	Factory Setting
EN1 - JP1 (3 pin header)	Installed EN and LOW
EN2 - JP2 (3 pin Header)	Installed EN2 and LOW
TS - JP3 (3 pin header)	Installed TS and FIXED
PULLUP - JP4 (3 pin header)	Installed PULLUP and Vz
N/A - JP5 (2 pin header)	N/A
ILIM - JP6 (3 pin header)	Installed ILIM and FIX

3.2 PCB Layout

The board layout is shown in [Figure 3-2](#) to [Figure 3-8](#).

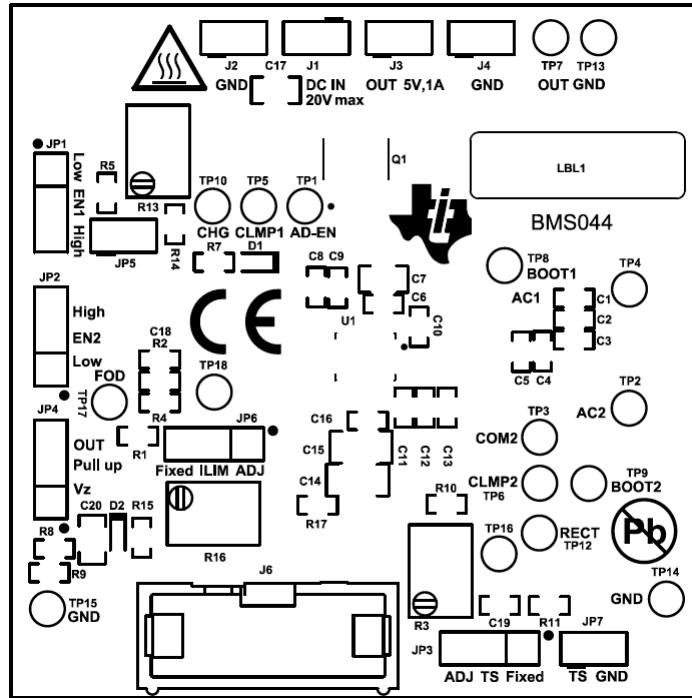

Figure 3-2. Top Overlay

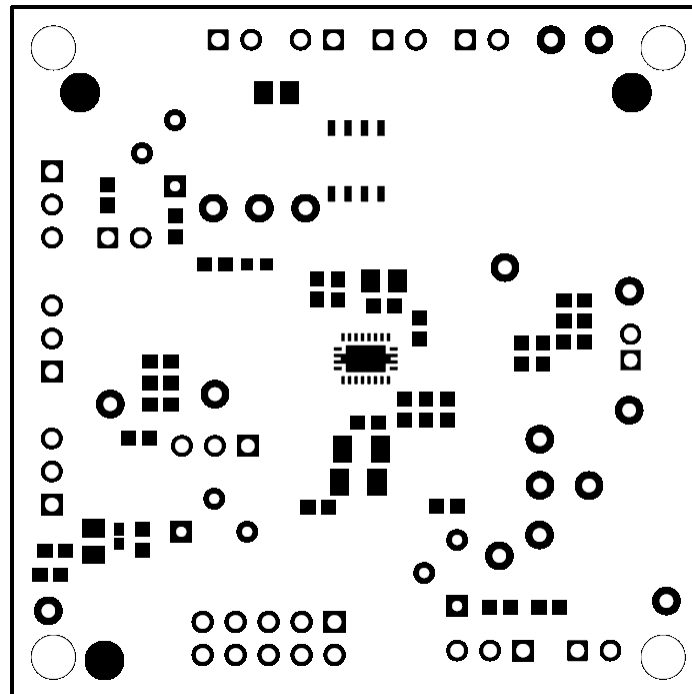

Figure 3-3. Top Solder

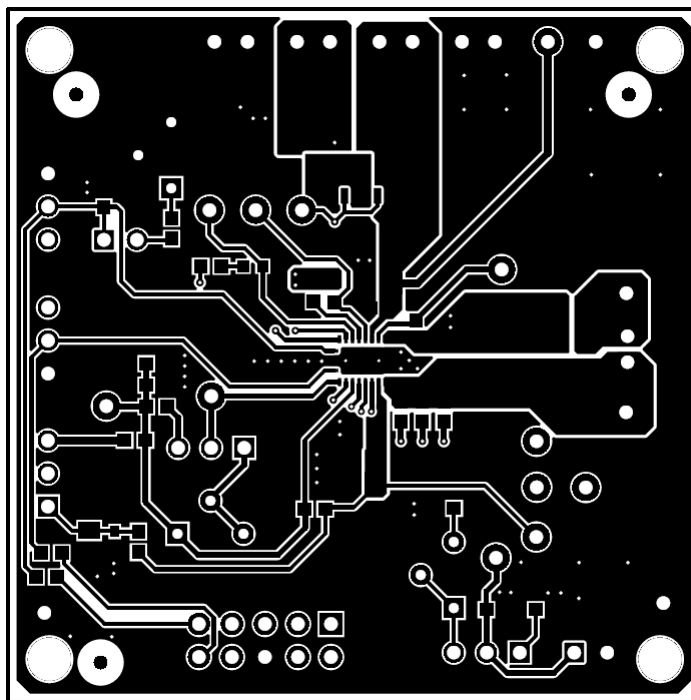

Figure 3-4. Top Layer

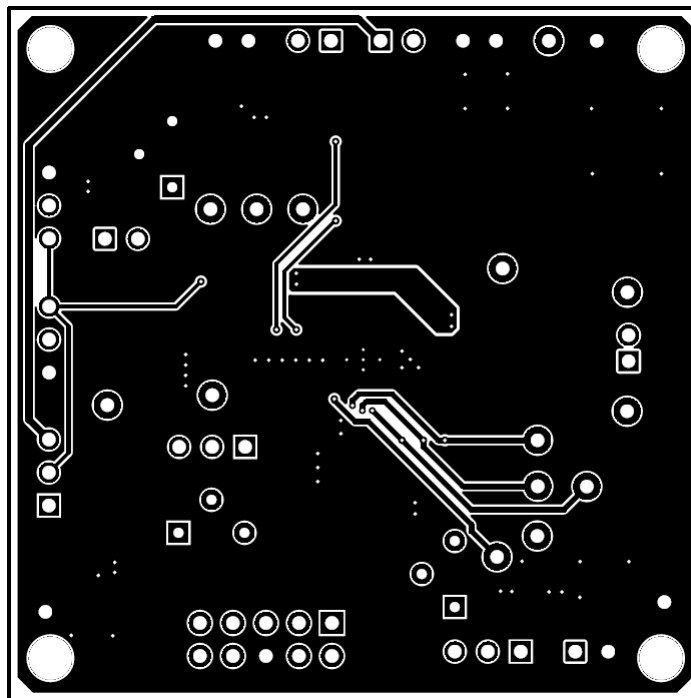

Figure 3-5. Bottom Layer

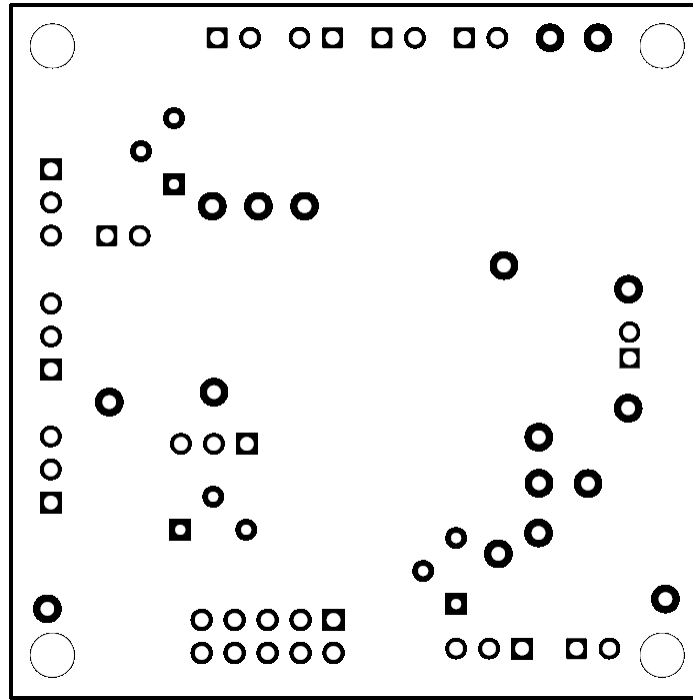

Figure 3-6. Bottom Solder

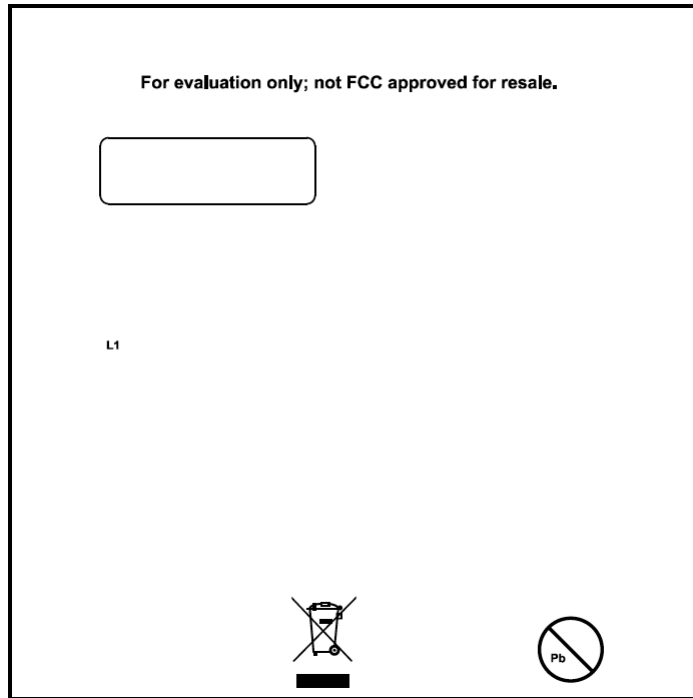
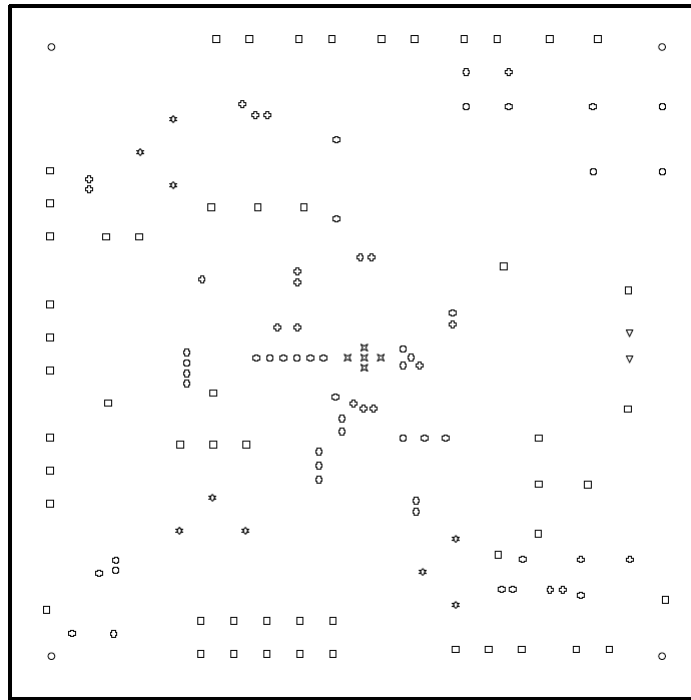

Figure 3-7. Bottom Overlay



Symbol	Quantity	Finished Hole Size	Plated	Hole Type	Drill Layer Pair	Hole Tolerance
○	4	3.302mm (130.00mil)	NPTH	Round	Top Layer - Bottom Layer	
⊗	5	0.200mm (7.87mil)	PTH	Round	Top Layer - Bottom Layer	
⊕	65	0.254mm (10.00mil)	PTH	Round	Top Layer - Bottom Layer	
⊛	9	0.750mm (29.53mil)	PTH	Round	Top Layer - Bottom Layer	
▽	2	1.000mm (39.37mil)	PTH	Round	Top Layer - Bottom Layer	
□	54	1.016mm (40.00mil)	PTH	Round	Top Layer - Bottom Layer	
	139 Total					

Figure 3-8. Drill Drawing

3.3 Bill of Materials (BOM)

Table 3-1 lists the bill of materials.

Table 3-1. Bill of Materials ⁽¹⁾

Designator	Qty	Value	Description	Package Reference	Part Number	Manufacturer
!PCB	1		Printed Circuit Board		BMS044	Any
C1, C2	2	0.068uF	CAP, CERM, 0.068 uF, 50 V, +/- 10%, X7R, AEC-Q200 Grade 1, 0603	0603	CGA3E2X7R1H683K080AA	TDK
C3	1	0.047uF	CAP, CERM, 0.047uF, 50V, +/- 10%, X7R, 0603	0603	C1608X7R1H473K080AA	TDK
C4	1	1800pF	CAP, CERM, 1800 pF, 50 V, +/- 5%, C0G/NP0, 0603	0603	GRM1885C1H182JA01D	MuRata
C5	1	100pF	CAP, CERM, 100 pF, 100 V, +/- 5%, C0G/NP0, AEC-Q200 Grade 1, 0603	0603	GCM1885C2A101JA16D	MuRata
C6, C16, C18, C19	4	0.1uF	CAP, CERM, 0.1 uF, 50 V, +/- 10%, X7R, 0603	0603	GCM188R71H104KA57D	MuRata
C7, C17, C20	3	1uF	CAP, CERM, 1 uF, 50 V, +/- 10%, X7R, 0805	805	CL21B105KBFNNNE	Samsung Electro-Mechanics
C8, C13	2	0.022uF	CAP, CERM, 0.022uF, 50V, +/- 10%, X7R, 0603	0603	C0603C223K5RACTU	Kemet
C9, C12	2	0.47uF	CAP, CERM, 0.47uF, 25V, +/- 10%, X7R, 0603	0603	GRM188R71E474KA12D	MuRata
C10, C11	2	0.01uF	CAP, CERM, 0.01uF, 50V, +/- 10%, X7R, 0603	0603	C0603C103K5RACTU	Kemet
C14, C15	2	10uF	CAP, CERM, 10 uF, 35 V, +/- 10%, X7R, 1206_190	1206_190	CL31B106KLHNNNE	Samsung Electro-Mechanics
D1	1	Green	LED, Green, SMD	1.6x0.8x0.8mm	LTST-C190GKT	Lite-On
D2	1	5.1V	Diode, Zener, 5.1V, 300mW, SOD-523	SOD-523	BZT52C5V1T-7	Diodes Inc.
H1	1		Tape segment, Low Static Polyimide Film. Cut tape section from 36 yard roll	1.5" x 2.3"	5419-1 1/2"	3M
H2	1		Case Modified Polycase LP-11B with 4 screws		J-6838A	Polycase
H4, H5, H6, H7	4		#4 x 3/8" pan head phillips screw	#4 x 3/8"	PMSSS 440 0038 PH	B&F Fastener
H8, H9, H10, H11	4		Spacer, 0.100" Thk x 0.25" OD x 0.147" ID	0.1" THK	905-100	Bivar
J1, J2, J3, J4, JP7	5		Header, 100mil, 2x1, Tin, TH	Header, 2 PIN, 100mil, Tin	PEC02SAAN	Sullins Connector Solutions
JP1, JP2, JP3, JP4, JP6	5		Header, 100mil, 3x1, Tin, TH	Header, 3 PIN, 100mil, Tin	PEC03SAAN	Sullins Connector Solutions
L1	1	14.3uH	1 Coil, 1 Layer 14.3uH Wireless Charging Coil Receiver 190mOhm Max	Inductor_48MM00_32MM00	760308103215	Würth Electronics
LBL1, LBL2	2			PCB Label 0.650 x 0.200 inch	THT-14-423-10	Brady
Q1	1		Trans MOSFET P-CH 30V 7.5A Automotive 8-Pin SOIC N T/R	SOIC8	SQ4949EY-T1_GE3	Vishay

Table 3-1. Bill of Materials (1) (continued)

Designator	Qty	Value	Description	Package Reference	Part Number	Manufacturer
R2	1	200	RES, 200, 1%, 0.1W, 0603	0603	RC0603FR-07200RL	Yageo
R3	1	100k	Trimmer, 100k ohm, 0.25W, TH	4.5x8x6.7mm	3266W-1-104LF	Bourns
R4	1	110	RES, 110, 1%, 0.1W, 0603	0603	RC0603FR-07110RL	Yageo
R7	1	1.50k	RES, 1.50k, 1%, 0.1W, 0603	0603	RC0603FR-071K5L	Yageo
R10	1	499	RES, 499, 1%, 0.1W, 0603	0603	CRCW0603499RFKEAC	Vishay-Dale
R11	1	10.0k	RES, 10.0k, 1%, 0.1W, 0603	0603	RC0603FR-0710KL	Yageo
R15	1	1.00k	RES, 1.00k, 1%, 0.1W, 0603	0603	RC0603FR-071KL	Yageo
R16	1	5 K	Trimmer, 5k ohm, 0.25W, TH	4.5x8x6.7mm	3266W-1-502LF	Bourns
R17	1	42.2k	RES, 42.2 k, 1%, 0.1W, 0603	0603	RC0603FR-0742K2L	Yageo
SH-JP1, SH-JP2, SH-JP3, SH-JP4, SH-JP6	5	1x2	Shunt, 100mil, Gold plated, Black	Shunt	SNT-100-BK-G	Samtec
TP1, TP7, TP10, TP12, TP16, TP17, TP18	7		Test Point, Miniature, Red, TH	Red Miniature Test point	5000	Keystone
TP2, TP3, TP4, TP5, TP6, TP8, TP9	7		Test Point, Miniature, Yellow, TH	Yellow Miniature Test point	5004	Keystone
TP13, TP14, TP15	3		Test Point, Miniature, Black, TH	Black Miniature Test point	5001	Keystone
U1	1		BQ51013BQWRHLT	VQFN20	BQ51013BQWRHLT	Texas Instruments
FID1, FID2, FID3	0		Fiducial mark. There is nothing to buy or mount.	N/A	N/A	N/A
J6	0		Header (shrouded), 100mil, 5x2, High-Temperature, Gold, TH	5x2 Shrouded header	N2510-6002-RB	3M
JP5	0		Header, 100mil, 2x1, Tin, TH	Header, 2 PIN, 100mil, Tin	PEC02SAAN	Sullins Connector Solutions
R1, R5, R14	0	10.0k	RES, 10.0k, 1%, 0.1W, 0603	0603	RC0603FR-0710KL	Yageo
R8, R9	0	200	RES, 200, 1%, 0.1W, 0603	0603	RC0603FR-07200RL	Yageo
R13	0	20k	Trimmer, 20k ohm, 0.25W, TH	4.5x8x6.7mm	3266W-1-203LF	Bourns

(1) Unless otherwise noted in the Alternate PartNumber and/or Alternate Manufacturer columns, all parts can be substituted with equivalents.

4 Additional Information

4.1 Trademarks

All trademarks are the property of their respective owners.

5 Related Documentation

Texas Instruments, [BQ51013C-Q1 Automotive Highly Integrated Wireless Receiver Qi \(WPC v2.0\) Compliant Power Supply](#) full data sheet

Texas Instruments, [BQ51013C-Q1 Automotive Highly Integrated Wireless Receiver Qi \(WPC v2.0\) Compliant Power Supply](#) short data sheet

6 Revision History

NOTE: Page numbers for previous revisions may differ from page numbers in the current version.

Changes from Revision * (June 2024) to Revision A (September 2024)	Page
• Updated capacitors in Bill of Materials.....	10

STANDARD TERMS FOR EVALUATION MODULES

1. *Delivery:* TI delivers TI evaluation boards, kits, or modules, including any accompanying demonstration software, components, and/or documentation which may be provided together or separately (collectively, an "EVM" or "EVMs") to the User ("User") in accordance with the terms set forth herein. User's acceptance of the EVM is expressly subject to the following terms.
 - 1.1 EVMs are intended solely for product or software developers for use in a research and development setting to facilitate feasibility evaluation, experimentation, or scientific analysis of TI semiconductors products. EVMs have no direct function and are not finished products. EVMs shall not be directly or indirectly assembled as a part or subassembly in any finished product. For clarification, any software or software tools provided with the EVM ("Software") shall not be subject to the terms and conditions set forth herein but rather shall be subject to the applicable terms that accompany such Software
 - 1.2 EVMs are not intended for consumer or household use. EVMs may not be sold, sublicensed, leased, rented, loaned, assigned, or otherwise distributed for commercial purposes by Users, in whole or in part, or used in any finished product or production system.
2. *Limited Warranty and Related Remedies/Disclaimers:*
 - 2.1 These terms do not apply to Software. The warranty, if any, for Software is covered in the applicable Software License Agreement.
 - 2.2 TI warrants that the TI EVM will conform to TI's published specifications for ninety (90) days after the date TI delivers such EVM to User. Notwithstanding the foregoing, TI shall not be liable for a nonconforming EVM if (a) the nonconformity was caused by neglect, misuse or mistreatment by an entity other than TI, including improper installation or testing, or for any EVMs that have been altered or modified in any way by an entity other than TI, (b) the nonconformity resulted from User's design, specifications or instructions for such EVMs or improper system design, or (c) User has not paid on time. Testing and other quality control techniques are used to the extent TI deems necessary. TI does not test all parameters of each EVM. User's claims against TI under this Section 2 are void if User fails to notify TI of any apparent defects in the EVMs within ten (10) business days after delivery, or of any hidden defects with ten (10) business days after the defect has been detected.
 - 2.3 TI's sole liability shall be at its option to repair or replace EVMs that fail to conform to the warranty set forth above, or credit User's account for such EVM. TI's liability under this warranty shall be limited to EVMs that are returned during the warranty period to the address designated by TI and that are determined by TI not to conform to such warranty. If TI elects to repair or replace such EVM, TI shall have a reasonable time to repair such EVM or provide replacements. Repaired EVMs shall be warranted for the remainder of the original warranty period. Replaced EVMs shall be warranted for a new full ninety (90) day warranty period.

WARNING

Evaluation Kits are intended solely for use by technically qualified, professional electronics experts who are familiar with the dangers and application risks associated with handling electrical mechanical components, systems, and subsystems.

User shall operate the Evaluation Kit within TI's recommended guidelines and any applicable legal or environmental requirements as well as reasonable and customary safeguards. Failure to set up and/or operate the Evaluation Kit within TI's recommended guidelines may result in personal injury or death or property damage. Proper set up entails following TI's instructions for electrical ratings of interface circuits such as input, output and electrical loads.

NOTE:

EXPOSURE TO ELECTROSTATIC DISCHARGE (ESD) MAY CAUSE DEGRADATION OR FAILURE OF THE EVALUATION KIT; TI RECOMMENDS STORAGE OF THE EVALUATION KIT IN A PROTECTIVE ESD BAG.

3 Regulatory Notices:

3.1 United States

3.1.1 Notice applicable to EVMs not FCC-Approved:

FCC NOTICE: This kit is designed to allow product developers to evaluate electronic components, circuitry, or software associated with the kit to determine whether to incorporate such items in a finished product and software developers to write software applications for use with the end product. This kit is not a finished product and when assembled may not be resold or otherwise marketed unless all required FCC equipment authorizations are first obtained. Operation is subject to the condition that this product not cause harmful interference to licensed radio stations and that this product accept harmful interference. Unless the assembled kit is designed to operate under part 15, part 18 or part 95 of this chapter, the operator of the kit must operate under the authority of an FCC license holder or must secure an experimental authorization under part 5 of this chapter.

3.1.2 For EVMs annotated as FCC – FEDERAL COMMUNICATIONS COMMISSION Part 15 Compliant:

CAUTION

This device complies with part 15 of the FCC Rules. Operation is subject to the following two conditions: (1) This device may not cause harmful interference, and (2) this device must accept any interference received, including interference that may cause undesired operation.

Changes or modifications not expressly approved by the party responsible for compliance could void the user's authority to operate the equipment.

FCC Interference Statement for Class A EVM devices

NOTE: This equipment has been tested and found to comply with the limits for a Class A digital device, pursuant to part 15 of the FCC Rules. These limits are designed to provide reasonable protection against harmful interference when the equipment is operated in a commercial environment. This equipment generates, uses, and can radiate radio frequency energy and, if not installed and used in accordance with the instruction manual, may cause harmful interference to radio communications. Operation of this equipment in a residential area is likely to cause harmful interference in which case the user will be required to correct the interference at his own expense.

FCC Interference Statement for Class B EVM devices

NOTE: This equipment has been tested and found to comply with the limits for a Class B digital device, pursuant to part 15 of the FCC Rules. These limits are designed to provide reasonable protection against harmful interference in a residential installation. This equipment generates, uses and can radiate radio frequency energy and, if not installed and used in accordance with the instructions, may cause harmful interference to radio communications. However, there is no guarantee that interference will not occur in a particular installation. If this equipment does cause harmful interference to radio or television reception, which can be determined by turning the equipment off and on, the user is encouraged to try to correct the interference by one or more of the following measures:

- Reorient or relocate the receiving antenna.
- Increase the separation between the equipment and receiver.
- Connect the equipment into an outlet on a circuit different from that to which the receiver is connected.
- Consult the dealer or an experienced radio/TV technician for help.

3.2 Canada

3.2.1 For EVMs issued with an Industry Canada Certificate of Conformance to RSS-210 or RSS-247

Concerning EVMs Including Radio Transmitters:

This device complies with Industry Canada license-exempt RSSs. Operation is subject to the following two conditions:

(1) this device may not cause interference, and (2) this device must accept any interference, including interference that may cause undesired operation of the device.

Concernant les EVMs avec appareils radio:

Le présent appareil est conforme aux CNR d'Industrie Canada applicables aux appareils radio exempts de licence. L'exploitation est autorisée aux deux conditions suivantes: (1) l'appareil ne doit pas produire de brouillage, et (2) l'utilisateur de l'appareil doit accepter tout brouillage radioélectrique subi, même si le brouillage est susceptible d'en compromettre le fonctionnement.

Concerning EVMs Including Detachable Antennas:

Under Industry Canada regulations, this radio transmitter may only operate using an antenna of a type and maximum (or lesser) gain approved for the transmitter by Industry Canada. To reduce potential radio interference to other users, the antenna type and its gain should be so chosen that the equivalent isotropically radiated power (e.i.r.p.) is not more than that necessary for successful communication. This radio transmitter has been approved by Industry Canada to operate with the antenna types listed in the user guide with the maximum permissible gain and required antenna impedance for each antenna type indicated. Antenna types not included in this list, having a gain greater than the maximum gain indicated for that type, are strictly prohibited for use with this device.

Concernant les EVMs avec antennes détachables

Conformément à la réglementation d'Industrie Canada, le présent émetteur radio peut fonctionner avec une antenne d'un type et d'un gain maximal (ou inférieur) approuvé pour l'émetteur par Industrie Canada. Dans le but de réduire les risques de brouillage radioélectrique à l'intention des autres utilisateurs, il faut choisir le type d'antenne et son gain de sorte que la puissance isotrope rayonnée équivalente (p.i.r.e.) ne dépasse pas l'intensité nécessaire à l'établissement d'une communication satisfaisante. Le présent émetteur radio a été approuvé par Industrie Canada pour fonctionner avec les types d'antenne énumérés dans le manuel d'usage et ayant un gain admissible maximal et l'impédance requise pour chaque type d'antenne. Les types d'antenne non inclus dans cette liste, ou dont le gain est supérieur au gain maximal indiqué, sont strictement interdits pour l'exploitation de l'émetteur.

3.3 Japan

3.3.1 *Notice for EVMs delivered in Japan:* Please see http://www.tij.co.jp/lstds/ti_ja/general/eStore/notice_01.page 日本国内に輸入される評価用キット、ボードについては、次のところをご覧ください。

<https://www.ti.com/ja-jp/legal/notice-for-evaluation-kits-delivered-in-japan.html>

3.3.2 *Notice for Users of EVMs Considered "Radio Frequency Products" in Japan:* EVMs entering Japan may not be certified by TI as conforming to Technical Regulations of Radio Law of Japan.

If User uses EVMs in Japan, not certified to Technical Regulations of Radio Law of Japan, User is required to follow the instructions set forth by Radio Law of Japan, which includes, but is not limited to, the instructions below with respect to EVMs (which for the avoidance of doubt are stated strictly for convenience and should be verified by User):

1. Use EVMs in a shielded room or any other test facility as defined in the notification #173 issued by Ministry of Internal Affairs and Communications on March 28, 2006, based on Sub-section 1.1 of Article 6 of the Ministry's Rule for Enforcement of Radio Law of Japan,
2. Use EVMs only after User obtains the license of Test Radio Station as provided in Radio Law of Japan with respect to EVMs, or
3. Use of EVMs only after User obtains the Technical Regulations Conformity Certification as provided in Radio Law of Japan with respect to EVMs. Also, do not transfer EVMs, unless User gives the same notice above to the transferee. Please note that if User does not follow the instructions above, User will be subject to penalties of Radio Law of Japan.

【無線電波を送信する製品の開発キットをお使いになる際の注意事項】 開発キットの中には技術基準適合証明を受けていないものがあります。技術適合証明を受けていないものご使用に際しては、電波法遵守のため、以下のいずれかの措置を取っていただく必要がありますのでご注意ください。

1. 電波法施行規則第6条第1項第1号に基づく平成18年3月28日総務省告示第173号で定められた電波暗室等の試験設備でご使用いただく。
2. 実験局の免許を取得後ご使用いただく。
3. 技術基準適合証明を取得後ご使用いただく。

なお、本製品は、上記の「ご使用にあたっての注意」を譲渡先、移転先に通知しない限り、譲渡、移転できないものとします。

上記を遵守頂けない場合は、電波法の罰則が適用される可能性があることをご留意ください。日本テキサス・イ

ンスツルメンツ株式会社

東京都新宿区西新宿 6 丁目 2 4 番 1 号

西新宿三井ビル

3.3.3 *Notice for EVMs for Power Line Communication:* Please see http://www.tij.co.jp/lstds/ti_ja/general/eStore/notice_02.page

電力線搬送波通信についての開発キットをお使いになる際の注意事項については、次のところをご覧ください。 <https://www.ti.com/ja-jp/legal/notice-for-evaluation-kits-for-power-line-communication.html>

3.4 European Union

3.4.1 *For EVMs subject to EU Directive 2014/30/EU (Electromagnetic Compatibility Directive):*

This is a class A product intended for use in environments other than domestic environments that are connected to a low-voltage power-supply network that supplies buildings used for domestic purposes. In a domestic environment this product may cause radio interference in which case the user may be required to take adequate measures.

-
- 4 *EVM Use Restrictions and Warnings:*
 - 4.1 EVMS ARE NOT FOR USE IN FUNCTIONAL SAFETY AND/OR SAFETY CRITICAL EVALUATIONS, INCLUDING BUT NOT LIMITED TO EVALUATIONS OF LIFE SUPPORT APPLICATIONS.
 - 4.2 User must read and apply the user guide and other available documentation provided by TI regarding the EVM prior to handling or using the EVM, including without limitation any warning or restriction notices. The notices contain important safety information related to, for example, temperatures and voltages.
 - 4.3 *Safety-Related Warnings and Restrictions:*
 - 4.3.1 User shall operate the EVM within TI's recommended specifications and environmental considerations stated in the user guide, other available documentation provided by TI, and any other applicable requirements and employ reasonable and customary safeguards. Exceeding the specified performance ratings and specifications (including but not limited to input and output voltage, current, power, and environmental ranges) for the EVM may cause personal injury or death, or property damage. If there are questions concerning performance ratings and specifications, User should contact a TI field representative prior to connecting interface electronics including input power and intended loads. Any loads applied outside of the specified output range may also result in unintended and/or inaccurate operation and/or possible permanent damage to the EVM and/or interface electronics. Please consult the EVM user guide prior to connecting any load to the EVM output. If there is uncertainty as to the load specification, please contact a TI field representative. During normal operation, even with the inputs and outputs kept within the specified allowable ranges, some circuit components may have elevated case temperatures. These components include but are not limited to linear regulators, switching transistors, pass transistors, current sense resistors, and heat sinks, which can be identified using the information in the associated documentation. When working with the EVM, please be aware that the EVM may become very warm.
 - 4.3.2 EVMs are intended solely for use by technically qualified, professional electronics experts who are familiar with the dangers and application risks associated with handling electrical mechanical components, systems, and subsystems. User assumes all responsibility and liability for proper and safe handling and use of the EVM by User or its employees, affiliates, contractors or designees. User assumes all responsibility and liability to ensure that any interfaces (electronic and/or mechanical) between the EVM and any human body are designed with suitable isolation and means to safely limit accessible leakage currents to minimize the risk of electrical shock hazard. User assumes all responsibility and liability for any improper or unsafe handling or use of the EVM by User or its employees, affiliates, contractors or designees.
 - 4.4 User assumes all responsibility and liability to determine whether the EVM is subject to any applicable international, federal, state, or local laws and regulations related to User's handling and use of the EVM and, if applicable, User assumes all responsibility and liability for compliance in all respects with such laws and regulations. User assumes all responsibility and liability for proper disposal and recycling of the EVM consistent with all applicable international, federal, state, and local requirements.
 5. *Accuracy of Information:* To the extent TI provides information on the availability and function of EVMs, TI attempts to be as accurate as possible. However, TI does not warrant the accuracy of EVM descriptions, EVM availability or other information on its websites as accurate, complete, reliable, current, or error-free.
 6. *Disclaimers:*
 - 6.1 EXCEPT AS SET FORTH ABOVE, EVMS AND ANY MATERIALS PROVIDED WITH THE EVM (INCLUDING, BUT NOT LIMITED TO, REFERENCE DESIGNS AND THE DESIGN OF THE EVM ITSELF) ARE PROVIDED "AS IS" AND "WITH ALL FAULTS." TI DISCLAIMS ALL OTHER WARRANTIES, EXPRESS OR IMPLIED, REGARDING SUCH ITEMS, INCLUDING BUT NOT LIMITED TO ANY EPIDEMIC FAILURE WARRANTY OR IMPLIED WARRANTIES OF MERCHANTABILITY OR FITNESS FOR A PARTICULAR PURPOSE OR NON-INFRINGEMENT OF ANY THIRD PARTY PATENTS, COPYRIGHTS, TRADE SECRETS OR OTHER INTELLECTUAL PROPERTY RIGHTS.
 - 6.2 EXCEPT FOR THE LIMITED RIGHT TO USE THE EVM SET FORTH HEREIN, NOTHING IN THESE TERMS SHALL BE CONSTRUED AS GRANTING OR CONFERRING ANY RIGHTS BY LICENSE, PATENT, OR ANY OTHER INDUSTRIAL OR INTELLECTUAL PROPERTY RIGHT OF TI, ITS SUPPLIERS/LICENSORS OR ANY OTHER THIRD PARTY, TO USE THE EVM IN ANY FINISHED END-USER OR READY-TO-USE FINAL PRODUCT, OR FOR ANY INVENTION, DISCOVERY OR IMPROVEMENT, REGARDLESS OF WHEN MADE, CONCEIVED OR ACQUIRED.
 7. *USER'S INDEMNITY OBLIGATIONS AND REPRESENTATIONS.* USER WILL DEFEND, INDEMNIFY AND HOLD TI, ITS LICENSORS AND THEIR REPRESENTATIVES HARMLESS FROM AND AGAINST ANY AND ALL CLAIMS, DAMAGES, LOSSES, EXPENSES, COSTS AND LIABILITIES (COLLECTIVELY, "CLAIMS") ARISING OUT OF OR IN CONNECTION WITH ANY HANDLING OR USE OF THE EVM THAT IS NOT IN ACCORDANCE WITH THESE TERMS. THIS OBLIGATION SHALL APPLY WHETHER CLAIMS ARISE UNDER STATUTE, REGULATION, OR THE LAW OF TORT, CONTRACT OR ANY OTHER LEGAL THEORY, AND EVEN IF THE EVM FAILS TO PERFORM AS DESCRIBED OR EXPECTED.

8. *Limitations on Damages and Liability:*

8.1 *General Limitations.* IN NO EVENT SHALL TI BE LIABLE FOR ANY SPECIAL, COLLATERAL, INDIRECT, PUNITIVE, INCIDENTAL, CONSEQUENTIAL, OR EXEMPLARY DAMAGES IN CONNECTION WITH OR ARISING OUT OF THESE TERMS OR THE USE OF THE EVMS , REGARDLESS OF WHETHER TI HAS BEEN ADVISED OF THE POSSIBILITY OF SUCH DAMAGES. EXCLUDED DAMAGES INCLUDE, BUT ARE NOT LIMITED TO, COST OF REMOVAL OR REINSTALLATION, ANCILLARY COSTS TO THE PROCUREMENT OF SUBSTITUTE GOODS OR SERVICES, RETESTING, OUTSIDE COMPUTER TIME, LABOR COSTS, LOSS OF GOODWILL, LOSS OF PROFITS, LOSS OF SAVINGS, LOSS OF USE, LOSS OF DATA, OR BUSINESS INTERRUPTION. NO CLAIM, SUIT OR ACTION SHALL BE BROUGHT AGAINST TI MORE THAN TWELVE (12) MONTHS AFTER THE EVENT THAT GAVE RISE TO THE CAUSE OF ACTION HAS OCCURRED.

8.2 *Specific Limitations.* IN NO EVENT SHALL TI'S AGGREGATE LIABILITY FROM ANY USE OF AN EVM PROVIDED HEREUNDER, INCLUDING FROM ANY WARRANTY, INDEMNITY OR OTHER OBLIGATION ARISING OUT OF OR IN CONNECTION WITH THESE TERMS, , EXCEED THE TOTAL AMOUNT PAID TO TI BY USER FOR THE PARTICULAR EVM(S) AT ISSUE DURING THE PRIOR TWELVE (12) MONTHS WITH RESPECT TO WHICH LOSSES OR DAMAGES ARE CLAIMED. THE EXISTENCE OF MORE THAN ONE CLAIM SHALL NOT ENLARGE OR EXTEND THIS LIMIT.

9. *Return Policy.* Except as otherwise provided, TI does not offer any refunds, returns, or exchanges. Furthermore, no return of EVM(s) will be accepted if the package has been opened and no return of the EVM(s) will be accepted if they are damaged or otherwise not in a resalable condition. If User feels it has been incorrectly charged for the EVM(s) it ordered or that delivery violates the applicable order, User should contact TI. All refunds will be made in full within thirty (30) working days from the return of the components(s), excluding any postage or packaging costs.

10. *Governing Law:* These terms and conditions shall be governed by and interpreted in accordance with the laws of the State of Texas, without reference to conflict-of-laws principles. User agrees that non-exclusive jurisdiction for any dispute arising out of or relating to these terms and conditions lies within courts located in the State of Texas and consents to venue in Dallas County, Texas. Notwithstanding the foregoing, any judgment may be enforced in any United States or foreign court, and TI may seek injunctive relief in any United States or foreign court.

Mailing Address: Texas Instruments, Post Office Box 655303, Dallas, Texas 75265
Copyright © 2023, Texas Instruments Incorporated

IMPORTANT NOTICE AND DISCLAIMER

TI PROVIDES TECHNICAL AND RELIABILITY DATA (INCLUDING DATA SHEETS), DESIGN RESOURCES (INCLUDING REFERENCE DESIGNS), APPLICATION OR OTHER DESIGN ADVICE, WEB TOOLS, SAFETY INFORMATION, AND OTHER RESOURCES "AS IS" AND WITH ALL FAULTS, AND DISCLAIMS ALL WARRANTIES, EXPRESS AND IMPLIED, INCLUDING WITHOUT LIMITATION ANY IMPLIED WARRANTIES OF MERCHANTABILITY, FITNESS FOR A PARTICULAR PURPOSE OR NON-INFRINGEMENT OF THIRD PARTY INTELLECTUAL PROPERTY RIGHTS.

These resources are intended for skilled developers designing with TI products. You are solely responsible for (1) selecting the appropriate TI products for your application, (2) designing, validating and testing your application, and (3) ensuring your application meets applicable standards, and any other safety, security, regulatory or other requirements.

These resources are subject to change without notice. TI grants you permission to use these resources only for development of an application that uses the TI products described in the resource. Other reproduction and display of these resources is prohibited. No license is granted to any other TI intellectual property right or to any third party intellectual property right. TI disclaims responsibility for, and you will fully indemnify TI and its representatives against, any claims, damages, costs, losses, and liabilities arising out of your use of these resources.

TI's products are provided subject to [TI's Terms of Sale](#) or other applicable terms available either on [ti.com](https://www.ti.com) or provided in conjunction with such TI products. TI's provision of these resources does not expand or otherwise alter TI's applicable warranties or warranty disclaimers for TI products.

TI objects to and rejects any additional or different terms you may have proposed.

Mailing Address: Texas Instruments, Post Office Box 655303, Dallas, Texas 75265
Copyright © 2024, Texas Instruments Incorporated