



ABSTRACT

This user's guide describes the TPS25865-Q1 evaluation module (TPS25865Q1EVM-141). This document contains the EVM schematics, EVM configuration, bill of materials (BOM), board layout drawing, and assembly drawing.

Table of Contents

1 Introduction	2
1.1 Features.....	2
1.2 Applications.....	2
2 Schematic	3
3 General Configuration and Description	4
3.1 Physical Access.....	4
3.2 Adjusting the Switching Frequency.....	4
3.3 Current Limit Value.....	4
3.4 Cable Compensation Value.....	4
3.5 Thermal Management.....	4
3.6 Test Setup.....	5
4 Board Layout	6
5 Bill of Materials	10

List of Figures

Figure 2-1. TPS25865Q1EVM-141 Schematic.....	3
Figure 3-1. EVM Setup for Charging USB Type-A Device.....	5
Figure 4-1. Top Side Assembly.....	6
Figure 4-2. Bottom Side Assembly.....	6
Figure 4-3. Top Side 3D View.....	7
Figure 4-4. Bottom Side 3D View.....	7
Figure 4-5. Top Layer Layout.....	8
Figure 4-6. Mid-1 Layer Layout.....	8
Figure 4-7. Mid-2 Layer Layout.....	9
Figure 4-8. Bottom Layer Layout.....	9

List of Tables

Table 3-1. Connectors.....	4
Table 3-2. Jumper.....	4
Table 3-3. Test Points.....	4
Table 5-1. TPS25865Q1EVM-141 Bill of Materials.....	10

Trademarks

All trademarks are the property of their respective owners.

1 Introduction

The TPS25865Q1EVM-141 is an evaluation module (EVM) for TI's TPS25865-Q1 USB BC1.2 dual type-A ports which is capable of providing up to 5-A output current, 2.4 A for each port with cable compensation. The EVM operates over a range from 5.5 V to 26 V and withstands 40-V transient voltage. The value of cable compensation, current limit, output voltage, and switching frequency can be adjusted by resistors on the EVM.

1.1 Features

The following features are available on this EVM:

- 5.5-V to 26-V input range, 2.4A continuous output current buck converter for each port
- 200-mA capability for OUT pin
- Forced PWM operation with Spread-Spectrum Dithering at 200 kHz –800 kHz
- Fully AEC-Q100 qualified
- Output current limit @2.73A: $\pm 10\%$ accuracy overtemperature
- Smart thermal management
- USB battery charging specification Rev. 1.2 DCP mode, apple divider3 mode, Samsung 1.2V mode

1.2 Applications

The EVM is used in the following applications:

- Automotive: USB media hubs, USB charging ports, aftermarket Dual USB chargers

2 Schematic

Figure 2-1 illustrates the TPS25865Q1EVM-141 schematic.

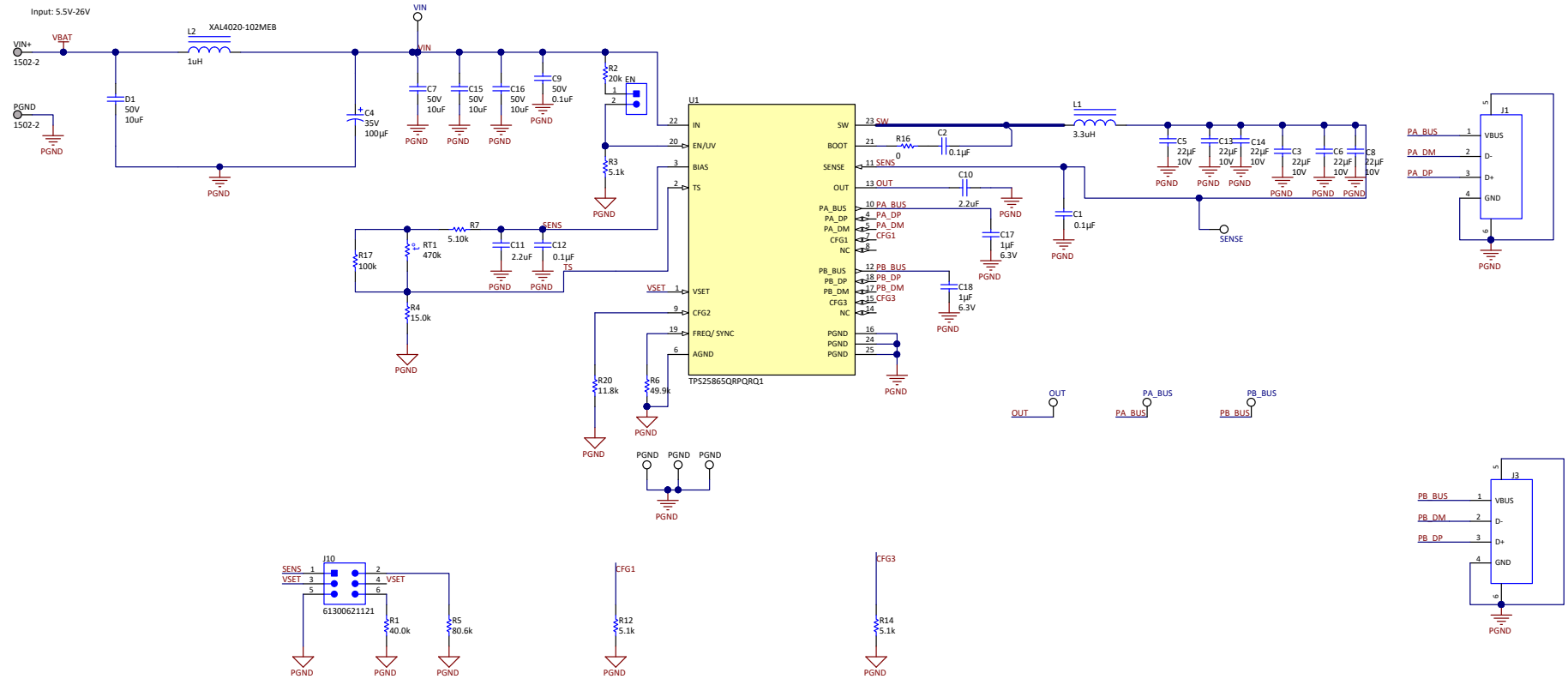

Figure 2-1. TPS25865Q1EVM-141 Schematic

3 General Configuration and Description

This section describes the connectors, jumpers, and test points on the EVM and how to properly connect, set up, and use the TPS25865Q1EVM-141.

3.1 Physical Access

[Table 3-1](#) lists the TPS25865Q1EVM-141 connector functionality, [Table 3-2](#) describes the jumper configuration, and [Table 3-3](#) describes the test point availability.

Table 3-1. Connectors

Connector	Component Type	Description
J1, J3	USB Type-A connector, receptacle	Downstream facing USB Type-A connector. USB output power is provided to the slave from the buck converter of the TPS25865-Q1 device.
VIN+, PGND	Terminal block	Power input connector for TPS25865-Q1. Connect to a 5.5-V to 26-V power supply.

Table 3-2. Jumper

Jumper	Label	Description
J10	Buck output voltage selection	3 × 2 header. Install shunt to pin 1 and pin 3 for 5.1 V, to pin 3 and pin 5 for 5.17 V, to pin 2 and pin 4 for 5.4 V, to pin 4 and pin 6 for 5.3 V.

Table 3-3. Test Points

Test Point	Label	Description
VIN	VIN	VIN pin test point
EN	EN	EN pin test point
OUT	OUT	OUT pin test point
SENSE	SENSE	SENSE pin test point
PA_BUS	PA_BUS	BUS pin of Port A test point
PB_BUS	PB_BUS	BUS pin of Port B test point
PGND	PGND	Power ground pin test point

3.2 Adjusting the Switching Frequency

If other frequencies are desired, within the frequency range of 200 kHz to 800 kHz, the RFREQ (R6) resistor value can be changed. Consult the data sheet for proper selection of the RFREQ resistor. Change the inductor (L1) and the total output capacitance for proper control loop operation.

The FREQ/SYNC pin can also be used to synchronize the internal oscillator to an external clock. The TPS25865EVMQ1-141 allows users to synchronize the internal oscillator to both Lo-Z clock source and Hi-Z clock source. Refer to the data sheet for detailed information.

3.3 Current Limit Value

CFG2 must connect a 11.8-k Ω resistor to AGND.

3.4 Cable Compensation Value

The TPS25865-Q1 needs to short the VSET pin to ground to enable the cable compensation. With that setting, the buck regulator will increase its output voltage linearly as the load current increases, and the voltage compensation at USB ports' currents greater than 2.4 A is 90 mV.

3.5 Thermal Management

The TS input pin allows for user programmable thermal protection, see Electrical Characteristics section of the data sheet for TS pin thresholds. The TS input pin threshold is ratio metric with VSENSE. The external resistor divider setting VTS (R4, R7, and R17) must be connected to the SENSE pin to achieve accurate results. See the data sheet for detailed information.

3.6 Test Setup

Figure 3-1 shows a typical test setup for charging the USB Type-A device. Connect VIN+ to the power supply. Connect the USB Type-A device to the J1 and J3 connector.

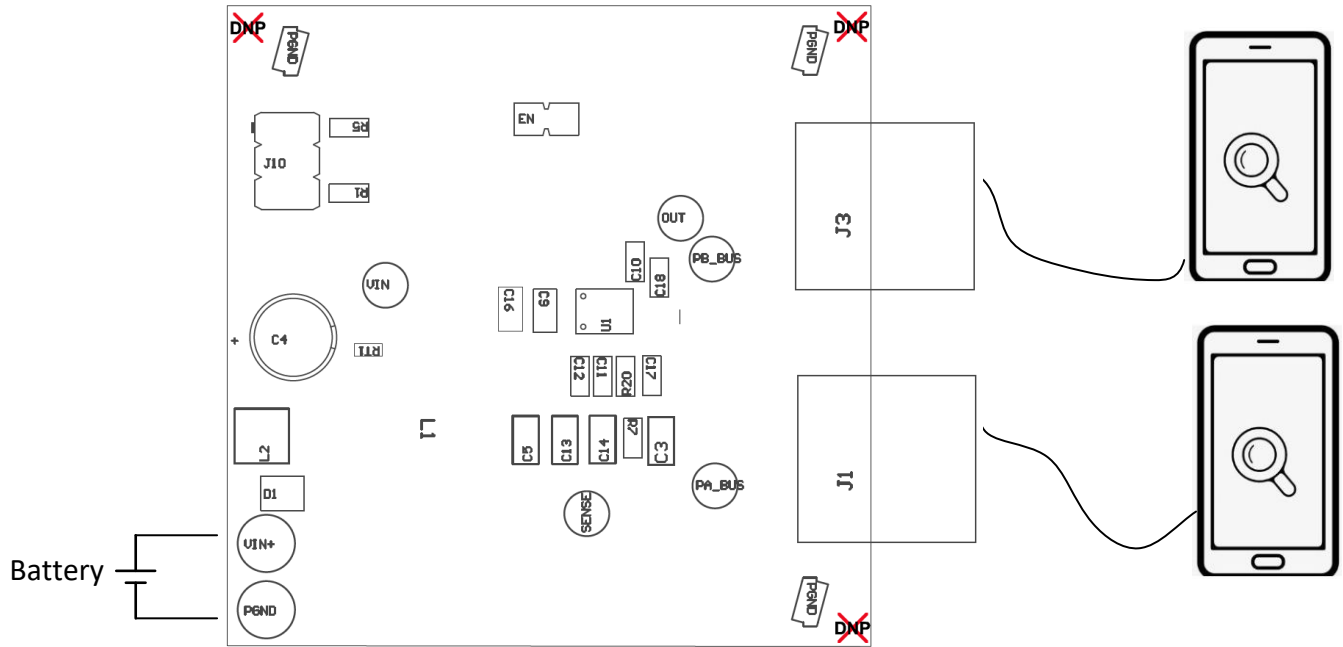

Figure 3-1. EVM Setup for Charging USB Type-A Device

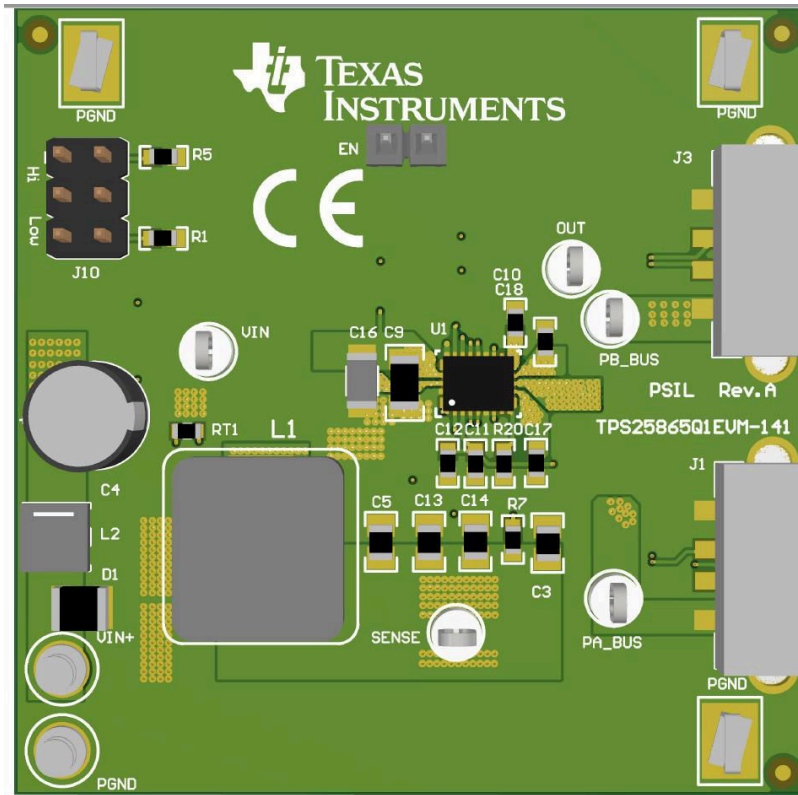

Figure 4-3. Top Side 3D View

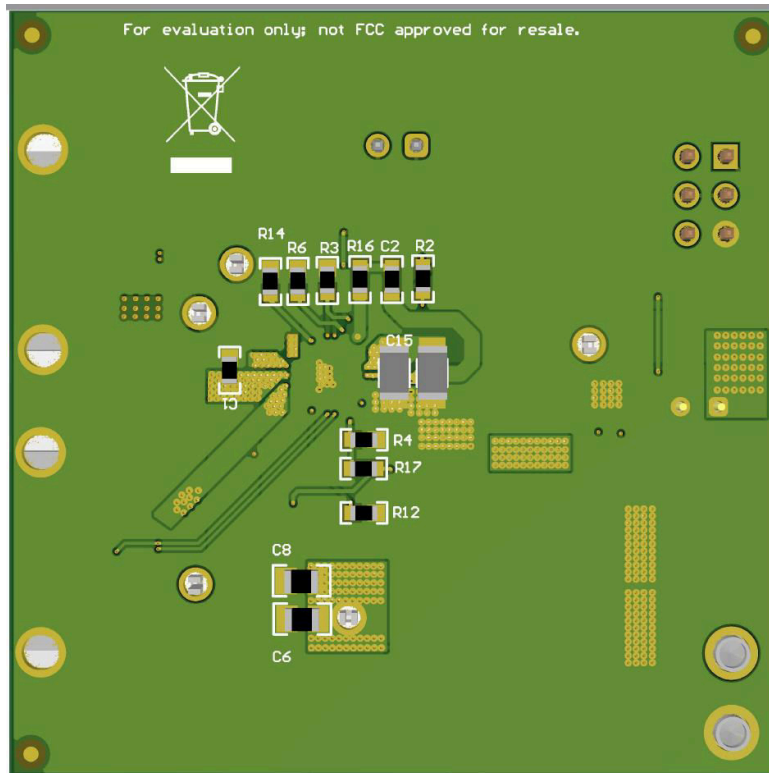

Figure 4-4. Bottom Side 3D View

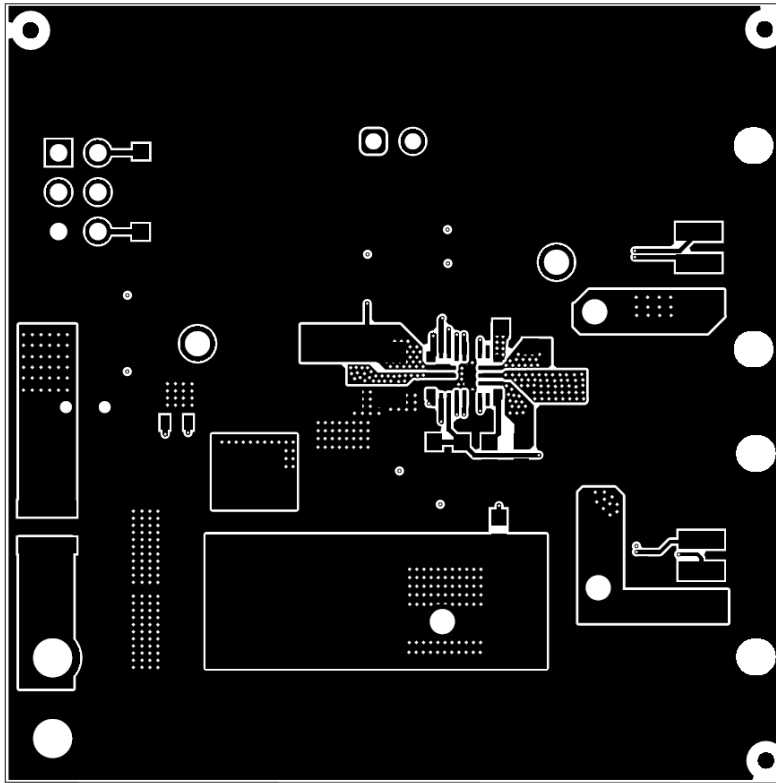

Figure 4-5. Top Layer Layout

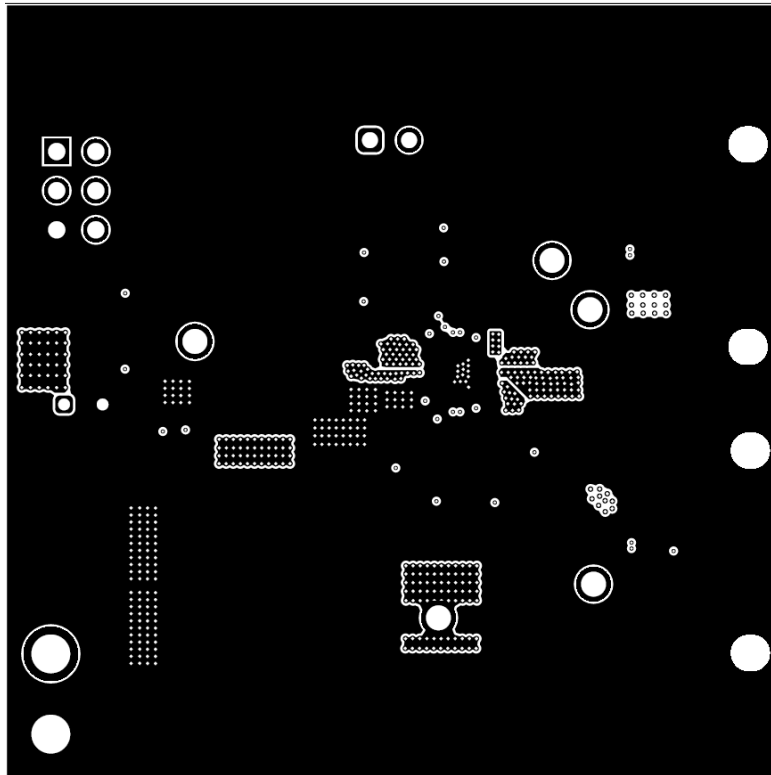

Figure 4-6. Mid-1 Layer Layout

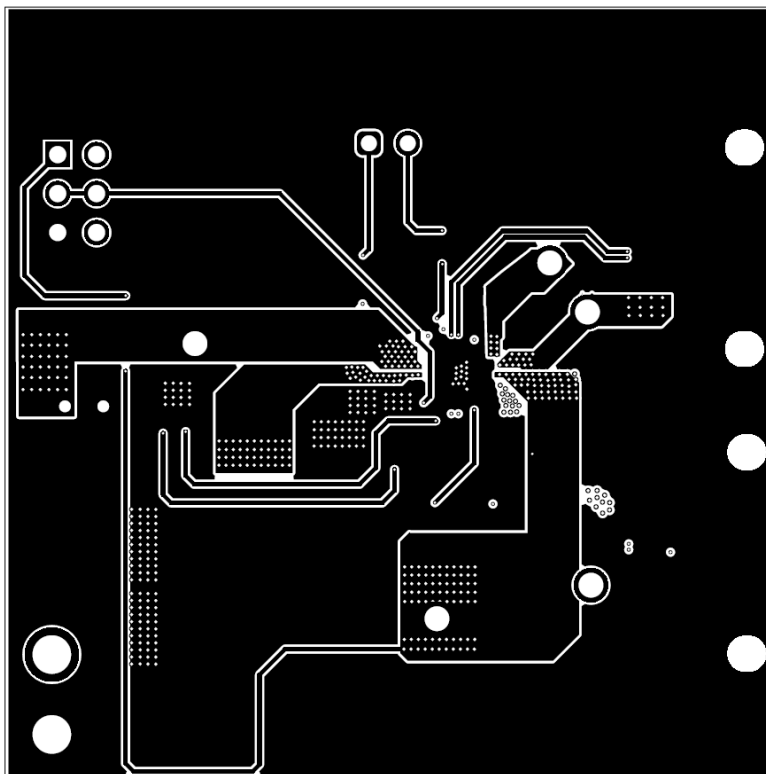

Figure 4-7. Mid-2 Layer Layout

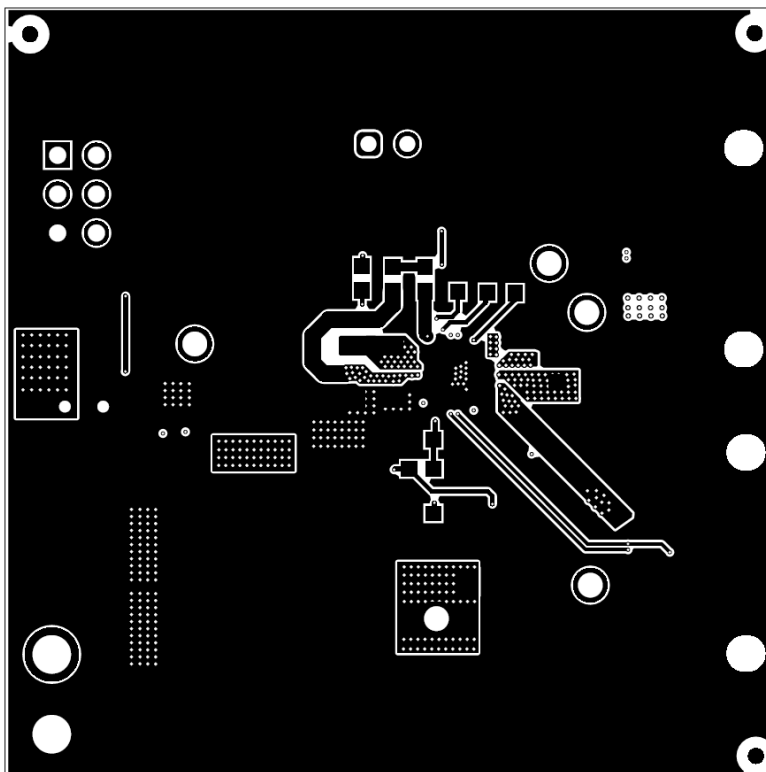

Figure 4-8. Bottom Layer Layout

5 Bill of Materials

Table 5-1 lists the EVM bill of materials

Table 5-1. TPS25865Q1EVM-141 Bill of Materials

Item #	Designator	QTY	Value	Part Number	Manufacturer	Description	Package Reference
1	C1, C2, C12	3	0.1uF	C0603C104K5RACAUTO	Kemet	CAP, CERM, 0.1 μ F, 50 V, \pm 10%, X7R, AEC-Q200 Grade 1, 0603	0603
2	C4	1	100uF	35ZLJ100M6.3X11	Rubycon	CAP, AL, 100 μ F, 35 V, \pm 20%, TH	D6.3xL11mm
3	C3, C5, C6, C8, C13, C14	6	22uF	GRM21BZ71A226ME15L	MuRata	CAP, CERM, 22 μ F, 10 V, \pm 20%, X7R, 0805	0805
4	C7, C15, C16	3	10uF	GRT31CR61H106KE01L	MuRata	CAP, CERM, 10 μ F, 50 V, \pm 10%, X5R, AEC-Q200 Grade 1, 1206	1206
5	C9	1	0.1uF	12065C104KAT2A	AVX	CAP, CERM, 0.1 μ F, 50 V, \pm 10%, X7R, 1206	1206
6	C10, C11	2	2.2uF	885012106018	Würth Elektronik	CAP, CERM, 2.2 μ F, 16 V, \pm 20%, X5R, 0603	0603
7	C17, C18	2	1uF	CL10B105KQ8NNNC	Samsung Electro-Mechanics	CAP, CERM, 1 μ F, 6.3 V, \pm 10%, X7R, 0603	0603
8	D1	1	10uF	GRM32ER71H106MA12	MuRata	CAP, CERM, 10 μ F, 50 V, \pm 20%, X7R, 1210	1210
9	EN	1		TSW-102-07-T-S	Samtec	Header, 2.54 mm, 2x1, Tin, TH	Header, 2.54 mm, 2x1, TH
10	J1, J3	2		896-43-004-00-000000		Connector, Receptacle, USB TYPE A, R/A, Top Mount SMT	Connector, Receptacle, USB TYPE A, R/A, Top Mount SMT
11	J10	1		61300621121	Würth Elektronik	Header, 2.54mm, 3x2, Gold, TH	Header, 2.54mm, 3x2, TH
12	L1	1		744323068	Würth Elektronik	3.3uH	Inductor, Shielded Drum Core, Superflux, 3.3 uH, 12 A, 0.0059 ohm, SMD
13	L2	1	1uH	XAL4020-102MEB	Coilcraft	Inductor, Shielded, Composite, 1 uH, 8.75 A, 0.01 ohm, SMD	4x2.1x4mm
14	OUT_PA_BUS, PB_BUS, SENSE, VIN	5		5012	Keystone	Test Point, Multipurpose, White, TH	White Multipurpose Testpoint
16	PGND	3		5016	Keystone	Test Point, Compact, SMT	Testpoint_Keystone_Compact
17	PGND, VIN+	2		1502-2	Keystone	Terminal, Turret, TH, Double	Keystone1502-2
18	R1	1	40.0k	PAT0603E4002BST1	Vishay Thin Film	RES, 40.0 k, 0.1%, 0.15 W, AEC-Q200 Grade 0, 0603	0603
19	R2	1	20k	CRCW060320K0JNEA	Vishay-Dale	RES, 20 k, 5%, 0.1 W, AEC-Q200 Grade 0, 0603	0603
20	R3, R12, R13, R14, R15	5	5.1k	CRCW06035K10JNEA	Vishay-Dale	RES, 5.1 k, 5%, 0.1 W, AEC-Q200 Grade 0, 0603	0603
21	R4	1	15.0k	RT0603DRE0715KL	Yageo America	RES, 15.0 k, 0.5%, 0.1 W, 0603	0603
22	R5	1	80.6k	RT0603DRE0780K6L	Yageo America	RES, 80.6 k, 0.5%, 0.1 W, 0603	0603
23	R6	1	49.9k	ERJ-3EKF4992V		RES, 49.9 k, 1%, 0.1 W, AEC-Q200 Grade 0, 0603	0603
24	R7	1	5.10k	RC0603FR-075K1L	Yageo America	RES, 5.10 k, 1%, 0.1 W, 0603	0603
25	R8, R9, R10, R11	4	1.0k	CRCW06031K00JNEA	Vishay-Dale	RES, 1.0 k, 5%, 0.1 W, AEC-Q200 Grade 0, 0603	0603
26	R16	1	0	RMCF0603ZT0R00	Stackpole Electronics Inc	RES, 0, 1%, 0.1 W, AEC-Q200 Grade 0, 0603	0603

Table 5-1. TPS25865Q1EVM-141 Bill of Materials (continued)

Item #	Designator	QTY	Value	Part Number	Manufacturer	Description	Package Reference
27	R20	1	11.8k	CRCW060311K8FKEA		RES, 11.8 k, 1%, 0.1 W, AEC-Q200 Grade 0, 0603	0603
27	R17	1	100k	CRCW0603100KFKEA	Vishay-Dale	RES, 100 k, 1%, 0.1 W, 0603	0603
28	RT1	1	470k	NCP18WM474E03RB	MuRata	Thermistor NTC, 470k ohm, 3%, 0603	0603
29	U1	1		TPS25850QRPQRQ1	Texas Instruments	Dual 3A USB Type-C Charging Ports Controller with Programmable Current Limit and Thermal Management, RPQ0025A (VQFN-25)	RPQ0025A
30	FID1, FID2, FID3, FID4, FID5, FID6	0		N/A	N/A	Fiducial mark. There is nothing to buy or mount.	N/A

IMPORTANT NOTICE AND DISCLAIMER

TI PROVIDES TECHNICAL AND RELIABILITY DATA (INCLUDING DATA SHEETS), DESIGN RESOURCES (INCLUDING REFERENCE DESIGNS), APPLICATION OR OTHER DESIGN ADVICE, WEB TOOLS, SAFETY INFORMATION, AND OTHER RESOURCES "AS IS" AND WITH ALL FAULTS, AND DISCLAIMS ALL WARRANTIES, EXPRESS AND IMPLIED, INCLUDING WITHOUT LIMITATION ANY IMPLIED WARRANTIES OF MERCHANTABILITY, FITNESS FOR A PARTICULAR PURPOSE OR NON-INFRINGEMENT OF THIRD PARTY INTELLECTUAL PROPERTY RIGHTS.

These resources are intended for skilled developers designing with TI products. You are solely responsible for (1) selecting the appropriate TI products for your application, (2) designing, validating and testing your application, and (3) ensuring your application meets applicable standards, and any other safety, security, regulatory or other requirements.

These resources are subject to change without notice. TI grants you permission to use these resources only for development of an application that uses the TI products described in the resource. Other reproduction and display of these resources is prohibited. No license is granted to any other TI intellectual property right or to any third party intellectual property right. TI disclaims responsibility for, and you will fully indemnify TI and its representatives against, any claims, damages, costs, losses, and liabilities arising out of your use of these resources.

TI's products are provided subject to [TI's Terms of Sale](#) or other applicable terms available either on ti.com or provided in conjunction with such TI products. TI's provision of these resources does not expand or otherwise alter TI's applicable warranties or warranty disclaimers for TI products.

TI objects to and rejects any additional or different terms you may have proposed.

Mailing Address: Texas Instruments, Post Office Box 655303, Dallas, Texas 75265
Copyright © 2022, Texas Instruments Incorporated