

**ABSTRACT**

The Texas Instruments DS90UB954-Q1EVM evaluation modules (EVM) are functional board designs for evaluating the DS90UB954-Q1 FPD-Link III deserializer, the DS90UB638-Q1 low-cost deserializer, and the TDES954 V³Link deserializer, which convert serialized camera data to MIPI CSI-2 for processing. The MIPI CSI-2 output has four available DPHY data lanes, which can be configured for either four-lane output or replicated two-lane output. When paired with a compatible serializer, the deserializer can receive data from imager(s) supporting cameras as well as satellite RADAR. The DS90UB954-Q1 also supports DS90UB913A/933 serializers.

Some variants are single channel. For these variants, ignore references to RX1. Some references are made to serializer backward compatibility. Refer to the product datasheet for serializer compatibility.

The **DS90UB954-Q1EVM** is configured for communication with the DS90UB953-Q1, DS90UB635-Q1, and TSER953 on channel 0 (RX0), and DS90UB933-Q1 on channel 1 (RX1). The EVM has two Rosenberger FAKRA connectors and configurable Power-over-Coax (PoC) voltage for connecting the camera modules (not included). FPD-Link III and V³Link interfaces also include a separate low latency bidirectional control channel that conveys control information from an I²C port. General purpose I/O signals, such as those required for camera synchronization and functional safety features, also make use of this bidirectional control channel to program registers in the DS90UB954-Q1, DS90UB638-Q1 and TDES954, as well as the connected serializer and any remote I2C connected devices. There is an onboard MSP430 which functions as a USB2ANY bridge for interfacing with a PC for evaluation. The USB2ANY interfaces with the [Analog LaunchPAD](#) GUI tool.

Table of Contents

1 Trademarks	4
2 Introduction	4
3 Quick Start Guide	5
3.1 System Requirements.....	5
3.1.1 Included Components.....	5
3.1.2 Additional Required Components.....	5
3.2 Applications Diagram.....	5
3.3 Major Components of DS90UB954-Q1EVM.....	6
3.4 DS90UB954-Q1EVM Setup.....	7
4 DS90UB954-Q1EVM Board Configuration	7
4.1 Default Configuration.....	7
4.2 Power Supply.....	8
4.3 Power-over-Coax Interface.....	8
4.4 MIPI CSI-2 Output Signals.....	9
4.5 FPD-Link III Signals.....	11
4.6 I ² C Interface.....	11
4.7 Control Interface.....	12
5 Enable and Reset	13
6 Use with DS90UB936-Q1	13
7 Typical Connection and Test Equipment	14
8 Termination Device	14
9 Typical Test Setup	14
10 Equipment References	15
11 Cable References	15
12 Software for DS90UB954Q1-EVM Evaluation - Analog LaunchPAD (ALP) Software Setup	16
12.1 System Requirements.....	16

12.2 Download Contents.....	16
12.3 Installation of the ALP Software.....	16
12.4 Startup - First Launch.....	17
13 Using ALP and DS90UB954 Profile.....	21
13.1 Information Tab.....	21
13.2 Registers Tab.....	22
13.3 Registers Tab - Address 0x00 Expanded.....	23
13.3.1 Port Specific Registers.....	23
13.4 Saving and Loading Register Settings.....	23
13.5 Scripting Tab.....	27
13.5.1 Example Functions.....	29
13.6 GPIO Tab.....	31
13.7 Forwarding Tab.....	32
13.8 CSI Registers Tab.....	33
13.9 Remote Registers Tab.....	34
14 Troubleshooting ALP Software.....	35
14.1 ALP Does Not Detect The EVM.....	35
14.2 USB2ANY Firmware Issues.....	36
15 DS90UB954-Q1EVM PCB Schematics, Layout and Bill of Materials - DS90UB954-Q1EVM Schematic.....	38
16 DS90UB954-Q1 EVM PCB Layout.....	46
17 DS90UB954-Q1EVM Bill of Materials.....	56
18 Revision History.....	61

List of Figures

Figure 2-1. DS90UB954-Q1EVM.....	4
Figure 3-1. Applications Diagram.....	5
Figure 3-2. Interfacing to the EVM.....	6
Figure 4-1. DS90UB954-Q1EVM with Jumpers Highlighted.....	7
Figure 4-2. Power-over-Coax Network For Use With DS90UB953.....	8
Figure 4-3. Power-over-Coax Network For Use With DS90UB933.....	9
Figure 9-1. Typical Test Setup for Evaluation.....	14
Figure 12-1. Launching ALP Splash Screen.....	17
Figure 12-2. Initial ALP Screen.....	17
Figure 12-3. Select USB2ANY/Aardvark Setup to Change Profile.....	18
Figure 12-4. ALP Profiles Dialog.....	19
Figure 12-5. ALP Profiles Dialog (continued).....	20
Figure 13-1. ALP Information Tab.....	21
Figure 13-2. ALP Registers Tab.....	22
Figure 13-3. ALP Device ID Expanded.....	23
Figure 13-4. Save Register Settings Step 1.....	24
Figure 13-5. Save Register Settings Step 2.....	24
Figure 13-6. Save Register Settings Step 3.....	25
Figure 13-7. Load Register Settings Step 1.....	25
Figure 13-8. Load Register Settings Step 2.....	26
Figure 13-9. Load Register Settings Step 3.....	26
Figure 13-10. ALP Scripting Tab.....	27
Figure 13-11. Pre-Defined Scripts.....	28
Figure 13-12. Custom Button Creation Step 1.....	28
Figure 13-13. Custom Button Creation Step 2.....	29
Figure 13-14. GPIO Tab.....	31
Figure 13-15. Forwarding Tab.....	32
Figure 13-16. CSI Registers Tab.....	33
Figure 13-17. Remote Registers Tab.....	34
Figure 14-1. ALP No Devices Error.....	35
Figure 14-2. Windows 7, ALP USB2ANY Driver.....	35
Figure 14-3. ALP in Demo Mode.....	36
Figure 14-4. ALP Preferences Menu.....	36
Figure 14-5. USB2ANY Firmware Update Notice.....	37
Figure 14-6. USB2ANY Firmware Update Procedure.....	37
Figure 15-1. DS90UB954-Q1EVM Block Diagram.....	38
Figure 15-2. DS90UB954-Q1EVM Main Circuit - Page 1.....	39
Figure 15-3. DS90UB954-Q1EVM CSI-2 Connectors - Page 2.....	40
Figure 15-4. DS90UB954-Q1EVM PoC Circuits - Page 3.....	41

Figure 15-5. DS90UB954-Q1EVM Power Distribution Circuits - Page 4.....	42
Figure 15-6. DS90UB954-Q1EVM LED Circuits - Page 5.....	43
Figure 15-7. DS90UB954-Q1EVM USB2ANY Circuits - Page 6.....	44
Figure 15-8. DS90UB954-Q1EVM Miscellaneous Hardware.....	45
Figure 16-1. Top View Composite.....	46
Figure 16-2. Layer 1: Top Signal Layer.....	47
Figure 16-3. Layer 2: GND Plane 1.....	48
Figure 16-4. Layer 3: Mid Signal Layer 1.....	49
Figure 16-5. Layer 4: GND Plane 2.....	50
Figure 16-6. Layer 5: GND Plane 3.....	51
Figure 16-7. Layer 6: Mid Signal Layer 2.....	52
Figure 16-8. Layer 7: GND Plane 4.....	53
Figure 16-9. Layer 8: Bottom Signal Layer.....	54
Figure 16-10. Bottom View Composite.....	55

List of Tables

Table 4-1. Power Supply.....	8
Table 4-2. Power-over-Coax Power Supply Feed Configuration.....	9
Table 4-3. MIPI CSI-2 Output Signals - J5 and J6 Pinout.....	10
Table 4-4. FPD-Link III Signals.....	11
Table 4-5. IDx I ² C Device Address Select - J23.....	11
Table 4-6. I ² C Interface Header - J25.....	11
Table 4-7. VDDIO Interface Header - J16.....	12
Table 4-8. GPIO Interface Header - J22.....	12
Table 4-9. CMLOUT Output Signals.....	12
Table 4-10. FPD-Link III Mode Control- J15.....	12
Table 4-11. Device Mode Control - J11.....	12
Table 4-12. LEDs.....	13
Table 17-1. DS90UB954-Q1EVM BOM.....	56

1 Trademarks

All trademarks are the property of their respective owners.

2 Introduction

Note

The demo board is not optimized for EMI testing. The demo board was designed for easy accessibility to device pins with tap points for monitoring or applying signals, additional pads for termination, and multiple connector options.

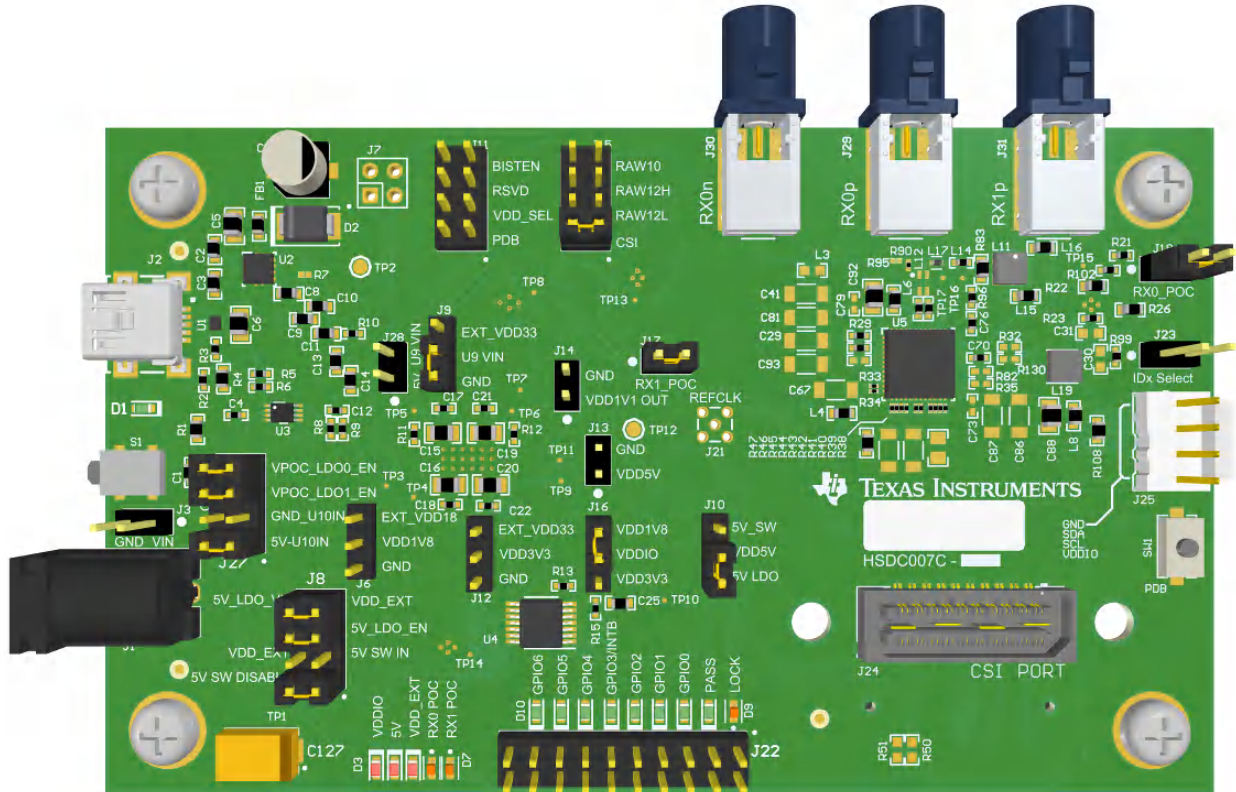

Figure 2-1. DS90UB954-Q1EVM

3 Quick Start Guide

3.1 System Requirements

3.1.1 Included Components

The major components of the DS90UB954-Q1EVM are:

- DS90UB954-Q1
- On-board Power-over-Coax (PoC) interface
- FAKRA coax connector(s) for digital video, power, control and diagnostics
- Samtec QSH type connector for CSI-2 interface
- On-board I²C programming interface

3.1.2 Additional Required Components

To demonstrate the functionality of the DS90UB954-Q1, the following components are required (not included):

- One compatible serializer.
- One DACAR/FAKRA coax cable
- USB to mini USB cable OR I²C host controller that supports clock stretching (such as USB2ANY)
- Power supply for 12V @ 1A (current limited bench supply recommended)
- Optional: MIPI CSI-2 output analyzer or host processor

3.2 Applications Diagram

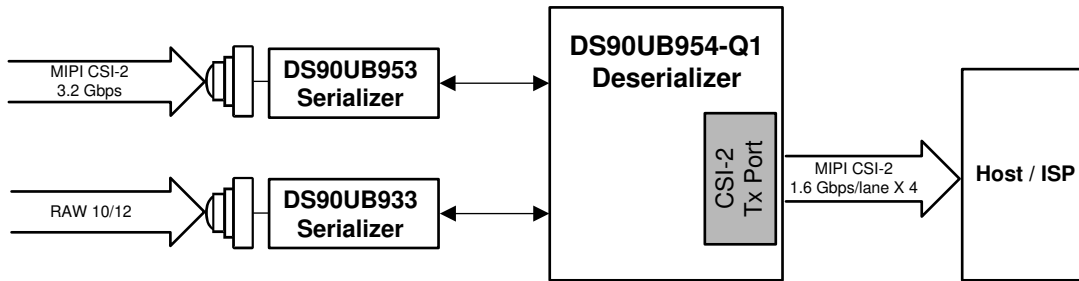

Figure 3-1. Applications Diagram

3.3 Major Components of DS90UB954-Q1EVM

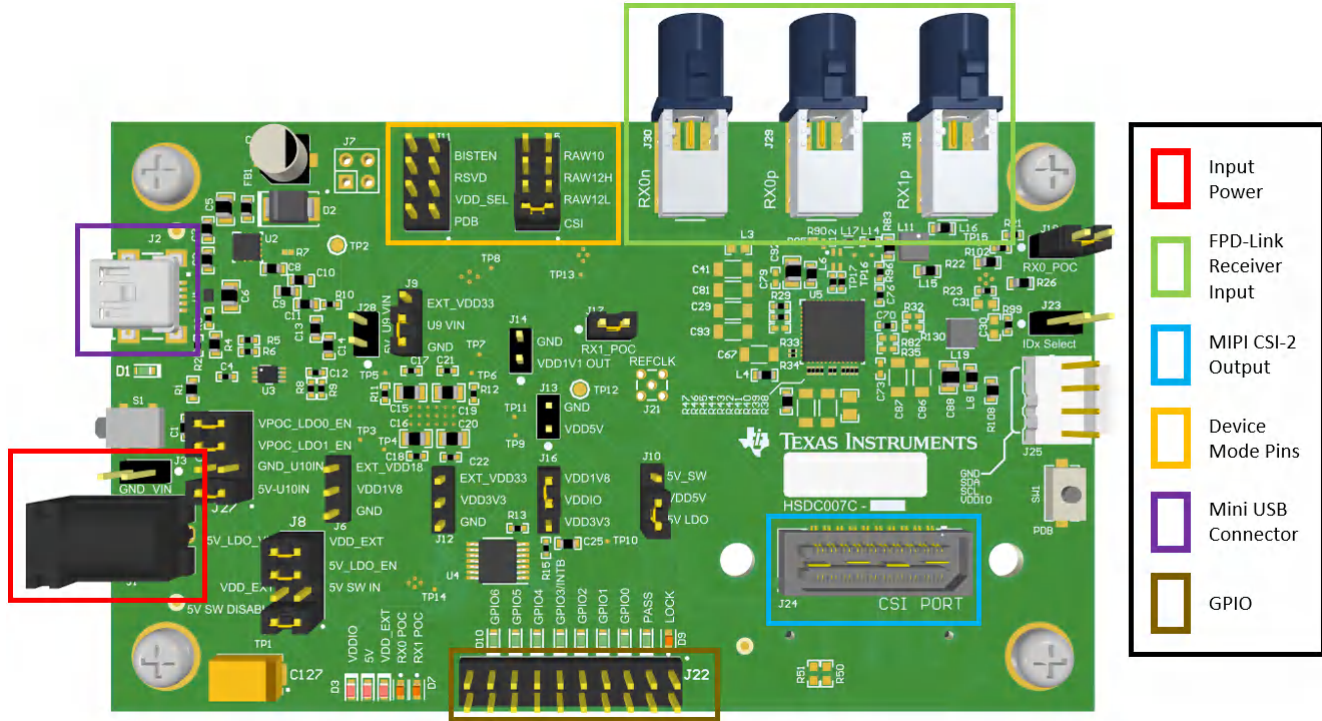

Figure 3-2. Interfacing to the EVM

3.4 DS90UB954-Q1EVM Setup

1. Use the mini USB to USB cable to connect J2 to computer USB port for register programming and open Analog LaunchPAD. See [Section 12](#) for details on installing and using Analog LaunchPAD.
2. Configure jumpers J8, J10, J11, J15, J16, J23, J27 to set device's operating modes. The default configuration can be seen in [Figure 4-1](#).
3. Configure Power-over-Coax power supplies for RX0 and RX1 with J18 and J17 respectively.
4. Connect the DS90UB954-Q1EVM to DS90UB953-Q1EVM (or variant) to RX0 and/or DS90UB933-Q1EVM to RX1 using a coax cable.
5. Interface MIPI CSI-2 output signals (J24) to test equipment or host processor (optional, not required to check status of FPD-Link III connection between serializer and deserializer).
6. Provide power to board. TI recommends using current limited bench supply to provide power to J1 (barrel jack) or J3.

4 DS90UB954-Q1EVM Board Configuration

4.1 Default Configuration

Default jumper placement is shown in red below. The [Hardware](#) schematic page also illustrates the default jumper positions. This configuration sets the device into the following mode:

- Device is set for FPD-Link III inputs from coax in CSI mode (for DS90UB953-Q1EVM (or variant))
- VDDIO is set to 1.8V
- VDD5V is powered by the 5V LDO
- The 3.3V + 1.1V LDO (U10) is powered by VDD5V
- The 9V LDO for PoC for RX0 and RX1 are enabled

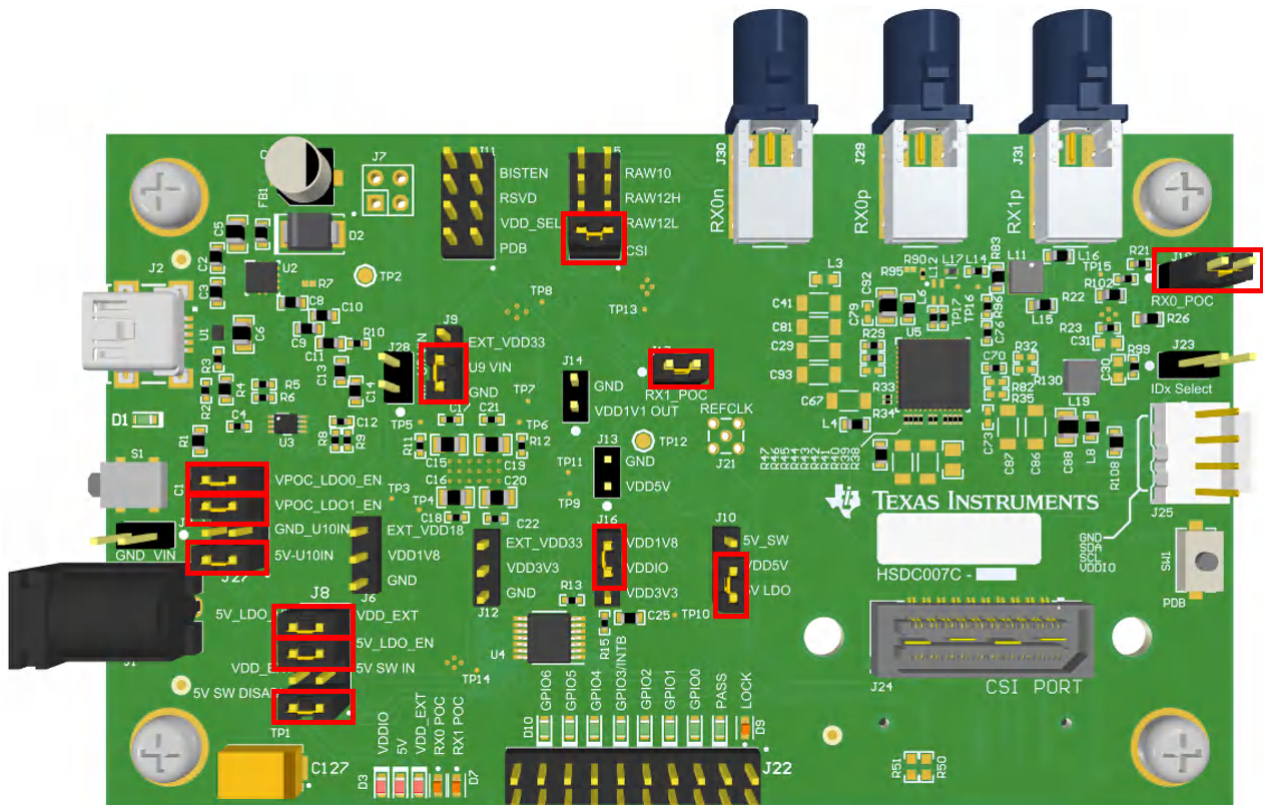

Figure 4-1. DS90UB954-Q1EVM with Jumpers Highlighted

4.2 Power Supply

Table 4-1. Power Supply

Reference	Signal	Description
J1/J3	+12V	Main Power Single +12VDC (nominal) power connector that supplies power to the entire board.

4.3 Power-over-Coax Interface

The DS90UB954-Q1EVM offers two Power-over-Coax interfaces (PoC) to connect cameras through a coaxial cable with FAKRA connectors. Power is delivered on the same conductor that is used to transmit video and control channel data between the host and the camera. By default, 5V power supply is applied over the coax cable. Refer to for other PoC configurations.

Note

For port RX0, the PoC network is configured for a DS90UB953-Q1EVM (or variant), and for RX1 the PoC network is configured for a DS90UB933-Q1. Only use a serializer EVM with the correct PoC network. To use PoC with two DS90UB953-Q1EVM (or variant) or DS90UB933-Q1 EVM's, one of the PoC networks must be reworked. You may also open the PoC circuit and power the serializer EVM directly from another supply.

For Power-over-Coax (PoC) on the EVM, the circuit uses a filter network as shown in Figure 4-3. The PoC network frequency response corresponds to the bandwidth compatible with DS90UB953-Q1EVM (or variant) chipsets.

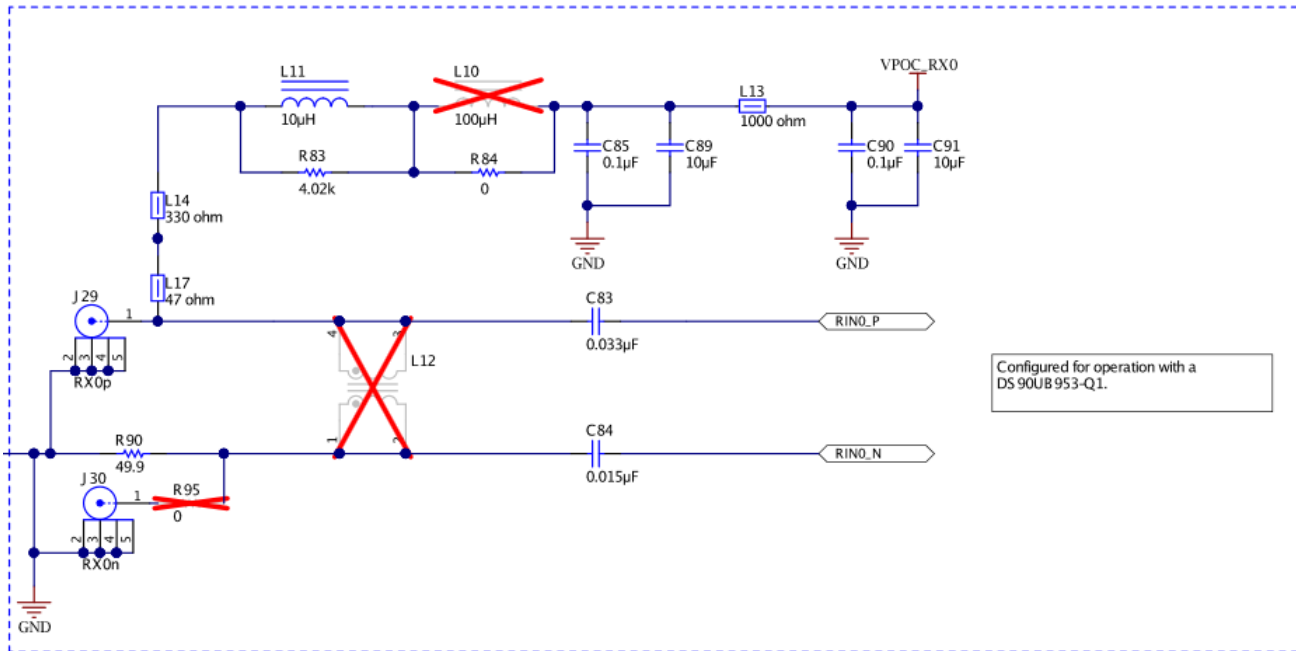

Figure 4-2. Power-over-Coax Network For Use With DS90UB953

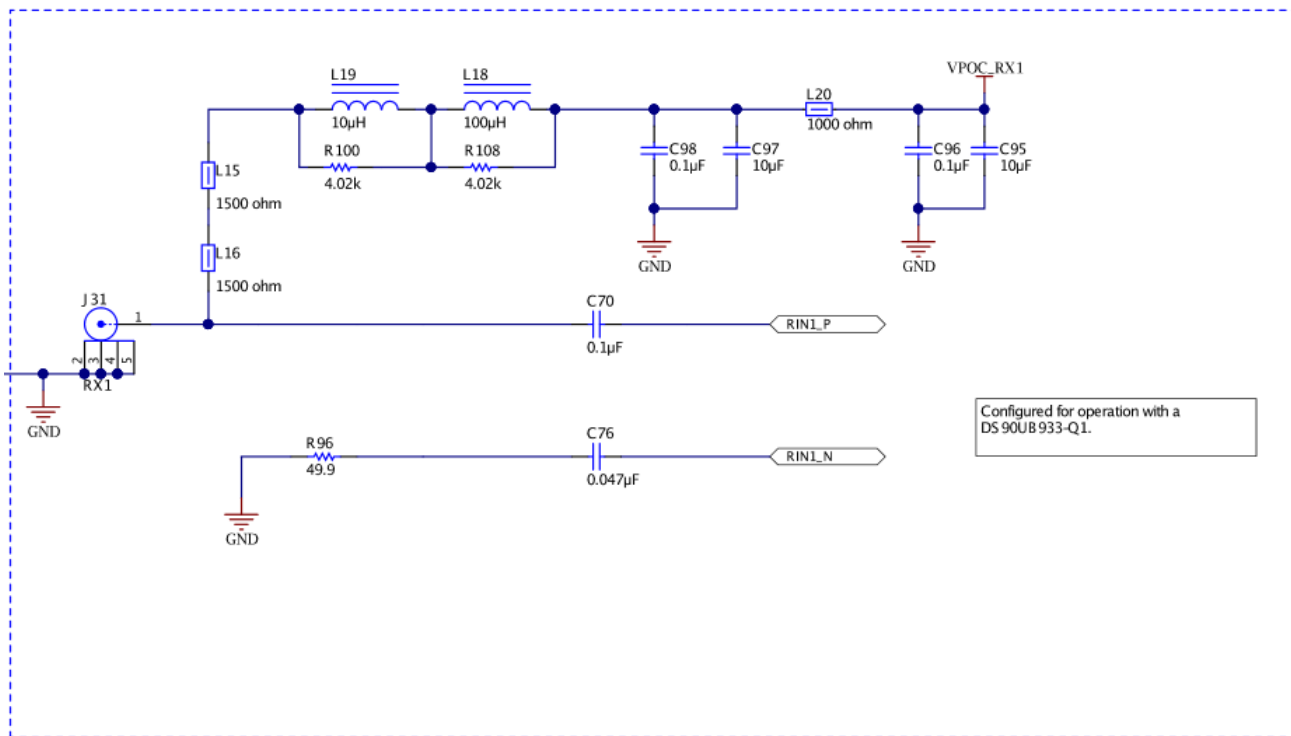

Figure 4-3. Power-over-Coax Network For Use With DS90UB933

WARNING

Verify that the Power-over-Coax voltage is properly set before plugging into RX0 or RX1. Power supply is not fused. Over-voltage will cause damage to boards directly connected due to incorrect input power supplies. **DS90UB913A-Q1EVM is designed for a maximum of 5V PoC.** To use DS90UB913A-Q1EVM with DS90UB954-Q1EVM, open J17 or J18 to disable PoC, and either power the DS90UB913A-Q1EVM separately or by applying 5V to the J17 or J18 pin on DS90UB954-Q1EVM.

Table 4-2. Power-over-Coax Power Supply Feed Configuration

Reference	Signal	Description
J18	VPOC_RX0	This sets the voltage for Power-over-Coax on RX0
		Jumper installed: +9V power supply from VPOC_LDO0_9V
		Jumper Open: No PoC connected. Apply power to pin1 or leave open and power serializer separately.
J17	VPOC_RX1	This sets the voltage for Power-over-Coax on RX1
		Jumper installed: +9V power supply from VPOC_LDO1_9V
		Jumper Open: No PoC connected. Apply power to pin1 or leave open and power serializer separately.

4.4 MIPI CSI-2 Output Signals

There are two options provided for passing out the deserialized data on the DS90UB954-Q1EVM . The first is a Samtec QSH-type connector, J24, on the top of the board that can be mated with a matching QTH type connector. The mating connector part number for the J24 connector is QTH-020-01-H-D-DP-A. On the bottom of the board is a Samtec QTH-type connector, J26, meant for mating with a TDAx evaluation kit. The signals to the connectors are the same, including access to I²C and other signals including PDB and GPIO. Only one connector should be used at a time. If the J6 connector on the bottom is to be used, populate the zero ohm resistors on the bottom of the board which extend the traces to the J26 connector.

There are third party solutions like the HDR-128291-XX breakout board from Samtec which can be used. The HDR- 128291-XX is a breakout board with a mating connector to J24 or J26, providing access to each pin through standard SMA male connectors. More info on this breakout board can be obtained from Samtec website. Another third party option is the ZX100 by Zebax Technologies. More information on this board can be obtained from Zebax website.

Table 4-3. MIPI CSI-2 Output Signals - J5 and J6 Pinout

Pin #	Signal Name	Pin #	Signal Name
1	NC	2	EXP_SCL (I2C_SCL or I2C_SCL2)
3	NC	4	EXP_SDA (I2C_SDA or I2C_SDA2)
5	CSI_CLK0_P	6	NC
7	CSI_CLK0_N	8	NC
9	CSI_D0_P	10	EXP_REF_CLK (REFCLK)
11	CSI_D0_N	12	GND
13	CSI_D1_P	14	RESET (PDB)
15	CSI_D1_N	16	GND
17	CSI_D2_P	18	SPI_PICO (GPIO0 or GPIO3)
19	CSI_D2_N	20	SPI_SCLK (GPIO1 or GPIO4)
21	CSI_D3_P	22	SPI_CS (GPIO2 or GPIO5)
23	CSI_D3_N	24	GND
25	CSI_CLK1_P	26	NC
27	CS_CLK1_N	28	NC
29	NC	30	VDD_3V3
31	NC	32	VDD_3V3
33	NC	34	VDD_3V3
35	NC	36	VDD_3V3
37	NC	38	VDD_1V8
39	NC	40	VDD_1V8

Note

Populate R60-R69, R71,R72 (0 Ω resistors) only when using the J26 connector on the bottom of the board. Do not use J24 and J26 connectors at the same time.

4.5 FPD-Link III Signals

Table 4-4. FPD-Link III Signals

Reference	Signal	Description
RX0p	RIN0+	FAKRA connector for DS90UB953-Q1EVM (or variant) serializer
RX0n	RIN0-	FAKRA connector footprint for use with STP applications.
RX1	RIN1+	FAKRA connector for DS90UB933-Q1 serializer

4.6 I²C Interface

In addition to the on-board USB2ANY controller accessible via the mini-USB port, a standalone external I²C host can connect via J25 for programming purposes. Examples of external I²C host controllers are Texas Instruments USB2ANY and Total Phase Aardvark I²C/SPI host adapter (Total Phase Part#: TP240141).

When the I²C interface is accessed through connector J25, I²C signal levels can be configured through J16 to be at 1.8V or 3.3V. Optional access to I²C signals are also available via CSI-2 connectors J24 (top) and J26 (bottom).

Table 4-5. IDx I²C Device Address Select - J23

Reference	Signal	Description
J23	IDX Select	Selects I ² C Device Address
		Open: 0x30 (7'b) or 0x60 (8'b)
		Short: 0x3D (7'b) or 0x7A (8'b) (Default)

Table 4-6. I²C Interface Header - J25

Reference	Signal	Description
J25.1	GND	Ground
J25.2	I2C_SDA	I ² C Data Interface for I ² C bus
J25.3	I2C_SCL	I ² C Clock Interface for I ² C bus
J25.4	VDDIO	I ² C bus voltage (tied to VDDIO)

4.7 Control Interface

Table 4-7. VDDIO Interface Header - J16

Reference	Signal	Description
J16	VDDIO	Selects VDDIO bus voltage
		Short pins 1-2: 3.3V IO (Default)
		Short pins 2-3: 1.8V IO

Table 4-8. GPIO Interface Header - J22

Reference	Signal	Description
J22.1	GPIO0	General Purpose Input/Output 0
J22.3	GPIO1	General Purpose Input/Output 1
J22.5	GPIO2	General Purpose Input/Output 2
J22.7	GPIO3/INTB	General Purpose Input/Output 3 / Interrupt (Active Low). Pulled up to VDDIO by 4.7k Ω
J22.9	GPIO4	General Purpose Input/Output 4
J22.11	GPIO5	General Purpose Input/Output 5
J22.13	GPIO6	General Purpose Input/Output 6
J22.15	EN 25MHz	Enable/Disable 25MHz Oscillator

Table 4-9. CMLOUT Output Signals

Reference	Signal	Description
TP16	CMLOUTP	Test Pad for Channel Monitor Loop-through Driver
TP17	CMLOUTN	Test Pad for Channel Monitor Loop-through Driver

Table 4-10. FPD-Link III Mode Control- J15

Reference	Mode ⁽¹⁾	Description
J15.1	1	CSI Mode (DS90UB953-Q1 compatible) ⁽²⁾
J15.2	2	RAW12 / LF (DS90UB933 compatible)
J15.3	3	RAW12 / HF (DS90UB933 compatible)
J15.4	4	RAW10 (DS90UB933 compatible)

(1) Only set one ON.

(2) This function is only available with 2-MP ADAS chipsets.

Table 4-11. Device Mode Control - J11

Reference	Signal	Input = L	Input = H	Description
J11.1	BISTEN	For Normal operation (Default)	Test Mode enable	Test Mode
J11.2	RSVD	Tied to GND (Default)	N/A	Reserved
J11.3	VDD_SEL	Internal 1.1V regulator from 1.8V supply (Default)	1.1V is supplied to VDD1V1 pins	VDD 1.1V Source Select
J11.4	PDB	Device is powered down	Device is enabled (Default)	Power-down Mode

Table 4-12. LEDs

Reference	LED Color	LED Name	Description
D3	Red	VDDIO	Illuminates on VDDIO Power
D4	Red	VDD5V	Illuminates on +5V
D5	Red	VDD_EXT	Illuminates if 12V Power is applied to DC-IN J24
D6	Orange	VPOC_RX1	Illuminates if VPOC_RX1 is ON
D7	Orange	VPOC_RX0	Illuminates if VPOC_RX0 is ON
D8	Orange	PASS	Illuminates if PASS pin is HIGH
D9	Green	LOCK	Illuminates if LOCK pin is HIGH
D10	Green	GPIO6	Illuminates if GPIO6 is HIGH
D11	Green	GPIO5	Illuminates if GPIO5 is HIGH
D12	Green	GPIO4	Illuminates if GPIO4 is HIGH
D13	Green	GPIO3/INTB	Illuminates if GPIO3 is HIGH, or GPIO3 disabled (pulled-up)
D14	Green	GPIO2	Illuminates if GPIO2 is HIGH
D15	Green	GPIO1	Illuminates if GPIO1 is HIGH
D16	Green	GPIO0	Illuminates if GPIO0 is HIGH

5 Enable and Reset

The DS90UB954-Q1 is enabled and reset by controlling the PDB input level. PDB has an internal pull down, and should remain low until all supplies are stable. There are three device enable and reset/power-down options for the EVM.

- RC timing option: The RC delay created with C123 and R131 connected to the PDB pin is the default option for delaying PDB on the EVM. This is used for simplicity of debugging and using the device. TI recommends using a GPIO signal from a host process or to drive PDB after all rails have settled in customer designs.
- External control option: A momentary push-button switch, SW1, is available for manually driving the PDB signal low while the button is held.
- Software control option: The PDB pin is also made available in the J24 and J26 CSI-2 output connectors, allowing a host processor to control the PDB pin.

6 Use with DS90UB936-Q1

The DS90UB954-Q1EVM may also be used to evaluate the DS90UB936-Q1. The only modification required is to swap the DS90UB954-Q1 with the DS90UB936-Q1.

7 Typical Connection and Test Equipment

The following is a list of typical test equipment that may be used to monitor the MIPI CSI-2 signals from the DS90UB954-Q1:

1. Logic Analyzer
2. Any SCOPE with a bandwidth of at least 4 GHz for observing differential signals.
3. UNH-IOL MIPI D-PHY Reference Termination Board (RTB)
4. UNH-IOL MIPI D-PHY/CSI/DSI Probing Board
5. UNH-IOL CSIGUI Tool

8 Termination Device

A termination device is required to properly monitor and measure the transmission of the MIPI DPHY signals. The termination device should support the change of signals as it switches between LP and HS modes. This can be provided by either a CSI-2 receiver or a dedicated dynamic termination board. The recommended termination board is the UNH-IOL MIPI D-PHY Reference Termination Board (RTB).

9 Typical Test Setup

Figure 9-1 illustrates a typical test set up used to measure and evaluate DS90UB954-Q1.

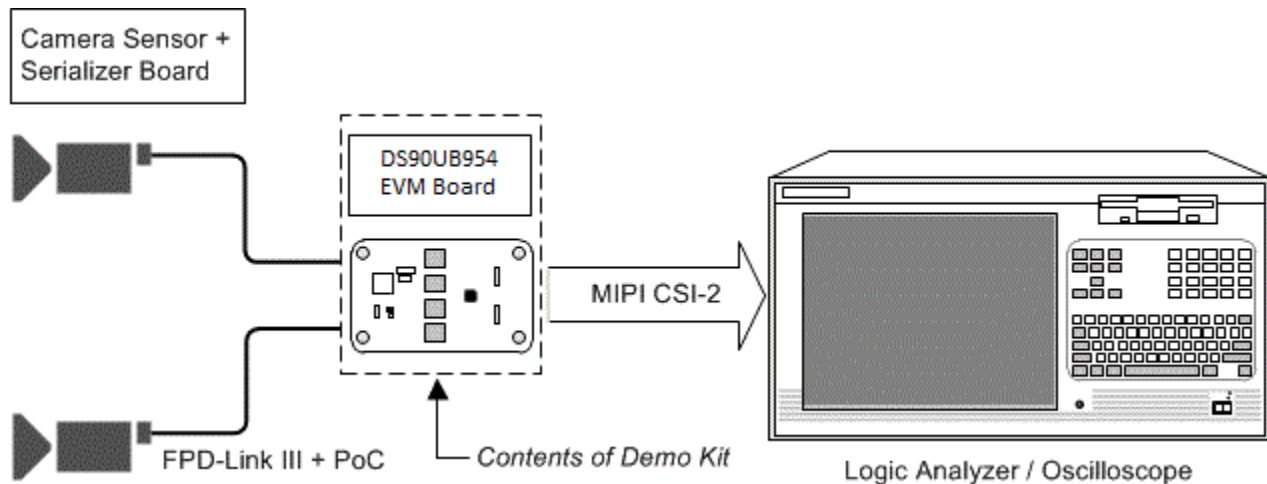

Figure 9-1. Typical Test Setup for Evaluation

10 Equipment References

Note

Please note that the following references are supplied only as a courtesy to our valued customers. It is not intended to be an endorsement of any particular equipment or supplier.

Logic Analyzer:

Keysight Technologies

www.keysight.com

MIPI Test Fixtures:

University of New Hampshire InterOperability Laboratory (UNH-IOL)

www.iol.unh.edu/services/testing/mipi/fixtures.php

Aardvark I²C/SPI Host Adapter Part Number: TP240141

www.totalphase.com/products/aardvark_i2cspi

11 Cable References

FAKRA coaxial cable:

www.leoni-automotive-cables.com

Rosenberger FAKRA connector:

<http://www.rosenberger.com/en/products/automotive/fakra.php>

12 Software for DS90UB954Q1-EVM Evaluation - Analog LaunchPAD (ALP) Software Setup

12.1 System Requirements

Operating System:	Windows 7 64-bit
USB:	USB2ANY (on-board, accessible via mini USB connector)
USB2ANY Firmware Version:	2.5.2.0
USB:	Aardvark I ² C/SPI host adapter p/n TP240141

12.2 Download Contents

Latest TI Analog LaunchPAD can be downloaded from: <http://www.ti.com/tool/alp>.

Download and extract the zip file to a temporary location that can be deleted later.

The following installation instructions are for a PC running Windows 7 64-bit Operating System.

12.3 Installation of the ALP Software

Execute the ALP Setup Wizard program called "ALPF_setup_v_x_x_x.exe" that was extracted to a temporary location on the local drive of your PC.

There are 7 steps to the installation once the setup wizard is started:

1. Select the "Next" button.
2. Select "I accept the agreement" and then select the "Next" button.
3. Select the location to install the ALP software and then select the "Next" button.
4. Select the location for the start menu shortcut and then select the "Next" button.
5. There will then be a screen that allows the creation of a desktop icon. After selecting the desired choices select the "Next" button.
6. Select the "Install" button, and the software will then be installed to the selected location.
7. Uncheck "Launch Analog LaunchPAD" and select the "Finish" button. The ALP software will start if "Launch Analog LaunchPAD" is checked, but it will not be useful until the USB driver is installed and board is attached.

Power the DS90UB954-Q1 EVM board with a 12 VDC power supply.

12.4 Startup - First Launch

Make sure all the software has been installed and the hardware is powered on and connected to the PC. Execute “Analog LaunchPAD” shortcut from the start menu. The default start menu location is under All Programs > Texas Instruments > Analog LaunchPAD vx.x.x > Analog LaunchPAD to start MainGUI.exe.



Figure 12-1. Launching ALP Splash Screen

Upon first launch of the Analog LaunchPAD utility, the default device will be DS90UB925. The active device can be seen as highlighted in [Figure 12-2](#), here showing the DS90UB954 as active. If the active device is already set to DS90UB954 you may skip to [Section 13](#).

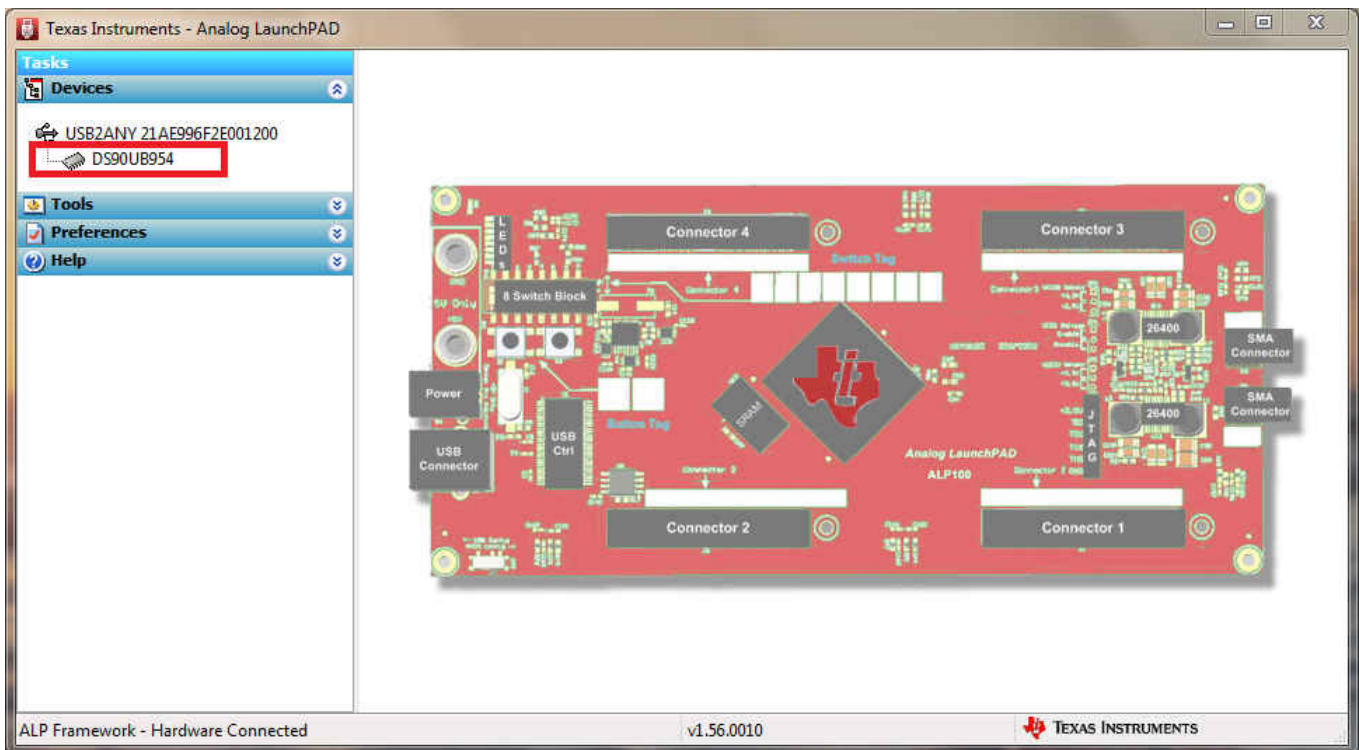

Figure 12-2. Initial ALP Screen

Follow the steps beginning with [Figure 12-3](#) to change the ALP profile to DS90UB954.

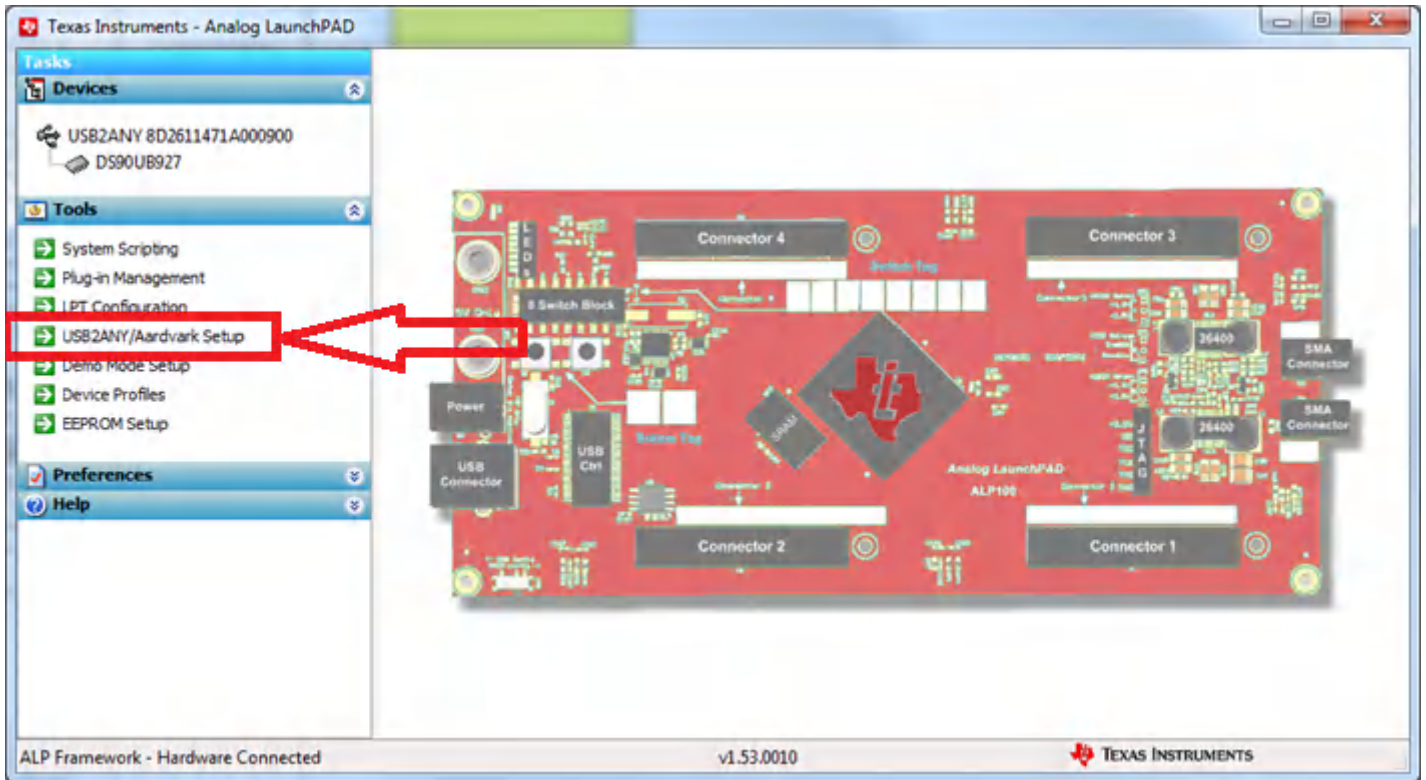

Figure 12-3. Select USB2ANY/Aardvark Setup to Change Profile

Select the active profile and click "Remove". Scroll down the list of available profiles to DS90UB954, click to highlight it, click "Add", and click "Ok".

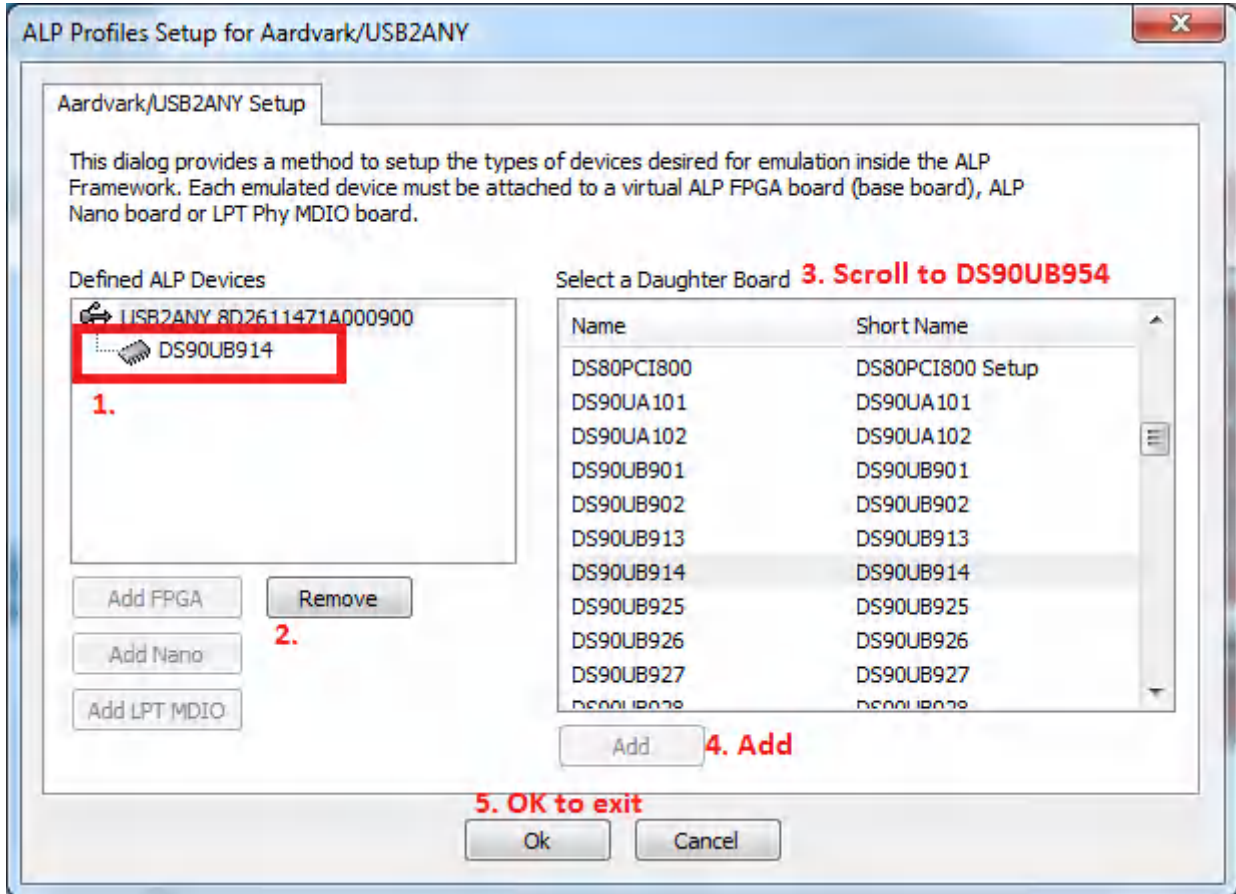

Figure 12-4. ALP Profiles Dialog

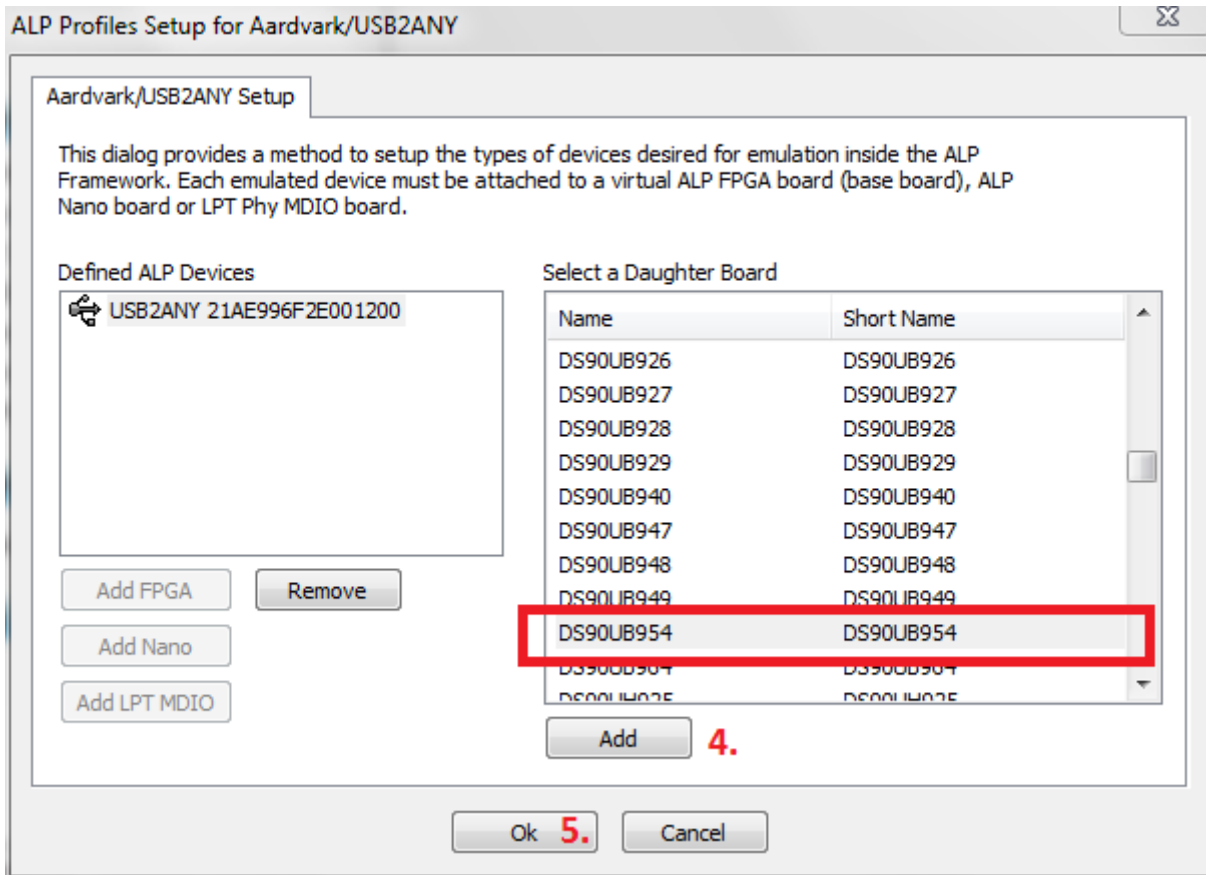

Figure 12-5. ALP Profiles Dialog (continued)

13 Using ALP and DS90UB954 Profile

13.1 Information Tab

Under the Devices tab click on “DS90UB954” to select the device and open up the device profile and its associated tabs. After selecting the DS90UB954, the following screen should appear. [Figure 13-1](#) shows the Information tab. The information tab shown assumes active and locked connection to a DS90UB953 on RX0, and an open port on RX1.

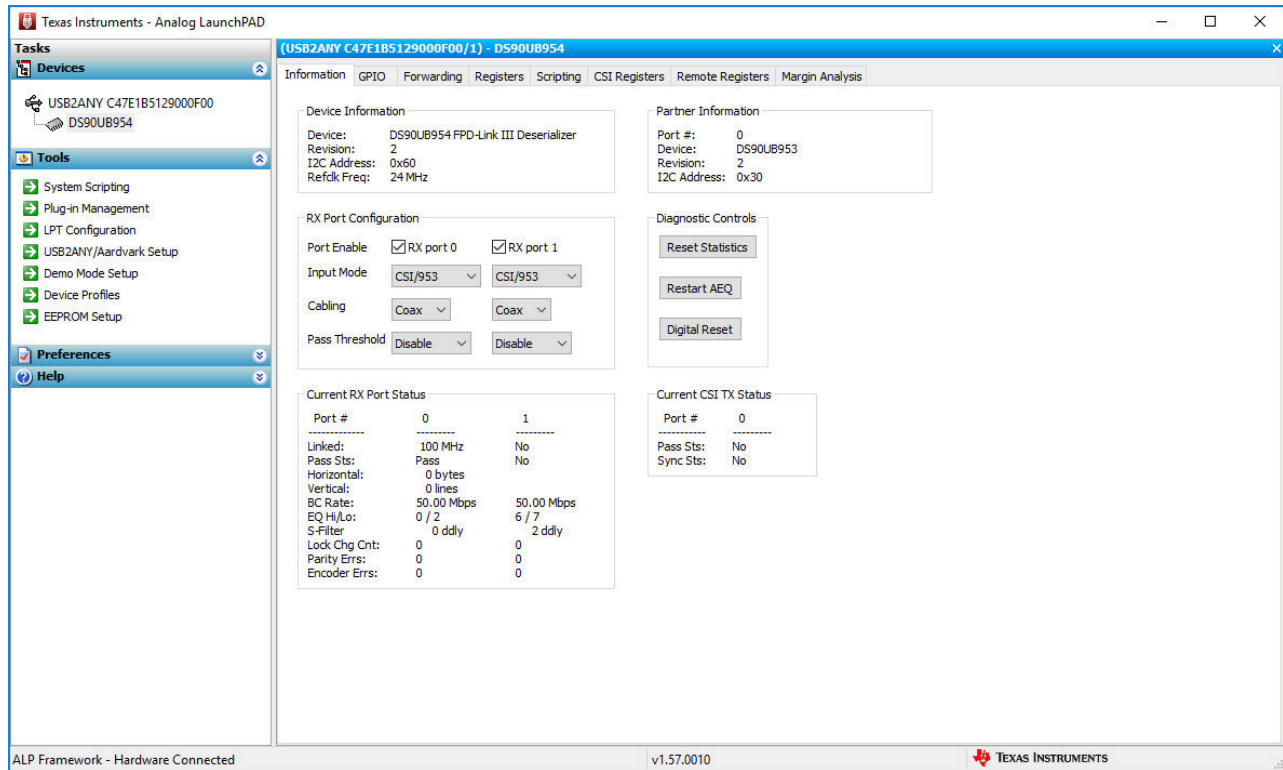

Figure 13-1. ALP Information Tab

13.2 Registers Tab

The Registers tab is shown in [Figure 13-2](#). Note that the value of the currently selected register is populated in the "Value: " box at the top. [Figure 13-2](#) shows the register I2C_DEVICE_ID is reading a hexadecimal value of 0x60.

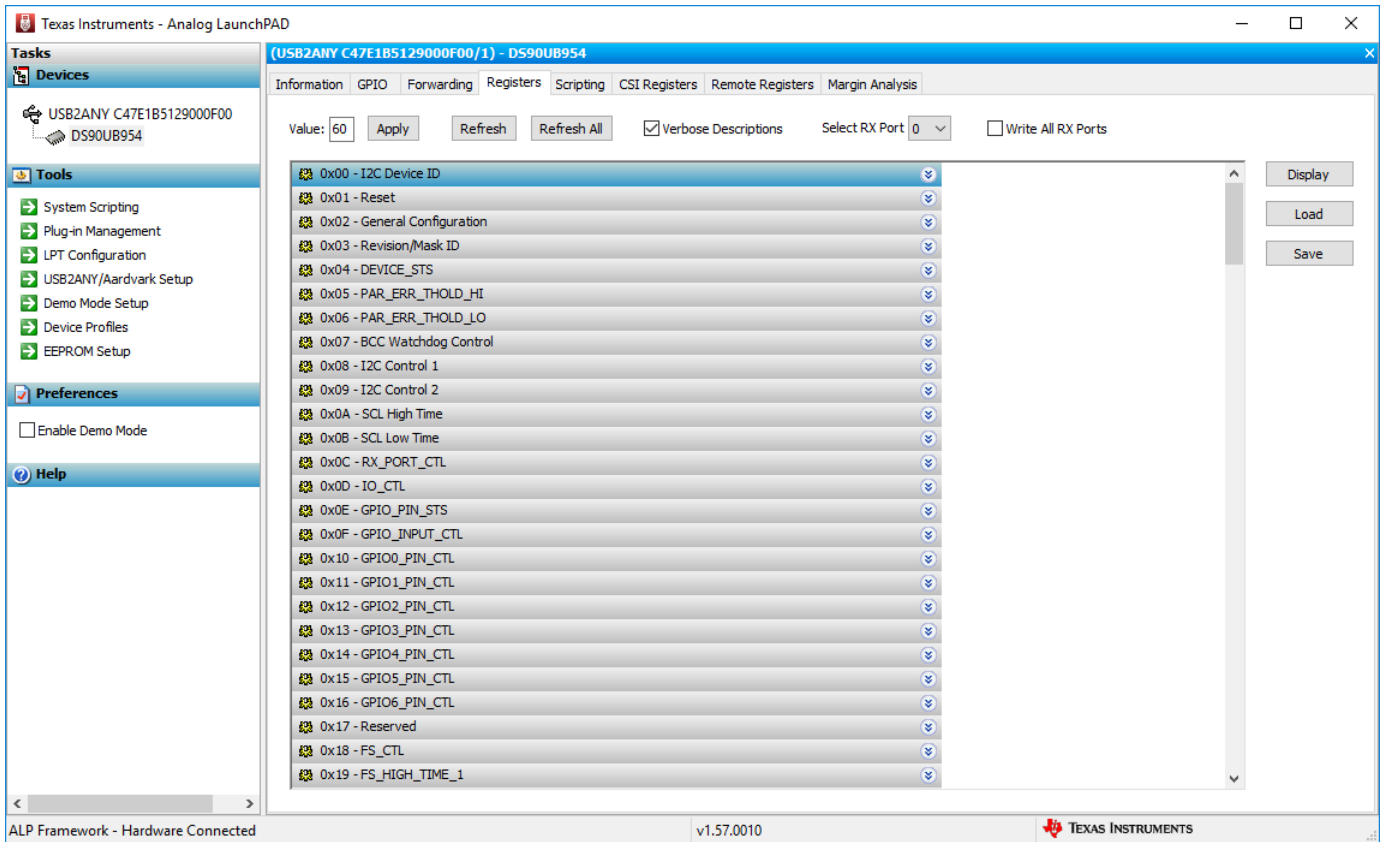



Figure 13-2. ALP Registers Tab

13.3 Registers Tab - Address 0x00 Expanded

By double clicking on the Address bar



or a single click on . Address 0x00 expanded reveals contents by bits. Any register address displayed can be expanded.

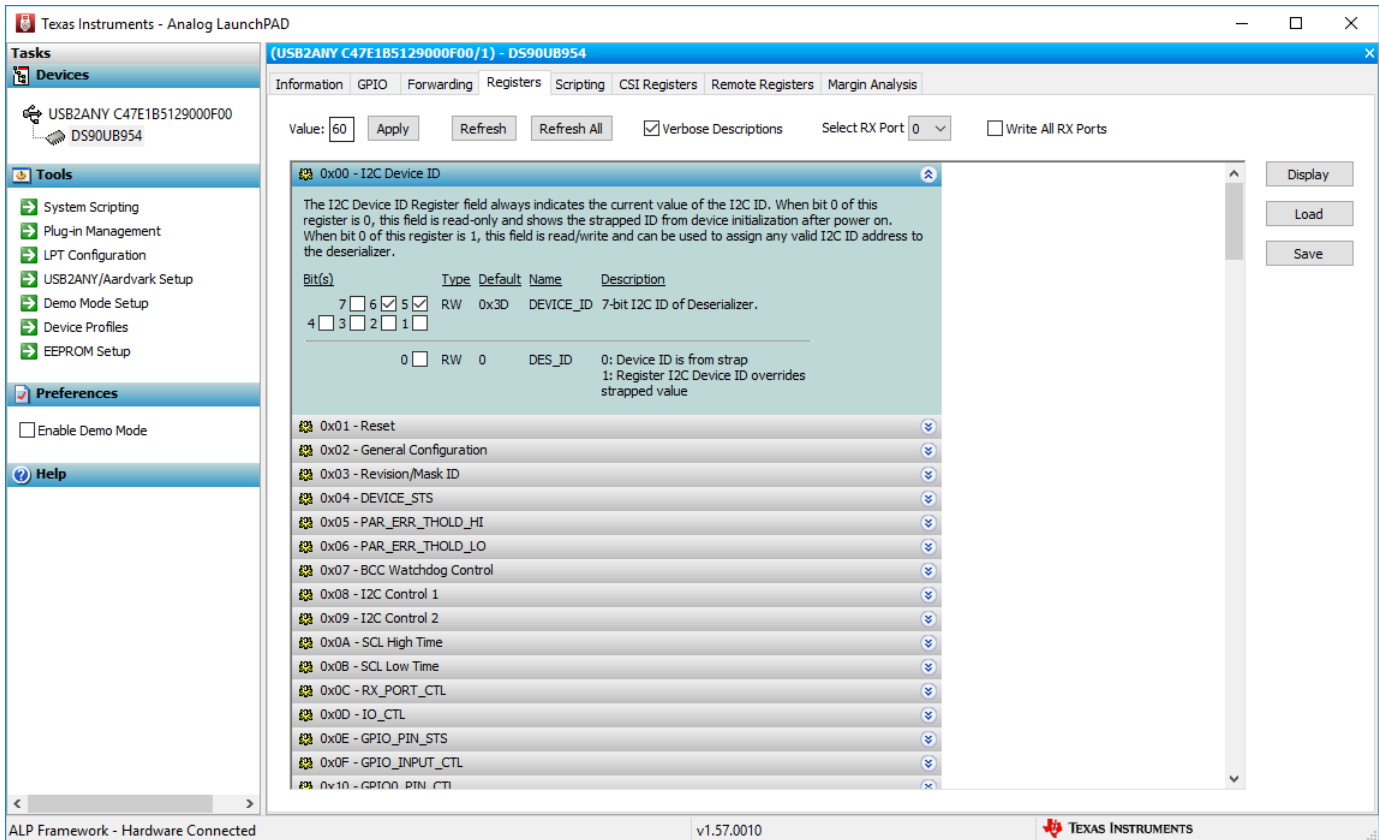



Figure 13-3. ALP Device ID Expanded

Any RW Type register can be written into by writing the hex value into the “Value:” box,  or putting the pointer into the individual register bit(s) box by a left mouse click to put a check mark (indicating a “1”) or unchecking to remove the check mark (indicating a “0”). Click the “Apply” button to write to the register, and “refresh” to see the new value of the selected (highlighted) register.

The box toggles on every mouse click.

13.3.1 Port Specific Registers

13.3.2

Certain registers in the DS90UB954-Q1 are port specific and have two copies, one for each FPD-Link RX port. The "Select RX Port" drop-down menu controls which port's registers are read. If the "Write All RX Ports" box is checked, both ports' registers will be written to. If it is not checked, only the port indicated by the drop-down menu will be written to. These controls set the value of register 0x4C, which is used to set which port is being read and which port(s) are being written to.

13.4 Saving and Loading Register Settings

Register settings can be saved and later loaded to the device using the "Save" and "Load" buttons. To save, click on the "Save" button, select the file location, and name the file. If desired, comments may be recorded

about the register settings. After the registers are saved, a dialog box will appear confirming that the registers were saved successfully. To load saved registers, click the "Load" button and select the .nrd file. Additional information about the register settings, including any comments, will be displayed in the dialog box. After confirming these are the desired registers settings, a message will appear confirming that the registers were successfully loaded.

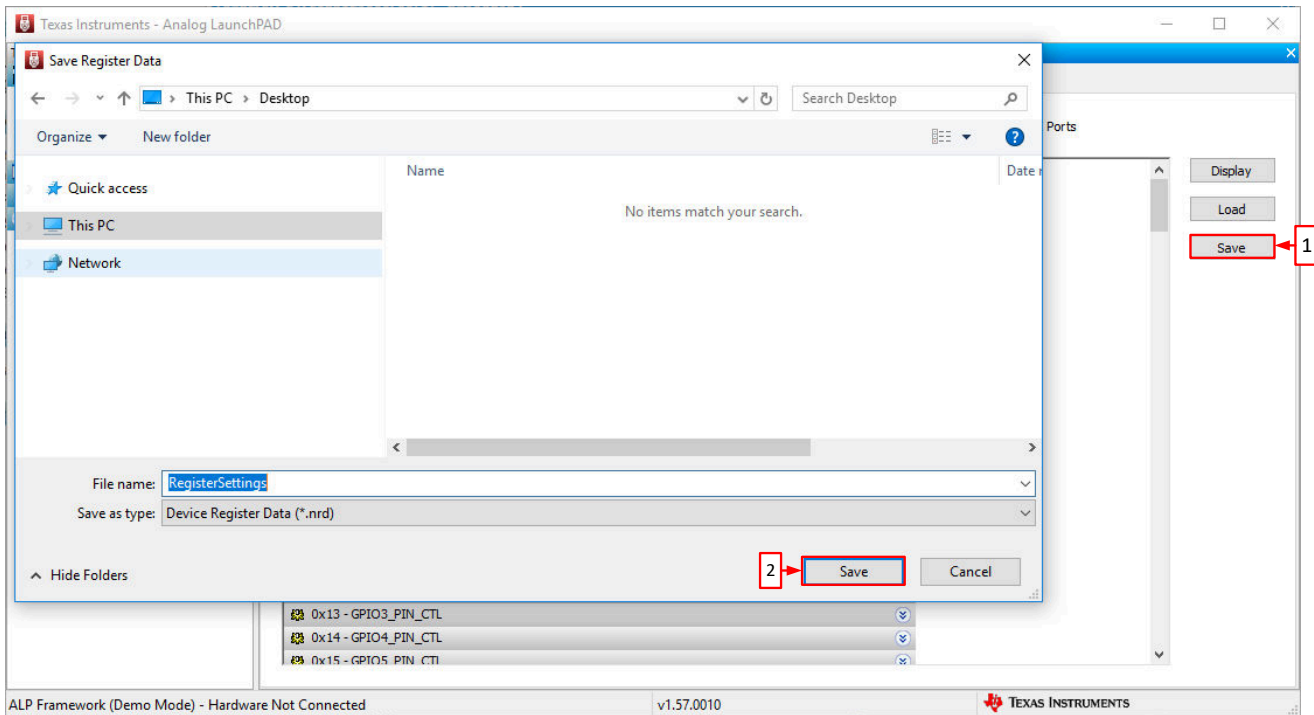

Figure 13-4. Save Register Settings Step 1

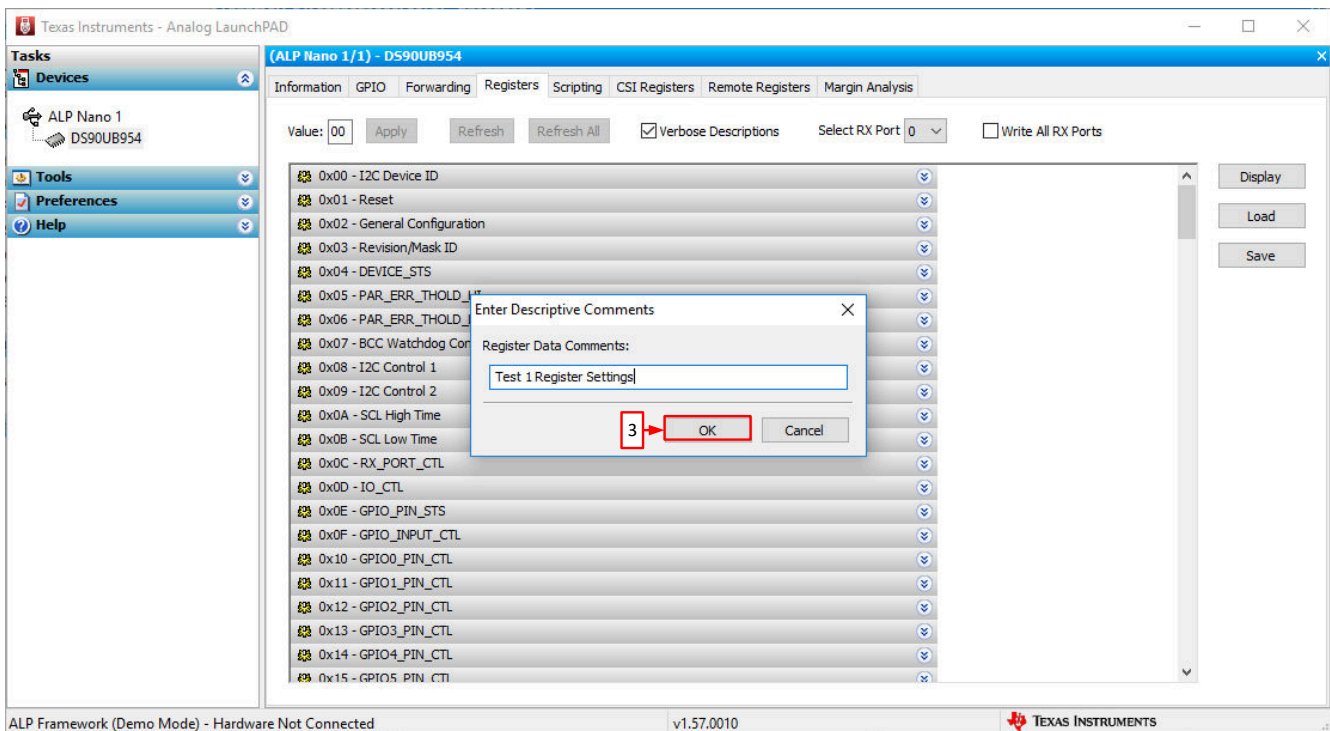

Figure 13-5. Save Register Settings Step 2

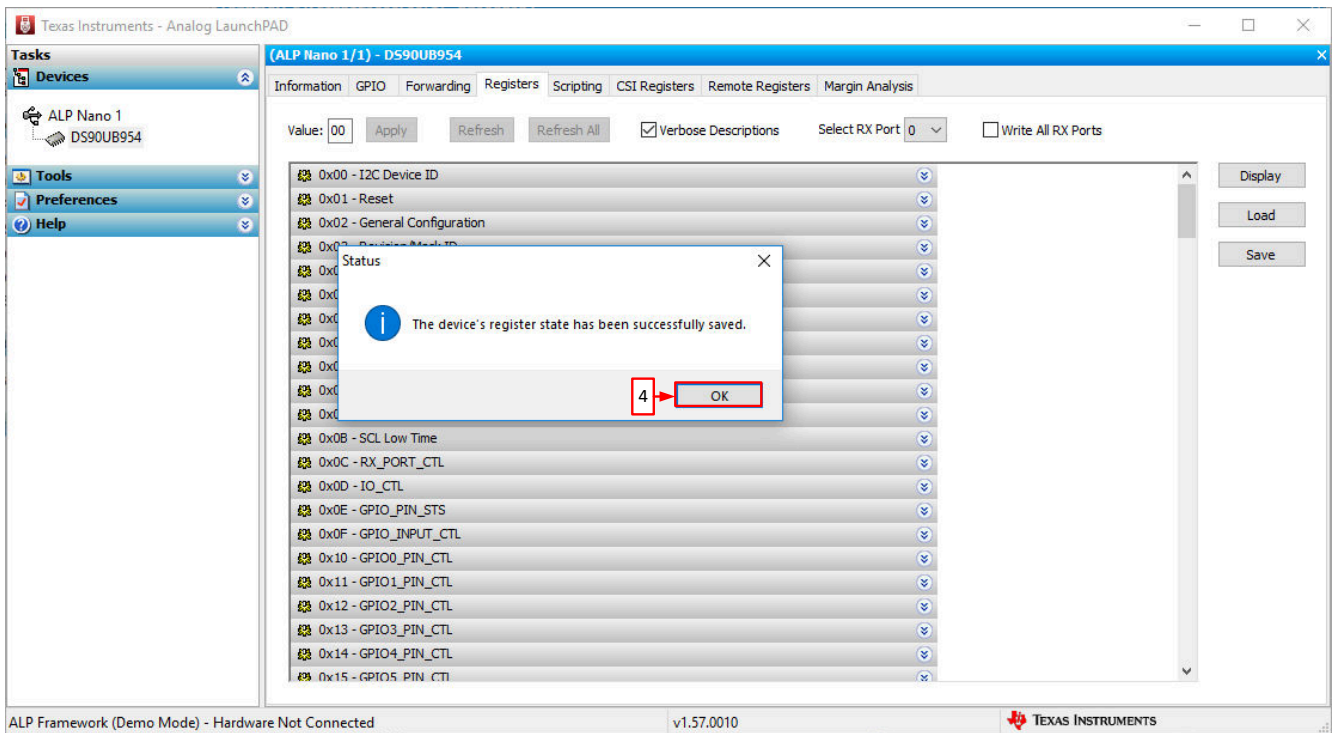

Figure 13-6. Save Register Settings Step 3

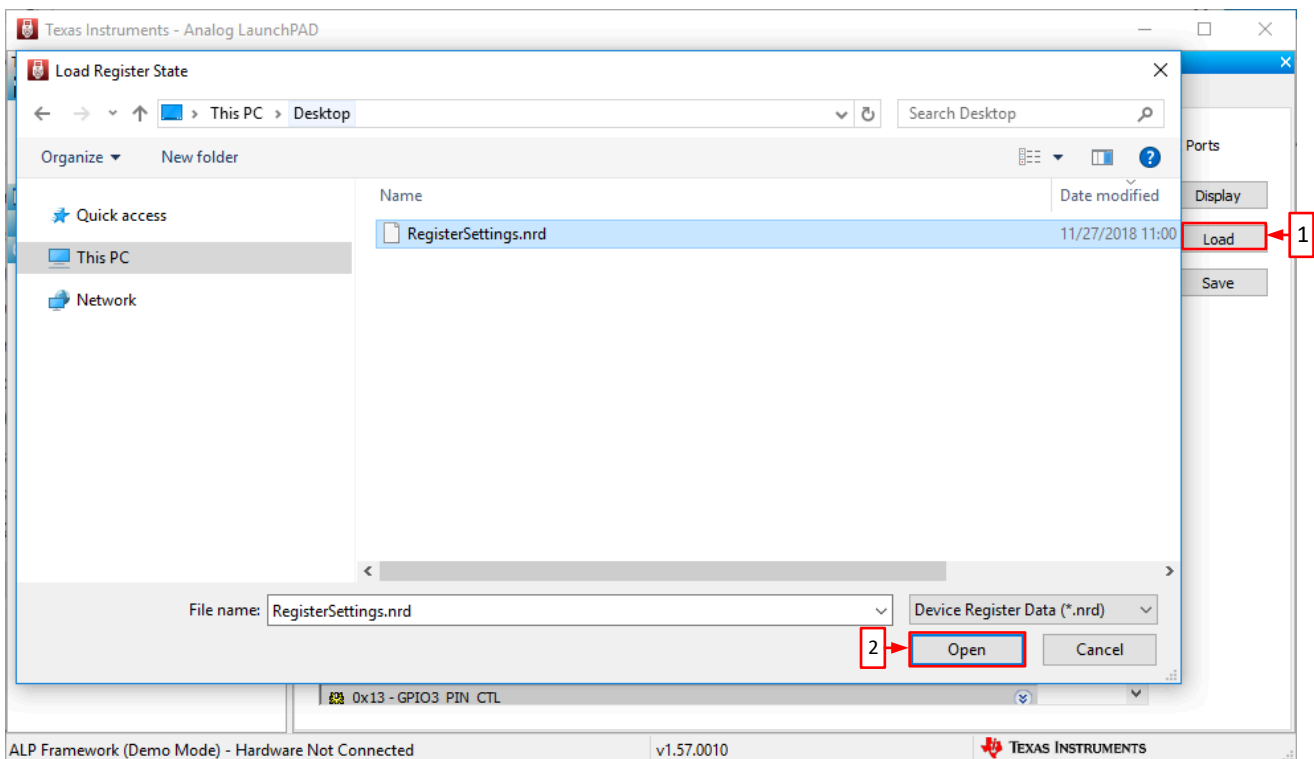

Figure 13-7. Load Register Settings Step 1

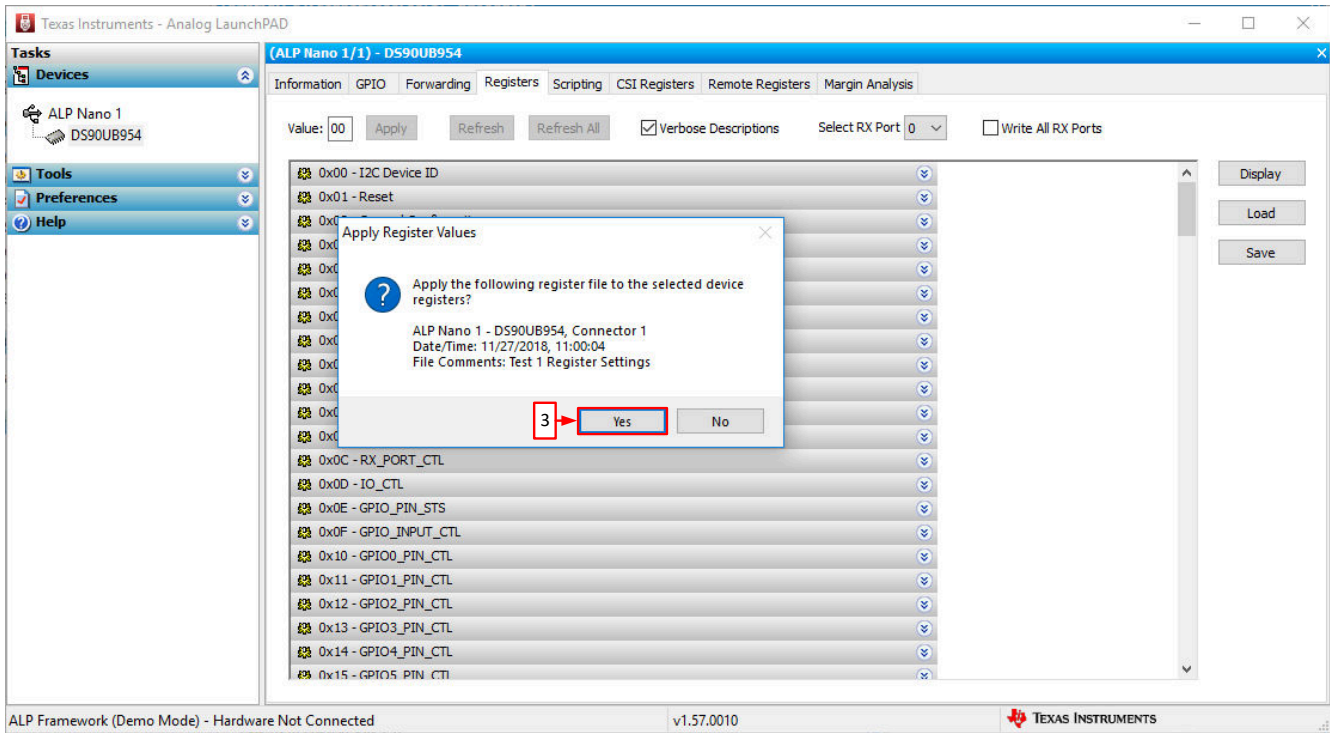

Figure 13-8. Load Register Settings Step 2

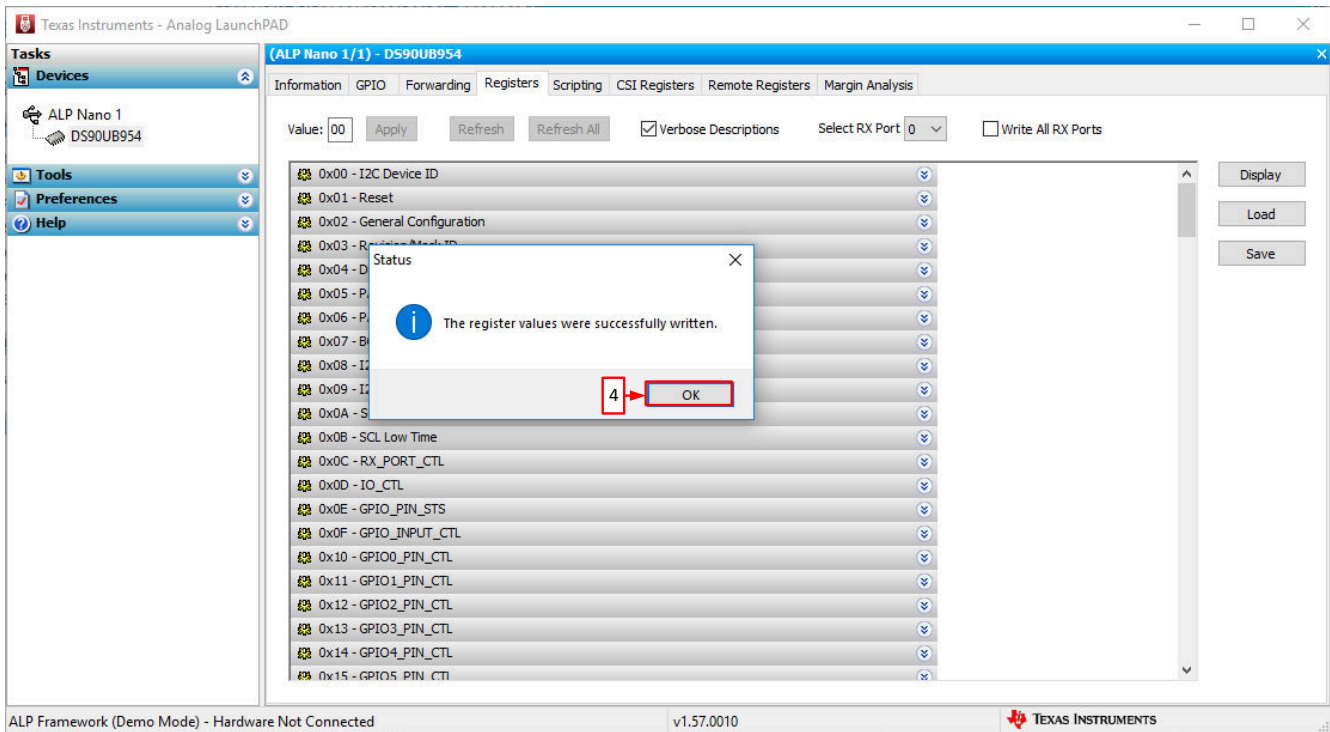

Figure 13-9. Load Register Settings Step 3

13.5 Scripting Tab

Figure 13-10 shows the Scripting tab. The script window provides a full Python scripting environment which can be for running scripts and interacting with the device in an interactive or automated fashion. Commands may be written directly into the Scripting tab or may be run from a .py file using the "Run" button. Example scripts may be found using the "Run PreDef Script" button.

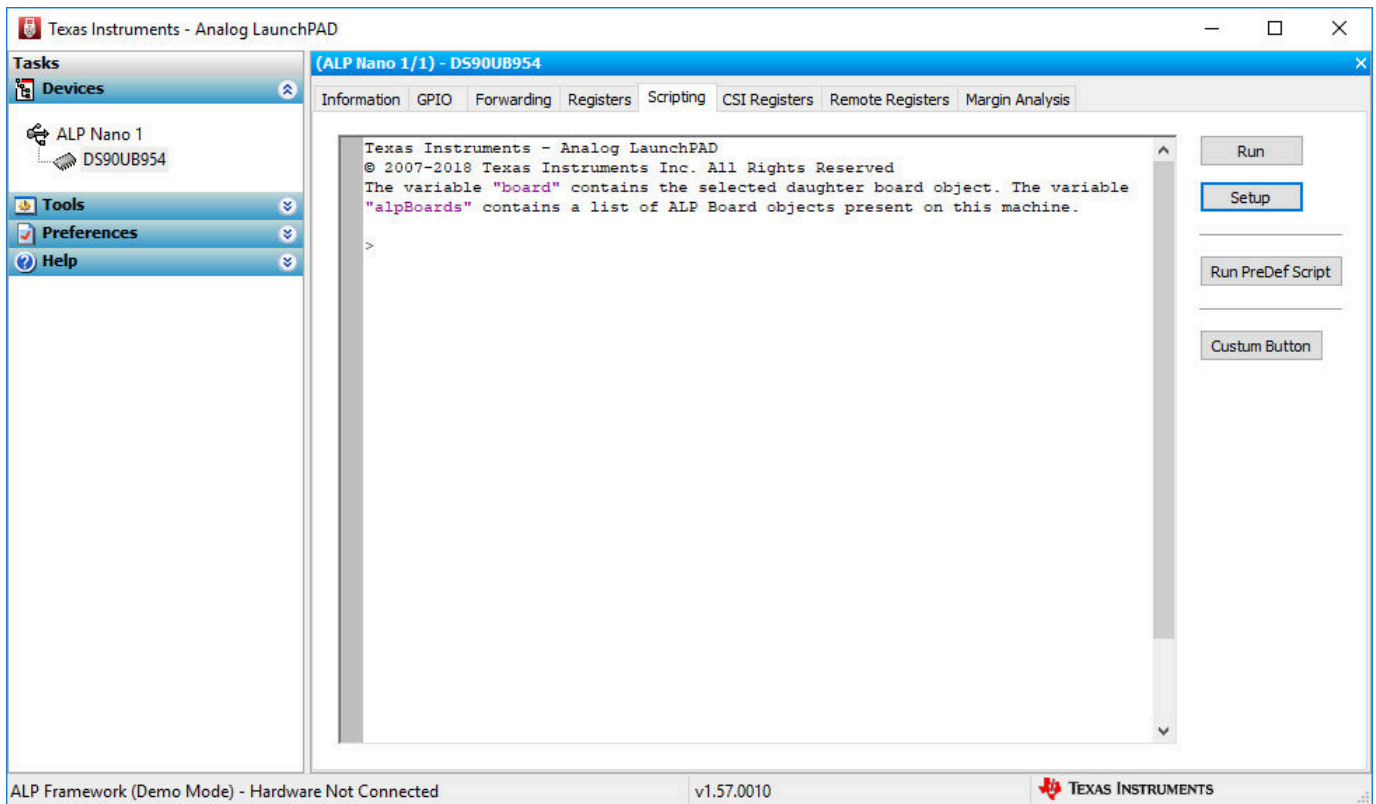

Figure 13-10. ALP Scripting Tab

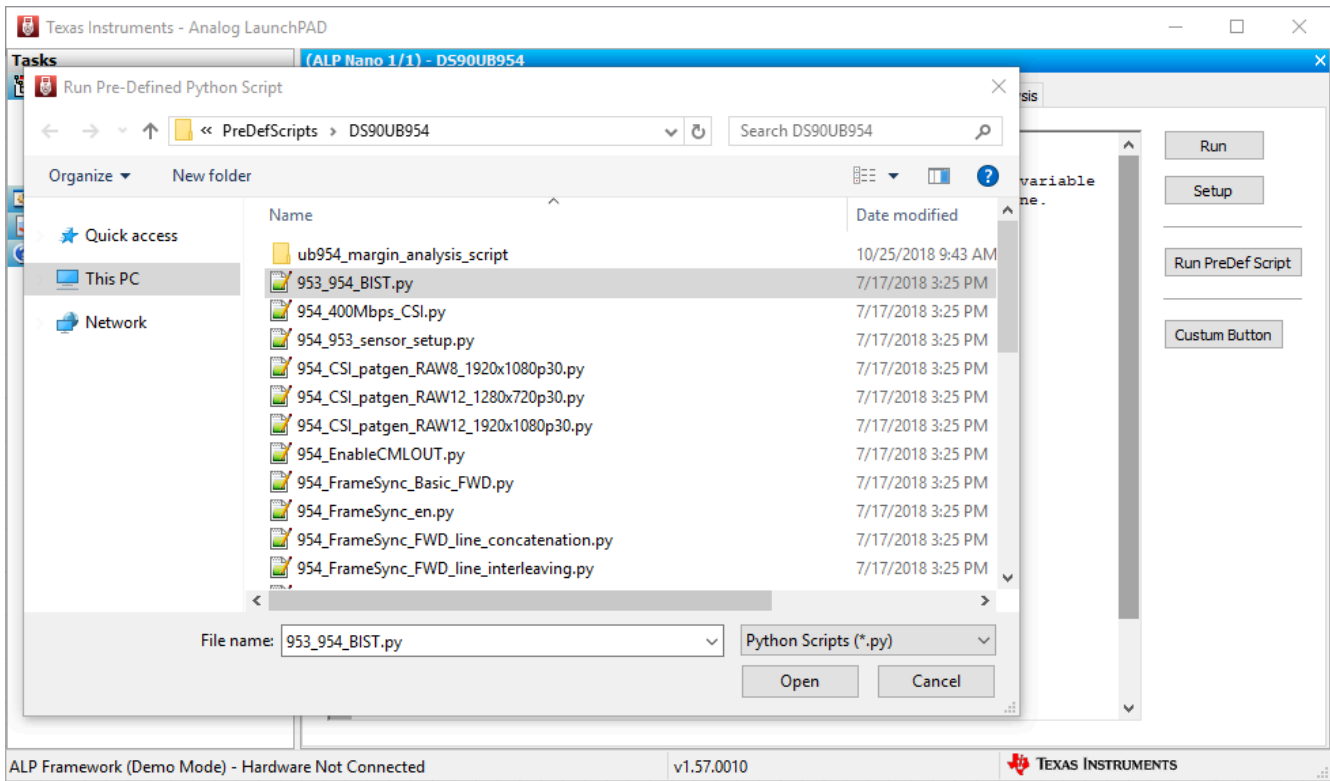

Figure 13-11. Pre-Defined Scripts

It is also possible to create custom buttons on the Scripting tab to run a desired script. To do so, click on the "Setup" button, then say "Add", and select the desired name and script. To make the button appear in future instances of ALP, click the "Set As Default" button.

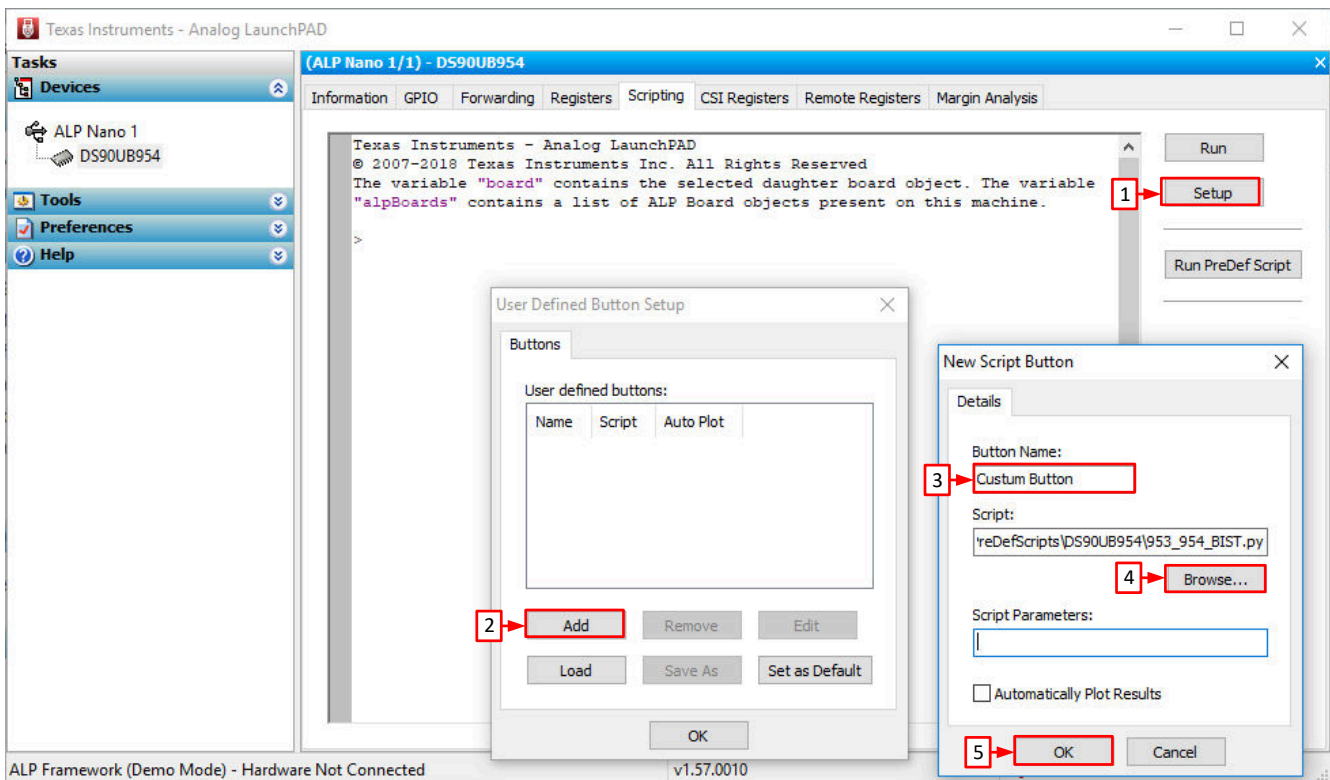

Figure 13-12. Custom Button Creation Step 1

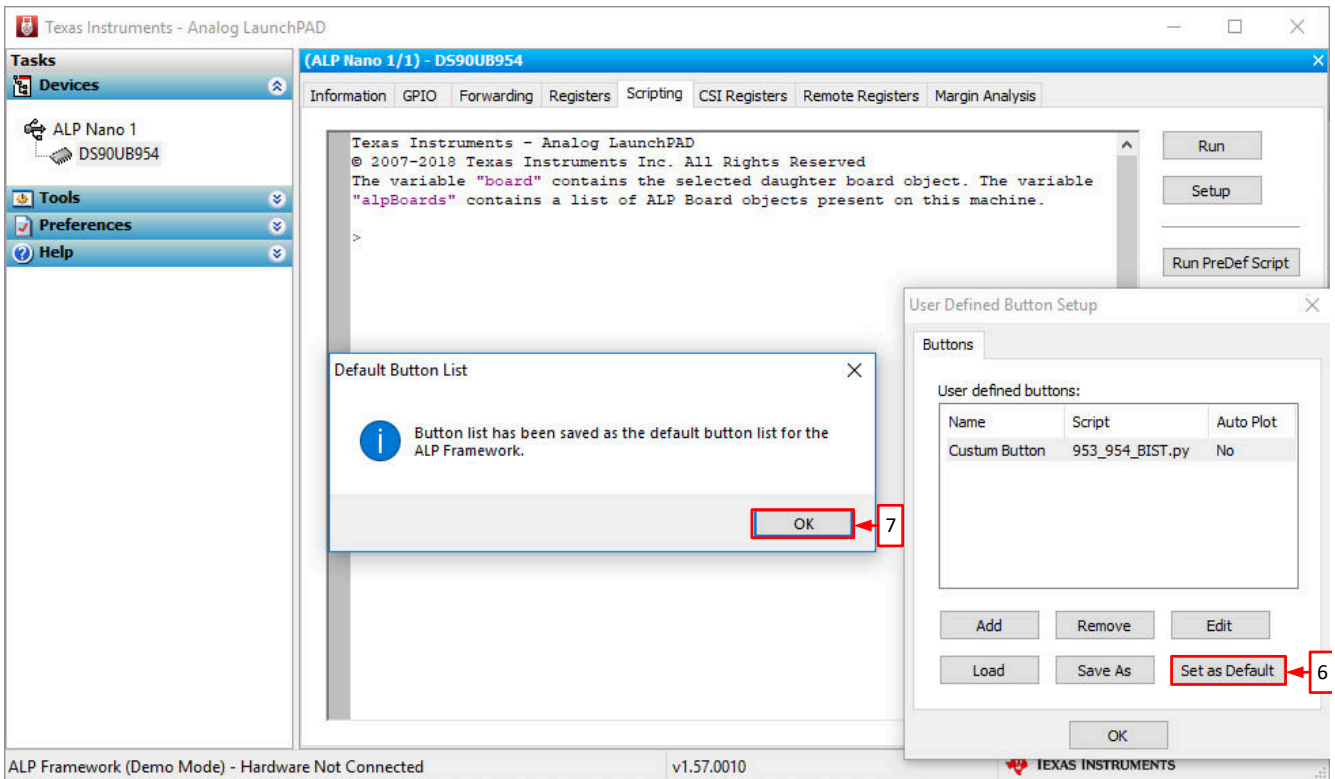

Figure 13-13. Custom Button Creation Step 2

WARNING

Directly interacting with devices either through register modifications or calling device support library functions can effect the performance and/or functionality of the user interface and may even crash the ALP Framework application.

13.5.1 Example Functions

The following are Python functions commonly used to interact with FPD-Link devices.

13.5.1.1 Local I2C Reads/Writes

These functions will perform reads and writes only for the I2C assigned to board.devAddr, which by default will be the detected address for the DS90UB954-Q1.

board.ReadReg(Register Address , # of Bytes) OR **board.ReadReg(Register Address)** I2C Read Command

- Accepts both hex & decimal inputs
- Number of bytes will default to 1 if omitted
- Ex: board.ReadReg(0x00) will return the value in Register 0 for the local device

board.WriteReg(Register Address , Data) I2C Write Command

- Accepts both hex & decimal inputs
- Ex: board.WriteReg(0x01, 0x01) will set Register 0 to have a value of 1

board.devAddr = [I2C Address] Assigns I2C address to be used for board.ReadReg and board.WriteReg commands

- Accepts both hex & decimal inputs
- Uses the 8-bit form of the I2C address

- Can be used to shorten read/write commands
- Ex: board.devAddress = 0x60 sets the board address to 0x60

13.5.1.2 General I2C Reads/Writes:

These I2C commands will work for any I2C address on the local bus and remote devices configured in the target ID and target alias registers of the device. The 8-bit form of I2C addresses should be used.

board.ReadI2C(Device Address, I2C Read Command

Register Address , # of Bytes) OR

board.ReadI2C(Device Address, Register Address)

- Accepts both hex & decimal inputs
- Number of bytes will default to 1 if omitted
- Ex: board.ReadI2C(0x60, 0x00) will return the value in Register 0 for the device with address 0x60 (8-bit form)

board.WriteI2C(Device Address, I2C Write Command

Register Address , Data)

- Accepts both hex & decimal inputs
- Ex: board.WriteI2C(0x60, 0x01, 0x01) will set Register 1 of the device with address 0x60 (8-bit form) to have a value of 1

13.5.1.3 I2C Reads/Writes with Multi-Byte Register Addresses

These I2C commands will work for any I2C address on the local bus and remote devices configured in the target ID and target alias registers of the device. The 8-bit form of I2C addresses should be used.

board.ReadI2C(Device Address, I2C Read Command for devices with multi-byte register addresses

Register Address Byte 2,[Register

Address Byte 1, # of Bytes])

OR board.ReadI2C(Device Address,

Register Address Byte 2, [Register Address Byte 1])

- Accepts both hex & decimal inputs
- Number of bytes will default to 1 if omitted
- Ex: board.ReadI2C(0x60, 0x30, [0x00]) will return the value in Register 0x3000 for the device with address 0x60 (8-bit form)

board.WriteI2C(Device Address, I2C Write Command for devices with multi-byte register addresses

Register Address Byte 2, [Register

Address Byte 1, Data])

- Accepts both hex & decimal inputs
- Number of bytes will default to 1 if omitted
- Ex: board.WriteI2C(0x60, 0x30, [0x01, 0x01]) will set Register 0x3000 of the device with address 0x60 (8-bit form) to have a value of 1

13.6 GPIO Tab

Figure 13-14 shows the GPIO tab. This tab may be used to configure the DS90UB954-Q1 GPIO pins, including the configuration of back channel GPIOs, and FrameSync generation.

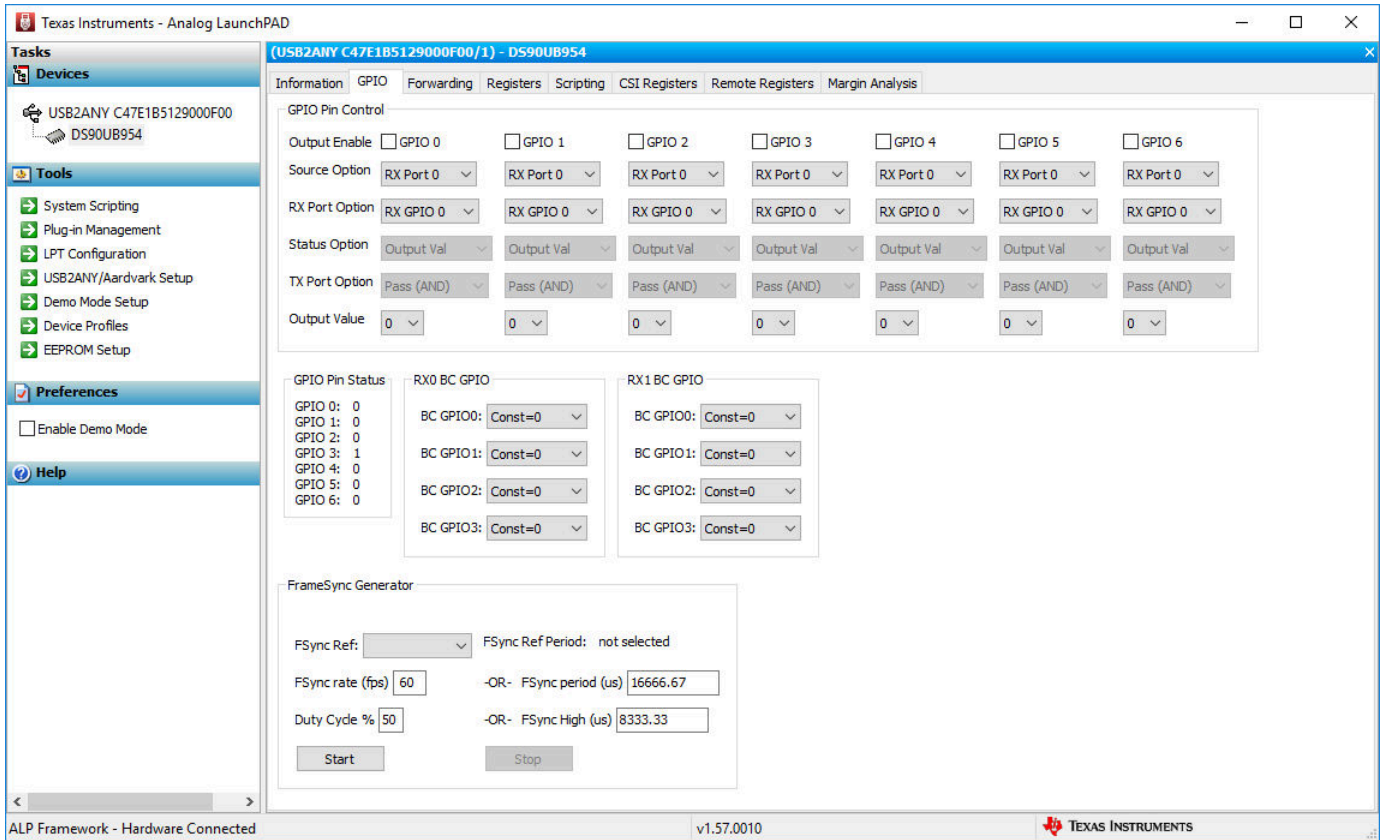

Figure 13-14. GPIO Tab

13.7 Forwarding Tab

Figure 13-15 shows the Forwarding tab. This tab may be used to configure the forwarding of CSI-2 data.

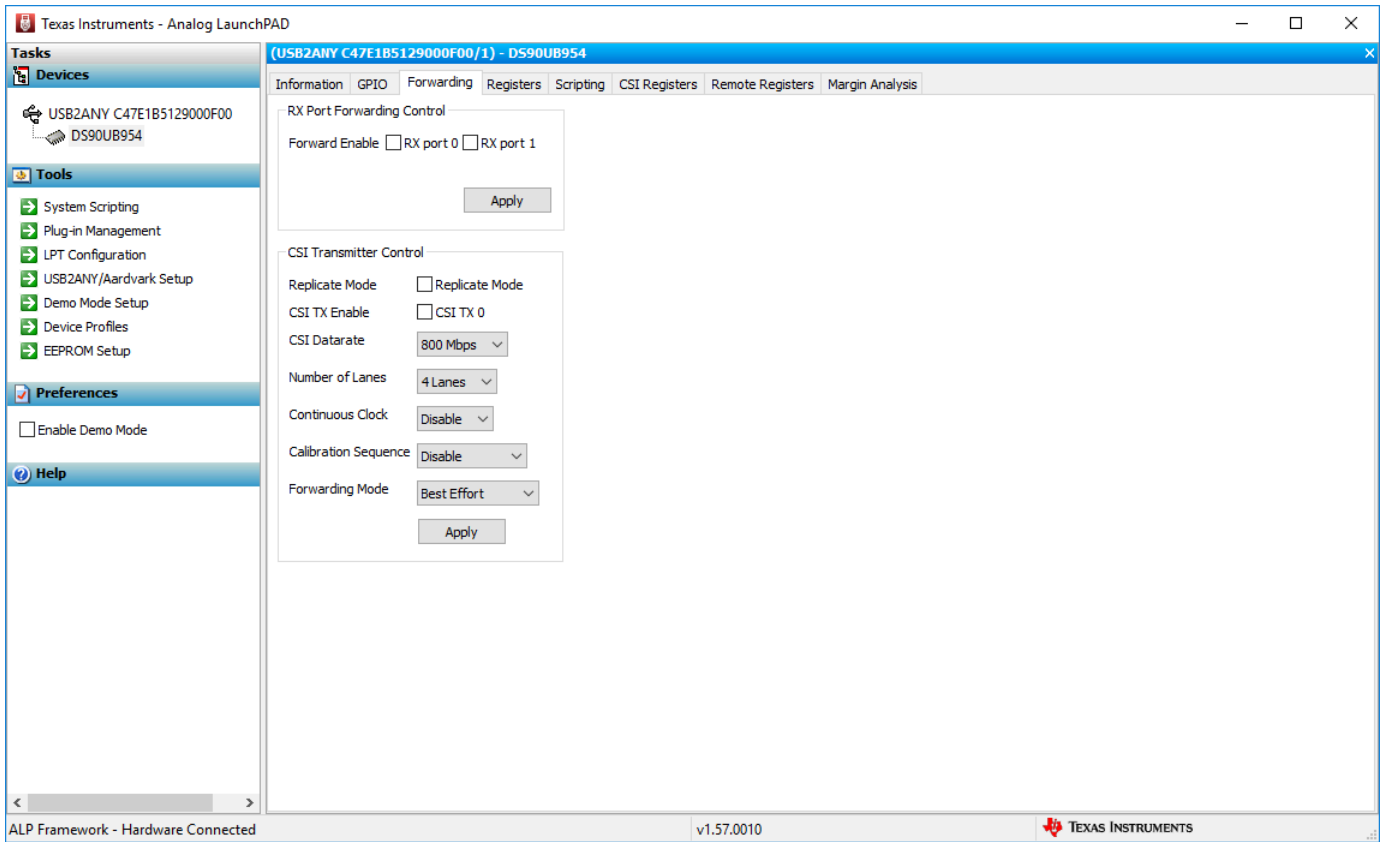

Figure 13-15. Forwarding Tab

13.8 CSI Registers Tab

Figure 13-16 shows the CSI Registers tab. This tab operates in the same way as the Registers tab, but holds the indirect access registers used to configure pattern generation.

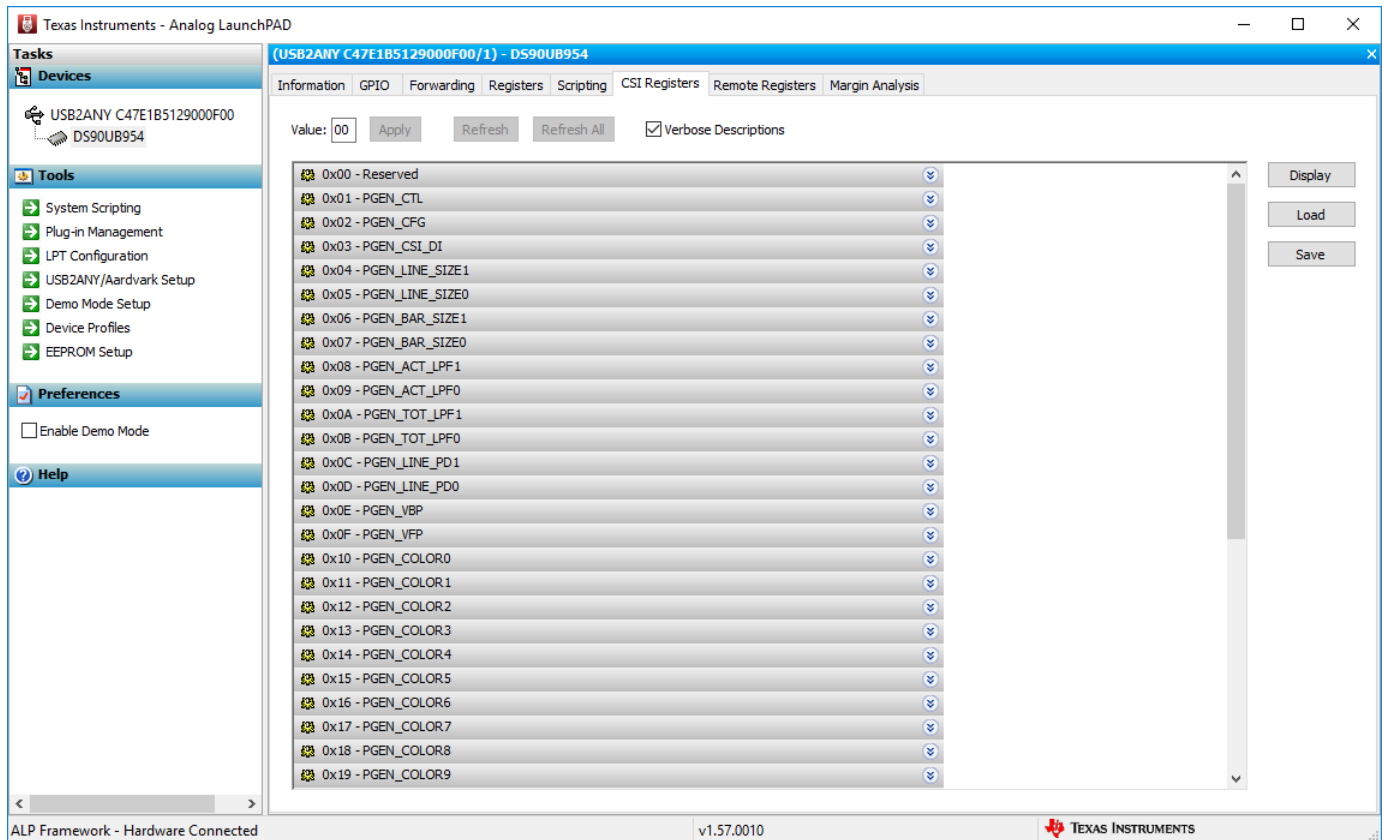

Figure 13-16. CSI Registers Tab

13.9 Remote Registers Tab

Figure 13-17 shows the Remote Registers tab. This tab may be used to read and write to the registers of the partner serializer. The RX Port selection drop-down controls which serializer is communicated with, the serializer connect to Port 0 or the serializer connected to Port 1.

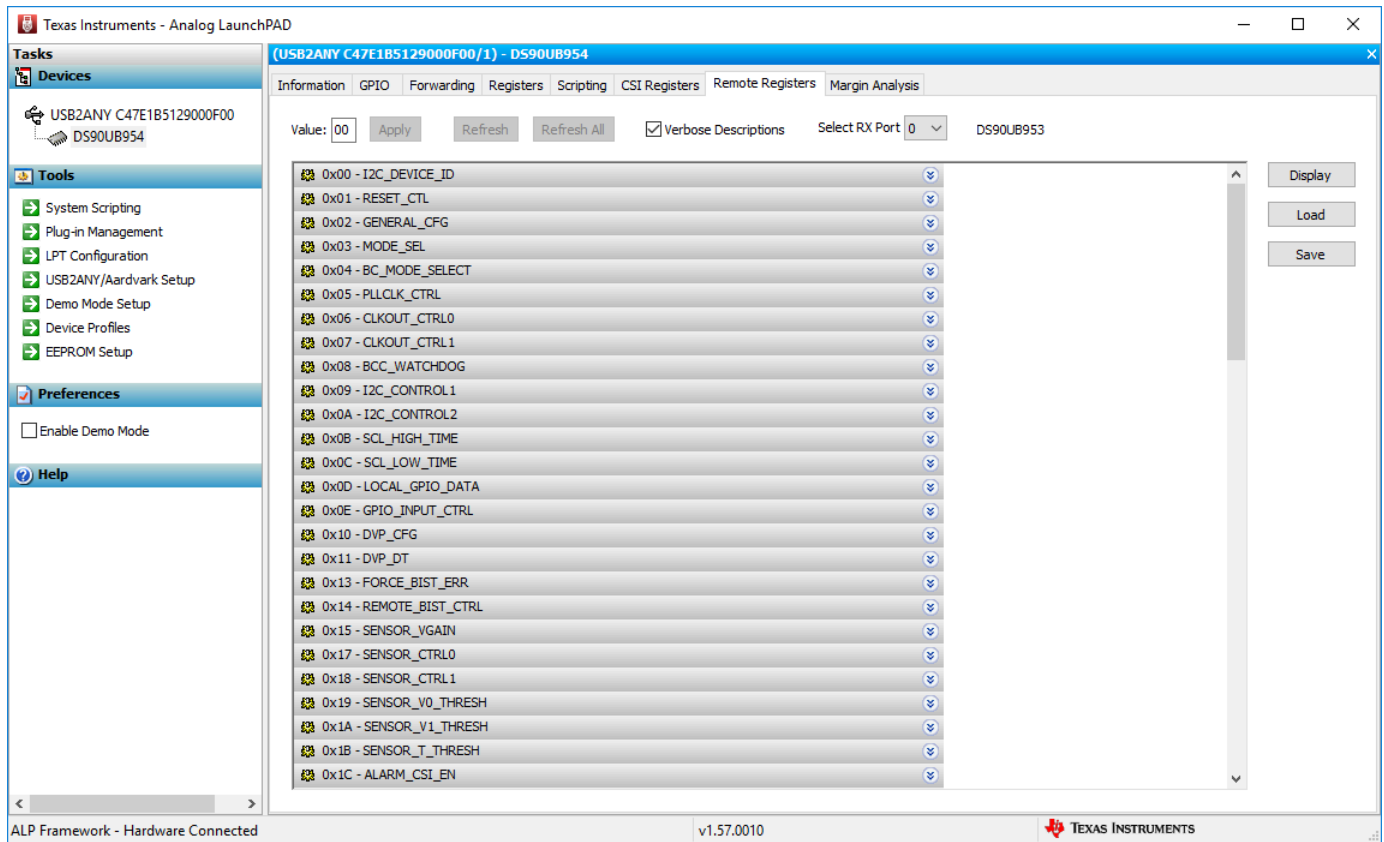

Figure 13-17. Remote Registers Tab

14 Troubleshooting ALP Software

14.1 ALP Does Not Detect The EVM

If the following window opens after starting the ALP software, double check the hardware setup.

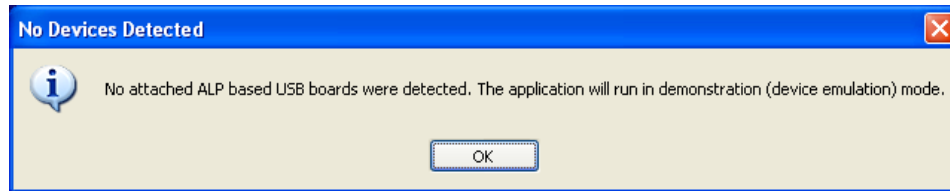

Figure 14-1. ALP No Devices Error

It may also be that the USB2ANY driver is not installed. Check the device manager. There should be a “HID-compliant device” under the “Human Interface Devices” as shown in [Figure 14-2](#).

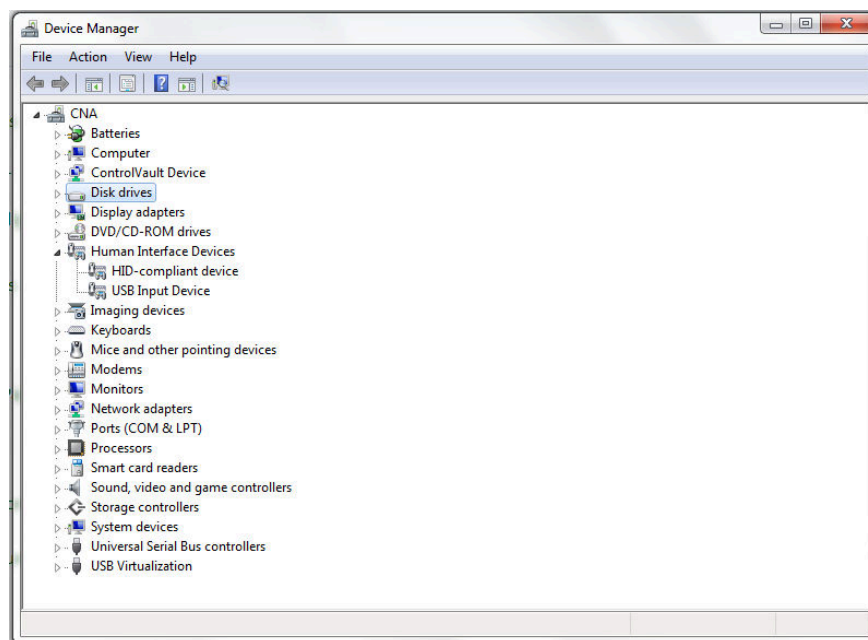

Figure 14-2. Windows 7, ALP USB2ANY Driver

The software should start with only “DS90UB954” in the “Devices” pull down menu. If there are more devices then the software is most likely in demo mode. When the ALP is operating in demo mode there is a “(Demo Mode)” indication in the lower left of the application status bar as shown in [Figure 14-3](#).

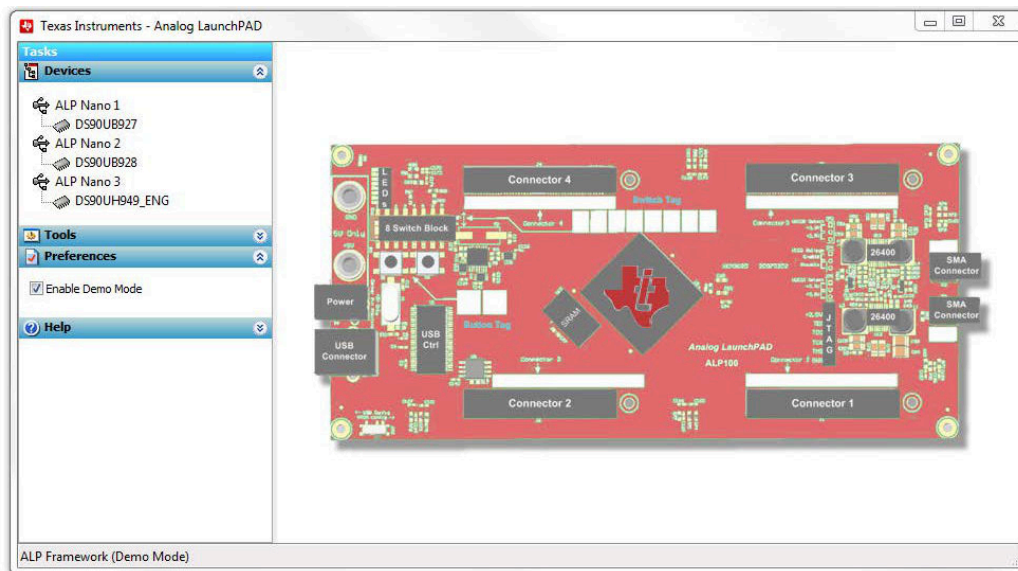

Figure 14-3. ALP in Demo Mode

Disable the demo mode by selecting the “Preferences” pull down menu and un-checking “Enable Demo Mode”.

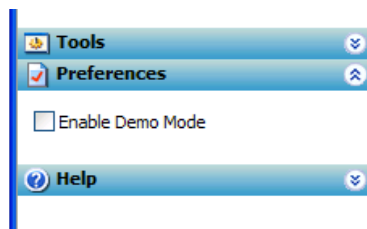

Figure 14-4. ALP Preferences Menu

After demo mode is disabled, the ALP software will poll the ALP hardware. The ALP software will update and have only “DS90UB954” under the “Devices” pull down menu.

14.2 USB2ANY Firmware Issues

If upon plugging in the board to the PC, the user is presented with a message stating USB2ANY firmware is out of date or is 0.0.0.0, similar to [Figure 14-5](#), try unplugging the USB cable and plugging it in again (holding S1 while plugging in the USB cable puts the USB2ANY into firmware update mode). If that does not solve the problem you will have to re-flash the on-board USB2ANY firmware. To re-flash the USB2ANY, download [USB2ANY Explorer](#) and install the application. Launch the USB2ANY Firmware Loader available at "C:\Program Files (x86)\TI USB2ANY SDK\bin\USB2ANY Firmware Loader.exe" and follow the instructions to flash the latest version of USB2ANY firmware. The firmware loading screen is shown in [Figure 14-6](#).

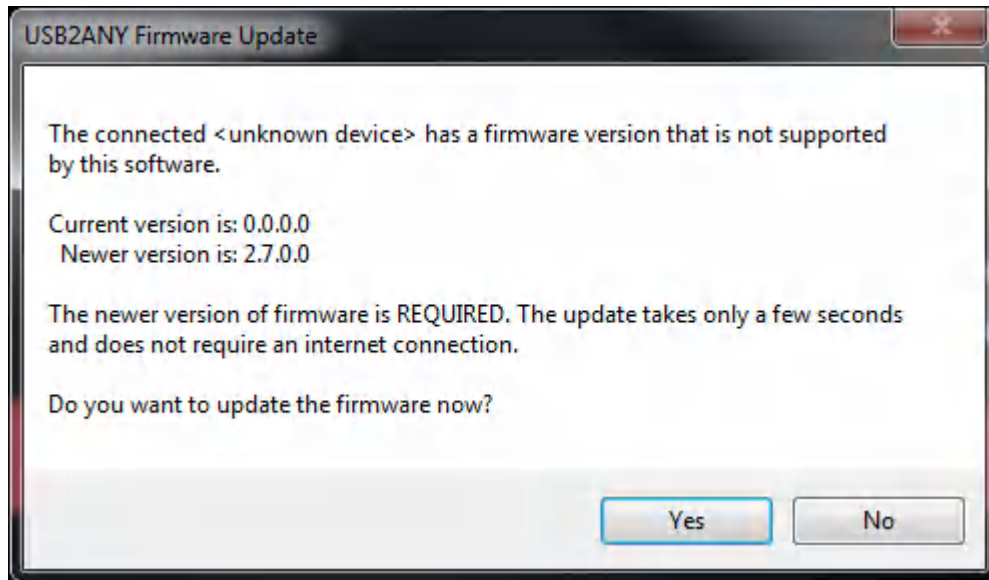

Figure 14-5. USB2ANY Firmware Update Notice

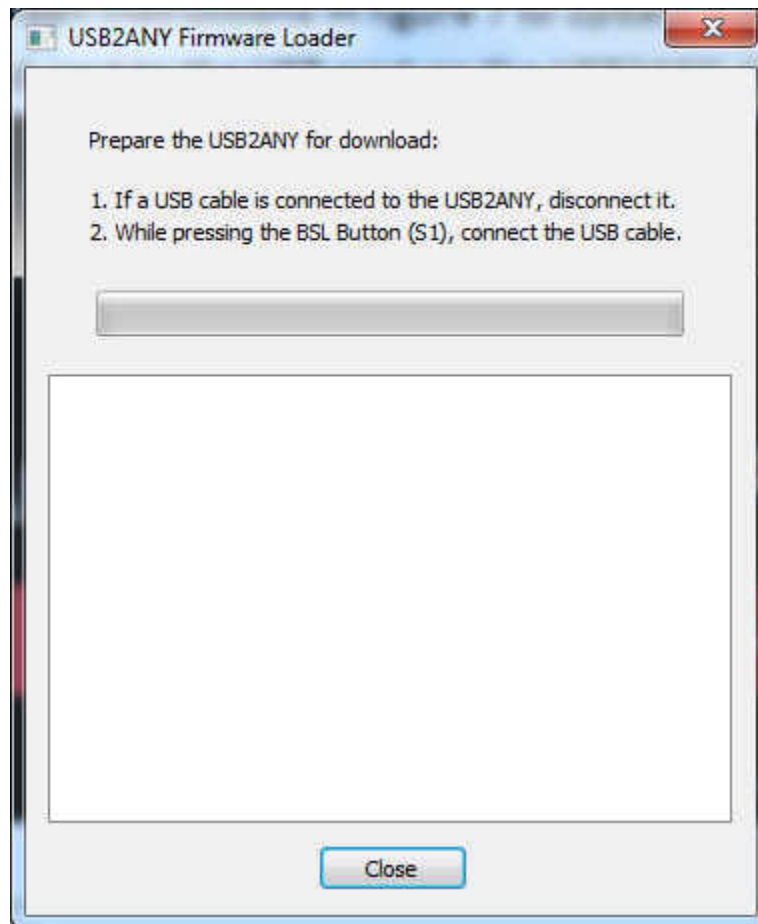

Figure 14-6. USB2ANY Firmware Update Procedure

15 DS90UB954-Q1EVM PCB Schematics, Layout and Bill of Materials - DS90UB954-Q1EVM Schematic

Revision History				
Rev	ECN #	Approved Date	Approved by	Notes
N/A	N/A	N/A	N/A	N/A

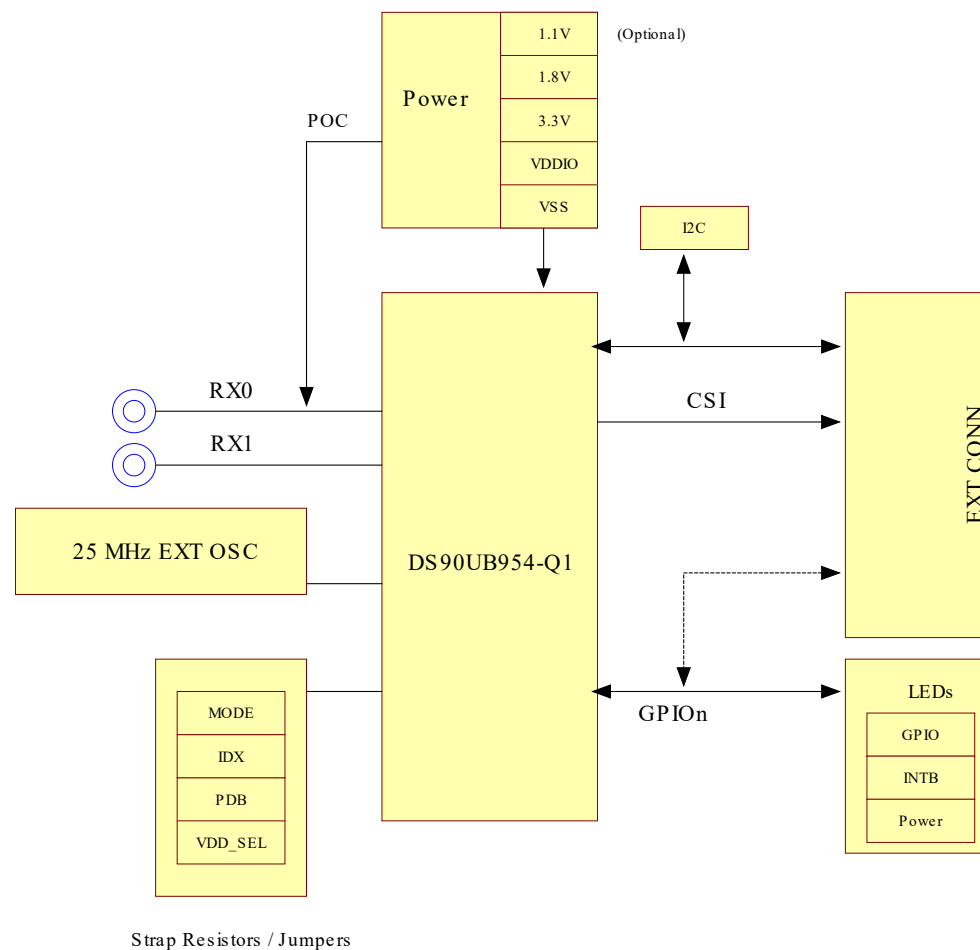

Figure 15-1. DS90UB954-Q1EVM Block Diagram

DS90UB954 Configuration

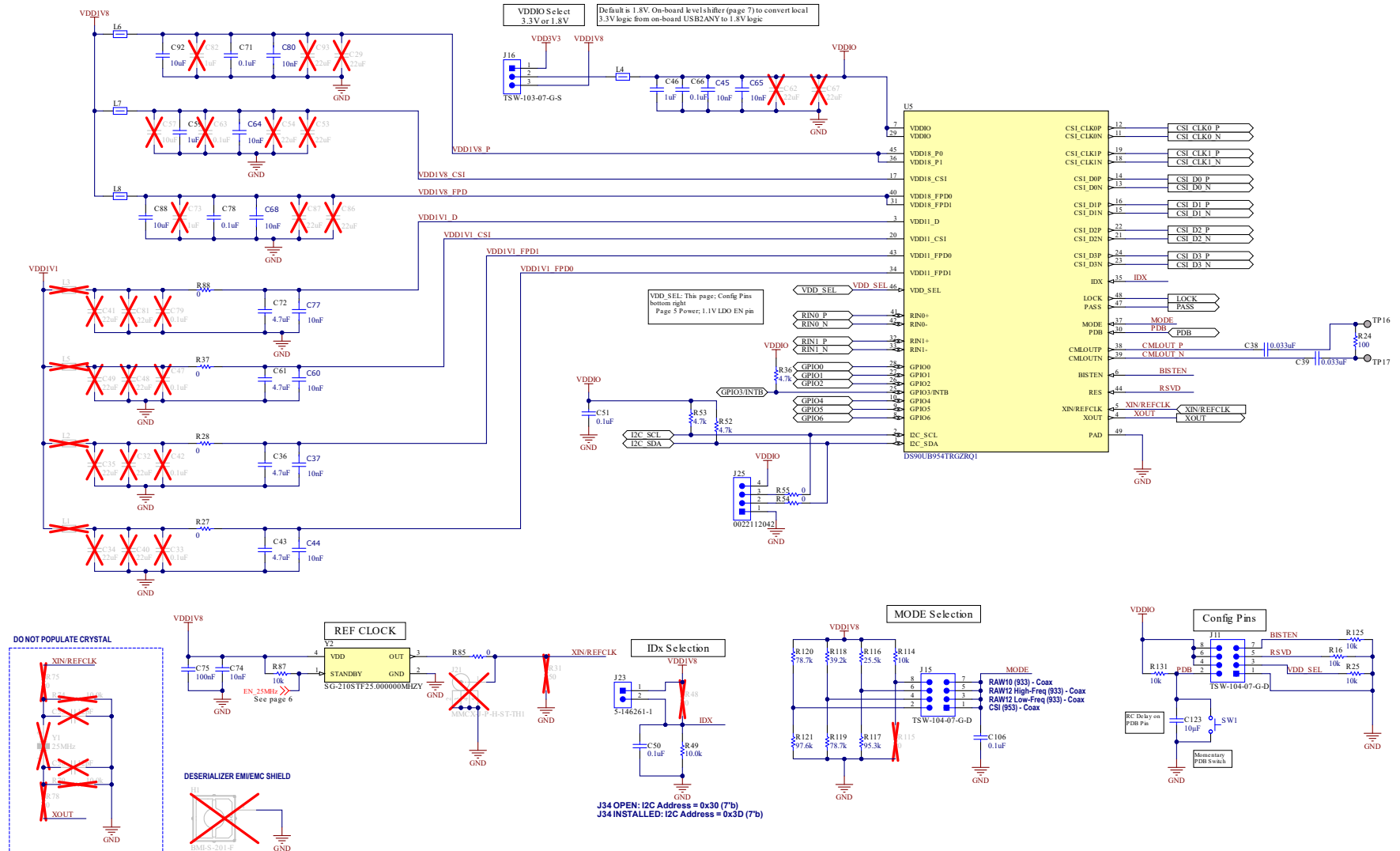

Figure 15-2. DS90UB954-Q1EVM Main Circuit - Page 1

MIPI CSI-2 Output Connectors

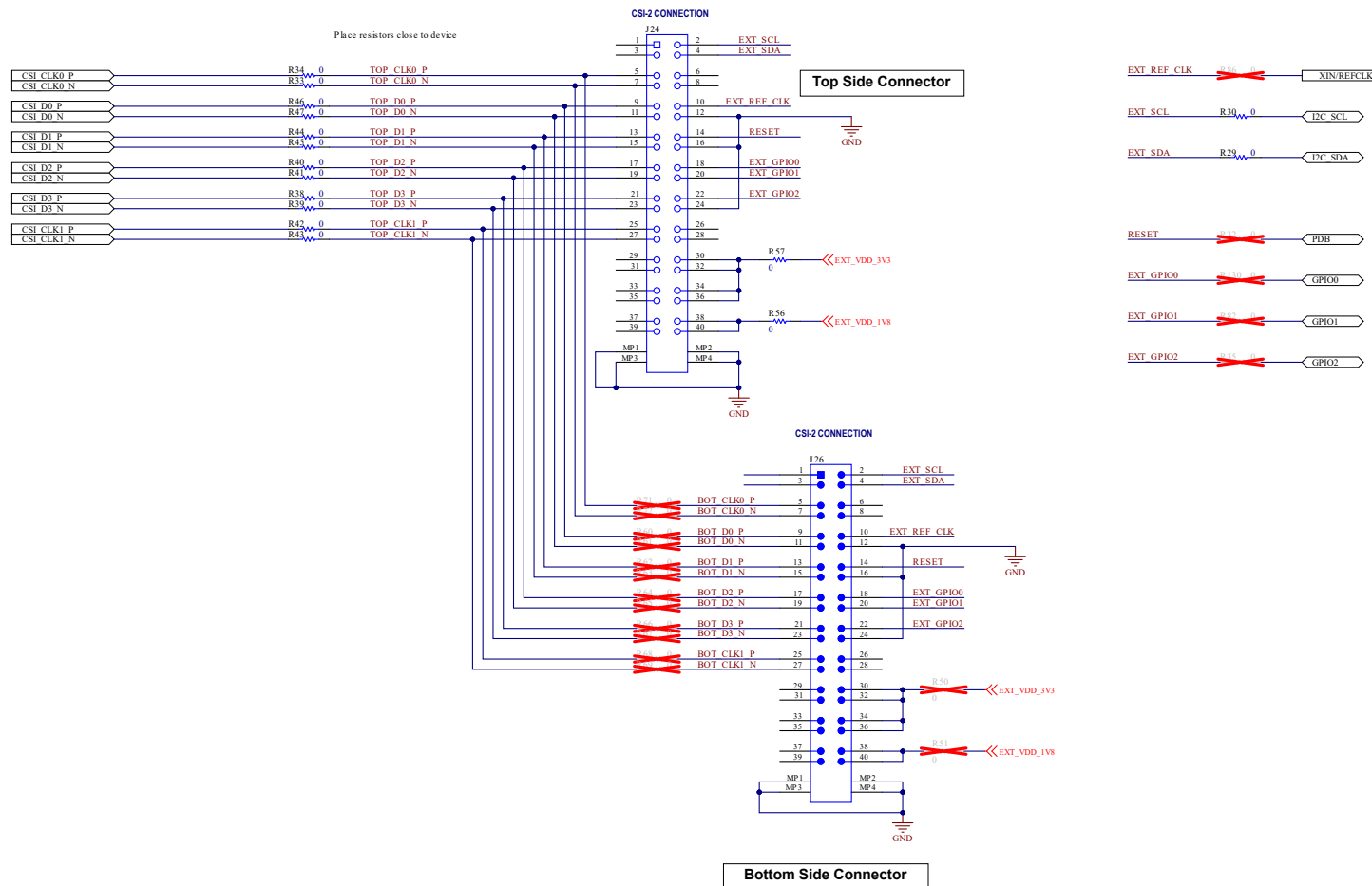

Figure 15-3. DS90UB954-Q1EVM CSI-2 Connectors - Page 2

Power over Coax (POC)

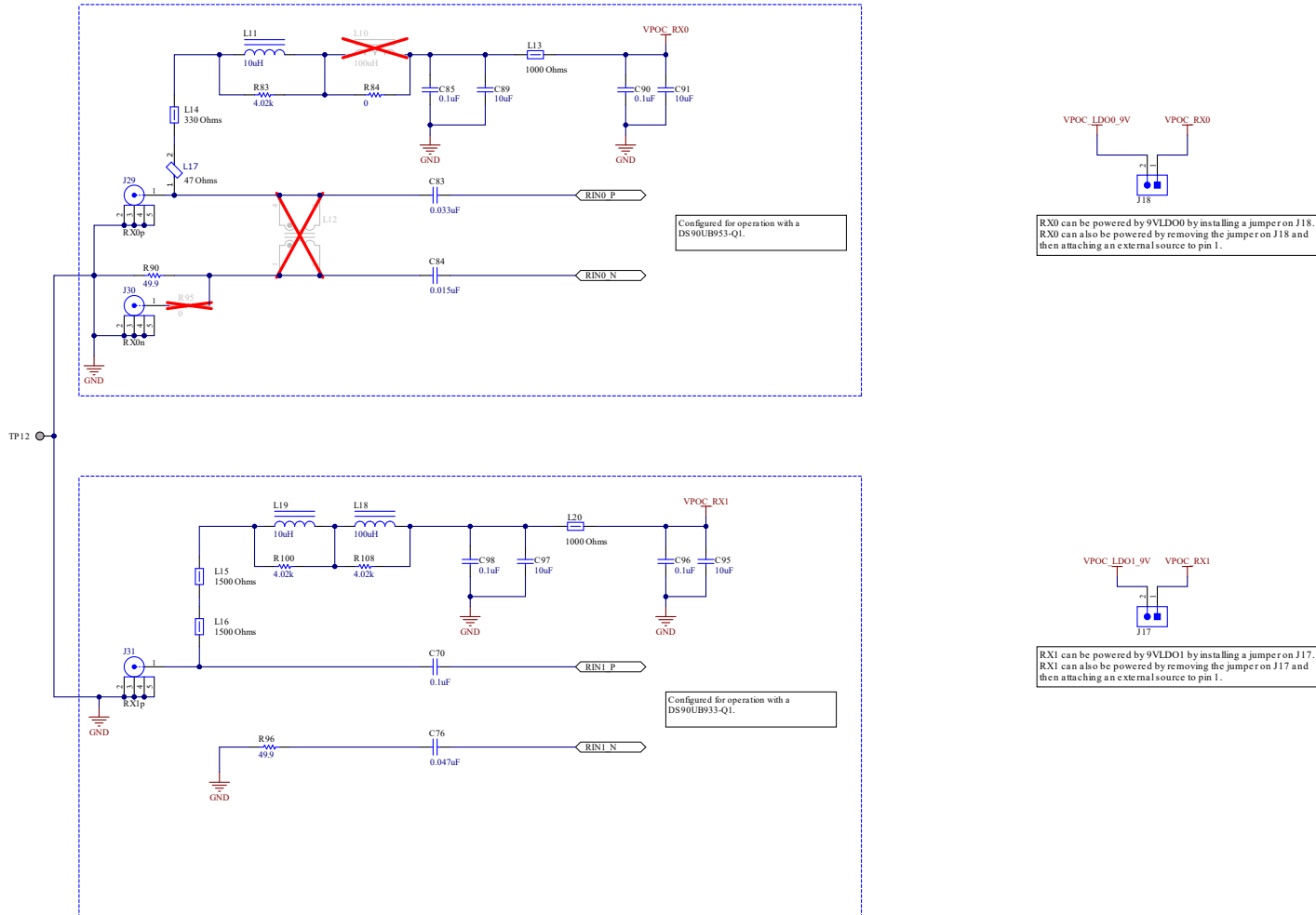
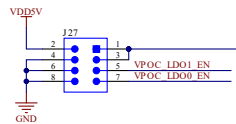
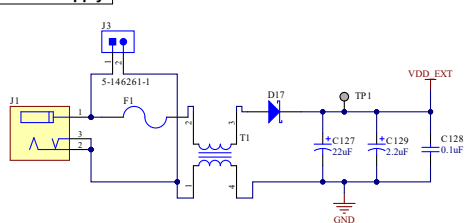

Figure 15-4. DS90UB954-Q1EVM PoC Circuits - Page 3

Power Distribution

12V External Supply



**3.3V @ 1A Linear Regulator
1.8V @ 1A Linear Regulator**

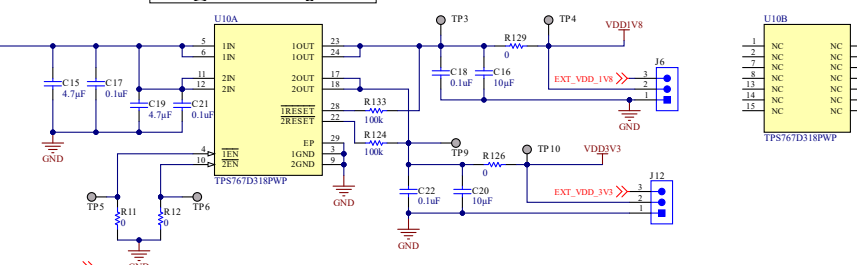

5V @ 2A Switching Regulator

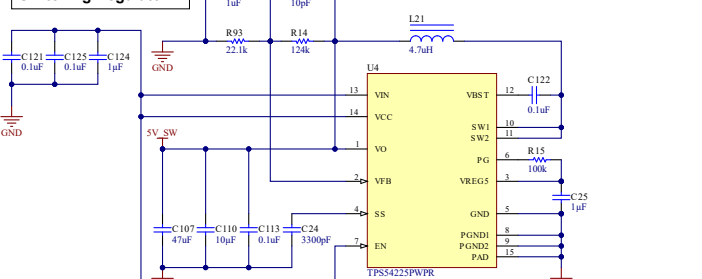

1.1V @ 1.5A Linear Regulator

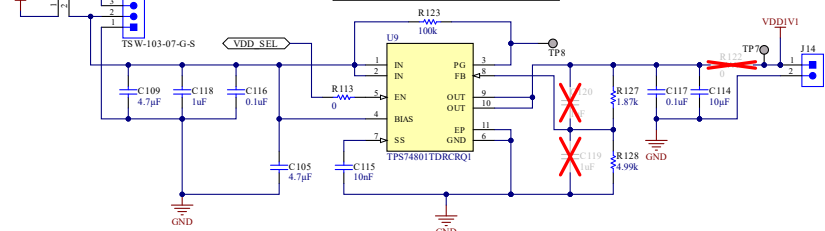

5V @ 1A Linear Regulator

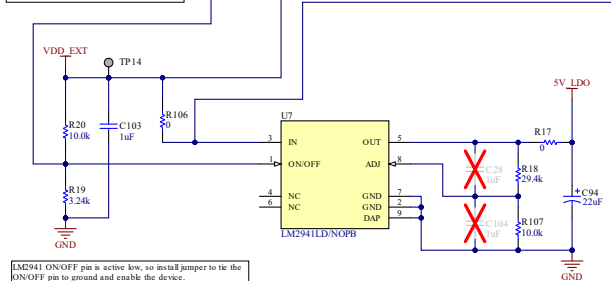

Select 5V Supply for VDD5V

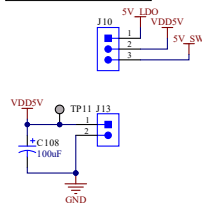

9V @ 1A Linear Regulator for PoC RX0

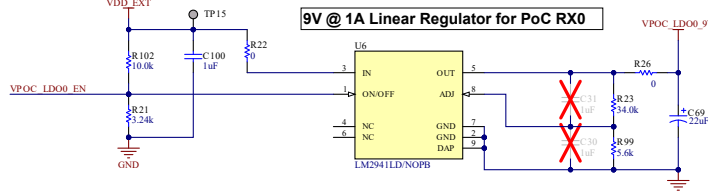

9V @ 1A Linear Regulator for PoC RX1

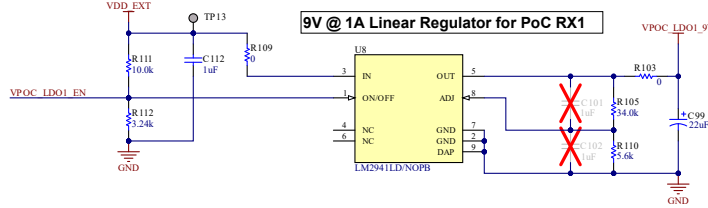

LM2941 ON/OFF pin is active low, so install jumper to tie the ON/OFF pin to ground and enable the device.

Figure 15-5. DS90UB954-Q1EVM Power Distribution Circuits - Page 4

LED Indicators and GPIO Header

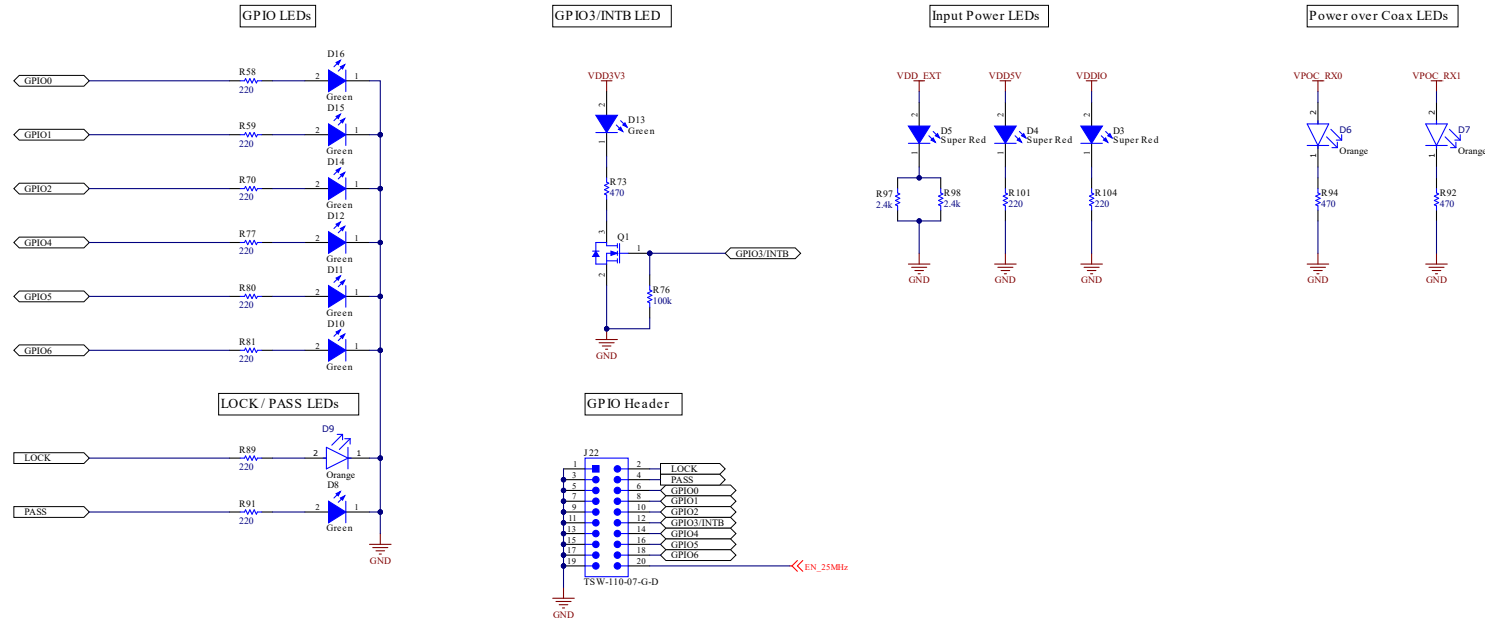

Figure 15-6. DS90UB954-Q1EVM LED Circuits - Page 5

On-Board USB2ANY

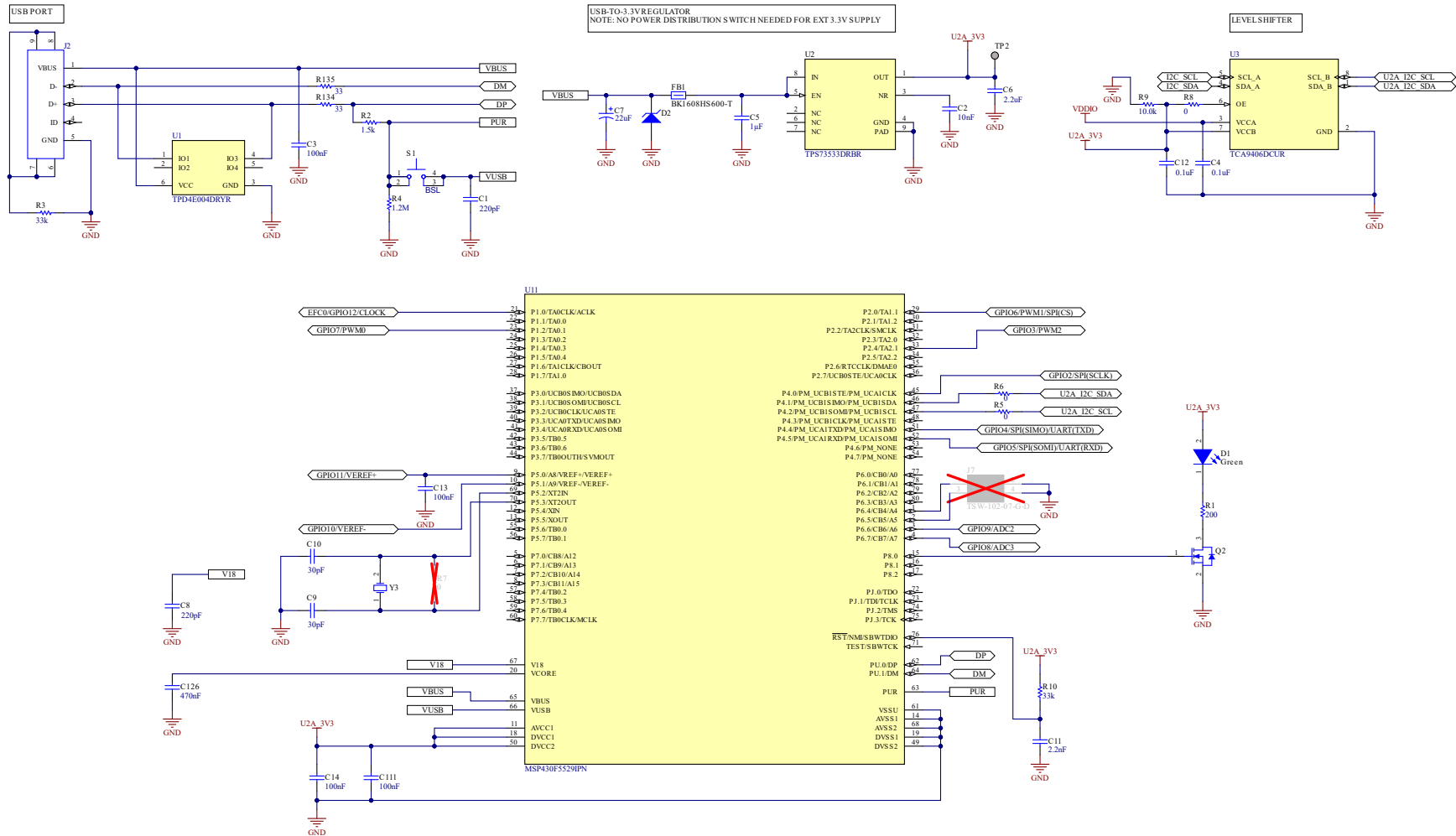

Figure 15-7. DS90UB954-Q1EVM USB2ANY Circuits - Page 6

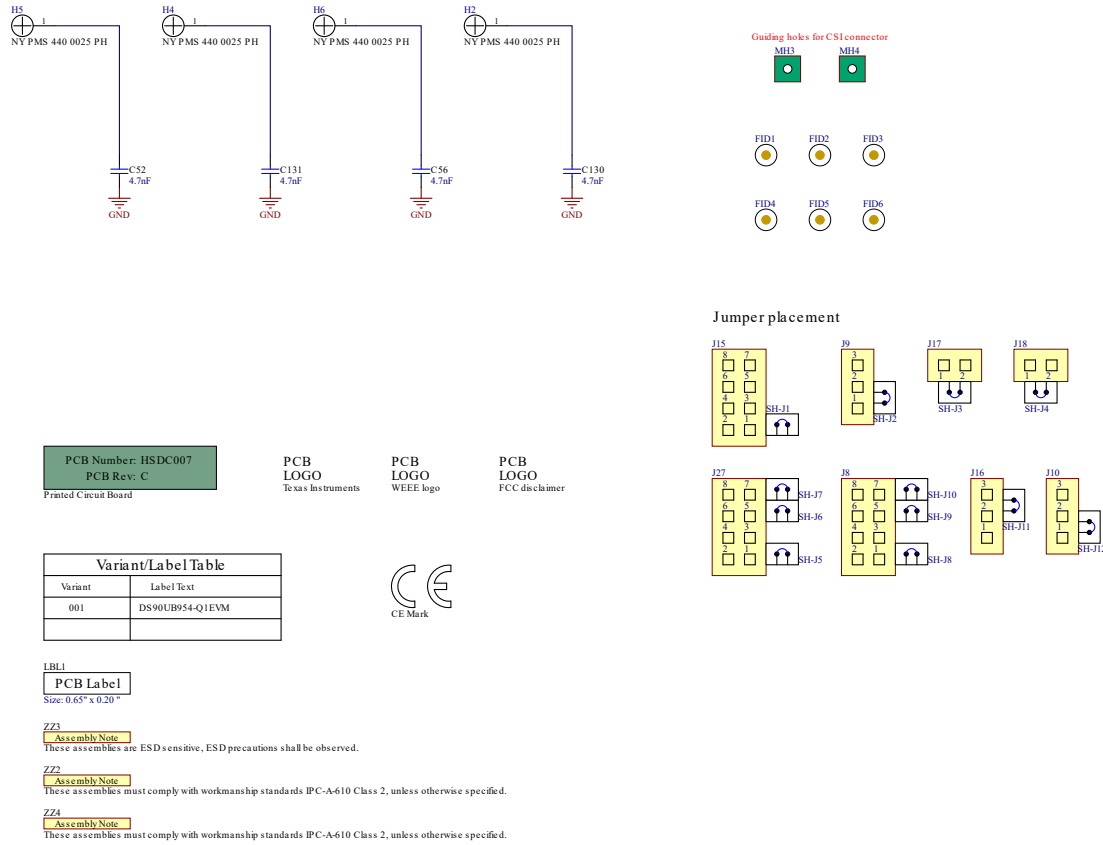

Figure 15-8. DS90UB954-Q1EVM Miscellaneous Hardware

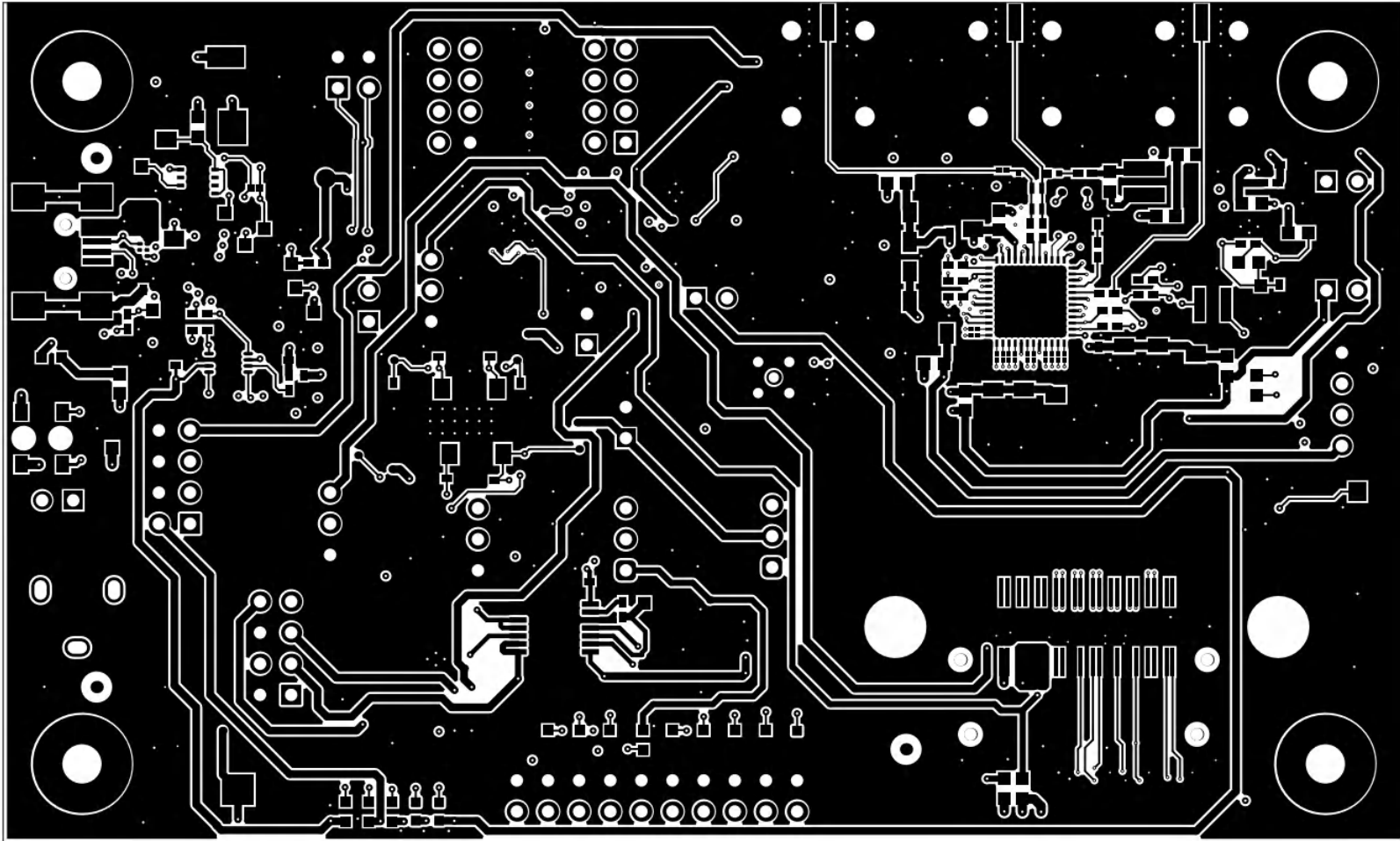

Figure 16-2. Layer 1: Top Signal Layer

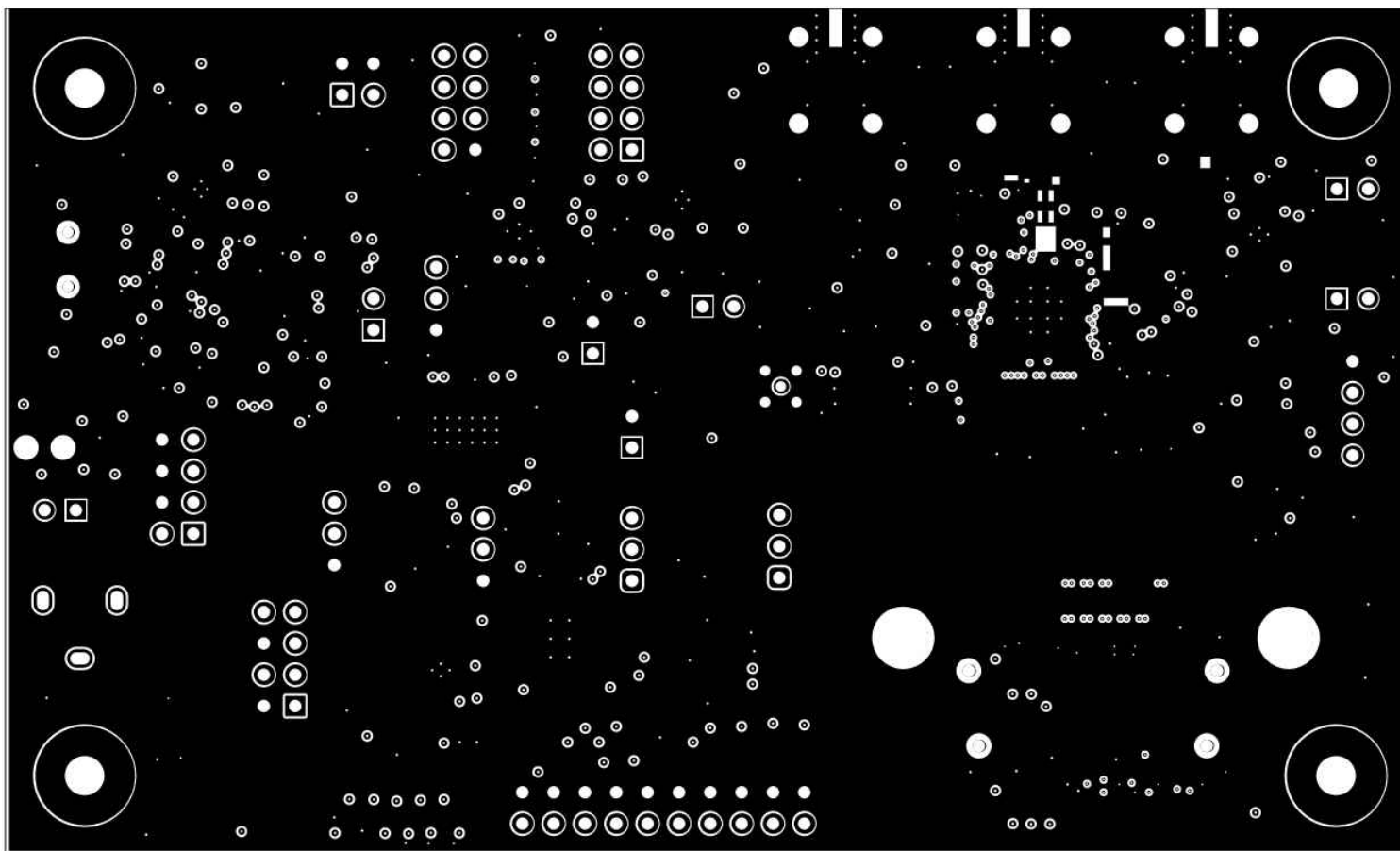

Figure 16-3. Layer 2: GND Plane 1

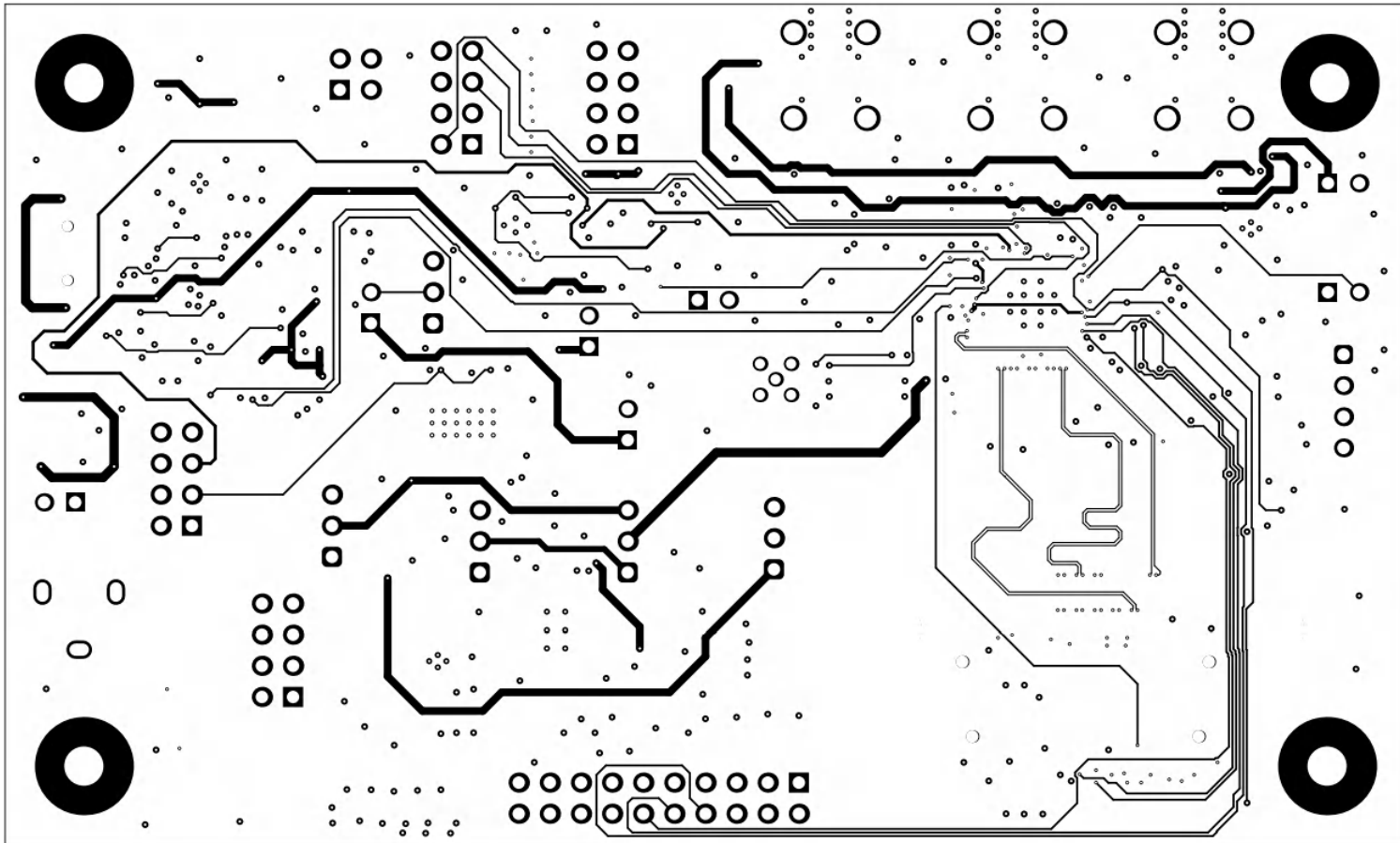

Figure 16-4. Layer 3: Mid Signal Layer 1

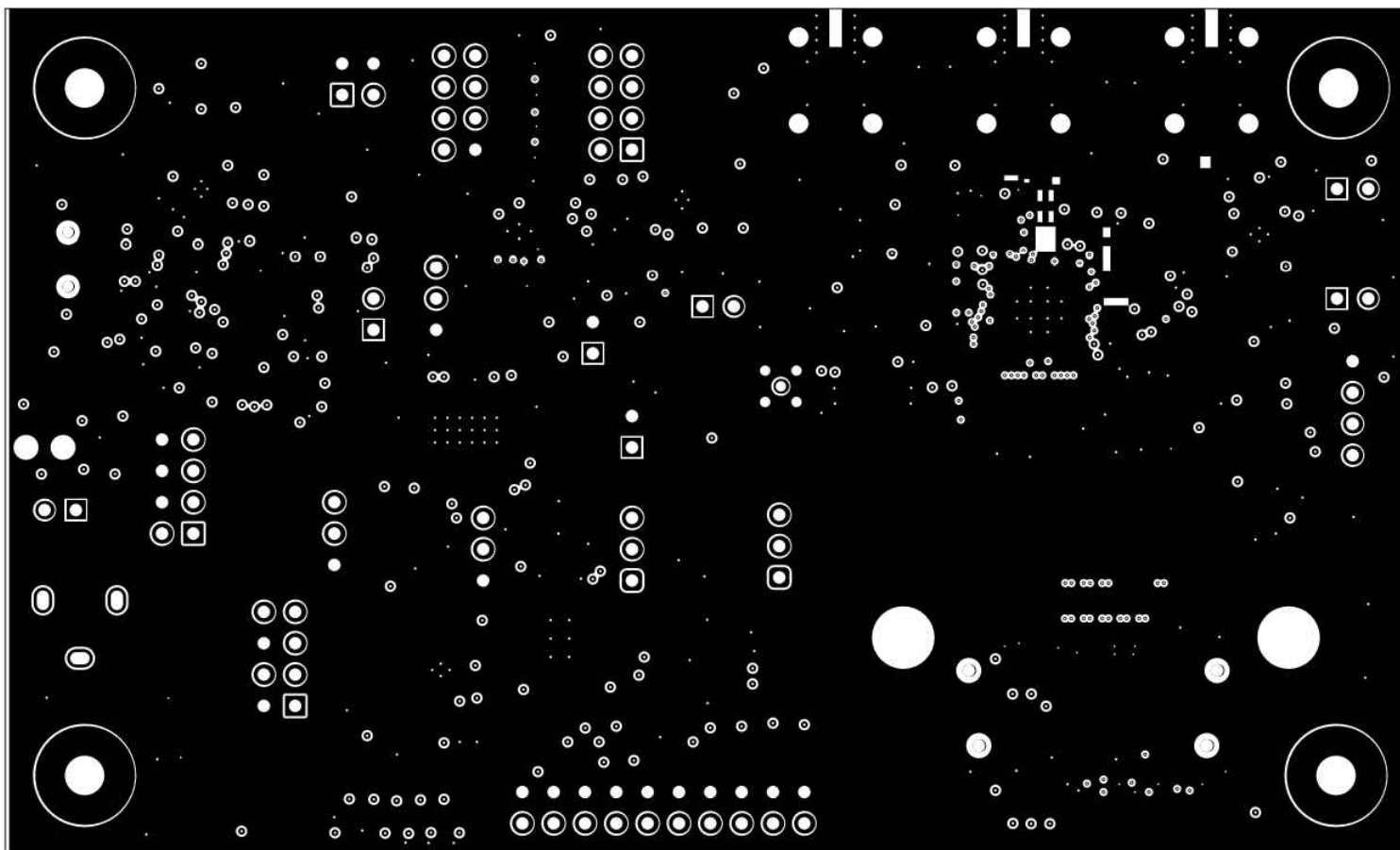

Figure 16-5. Layer 4: GND Plane 2

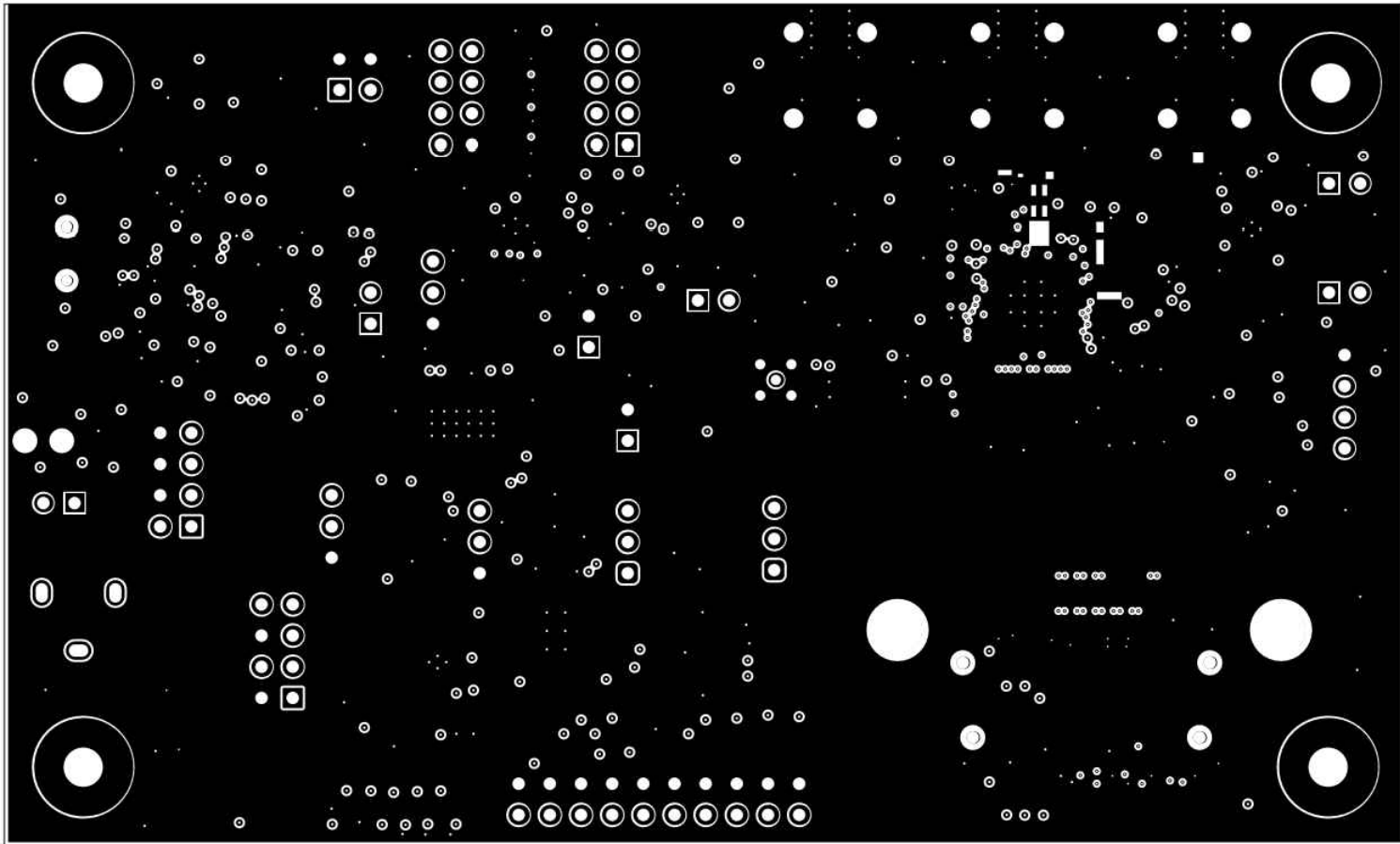

Figure 16-6. Layer 5: GND Plane 3

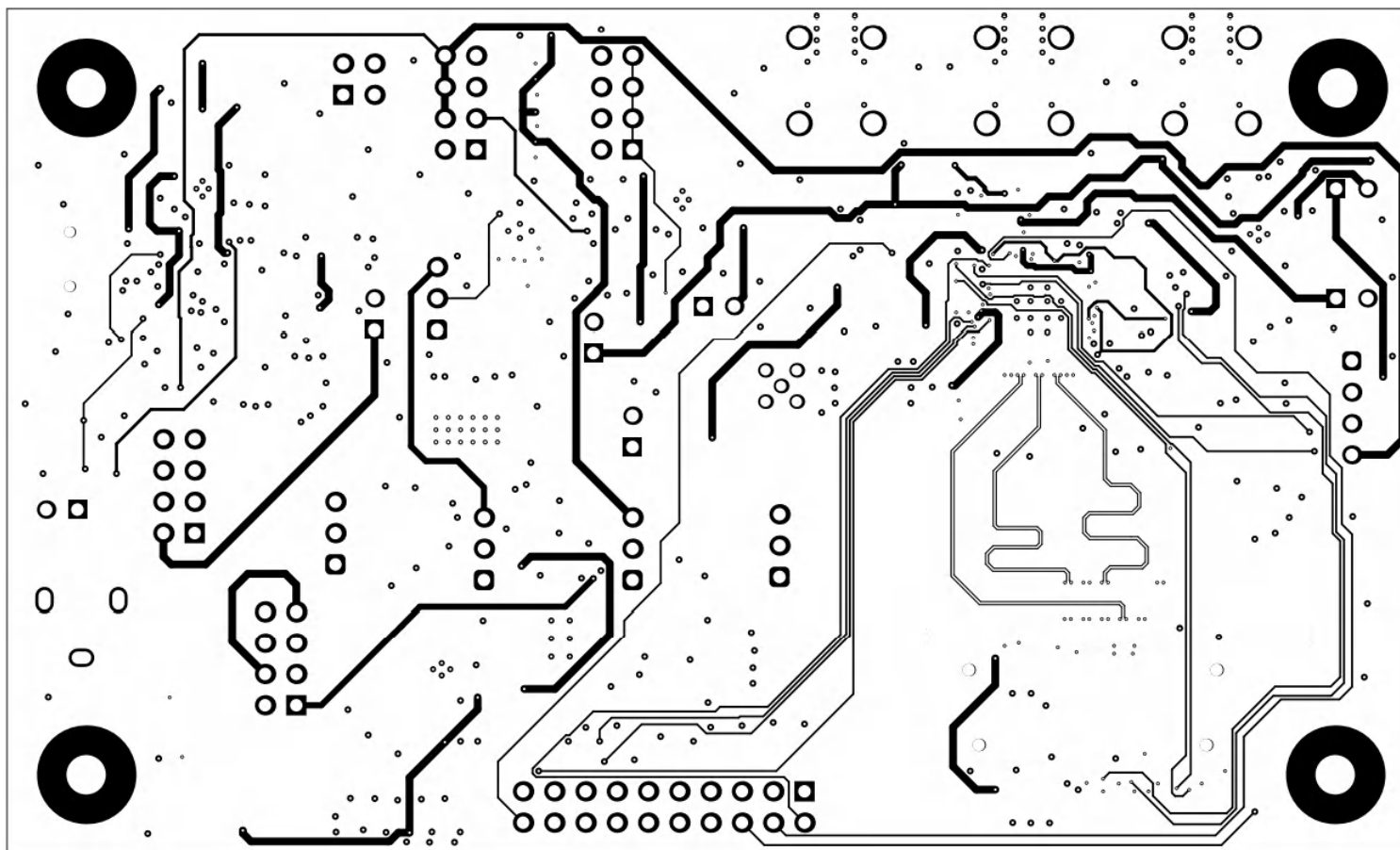

Figure 16-7. Layer 6: Mid Signal Layer 2

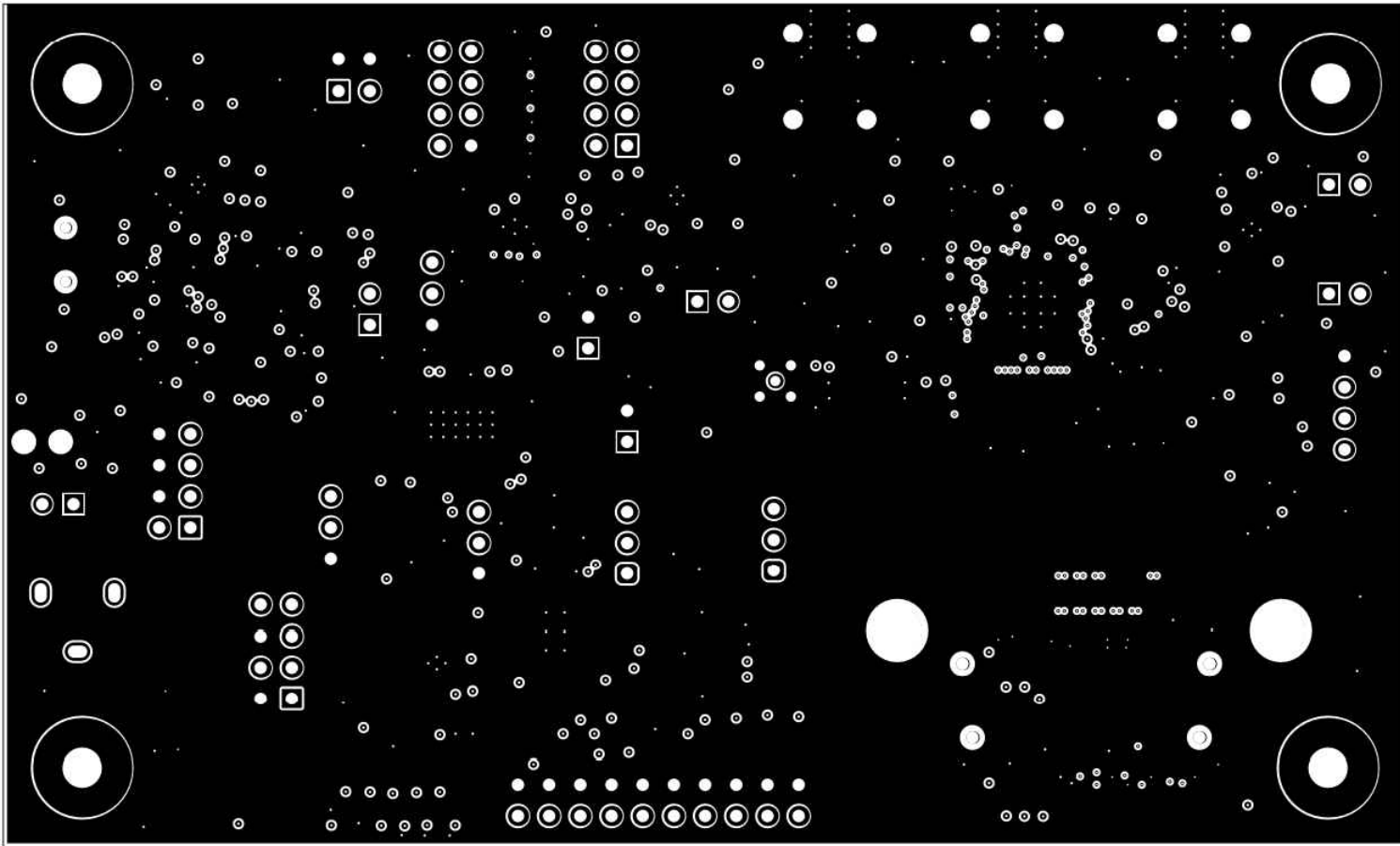

Figure 16-8. Layer 7: GND Plane 4

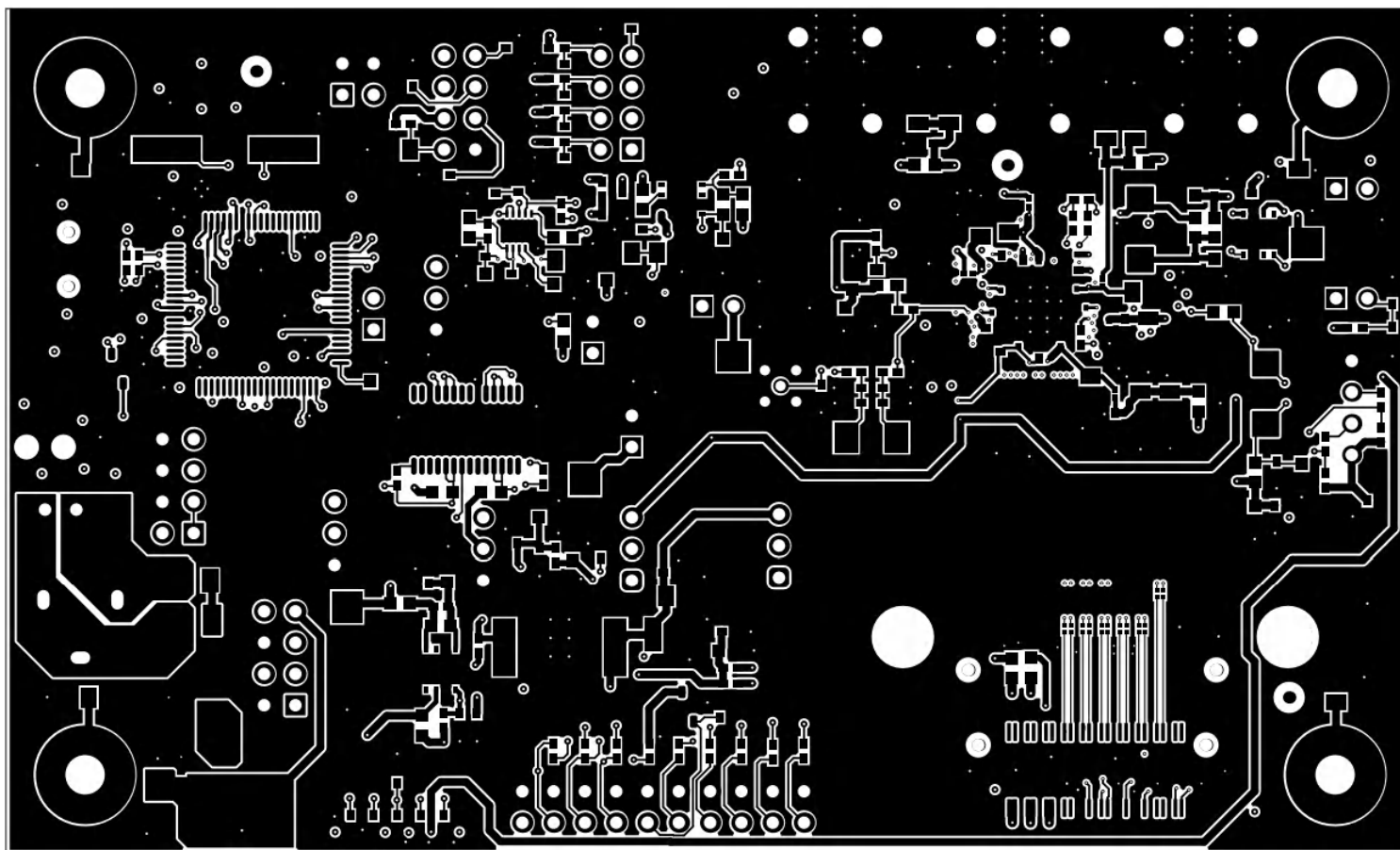

Figure 16-9. Layer 8: Bottom Signal Layer

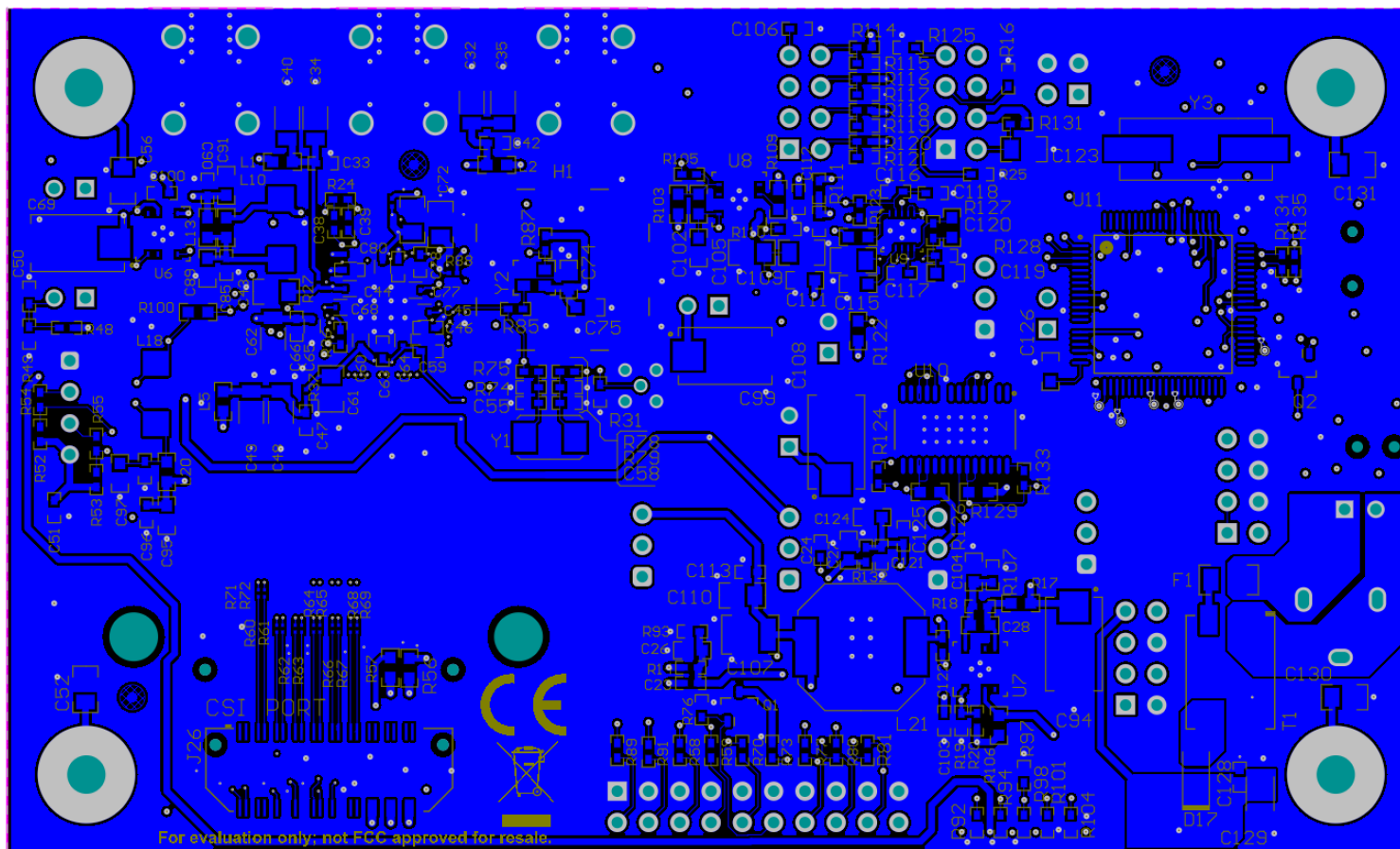

Figure 16-10. Bottom View Composite

17 DS90UB954-Q1EVM Bill of Materials

Table 17-1. DS90UB954-Q1EVM BOM

ITEM	QTY	DESIGNATOR	VALUE	PART NUMBER	MANUFACTURER	DESCRIPTION
1	1	!PCB1		HSDC007	Any	Printed Circuit Board
2	2	C1, C8	220pF	06035A221FAT2A	AVX	CAP, CERM, 220 pF, 50 V, +/- 1%, C0G/NPO, 0603
3	1	C2	0.01uF	C1608X7R1H103K080AA	TDK	CAP, CERM, 0.01 μF, 50 V, +/- 10%, X7R, 0603
4	5	C3, C13, C14, C75, C111	0.1uF	0603YC104JAT2A	AVX	CAP, CERM, 0.1 μF, 16 V, +/- 5%, X7R, 0603
5	14	C4, C12, C17, C18, C21, C22, C51, C113, C116, C117, C121, C122, C125, C128	0.1uF	GRM155R71C104KA88D	MuRata	CAP, CERM, 0.1 μF, 16 V, +/- 10%, X7R, 0402
6	1	C5	1uF	C0805C105K3RACTU	Kemet	CAP, CERM, 1 μF, 25 V, +/- 10%, X7R, 0805
7	1	C6	2.2uF	0805YD225KAT2A	AVX	CAP, CERM, 2.2 μF, 16 V, +/- 10%, X5R, 0805
8	1	C7	22uF	EMVE100ADA220ME55G	Chemi-Con	CAP ALUM 22 μF 10V 20% SMD
9	2	C9, C10	30pF	GRM1885C2A300JA01D	MuRata	CAP, CERM, 30 pF, 100 V, +/- 5%, C0G/NPO, 0603
10	1	C11	2200pF	C0603X222K5RACTU	Kemet	CAP, CERM, 2200 pF, 50 V, +/- 10%, X7R, 0603
11	4	C15, C19, C105, C109	4.7uF	GRM21BR71C475KA73L	MuRata	CAP, CERM, 4.7uF, 16V, +/-10%, X7R, 0805
12	5	C16, C20, C110, C114, C123	10uF	GRM21BR71A106KE51L	MuRata	CAP, CERM, 10uF, 10V, +/-10%, X7R, 0805
13	1	C23	10pF	GRM1555C1H100JA01D	MuRata	CAP, CERM, 10pF, 50V, +/-5%, C0G/NPO, 0402
14	1	C24	3300pF	GRM155R71H332KA01D	MuRata	CAP, CERM, 3300pF, 50V, +/-10%, X7R, 0402
15	2	C25, C124	1uF	GCM188R71C105KA64D	MuRata	CAP, CERM, 1 μF, 16 V, +/- 10%, X7R, AEC-Q200 Grade 1, 0603
16	1	C26	1uF	GRM185R61C105KE44D	MuRata	CAP, CERM, 1 μF, 16 V, +/- 10%, X5R, 0603
17	1	C27	10uF	GRM188R61E106MA73D	MuRata	CAP, CERM, 10 μF, 25 V, +/- 20%, X5R, 0603
18	4	C36, C43, C61, C72	4.7uF	C0805C475K3PACTU	Kemet	CAP, CERM, 4.7 μF, 25 V, +/- 10%, X5R, 0805
19	9	C37, C44, C45, C60, C64, C65, C68, C77, C80	0.01uF	GCM155R71H103KA55D	MuRata	CAP, CERM, 0.01uF, 50V, +/-10%, C0G/NPO, 0402
20	3	C38, C39, C83	0.033uF	CGA2B3X7R1H333K050BB	TDK	CAP, CERM, 0.033 μF, 50 V, +/- 10%, X7R, AEC-Q200 Grade 1, 0402
21	6	C46, C59, C100, C103, C112, C118	1uF	C1005JB1V105K050BC	TDK	CAP, CERM, 1 μF, 35 V, +/- 10%, JB, 0402
22	2	C50, C106	0.1uF	C1005X5R1H104K050BB	TDK	CAP, CERM, 0.1 μF, 50 V, +/- 10%, X5R, 0402
23	4	C52, C56, C130, C131	4700pF	08051C472KAT2A	AVX	CAP, CERM, 4700 pF, 100 V, +/- 10%, X7R, 0805
24	3	C66, C71, C78	0.1uF	CGA2B3X7R1H104K050BB	TDK	CAP, CERM, 0.1 uF, 50 V, +/- 10%, X7R, AEC-Q200 Grade 1, 0402
25	4	C69, C94, C99, C127	22uF	293D226X0025D2TE3	Vishay-Sprague	CAP, TA, 22uF, 25V, +/-20%, 0.7 ohm, SMD

Table 17-1. DS90UB954-Q1EVM BOM (continued)

ITEM	QTY	DESIGNATOR	VALUE	PART NUMBER	MANUFACTURER	DESCRIPTION
26	5	C70, C85, C90, C96, C98	0.1uF	C1005X7R1H104K050BB	TDK	CAP, CERM, 0.1 μ F, 50 V, +/- 10%, X7R, 0402
27	1	C74	0.01uF	06031C103KAT2A	AVX	CAP, CERM, 0.01 μ F, 100 V, +/- 10%, X7R, 0603
28	1	C76	0.047uF	C1005X7R1H473K050BB	TDK	CAP, CERM, 0.047 μ F, 50 V, +/- 10%, X7R, 0402
29	1	C84	0.015uF	CGA2B3X7R1H153K050BB	TDK	CAP, CERM, 0.015 μ F, 50 V, +/- 10%, X7R, AEC-Q200 Grade 1, 0402
30	2	C88, C92	10uF	CL21A106KAFN3NE	Samsung	CAP, CERM, 10 μ F, 25 V, +/- 10%, X5R, 0805
31	4	C89, C91, C95, C97	10uF	C1608X5R1E106M080AC	TDK	CAP, CERM, 10 μ F, 25 V, +/- 20%, X5R, 0603
32	1	C107	47uF	GRM32ER61C476ME15L	MuRata	CAP, CERM, 47uF, 16V, +/-20%, X5R, 1210
33	1	C108	100uF	T495D107M016ATE100	Kemet	CAP, TA, 100uF, 16V, +/-20%, 0.1 ohm, SMD
34	1	C115	0.01uF	06031C103JAT2A	AVX	CAP, CERM, 0.01uF, 100V, +/-5%, X7R, 0603
35	1	C126	0.47uF	GRM188R71A474KA61D	MuRata	CAP, CERM, 0.47 μ F, 10 V, +/- 10%, X7R, 0603
36	1	C129	2.2uF	293D225X9025A2TE3	Vishay-Sprague	CAP, TA, 2.2uF, 25V, +/-10%, 6.3 ohm, SMD
37	9	D1, D8, D10, D11, D12, D13, D14, D15, D16	Green	150060VS75000	Würth Elektronik eiSos	LED, Green, SMD
38	1	D2	7.5V	1SMB5922BT3G	ON Semiconductor	Diode, Zener, 7.5 V, 550 mW, SMB
39	3	D3, D4, D5	Super Red	150060SS75000	Würth Elektronik eiSos	LED, Super Red, SMD
40	3	D6, D7, D9	Orange	LTST-C190KFKT	Lite-On	LED, Orange, SMD
41	1	D17	40V	1N5819HW-7-F	Diodes Inc.	Diode, Schottky, 40V, 1A, SOD-123
42	1	F1		0440002.WR	Littelfuse	Fuse, 2 A, 32 V, SMD
43	1	FB1	60 ohm	BK1608HS600-T	Taiyo Yuden	Ferrite Bead, 60 ohm @ 100 MHz, 0.8 A, 0603
44	6	FID1, FID2, FID3, FID4, FID5, FID6		N/A	N/A	Fiducial mark. There is nothing to buy or mount.
45	4	H2, H4, H5, H6		NY PMS 440 0025 PH	BF Fastener Supply	Machine Screw, Round, 4-40 x 1/4, Nylon, Philips panhead
46	1	J1		PJ-102A	CUI Inc.	Connector, DC Jack 2.1X5.5 mm, TH
47	1	J2		1734035-2	TE Connectivity	Connector, Receptacle, Mini-USB Type B, R/A, Top Mount SMT
48	7	J3, J13, J14, J17, J18, J23, J28		5-146261-1	TE Connectivity	Header, 100mil, 2x1, Gold plated, TH
49	5	J6, J9, J10, J12, J16		TSW-103-07-G-S	Samtec, Inc.	Header, TH, 100mil, 3x1, Gold plated, 230 mil above insulator
50	4	J8, J11, J15, J27		TSW-104-07-G-D	Samtec	Header, 100mil, 4x2, Gold, TH
51	1	J22		TSW-110-07-G-D	Samtec	Header, 100mil, 10x2, Gold, TH
52	1	J24		QSH-020-01-H-D-DP-A	Samtec	Receptacle, Differential, 0.5mm, 10 pair x2, Gold, SMT
53	1	J25		0022112042	Molex	Header, 100mil, 4x1, White, TH
54	1	J26		QTH-020-04-L-D-DP-A	Samtec	Header(shrouded), 0.5mm, 10 pair x 2, Gold, SMT

Table 17-1. DS90UB954-Q1EVM BOM (continued)

ITEM	QTY	DESIGNATOR	VALUE	PART NUMBER	MANUFACTURER	DESCRIPTION
55	3	J29, J30, J31		59S20X-40ML5-Z	Rosenberger	Connector, RF, 50 Ohm, R/A, TH
56	4	L4, L6, L7, L8	120 ohm	BLM18SG121TN1D	MuRata	Ferrite Bead, 120 ohm @ 100 MHz, 3 A, 0603
57	1	L11	10uH	LQH3NPN100NG0	MuRata	Inductor, Wirewound, Ferrite, 10 µH, 0.5 A, 0.57 ohm, SMD
58	2	L13, L20	1000 ohm	BLM18AG102SN1D	MuRata	Ferrite Bead, 1000 ohm @ 100 MHz, 0.4 A, 0603
59	1	L14	330 ohm	MPZ1005S331ETD25	TDK	Ferrite Bead, 330 ohm @ 100 MHz, 0.7 A, 0402
60	2	L15, L16	1500 ohm	BLM18HE152SN1D	MuRata	Ferrite Bead, 1500 ohm @ 100 MHz, 0.5 A, 0603
61	1	L17	47 ohm	MPZ1005F470ETD25	TDK	Ferrite Bead, 47 ohm @ 100 MHz, 0.45 A, 0402
62	1	L18	100uH	CLF6045NIT-101M-D	TDK	Inductor, Wirewound, Ferrite, 100 µH, 0.61 A, 0.32 ohm, AEC-Q200 Grade 0, SMD
63	1	L19	10uH	LQH3NPN100MJRL	MuRata	Inductor, Wirewound, Ferrite, 10 µH, 0.81 A, 0.24 ohm, SMD
64	1	L21	4.7uH	7440650047	Würth Elektronik	Inductor, Shielded Drum Core, Ferrite, 4.7 µH, 4.2 A, 0.02 ohm, SMD
65	1	LBL1		THT-14-423-10	Brady	Thermal Transfer Printable Labels, 0.650" W x 0.200" H - 10,000 per roll
66	2	Q1, Q2	50V	BSS138	Fairchild Semiconductor	MOSFET, N-CH, 50 V, 0.22 A, SOT-23
67	1	R1	200	CRCW0603200RFKEA	Vishay-Dale	RES, 200, 1%, 0.1 W, 0603
68	1	R2	1.5k	CRCW04021K50JNED	Vishay-Dale	RES, 1.5k ohm, 5%, 0.063W, 0402
69	2	R3, R10	33k	CRCW040233K0JNED	Vishay-Dale	RES, 33k ohm, 5%, 0.063W, 0402
70	1	R4	1.2Meg	CRCW06031M20JNEA	Vishay-Dale	RES, 1.2 M, 5%, 0.1 W, 0603
71	10	R5, R6, R8, R11, R12, R29, R30, R54, R55, R85	0	ERJ-2GE0R00X	Panasonic	RES, 0, 5%, 0.1 W, AEC-Q200 Grade 0, 0402
72	6	R9, R20, R102, R107, R111, R132	10.0k	CRCW040210K0FKED	Vishay-Dale	RES, 10.0 k, 1%, 0.063 W, AEC-Q200 Grade 0, 0402
73	4	R13, R19, R21, R112	3.24k	CRCW04023K24FKED	Vishay-Dale	RES, 3.24 k, 1%, 0.063 W, AEC-Q200 Grade 0, 0402
74	1	R14	124k	CRCW0402124KFKED	Vishay-Dale	RES, 124k ohm, 1%, 0.063W, 0402
75	5	R15, R76, R123, R124, R133	100k	CRCW0402100KJNED	Vishay-Dale	RES, 100k ohm, 5%, 0.063W, 0402
76	6	R16, R25, R87, R114, R125, R131	10k	CRCW040210K0JNED	Vishay-Dale	RES, 10k ohm, 5%, 0.063W, 0402
77	12	R17, R22, R26, R56, R57, R84, R103, R106, R109, R113, R126, R129	0	CRCW06030000Z0EA	Vishay-Dale	RES, 0 ohm, 5%, 0.1W, 0603
78	1	R18	29.4k	CRCW040229K4FKED	Vishay-Dale	RES, 29.4 k, 1%, 0.063 W, 0402
79	2	R23, R105	34.0k	CRCW040234K0FKED	Vishay-Dale	RES, 34.0 k, 1%, 0.063 W, 0402
80	1	R24	100	ERJ-2RKF1000X	Panasonic	RES, 100, 1%, 0.1 W, 0402
81	4	R27, R28, R37, R88	0	CRCW02010000Z0ED	Vishay-Dale	RES, 0, 5%, 0.05 W, 0201
82	12	R33, R34, R38, R39, R40, R41, R42, R43, R44, R45, R46, R47	0	ERJ-1GE0R00C	Panasonic	RES, 0, 5%, 0.05 W, 0201

Table 17-1. DS90UB954-Q1EVM BOM (continued)

ITEM	QTY	DESIGNATOR	VALUE	PART NUMBER	MANUFACTURER	DESCRIPTION
83	3	R36, R52, R53	4.7k	CRCW04024K70JNED	Vishay-Dale	RES, 4.7k ohm, 5%, 0.063W, 0402
84	1	R49	10.0k	ERJ-2RKF1002X	Panasonic	RES, 10.0 k, 1%, 0.1 W, 0402
85	10	R58, R59, R70, R77, R80, R81, R89, R91, R101, R104	220	CRCW0402220RJNED	Vishay-Dale	RES, 220, 5%, 0.063 W, 0402
86	3	R73, R92, R94	470	CRCW0402470RJNED	Vishay-Dale	RES, 470 ohm, 5%, 0.063W, 0402
87	3	R83, R100, R108	4.02k	CRCW06034K02FKEA	Vishay-Dale	RES, 4.02 k, 1%, 0.1 W, 0603
88	1	R90	49.9	CRCW020149R9FKED	Vishay-Dale	RES, 49.9, 1%, 0.05 W, 0201
89	1	R93	22.1k	CRCW040222K1FKED	Vishay-Dale	RES, 22.1k ohm, 1%, 0.063W, 0402
90	1	R96	49.9	ERJ-2RKF49R9X	Panasonic	RES, 49.9, 1%, 0.1 W, AEC-Q200 Grade 0, 0402
91	2	R97, R98	2.4k	CRCW04022K40JNED	Vishay-Dale	RES, 2.4 k, 5%, 0.063 W, 0402
92	2	R99, R110	5.6k	CRCW04025K60JNED	Vishay-Dale	RES, 5.6 k, 5%, 0.063 W, 0402
93	1	R116	25.5k	CRCW040225K5FKED	Vishay-Dale	RES, 25.5 k, 1%, 0.063 W, 0402
94	1	R117	95.3k	CRCW040295K3FKED	Vishay-Dale	RES, 95.3 k, 1%, 0.063 W, 0402
95	1	R118	39.2k	CRCW040239K2FKED	Vishay-Dale	RES, 39.2 k, 1%, 0.063 W, 0402
96	2	R119, R120	78.7k	CRCW040278K7FKED	Vishay-Dale	RES, 78.7 k, 1%, 0.063 W, 0402
97	1	R121	97.6k	CRCW040297K6FKED	Vishay-Dale	RES, 97.6 k, 1%, 0.063 W, 0402
98	1	R127	1.87k	CRCW04021K87FKED	Vishay-Dale	RES, 1.87k ohm, 1%, 0.063W, 0402
99	1	R128	4.99k	CRCW04024K99FKED	Vishay-Dale	RES, 4.99k ohm, 1%, 0.063W, 0402
100	2	R134, R135	33	CRCW040233R0JNED	Vishay-Dale	RES, 33 ohm, 5%, 0.063W, 0402
101	1	S1		EVQ-PSD02K	Panasonic	Switch, Tactile, SPST-NO, SMT
102	12	SH-J1, SH-J2, SH-J3, SH-J4, SH-J5, SH-J6, SH-J7, SH-J8, SH-J9, SH-J10, SH-J11, SH-J12	1x2	SNT-100-BK-G	Samtec	Shunt, 2mm, Gold plated, Black
103	1	SW1		KSR221GLFS	C and K Components	Switch, Normally open, 2.3N force, 200k operations, SMD
104	1	T1		ACM9070-701-2PL-TL01	TDK	Coupled inductor, 5 A, 0.01 ohm, SMD
105	1	U1		TPD4E004DRYR	Texas Instruments	4-Channel ESD Protection Array for High-Speed Data Interfaces, DRY0006A (USON-6)
106	1	U2		TPS73533DRBR	Texas Instruments	500mA, Low Quiescent Current, Ultra-Low Noise, High PSRR Low-Dropout Linear Regulator, DRB0008A
107	1	U3		TCA9406DCUR	Texas Instruments	2-Bit Bidirectional 1-MHz I2C Bus and SMBus Voltage-Level Shifter, DCU0008A (VSSOP-8)
108	1	U4		TPS54225PWPR	Texas Instruments	4.5V to 18V Input, 2-A Synchronous Step-Down SWIFT™ Converter, PWP0014E
109	1	U5		DS90UB954TRGZRQ1	Texas Instruments	FPD\Link III Deserializer with CSI\2 interface for 2.3MP/60fps cameras, RGZ0048B (VQFN-48)
110	3	U6, U7, U8		LM2941LD/NOPB	Texas Instruments	1A Low Dropout Adjustable Regulator, NGN0008A (WSON-8)
111	1	U9		TPS74801TDRCRQ1	Texas Instruments	Single Output LDO, 1.5 A, Adjustable 0.8 to 3.6 V Output, 0.8 to 5.5 V Input, with Programmable Soft Start, 10-pin SON (DRC), -40 to 105 degC, Green (RoHS & no Sb/Br)

Table 17-1. DS90UB954-Q1EVM BOM (continued)

ITEM	QTY	DESIGNATOR	VALUE	PART NUMBER	MANUFACTURER	DESCRIPTION
112	1	U10		TPS767D318PWP	Texas Instruments	Dual Output LDO, 1 A, Fixed 1.8, 3.3 V Output, 2.7 to 10 V Input, 28-pin HTSSOP (PWP), -40 to 125 degC, Green (RoHS & no Sb/Br)
113	1	U11		MSP430F5529IPN	Texas Instruments	25 MHz Mixed Signal Microcontroller with 128 KB Flash, 8192 B SRAM and 63 GPIOs, -40 to 85 degC, 80-pin QFP (PN), Green (RoHS & no Sb/Br)
114	1	Y2		SG-210STF25.000000MHZY	Epson	OSC, 25 MHz, 1.6 to 3.6 V, SMD
115	1	Y3		ECS-240-20-5PX-TR	ECS Inc.	Crystal, 24.000MHz, 20pF, SMD
116	0	C28, C30, C31, C101, C102, C104, C119, C120	1uF	GRM185R61C105KE44D	MuRata	CAP, CERM, 1 uF, 16 V, +/- 10%, X5R, 0603
117	0	C29, C32, C34, C35, C40, C41, C48, C49, C53, C54, C62, C67, C81, C86, C87, C93	22uF	GRT31CR61E226KE01L	MuRata	CAP, CERM, 22 uF, 25 V, +/- 10%, X5R, AEC-Q200 Grade 3, 1206
118	0	C33, C42, C47, C63, C79	0.1uF	CGA2B3X7R1H104K050BB	TDK	CAP, CERM, 0.1 uF, 50 V, +/- 10%, X7R, AEC-Q200 Grade 1, 0402
119	0	C55, C58	12pF	GRM1555C1E120JA01D	MuRata	CAP, CERM, 12pF, 25V, +/-5%, COG/NP0, 0402
120	0	C57	10uF	CL21A106KAFN3NE	Samsung Electro-Mechanics	CAP, CERM, 10 uF, 25 V, +/- 10%, X5R, 0805
121	0	C73, C82	1uF	C1005JB1V105K050BC	TDK	CAP, CERM, 1 uF, 35 V, +/- 10%, JB, 0402
122	0	H1		BMI-S-201-F	Laird-Signal Integrity Products	EMI SHIELD, 13.66 x 12.70 mm, SMT
123	0	J7		TSW-102-07-G-D	Samtec	Header, 100mil, 2x2, Gold, TH
124	0	J21		MMCX-J-P-H-ST-TH1	Samtec	Connector, MMCX 50 ohm, TH
125	0	L1, L2, L3, L5	120 ohm	BLM18SG121TN1D	MuRata	Ferrite Bead, 120 ohm @ 100 MHz, 3 A, 0603
126	0	L10	100uH	CLF6045NIT-101M-D	TDK	Inductor, Shielded, Ferrite, 100 uH, 0.61 A, 0.384 ohm, AEC-Q200 Grade 0, SMD
127	0	L12		DLW21SN900HQ2L	MuRata	Coupled inductor, 0.28 A, 0.41 ohm, SMD
128	0	R7, R60, R61, R62, R63, R64, R65, R66, R67, R68, R69, R71, R72	0	ERJ-1GE0R00C	Panasonic	RES, 0, 5%, 0.05 W, AEC-Q200 Grade 1, 0201
129	0	R31	50	504L50R0FTNCF	AT Ceramics	RES, 50, 1%, 0.125 W, AEC-Q200 Grade 1, 0402
130	0	R32, R35, R48, R75, R78, R82, R86, R115, R130	0	ERJ-2GE0R00X	Panasonic	RES, 0, 5%, 0.1 W, AEC-Q200 Grade 0, 0402
131	0	R50, R51, R122	0	CRCW06030000Z0EA	Vishay-Dale	RES, 0, 5%, 0.1 W, AEC-Q200 Grade 0, 0603
132	0	R74, R79	10.0k	CRCW040210K0FKED	Vishay-Dale	RES, 10.0 k, 1%, 0.063 W, AEC-Q200 Grade 0, 0402
133	0	R95	0	CRCW02010000Z0ED	Vishay-Dale	RES, 0, 5%, 0.05 W, 0201
134	0	Y1		ABM3-25.000MHZ-D2W-T	Abracon Corporation	Crystal, 25 MHz, 18 pF, SMD

18 Revision History

NOTE: Page numbers for previous revisions may differ from page numbers in the current version.

Changes from Revision C (November 2022) to Revision D (February 2023)	Page
• Updated Abstract section to include DS90UB638-Q1.....	1
• Changed all instances of legacy terminology to controller and target where I2C is mentioned.....	4
Changes from Revision B (April 2021) to Revision C (November 2022)	Page
• Updated schematic, PCB layers, and BOM to match the updated EVM.....	1
Changes from Revision A (May 2019) to Revision B (April 2021)	Page
• Updated Abstract section to include V ³ Link TDES954.....	1
Changes from Revision * (August 2017) to Revision A (May 2019)	Page
• Updated User's Guide throughout.....	1

STANDARD TERMS FOR EVALUATION MODULES

1. *Delivery:* TI delivers TI evaluation boards, kits, or modules, including any accompanying demonstration software, components, and/or documentation which may be provided together or separately (collectively, an "EVM" or "EVMs") to the User ("User") in accordance with the terms set forth herein. User's acceptance of the EVM is expressly subject to the following terms.
 - 1.1 EVMs are intended solely for product or software developers for use in a research and development setting to facilitate feasibility evaluation, experimentation, or scientific analysis of TI semiconductors products. EVMs have no direct function and are not finished products. EVMs shall not be directly or indirectly assembled as a part or subassembly in any finished product. For clarification, any software or software tools provided with the EVM ("Software") shall not be subject to the terms and conditions set forth herein but rather shall be subject to the applicable terms that accompany such Software
 - 1.2 EVMs are not intended for consumer or household use. EVMs may not be sold, sublicensed, leased, rented, loaned, assigned, or otherwise distributed for commercial purposes by Users, in whole or in part, or used in any finished product or production system.
2. *Limited Warranty and Related Remedies/Disclaimers:*
 - 2.1 These terms do not apply to Software. The warranty, if any, for Software is covered in the applicable Software License Agreement.
 - 2.2 TI warrants that the TI EVM will conform to TI's published specifications for ninety (90) days after the date TI delivers such EVM to User. Notwithstanding the foregoing, TI shall not be liable for a nonconforming EVM if (a) the nonconformity was caused by neglect, misuse or mistreatment by an entity other than TI, including improper installation or testing, or for any EVMs that have been altered or modified in any way by an entity other than TI, (b) the nonconformity resulted from User's design, specifications or instructions for such EVMs or improper system design, or (c) User has not paid on time. Testing and other quality control techniques are used to the extent TI deems necessary. TI does not test all parameters of each EVM. User's claims against TI under this Section 2 are void if User fails to notify TI of any apparent defects in the EVMs within ten (10) business days after delivery, or of any hidden defects with ten (10) business days after the defect has been detected.
 - 2.3 TI's sole liability shall be at its option to repair or replace EVMs that fail to conform to the warranty set forth above, or credit User's account for such EVM. TI's liability under this warranty shall be limited to EVMs that are returned during the warranty period to the address designated by TI and that are determined by TI not to conform to such warranty. If TI elects to repair or replace such EVM, TI shall have a reasonable time to repair such EVM or provide replacements. Repaired EVMs shall be warranted for the remainder of the original warranty period. Replaced EVMs shall be warranted for a new full ninety (90) day warranty period.

WARNING

Evaluation Kits are intended solely for use by technically qualified, professional electronics experts who are familiar with the dangers and application risks associated with handling electrical mechanical components, systems, and subsystems.

User shall operate the Evaluation Kit within TI's recommended guidelines and any applicable legal or environmental requirements as well as reasonable and customary safeguards. Failure to set up and/or operate the Evaluation Kit within TI's recommended guidelines may result in personal injury or death or property damage. Proper set up entails following TI's instructions for electrical ratings of interface circuits such as input, output and electrical loads.

NOTE:

EXPOSURE TO ELECTROSTATIC DISCHARGE (ESD) MAY CAUSE DEGRADATION OR FAILURE OF THE EVALUATION KIT; TI RECOMMENDS STORAGE OF THE EVALUATION KIT IN A PROTECTIVE ESD BAG.

3 Regulatory Notices:

3.1 United States

3.1.1 Notice applicable to EVMs not FCC-Approved:

FCC NOTICE: This kit is designed to allow product developers to evaluate electronic components, circuitry, or software associated with the kit to determine whether to incorporate such items in a finished product and software developers to write software applications for use with the end product. This kit is not a finished product and when assembled may not be resold or otherwise marketed unless all required FCC equipment authorizations are first obtained. Operation is subject to the condition that this product not cause harmful interference to licensed radio stations and that this product accept harmful interference. Unless the assembled kit is designed to operate under part 15, part 18 or part 95 of this chapter, the operator of the kit must operate under the authority of an FCC license holder or must secure an experimental authorization under part 5 of this chapter.

3.1.2 For EVMs annotated as FCC – FEDERAL COMMUNICATIONS COMMISSION Part 15 Compliant:

CAUTION

This device complies with part 15 of the FCC Rules. Operation is subject to the following two conditions: (1) This device may not cause harmful interference, and (2) this device must accept any interference received, including interference that may cause undesired operation.

Changes or modifications not expressly approved by the party responsible for compliance could void the user's authority to operate the equipment.

FCC Interference Statement for Class A EVM devices

NOTE: This equipment has been tested and found to comply with the limits for a Class A digital device, pursuant to part 15 of the FCC Rules. These limits are designed to provide reasonable protection against harmful interference when the equipment is operated in a commercial environment. This equipment generates, uses, and can radiate radio frequency energy and, if not installed and used in accordance with the instruction manual, may cause harmful interference to radio communications. Operation of this equipment in a residential area is likely to cause harmful interference in which case the user will be required to correct the interference at his own expense.

FCC Interference Statement for Class B EVM devices

NOTE: This equipment has been tested and found to comply with the limits for a Class B digital device, pursuant to part 15 of the FCC Rules. These limits are designed to provide reasonable protection against harmful interference in a residential installation. This equipment generates, uses and can radiate radio frequency energy and, if not installed and used in accordance with the instructions, may cause harmful interference to radio communications. However, there is no guarantee that interference will not occur in a particular installation. If this equipment does cause harmful interference to radio or television reception, which can be determined by turning the equipment off and on, the user is encouraged to try to correct the interference by one or more of the following measures:

- Reorient or relocate the receiving antenna.
- Increase the separation between the equipment and receiver.
- Connect the equipment into an outlet on a circuit different from that to which the receiver is connected.
- Consult the dealer or an experienced radio/TV technician for help.

3.2 Canada

3.2.1 For EVMs issued with an Industry Canada Certificate of Conformance to RSS-210 or RSS-247

Concerning EVMs Including Radio Transmitters:

This device complies with Industry Canada license-exempt RSSs. Operation is subject to the following two conditions:

(1) this device may not cause interference, and (2) this device must accept any interference, including interference that may cause undesired operation of the device.

Concernant les EVMs avec appareils radio:

Le présent appareil est conforme aux CNR d'Industrie Canada applicables aux appareils radio exempts de licence. L'exploitation est autorisée aux deux conditions suivantes: (1) l'appareil ne doit pas produire de brouillage, et (2) l'utilisateur de l'appareil doit accepter tout brouillage radioélectrique subi, même si le brouillage est susceptible d'en compromettre le fonctionnement.

Concerning EVMs Including Detachable Antennas:

Under Industry Canada regulations, this radio transmitter may only operate using an antenna of a type and maximum (or lesser) gain approved for the transmitter by Industry Canada. To reduce potential radio interference to other users, the antenna type and its gain should be so chosen that the equivalent isotropically radiated power (e.i.r.p.) is not more than that necessary for successful communication. This radio transmitter has been approved by Industry Canada to operate with the antenna types listed in the user guide with the maximum permissible gain and required antenna impedance for each antenna type indicated. Antenna types not included in this list, having a gain greater than the maximum gain indicated for that type, are strictly prohibited for use with this device.

Concernant les EVMs avec antennes détachables

Conformément à la réglementation d'Industrie Canada, le présent émetteur radio peut fonctionner avec une antenne d'un type et d'un gain maximal (ou inférieur) approuvé pour l'émetteur par Industrie Canada. Dans le but de réduire les risques de brouillage radioélectrique à l'intention des autres utilisateurs, il faut choisir le type d'antenne et son gain de sorte que la puissance isotrope rayonnée équivalente (p.i.r.e.) ne dépasse pas l'intensité nécessaire à l'établissement d'une communication satisfaisante. Le présent émetteur radio a été approuvé par Industrie Canada pour fonctionner avec les types d'antenne énumérés dans le manuel d'usage et ayant un gain admissible maximal et l'impédance requise pour chaque type d'antenne. Les types d'antenne non inclus dans cette liste, ou dont le gain est supérieur au gain maximal indiqué, sont strictement interdits pour l'exploitation de l'émetteur.

3.3 Japan

3.3.1 *Notice for EVMs delivered in Japan:* Please see http://www.tij.co.jp/llds/ti_ja/general/eStore/notice_01.page 日本国内に輸入される評価用キット、ボードについては、次のところをご覧ください。

<https://www.ti.com/ja-jp/legal/notice-for-evaluation-kits-delivered-in-japan.html>

3.3.2 *Notice for Users of EVMs Considered "Radio Frequency Products" in Japan:* EVMs entering Japan may not be certified by TI as conforming to Technical Regulations of Radio Law of Japan.

If User uses EVMs in Japan, not certified to Technical Regulations of Radio Law of Japan, User is required to follow the instructions set forth by Radio Law of Japan, which includes, but is not limited to, the instructions below with respect to EVMs (which for the avoidance of doubt are stated strictly for convenience and should be verified by User):

1. Use EVMs in a shielded room or any other test facility as defined in the notification #173 issued by Ministry of Internal Affairs and Communications on March 28, 2006, based on Sub-section 1.1 of Article 6 of the Ministry's Rule for Enforcement of Radio Law of Japan,
2. Use EVMs only after User obtains the license of Test Radio Station as provided in Radio Law of Japan with respect to EVMs, or
3. Use of EVMs only after User obtains the Technical Regulations Conformity Certification as provided in Radio Law of Japan with respect to EVMs. Also, do not transfer EVMs, unless User gives the same notice above to the transferee. Please note that if User does not follow the instructions above, User will be subject to penalties of Radio Law of Japan.

【無線電波を送信する製品の開発キットをお使いになる際の注意事項】 開発キットの中には技術基準適合証明を受けていないものがあります。技術適合証明を受けていないものご使用に際しては、電波法遵守のため、以下のいずれかの措置を取っていただく必要がありますのでご注意ください。

1. 電波法施行規則第6条第1項第1号に基づく平成18年3月28日総務省告示第173号で定められた電波暗室等の試験設備でご使用いただく。
2. 実験局の免許を取得後ご使用いただく。
3. 技術基準適合証明を取得後ご使用いただく。

なお、本製品は、上記の「ご使用にあたっての注意」を譲渡先、移転先に通知しない限り、譲渡、移転できないものとします。

上記を遵守頂けない場合は、電波法の罰則が適用される可能性があることをご留意ください。日本テキサス・イ

ンスツルメンツ株式会社

東京都新宿区西新宿 6 丁目 2 4 番 1 号

西新宿三井ビル

3.3.3 *Notice for EVMs for Power Line Communication:* Please see http://www.tij.co.jp/llds/ti_ja/general/eStore/notice_02.page

電力線搬送波通信についての開発キットをお使いになる際の注意事項については、次のところをご覧ください。 <https://www.ti.com/ja-jp/legal/notice-for-evaluation-kits-for-power-line-communication.html>

3.4 European Union

3.4.1 *For EVMs subject to EU Directive 2014/30/EU (Electromagnetic Compatibility Directive):*

This is a class A product intended for use in environments other than domestic environments that are connected to a low-voltage power-supply network that supplies buildings used for domestic purposes. In a domestic environment this product may cause radio interference in which case the user may be required to take adequate measures.

-
- 4 *EVM Use Restrictions and Warnings:*
 - 4.1 EVMS ARE NOT FOR USE IN FUNCTIONAL SAFETY AND/OR SAFETY CRITICAL EVALUATIONS, INCLUDING BUT NOT LIMITED TO EVALUATIONS OF LIFE SUPPORT APPLICATIONS.
 - 4.2 User must read and apply the user guide and other available documentation provided by TI regarding the EVM prior to handling or using the EVM, including without limitation any warning or restriction notices. The notices contain important safety information related to, for example, temperatures and voltages.
 - 4.3 *Safety-Related Warnings and Restrictions:*
 - 4.3.1 User shall operate the EVM within TI's recommended specifications and environmental considerations stated in the user guide, other available documentation provided by TI, and any other applicable requirements and employ reasonable and customary safeguards. Exceeding the specified performance ratings and specifications (including but not limited to input and output voltage, current, power, and environmental ranges) for the EVM may cause personal injury or death, or property damage. If there are questions concerning performance ratings and specifications, User should contact a TI field representative prior to connecting interface electronics including input power and intended loads. Any loads applied outside of the specified output range may also result in unintended and/or inaccurate operation and/or possible permanent damage to the EVM and/or interface electronics. Please consult the EVM user guide prior to connecting any load to the EVM output. If there is uncertainty as to the load specification, please contact a TI field representative. During normal operation, even with the inputs and outputs kept within the specified allowable ranges, some circuit components may have elevated case temperatures. These components include but are not limited to linear regulators, switching transistors, pass transistors, current sense resistors, and heat sinks, which can be identified using the information in the associated documentation. When working with the EVM, please be aware that the EVM may become very warm.
 - 4.3.2 EVMs are intended solely for use by technically qualified, professional electronics experts who are familiar with the dangers and application risks associated with handling electrical mechanical components, systems, and subsystems. User assumes all responsibility and liability for proper and safe handling and use of the EVM by User or its employees, affiliates, contractors or designees. User assumes all responsibility and liability to ensure that any interfaces (electronic and/or mechanical) between the EVM and any human body are designed with suitable isolation and means to safely limit accessible leakage currents to minimize the risk of electrical shock hazard. User assumes all responsibility and liability for any improper or unsafe handling or use of the EVM by User or its employees, affiliates, contractors or designees.
 - 4.4 User assumes all responsibility and liability to determine whether the EVM is subject to any applicable international, federal, state, or local laws and regulations related to User's handling and use of the EVM and, if applicable, User assumes all responsibility and liability for compliance in all respects with such laws and regulations. User assumes all responsibility and liability for proper disposal and recycling of the EVM consistent with all applicable international, federal, state, and local requirements.
 5. *Accuracy of Information:* To the extent TI provides information on the availability and function of EVMs, TI attempts to be as accurate as possible. However, TI does not warrant the accuracy of EVM descriptions, EVM availability or other information on its websites as accurate, complete, reliable, current, or error-free.
 6. *Disclaimers:*
 - 6.1 EXCEPT AS SET FORTH ABOVE, EVMS AND ANY MATERIALS PROVIDED WITH THE EVM (INCLUDING, BUT NOT LIMITED TO, REFERENCE DESIGNS AND THE DESIGN OF THE EVM ITSELF) ARE PROVIDED "AS IS" AND "WITH ALL FAULTS." TI DISCLAIMS ALL OTHER WARRANTIES, EXPRESS OR IMPLIED, REGARDING SUCH ITEMS, INCLUDING BUT NOT LIMITED TO ANY EPIDEMIC FAILURE WARRANTY OR IMPLIED WARRANTIES OF MERCHANTABILITY OR FITNESS FOR A PARTICULAR PURPOSE OR NON-INFRINGEMENT OF ANY THIRD PARTY PATENTS, COPYRIGHTS, TRADE SECRETS OR OTHER INTELLECTUAL PROPERTY RIGHTS.
 - 6.2 EXCEPT FOR THE LIMITED RIGHT TO USE THE EVM SET FORTH HEREIN, NOTHING IN THESE TERMS SHALL BE CONSTRUED AS GRANTING OR CONFERRING ANY RIGHTS BY LICENSE, PATENT, OR ANY OTHER INDUSTRIAL OR INTELLECTUAL PROPERTY RIGHT OF TI, ITS SUPPLIERS/LICENSORS OR ANY OTHER THIRD PARTY, TO USE THE EVM IN ANY FINISHED END-USER OR READY-TO-USE FINAL PRODUCT, OR FOR ANY INVENTION, DISCOVERY OR IMPROVEMENT, REGARDLESS OF WHEN MADE, CONCEIVED OR ACQUIRED.
 7. *USER'S INDEMNITY OBLIGATIONS AND REPRESENTATIONS.* USER WILL DEFEND, INDEMNIFY AND HOLD TI, ITS LICENSORS AND THEIR REPRESENTATIVES HARMLESS FROM AND AGAINST ANY AND ALL CLAIMS, DAMAGES, LOSSES, EXPENSES, COSTS AND LIABILITIES (COLLECTIVELY, "CLAIMS") ARISING OUT OF OR IN CONNECTION WITH ANY HANDLING OR USE OF THE EVM THAT IS NOT IN ACCORDANCE WITH THESE TERMS. THIS OBLIGATION SHALL APPLY WHETHER CLAIMS ARISE UNDER STATUTE, REGULATION, OR THE LAW OF TORT, CONTRACT OR ANY OTHER LEGAL THEORY, AND EVEN IF THE EVM FAILS TO PERFORM AS DESCRIBED OR EXPECTED.
-

8. *Limitations on Damages and Liability:*

8.1 *General Limitations.* IN NO EVENT SHALL TI BE LIABLE FOR ANY SPECIAL, COLLATERAL, INDIRECT, PUNITIVE, INCIDENTAL, CONSEQUENTIAL, OR EXEMPLARY DAMAGES IN CONNECTION WITH OR ARISING OUT OF THESE TERMS OR THE USE OF THE EVMS , REGARDLESS OF WHETHER TI HAS BEEN ADVISED OF THE POSSIBILITY OF SUCH DAMAGES. EXCLUDED DAMAGES INCLUDE, BUT ARE NOT LIMITED TO, COST OF REMOVAL OR REINSTALLATION, ANCILLARY COSTS TO THE PROCUREMENT OF SUBSTITUTE GOODS OR SERVICES, RETESTING, OUTSIDE COMPUTER TIME, LABOR COSTS, LOSS OF GOODWILL, LOSS OF PROFITS, LOSS OF SAVINGS, LOSS OF USE, LOSS OF DATA, OR BUSINESS INTERRUPTION. NO CLAIM, SUIT OR ACTION SHALL BE BROUGHT AGAINST TI MORE THAN TWELVE (12) MONTHS AFTER THE EVENT THAT GAVE RISE TO THE CAUSE OF ACTION HAS OCCURRED.

8.2 *Specific Limitations.* IN NO EVENT SHALL TI'S AGGREGATE LIABILITY FROM ANY USE OF AN EVM PROVIDED HEREUNDER, INCLUDING FROM ANY WARRANTY, INDEMNITY OR OTHER OBLIGATION ARISING OUT OF OR IN CONNECTION WITH THESE TERMS, , EXCEED THE TOTAL AMOUNT PAID TO TI BY USER FOR THE PARTICULAR EVM(S) AT ISSUE DURING THE PRIOR TWELVE (12) MONTHS WITH RESPECT TO WHICH LOSSES OR DAMAGES ARE CLAIMED. THE EXISTENCE OF MORE THAN ONE CLAIM SHALL NOT ENLARGE OR EXTEND THIS LIMIT.

9. *Return Policy.* Except as otherwise provided, TI does not offer any refunds, returns, or exchanges. Furthermore, no return of EVM(s) will be accepted if the package has been opened and no return of the EVM(s) will be accepted if they are damaged or otherwise not in a resalable condition. If User feels it has been incorrectly charged for the EVM(s) it ordered or that delivery violates the applicable order, User should contact TI. All refunds will be made in full within thirty (30) working days from the return of the components(s), excluding any postage or packaging costs.

10. *Governing Law:* These terms and conditions shall be governed by and interpreted in accordance with the laws of the State of Texas, without reference to conflict-of-laws principles. User agrees that non-exclusive jurisdiction for any dispute arising out of or relating to these terms and conditions lies within courts located in the State of Texas and consents to venue in Dallas County, Texas. Notwithstanding the foregoing, any judgment may be enforced in any United States or foreign court, and TI may seek injunctive relief in any United States or foreign court.

Mailing Address: Texas Instruments, Post Office Box 655303, Dallas, Texas 75265
Copyright © 2023, Texas Instruments Incorporated

IMPORTANT NOTICE AND DISCLAIMER

TI PROVIDES TECHNICAL AND RELIABILITY DATA (INCLUDING DATA SHEETS), DESIGN RESOURCES (INCLUDING REFERENCE DESIGNS), APPLICATION OR OTHER DESIGN ADVICE, WEB TOOLS, SAFETY INFORMATION, AND OTHER RESOURCES "AS IS" AND WITH ALL FAULTS, AND DISCLAIMS ALL WARRANTIES, EXPRESS AND IMPLIED, INCLUDING WITHOUT LIMITATION ANY IMPLIED WARRANTIES OF MERCHANTABILITY, FITNESS FOR A PARTICULAR PURPOSE OR NON-INFRINGEMENT OF THIRD PARTY INTELLECTUAL PROPERTY RIGHTS.

These resources are intended for skilled developers designing with TI products. You are solely responsible for (1) selecting the appropriate TI products for your application, (2) designing, validating and testing your application, and (3) ensuring your application meets applicable standards, and any other safety, security, regulatory or other requirements.

These resources are subject to change without notice. TI grants you permission to use these resources only for development of an application that uses the TI products described in the resource. Other reproduction and display of these resources is prohibited. No license is granted to any other TI intellectual property right or to any third party intellectual property right. TI disclaims responsibility for, and you will fully indemnify TI and its representatives against, any claims, damages, costs, losses, and liabilities arising out of your use of these resources.

TI's products are provided subject to [TI's Terms of Sale](#) or other applicable terms available either on [ti.com](https://www.ti.com) or provided in conjunction with such TI products. TI's provision of these resources does not expand or otherwise alter TI's applicable warranties or warranty disclaimers for TI products.

TI objects to and rejects any additional or different terms you may have proposed.

Mailing Address: Texas Instruments, Post Office Box 655303, Dallas, Texas 75265
Copyright © 2023, Texas Instruments Incorporated