



Introduction

Voltage supervisors come in many form factors with a variety of functions to help designers increase the robustness of their system. Voltage supervisors are typically used to monitor power rails. One of the advantages of using voltage supervisors in almost every design, industrial or automobile applications, is that supervisors help processors to prevent brownouts conditions to occur. Monitoring the power rails going into a MCU with a supervisor will help to reset the MCU from the unwanted voltage rail faults such as sudden voltage drops, spikes and transient.

Another popular purpose of a voltage supervisor is its ability to act as a comparator for battery or system power rail monitoring. Whenever an overvoltage or undervoltage event occurs, the supervisor can sense and react to this event. TI has very wide portfolio that can provide supervisors with different thresholds, accuracies, hysteresis so that low voltage power rails as well as high voltage power rails can be monitored.

Designers can choose between utilizing a properly rated high voltage supervisor or a low voltage supervisor with extra circuitry that allows the supervisor to operate beyond its recommended operating conditions. This application note covers several design solutions to monitoring high voltage power rails with both high and low voltage supervisors.

High Voltage Supervisors

Figure 1 shows the TPS37's low-complexity solution to monitoring both undervoltage and overvoltage conditions on a standard 24V rail. As the TPS37 is designed to handle up to 65V, the device can easily monitor a direct connection to a 24V power supply.

Similarly Figure 2 shows the TPS38 being used to monitor two separate voltage rails directly and Figure 3 shows the TPS3760 monitoring an undervoltage condition on a standard 12V rail.

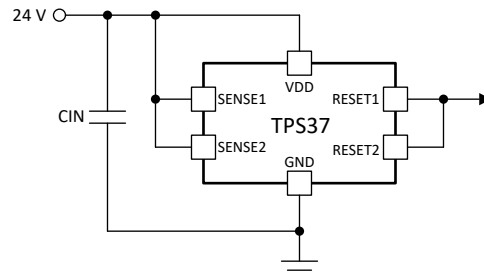

Figure 1. TPS37 Circuit

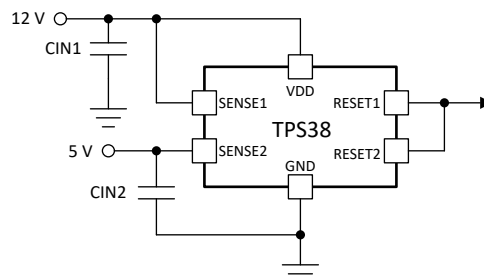

Figure 2. TPS38 Circuit

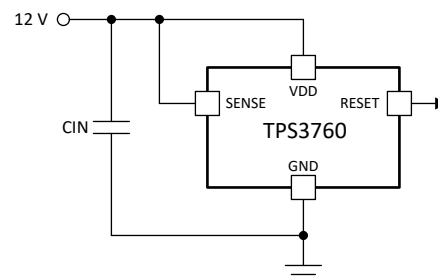

Figure 3. TPS3760 Circuit

Table 1. High Voltage Supervisor Comparisons

Features	TPS37	TPS38	TPS3760	TPS3762
Number of Channel	Dual	Dual	Single	Single
Window Supervisor	✓	—	—	✓
Output Reset Latch	—	—	—	✓
FuSa Capable / Compliant	Capable	Capable	Capable	Compliant

Programmable sense and reset time delay feature, low quiescent current, manual reset feature and having different output topologies options are some of the common features for TPS37, TPS38, and TPS3760. Please refer to application note [Common Applications of Wide VIN Overvoltage and Undervoltage Supervisors](#) for more details about key features of TPS3760, TPS37, and TPS38.

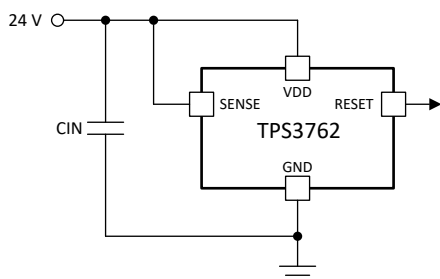

Figure 4. TPS3762 Circuit

As shown in [Figure 4](#), [TPS3762](#) is another 65V window supervisor with low supply current that can also monitor directly to 12V / 24V. It also has output reset latching feature that can help bring the system to safe state, and built-in self-test feature that runs diagnostics internally in the device. One of the advantages of [TPS3762](#) is that, thanks to the bist functionality, SIL-3 Functional Safety-compliant level is targeted for [TPS3762](#) for industrial applications, and ASIL-D Functional Safety-Compliant is targeted for [TPS3762 -Q1](#) for automotive applications, which will help a designer to meet their functional safety requirements as shown in [Table 1](#).

High voltage supervisors offer the simplest solution to monitoring high voltage rails. TI's high voltage supervisors are designed to handle voltages up to 65V with low current consumption for both industrial SELV power rails as well as automotive battery system. As these supervisors can be directly connected to high voltage power supplies without extra circuitry (as shown in [Figure 5](#)), they offer simple solutions to monitoring high voltage power rails with fast response times.

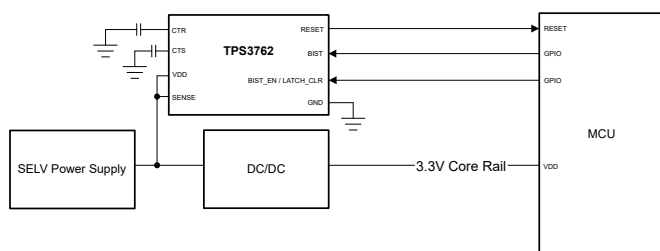

Figure 5. TPS3762 Typical Application

Low Voltage Supervisors

For some designs, there is a benefit to adapting a low voltage supervisor for voltage monitoring applications above the device's rated voltages. For example, some applications require the use of a low voltage supervisor such as the [TPS3808E](#) to monitor a standard 12V rail, despite the 6.5V functional limit of the [TPS3808E](#). A solution to this is to add additional circuitry to help the supervisor stay within its recommended operating conditions. To do this there are two common approaches, which can be either adding in a voltage divider or adding in a shunt voltage reference. [Table 2](#) outlines some of the differences between using these low voltage supervisor solutions or a high voltage supervisor like the [TPS37](#).

Voltage Divider Method

One way of doing this is to use a voltage divider connected to the VDD pin of the supervisor to scale the power voltage rail down to a recommended level. For example, if you have a nominal 12V battery voltage rail that has 40V transients but need to power a [TPS3840](#) of the same rail, the supervisor needs to still function when the rail is 40V. A solution to this is to connect the voltage divider to the VDD pin to scale the power to the recommended level on the [TPS3840](#), as shown in [Figure 6](#). One issue is that the voltage divider is always on and therefore will always have a leakage current. The low Iq of the [TPS3840](#) allows the resistor values to be increased to lower the leakage current. The voltage divider method can increase the VDD capabilities of a supervisor as a low solution cost but come at the expense of power. In the case of noisy applications, TI recommends implementing an input capacitor on VDD when using a resistor divider. However, adding a capacitor on VDD can significantly slow down the response time of the device as it creates an RC circuit with CIN and the resistors used for the voltage divider.

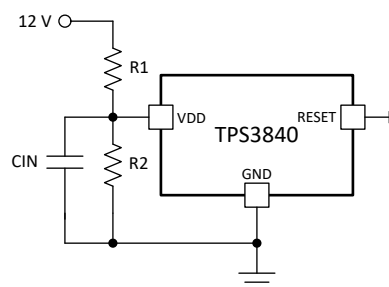

Figure 6. Voltage Divider at VDD

Shunt Voltage Reference

An alternative option is to use a shunt reference to clamp the input voltage, as shown in [Figure 7](#). In this example a [LM4040](#) reference is used to clamp VDD to 6.5V. Shunt references conduct very little current and then shunt the rest of the current above its set shunt voltage. In the situation that the voltage rail is below 6.5V, the current consumption will be low, and the shunt does not limit the voltage at the TPS3808E VDD pin. This means that the TPS3808E can regulate once the power rail is above the minimum input voltage. Implementing a shunt reference in this fashion creates a low-cost buck regulator that is only enabled when the voltage is above 6.5V. [Figure 7](#) shows a typical example of how LM4040 can be implemented with a TPS3808E to monitor a 12V rail.

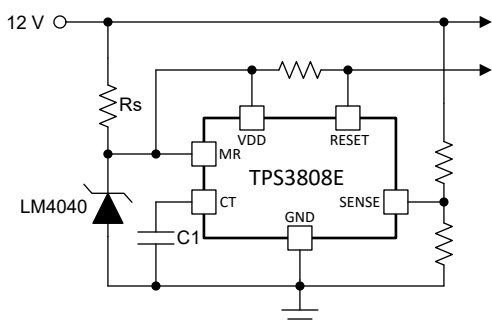

Figure 7. TPS3808E with Shunt Reference

Conclusion

There are a variety of ways to monitor a high voltage rail. TI offers a plethora of devices that can accomplish a wide range of functions that can benefit high voltage rail supervision. In general, TI recommends implementing one of its high voltage supervisors, that offer simple yet effective solutions to monitoring high voltage rails with fast response times and low power consumption. Using a low voltage supervisor with one of the outlined circuitry can be a viable solution for any high voltage need, provided the application does not require low-power consumption or fast response times. [Table 2](#) compares some of the high voltage supervision solutions that TI offers within its portfolio.

Table 2. Design Solution Comparisons

Specs	TPS37	TPS38	TPS3840	TPS3808E + LM4040
Component Count	1 Capacitor	2 Capacitors	2 Resistors, 1 Capacitor	4 Resistors, 1 Capacitor, 1 LM4040
IC I _Q	1.2μA	1.2μA	700nA	0.6μA
Power Dissipation	Low approx. 1.2μA	Low approx. 1.2μA	High ⁽¹⁾	High approx. 65μA

- (1) Using higher value resistors can decrease power dissipation, but can come at the cost of overall accuracy.

IMPORTANT NOTICE AND DISCLAIMER

TI PROVIDES TECHNICAL AND RELIABILITY DATA (INCLUDING DATA SHEETS), DESIGN RESOURCES (INCLUDING REFERENCE DESIGNS), APPLICATION OR OTHER DESIGN ADVICE, WEB TOOLS, SAFETY INFORMATION, AND OTHER RESOURCES "AS IS" AND WITH ALL FAULTS, AND DISCLAIMS ALL WARRANTIES, EXPRESS AND IMPLIED, INCLUDING WITHOUT LIMITATION ANY IMPLIED WARRANTIES OF MERCHANTABILITY, FITNESS FOR A PARTICULAR PURPOSE OR NON-INFRINGEMENT OF THIRD PARTY INTELLECTUAL PROPERTY RIGHTS.

These resources are intended for skilled developers designing with TI products. You are solely responsible for (1) selecting the appropriate TI products for your application, (2) designing, validating and testing your application, and (3) ensuring your application meets applicable standards, and any other safety, security, regulatory or other requirements.

These resources are subject to change without notice. TI grants you permission to use these resources only for development of an application that uses the TI products described in the resource. Other reproduction and display of these resources is prohibited. No license is granted to any other TI intellectual property right or to any third party intellectual property right. TI disclaims responsibility for, and you will fully indemnify TI and its representatives against, any claims, damages, costs, losses, and liabilities arising out of your use of these resources.

TI's products are provided subject to [TI's Terms of Sale](#) or other applicable terms available either on [ti.com](https://www.ti.com) or provided in conjunction with such TI products. TI's provision of these resources does not expand or otherwise alter TI's applicable warranties or warranty disclaimers for TI products.

TI objects to and rejects any additional or different terms you may have proposed.

Mailing Address: Texas Instruments, Post Office Box 655303, Dallas, Texas 75265
Copyright © 2024, Texas Instruments Incorporated