

# Design Guide: TIDA-060024

## Ultrasonic Proximity-Sensing Module (PSM) Reference Design



### Description

This reference design is a small-form factor solution showcasing double-sided PCB spacing and minimum supporting component requirements for the PGA460 ultrasonic sensor signal conditioner. This module operates in a mono-static mode for single sensor transmit and receive operation to enable object detection through air at a range of 0.3 to 5m. Regardless of ambient temperature, humidity, and target color/transparency, object detection remains unaffected; however, maximum range can be hindered by very small or soft targets. The PGA460 operates exclusively as a slave device, and requires a separate master controller. TI recommends using the MSP-EXP430F5529LP as an example master controller to repurpose the existing PGA460Q1EVM GUI and example source code.

### Resources

<a href="#">TIDA-060024</a>	Design Folder
<a href="#">PGA460</a>	Product Folder
<a href="#">BOOSTXL-PGA460</a>	Product Folder
<a href="#">MSP-EXP430F5529LP</a>	Product Folder

### Features

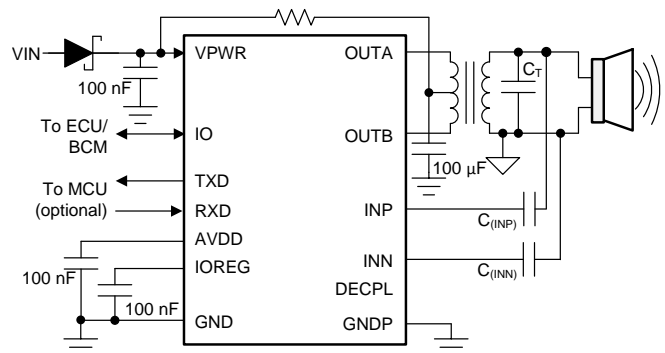
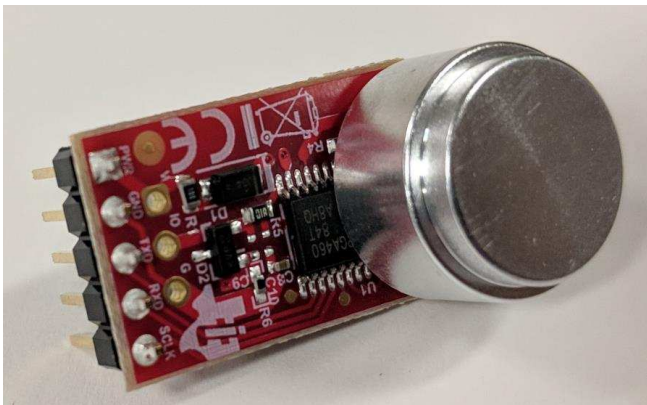
- Integrated driver and receiver solution for ultrasonic sensing
- Compatible with ultrasonic transducers operating at a center frequency between 30-80kHz and 180-480kHz
- Able to generate maximum sound pressure level using a transformer driver
- Access to all communication interfaces offered by the PGA460-Q1, including: USART (UART and SPI), TCI, and One-Wire UART
- Record time for object detection up to 11 m in air

### Applications

- [Position sensor](#)
- [Occupancy detection](#)
- [Ultrasonic park assist sensor](#)



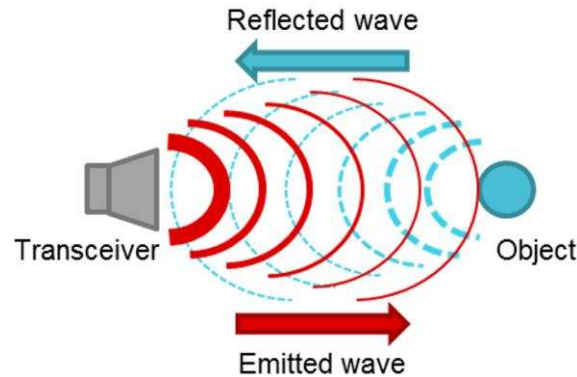
[ASK Our E2E™ Experts](#)



An IMPORTANT NOTICE at the end of this TI reference design addresses authorized use, intellectual property matters and other important disclaimers and information.

## 1 System Description

Ultrasonic time-of-flight using air-coupled transducers is typically reserved for automotive, industrial, or commercial systems that must measure the distance of a single or multiple objects up to several meters. Example applications include automotive park-assist, blind-spot monitoring, hands-free door opening, mobile robotic collision avoidance, drone landing assist, occupancy detection, motion sensing, conveyer belt item counting, and tank level sensing.



**Figure 1. Ultrasonic Time-of-Flight Measurement**

The PGA460Q1EVM is not the optimal size for an end-product’s ultrasonic module, therefore the PGA460PSM reference design is available as a small-form factor implementation example. The PSM reference design routes the USART (UART and/or SPI) TXD, RXD and SCLK pins of the PGA460, along with the one-wire interface IO pin to the external connector. Typically, only the two UART pins, three SPI pins, or the single IO pin are routed the module connector for master-slave communication. Power and ground are always required. The minimum number of required power and ground pins per module is three when using IO, four when using UART, and five when using SPI.

### 1.1 Key System Specifications

Table 1 shows the specification and features of the PGA460PSM reference design.

**Table 1. Key System Specifications**

	PARAMETER	SPECIFICATIONS
Input	Recommended supply voltage	6 to 18 V DC
	Maximum input current	Static 12 mA, Bursting up to 500 mA
Communication Protocols	UART	+3.3 or (5 V) TTL up to 115.2kBaud
	SPI	+3.3 (or 5 V) TTL up to 8MHz
	OWU	+6 to 28 V up to 115.2kBaud
	TCI	+6 to 28 V at 3.3kBaud
Sensor	Transducer mono-static	PUI Audio UTR-1440K-TT-R
	Driver (Transformer)	Wurth 750317161 Alternatives: EPCOS B78416A2232A003 Coilcraft WA8351-AL
	Operating Frequency	40 kHz (device supports 30-80 kHz and 180-480 kHz)
Environment	Temperature Range	-40°C to +85°C
	Transmission Medium	Air
PCB	Form factor (L x W)	0.56 x 0.88 inches
	Number of Layers	Two layers, both sides populated

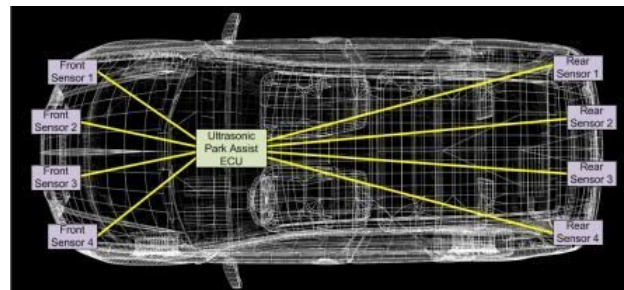
## 1.2 Applications

### 1.2.1 Position Sensor and Occupancy Detection

Ultrasonic sensors are not affected by temperature, humidity, or pressure, meaning they can be used in nearly any environment. Only the speed of sound is affected by temperature and transmission medium, so the accuracy of an ultrasonic measurement must be independently accounted for by monitoring the environmental conditions using other system sensors (primarily a temperature sensor). This reference design is a universal mono-static transformer-driven solution intended to meet the general requirement of accurately measuring the distance to multiple objects through air between 30cm and 5m at 1cm resolution using a closed-top transducer. If an accurate distance measurement is not required, and only a binary indication of presence detection is required, the measurement process will remain the same. The system master can decide how much measurement data is to be extracted from the PGA460 for accurate or binary detection. This reference design allows for the evaluation of most transducers with a center frequency between 30kHz to 80kHz. The flexibility in transducer selection allows the user to change the sensor element based on a different field of view, detectable range, mechanical size, case construction, and/or excitation voltage requirement.

### 1.2.2 Ultrasonic Parking Assist Sensor

Ultrasonic parking assist sensor systems vary from simply detecting an object's presence and alerting the driver with a noise or light, to autonomously parking the car with little to no driver interaction. Typically, these systems have between four and 16 sensor modules placed strategically around the car to provide the desired detection coverage.



**Figure 2. Ultrasonic Parking Assist Sensor in a Point-to-Point Configuration**

This application typically requires a single integrated circuit to drive an ultrasonic transducer (transmitter) and simultaneously receive, signal condition, and process the ultrasonic echo to determine the distance of an object from the vehicle's bumper. When paired with an automotive grade ultrasonic transducer, the PGA460-Q1 can typically detect an International Organization for Standardization (ISO) defined polyvinyl chloride (PVC) pole target up to 5m. The ISO-pole is considered to be a worst-case target due to its single axis of sonar cross section returning the echo towards the immediate direction of the transducer. This reference design's layout and supporting component selection is designed to support electrostatic discharge (ESD) and bulk-current injection (BCI) testing. Common requirements in modern ultrasonic parking assist modules include:

- Object detection from 30cm to 5m
- Time command interface (TCI) or Local Interconnect Network (LIN) communication from the module to a local electronic control unit or directly to the body control module
- A digital processing engine, such as a state machine
- Automotive qualification to support ambient temperature ratings for 40°C to 105°C

The ability for the ultrasonic system to accurately convert a time-of-flight measurement to a one-way distance is based on temperature, humidity, transducer sensitivity, emitted sound pressure level, transmission medium, and target characteristics. In automotive systems, hermetically sealed transducers with minor drift in resonant frequency and decay time across temperature and humidity are necessary to maintain the quality and robustness of the sensor's performance as it is exposed to various climates, severe weather scenarios, hot-and-cold seasons, and road debris. When maximum ranging requirements are less stringent (sub-3m), automotive ultrasonic sensor modules can substitute this reference design's transformer-driver with a bridge-driver solution to drive the transducer with a lower excitation voltage.

## 2 System Overview

### 2.1 PGA460PSM Block Diagram

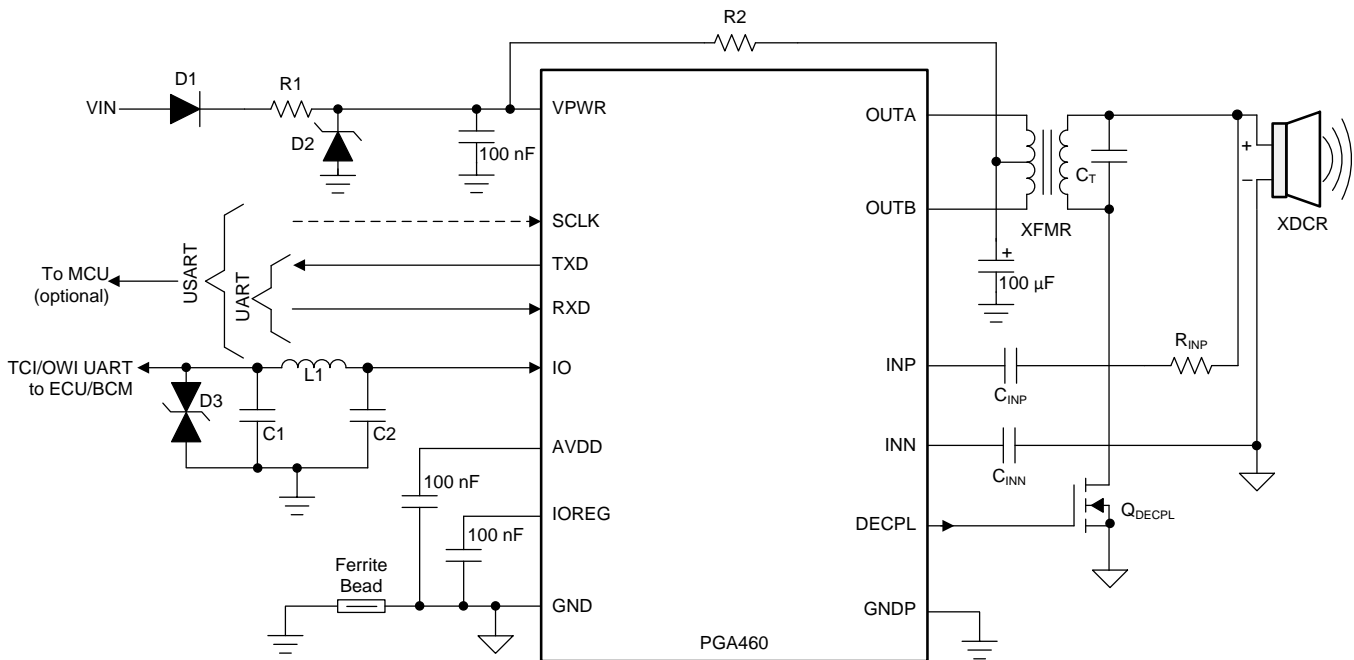


Figure 3. TIDA-060024 Block Diagram

## 2.2 Design Considerations

### 2.2.1 Range Requirements

Firstly, consider the minimum and maximum range requirements. A common range requirement for air-coupled ultrasonic transducer measurements is, but not limited to, object detection between 30 cm to 5 m. Short distance measurements are a challenge for single-transducer configurations, whereby the transducer acts as both the transmitting and receiving element. Due to the resonant behavior of transducers, residual energy will oscillate within the transducer for a short duration immediately after excitation. This short post-burst duration is termed the ringing or decay time. The decay time is based on the equivalent model of the transducer, how long and strongly the transducer is excited, the matched or un-matched resonance frequency of the driver components (based on transformer's secondary leakage inductance), and resonant frequency offset from the band-pass filter's center-frequency.

Section 2.2.5 presents the techniques on external matching network compensation design for improved short distance performance. The matching network consists of inductive, capacitive, and resistive components, which can be optimized to reduce decay time and improve the minimum distance that can be measured using an ultrasonic sensor. Long distance measurements are less of a concern since the decay profile has typically subsided to the same level as the noise floor at the time of object detection. When using a dual-transducer (bi-static) configuration, which includes a separate transducer dedicated exclusively to transmitting, and another transducer dedicated to receiving, the decay time becomes irrelevant since the receiving transducer is only excited by the returning ultrasonic echo. Dual-transducer configurations are recommended for very short object detection (at nearly 0 cm).

Long distance detection must account for the attenuation of ultrasonic energy as it attenuates through air. The rate of attenuation is primarily dependent on frequency. The relationship of transducer frequency to maximum detectable distance is provided as the following:

↑ Frequency :: ↑ Resolution :: ↑ Narrower Directivity :: ↑ Attenuation :: ↓ Distance

Ultrasonic energy does not decay linearly across distance. Instead, the energy decay is logarithmic in nature. Figure 4 shows the attenuation of sound pressure by distance and frequency.

The benefits of high-frequency transducers include an increase to resolution and focused directivity (forward-facing beam pattern), but the disadvantage is the increase to attenuation. The rate at which the ultrasonic energy experiences scattering and absorption while propagating through the medium of air increases with frequency. Hence, the decrease in maximum detectable distance.

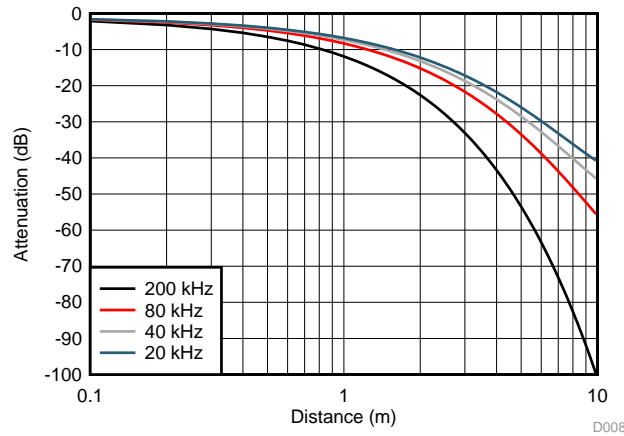


Figure 4. Attenuation Characteristics of Sound Pressure by Distance

Table 2. Transducer Frequency Options

TYPE	LOW FREQUENCY (30-80 kHz)	HIGH FREQUENCY (180-480 kHz)
Benefits	<ul style="list-style-type: none"> <li>Maximize long range performance</li> <li>Large off-the-shelf selection for purchase</li> </ul>	<ul style="list-style-type: none"> <li>Maximize resolution (approximately 1mm)</li> <li>Short blind-zone in monostatic topology</li> <li>Transmission concentrated into forward facing direction (no side lobes)</li> </ul>
Disadvantages	<ul style="list-style-type: none"> <li>Long blind-zone in monostatic topology</li> <li>Low resolution (approximately 1cm)</li> <li>Ultrasonic aggressors likely to be the same frequency</li> </ul>	<ul style="list-style-type: none"> <li>Short maximum detectable range</li> <li>Limited off-the-shelf selection for purchase</li> </ul>

Once the environmental considerations have been accounted for, the selection of the sonar configuration, ultrasonic transducer type, transducer frequency, and driver mode is required. See the [PGA460 Ultrasonic Module Hardware and Software Optimization](#) application note (SLAA732) for details.

### 2.2.2 Sonar Configuration

Air-coupled ultrasonic transducers can be used in a wide variety of applications, from automotive park assist to paper counting and room occupancy detection. The most basic approach to ultrasonic measurements is to use a monostatic configuration for linear time-of-flight ranging. This requires a single transducer to serve as both the transmitter and receiver. The monostatic configuration has limitations to the minimum detectable distance due to the ringing-decay time, and limitations to the maximum detectable distance due to the loading-resonant effects of the transformer or driver circuit.

For improvements to both the minimum and maximum range requirement, a bistatic configuration is required to separate the transmit and receive functions to two independent transducers. The bistatic option allows for near 0-cm detection, especially when the receiving transducer is physically further recessed in comparison to the transmitting transducer. For angular orientation, tracking, and triangulation, three or more ultrasonic transducers are required, whereby each transducer is paired with an independent PGA460 device. A single PGA460 can support the monostatic or bistatic configuration for standalone purposes. [Figure 5](#) shows an example of the monostatic and bistatic configurations

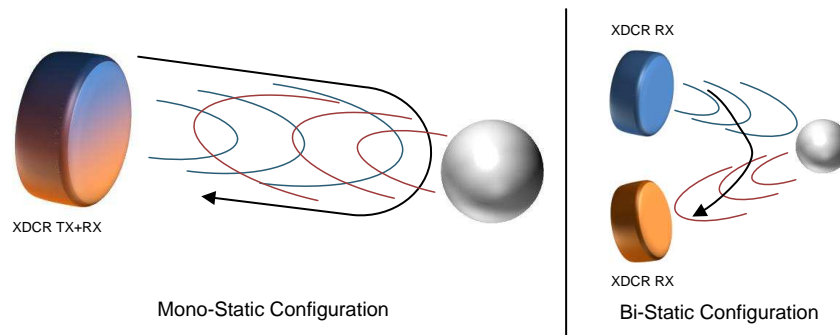


Figure 5. Sonar Configurations

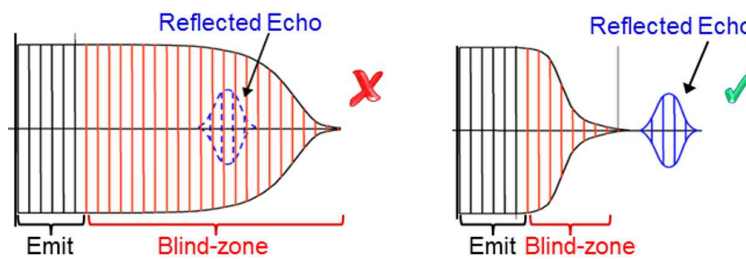


Figure 6. Monostatic Ring Decay Limiting Short Range Detection

Table 3. Sonar Configuration Options

TYPE	MONOSTATIC	BISTATIC
Benefits	<ul style="list-style-type: none"> <li>• Single transducer element can transmit echo, and then listen for returning echoes</li> <li>• No need to consider spacing and angular compensation as with separate elements</li> <li>• Low-cost and small solution size</li> </ul>	<ul style="list-style-type: none"> <li>• Dedicated transmitter can generate more SPL</li> <li>• Dedicated receiver element is more sensitive and receptive of returning ultrasound</li> <li>• No blind-zone allows for near 0-cm detection</li> <li>• Can be used for trip/intercept applications</li> </ul>
Disadvantages	<ul style="list-style-type: none"> <li>• Excitation's ringing-decay creates an initial blind-zone, limiting minimum detectable range</li> <li>• Limited to round trip TOF applications</li> </ul>	<ul style="list-style-type: none"> <li>• TOF round trip calculation must factor in angle of incoming echo at receiver</li> <li>• High-cost and larger solution size</li> </ul>

### 2.2.3 Transducer Selection

Transducer selection initially requires consideration to the operating environment. If the transducer module is exposed to the outdoors, positioned in an active warehouse/production floor, or is highly mobile, and as such that water droplets, dirt, or airborne debris are present, a closed-top or closed-face transducer is recommended. Closed-top transducers are typically hermetically sealed to prevent the piezoelectric membrane from being damaged by environmental debris or alien particles, and are able to tolerate a wider temperature range. As a result of the additional protective overhead from closed-top transducers, the piezoelectric membrane must be excited with a sinusoidal voltage averaging 100Vpp.

If the protective overhead is not required, and the transducer will be operating in a controlled, indoor environment, open-top transducers are available as an alternative. Open-top transducers offer an increase to driver and receiver sensitivity because the piezoelectric membrane is directly exposed to air, and less acoustic impedance mismatch exists at the face of the transducer. Open-top transducers typically require ten times less in their driving voltage requirement, averaging 10Vpp.

**Table 4. Transducer Top Type Options**

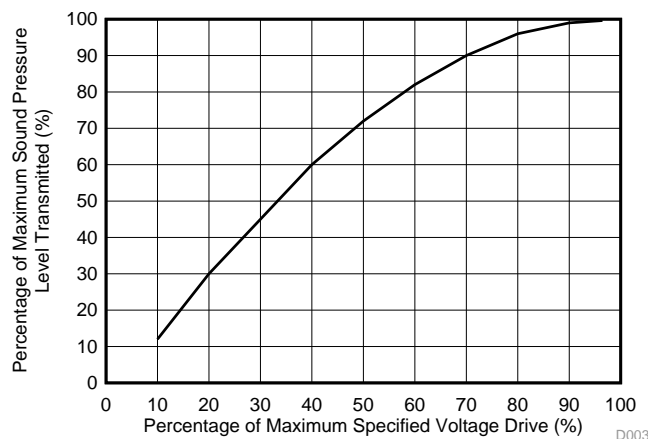
TYPE	CLOSED-TOP	OPEN-TOP
Benefits	<ul style="list-style-type: none"> <li>• Piezoelectric membrane protected against water (hermetically sealed), heat, and humidity</li> <li>• Constructed to mitigate ESD strikes</li> <li>• Suitable for outdoor or harsh environments</li> </ul>	<ul style="list-style-type: none"> <li>• Piezoelectric membrane directly couples to air for increased receiver sensitivity</li> <li>• Small driving voltage to generate maximum SPL</li> <li>• Large off-the-shelf selection for purchase</li> <li>• Low-cost</li> </ul>
Disadvantages	<ul style="list-style-type: none"> <li>• Requires large driving voltage enabled by transformer</li> <li>• Limited off-the-shelf selection for purchase</li> <li>• High-cost</li> </ul>	<ul style="list-style-type: none"> <li>• Limited to indoor or protected environments</li> </ul>

**2.2.4 Driver Selection**

Transducers require a sinusoidal or square-wave voltage driver to properly excite the piezoelectric membrane for oscillation at the specified resonant frequency. Due to the wide variety of air-coupled transducers of the open and closed-top types, maximum drive voltage specifications typically range between 5Vpp to 200Vpp. The driving voltage specification is important to consider when wanting to maximize the amount of sound pressure level (SPL) generated for long distance measurements. SPL is defined as the logarithmic measure of the effective or RMS sound pressure of a sound relative to the threshold of hearing reference value, measured in decibels (dB). At the maximum driving voltage specification, the amount of SPL a transducer is able to generate is saturated, such that driving a transducer beyond the maximum driving specification will not yield in any additional gains. Figure 7 shows the typical relationship between driving voltage and transmittable SPL.

To generate a large driving voltage averaging 100Vpp for closed-top transducers, a single-ended or center-tap transformer is typically paired with the transducer, such that the primary-to-secondary turns ratio acts as a x10 multiplier. This is a common turns ratio assuming a PGA460 supply voltage of 6-18VDC. The transformer driver mode enables a low-voltage DC reference to be amplified at the secondary as a sinusoidal waveform.

If a smaller driving voltage averaging 10Vpp is required for open-top transducers, the transformer can be replaced with a direct driver using either half-bridge or full-bridge. The direct driver mode allows the PGA460 and transducer to reference the same supply voltage without the need for any boost circuitry to excite the transducer. The PGA460 can only use the monostatic configuration in half-bridge mode. The full-bridge mode is only compatible in the bistatic configuration when using the PGA460. Closed-top transducers can be direct-driven for short to mid-range applications, but will not generate the maximum amount of transmittable SPL for long distance applications.



**Figure 7. Voltage Driver vs Sound Pressure Level**

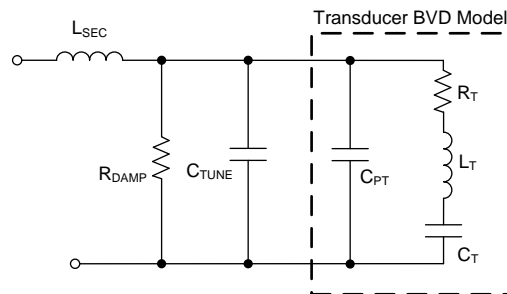


**Table 5. Transducer Driver Mode Options**

TYPE	TRANSFORMER	DIRECT
Benefits	<ul style="list-style-type: none"> <li>• Able to maximize drive requirements for closed-top transducers (beyond 100Vpp)</li> <li>• Equivalent circuit enables de/tuning for short range</li> <li>• Fixed and tunable coil types available</li> <li>• Center-tap push-pull or single-ended available</li> </ul>	<ul style="list-style-type: none"> <li>• Able to maximize drive requirement for open-top transducers (beyond 6Vpp)</li> <li>• Able to drive closed-top transducer for short range applications</li> <li>• Half-bridge or full-bridge drive topology available</li> <li>• Low-cost and small footprint</li> </ul>
Disadvantages	<ul style="list-style-type: none"> <li>• Additional calibration required at mass production</li> <li>• High-cost and large footprint</li> </ul>	<ul style="list-style-type: none"> <li>• Short range tuning limited to damping resistor due to lacking inductive element</li> </ul>

### 2.2.5 Passive Tuning

Transducer and transformer modeling must be considered when optimizing the ultrasonic module for short distance measurements to minimize the ringing-decay time of monostatic configurations. The decay profile of all transducers are not identical, therefore the tuning values will be specific for a particular transducer part number.



**Figure 8. Transducer and Transformer Electrical Model With Tuning Components**

#### 2.2.5.1 Tuning Capacitor

When using the transformer driven mode, the equivalent circuit of the transformer introduces additional parasitics. The parasitic characteristic with the greatest performance-impact is the transformer’s secondary side leakage inductance ( $L_{SEC}$ ). The transducer resonates most efficiently at a single frequency. For instance, a 4-kHz transducer cannot be driven at 20, 30, or 50 kHz, because any drift from the resonant frequency yields a loss in SPL. When the series inductance is introduced to the transducer, the driving frequency, the equivalent BVD model of the transducer, and the effective versus expected receiving frequency may be at a mismatch. To match the secondary inductance of the transformer to the resonant frequency of the transducer, a tuning capacitor ( $C_{TUNE}$ ) is added in parallel to the transducer.

Use Equation 1 to solve for  $C_{TUNE}$ :

$$C_{TUNE} = \frac{C_T \times L_T}{L_{SEC}} - C_{PT} \tag{1}$$

If the tuning capacitor is too large, the attenuation factors increase significantly. Typical values for the tuning capacitance range from 50 pF to 5000 pF. When driving the transducer in half-bridge and full-bridge, resonance is primarily dependent on the transducer, so a tuning capacitor is not required.

### 2.2.5.2 Damping Resistor

The damping resistor ( $R_{DAMP}$ ) is a resistor added in parallel to the transducer to help reduce the ringing-decay time without significantly jeopardizing the driver strength to maximize long distance measurements. A damping resistor is able to benefit both the transformer-driven and bridge-driven modes as a bleed-out resistor immediately at post-excitation. The damping resistor has minute loading effects on the transducer during the bursting and receive segments, so a damping resistor is recommended for any monostatic configuration. Due to the complexity and number of components at the transducer, optimizing the value of  $R_{DAMP}$  is currently an arbitrary process of monitoring the decay profile by trial-and-error. Given the value of  $R_{DAMP}$  ranges between 500  $\Omega$  to 30 k $\Omega$ , TI recommends to use a potentiometer to sweep and fine-tune the value for the specific sensor, driver, and component combination.

### 2.2.5.3 Tunable Transformer

In addition to the appended tuning capacitor, variable coil transformers offer the ability to further tune the secondary side inductance of the transformer. The tunable transformer can be adjusted by the screw type of the top notch on the transformer. This is especially useful for systems that require short distance optimization. To observe the effects of tuning the transformer, the ringing-decay profile or low-noise amplifier output must be monitored. Figure 9 shows the ringing-decay profile of a transducer before and after the transformer is tuned for a 600- $\mu$ s (10-cm) improvement.

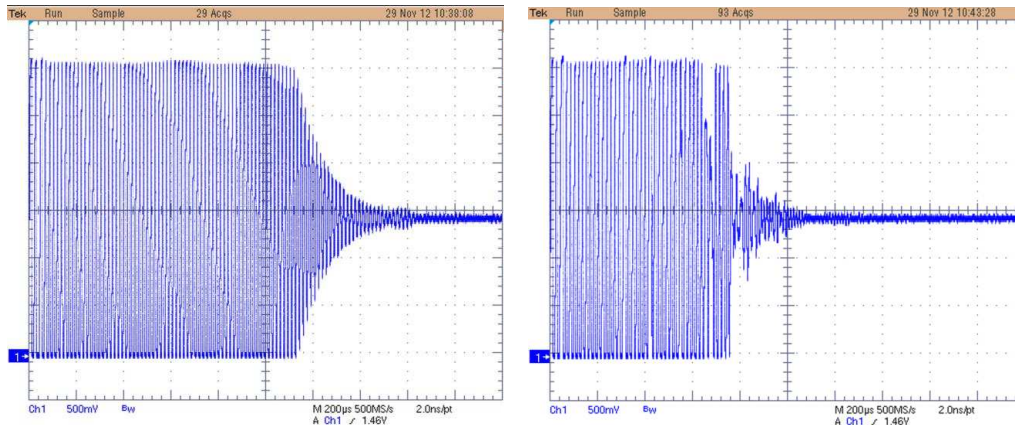


Figure 9. Ringing-Decay Time Before and After Tuning of Variable Coil Transformer

## 2.3 Highlighted Products

### 2.3.1 PGA460 Ultrasonic Sensor Signal Conditioner and Driver

The PGA460 device is a highly-integrated system on-chip ultrasonic transducer driver and signal conditioner with an advanced DSP core. The device has a complimentary low-side driver pair that can drive a transducer either in a transformer based topology using a step-up transformer or in a direct drive topology using external high-side FETs. The device can receive and condition the reflected echo signal for reliable object detection. This feature is accomplished using an analog front-end (AFE) consisting of a low-noise amplifier followed by a programmable time-varying gain stage feeding into an ADC. The digitized signal is processed in the DSP core for both near-field and far-field object detection using time-varying thresholds.

The main communication with an external controller is achieved by either a time-command interface (TCI) or a one-wire USART asynchronous interface on the IO pin, or a CMOS-level USART interface on the RXD and TXD pins. The PGA460 can be put in ultra-low quiescent current low-power mode to reduce power consumption when not in use and can be woken up by commands on the communication interfaces.

The PGA460 also includes on-chip system diagnostics which monitor transducer voltage during burst, frequency and decay time of transducer to provide information about the integrity of the excitation as well as supply-side and transceiver-side diagnostics for overvoltage, undervoltage, overcurrent and short-circuit scenarios.

## 2.4 System Design Theory

The PGA460 device is a signal-conditioning and transducer-driver device for ultrasonic sensing for object or distance sensing. The output driver consists of complimentary low-side drivers capable of driving a center-tap transformer to generate large excitation voltages across an ultrasonic transducer and as a result create the desired sound pressure level (SPL). The output driver can also be configured to be used in direct-drive mode without a transformer using external FETs. The output driver implements configurable current limit for efficient driving of the transformer and configurable bursting frequencies and burst length to be compatible with a large number of transducers.

The analog front-end (AFE) can sense the received echo from the transducer and amplify it for correct object detection. The AFE implements a low-noise amplifier followed by a time-varying gain amplifier that allows signals from objects at a variable distance to be amplified correspondingly. This implementation allows for the maximum dynamic range of the ADC to be used for both near-field and far-field objects in the same recording. An embedded temperature sensor can be used to calibrate the signal conditioner for changes in temperature. The digital signal processing path further filters the received echo and uses time-varying thresholds for accurate detection of objects. Two presets for both bursting and thresholds are available, which allow faster detection cycles by saving time required to configure the device between multiple bursts. Most configuration parameters are stored in nonvolatile memory for a quick power up to reduce initialization time.

The PGA460 device provides multiple IO protocols to communicate with the master controller. The device provides a time-command interface and one-wire UART on the VPWR reference IO pin. It also provides both synchronous and asynchronous USART on the TXD, RXD, and SCLK pins.

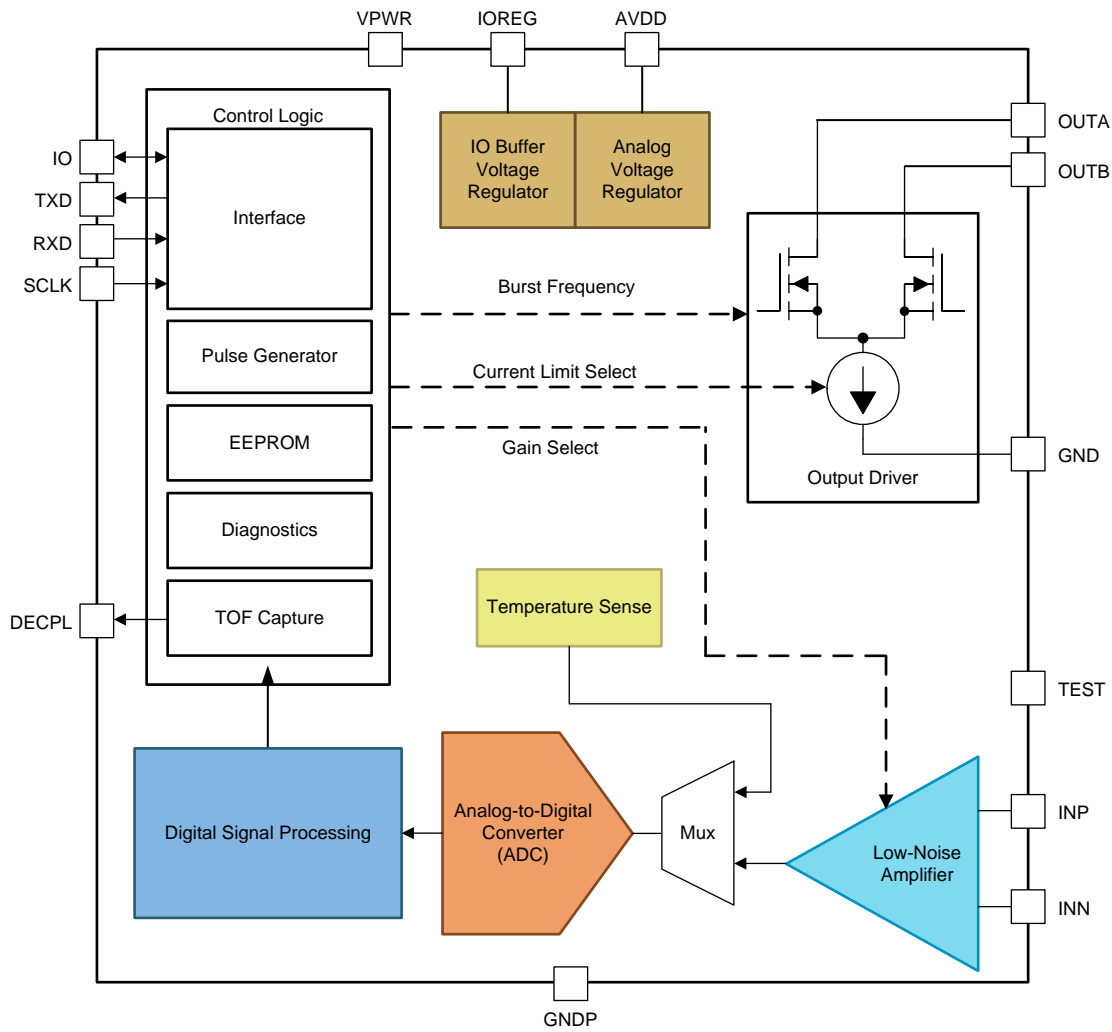


Figure 10. PGA460 Block Diagram

### 3 Hardware, Software, Testing Requirements, and Test Results

#### 3.1 Required Hardware and Software

The PGA460-Q1 EVM and GUI is used for the evaluation of the PGA460PSM.

##### 3.1.1 Hardware

The PGA460-Q1 EVM consists of two boards: the MSP-EXP430F5529LP and the BOOSTXL-PGA460. If you are evaluating the PGA460PSM in UART or SPI interface mode, then only the MSP-EXP430F5529LP is required. The PGA460PSM will connect directly to the LaunchPad's UART or SPI pin. The standard PGA460-Q1 EVM GUI is designed for UART evaluation. For SPI evaluation, refer to the supporting Energia code examples. If you are evaluating the PGA460PSM in TCI or OWU automotive interface mode, then the BOOSTXL-PGA460 will be required for the one-wire transceiver.

##### 3.1.1.1 External PGA460-Q1 Evaluation

This section provides a detailed description on connecting external PGA460-Q1 devices to the PGA460-Q1 EVM to reuse the EVM GUI.

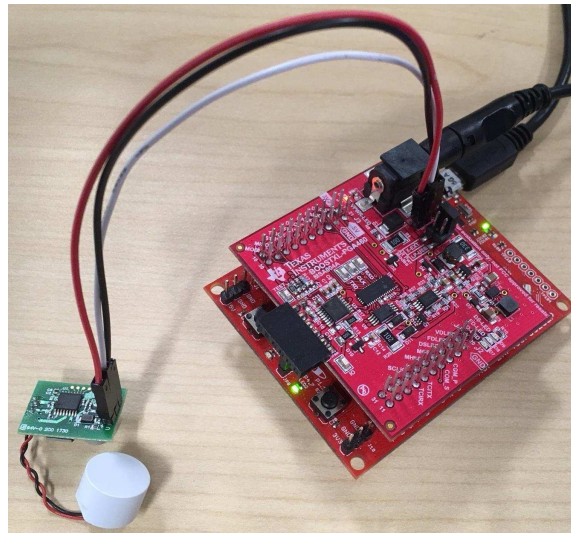
##### 3.1.1.2 External PGA460-Q1 Module Compatibility and Connections for IO Communication

When the user has completely evaluated the PGA460-Q1 EVM and GUI, the next step typically involves evaluation of custom hardware. Instead of using the BOOSTXL-PGA460, the user may build a custom small- or system-form factor module with the intention to continue the device evaluation using only the PGA460-Q1 GUI. Examples of small-form factor PGA460-Q1 reference designs are available on [www.ti.com](http://www.ti.com). By detaching the BOOSTXL-PGA460 from the PGA460-Q1 EVM, the MSP-EXP430F5529LP can still be used as the master controller and interface to the PGA460-Q1 GUI through logic level USART. However, if the one-wire interface's TCI or OWU modes are to be routed to the external PGA460-Q1 module, the BOOSTXL-PGA460 motherboard is required, and additional register modifications must be made to the onboard PGA460-Q1 device.

##### 3.1.1.3 IO Transceiver Circuit

The PGA460 device onboard the BOOSTXL-PGA460 is always connected to the One-Wire Interface (OWI) IO transceiver circuit. To prevent crosstalk or data collision between the onboard and external PGA460-Q1 devices, the user has two options:

- **Software Modification:** Disable the onboard PGA460-Q1's IO pin transceiver before connecting the external module. To do so, the IO\_IF\_SEL bit must be set to 0, and then the IO\_DIS bit must be set to 1, which immediately disables the IO pin transceiver. After applying these register modifications, communication to the onboard PGA460-Q1 is only possible through the RXD, TXD, and SCLK pins. To ensure the IO transceiver of the onboard PGA460 remains disabled upon power-cycle, EEPROM program the device to save the IO transceiver settings. Now the BOOSTXL-PGA460's J6 connector block containing VPWR, IO, and GND can be used to connect a three-pin external module. As an additional precaution to eliminate any potential crosstalk or data collision between the onboard and external PGA460-Q1 devices in OWU mode, set different UART\_ADDR values. TI recommends that the onboard PGA460-Q1's UART\_ADDR be set to a value of 0x7 to allow the external PGA460-Q1 to use the default factory address of 0x0.
- **Hardware Modification:** Desolder the R15 0-Ω short which typically connects the OWI transceiver to the onboard IO pins of the PGA460-Q1. Now the BOOSTXL-PGA460's J6 connector block containing VPWR, IO, and GND can be used to connect a three-pin external module. This hardware-only modification is required for IO-TCI communication. However, when using IO-OWU, different UART\_ADDR address values can be used to differentiate between the onboard and external PGA460-Q1 devices.



**Figure 11. External OWI Evaluation Setup for PGA460PSM With Software Modification**

Alternatively, to using the BOOSTXL-PGA460's One-Wire Interface transceiver circuit, an external OWI transceiver circuit can be connected to the MSP-EXP430F5529LP. The discrete OWI transceiver circuit on the BOOSTXL-PGA460 allows OWU to operate up to 115.2kBaud. For solutions that only use TCI or OWU at 19.2kBaud or less, the SN65HVDA100-Q1 LIN Physical Interface can be used as an integrated OWI transceiver solution.

## 3.1.2 Software

### 3.1.2.1 One-Wire Evaluation Page

When using the BOOSTXL-PGA460 OWI transceiver for evaluation of an external module, the PGA460-Q1 EVM GUI can be enabled to display a page specific to external OWI evaluation. This OWI Evaluation page uses the in-system, IO-pin interface selection toggle pattern to constantly switch between TCI and OWU modes to maximize the speed of OWI evaluation. TCI mode is used strictly for real-time IO toggle response object detection, while OWU is used for all other register read and write features. If the TCI communicates at a speed equivalent to 3.3kBaud, then the OWU operating at 115.2kBaud is more suitable for register read and write commands. The benefit of using the OWI Evaluation page is that all device settings are made available on a single page to prevent the need to switch between multiple pages. This advanced condensed view of all device settings assumes the user is familiar with the features, thus details are limited to conserve space on the page.

To enable the OWI Evaluation page, navigate to the top of the GUI menu bar. From the Edit drop-down, the GUI Initialization Mode is set to BOOSTXL-PGA460 (Standard) by default. Change this selection to External IO-Pin Only. The GUI will then prompt the user to automatically apply the onboard IO transceiver software modifications described in [Section 3.1.1.3](#). If no onboard IO transceiver modifications were applied, then follow the GUI's instructions and click Yes. If the appropriate modifications were applied, then click No. Once all register changes and hardware connections are ready, the GUI will automatically restart or be manually restarted to reveal and initialize to the OWI Evaluation page.

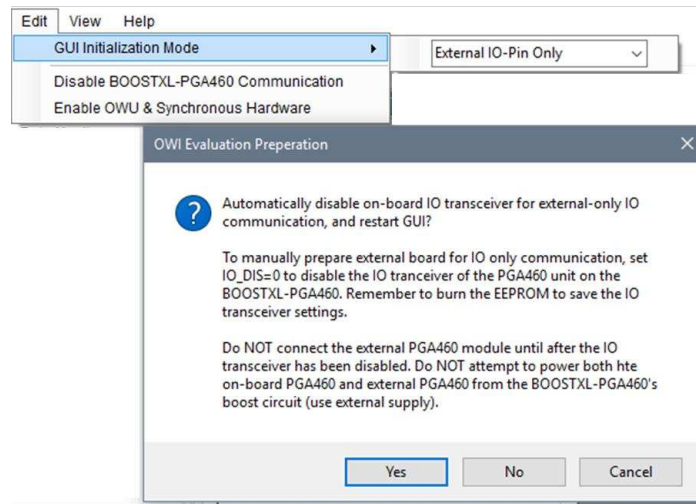


Figure 12. OWI Evaluation Page Preparation

When the GUI Initialization Mode is set, the GUI will always start in that mode until the initialization mode is changed from the Edit drop-down menu. Thus, TI recommends reverting the GUI Initialization Mode to BOOSTXL-PGA460 (Standard) to revert to the standard UART mode of initialization and evaluation. Ensure to restart the GUI after changing the initialization mode.

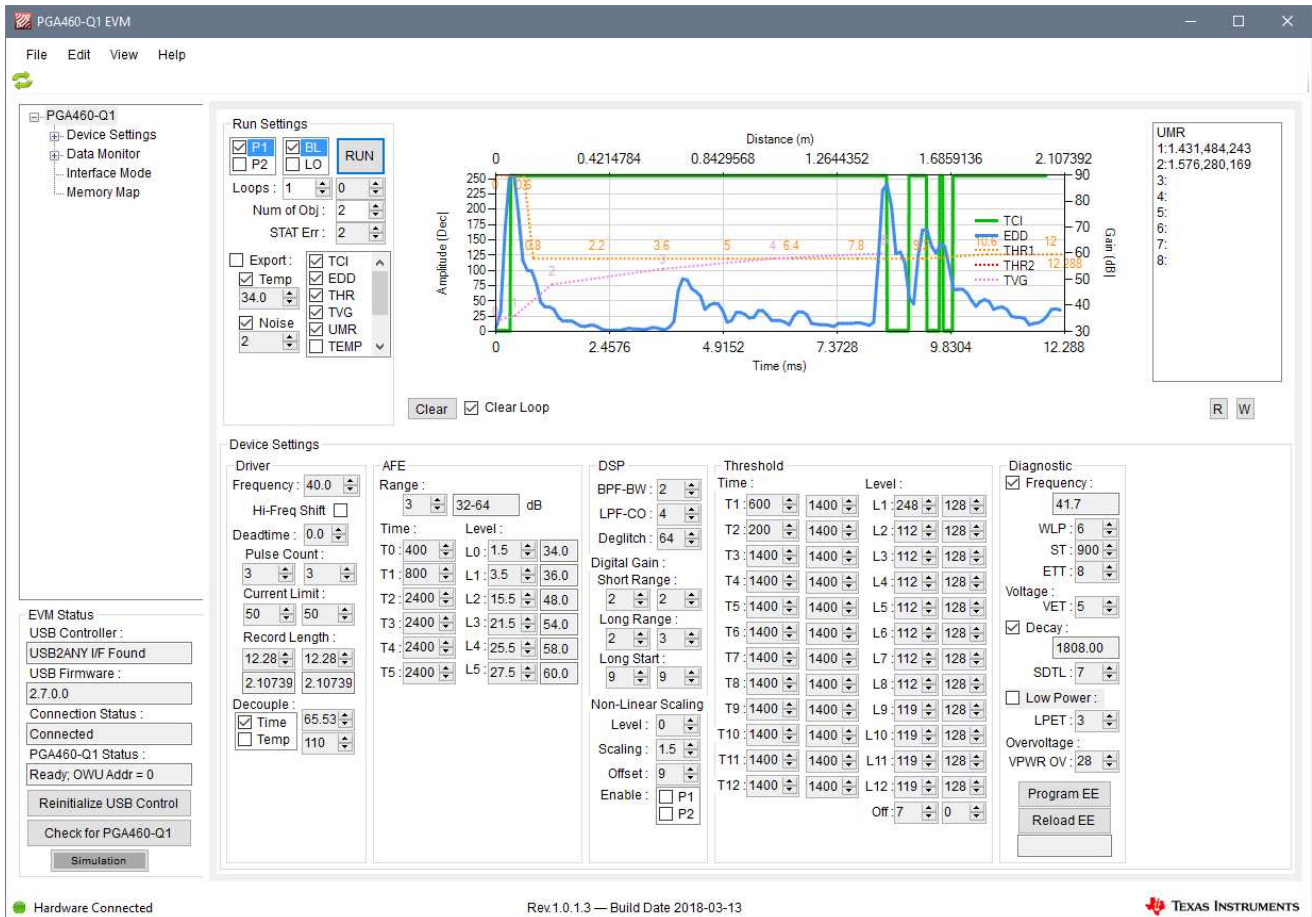


Figure 13. One-Wire Evaluation Page - Working Example

The OWI Evaluation settings are defined as follows:

**Run Settings** —Similarly to the Data Monitor page, this box allows the user to define which preset and burst/listen type is to run. In addition, the number of loops (1-1000) and the number of objects for the Ultrasonic Measurement Results can be defined. When the TCI mode is enabled, the STAT error will be updated here. Each item in the check box corresponds to a run type. The default run mode will obtain the TCI response, the Echo Data Dump response, and the Ultrasonic Measurement Results in a single loop. This means three independent burst/listen commands are run to obtain each set of data points. In addition to ultrasonic echo activity, the threshold and time varying gain profiles are mapped to the OWI chart by default. Items can be checked or unchecked based on the information to be displayed. When the export box is checked, each data point associated with the checked item in the check box list will be saved to a single XML file for postprocessing. A separate TXT file is created and saved from the Utilities-Datalog box for UMR, TEMP, NOISE, FREQ, and DECAY, because these data points are not included on the OWI chart. The exported files are automatically saved to the "My Documents > BOOSTXL-PGA460" path. When the Temp and Noise boxes are checked, the PGA460-Q1 will run independent temperature or noise measurements per item

**OWI Chart** —The data points for TCI, EDD, THR, and/or TVG are plotted and overlapped on this chart based on their checked state in the Run Settings. Each loop will automatically clear, unless the Clear Loop box is unchecked. To clear the chart manually, click the Clear button. When UMR is enabled from the Run Settings, the UMR results list box will appear to the right of the OWI chart.

**Device Settings** — All device settings for the Driver, Analog Front End (AFE), Digital Signal Processing (DSP), Thresholding, and Diagnostic are made available here. Whenever a value is manually updated, the control will highlight yellow to indicate the value has changed, and is queued to update on the next run command. The register settings are not written to until the run command is sent from the Run Settings.

**Memory Map** — All register settings can be manually read and written to using the R and W buttons below the OWI Chart. When the Read (R) button is clicked, the Device Settings section is updated with the latest values read from the PGA460-Q1. When the Write (W) button is clicked, only the Device Settings highlighted in yellow will be updated. Otherwise, there will be no change to the value since the last read. From the Memory Map page, the grid can be loaded with a previously saved memory map TXT file. Once the grid has been updated with the TXT file import, the user must click the Write All button to apply the updated Device Settings to the externally connected OWI device. The OWI device settings can also be saved to a TXT file for later use.



## 3.2 Testing and Results

### 3.2.1 Test Setup

The PGA460PSM is tested in an open-floor environment to prevent unwanted reflections from walls and/or the ceiling. A 9-V battery is used to supply the PSM and the PGA460Q1EVM. The PGA460Q1EVM-GUI is used to configure the PSM and collect PSM echo data. A plastic PVC pole measuring 1 m in height and 75 mm in diameter is used as a universal target type for long range measurements. The recommended external passive matching circuit is listed for specific transducer and transformer combinations in [Table 6](#).

**Table 6. Matching Circuit Values for Various Closed-Top Transducers and Transformers**

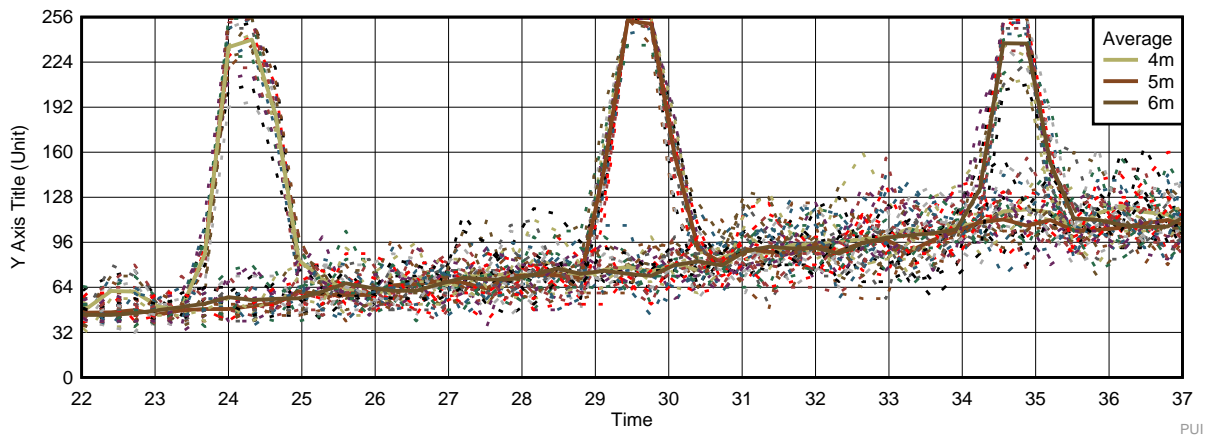
	PUI AUDIO UTR-1440K-TT-R	STEMINC SMATR10H60X80	MURATA MA58MF14-7N
TDK EPCOS B78416A2232A003	$C_{TUNE}=3.9\text{nF}$ $R_{DAMP}=3.9\text{k}\Omega$	$C_{TUNE}=1.2\text{nF}$ $R_{DAMP}=10\text{k}\Omega$	$C_{TUNE}=0.68\text{nF}$ $R_{DAMP}=10\text{k}\Omega$
Würth 750317161	$C_{TUNE}=3.9\text{nF}$ $R_{DAMP}=3.9\text{k}\Omega$	$C_{TUNE}=1.2\text{nF}$ $R_{DAMP}=10\text{k}\Omega$	$C_{TUNE}=0.68\text{nF}$ $R_{DAMP}=10\text{k}\Omega$
Coilcraft WA8351- AL	$C_{TUNE}=3.9\text{nF}$ $R_{DAMP}=3.9\text{k}\Omega$	$C_{TUNE}=1.2\text{nF}$ $R_{DAMP}=10\text{k}\Omega$	$C_{TUNE}=0.68\text{nF}$ $R_{DAMP}=10\text{k}\Omega$

### 3.2.2 Test Results

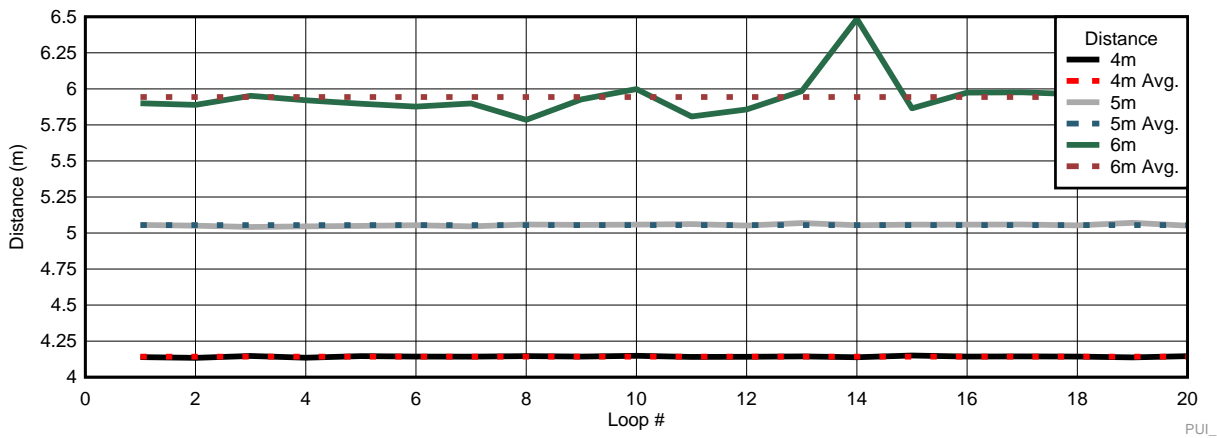
Each set of results highlights the long range performance of the given transducer. Acceptable long range performance is considered to have a signal-to-noise (SNR) ratio of 3:1 at a distance of greater than or equal to 2 m.

#### 3.2.2.1 PUI Audio UTR-1440K-TT-R

The PUI Audio transducer has an accuracy of  $\leq 1$  cm up to 5 m. At 6 m, stability is shown to fluctuate an average of 10 cm.

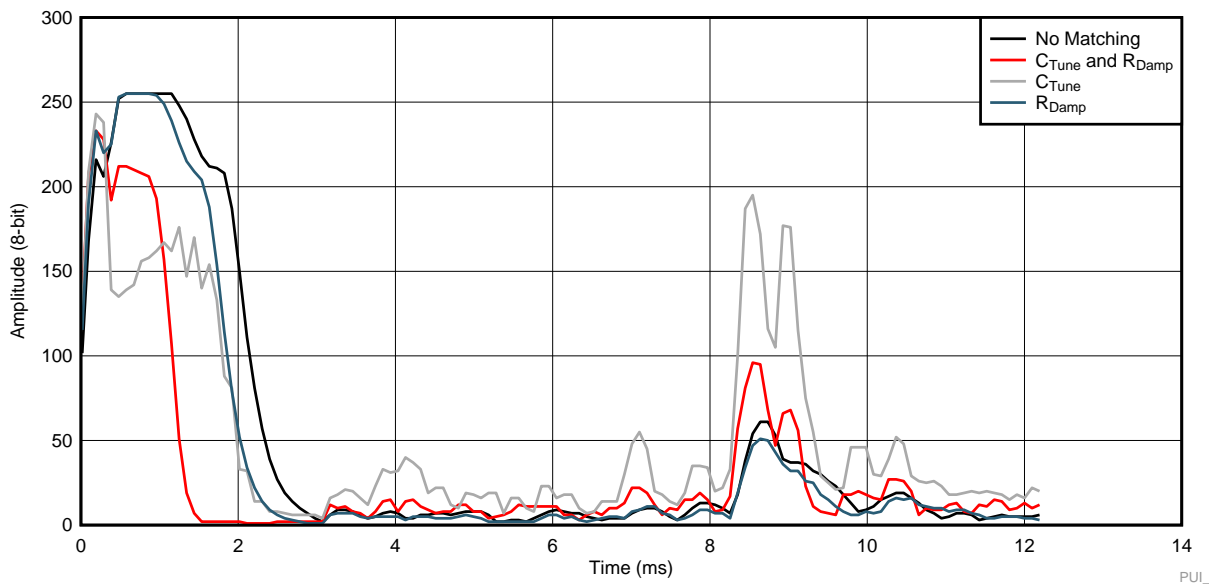


**Figure 14. PUI Audio Long Range Echo Data Dump Performance at 4, 5, and 6 m**



**Figure 15. PUI Audio Long Range Measurement Results at 4, 5, and 6 m**

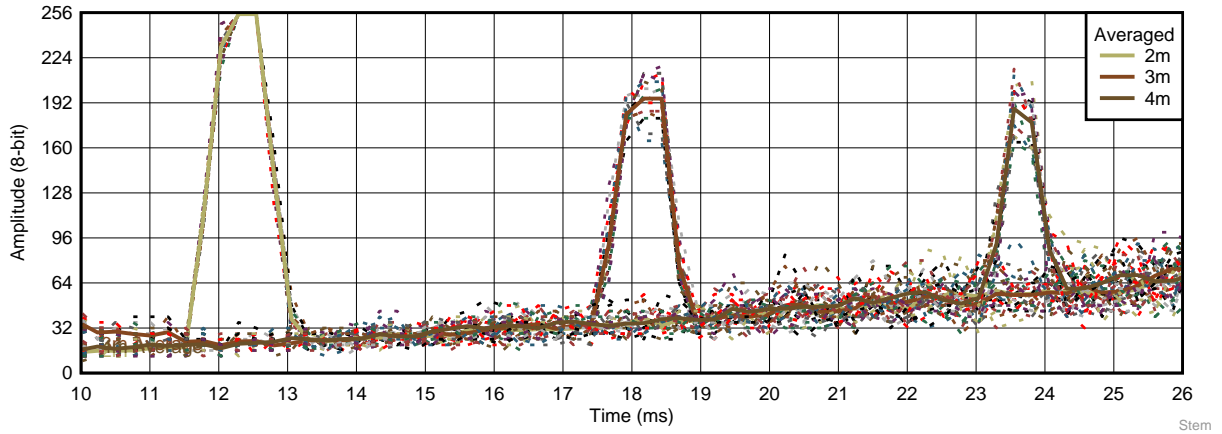
When optimizing the PUI Audio transducer for short range detection, a matching circuit must be implemented in parallel to the transducer. The combination of adding both the tuning capacitor and damping resistor enables minimum object detection down to 15 cm, compared to 40 cm without any matching components. Adding the matching circuit also improves overall SNR and peak return echo amplitude performance. If only long range performance is of importance to the application, then adding only the tuning capacitor yields the greatest SNR improvement to improve 6-m stability. Adding the damping resistor barely improves minimum range detection by a few centimeter.



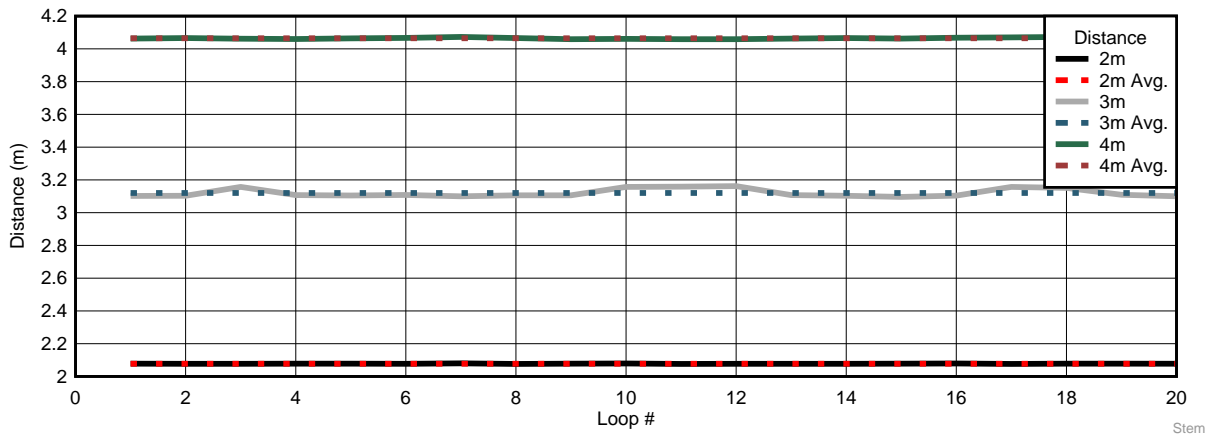
**Figure 16. PUI Audio Short Range Matching Options With Reference Object at 1.4 m**

### 3.2.2.2 Steminc SMATR10H60X80

The Steminc transducer has an accuracy of  $\leq 1$  cm up to 4 m. Object detection was unreliable at 5 m.



**Figure 17. Steminc Long Range Echo Data Dump Performance at 2, 3, and 4 m**



**Figure 18. Steminc Long Range Measurement Results at 2, 3, and 4 m**

The minimum detectable range of the Steminc transducer is 15 cm with proper matching, and 40 cm without matching.

### 3.2.2.3 Murata MA58MF14-7N

The Murata transducer has an accuracy of  $\leq 1$  cm up to 6 m. For this transducer, the center-tap voltage at the transformer was set to 6 V, 9 V, and 12 V for each distance measurement to compare SNR performances. All voltages yielded positive results up to 6 m. The 6-V supply was only 70% effective, however, at detecting the pole at 6 m.

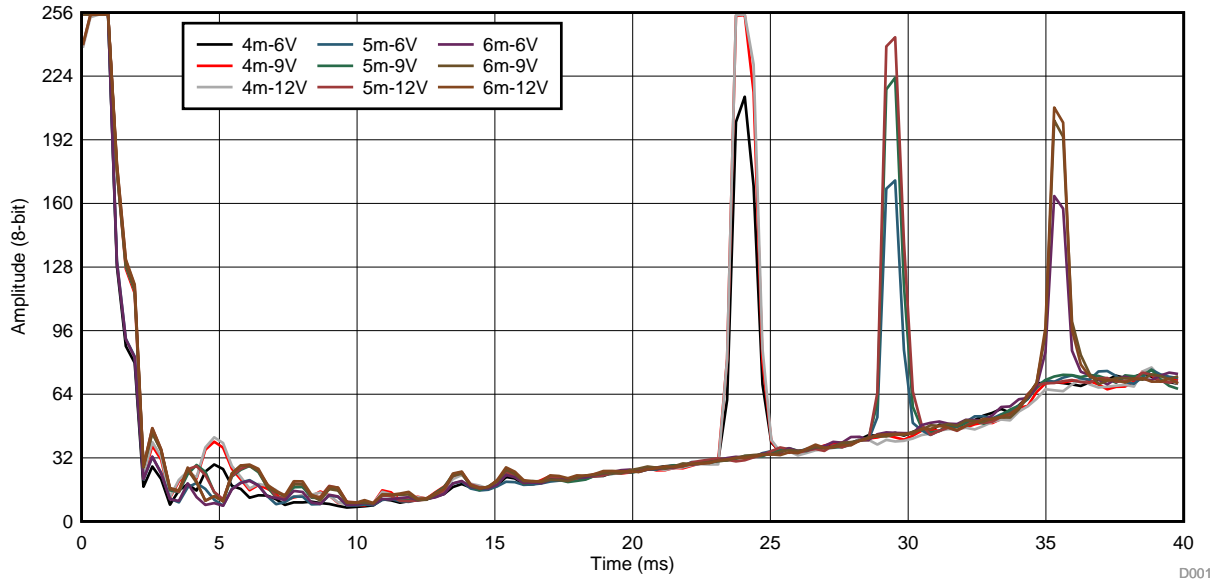


Figure 19. Murata Long Range Echo Data Dump Performance (100 Samples Averaged) at 4, 5, and 6 m With Voltages of 6, 9, and 12 V

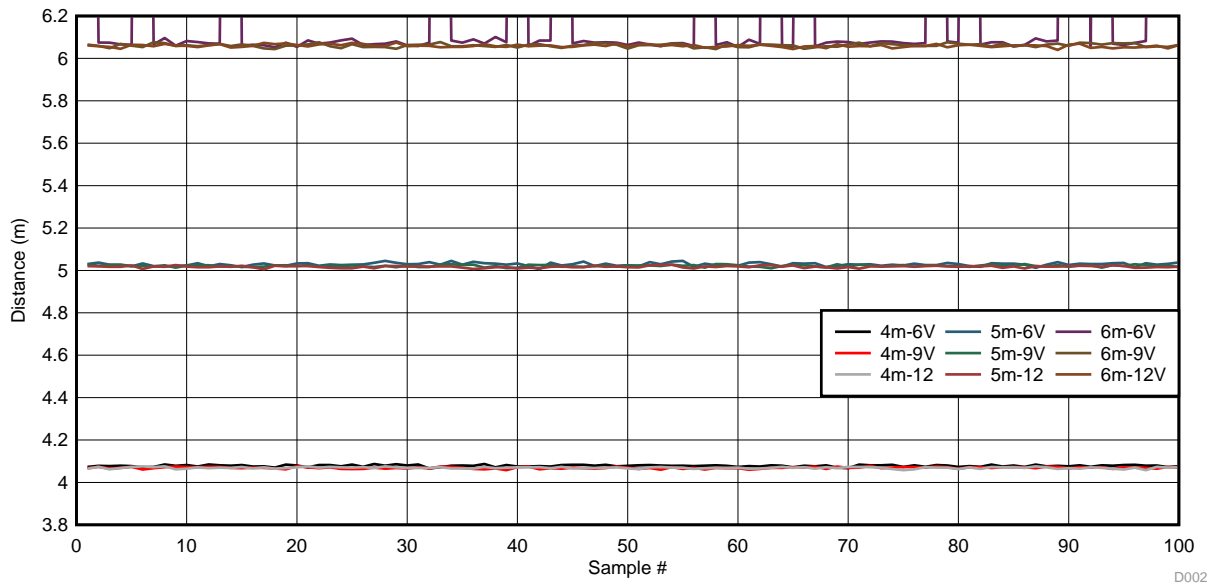


Figure 20. Murata Long Range Measurement Results (100 Samples Averaged) at 4, 5, and 6 m With Voltages of 6, 9, and 12 V

The minimum detectable range of the Murata transducer is 15 cm with proper matching, and 40 cm without matching.

PGA460-Q1 EVM GUI memory map text file configuration of the Murata MA58MF14-7N transducer:

```

;GRID_USER_MEMSPACE      1C (FREQUENCY),8F      5F (P1_THR_0),41
00 (USER_DATA1),41      1D (DEADTIME),80      60 (P1_THR_1),11
01 (USER_DATA2),11      1E (PULSE_P1),12      61 (P1_THR_2),11
02 (USER_DATA3),11      1F (PULSE_P2),12      62 (P1_THR_3),10
03 (USER_DATA4),10      20 (CURR_LIM_P1),72    63 (P1_THR_4),FF
04 (USER_DATA5),FF      21 (CURR_LIM_P2),32    64 (P1_THR_5),FF
05 (USER_DATA6),FF      22 (REC_LENGTH),09     65 (P1_THR_6),00
06 (USER_DATA7),00      23 (FREQ_DIAG),00     66 (P1_THR_7),01
07 (USER_DATA8),00      24 (SAT_FDIAG_TH),EE   67 (P1_THR_8),F8
08 (USER_DATA9),08      25 (FVOLT_DEC),7C     68 (P1_THR_9),20
09 (USER_DATA10),20     26 (DECPL_TEMP),8F     69 (P1_THR_10),C6
0A (USER_DATA11),C6     27 (DSP_SCALE),00     6A (P1_THR_11),30
0B (USER_DATA12),30     28 (TEMP_TRIM),00     6B (P1_THR_12),38
0C (USER_DATA13),38     29 (P1_GAIN_CTRL),29   6C (P1_THR_13),50
0D (USER_DATA14),50     2A (P2_GAIN_CTRL),29   6D (P1_THR_14),80
0E (USER_DATA15),80     2B (EE_CRC),76        6E (P1_THR_15),00
0F (USER_DATA16),00     40 (EE_CNTRL),04      6F (P2_THR_0),41
10 (USER_DATA17),00     41 (BPF_A2_MSB),89     70 (P2_THR_1),11
11 (USER_DATA18),00     42 (BPF_A2_LSB),52     71 (P2_THR_2),11
12 (USER_DATA19),00     43 (BPF_A3_MSB),FC     72 (P2_THR_3),10
13 (USER_DATA20),00     44 (BPF_A3_LSB),CE     73 (P2_THR_4),FF
14 (TVGAIN0),9D         45 (BPF_B1_MSB),01     74 (P2_THR_5),FF
15 (TVGAIN1),EE         46 (BPF_B1_LSB),99     75 (P2_THR_6),00
16 (TVGAIN2),EF         47 (LPF_A2_MSB),7F     76 (P2_THR_7),01
17 (TVGAIN3),2D         48 (LPF_A2_LSB),33     77 (P2_THR_8),F8
18 (TVGAIN4),B9         49 (LPF_B1_MSB),00     78 (P2_THR_9),20
19 (TVGAIN5),EF         4A (LPF_B1_LSB),67     79 (P2_THR_10),C6
1A (TVGAIN6),DC         4B (TEST_MUX),00       7A (P2_THR_11),30
1B (INIT_GAIN),03       4C (DEV_STAT0),80      7B (P2_THR_12),38
                        4D (DEV_STAT1),00      7C (P2_THR_13),50
                        7D (P2_THR_14),80
                        7E (P2_THR_15),00
                        7F (THR_CRC),F9
                        EOF

```

## 4 Design Files

### 4.1 Schematics

To download the schematics, see the design files at [TIDA-060024](#).

### 4.2 Bill of Materials

To download the bill of materials (BOM), see the design files at [TIDA-060024](#).

### 4.3 PCB Layout Recommendations

#### 4.3.1 Layout Prints

To download the layer plots, see the design files at [TIDA-060024](#).

### 4.4 Altium Project

To download the Altium Designer® project files, see the design files at [TIDA-060024](#).

### 4.5 Gerber Files

To download the Gerber files, see the design files at [TIDA-060024](#).

### 4.6 Assembly Drawings

To download the assembly drawings, see the design files at [TIDA-060024](#).

## 5 Software Files

To download the software files, see the design files at [TIDA-060024](#).

## 6 Related Documentation

1. [PGA460 Ultrasonic Signal Processor and Transducer Driver data sheet](#) (SLASEJ4)
2. [PGA460PSM-EVM User's Guide](#) (SLAU817)
3. [PGA460 Ultrasonic Module Hardware and Software Optimization application report](#) (SLAA732)
4. [PGA460-Q1 Ultrasonic Signal Conditioner EVM With Transducer User's Guide](#) (SLAU659)

### 6.1 Trademarks

E2E is a trademark of Texas Instruments.

Altium Designer is a registered trademark of Altium LLC or its affiliated companies.

All other trademarks are the property of their respective owners.

### 6.2 Third-Party Products Disclaimer

TI'S PUBLICATION OF INFORMATION REGARDING THIRD-PARTY PRODUCTS OR SERVICES DOES NOT CONSTITUTE AN ENDORSEMENT REGARDING THE SUITABILITY OF SUCH PRODUCTS OR SERVICES OR A WARRANTY, REPRESENTATION OR ENDORSEMENT OF SUCH PRODUCTS OR SERVICES, EITHER ALONE OR IN COMBINATION WITH ANY TI PRODUCT OR SERVICE.

## IMPORTANT NOTICE AND DISCLAIMER

TI PROVIDES TECHNICAL AND RELIABILITY DATA (INCLUDING DATA SHEETS), DESIGN RESOURCES (INCLUDING REFERENCE DESIGNS), APPLICATION OR OTHER DESIGN ADVICE, WEB TOOLS, SAFETY INFORMATION, AND OTHER RESOURCES "AS IS" AND WITH ALL FAULTS, AND DISCLAIMS ALL WARRANTIES, EXPRESS AND IMPLIED, INCLUDING WITHOUT LIMITATION ANY IMPLIED WARRANTIES OF MERCHANTABILITY, FITNESS FOR A PARTICULAR PURPOSE OR NON-INFRINGEMENT OF THIRD PARTY INTELLECTUAL PROPERTY RIGHTS.

These resources are intended for skilled developers designing with TI products. You are solely responsible for (1) selecting the appropriate TI products for your application, (2) designing, validating and testing your application, and (3) ensuring your application meets applicable standards, and any other safety, security, regulatory or other requirements.

These resources are subject to change without notice. TI grants you permission to use these resources only for development of an application that uses the TI products described in the resource. Other reproduction and display of these resources is prohibited. No license is granted to any other TI intellectual property right or to any third party intellectual property right. TI disclaims responsibility for, and you will fully indemnify TI and its representatives against, any claims, damages, costs, losses, and liabilities arising out of your use of these resources.

TI's products are provided subject to [TI's Terms of Sale](#) or other applicable terms available either on [ti.com](http://ti.com) or provided in conjunction with such TI products. TI's provision of these resources does not expand or otherwise alter TI's applicable warranties or warranty disclaimers for TI products.

TI objects to and rejects any additional or different terms you may have proposed.

Mailing Address: Texas Instruments, Post Office Box 655303, Dallas, Texas 75265  
Copyright © 2022, Texas Instruments Incorporated