

**SN5432, SN54LS32, SN54S32,
SN7432, SN74LS32, SN74S32**
QUADRUPLE 2-INPUT POSITIVE-OR GATES
DECEMBER 1983 - REVISED MARCH 1988

- Package Options Include Plastic "Small Outline" Packages, Ceramic Chip Carriers and Flat Packages, and Plastic and Ceramic DIPs
- Dependable Texas Instruments Quality and Reliability

SN5432, SN54LS32, SN54S32 . . . J OR W PACKAGE
SN7432 . . . N PACKAGE
SN74LS32, SN74S32 . . . D OR N PACKAGE

description

These devices contain four independent 2-input OR gates.

The SN5432, SN54LS32 and SN54S32 are characterized for operation over the full military range of -55°C to 125°C. The SN7432, SN74LS32 and SN74S32 are characterized for operation from 0°C to 70°C.

FUNCTION TABLE (each gate)

INPUTS		OUTPUT
A	B	Y
H	X	H
X	H	H
L	L	L

logic symbol†

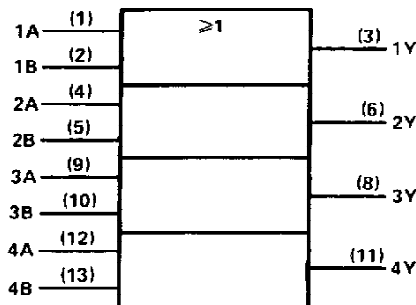

† This symbol is in accordance with ANSI/IEEE Std 91-1984 and IEC Publication 617-12. Pin numbers shown are for D, J, N, or W packages.

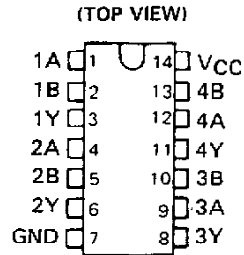

SN54LS32, SN54S32 . . . FK PACKAGE
(TOP VIEW)

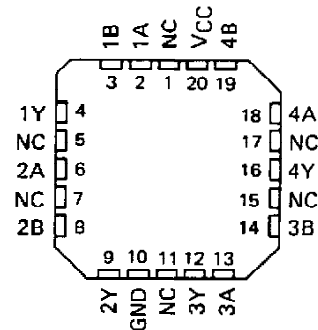

NC - No internal connection

logic diagram

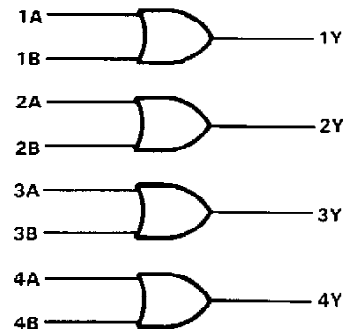

positive logic

$$Y = A + B \text{ or } Y = \overline{\overline{A} \cdot \overline{B}}$$

PRODUCTION DATA documents contain information current as of publication date. Products conform to specifications per the terms of Texas Instruments standard warranty. Production processing does not necessarily include testing of all parameters.



POST OFFICE BOX 655012 • DALLAS, TEXAS 75265

**SN5432, SN54LS32, SN54S32,
SN7432, SN74LS32, SN74S32
QUADRUPLE 2-INPUT POSITIVE-OR GATES**

schematics (each gate)



Resistor values shown are nominal.

absolute maximum ratings over operating free-air temperature range (unless otherwise noted)

Supply voltage, V_{CC} (see Note 1)	7 V
Input voltage: '32, 'S32	5.5 V
'LS32	7 V
Operating free-air temperature: SN54'	-55°C to 125°C
SN74'	0°C to 70°C
Storage temperature range	-65°C to 150°C

NOTE 1: Voltage values are with respect to network ground terminal.



POST OFFICE BOX 655012 • DALLAS, TEXAS 75265

SN5432, SN7432 QUADRUPLE 2-INPUT POSITIVE-OR GATES

recommended operating conditions

	SN5432			SN7432			UNIT
	MIN	NOM	MAX	MIN	NOM	MAX	
V _{CC} Supply voltage	4.5	5	5.5	4.75	5	5.25	V
V _{IH} High-level input voltage	2			2			V
V _{IL} Low-level input voltage			0.8			0.8	V
I _{OH} High-level output current			-0.8			-0.8	mA
I _{OL} Low-level output current			16			16	mA
T _A Operating free-air temperature	-55		125	0		70	°C

electrical characteristics over recommended operating free-air temperature range (unless otherwise noted)

PARAMETER	TEST CONDITIONS †	SN5432			SN7432			UNIT
		MIN	TYP ‡	MAX	MIN	TYP ‡	MAX	
V _{IK}	V _{CC} = MIN, I _I = -12 mA			-1.5			-1.5	V
V _{OH}	V _{CC} = MIN, V _{IH} = 2 V, I _{OH} = -0.8 mA	2.4	3.4		2.4	3.4		V
V _{OL}	V _{CC} = MIN, V _{IL} = 0.8 V, I _{OL} = 16 mA		0.2	0.4		0.2	0.4	V
I _I	V _{CC} = MAX, V _I = 5.5 V			1			1	mA
I _{IH}	V _{CC} = MAX, V _I = 2.4 V			40			40	μA
I _{IL}	V _{CC} = MAX, V _I = 0.4 V			1.6			-1.6	mA
I _{OS} §	V _{CC} = MAX	-20		-55	-18		-55	mA
I _{CCH}	V _{CC} = MAX, See Note 2		15	22		15	22	mA
I _{CCL}	V _{CC} = MAX, V _I = 0 V		23	38		23	38	mA

† For conditions shown as MIN or MAX, use the appropriate value specified under recommended operating conditions.

‡ All typical values are at V_{CC} = 5 V, T_A = 25°C.

§ Not more than one output should be shorted at a time.

NOTE 2: One input at 4.5 V, all others at GND.

switching characteristics, V_{CC} = 5 V, T_A = 25°C (see note 3)

PARAMETER	FROM (INPUT)	TO (OUTPUT)	TEST CONDITIONS	MIN	TYP	MAX	UNIT
t _{PLH}	A or B	Y	R _L = 400 Ω, C _L = 15 pF		10	15	ns
t _{PHL}					14	22	ns

NOTE 3: Load circuits and voltage waveforms are shown in Section 1.



SN54LS32, SN74LS32

QUADRUPLE 2-INPUT POSITIVE-OR GATES

recommended operating conditions

	SN54LS32			SN74LS32			UNIT
	MIN	NOM	MAX	MIN	NOM	MAX	
V _{CC} Supply voltage	4.5	5	5.5	4.75	5	5.25	V
V _{IH} High-level input voltage	2			2			V
V _{IL} Low-level input voltage			0.7			0.8	V
I _{OH} High-level output current			-0.4			-0.4	mA
I _{OL} Low-level output current			4			8	mA
T _A Operating free-air temperature	-55		125	0		70	°C

electrical characteristics over recommended operating free-air temperature range (unless otherwise noted)

PARAMETER	TEST CONDITIONS †	SN54LS32			SN74LS32			UNIT
		MIN	TYP ‡	MAX	MIN	TYP ‡	MAX	
V _{IK}	V _{CC} = MIN, I _I = -18 mA			-1.5			-1.5	V
V _{OH}	V _{CC} = MIN, V _{IH} = 2 V, I _{OH} = -0.4 mA	2.5	3.4		2.7	3.4		V
V _{OL}	V _{CC} = MIN, V _{IL} = MAX, I _{OL} = 4 mA		0.25	0.4		0.25	0.4	V
	V _{CC} = MIN, V _{IL} = MAX, I _{OL} = 8 mA					0.35	0.5	
I _I	V _{CC} = MAX, V _I = 7 V			0.1			0.1	mA
I _{IH}	V _{CC} = MAX, V _I = 2.7 V			20			20	µA
I _{IL}	V _{CC} = MAX, V _I = 0.4 V			-0.4			-0.4	mA
I _{OS} §	V _{CC} = MAX	-20		-100	-20		-100	mA
I _{CCH}	V _{CC} = MAX, See Note 2		3.1	6.2		3.1	6.2	mA
I _{CCL}	V _{CC} = MAX, V _I = 0 V		4.9	9.8		4.9	9.8	mA

† For conditions shown as MIN or MAX, use the appropriate value specified under recommended operating conditions.

‡ All typical values are at V_{CC} = 5 V, T_A = 25°C.

§ Not more than one output should be shorted at a time and the duration of the short-circuit should not exceed one second.

NOTE 2: One input at 4.5 V, all others at GND.

switching characteristics, V_{CC} = 5 V, T_A = 25°C (see note 3)

PARAMETER	FROM (INPUT)	TO (OUTPUT)	TEST CONDITIONS	MIN	TYP	MAX	UNIT
t _{PLH}	A or B	Y	R _L = 2 kΩ, C _L = 15 pF		14	22	ns
t _{PHL}					14	22	ns

NOTE 3: Load circuits and voltage waveforms are shown in Section 1.

TEXAS
INSTRUMENTS

POST OFFICE BOX 655012 • DALLAS, TEXAS 75265

SN54S32, SN74S32 QUADRUPLE 2-INPUT POSITIVE-OR GATES

recommended operating conditions

	SN54S32			SN74S32			UNIT
	MIN	NOM	MAX	MIN	NOM	MAX	
V _{CC} Supply voltage	4.5	5	5.5	4.75	5	5.25	V
V _{IH} High-level input voltage	2			2			V
V _{IL} Low-level input voltage			0.8			0.8	V
I _{OH} High-level output current			-1			-1	mA
I _{OL} Low-level output current			20			20	mA
T _A Operating free-air temperature	-55		125	0		70	°C

electrical characteristics over recommended operating free-air temperature range (unless otherwise noted)

PARAMETER	TEST CONDITIONS †	SN54S32			SN74S32			UNIT
		MIN	TYP ‡	MAX	MIN	TYP ‡	MAX	
V _{IK}	V _{CC} = MIN, I _I = -18 mA			-1.2			-1.2	V
V _{OH}	V _{CC} = MIN, V _{IH} = 2 V, I _{OH} = -1 mA	2.5	3.4		2.7	3.4		V
V _{OL}	V _{CC} = MIN, V _{IL} = 0.8 V, I _{OL} = 20 mA			0.5			0.5	V
I _I	V _{CC} = MAX, V _I = 5.5 V			1			1	mA
I _{IH}	V _{CC} = MAX, V _I = 2.7 V			50			50	μA
I _{IL}	V _{CC} = MAX, V _I = 0.5 V			-2			-2	mA
I _{OS} §	V _{CC} = MAX	-40		-100	-40		-100	mA
I _{CCH}	V _{CC} = MAX, See Note 2		18	32		18	32	mA
I _{CCL}	V _{CC} = MAX, V _I = 0 V		38	68		38	68	mA

† For conditions shown as MIN or MAX, use the appropriate value specified under recommended operating conditions.

‡ All typical values are at V_{CC} = 5 V, T_A = 25°C.

§ Not more than one output should be shorted at a time and the duration of the short-circuit should not exceed one second.

NOTE 2: One input at 4.5 V, all others at GND.

switching characteristics, V_{CC} = 5 V, T_A = 25°C (see note 3)

PARAMETER	FROM (INPUT)	TO (OUTPUT)	TEST CONDITIONS	MIN	TYP	MAX	UNIT
t _{PLH}	A or B	Y	R _L = 280 Ω, C _L = 15 pF		4	7	ns
t _{PHL}					4	7	ns
t _{PLH}	A or B	Y	R _L = 280 Ω, C _L = 50 pF		5		ns
t _{PHL}					5		ns

NOTE 3: Load circuits and voltage waveforms are shown in Section 1.

**TEXAS
INSTRUMENTS**

POST OFFICE BOX 655012 • DALLAS, TEXAS 75265

PACKAGING INFORMATION

Orderable Device	Status (1)	Package Type	Package Drawing	Pins	Package Qty	Eco Plan (2)	Lead finish/ Ball material (6)	MSL Peak Temp (3)	Op Temp (°C)	Device Marking (4/5)	Samples
5962-9557401QCA	ACTIVE	CDIP	J	14	25	Non-RoHS & Green	SNPB	N / A for Pkg Type	-55 to 125	5962-9557401QC A SNJ5432J	Samples
5962-9557401QDA	ACTIVE	CFP	W	14	25	Non-RoHS & Green	SNPB	N / A for Pkg Type	-55 to 125	5962-9557401QD A SNJ5432W	Samples
5962-9557401QDA	ACTIVE	CFP	W	14	25	Non-RoHS & Green	SNPB	N / A for Pkg Type	-55 to 125	5962-9557401QD A SNJ5432W	Samples
JM38510/30501B2A	ACTIVE	LCCC	FK	20	55	Non-RoHS & Green	SNPB	N / A for Pkg Type	-55 to 125	JM38510/ 30501B2A	Samples
JM38510/30501B2A	ACTIVE	LCCC	FK	20	55	Non-RoHS & Green	SNPB	N / A for Pkg Type	-55 to 125	JM38510/ 30501B2A	Samples
JM38510/30501BCA	ACTIVE	CDIP	J	14	25	Non-RoHS & Green	SNPB	N / A for Pkg Type	-55 to 125	JM38510/ 30501BCA	Samples
JM38510/30501BCA	ACTIVE	CDIP	J	14	25	Non-RoHS & Green	SNPB	N / A for Pkg Type	-55 to 125	JM38510/ 30501BCA	Samples
JM38510/30501BDA	ACTIVE	CFP	W	14	25	Non-RoHS & Green	SNPB	N / A for Pkg Type	-55 to 125	JM38510/ 30501BDA	Samples
JM38510/30501BDA	ACTIVE	CFP	W	14	25	Non-RoHS & Green	SNPB	N / A for Pkg Type	-55 to 125	JM38510/ 30501BDA	Samples
JM38510/30501SCA	ACTIVE	CDIP	J	14	25	Non-RoHS & Green	SNPB	N / A for Pkg Type	-55 to 125	JM38510/ 30501SCA	Samples
JM38510/30501SCA	ACTIVE	CDIP	J	14	25	Non-RoHS & Green	SNPB	N / A for Pkg Type	-55 to 125	JM38510/ 30501SCA	Samples
JM38510/30501SDA	ACTIVE	CFP	W	14	25	Non-RoHS & Green	SNPB	N / A for Pkg Type	-55 to 125	JM38510/ 30501SDA	Samples
JM38510/30501SDA	ACTIVE	CFP	W	14	25	Non-RoHS & Green	SNPB	N / A for Pkg Type	-55 to 125	JM38510/ 30501SDA	Samples
M38510/30501B2A	ACTIVE	LCCC	FK	20	55	Non-RoHS & Green	SNPB	N / A for Pkg Type	-55 to 125	JM38510/ 30501B2A	Samples
M38510/30501B2A	ACTIVE	LCCC	FK	20	55	Non-RoHS & Green	SNPB	N / A for Pkg Type	-55 to 125	JM38510/ 30501B2A	Samples

Orderable Device	Status (1)	Package Type	Package Drawing	Pins	Package Qty	Eco Plan (2)	Lead finish/ Ball material (6)	MSL Peak Temp (3)	Op Temp (°C)	Device Marking (4/5)	Samples
M38510/30501BCA	ACTIVE	CDIP	J	14	25	Non-RoHS & Green	SNPB	N / A for Pkg Type	-55 to 125	JM38510/ 30501BCA	Samples
M38510/30501BCA	ACTIVE	CDIP	J	14	25	Non-RoHS & Green	SNPB	N / A for Pkg Type	-55 to 125	JM38510/ 30501BCA	Samples
M38510/30501BDA	ACTIVE	CFP	W	14	25	Non-RoHS & Green	SNPB	N / A for Pkg Type	-55 to 125	JM38510/ 30501BDA	Samples
M38510/30501BDA	ACTIVE	CFP	W	14	25	Non-RoHS & Green	SNPB	N / A for Pkg Type	-55 to 125	JM38510/ 30501BDA	Samples
M38510/30501SCA	ACTIVE	CDIP	J	14	25	Non-RoHS & Green	SNPB	N / A for Pkg Type	-55 to 125	JM38510/ 30501SCA	Samples
M38510/30501SCA	ACTIVE	CDIP	J	14	25	Non-RoHS & Green	SNPB	N / A for Pkg Type	-55 to 125	JM38510/ 30501SCA	Samples
M38510/30501SDA	ACTIVE	CFP	W	14	25	Non-RoHS & Green	SNPB	N / A for Pkg Type	-55 to 125	JM38510/ 30501SDA	Samples
M38510/30501SDA	ACTIVE	CFP	W	14	25	Non-RoHS & Green	SNPB	N / A for Pkg Type	-55 to 125	JM38510/ 30501SDA	Samples
SN5432J	ACTIVE	CDIP	J	14	25	Non-RoHS & Green	SNPB	N / A for Pkg Type	-55 to 125	SN5432J	Samples
SN5432J	ACTIVE	CDIP	J	14	25	Non-RoHS & Green	SNPB	N / A for Pkg Type	-55 to 125	SN5432J	Samples
SN54LS32J	ACTIVE	CDIP	J	14	25	Non-RoHS & Green	SNPB	N / A for Pkg Type	-55 to 125	SN54LS32J	Samples
SN54LS32J	ACTIVE	CDIP	J	14	25	Non-RoHS & Green	SNPB	N / A for Pkg Type	-55 to 125	SN54LS32J	Samples
SN54S32J	ACTIVE	CDIP	J	14	25	Non-RoHS & Green	SNPB	N / A for Pkg Type	-55 to 125	SN54S32J	Samples
SN54S32J	ACTIVE	CDIP	J	14	25	Non-RoHS & Green	SNPB	N / A for Pkg Type	-55 to 125	SN54S32J	Samples
SN7432N	ACTIVE	PDIP	N	14	25	RoHS & Green	NIPDAU	N / A for Pkg Type	0 to 70	SN7432N	Samples
SN7432N	ACTIVE	PDIP	N	14	25	RoHS & Green	NIPDAU	N / A for Pkg Type	0 to 70	SN7432N	Samples
SN7432NE4	ACTIVE	PDIP	N	14	25	RoHS & Green	NIPDAU	N / A for Pkg Type	0 to 70	SN7432N	Samples
SN7432NE4	ACTIVE	PDIP	N	14	25	RoHS & Green	NIPDAU	N / A for Pkg Type	0 to 70	SN7432N	Samples

Orderable Device	Status (1)	Package Type	Package Drawing	Pins	Package Qty	Eco Plan (2)	Lead finish/ Ball material (6)	MSL Peak Temp (3)	Op Temp (°C)	Device Marking (4/5)	Samples
SN74LS32D	OBSOLETE	SOIC	D	14		TBD	Call TI	Call TI	0 to 70	LS32	
SN74LS32D	OBSOLETE	SOIC	D	14		TBD	Call TI	Call TI	0 to 70	LS32	
SN74LS32DBR	ACTIVE	SSOP	DB	14	2000	RoHS & Green	NIPDAU	Level-1-260C-UNLIM	0 to 70	LS32	Samples
SN74LS32DBR	ACTIVE	SSOP	DB	14	2000	RoHS & Green	NIPDAU	Level-1-260C-UNLIM	0 to 70	LS32	Samples
SN74LS32DR	ACTIVE	SOIC	D	14	2500	RoHS & Green	NIPDAU	Level-1-260C-UNLIM	0 to 70	LS32	Samples
SN74LS32DR	ACTIVE	SOIC	D	14	2500	RoHS & Green	NIPDAU	Level-1-260C-UNLIM	0 to 70	LS32	Samples
SN74LS32DRE4	ACTIVE	SOIC	D	14	2500	RoHS & Green	NIPDAU	Level-1-260C-UNLIM	0 to 70	LS32	Samples
SN74LS32DRE4	ACTIVE	SOIC	D	14	2500	RoHS & Green	NIPDAU	Level-1-260C-UNLIM	0 to 70	LS32	Samples
SN74LS32DRG4	ACTIVE	SOIC	D	14	2500	RoHS & Green	NIPDAU	Level-1-260C-UNLIM	0 to 70	LS32	Samples
SN74LS32DRG4	ACTIVE	SOIC	D	14	2500	RoHS & Green	NIPDAU	Level-1-260C-UNLIM	0 to 70	LS32	Samples
SN74LS32N	ACTIVE	PDIP	N	14	25	RoHS & Green	NIPDAU	N / A for Pkg Type	0 to 70	SN74LS32N	Samples
SN74LS32N	ACTIVE	PDIP	N	14	25	RoHS & Green	NIPDAU	N / A for Pkg Type	0 to 70	SN74LS32N	Samples
SN74LS32NE4	ACTIVE	PDIP	N	14	25	RoHS & Green	NIPDAU	N / A for Pkg Type	0 to 70	SN74LS32N	Samples
SN74LS32NE4	ACTIVE	PDIP	N	14	25	RoHS & Green	NIPDAU	N / A for Pkg Type	0 to 70	SN74LS32N	Samples
SN74LS32NSR	ACTIVE	SO	NS	14	2000	RoHS & Green	NIPDAU	Level-1-260C-UNLIM	0 to 70	74LS32	Samples
SN74LS32NSR	ACTIVE	SO	NS	14	2000	RoHS & Green	NIPDAU	Level-1-260C-UNLIM	0 to 70	74LS32	Samples
SN74LS32NSRG4	ACTIVE	SO	NS	14	2000	RoHS & Green	NIPDAU	Level-1-260C-UNLIM	0 to 70	74LS32	Samples
SN74LS32NSRG4	ACTIVE	SO	NS	14	2000	RoHS & Green	NIPDAU	Level-1-260C-UNLIM	0 to 70	74LS32	Samples
SN74S32D	OBSOLETE	SOIC	D	14		TBD	Call TI	Call TI	0 to 70	S32	
SN74S32D	OBSOLETE	SOIC	D	14		TBD	Call TI	Call TI	0 to 70	S32	
SN74S32DR	ACTIVE	SOIC	D	14	2500	RoHS & Green	NIPDAU	Level-1-260C-UNLIM	0 to 70	S32	Samples
SN74S32DR	ACTIVE	SOIC	D	14	2500	RoHS & Green	NIPDAU	Level-1-260C-UNLIM	0 to 70	S32	Samples

Orderable Device	Status (1)	Package Type	Package Drawing	Pins	Package Qty	Eco Plan (2)	Lead finish/ Ball material (6)	MSL Peak Temp (3)	Op Temp (°C)	Device Marking (4/5)	Samples
SN74S32N	ACTIVE	PDIP	N	14	25	RoHS & Green	NIPDAU	N / A for Pkg Type	0 to 70	SN74S32N	Samples
SN74S32N	ACTIVE	PDIP	N	14	25	RoHS & Green	NIPDAU	N / A for Pkg Type	0 to 70	SN74S32N	Samples
SNJ5432J	ACTIVE	CDIP	J	14	25	Non-RoHS & Green	SNPB	N / A for Pkg Type	-55 to 125	5962-9557401QC A SNJ5432J	Samples
SNJ5432J	ACTIVE	CDIP	J	14	25	Non-RoHS & Green	SNPB	N / A for Pkg Type	-55 to 125	5962-9557401QC A SNJ5432J	Samples
SNJ5432W	ACTIVE	CFP	W	14	25	Non-RoHS & Green	SNPB	N / A for Pkg Type	-55 to 125	5962-9557401QD A SNJ5432W	Samples
SNJ5432W	ACTIVE	CFP	W	14	25	Non-RoHS & Green	SNPB	N / A for Pkg Type	-55 to 125	5962-9557401QD A SNJ5432W	Samples
SNJ54LS32FK	ACTIVE	LCCC	FK	20	55	Non-RoHS & Green	SNPB	N / A for Pkg Type	-55 to 125	SNJ54LS 32FK	Samples
SNJ54LS32FK	ACTIVE	LCCC	FK	20	55	Non-RoHS & Green	SNPB	N / A for Pkg Type	-55 to 125	SNJ54LS 32FK	Samples
SNJ54LS32J	ACTIVE	CDIP	J	14	25	Non-RoHS & Green	SNPB	N / A for Pkg Type	-55 to 125	SNJ54LS32J	Samples
SNJ54LS32J	ACTIVE	CDIP	J	14	25	Non-RoHS & Green	SNPB	N / A for Pkg Type	-55 to 125	SNJ54LS32J	Samples
SNJ54LS32W	ACTIVE	CFP	W	14	25	Non-RoHS & Green	SNPB	N / A for Pkg Type	-55 to 125	SNJ54LS32W	Samples
SNJ54LS32W	ACTIVE	CFP	W	14	25	Non-RoHS & Green	SNPB	N / A for Pkg Type	-55 to 125	SNJ54LS32W	Samples
SNJ54S32J	ACTIVE	CDIP	J	14	25	Non-RoHS & Green	SNPB	N / A for Pkg Type	-55 to 125	SNJ54S32J	Samples
SNJ54S32J	ACTIVE	CDIP	J	14	25	Non-RoHS & Green	SNPB	N / A for Pkg Type	-55 to 125	SNJ54S32J	Samples
SNJ54S32W	ACTIVE	CFP	W	14	25	Non-RoHS & Non-Green	SNPB	N / A for Pkg Type	-55 to 125	SNJ54S32W	Samples
SNJ54S32W	ACTIVE	CFP	W	14	25	Non-RoHS & Non-Green	SNPB	N / A for Pkg Type	-55 to 125	SNJ54S32W	Samples

(1) The marketing status values are defined as follows:

ACTIVE: Product device recommended for new designs.

LIFEBUY: TI has announced that the device will be discontinued, and a lifetime-buy period is in effect.

NRND: Not recommended for new designs. Device is in production to support existing customers, but TI does not recommend using this part in a new design.

PREVIEW: Device has been announced but is not in production. Samples may or may not be available.

OBSOLETE: TI has discontinued the production of the device.

(2) **RoHS:** TI defines "RoHS" to mean semiconductor products that are compliant with the current EU RoHS requirements for all 10 RoHS substances, including the requirement that RoHS substance do not exceed 0.1% by weight in homogeneous materials. Where designed to be soldered at high temperatures, "RoHS" products are suitable for use in specified lead-free processes. TI may reference these types of products as "Pb-Free".

RoHS Exempt: TI defines "RoHS Exempt" to mean products that contain lead but are compliant with EU RoHS pursuant to a specific EU RoHS exemption.

Green: TI defines "Green" to mean the content of Chlorine (Cl) and Bromine (Br) based flame retardants meet JS709B low halogen requirements of ≤ 1000 ppm threshold. Antimony trioxide based flame retardants must also meet the ≤ 1000 ppm threshold requirement.

(3) MSL, Peak Temp. - The Moisture Sensitivity Level rating according to the JEDEC industry standard classifications, and peak solder temperature.

(4) There may be additional marking, which relates to the logo, the lot trace code information, or the environmental category on the device.

(5) Multiple Device Markings will be inside parentheses. Only one Device Marking contained in parentheses and separated by a "~" will appear on a device. If a line is indented then it is a continuation of the previous line and the two combined represent the entire Device Marking for that device.

(6) Lead finish/Ball material - Orderable Devices may have multiple material finish options. Finish options are separated by a vertical ruled line. Lead finish/Ball material values may wrap to two lines if the finish value exceeds the maximum column width.

Important Information and Disclaimer:The information provided on this page represents TI's knowledge and belief as of the date that it is provided. TI bases its knowledge and belief on information provided by third parties, and makes no representation or warranty as to the accuracy of such information. Efforts are underway to better integrate information from third parties. TI has taken and continues to take reasonable steps to provide representative and accurate information but may not have conducted destructive testing or chemical analysis on incoming materials and chemicals. TI and TI suppliers consider certain information to be proprietary, and thus CAS numbers and other limited information may not be available for release.

In no event shall TI's liability arising out of such information exceed the total purchase price of the TI part(s) at issue in this document sold by TI to Customer on an annual basis.

OTHER QUALIFIED VERSIONS OF SN5432, SN54LS32, SN54LS32-SP, SN54S32, SN7432, SN74LS32, SN74S32 :

● Catalog : [SN7432](#), [SN74LS32](#), [SN54LS32](#), [SN74S32](#)

● Military : [SN5432](#), [SN54LS32](#), [SN54S32](#)

● Space : [SN54LS32-SP](#)

NOTE: Qualified Version Definitions:

- Catalog - TI's standard catalog product
- Military - QML certified for Military and Defense Applications
- Space - Radiation tolerant, ceramic packaging and qualified for use in Space-based application

TAPE AND REEL INFORMATION

QUADRANT ASSIGNMENTS FOR PIN 1 ORIENTATION IN TAPE

*All dimensions are nominal

Device	Package Type	Package Drawing	Pins	SPQ	Reel Diameter (mm)	Reel Width W1 (mm)	A0 (mm)	B0 (mm)	K0 (mm)	P1 (mm)	W (mm)	Pin1 Quadrant
SN74LS32DBR	SSOP	DB	14	2000	330.0	16.4	8.35	6.6	2.4	12.0	16.0	Q1
SN74LS32DR	SOIC	D	14	2500	330.0	16.4	6.5	9.0	2.1	8.0	16.0	Q1
SN74LS32NSR	SO	NS	14	2000	330.0	16.4	8.2	10.5	2.5	12.0	16.0	Q1
SN74S32DR	SOIC	D	14	2500	330.0	16.4	6.5	9.0	2.1	8.0	16.0	Q1

TAPE AND REEL BOX DIMENSIONS



*All dimensions are nominal

Device	Package Type	Package Drawing	Pins	SPQ	Length (mm)	Width (mm)	Height (mm)
SN74LS32DBR	SSOP	DB	14	2000	356.0	356.0	35.0
SN74LS32DR	SOIC	D	14	2500	356.0	356.0	35.0
SN74LS32NSR	SO	NS	14	2000	356.0	356.0	35.0
SN74S32DR	SOIC	D	14	2500	356.0	356.0	35.0

TUBE

*All dimensions are nominal

Device	Package Name	Package Type	Pins	SPQ	L (mm)	W (mm)	T (μm)	B (mm)
5962-9557401QDA	W	CFP	14	25	506.98	26.16	6220	NA
JM38510/30501B2A	FK	LCCC	20	55	506.98	12.06	2030	NA
JM38510/30501BDA	W	CFP	14	25	506.98	26.16	6220	NA
JM38510/30501SDA	W	CFP	14	25	506.98	26.16	6220	NA
M38510/30501B2A	FK	LCCC	20	55	506.98	12.06	2030	NA
M38510/30501BDA	W	CFP	14	25	506.98	26.16	6220	NA
M38510/30501SDA	W	CFP	14	25	506.98	26.16	6220	NA
SN7432N	N	PDIP	14	25	506	13.97	11230	4.32
SN7432N	N	PDIP	14	25	506	13.97	11230	4.32
SN7432NE4	N	PDIP	14	25	506	13.97	11230	4.32
SN7432NE4	N	PDIP	14	25	506	13.97	11230	4.32
SN74LS32N	N	PDIP	14	25	506	13.97	11230	4.32
SN74LS32N	N	PDIP	14	25	506	13.97	11230	4.32
SN74LS32NE4	N	PDIP	14	25	506	13.97	11230	4.32
SN74LS32NE4	N	PDIP	14	25	506	13.97	11230	4.32
SN74S32N	N	PDIP	14	25	506	13.97	11230	4.32
SN74S32N	N	PDIP	14	25	506	13.97	11230	4.32
SNJ5432W	W	CFP	14	25	506.98	26.16	6220	NA
SNJ54LS32FK	FK	LCCC	20	55	506.98	12.06	2030	NA
SNJ54LS32W	W	CFP	14	25	506.98	26.16	6220	NA
SNJ54S32W	W	CFP	14	25	506.98	26.16	6220	NA

MECHANICAL DATA

NS (R-PDSO-G**)

PLASTIC SMALL-OUTLINE PACKAGE

14-PINS SHOWN



- NOTES:
- A. All linear dimensions are in millimeters.
 - B. This drawing is subject to change without notice.
 - C. Body dimensions do not include mold flash or protrusion, not to exceed 0,15.

W (R-GDFP-F14)

CERAMIC DUAL FLATPACK



- NOTES:
- A. All linear dimensions are in inches (millimeters).
 - B. This drawing is subject to change without notice.
 - C. This package can be hermetically sealed with a ceramic lid using glass frit.
 - D. Index point is provided on cap for terminal identification only.
 - E. Falls within MIL STD 1835 GDFP1-F14

DB0014A



PACKAGE OUTLINE

SSOP - 2 mm max height

SMALL OUTLINE PACKAGE



NOTES:

1. All linear dimensions are in millimeters. Any dimensions in parenthesis are for reference only. Dimensioning and tolerancing per ASME Y14.5M.
2. This drawing is subject to change without notice.
3. This dimension does not include mold flash, protrusions, or gate burrs. Mold flash, protrusions, or gate burrs shall not exceed 0.15 mm per side.
4. Reference JEDEC registration MO-150.

EXAMPLE BOARD LAYOUT

DB0014A

SSOP - 2 mm max height

SMALL OUTLINE PACKAGE



LAND PATTERN EXAMPLE
EXPOSED METAL SHOWN
SCALE: 10X



4220762/A 05/2024

NOTES: (continued)

5. Publication IPC-7351 may have alternate designs.
6. Solder mask tolerances between and around signal pads can vary based on board fabrication site.

EXAMPLE STENCIL DESIGN

DB0014A

SSOP - 2 mm max height

SMALL OUTLINE PACKAGE

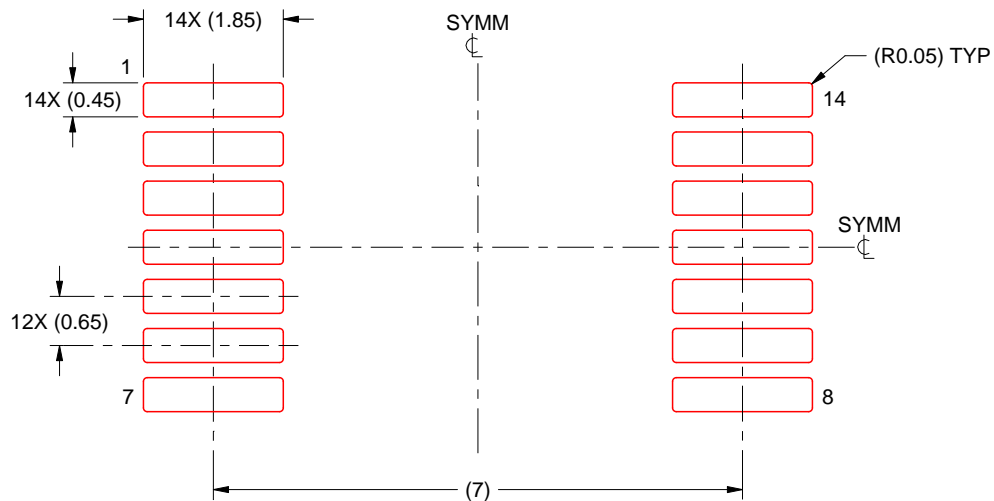

SOLDER PASTE EXAMPLE
BASED ON 0.125 mm THICK STENCIL
SCALE: 10X

4220762/A 05/2024

NOTES: (continued)

7. Laser cutting apertures with trapezoidal walls and rounded corners may offer better paste release. IPC-7525 may have alternate design recommendations.
8. Board assembly site may have different recommendations for stencil design.

GENERIC PACKAGE VIEW

FK 20

LCCC - 2.03 mm max height

8.89 x 8.89, 1.27 mm pitch

LEADLESS CERAMIC CHIP CARRIER

This image is a representation of the package family, actual package may vary.
Refer to the product data sheet for package details.



4229370VA\

J 14

GENERIC PACKAGE VIEW
CDIP - 5.08 mm max height
CERAMIC DUAL IN LINE PACKAGE



Images above are just a representation of the package family, actual package may vary.
Refer to the product data sheet for package details.

4040083-5/G

J0014A



PACKAGE OUTLINE

CDIP - 5.08 mm max height

CERAMIC DUAL IN LINE PACKAGE



4214771/A 05/2017

NOTES:

1. All controlling linear dimensions are in inches. Dimensions in brackets are in millimeters. Any dimension in brackets or parenthesis are for reference only. Dimensioning and tolerancing per ASME Y14.5M.
2. This drawing is subject to change without notice.
3. This package is hermetically sealed with a ceramic lid using glass frit.
4. Index point is provided on cap for terminal identification only and on press ceramic glass frit seal only.
5. Falls within MIL-STD-1835 and GDIP1-T14.

EXAMPLE BOARD LAYOUT

J0014A

CDIP - 5.08 mm max height

CERAMIC DUAL IN LINE PACKAGE



LAND PATTERN EXAMPLE
NON-SOLDER MASK DEFINED
SCALE: 5X





4214771/A 05/2017

D (R-PDSO-G14)

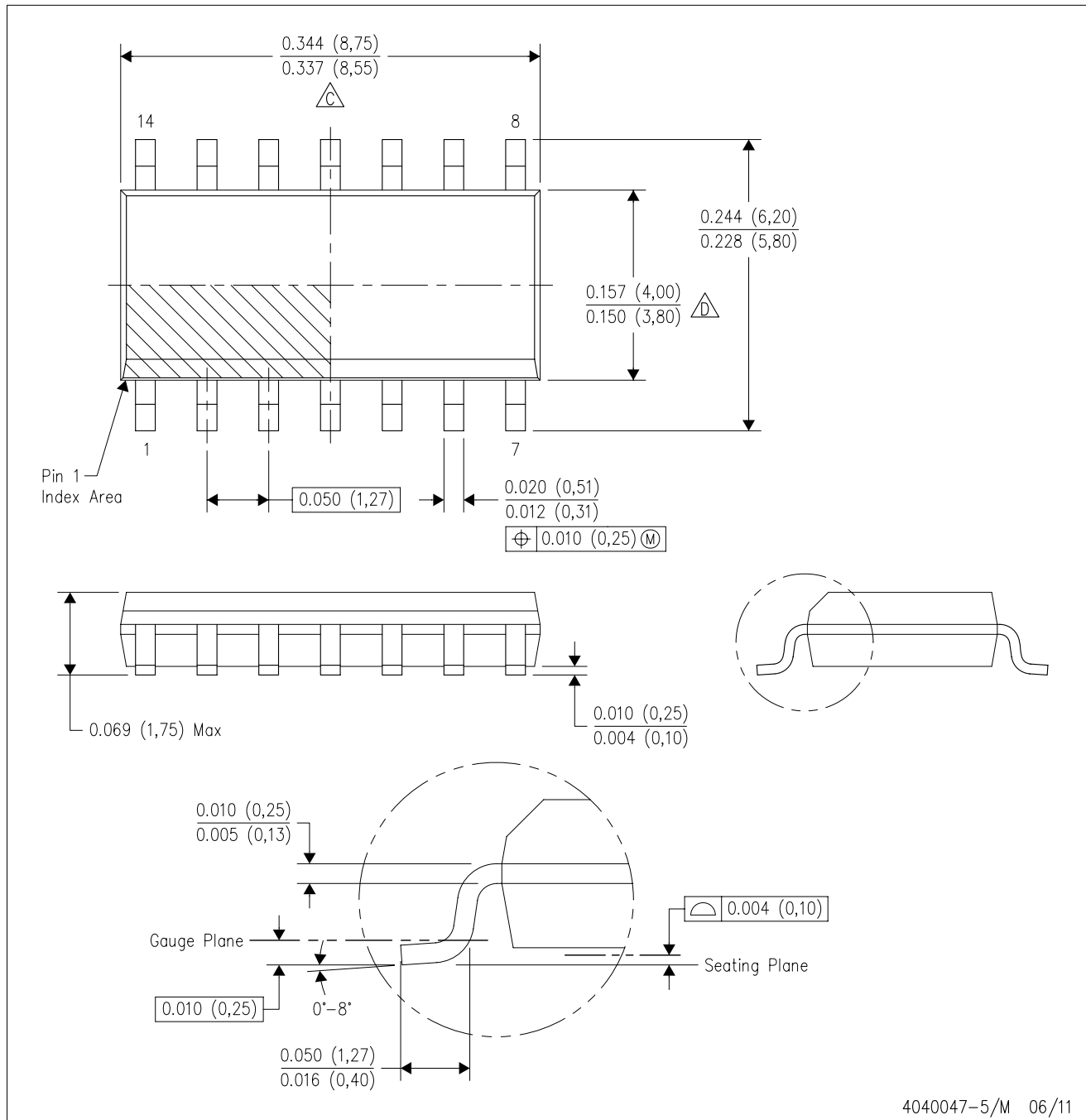
PLASTIC SMALL OUTLINE



- NOTES:
- A. All linear dimensions are in inches (millimeters).
 - B. This drawing is subject to change without notice.
 -  Body length does not include mold flash, protrusions, or gate burrs. Mold flash, protrusions, or gate burrs shall not exceed 0.006 (0,15) each side.
 -  Body width does not include interlead flash. Interlead flash shall not exceed 0.017 (0,43) each side.
 - E. Reference JEDEC MS-012 variation AB.

D (R-PDSO-G14)

PLASTIC SMALL OUTLINE



4211283-3/E 08/12

- NOTES:
- All linear dimensions are in millimeters.
 - This drawing is subject to change without notice.
 - Publication IPC-7351 is recommended for alternate designs.
 - Laser cutting apertures with trapezoidal walls and also rounding corners will offer better paste release. Customers should contact their board assembly site for stencil design recommendations. Refer to IPC-7525 for other stencil recommendations.
 - Customers should contact their board fabrication site for solder mask tolerances between and around signal pads.

N (R-PDIP-T**)

PLASTIC DUAL-IN-LINE PACKAGE

16 PINS SHOWN



- NOTES:
- A. All linear dimensions are in inches (millimeters).
 - B. This drawing is subject to change without notice.
 - Falls within JEDEC MS-001, except 18 and 20 pin minimum body length (Dim A).
 - The 20 pin end lead shoulder width is a vendor option, either half or full width.

IMPORTANT NOTICE AND DISCLAIMER

TI PROVIDES TECHNICAL AND RELIABILITY DATA (INCLUDING DATA SHEETS), DESIGN RESOURCES (INCLUDING REFERENCE DESIGNS), APPLICATION OR OTHER DESIGN ADVICE, WEB TOOLS, SAFETY INFORMATION, AND OTHER RESOURCES "AS IS" AND WITH ALL FAULTS, AND DISCLAIMS ALL WARRANTIES, EXPRESS AND IMPLIED, INCLUDING WITHOUT LIMITATION ANY IMPLIED WARRANTIES OF MERCHANTABILITY, FITNESS FOR A PARTICULAR PURPOSE OR NON-INFRINGEMENT OF THIRD PARTY INTELLECTUAL PROPERTY RIGHTS.

These resources are intended for skilled developers designing with TI products. You are solely responsible for (1) selecting the appropriate TI products for your application, (2) designing, validating and testing your application, and (3) ensuring your application meets applicable standards, and any other safety, security, regulatory or other requirements.

These resources are subject to change without notice. TI grants you permission to use these resources only for development of an application that uses the TI products described in the resource. Other reproduction and display of these resources is prohibited. No license is granted to any other TI intellectual property right or to any third party intellectual property right. TI disclaims responsibility for, and you will fully indemnify TI and its representatives against, any claims, damages, costs, losses, and liabilities arising out of your use of these resources.

TI's products are provided subject to [TI's Terms of Sale](#) or other applicable terms available either on [ti.com](https://www.ti.com) or provided in conjunction with such TI products. TI's provision of these resources does not expand or otherwise alter TI's applicable warranties or warranty disclaimers for TI products.

TI objects to and rejects any additional or different terms you may have proposed.

Mailing Address: Texas Instruments, Post Office Box 655303, Dallas, Texas 75265
Copyright © 2024, Texas Instruments Incorporated