

AMC3330 DC/DC コンバータ内蔵、高精度、 $\pm 1V$ 入力、強化絶縁アンプ

1 特長

- 3.3V または 5V 単一電源動作、DC/DC コンバータ内蔵
- 高入力インピーダンスの電圧測定用に最適化された $\pm 1V$ の入力電圧範囲
- 固定ゲイン：2.0
- 小さな DC 誤差：
 - ゲイン誤差： $\pm 0.2\%$ （最大値）
 - ゲイン・ドリフト： $\pm 45\text{ppm}/^\circ\text{C}$ （最大値）
 - オフセット誤差： $\pm 0.3\text{mV}$ （最大値）
 - オフセット・ドリフト： $\pm 4\mu\text{V}/^\circ\text{C}$ （最大値）
 - 非線形性： $\pm 0.02\%$ （最大値）
- 高 CMTI：85kV/ μs （最小値）
- システム・レベル診断機能
- 安全関連の認定：
 - DIN VDE V 0884-11 (VDE V 0884-11) に準拠した強化絶縁耐圧：6000V_{PK}2017-01
 - UL 1577 に準拠した絶縁耐圧：4250V_{RMS} (1 分間)
- CISPR-11 および CISPR-25 EMI 規格に準拠

2 アプリケーション

- 次の用途での絶縁型電圧センシング：
 - モーター・ドライブ
 - 太陽光発電インバータ
 - 電力供給システム
 - 電気メーター
 - 保護リレー

3 概要

AMC3330 は、デバイスのローサイドから単一電源で動作できる完全統合型絶縁 DC/DC コンバータを備えた高精度絶縁アンプです。その容量性強化絶縁バリアは、VDE V 0884-11 および UL1577 に準じて認定済みであり、異なる同相電圧レベルで動作するシステムの各部を分離し、低電圧部分を損傷から保護します。

AMC3330 の入力は、高電圧信号を検出するために、抵抗分圧ネットワークなどの高インピーダンス電圧信号ソースに直接接続するよう最適化されています。内蔵の絶縁 DC/DC コンバータにより非グランド基準信号を測定できるため、ノイズが多くスペースに制約があるアプリケーション向けのユニークなソリューションとして活用できます。

このデバイスの優れた性能により、正確な電圧監視と制御がサポートされます。AMC3330 の内蔵 DC/DC コンバータ・フォルト検出および診断出力ピンを使用すると、システム・レベルの設計と診断を簡素化できます。

AMC3330 は、温度範囲 ($-40^\circ\text{C} \sim +125^\circ\text{C}$) で動作が規定されています。

製品情報 (1) (1 ページ)

型番	パッケージ	本体サイズ (公称)
AMC3330	SOIC (16)	10.30mm×7.50mm

(1) 利用可能なすべてのパッケージについては、このデータシート末尾にある注文情報を参照してください。

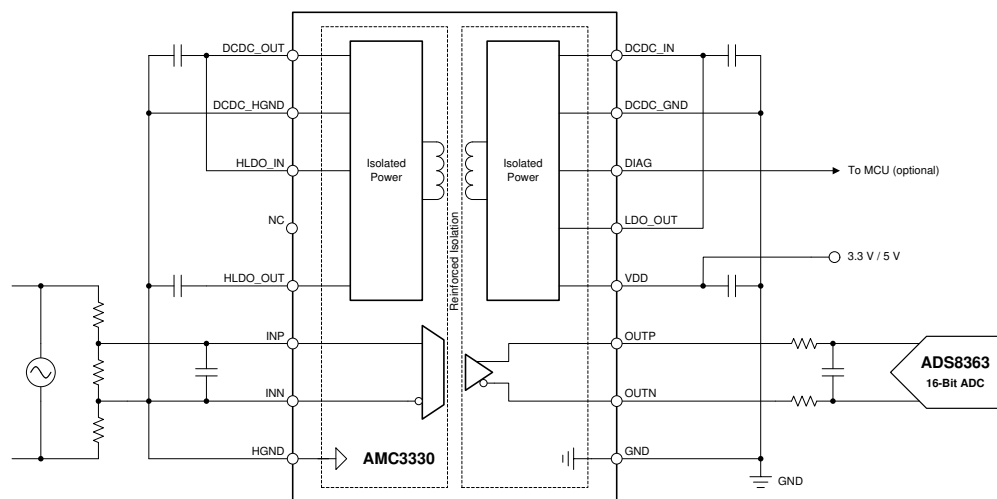

アプリケーションの例



Table of Contents

1 特長	1	7.2 Functional Block Diagram.....	17
2 アプリケーション	1	7.3 Feature Description.....	17
3 概要	1	7.4 Device Functional Modes.....	21
4 Revision History	2	8 Application and Implementation	22
5 Pin Configuration and Functions	3	8.1 Application Information.....	22
6 Specifications	4	8.2 Typical Application.....	22
6.1 Absolute Maximum Ratings	4	8.3 What to Do and What Not to Do.....	24
6.2 ESD Ratings	4	9 Power Supply Recommendations	25
6.3 Recommended Operating Conditions	4	10 Layout	27
6.4 Thermal Information	5	10.1 Layout Guidelines.....	27
6.5 Power Ratings	5	10.2 Layout Example.....	27
6.6 Insulation Specifications	6	11 Device and Documentation Support	28
6.7 Safety-Related Certifications	7	11.1 Device Support.....	28
6.8 Safety Limiting Values	7	11.2 Documentation Support.....	28
6.9 Electrical Characteristics	8	11.3 Receiving Notification of Documentation Updates..	28
6.10 Switching Characteristics	9	11.4 Support Resources.....	28
6.11 Timing Diagram.....	9	11.5 Trademarks.....	28
6.12 Insulation Characteristics Curves.....	10	11.6 Electrostatic Discharge Caution.....	28
6.13 Typical Characteristics.....	11	11.7 Glossary.....	28
7 Detailed Description	17	12 Mechanical, Packaging, and Orderable Information	28
7.1 Overview.....	17		

4 Revision History

資料番号末尾の英字は改訂を表しています。その改訂履歴は英語版に準じています。

Changes from Revision * (June 2020) to Revision A (October 2020)

Page

• ドキュメントのステータスを事前情報から量産データに変更.....	1
------------------------------------	---

5 Pin Configuration and Functions



图 5-1. DWE Package, 16-Pin SOIC, Top View

表 5-1. Pin Functions

PIN		TYPE	DESCRIPTION
NO.	NAME		
1	DCDC_OUT	Power	High-side output of the isolated DC/DC converter; connect this pin to the HLDO_IN pin. ⁽¹⁾
2	DCDC_HGND	Power Ground	High-side ground reference for the isolated DC/DC converter; connect this pin to the HGND pin.
3	HLDO_IN	Power	Input of the high-side low-dropout (LDO) regulator; connect this pin to the DCDC_OUT pin. ⁽¹⁾
4	NC	—	No internal connection. Connect this pin to the high-side ground or leave this pin unconnected (floating).
5	HLDO_OUT	Power	Output of the high-side LDO. ⁽¹⁾
6	INP	Analog Input	Noninverting analog input.
7	INN	Analog Input	Inverting analog input. Connect this pin to HGND.
8	HGND	Signal Ground	High-side analog ground; connect this pin to the DCDC_HGND pin.
9	GND	Signal Ground	Low-side analog ground; connect this pin to the DCDC_GND pin.
10	OUTN	Analog Output	Inverting analog output.
11	OUTP	Analog Output	Noninverting analog output.
12	VDD	Power	Low-side power supply. ⁽¹⁾
13	LDO_OUT	Power	Output of the low-side LDO; connect this pin to the DCDC_IN pin. ⁽¹⁾
14	DIAG	Digital Output	Active-low, open-drain status indicator output; connect this pin to the pullup supply (for example, VDD) using a resistor or leave this pin floating if not used.
15	DCDC_GND	Power Ground	Low-side ground reference for the isolated DC/DC converter; connect this pin to the GND pin.
16	DCDC_IN	Power	Low-side input of the isolated DC/DC converter; connect this pin to the LDO_OUT pin. ⁽¹⁾

(1) See the [Power Supply Recommendations](#) section for power-supply decoupling recommendations.

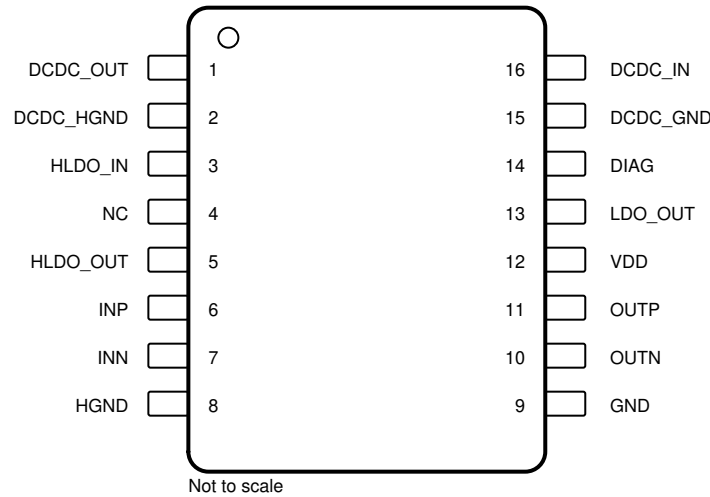
6 Specifications

6.1 Absolute Maximum Ratings

see (1)

		MIN	MAX	UNIT
Power-supply voltage	VDD to GND	-0.3	6.5	V
Analog input voltage	INP, INN	HGND – 6	V _{HLD0out} + 0.5	V
Analog output voltage	OUTP, OUTN	GND – 0.5	VDD + 0.5	V
Digital output voltage	DIAG	GND – 0.5	5.5	V
Input current	Continuous, any pin except power-supply pins	-10	10	mA
Temperature	Junction, T _J		150	°C
	Storage, T _{stg}	-65	150	

- (1) Stresses beyond those listed under *Absolute Maximum Ratings* may cause permanent damage to the device. These are stress ratings only, and do not imply functional operation of the device at these or any other conditions beyond those indicated under *Recommended Operating Conditions*. Exposure to absolute-maximum-rated conditions for extended periods may affect device reliability.

6.2 ESD Ratings

			VALUE	UNIT
V _(ESD)	Electrostatic discharge	Human-body model (HBM), per ANSI/ESDA/JEDEC JS-001 ⁽¹⁾	±2000	V
		Charged-device model (CDM), per JEDEC specification JESD22-C101 ⁽²⁾	±1000	

- (1) JEDEC document JEP155 states that 500-V HBM allows safe manufacturing with a standard ESD control process.
 (2) JEDEC document JEP157 states that 250-V CDM allows safe manufacturing with a standard ESD control process.

6.3 Recommended Operating Conditions

over operating ambient temperature range (unless otherwise noted)

				MIN	NOM	MAX	UNIT
POWER SUPPLY							
VDD	Low-side supply voltage	VDD to GND		3.0	3.3	5.5	V
ANALOG INPUT							
V _{Clipping}	Differential input voltage before clipping output	V _{IN} = V _{INP} – V _{INN}		±1.25			V
V _{FSR}	Specified linear differential full-scale voltage	V _{IN} = V _{INP} – V _{INN}		-1		1	V
	Absolute common-mode input voltage ⁽¹⁾	(V _{INP} + V _{INN}) / 2 to HGND		-2		3	V
V _{CM}	Operating common-mode input voltage	(V _{INP} + V _{INN}) / 2 to HGND, V _{INP} = V _{INN}		-1.4		1.6	V
		(V _{INP} + V _{INN}) / 2 to HGND, V _{INP} – V _{INN} = 1.0 V ⁽²⁾		-0.925		0.725	
		(V _{INP} + V _{INN}) / 2 to HGND, V _{INP} – V _{INN} = 1.25 V		-0.8		0.6	
DIGITAL OUTPUT							
	Pull-up supply-voltage for DIAG pin			0		VDD	V
TEMPERATURE RANGE							
T _A	Operating ambient temperature			-40	25	125	°C

- (1) Steady-state voltage supported by the device in case of a system failure. See specified common-mode input voltage V_{CM} for normal operation. Observe analog input voltage range as specified in the *Absolute Maximum Ratings* table.
 (2) Linear response.

6.4 Thermal Information

THERMAL METRIC ⁽¹⁾		AMC3330	UNIT
		DWE (SOIC)	
		16 PINS	
$R_{\theta JA}$	Junction-to-ambient thermal resistance	73.5	°C/W
$R_{\theta JC(top)}$	Junction-to-case (top) thermal resistance	31	°C/W
$R_{\theta JB}$	Junction-to-board thermal resistance	44	°C/W
Ψ_{JT}	Junction-to-top characterization parameter	16.7	°C/W
Ψ_{JB}	Junction-to-board characterization parameter	42.8	°C/W
$R_{\theta JC(bot)}$	Junction-to-case (bottom) thermal resistance	n/a	°C/W

(1) For more information about traditional and new thermal metrics, see the [Semiconductor and IC Package Thermal Metrics](#) application report.

6.5 Power Ratings

PARAMETER		TEST CONDITIONS	MIN	TYP	MAX	UNIT
P_D	Maximum power dissipation	VDD = 5.5 V			236.5	mW
		VDD = 3.6 V			155	

6.6 Insulation Specifications

over operating ambient temperature range (unless otherwise noted)

PARAMETER		TEST CONDITIONS	VALUE	UNIT
GENERAL				
CLR	External clearance ⁽¹⁾	Shortest pin-to-pin distance through air	≥ 8	mm
CPG	External creepage ⁽¹⁾	Shortest pin-to-pin distance across the package surface	≥ 8	mm
DTI	Distance through the insulation	Minimum internal gap (internal clearance - capacitive signal isolation)	≥ 21	μm
		Minimum internal gap (internal clearance - transformer power isolation)	≥ 120	
CTI	Comparative tracking index	DIN EN 60112 (VDE 0303-11); IEC 60112	≥ 600	V
	Material group	According to IEC 60664-1	I	
	Overvoltage category per IEC 60664-1	Rated mains voltage ≤ 600 V _{RMS}	I-IV	
		Rated mains voltage ≤ 1000 V _{RMS}	I-III	
DIN VDE V 0884-11 (VDE V 0884-11): 2017-01⁽²⁾				
V _{IORM}	Maximum repetitive peak isolation voltage	At AC voltage (bipolar)	1700	V _{PK}
V _{IOWM}	Maximum-rated isolation working voltage	At AC voltage (sine wave); time-dependent dielectric breakdown (TDDB) test	1200	V _{RMS}
		At DC voltage	1700	V _{DC}
V _{IOTM}	Maximum transient isolation voltage	V _{TEST} = V _{IOTM} , t = 60 s (qualification test)	6000	V _{PK}
		V _{TEST} = 1.2 × V _{IOTM} , t = 1 s (100% production test)	7200	V _{PK}
V _{IOSM}	Maximum surge isolation voltage ⁽³⁾	Test method per IEC 60065, 1.2/50-μs waveform, V _{TEST} = 1.6 × V _{IOSM} = 10000 V _{PK} (qualification)	6250	V _{PK}
q _{pd}	Apparent charge ⁽⁴⁾	Method a, after input/output safety test subgroup 2 / 3, V _{ini} = V _{IOTM} , t _{ini} = 60 s, V _{pd(m)} = 1.2 × V _{IORM} , t _m = 10 s	≤ 5	pC
		Method a, after environmental tests subgroup 1, V _{ini} = V _{IOTM} , t _{ini} = 60 s, V _{pd(m)} = 1.6 × V _{IORM} , t _m = 10 s	≤ 5	
		Method b1, at routine test (100% production) and preconditioning (type test), V _{ini} = V _{IOTM} , t _{ini} = 1 s, V _{pd(m)} = 1.875 × V _{IORM} , t _m = 1 s	≤ 5	
C _{IO}	Barrier capacitance, input to output ⁽⁵⁾	V _{IO} = 0.5 V _{PP} at 1 MHz	~3.5	pF
R _{IO}	Insulation resistance, input to output ⁽⁵⁾	V _{IO} = 500 V at T _A = 25°C	> 10 ¹²	Ω
		V _{IO} = 500 V at 100°C ≤ T _A ≤ 125°C	> 10 ¹¹	
		V _{IO} = 500 V at T _S = 150°C	> 10 ⁹	
	Pollution degree		2	
	Climatic category		40/125/21	
UL1577				
V _{ISO}	Withstand isolation voltage	V _{TEST} = V _{ISO} = 5000 V _{RMS} or 7071 V _{DC} , t = 60 s (qualification), V _{TEST} = 1.2 × V _{ISO} , t = 1 s (100% production test)	4250	V _{RMS}

- (1) Apply creepage and clearance requirements according to the specific equipment isolation standards of an application. Care must be taken to maintain the creepage and clearance distance of a board design to ensure that the mounting pads of the isolator on the printed circuit board (PCB) do not reduce this distance. Creepage and clearance on a PCB become equal in certain cases. Techniques such as inserting grooves, ribs, or both on a PCB are used to help increase these specifications.
- (2) This coupler is suitable for *safe electrical insulation* only within the safety ratings. Compliance with the safety ratings must be ensured by means of suitable protective circuits.
- (3) Testing is carried out in air or oil to determine the intrinsic surge immunity of the isolation barrier.
- (4) Apparent charge is electrical discharge caused by a partial discharge (pd).
- (5) All pins on each side of the barrier are tied together, creating a two-pin device.

6.7 Safety-Related Certifications

VDE	UL
Certified according to DIN VDE V 0884-11 (VDE V 0884-11): 2017-01, DIN EN 60950-1 (VDE 0805 Teil 1): 2014-08, and DIN EN 60065 (VDE 0860): 2005-11	Recognized under 1577 component recognition and CSA component acceptance NO 5 programs
Reinforced insulation	Single protection
Certificate number: 40040142	File number: E181974

6.8 Safety Limiting Values

Safety limiting ⁽¹⁾ intends to minimize potential damage to the isolation barrier upon failure of input or output circuitry. A failure of the I/O can allow low resistance to ground or the supply and, without current limiting, dissipate sufficient power to over-heat the die and damage the isolation barrier potentially leading to secondary system failures.

PARAMETER		TEST CONDITIONS	MIN	TYP	MAX	UNIT
I _S	Safety input, output, or supply current	R _{θJA} = 73.5°C/W, VDD = 5.5 V, T _J = 150°C, T _A = 25°C			309	mA
		R _{θJA} = 73.5°C/W, VDD = 3.6 V, T _J = 150°C, T _A = 25°C			472	
P _S	Safety input, output, or total power	R _{θJA} = 73.5°C/W, T _J = 150°C, T _A = 25°C			1700	mW
T _S	Maximum safety temperature				150	°C

- (1) The maximum safety temperature, T_S, has the same value as the maximum junction temperature, T_J, specified for the device. The I_S and P_S parameters represent the safety current and safety power, respectively. Do not exceed the maximum limits of I_S and P_S. These limits vary with the ambient temperature, T_A.
The junction-to-air thermal resistance, R_{θJA}, in the [Thermal Information](#) table is that of a device installed on a high-K test board for leaded surface-mount packages. Use these equations to calculate the value for each parameter:
T_J = T_A + R_{θJA} × P, where P is the power dissipated in the device.
T_{J(max)} = T_S = T_A + R_{θJA} × P_S, where T_{J(max)} is the maximum junction temperature.
P_S = I_S × VDD_{max}, where VDD_{max} is the maximum low-side voltage.

6.9 Electrical Characteristics

minimum and maximum specifications apply from $T_A = -40^\circ\text{C}$ to $+125^\circ\text{C}$, $V_{DD} = 3.0\text{ V}$ to 5.5 V , $I_{NP} = -1\text{ V}$ to $+1\text{ V}$, and $I_{NN} = \text{HGND} = 0\text{ V}$; typical specifications are at $T_A = 25^\circ\text{C}$, and $V_{DD} = 3.3\text{ V}$ (unless otherwise noted)

PARAMETER		TEST CONDITIONS	MIN	TYP	MAX	UNIT
ANALOG INPUT						
R_{IN}	Single-ended input resistance	$I_{NN} = \text{HGND}$	0.1	0.8		G Ω
R_{IND}	Differential input resistance		0.1	1.2		
I_{IB}	Input bias current	$I_{NP} = I_{NN} = \text{HGND}$, $I_{IB} = (I_{IBP} + I_{IBN}) / 2$	-10	2.5	10	nA
TC_{IB}	Input bias current drift			-14		pA/ $^\circ\text{C}$
I_{IO}	Input offset current	$I_{IO} = I_{INP} - I_{INN}$; $I_{NP} = I_{NN} = \text{HGND}$	-10	-0.8	10	nA
C_{IN}	Single-ended input capacitance	$I_{NN} = \text{HGND}$, $f_{IN} = 310\text{ kHz}$		2		pF
C_{IND}	Differential input capacitance	$f_{IN} = 310\text{ kHz}$		2		
ANALOG OUTPUT						
	Nominal gain			2		
V_{CMout}	Common-mode output voltage		1.39	1.44	1.49	V
$V_{CLIPout}$	Clipping differential output voltage	$V_{OUT} = (V_{OUTP} - V_{OUTN})$; $ V_{IN} = V_{INP} - V_{INN} > V_{Clipping}$		± 2.49		V
$V_{Failsafe}$	Fail-safe differential output voltage	$V_+ = (V_{OUTP} - V_{OUTN})$; $V_{DCDCout} \leq V_{DCDCUV}$ or $V_{HLDout} \leq V_{HLDOUTV}$		-2.57	-2.5	V
BW_{OUT}	Output bandwidth		300	375		kHz
R_{OUT}	Output resistance	On OUTP or OUTN		0.2		Ω
	Output short-circuit current	On OUTP or OUTN, sourcing or sinking, $I_{NP} = I_{NN} = \text{HGND}$, outputs shorted to either GND or VDD		14		mA
$CMTI$	Common-mode transient immunity	$ HGND - GND = 2\text{ kV}$	85	135		kV/ μs
ACCURACY						
E_G	Gain error	$T_A = 25^\circ\text{C}$	-0.2%	-0.08%	0.2%	
TCE_G	Gain error drift ⁽¹⁾		-45	± 7	45	ppm/ $^\circ\text{C}$
V_{OS}	Input offset voltage ⁽¹⁾	$T_A = 25^\circ\text{C}$, $I_{NP} = I_{NN} = \text{HGND}$	-0.3	± 0.05	0.3	mV
TCV_{OS}	Input offset drift ⁽¹⁾		-4	± 1	4	$\mu\text{V}/^\circ\text{C}$
	Nonlinearity		-0.02%	0.01%	0.02%	
	Nonlinearity drift			0.4		ppm/ $^\circ\text{C}$
SNR	Signal-to-noise ratio	$V_{IN} = 2\text{ V}_{PP}$, $f_{IN} = 1\text{ kHz}$, $BW = 10\text{ kHz}$, 10 kHz filter	81	85		dB
		$V_{IN} = 2\text{ V}_{PP}$, $f_{IN} = 10\text{ kHz}$, $BW = 100\text{ kHz}$, 1 MHz filter		72		
THD	Total harmonic distortion	$V_{IN} = 2\text{ V}_{PP}$, $f_{IN} = 10\text{ kHz}$, $BW = 100\text{ kHz}$		-84		dB
	Output noise	$I_{NP} = I_{NN} = \text{HGND}$, $f_{IN} = 0\text{ Hz}$, $BW = 100\text{ kHz}$		250		μV_{RMS}
CMRR	Common-mode rejection ratio	$f_{IN} = 0\text{ Hz}$, $V_{CM\ min} \leq V_{CM} \leq V_{CM\ max}$		-100		dB
		$f_{IN} = 10\text{ kHz}$, $V_{CM\ min} \leq V_{CM} \leq V_{CM\ max}$		-86		
PSRR	Power-supply rejection ratio	VDD from 3.0 V to 5.5 V, at dc, input referred		-98		dB
		$I_{NP} = I_{NN} = \text{HGND}$, VDD from 3.0 V to 5.5 V, 10 kHz / 100 mV ripple, input referred		-86		

6.9 Electrical Characteristics (continued)

minimum and maximum specifications apply from $T_A = -40^\circ\text{C}$ to $+125^\circ\text{C}$, $V_{DD} = 3.0\text{ V}$ to 5.5 V , $INP = -1\text{ V}$ to $+1\text{ V}$, and $INN = HGND = 0\text{ V}$; typical specifications are at $T_A = 25^\circ\text{C}$, and $V_{DD} = 3.3\text{ V}$ (unless otherwise noted)

PARAMETER	TEST CONDITIONS	MIN	TYP	MAX	UNIT	
POWER SUPPLY						
IDD	Low-side supply current	No external load on HLDO	28.5	41	mA	
		1 mA external load on HLDO	30.5	43	mA	
V _{DCDC_OUT}	DC/DC output voltage	DCDC_OUT to HGND	3.1	3.5	4.65	V
V _{DCDCUV}	DC/DC output undervoltage detection threshold voltage	DCDC output falling	2.1	2.25		V
V _{HLDO_OUT}	High-side LDO output voltage	HLDO to HGND, up to 1 mA external load	3	3.2	3.4	V
V _{HLDOUV}	High-side LDO output undervoltage detection threshold voltage	HLDO output falling	2.4	2.6		V
I _H	High-side supply current for auxiliary circuitry	Load connected from HLDO_OUT to HGND; non-switching			1	mA
t _{AS}	Analog settling time	V _{DD} step to 3.0 V, to OUTP and OUTN valid, 0.1% settling	0.6	1.1		ms

(1) The typical value includes one standard deviation ("sigma") at nominal operating conditions.

6.10 Switching Characteristics

over operating ambient temperature range (unless otherwise noted)

PARAMETER	TEST CONDITIONS	MIN	TYP	MAX	UNIT
t _r	Output signal rise time		1.3		μs
t _f	Output signal fall time		1.3		μs
	V _{INx} to V _{OUTx} signal delay (50% – 10%)	Unfiltered output	1.2	1.3	μs
	V _{INx} to V _{OUTx} signal delay (50% – 50%)	Unfiltered output	1.6	2.1	μs
	V _{INx} to V _{OUTx} signal delay (50% – 90%)	Unfiltered output	2.2	2.6	μs

6.11 Timing Diagram

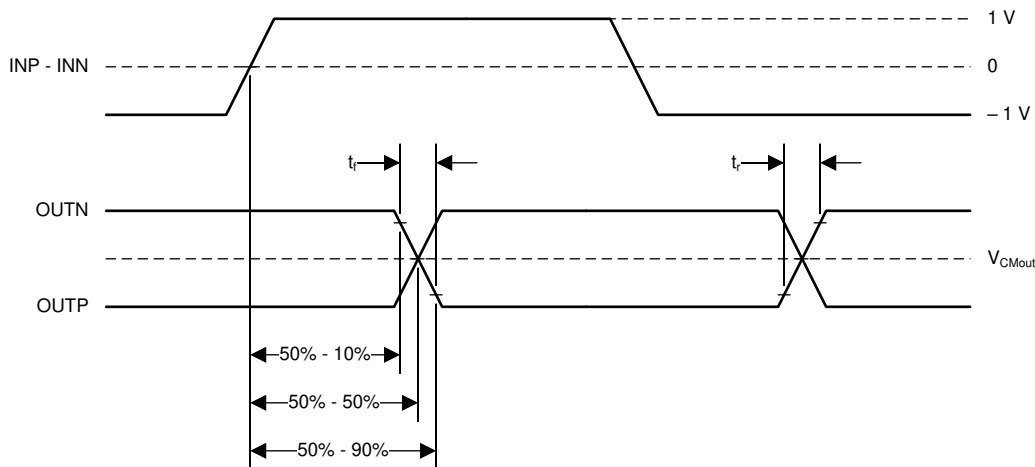

6-1. Rise, Fall, and Delay Time Waveforms

6.12 Insulation Characteristics Curves

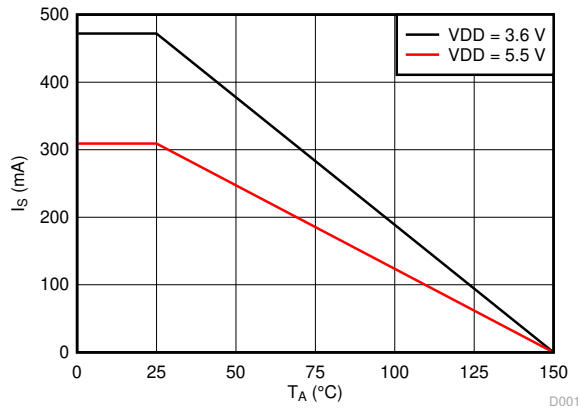

6-2. Thermal Derating Curve for Safety-Limiting Current per VDE

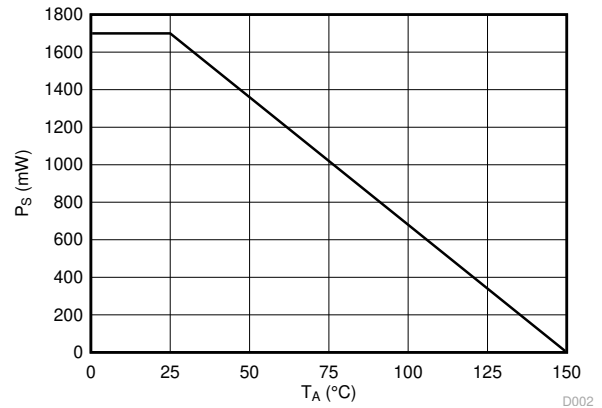

6-3. Thermal Derating Curve for Safety-Limiting Power per VDE

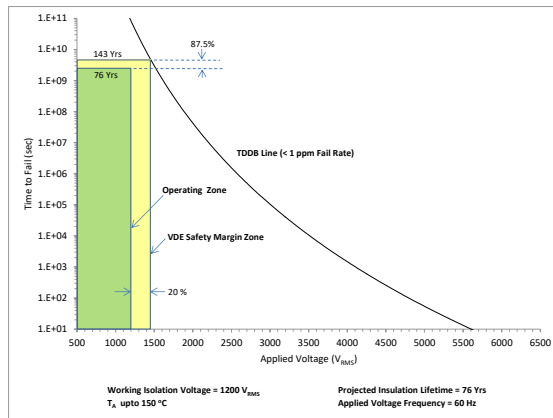

6-4. Reinforced Isolation Capacitor Lifetime Projection

6.13 Typical Characteristics

at VDD = 3.3 V, INP = -1 V to 1 V, INN = HGND = 0V, and $f_{IN} = 10$ kHz (unless otherwise noted)

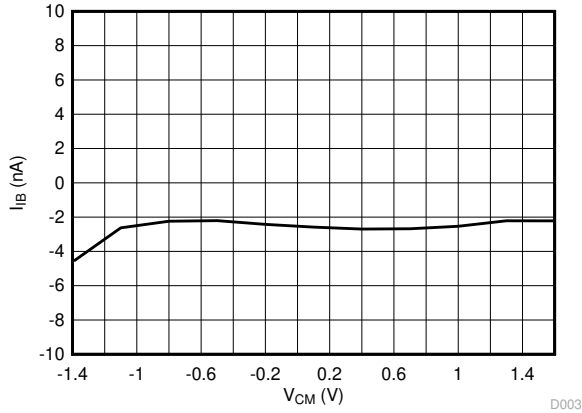

6-5. Input Bias Current vs Common-Mode Input Voltage

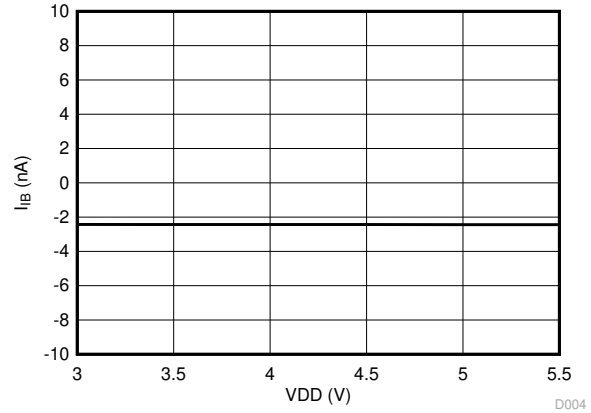

6-6. Input Bias Current vs Supply Voltage

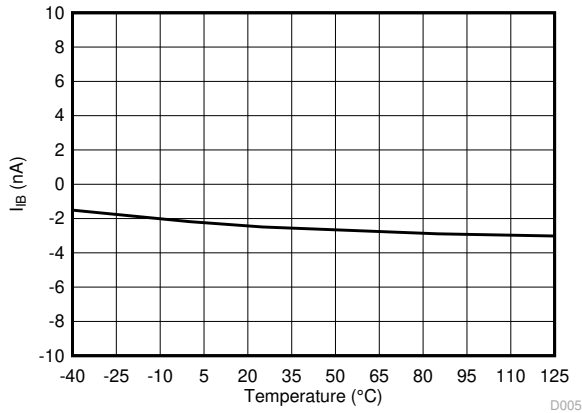

6-7. Input Bias Current vs Temperature

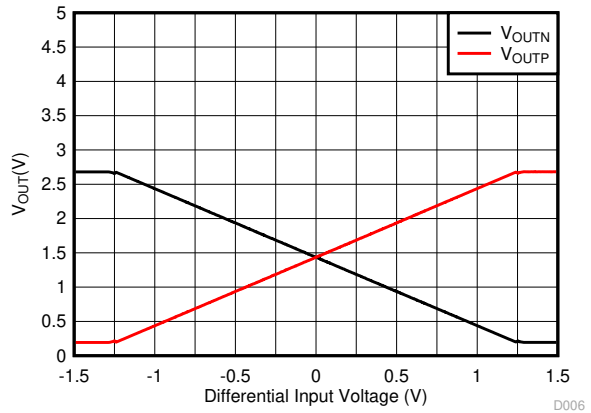

6-8. Output vs Differential Input Voltage

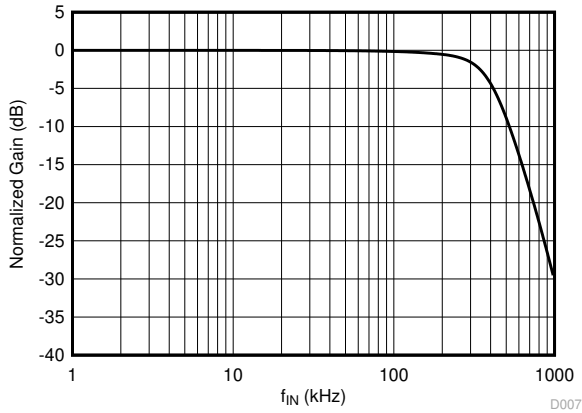

6-9. Normalized Gain vs Input Frequency

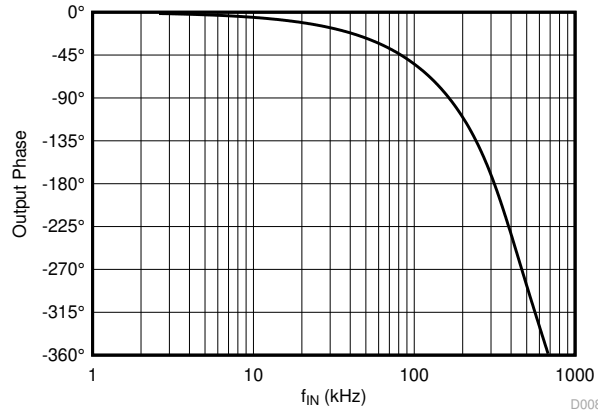

6-10. Output Phase vs Input Frequency

6.13 Typical Characteristics (continued)

at VDD = 3.3 V, INP = -1 V to 1 V, INN = HGND = 0V, and $f_{IN} = 10$ kHz (unless otherwise noted)

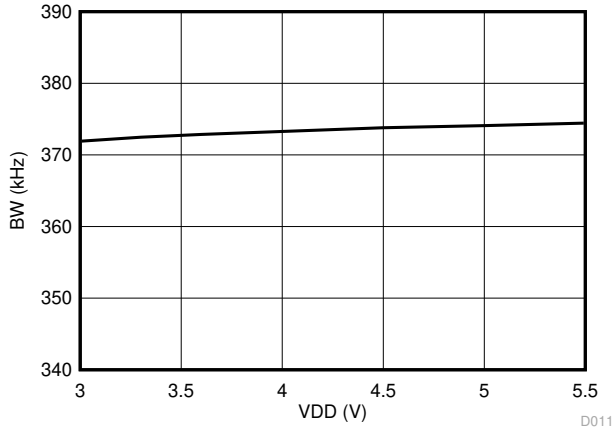

6-11. Output Bandwidth vs Supply Voltage

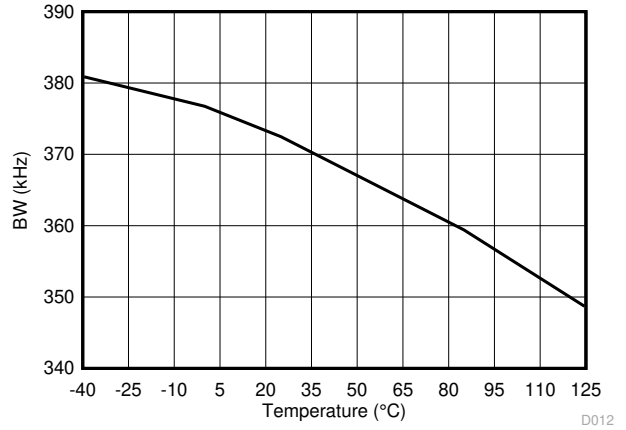

6-12. Output Bandwidth vs Temperature

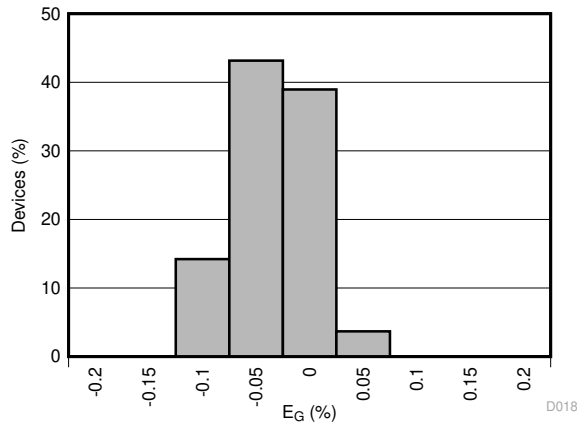

6-13. Gain Error Histogram

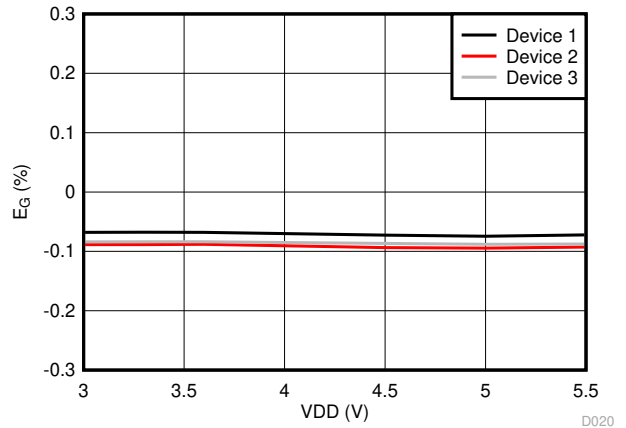

6-14. Gain Error vs Supply Voltage

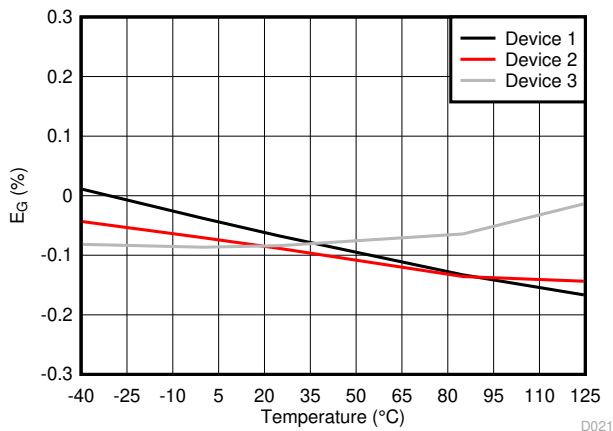

6-15. Gain Error vs Temperature

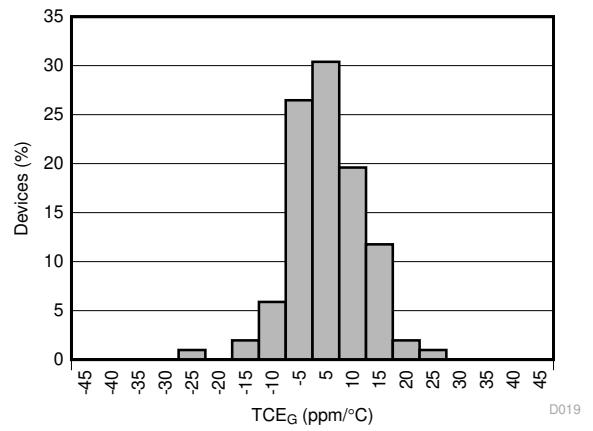

6-16. Gain Error Drift Histogram

6.13 Typical Characteristics (continued)

at VDD = 3.3 V, INP = -1 V to 1 V, INN = HGND = 0V, and $f_{IN} = 10$ kHz (unless otherwise noted)

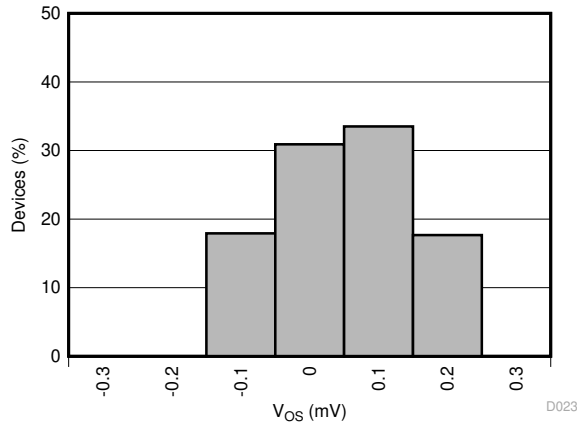

Figure 6-17. Offset Error Histogram

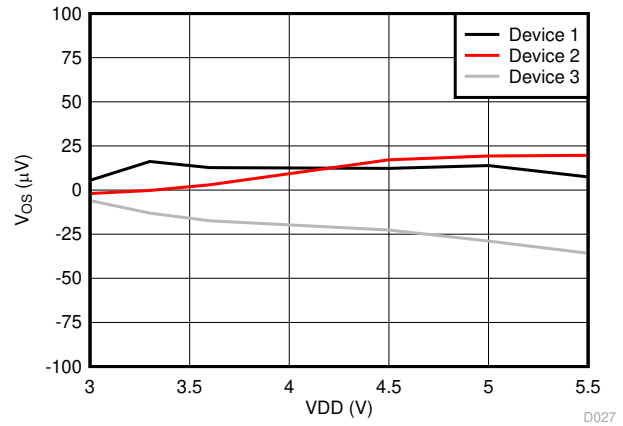

Figure 6-18. Offset Error vs Supply Voltage

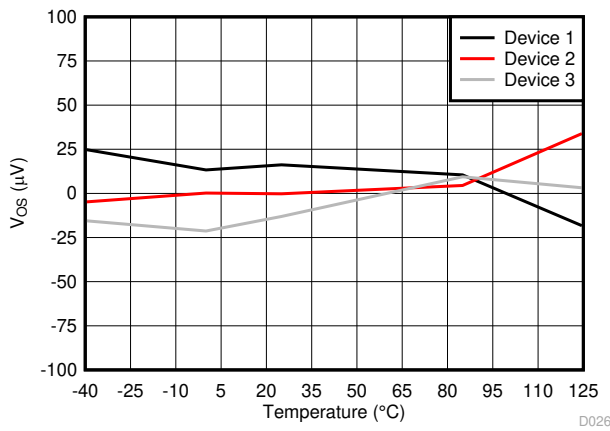

Figure 6-19. Offset Error vs Temperature

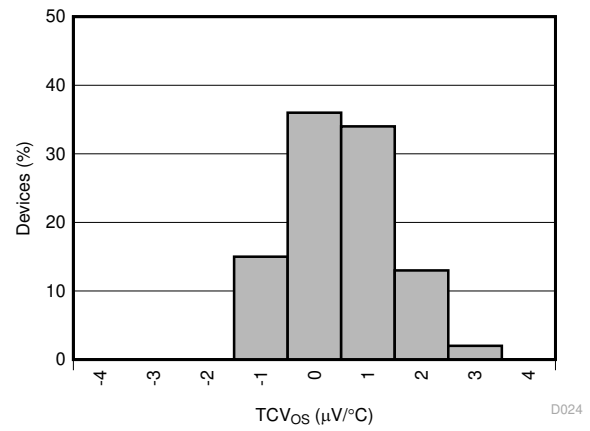

Figure 6-20. Offset Error Drift Histogram

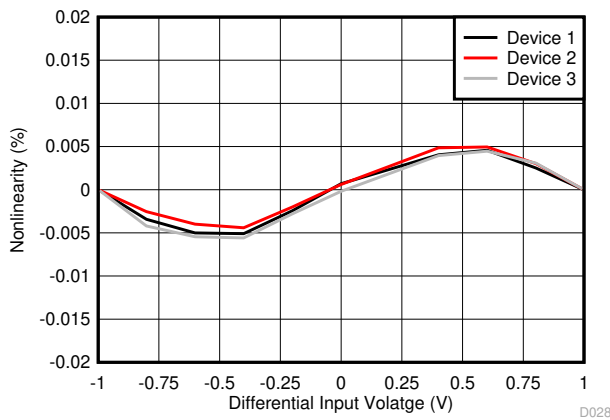

Figure 6-21. Nonlinearity vs Differential Input Voltage

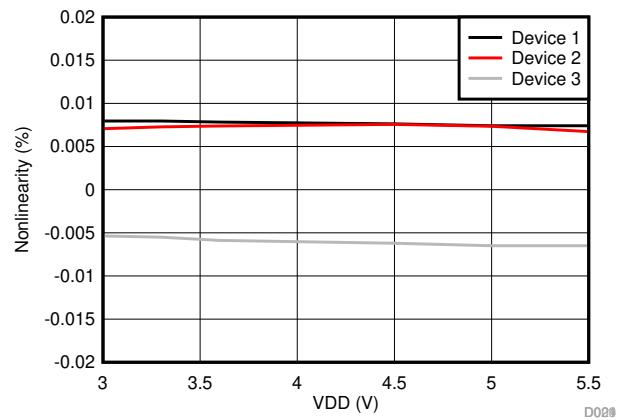
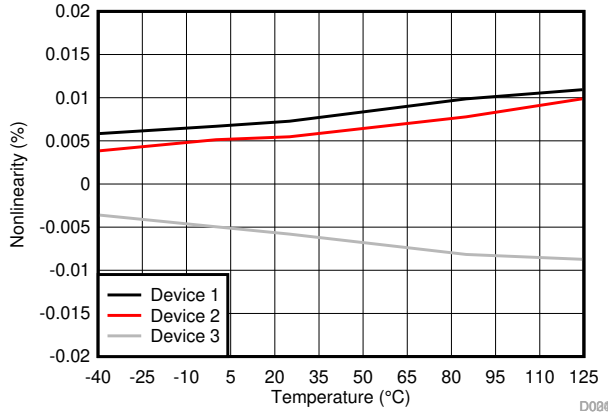

Figure 6-22. Nonlinearity vs Supply Voltage

6.13 Typical Characteristics (continued)

at VDD = 3.3 V, INP = -1 V to 1 V, INN = HGND = 0V, and $f_{IN} = 10$ kHz (unless otherwise noted)



6-23. Nonlinearity vs Temperature

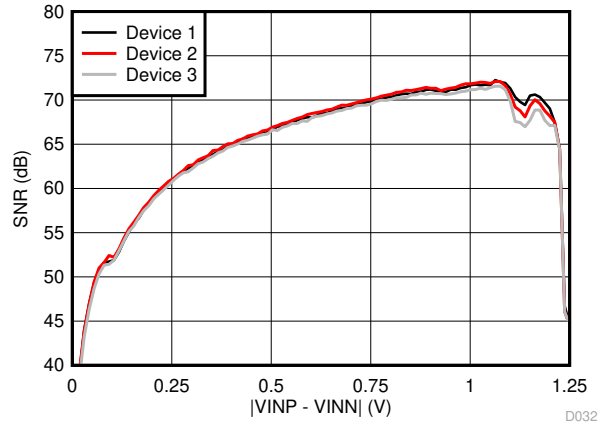

6-24. Signal to Noise Ratio vs Differential Input Voltage

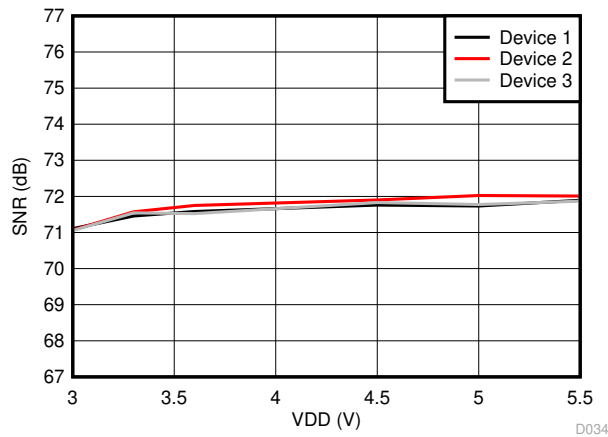

6-25. Signal to Noise Ratio vs Supply Voltage

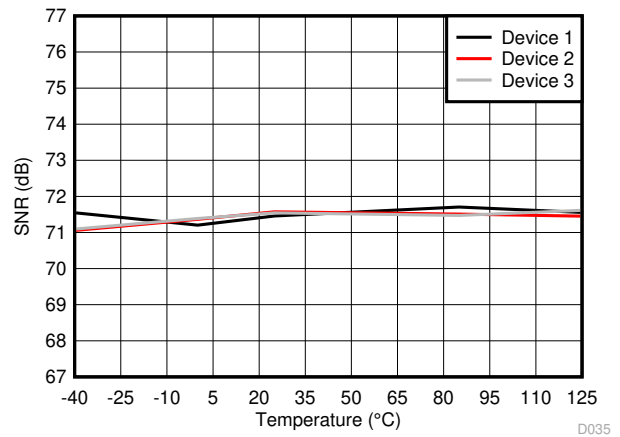

6-26. Signal to Noise Ratio vs Temperature

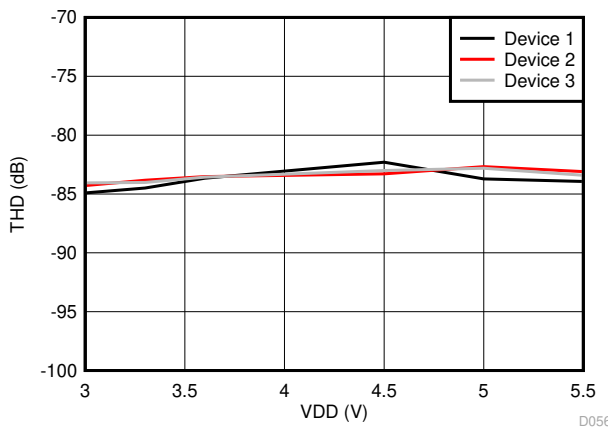

6-27. Total Harmonic Distortion vs Supply Voltage

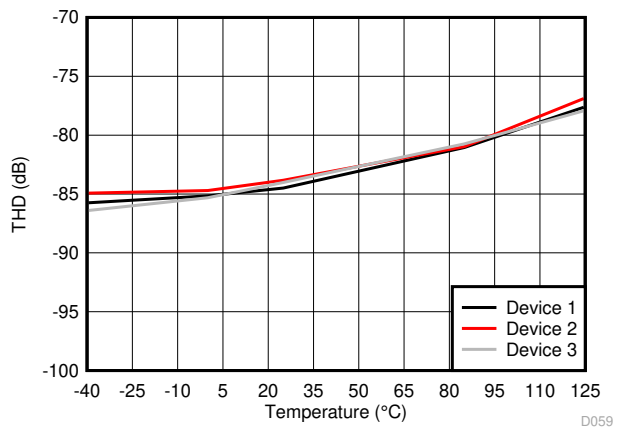

6-28. Total Harmonic Distortion vs Temperature

6.13 Typical Characteristics (continued)

at VDD = 3.3 V, INP = -1 V to 1 V, INN = HGND = 0V, and $f_{IN} = 10$ kHz (unless otherwise noted)

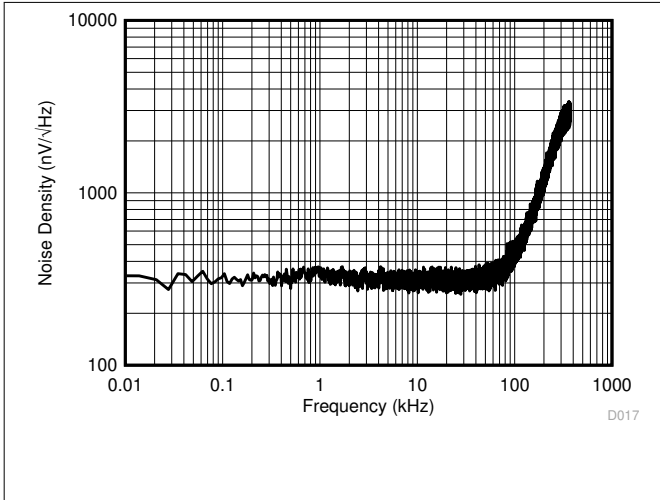

6-29. Input-Referred Noise Density vs Frequency

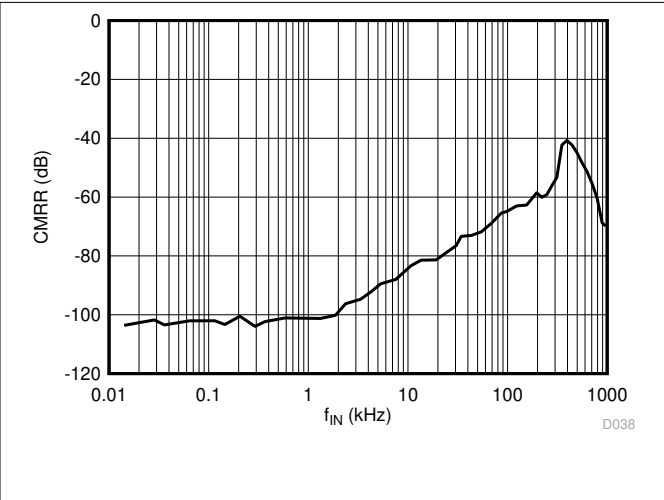

6-30. Common-Mode Rejection Ratio vs Input Frequency

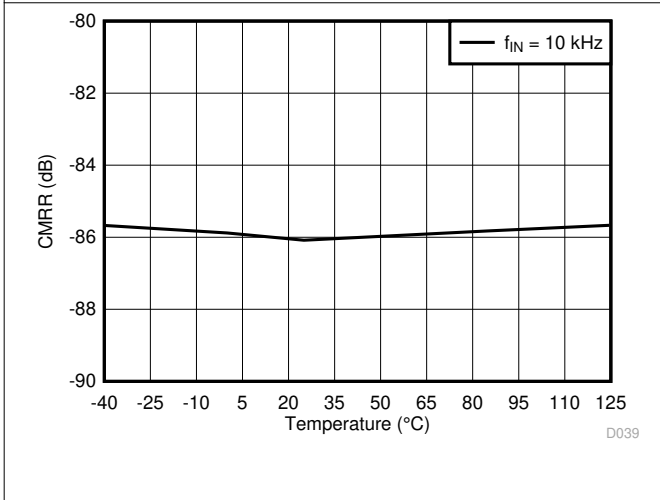

6-31. Common-Mode Rejection Ratio vs Temperature

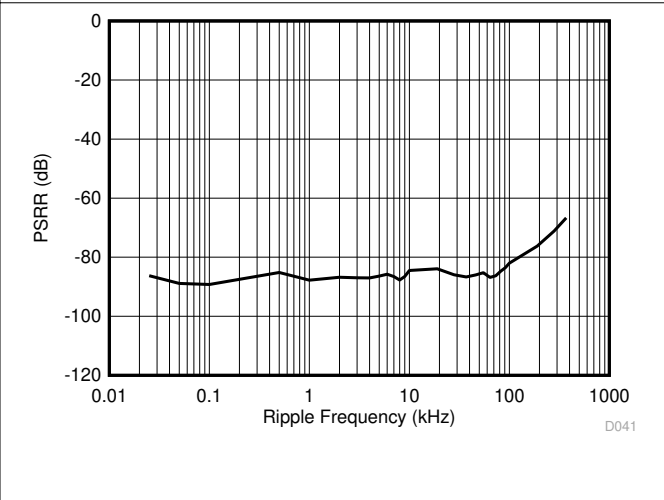

6-32. Power-Supply Rejection Ratio vs Ripple Frequency

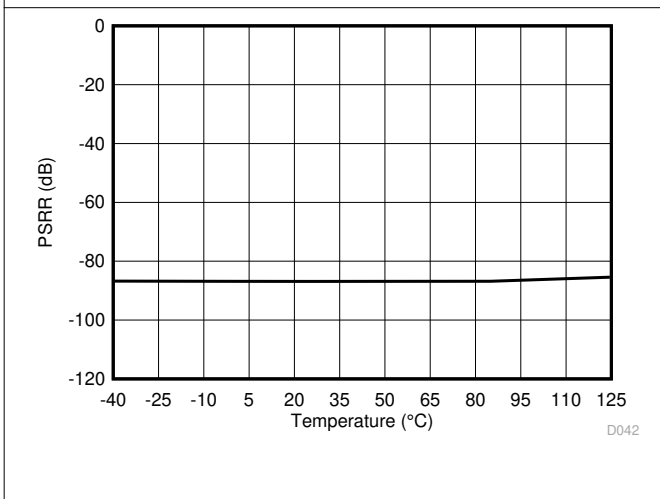

6-33. Power-Supply Rejection Ratio vs Temperature

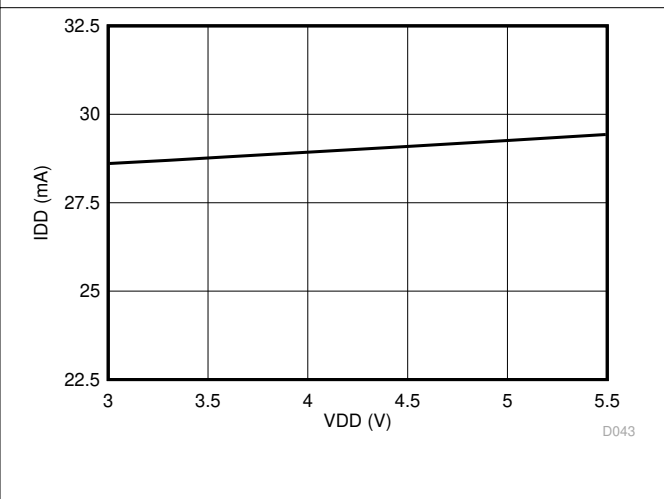

6-34. Input-Supply Current vs Supply Voltage

6.13 Typical Characteristics (continued)

at VDD = 3.3 V, INP = -1 V to 1 V, INN = HGND = 0V, and $f_{IN} = 10$ kHz (unless otherwise noted)

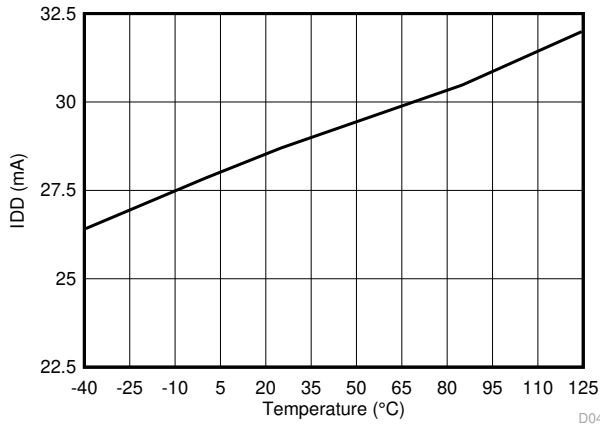

6-35. Input-Supply Current vs Temperature

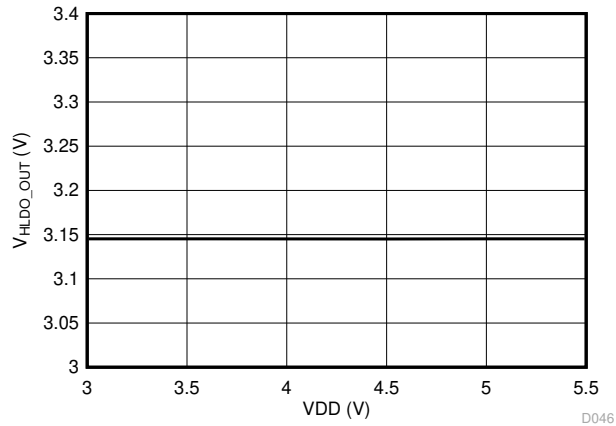

6-36. High-Side LDO Line Regulation

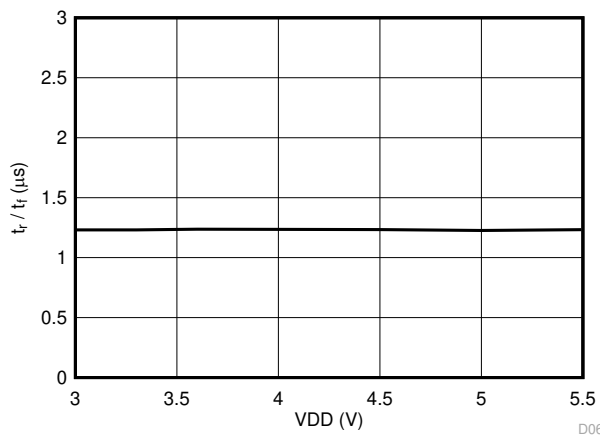

6-37. Output Rise And Fall Time vs Supply Voltage

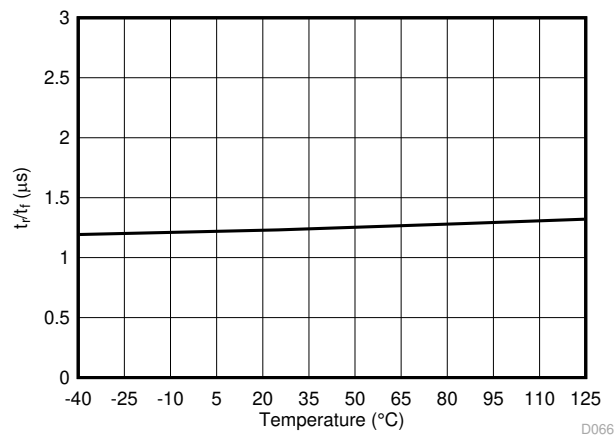

6-38. Output Rise And Fall Time vs Temperature

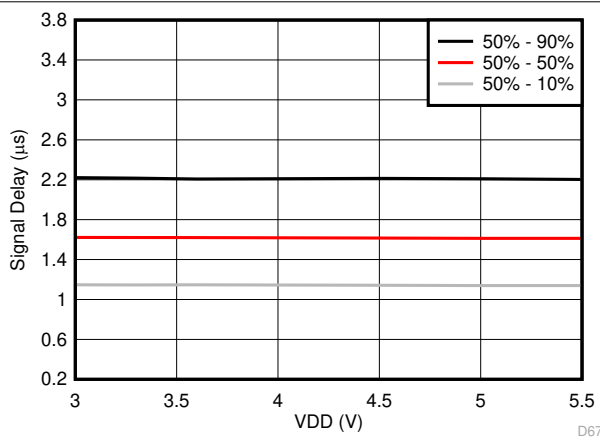

6-39. V_{IN} to V_{OUT} Signal Delay Time vs Supply Voltage

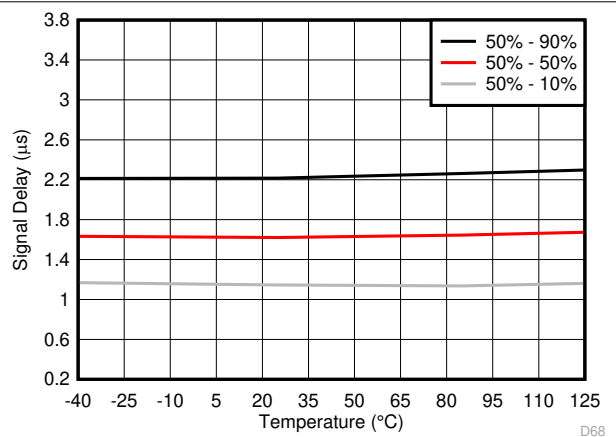

6-40. V_{IN} to V_{OUT} Signal Delay Time vs Temperature

7 Detailed Description

7.1 Overview

The AMC3330 is a fully-differential, precision, isolated amplifier with high input impedance, and an integrated DC/DC converter that allows the device to be supplied from a single 3.3-V or 5-V voltage supply source on the low side. The input stage of the device drives a second-order, delta-sigma ($\Delta\Sigma$) modulator. The modulator uses an internal voltage reference and clock generator to convert the analog input signal to a digital bitstream. The drivers (termed TX in the *Functional Block Diagram*) transfer the output of the modulator across the isolation barrier that separates the high-side and low-side voltage domains. The received bitstream and clock are synchronized and processed by a fourth-order analog filter on the low-side and presented as a differential analog output.

A block diagram of the AMC3330 is shown in the *Functional Block Diagram*. The 1.2-G Ω differential input impedance of the analog input stage supports low gain-error signal-sensing in high-voltage applications using high-impedance resistor dividers.

The signal path is isolated by a double capacitive silicon-dioxide (SiO₂) insulation barrier, whereas power isolation uses an on-chip transformer separated by a thin-film polymer as the insulating material.

7.2 Functional Block Diagram

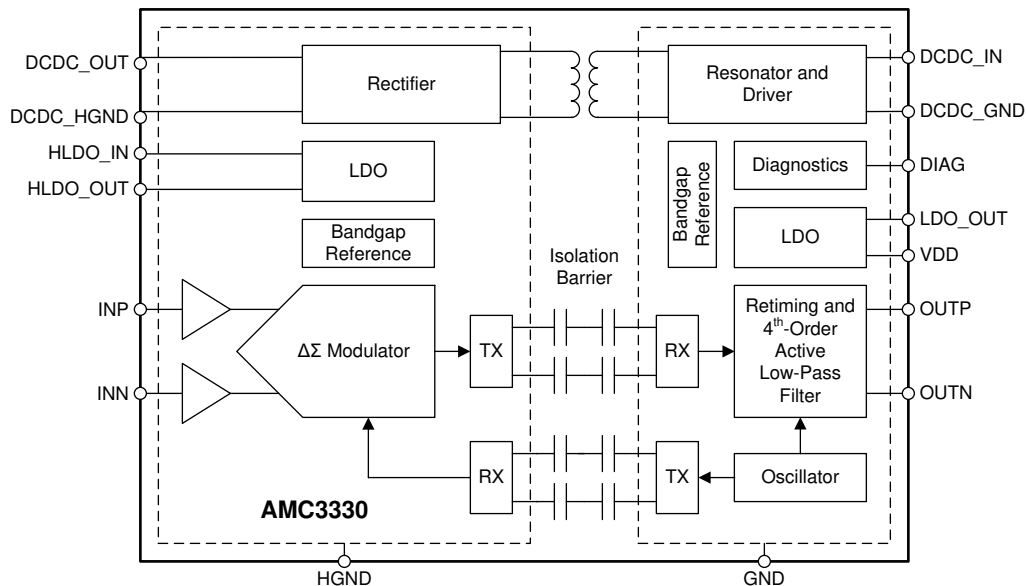

7.3 Feature Description

7.3.1 Analog Input

The input stage of the AMC3330 feeds a second-order, switched-capacitor, feed-forward $\Delta\Sigma$ modulator. The modulator converts the analog signal into a bitstream that is transferred over the isolation barrier, as described in the *Isolation Channel Signal Transmission* section. The high-impedance, and low bias-current input of the AMC3330 makes the device suitable for isolated, high-voltage-sensing applications that typically employ high-impedance resistor dividers.

There are two restrictions on the analog input signals (INP and INN). First, if the input voltage exceeds the input range specified in the *Absolute Maximum Ratings* table, the input current must be limited to 10 mA because the device input electrostatic discharge (ESD) diodes turn on. Second, the linearity and noise performance of the device are ensured only when the differential analog input voltage remains within the specified linear full-scale range V_{FSR} and within the specified input common-mode voltage range V_{CM} as specified in the *Recommended Operating Conditions* table.

7.3.2 Isolation Channel Signal Transmission

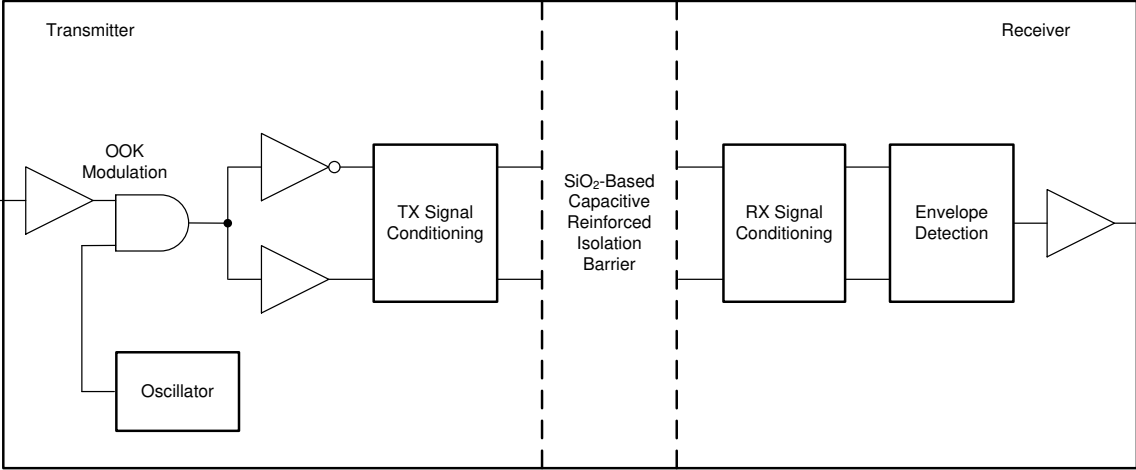
The AMC3330 uses an on-off keying (OOK) modulation scheme to transmit the modulator output-bitstream across the capacitive SiO₂-based isolation barrier.  shows the block diagram of an isolation channel. The transmitter modulates the bitstream at TX IN with an internally generated, 480-MHz carrier and sends a burst across the isolation barrier to represent a digital *one* and sends a *no signal* to represent the digital *zero*. The receiver demodulates the signal after advanced signal conditioning and produces the output. The symmetrical design of each isolation channel improves the common-mode transient immunity (CMTI) performance and reduces the radiated emissions caused by the high-frequency carrier.

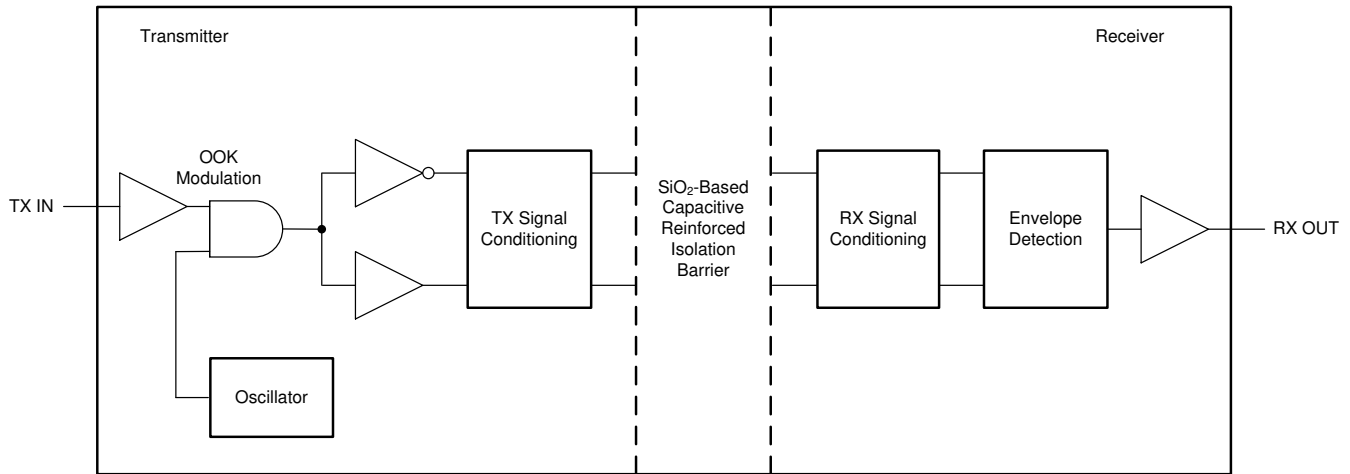

 **7-1. Block Diagram of an Isolation Channel**

 **7-2** shows the concept of the on-off keying scheme.

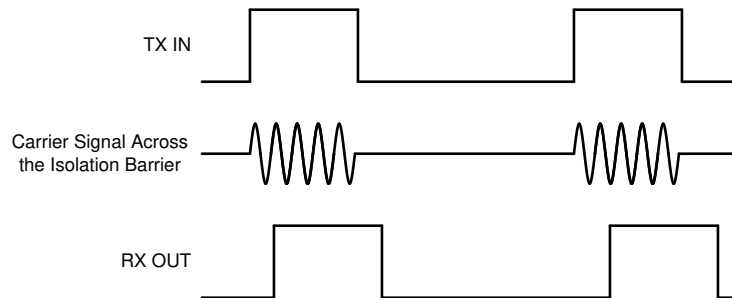

 **7-2. OOK-Based Modulation Scheme**

7.3.3 Analog Output

The AMC3330 offers a differential analog output comprised of the OOUTP and OOUTN pins. For differential input voltages ($V_{INP} - V_{INN}$) in the range from -1 V to 1 V , the device provides a linear response with a nominal gain of 2. For example, for a differential input voltage of 1 V , the differential output voltage ($V_{OOUTP} - V_{OOUTN}$) is 2 V . At zero input (INP shorted to INN), both pins output the same voltage, V_{CMout} , as specified in the [Electrical Characteristics](#) table. For absolute differential input voltages greater than 1.0 V but less than 1.25 V , the differential output voltage continues to increase in magnitude but with reduced linearity performance. The outputs saturate as shown in [Figure 7-3](#) if the differential input voltage exceeds the $V_{Clipping}$ value.

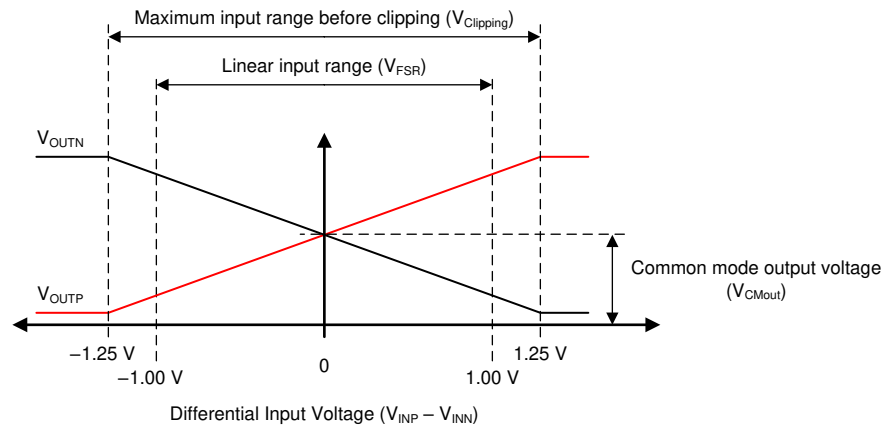
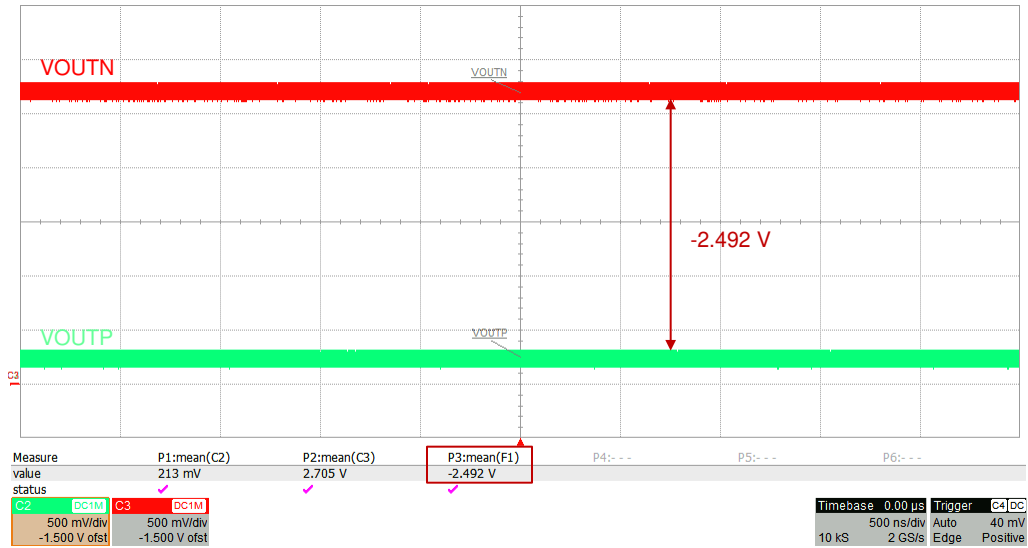

Figure 7-3. AMC3330 Output Behavior

The AMC3330 provides a fail-safe output that simplifies diagnostics on system level. The fail-safe output is active when the integrated DC/DC converter or high-side LDO don't deliver the required supply voltage for the high-side of the device. [Figure 7-4](#) and [Figure 7-5](#) illustrate the fail-safe output of the AMC3330 that is a negative differential output voltage value that does not occur under normal operating conditions. Use the maximum $V_{FAILSAFE}$ voltage specified in the [Electrical Characteristics](#) table as a reference value for the fail-safe detection on system level.



7-4. Typical Negative Clipping Output of the AMC3330



7-5. Typical Fail-Safe Output of the AMC3330

7.3.4 Isolated DC/DC Converter

The AMC3330 offers a fully integrated isolated DC/DC converter that includes the following components illustrated in the [Functional Block Diagram](#):

- Low-dropout regulator (LDO) on the low-side to stabilize the supply voltage VDD that drives the low-side of the DC/DC converter
- Low-side full-bridge inverter and drivers
- Laminate-based, air-core transformer for high immunity to magnetic fields
- High-side full-bridge rectifier
- High-side LDO to stabilize the output voltage of the DC/DC converter for high analog performance of the signal path

The DC/DC converter uses a spread-spectrum clock generation technique to reduce the spectral density of the electromagnetic radiation. The resonator frequency is synchronous to the operation of the $\Delta\Sigma$ modulator to minimize interference with data transmission and support the high analog performance of the device.

The architecture of the DC/DC converter is optimized to drive the high-side circuitry of the AMC3330 and can source up to 1 mA of additional current (I_H) for an optional auxiliary circuit such as an active filter, pre-amplifier, or comparator.

7.3.5 Diagnostic Output and Fail-Safe Behavior

The open-drain DIAG pin can be monitored to confirm the device is operational, and the output voltage is valid. During power-up, the DIAG pin is actively held low until the high-side supply is in regulation and the device operates properly. The DIAG pin is actively pulled low if:

- The low-side does not receive data from the high-side (for example, because of a loss of power on the high-side). The amplifier outputs are driven to negative full-scale.
- The high-side DC/DC output voltage (DCDC_OUT) or the high-side LDO output voltage (HLDO_OUT) drop below their respective undervoltage detection thresholds V_{DCDCUV} and V_{HLDOUV} as specified in the [Electrical Characteristics](#) table. In this case, the low-side may still receive data from the high-side but the data may not be valid. The amplifier outputs are driven to negative full-scale.

During normal operation, the DIAG pin is in a high-impedance state. Connect the DIAG pin to a pull-up supply through a resistor or leave open if not used.

7.4 Device Functional Modes

The AMC3330 is operational when the power supply VDD is applied, as specified in the [Recommended Operating Conditions](#) table.

8 Application and Implementation

Note

Information in the following applications sections is not part of the TI component specification, and TI does not warrant its accuracy or completeness. TI's customers are responsible for determining suitability of components for their purposes. Customers should validate and test their design implementation to confirm system functionality.

8.1 Application Information

The low input bias current, AC and DC errors, and temperature drift make the AMC3330 a high-performance solution for applications where voltage measurement with high common-mode levels is required.

8.2 Typical Application

Isolated amplifiers are widely used for voltage measurements in high-voltage applications that must be isolated from a low-voltage domain. Typical applications are AC line voltage measurements at the input of a power factor correction (PFC) stage or the output of a solar inverter. Other applications are DC measurements at the output of a PFC stage or DC/DC converter, or phase voltage measurements in motor and servo drives. The AMC3330 integrates an isolated power supply for the high-voltage side and therefore is particularly easy to use in applications that do not have a high-side supply readily available or where a high-side supply is referenced to a different ground potential than the signal to be measured.

Figure 8-1 shows a simplified schematic of the AMC3330 in a solar inverter where the AC phase voltage on the grid-side must be measured. At that location in the system, there is no supply readily available for powering the isolated amplifier. The integrated isolated power supply, together with its bipolar input voltage range, makes the AMC3330 ideally suited for AC line-voltage sensing. In this example, phase current is sensed by the AMC3301 across a shunt resistor on the grid-side of an LCL filter where there is also no suitable supply available for powering the isolated amplifier. The integrated power supply of the AMC3301 eliminates that problem and enables current sensing at optimal locations for the system.

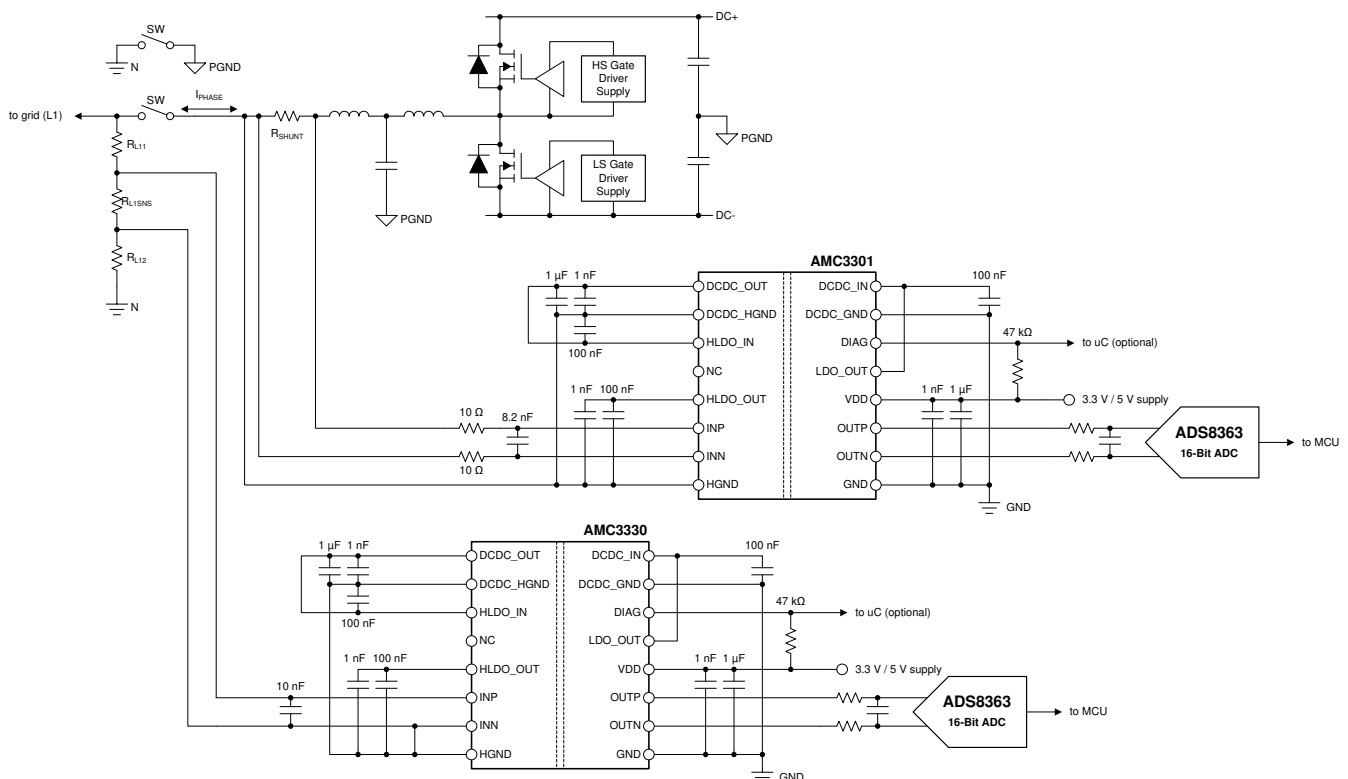

Figure 8-1. The AMC3330 in a Solar Inverter Application

8.2.1 Design Requirements

表 8-1 lists the parameters for this typical application.

表 8-1. Design Requirements

PARAMETER	VALUE
Low-side supply voltage	3.3 V or 5 V
Voltage drop across the sensing resistor for a linear response	1 V (maximum)
Current through the resistive divider, I_{CROSS}	100 μ A (maximum)

8.2.2 Detailed Design Procedure

Use Ohm's Law to calculate the minimum total resistance of the resistive divider to limit the cross current to the desired value ($R_{TOTAL} = V_{LX} / I_{CROSS}$) and the required sense resistor value to be connected to the AMC3330 input: $R_{SNS} = V_{FSR} / I_{CROSS}$.

Consider the following two restrictions to choose the proper value of the sense resistor R_{SNS} :

- The voltage drop on R_{SNS} caused by the nominal voltage range of the system must not exceed the recommended input voltage range: $V_{SNS} \leq V_{FSR}$
- The voltage drop on R_{SNS} caused by the maximum allowed system overvoltage must not exceed the input voltage that causes a clipping output: $V_{SNS} \leq V_{Clipping}$

表 8-2 lists examples of nominal E96-series (1% accuracy) resistor values for systems using 120-V and 230-V AC line voltages.

表 8-2. Resistor Value Examples

PARAMETER	120-V _{RMS} LINE VOLTAGE	120-V _{RMS} LINE VOLTAGE	230-V _{RMS} LINE VOLTAGE
Peak voltage	170 V	170 V	325 V
Resistive divider resistors R_{L11} , R_{L12}	845 k Ω	845 k Ω	1.62 M Ω
Sense resistor R_{SNS}	10 k Ω	10 k Ω	10 k Ω
Current through resistive divider I_{CROSS}	100 μ A	100 μ A	100 μ A
Resulting voltage drop on sense resistor V_{SNS}	1.00 V	1.00 V	1.00 V

8.2.2.1 Input Filter Design

TI recommends placing an RC filter in front of the isolated amplifier to improve signal-to-noise performance of the signal path. Design the input filter such that:

- The cutoff frequency of the filter is at least one order of magnitude lower than the sampling frequency (20 MHz) of the internal $\Delta\Sigma$ modulator
- The input bias current does not generate significant voltage drop across the DC impedance of the input filter
- The impedances measured from the analog inputs are equal

Most voltage sensing applications use high-impedance resistor dividers in front of the isolated amplifier to scale down the input voltage. In this case, a single capacitor shown in 图 8-2 is sufficient to filter the input signal.



图 8-2. Differential Input Filter

8.2.2.2 Differential to Single-Ended Output Conversion

For systems using single-ended input ADCs to convert the analog output voltage into digital, [Figure 8-3](#) shows an example of a TLV6001-based signal conversion and filter circuit. With $R1 = R2 = R3 = R4$, the output voltage equals $(V_{OUTP} - V_{OUTN}) + V_{REF}$. Tailor the bandwidth of this filter stage to the bandwidth requirement of the system and use NP0-type capacitors for best performance. For most applications, $R1 = R2 = R3 = R4 = 10\text{ k}\Omega$ and $C1 = C2 = 1000\text{ pF}$ yields good performance.

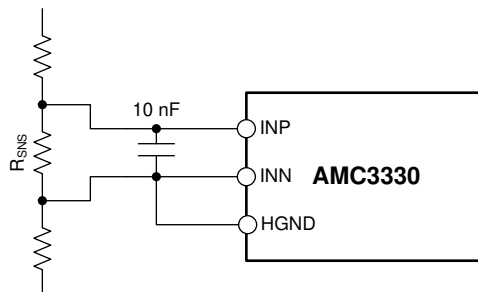
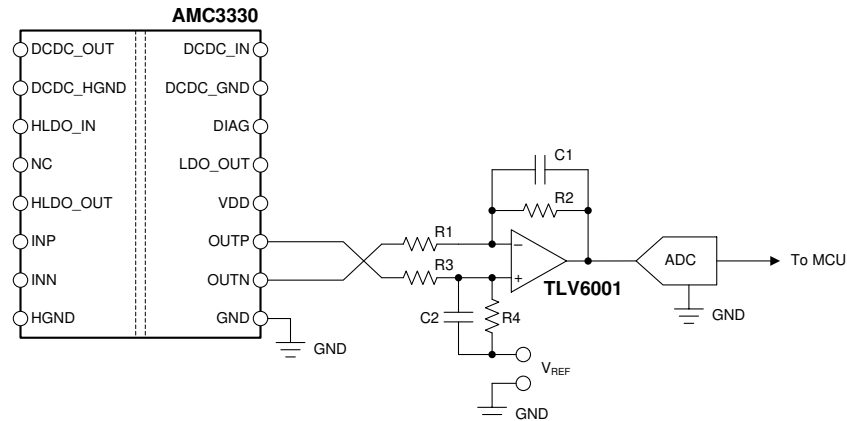

Figure 8-3. Connecting the AMC3330 Output to a Single-Ended Input ADC

For more information on the general procedure to design the filtering and driving stages of SAR ADCs, see the [18-Bit, 1MSPS Data Acquisition Block \(DAQ\) Optimized for Lowest Distortion and Noise](#) and [18-Bit Data Acquisition Block \(DAQ\) Optimized for Lowest Power](#) reference guides, available for download at www.ti.com.

8.2.3 Application Curve

[Figure 8-4](#) shows the typical full-scale step response of the AMC3330.

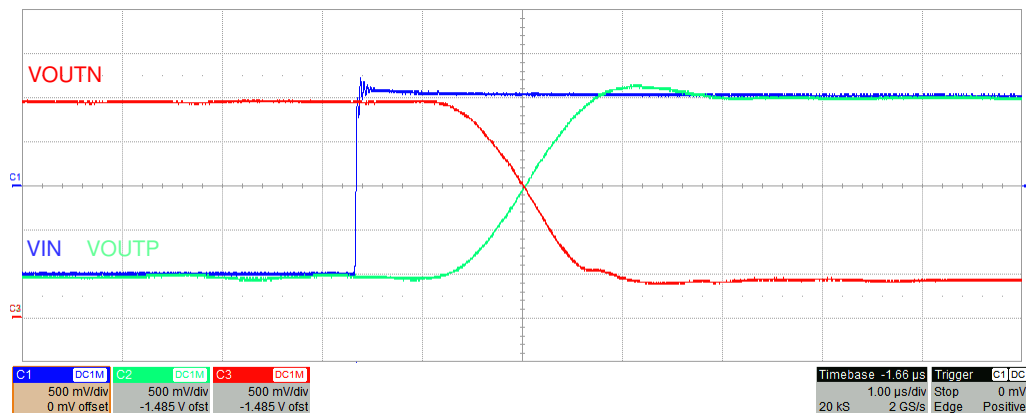

Figure 8-4. Step Response of the AMC3330

8.3 What to Do and What Not to Do

Do not leave the analog inputs INP and INN of the AMC3330 unconnected (floating) when the device is powered up on the high-side. If the device input is left floating, the bias current may generate a negative input voltage that exceeds the specified input voltage range and the output of the device is invalid.

Connect the high-side ground (HGND) to INN, either directly or through a resistive path. A DC current path between INN and HGND is required to define the input common-mode voltage. Take care not to exceed the input common-mode range as specified in the [Recommended Operating Conditions](#) table.

9 Power Supply Recommendations

The AMC3330 is powered from the low-side power supply (VDD) with a nominal value of 3.3 V (or 5 V). TI recommends a low-ESR decoupling capacitor of 1 nF (C8 in [Figure 9-1](#)) placed as close as possible to the VDD pin, followed by a 1- μ F capacitor (C9) to filter this power-supply path.

The low-side of the DC/DC converter is decoupled with a low-ESR 100-nF capacitor (C4) positioned close to the device between the DCDC_IN and DCDC_GND pins. Use a 1- μ F capacitor (C2) to decouple the high-side in addition to a low-ESR, 1-nF capacitor (C3) placed as close as possible to the device and connected to the DCDC_OUT and DCDC_HGND pins.

For the high-side LDO, use low-ESR capacitors of 1-nF (C6), placed as close as possible to the AMC3330, followed by a 100-nF decoupling capacitor (C5).

The ground reference for the high-side (HGND) is derived from the terminal of the sense resistor which is connected to the negative input (INN) of the device. For best DC accuracy, use a separate trace to make this connection but shorting HGND to INN directly at the device input is also acceptable. The high-side DC/DC ground terminal (DCDC_HGND) is shorted to HGND directly at the device pins.

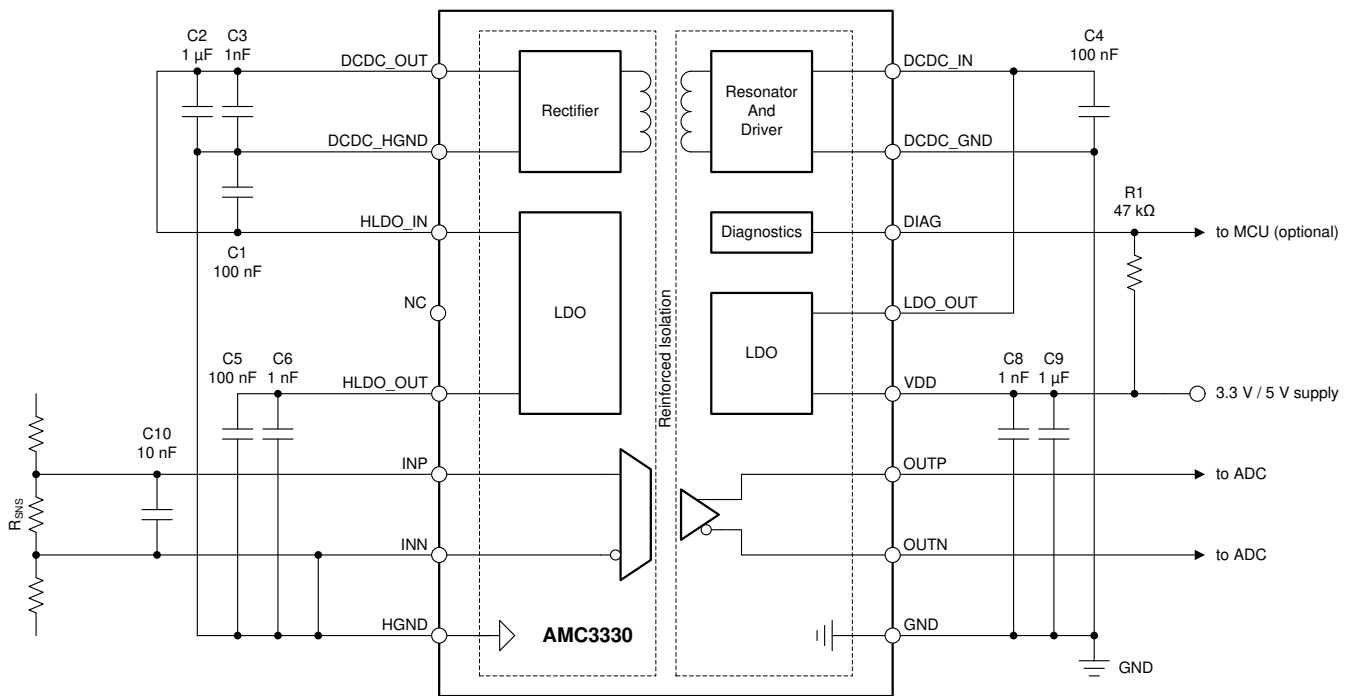

Figure 9-1. Decoupling the AMC3330

Capacitors must provide adequate *effective* capacitance under the applicable DC bias conditions they experience in the application. Multilayer ceramic capacitors (MLCC) capacitors typically exhibit only a fraction of their nominal capacitance under real-world conditions and this factor must be taken into consideration when selecting these capacitors. This problem is especially acute in low-profile capacitors, in which the dielectric field strength is higher than in taller components. Reputable capacitor manufacturers provide capacitance versus DC bias curves that greatly simplify component selection.

表 9-1 lists components suitable for use with the AMC3330. This list is not exhaustive. Other components may exist that are equally suitable (or better), however these listed components have been validated during the development of the AMC3330.

表 9-1. Recommended External Components

	DESCRIPTION	PART NUMBER	MANUFACTURER	SIZE (EIA, L x W)
VDD				
C8	1 nF ± 10%, X7R, 50 V	12065C102KAT2A	AVX	1206, 3.2 mm x 1.6 mm
C9	1 μF ± 10%, X7R, 25 V	12063C105KAT2A	AVX	1206, 3.2 mm x 1.6 mm
DC/DC CONVERTER				
C4	100 nF ± 10%, X7R, 50 V	C0603C104K5RACAUTO	Kemet	0603, 1.6 mm x 0.8 mm
C3	1 nF ± 10%, X7R, 50 V	C0603C102K5RACTU	Kemet	0603, 1.6 mm x 0.8 mm
C2	1 μF ± 10%, X7R, 25 V	CGA3E1X7R1E105K080AC	TDK	0603, 1.6 mm x 0.8 mm
HLDO				
C1	100 nF ± 10%, X7R, 50 V	C0603C104K5RACAUTO	Kemet	0603, 1.6 mm x 0.8 mm
C5	100 nF ± 5%, NP0, 50 V	C3216NP01H104J160AA	TDK	1206, 3.2 mm x 1.6 mm
C6	1 nF ± 10%, X7R, 50 V	12065C102KAT2A	AVX	1206, 3.2 mm x 1.6 mm

10 Layout

10.1 Layout Guidelines

 10-1 shows a layout recommendation with the critical placement of the decoupling capacitors. The same component reference designators are used as in the [Power Supply Recommendations](#) section. Decoupling capacitors are placed as close as possible to the AMC3330 supply pins. For best performance, place the sense resistor close to the INP and INN inputs of the AMC3330 and keep the layout of both connections symmetrical.

This layout is used on the AMC3330 EVM and supports CISPR-11 compliant electromagnetic radiation levels.

10.2 Layout Example

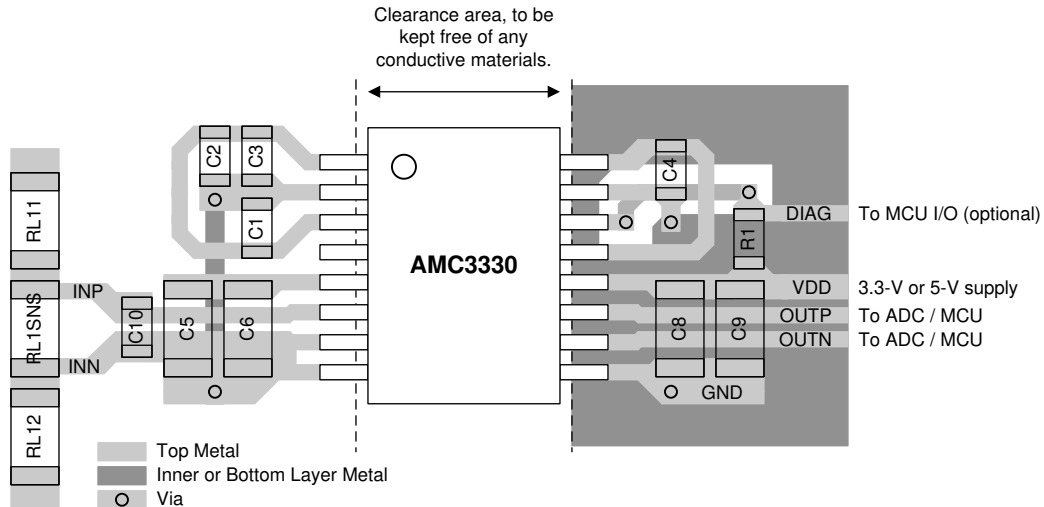

 10-1. Recommended Layout of the AMC3330

11 Device and Documentation Support

11.1 Device Support

11.1.1 Device Nomenclature

Texas Instruments, [Isolation Glossary](#)

11.2 Documentation Support

11.2.1 Related Documentation

For related documentation see the following:

- Texas Instruments, [ISO72x Digital Isolator Magnetic-Field Immunity](#) application report
- Texas Instruments, [AMC3301 Precision, ±250-mV Input, Reinforced Isolated Amplifier With Integrated DC/DC Converter](#) data sheet
- Texas Instruments, [TLV600x Low-Power, Rail-to-Rail In/Out, 1-MHz Operational Amplifier for Cost-Sensitive Systems](#) data sheet
- Texas Instruments, [18-Bit, 1MSPS Data Acquisition Block \(DAQ\) Optimized for Lowest Distortion and Noise](#) reference guide
- Texas Instruments, [18-Bit Data Acquisition Block \(DAQ\) Optimized for Lowest Power](#) reference guide

11.3 Receiving Notification of Documentation Updates

To receive notification of documentation updates, navigate to the device product folder on [ti.com](#). Click on [Subscribe to updates](#) to register and receive a weekly digest of any product information that has changed. For change details, review the revision history included in any revised document.

11.4 Support Resources

[TI E2E™ support forums](#) are an engineer's go-to source for fast, verified answers and design help — straight from the experts. Search existing answers or ask your own question to get the quick design help you need.

Linked content is provided "AS IS" by the respective contributors. They do not constitute TI specifications and do not necessarily reflect TI's views; see TI's [Terms of Use](#).

11.5 Trademarks

TI E2E™ is a trademark of Texas Instruments.

すべての商標は、それぞれの所有者に帰属します。

11.6 Electrostatic Discharge Caution



This integrated circuit can be damaged by ESD. Texas Instruments recommends that all integrated circuits be handled with appropriate precautions. Failure to observe proper handling and installation procedures can cause damage.

ESD damage can range from subtle performance degradation to complete device failure. Precision integrated circuits may be more susceptible to damage because very small parametric changes could cause the device not to meet its published specifications.

11.7 Glossary

[TI Glossary](#) This glossary lists and explains terms, acronyms, and definitions.

12 Mechanical, Packaging, and Orderable Information

The following pages include mechanical, packaging, and orderable information. This information is the most current data available for the designated devices. This data is subject to change without notice and revision of this document. For browser-based versions of this data sheet, refer to the left-hand navigation.

PACKAGING INFORMATION

Orderable Device	Status (1)	Package Type	Package Drawing	Pins	Package Qty	Eco Plan (2)	Lead finish/ Ball material (6)	MSL Peak Temp (3)	Op Temp (°C)	Device Marking (4/5)	Samples
AMC3330DWE	ACTIVE	SOIC	DWE	16	40	RoHS & Green	NIPDAU	Level-3-260C-168 HR	-40 to 125	AMC3330	Samples
AMC3330DWER	ACTIVE	SOIC	DWE	16	2000	RoHS & Green	NIPDAU	Level-3-260C-168 HR	-40 to 125	AMC3330	Samples

(1) The marketing status values are defined as follows:

ACTIVE: Product device recommended for new designs.

LIFEBUY: TI has announced that the device will be discontinued, and a lifetime-buy period is in effect.

NRND: Not recommended for new designs. Device is in production to support existing customers, but TI does not recommend using this part in a new design.

PREVIEW: Device has been announced but is not in production. Samples may or may not be available.

OBSOLETE: TI has discontinued the production of the device.

(2) **RoHS:** TI defines "RoHS" to mean semiconductor products that are compliant with the current EU RoHS requirements for all 10 RoHS substances, including the requirement that RoHS substance do not exceed 0.1% by weight in homogeneous materials. Where designed to be soldered at high temperatures, "RoHS" products are suitable for use in specified lead-free processes. TI may reference these types of products as "Pb-Free".

RoHS Exempt: TI defines "RoHS Exempt" to mean products that contain lead but are compliant with EU RoHS pursuant to a specific EU RoHS exemption.

Green: TI defines "Green" to mean the content of Chlorine (Cl) and Bromine (Br) based flame retardants meet JS709B low halogen requirements of <=1000ppm threshold. Antimony trioxide based flame retardants must also meet the <=1000ppm threshold requirement.

(3) MSL, Peak Temp. - The Moisture Sensitivity Level rating according to the JEDEC industry standard classifications, and peak solder temperature.

(4) There may be additional marking, which relates to the logo, the lot trace code information, or the environmental category on the device.

(5) Multiple Device Markings will be inside parentheses. Only one Device Marking contained in parentheses and separated by a "~" will appear on a device. If a line is indented then it is a continuation of the previous line and the two combined represent the entire Device Marking for that device.

(6) Lead finish/Ball material - Orderable Devices may have multiple material finish options. Finish options are separated by a vertical ruled line. Lead finish/Ball material values may wrap to two lines if the finish value exceeds the maximum column width.

Important Information and Disclaimer:The information provided on this page represents TI's knowledge and belief as of the date that it is provided. TI bases its knowledge and belief on information provided by third parties, and makes no representation or warranty as to the accuracy of such information. Efforts are underway to better integrate information from third parties. TI has taken and continues to take reasonable steps to provide representative and accurate information but may not have conducted destructive testing or chemical analysis on incoming materials and chemicals. TI and TI suppliers consider certain information to be proprietary, and thus CAS numbers and other limited information may not be available for release.

In no event shall TI's liability arising out of such information exceed the total purchase price of the TI part(s) at issue in this document sold by TI to Customer on an annual basis.

OTHER QUALIFIED VERSIONS OF AMC3330 :

- Automotive : [AMC3330-Q1](#)

NOTE: Qualified Version Definitions:

- Automotive - Q100 devices qualified for high-reliability automotive applications targeting zero defects

TAPE AND REEL INFORMATION

QUADRANT ASSIGNMENTS FOR PIN 1 ORIENTATION IN TAPE



*All dimensions are nominal

Device	Package Type	Package Drawing	Pins	SPQ	Reel Diameter (mm)	Reel Width W1 (mm)	A0 (mm)	B0 (mm)	K0 (mm)	P1 (mm)	W (mm)	Pin1 Quadrant
AMC3330DWER	SOIC	DWE	16	2000	330.0	16.4	10.75	10.7	2.7	12.0	16.0	Q1

TAPE AND REEL BOX DIMENSIONS

*All dimensions are nominal

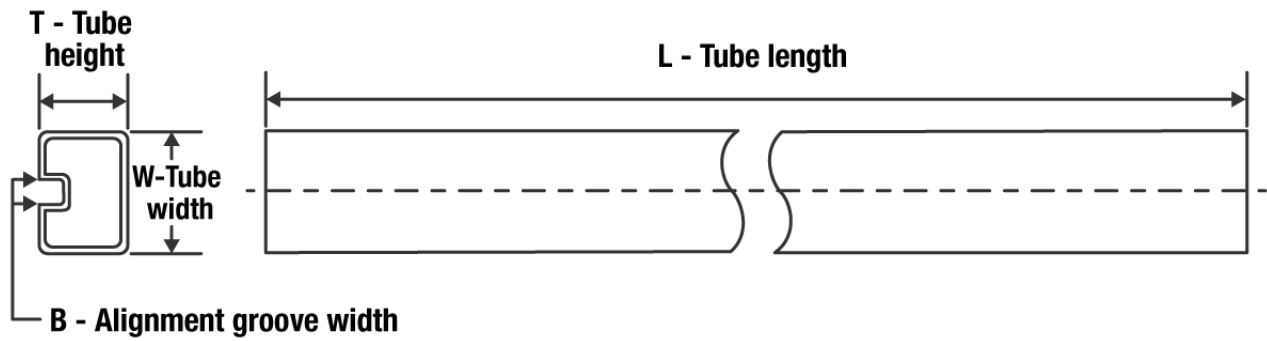
Device	Package Type	Package Drawing	Pins	SPQ	Length (mm)	Width (mm)	Height (mm)
AMC3330DWER	SOIC	DWE	16	2000	350.0	350.0	43.0

TUBE

*All dimensions are nominal

Device	Package Name	Package Type	Pins	SPQ	L (mm)	W (mm)	T (μm)	B (mm)
AMC3330DWE	DWE	SO-MOD	16	40	506.98	12.7	4826	6.6



PACKAGE OUTLINE

DWE0016A

SOIC - 2.65 mm max height

SOIC

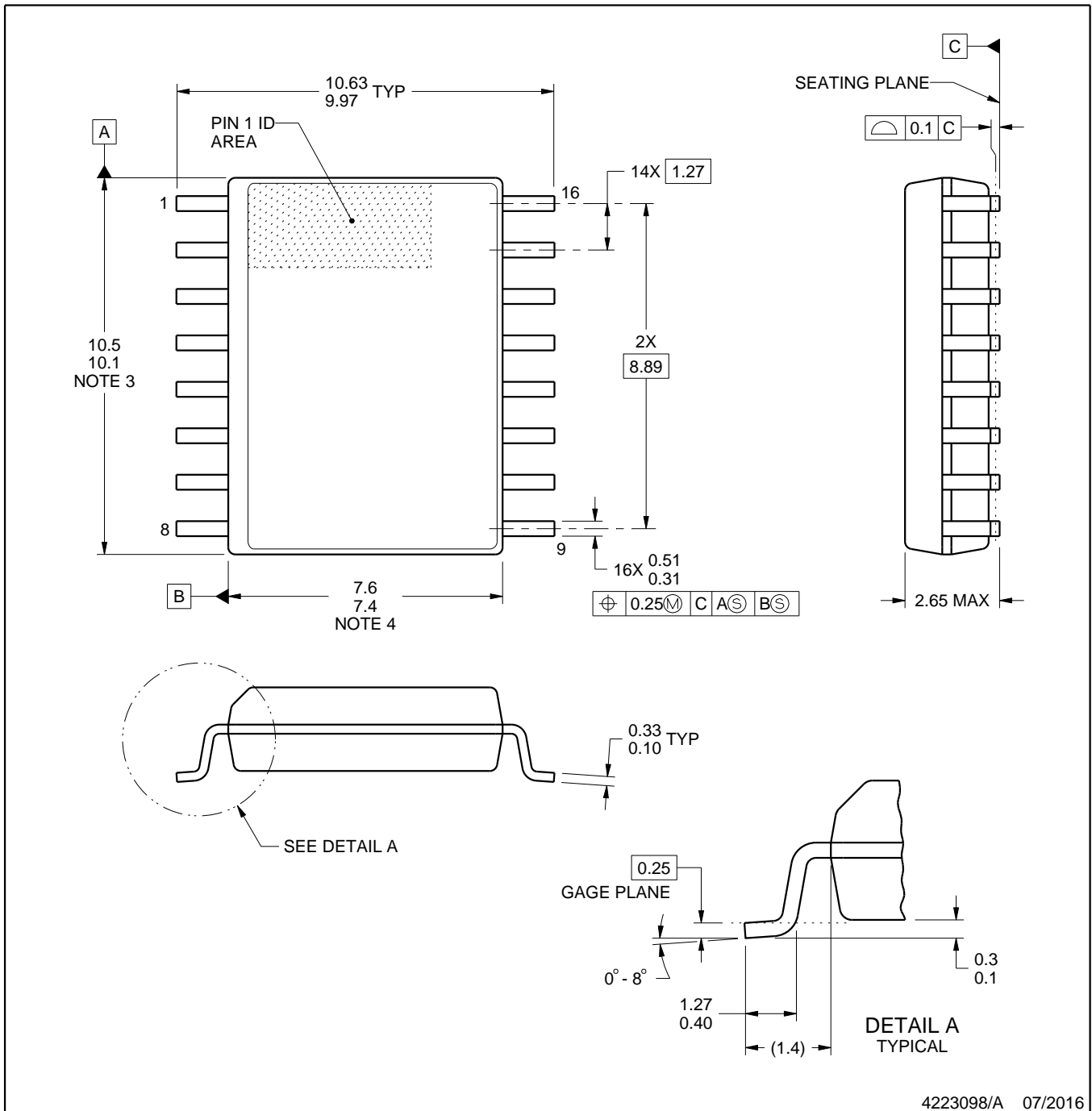

NOTES:

1. All linear dimensions are in millimeters. Any dimensions in parenthesis are for reference only. Dimensioning and tolerancing per ASME Y14.5M.
2. This drawing is subject to change without notice.
3. This dimension does not include mold flash, protrusions, or gate burrs. Mold flash, protrusions, or gate burrs shall not exceed 0.15 mm, per side.
4. This dimension does not include interlead flash. Interlead flash shall not exceed 0.25 mm, per side.
5. Reference JEDEC registration MS-013.

EXAMPLE BOARD LAYOUT

DWE0016A

SOIC - 2.65 mm max height

SOIC

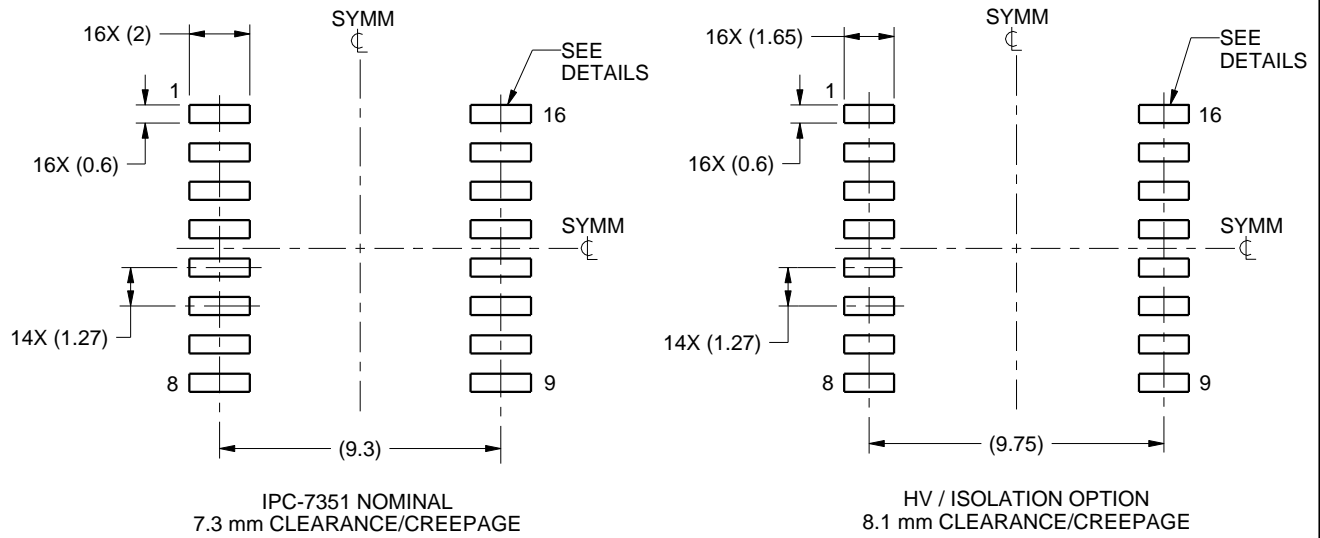

LAND PATTERN EXAMPLE
SCALE:4X

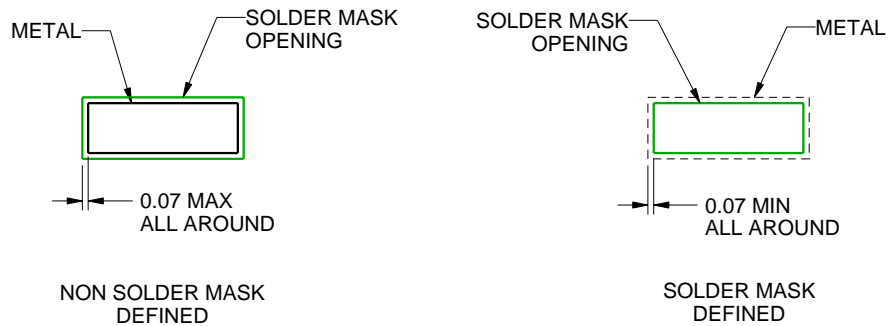

SOLDER MASK DETAILS

4223098/A 07/2016

NOTES: (continued)

- 6. Publication IPC-7351 may have alternate designs.
- 7. Solder mask tolerances between and around signal pads can vary based on board fabrication site.

EXAMPLE STENCIL DESIGN

DWE0016A

SOIC - 2.65 mm max height

SOIC

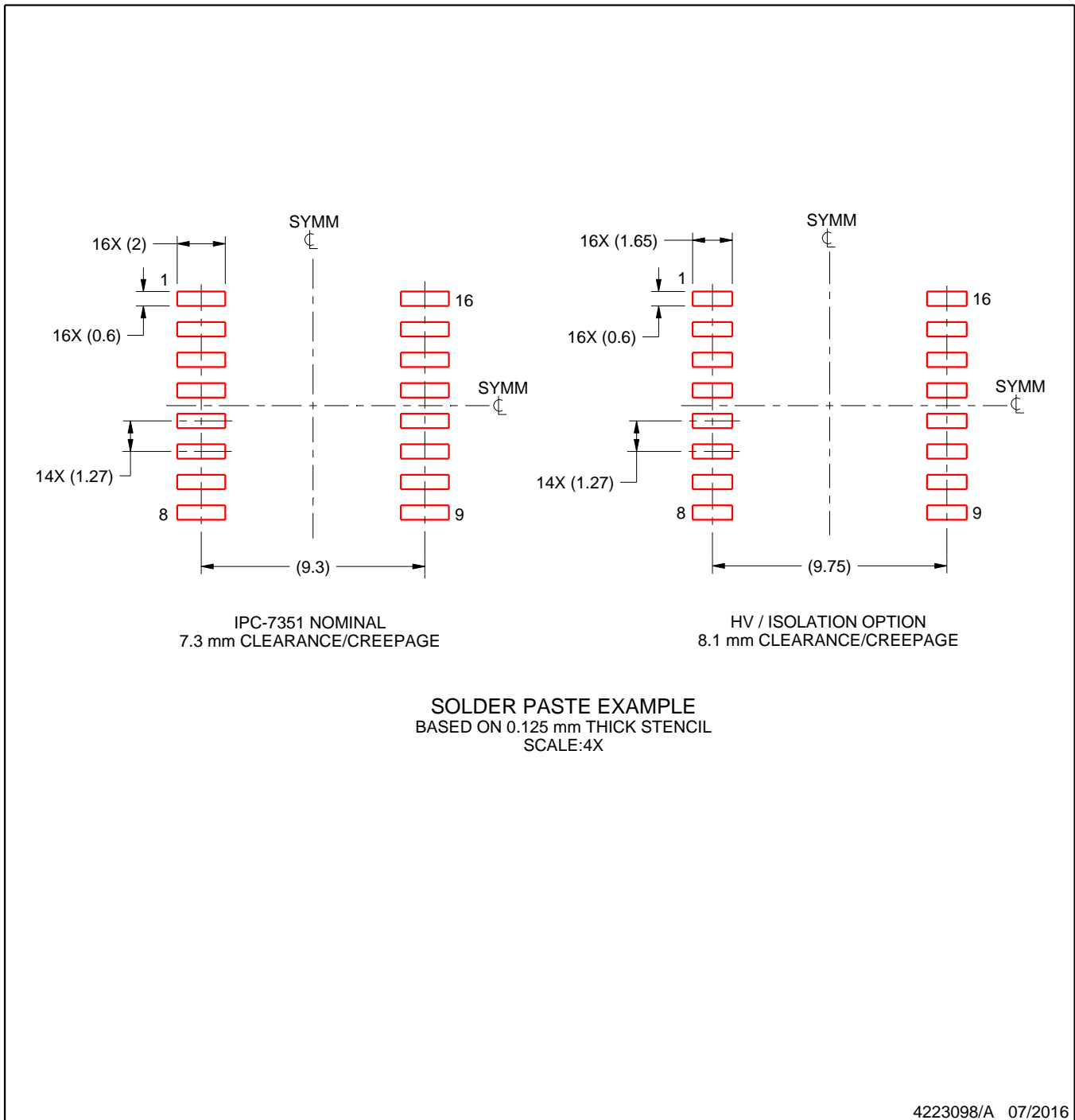

NOTES: (continued)

8. Laser cutting apertures with trapezoidal walls and rounded corners may offer better paste release. IPC-7525 may have alternate design recommendations.
9. Board assembly site may have different recommendations for stencil design.

重要なお知らせと免責事項

TI は、技術データと信頼性データ(データシートを含みます)、設計リソース(リファレンス・デザインを含みます)、アプリケーションや設計に関する各種アドバイス、Web ツール、安全性情報、その他のリソースを、欠陥が存在する可能性のある「現状のまま」提供しており、商品性および特定目的に対する適合性の黙示保証、第三者の知的財産権の非侵害保証を含むいかなる保証も、明示的または黙示的にかかわらず拒否します。

これらのリソースは、TI 製品を使用する設計の経験を積んだ開発者への提供を意図したものです。(1) お客様のアプリケーションに適した TI 製品の選定、(2) お客様のアプリケーションの設計、検証、試験、(3) お客様のアプリケーションに該当する各種規格や、その他のあらゆる安全性、セキュリティ、規制、または他の要件への確実な適合に関する責任を、お客様のみが単独で負うものとし、

上記の各種リソースは、予告なく変更される可能性があります。これらのリソースは、リソースで説明されている TI 製品を使用するアプリケーションの開発の目的でのみ、TI はその使用をお客様に許諾します。これらのリソースに関して、他の目的で複製することや掲載することは禁止されています。TI や第三者の知的財産権のライセンスが付与されている訳ではありません。お客様は、これらのリソースを自身で使用した結果発生するあらゆる申し立て、損害、費用、損失、責任について、TI およびその代理人を完全に補償するものとし、TI は一切の責任を拒否します。

TI の製品は、[TI の販売条件](#)、または [ti.com](https://www.ti.com) やかかる TI 製品の関連資料などのいずれかを通じて提供する適用可能な条項の下で提供されています。TI がこれらのリソースを提供することは、適用される TI の保証または他の保証の放棄の拡大や変更を意味するものではありません。

お客様がいかなる追加条項または代替条項を提案した場合でも、TI はそれらに異議を唱え、拒否します。

郵送先住所 : Texas Instruments, Post Office Box 655303, Dallas, Texas 75265

Copyright © 2022, Texas Instruments Incorporated