

- Meets or Exceeds the Requirement of TIA/EIA-232-F and ITU Recommendation V.28
- Withstands Sustained Output Short Circuit to Any Low-Impedance Voltage Between -25 V and 25 V
- $2\text{-}\mu\text{s}$ Maximum Transition Time Through the 3-V to -3-V Transition Region Under Full 2500-pF Load
- Inputs Compatible With Most TTL Families
- Common Strobe Input
- Inverting Output
- Slew Rate Can Be Controlled With an External Capacitor at the Output
- Standard Supply Voltages . . . $\pm 12\text{ V}$

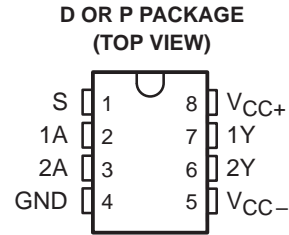

description

The SN75150 is a monolithic dual line driver designed to satisfy the requirements of the standard interface between data-terminal equipment and data-communication equipment as defined by TIA/EIA-232-F. A rate of 20 kbits/s can be transmitted with a full 2500-pF load. Other applications are in data-transmission systems using relatively short single lines, in level translators, and for driving MOS devices. The logic input is compatible with most TTL families. Operation is from 12-V and -12-V power supplies.

The SN75150 is characterized for operation from 0°C to 70°C .

logic symbol†

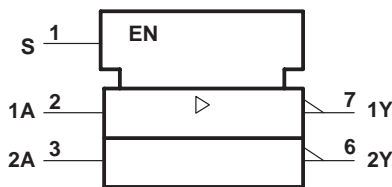

† This symbol is in accordance with ANSI/IEEE Std 91-1984 and IEC Publication 617-12.

logic diagram (positive logic)

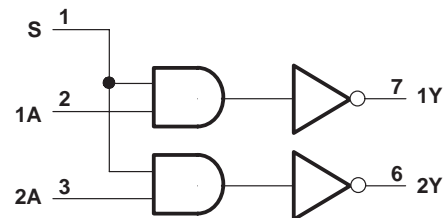

Please be aware that an important notice concerning availability, standard warranty, and use in critical applications of Texas Instruments semiconductor products and disclaimers thereto appears at the end of this data sheet.

SN75150 DUAL LINE DRIVER

SLLS081C – JANUARY 1971 – REVISED JUNE 1999

schematic (each line driver)

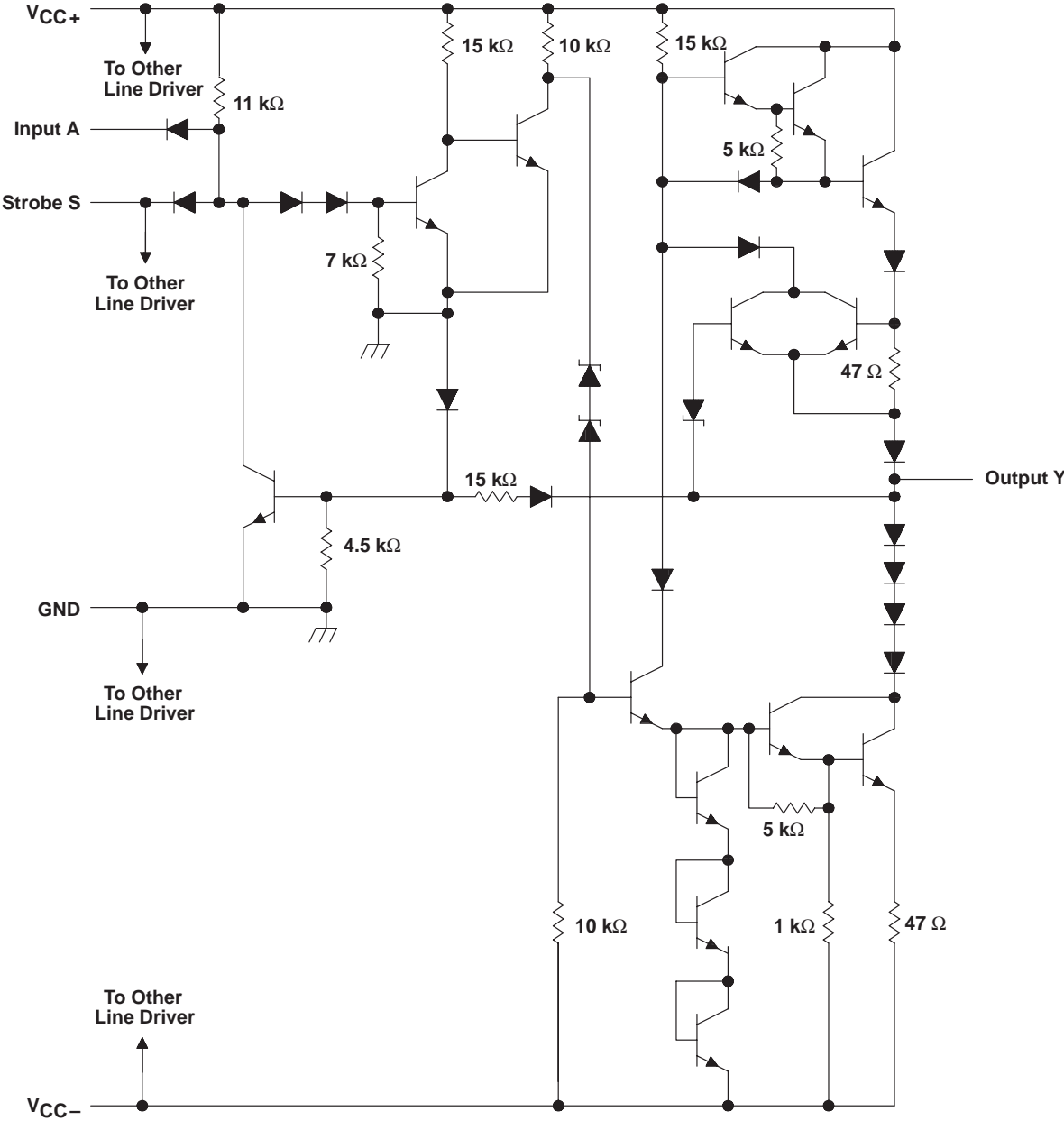

Resistor values shown are nominal.



absolute maximum ratings over operating free-air temperature range (unless otherwise noted)†

Supply voltage, V_{CC+} (see Note 1)	15 V
Supply voltage, V_{CC-}	–15 V
Input voltage, V_I	15 V
Applied output voltage	±25 V
Package thermal impedance, θ_{JA} (see Notes 2 and 3): D package	197°C/W
P package	104°C/W
Lead temperature 1,6 mm (1/16 inch) from case for 10 seconds	260°C
Storage temperature range, T_{Stg}	–65°C to 150°C

† Stresses beyond those listed under “absolute maximum ratings” may cause permanent damage to the device. These are stress ratings only, and functional operation of the device at these or any other conditions beyond those indicated under “recommended operating conditions” is not implied. Exposure to absolute-maximum-rated conditions for extended periods may affect device reliability.

- NOTES:
1. Voltage values are with respect to network ground terminal.
 2. Maximum power dissipation is a function of $T_J(\max)$, θ_{JA} , and T_A . The maximum allowable power dissipation at any allowable ambient temperature is $P_D = (T_J(\max) - T_A)/\theta_{JA}$. Operating at the absolute maximum T_J of 150°C can impact reliability.
 3. The package thermal impedance is calculated in accordance with JESD 51, except for through-hole packages, which use a trace length of zero.

recommended operating conditions

		MIN	NOM	MAX	UNIT
Supply voltage	V_{CC+}	10.8	12	13.2	V
	V_{CC-}	–10.8	–12	–13.2	
High-level input voltage, V_{IH}		2		5.5	V
Low-level input voltage, V_{IL}		0		0.8	V
Driver output voltage, V_O				±15	V
Operating free-air temperature, T_A		0		70	°C

SN75150 DUAL LINE DRIVER

SLLS081C – JANUARY 1971 – REVISED JUNE 1999

electrical characteristics over recommended operating free-air temperature range, $V_{CC\pm} = \pm 13.2$ V (unless otherwise noted)

PARAMETER		TEST CONDITIONS	MIN	TYP†	MAX	UNIT
V_{OH}	High-level output voltage	$V_{CC+} = 10.8$ V, $V_{IL} = 0.8$ V, $V_{CC-} = -10.8$ V, $R_L = 3$ k Ω to 7 k Ω	5	8		V
V_{OL}	Low-level output voltage (see Note 4)	$V_{CC+} = 10.8$ V, $V_{IH} = 2$ V, $V_{CC-} = -10.8$ V, $R_L = 3$ k Ω to 7 k Ω		-8	-5	V
I_{IH}	High-level input current	$V_I = 2.4$ V		1	10	μ A
	Data input			2	20	
I_{IL}	Low-level input current	$V_I = 0.4$ V		-1	-1.6	mA
	Strobe input			-2	-3.2	
I_{OS}	Short-circuit output current‡	$V_O = 25$ V		2	8	mA
		$V_O = -25$ V		-3	-8	
		$V_O = 0$, $V_I = 3$ V	10	15	30	
		$V_O = 0$, $V_I = 0$	-10	-15	-30	
I_{CCH+}	Supply current from V_{CC+} , high-level output	$V_I = 0$, $R_L = 3$ k Ω , $T_A = 25^\circ$ C		10	22	mA
I_{CCH-}	Supply current from V_{CC-} , high-level output			-1	-10	mA
I_{CCL+}	Supply current from V_{CC+} , low-level output	$V_I = 3$ V, $R_L = 3$ k Ω , $T_A = 25^\circ$ C		8	17	mA
I_{CCL-}	Supply current from V_{CC-} , low-level output			-9	-20	mA

† All typical values are at $V_{CC+} = 12$ V, $V_{CC-} = -12$ V, $T_A = 25^\circ$ C.

‡ Not more than one output should be shorted at a time.

NOTE 4: The algebraic convention, in which the less positive (more negative) limit is designated as minimum, is used in this data sheet for logic levels only, e.g., when -5 V is the maximum, the typical value is a more negative voltage.

switching characteristics, $V_{CC+} = 12$ V, $V_{CC-} = -12$ V, $T_A = 25^\circ$ C (see Figure 1)

PARAMETER		TEST CONDITIONS	MIN	TYP	MAX	UNIT
t_{TLH}	Transition time, low-to-high-level output	$C_L = 2500$ pF, $R_L = 3$ k Ω to 7 k Ω	0.2	1.4	2	μ s
t_{THL}	Transition time, high-to-low-level output		0.2	1.5	2	μ s
t_{TLH}	Transition time, low-to-high-level output	$C_L = 15$ pF, $R_L = 7$ k Ω		40		ns
t_{THL}	Transition time, high-to-low-level output			20		ns
t_{PLH}	Propagation delay time, low-to-high-level output	$C_L = 15$ pF, $R_L = 7$ k Ω		60		ns
t_{PHL}	Propagation delay time, high-to-low-level output			45		ns



PARAMETER MEASUREMENT INFORMATION

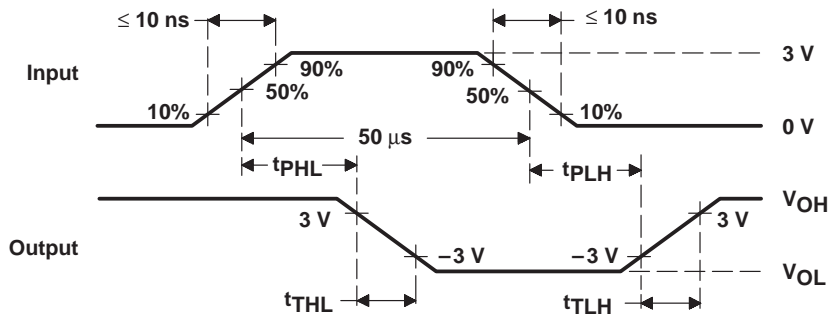
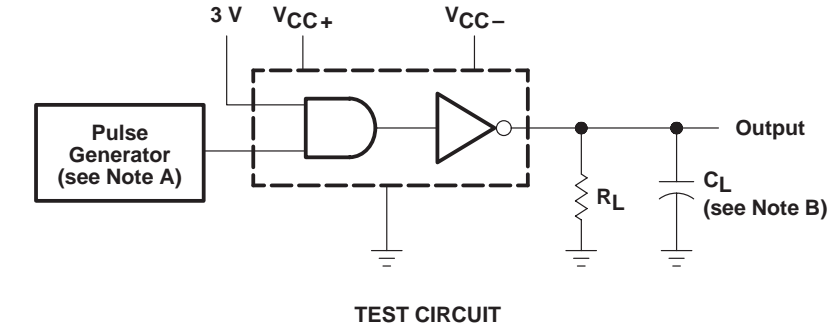

- NOTES: A. The pulse generator has the following characteristics: duty cycle ≤ 50%, $Z_O \approx 50 \Omega$.
B. C_L includes probe and jig capacitance.

Figure 1. Test Circuit and Voltage Waveforms

SN75150 DUAL LINE DRIVER

SLLS081C – JANUARY 1971 – REVISED JUNE 1999

TYPICAL CHARACTERISTICS

OUTPUT CURRENT
vs
APPLIED OUTPUT VOLTAGE

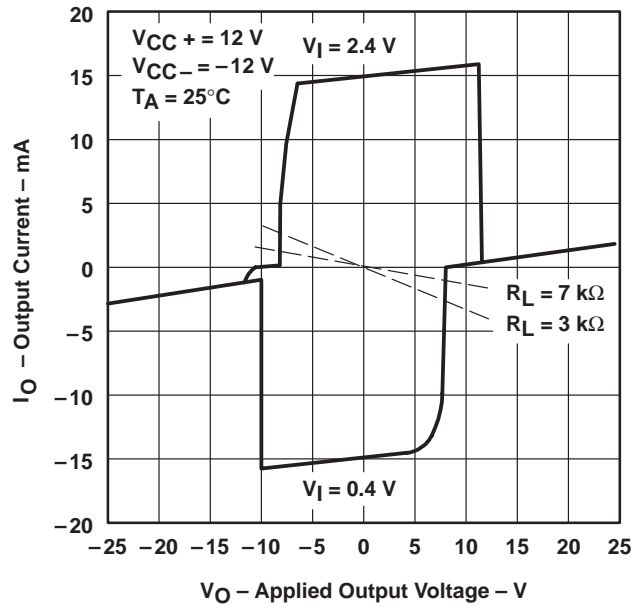

Figure 2

PACKAGING INFORMATION

Orderable Device	Status (1)	Package Type	Package Drawing	Pins	Package Qty	Eco Plan (2)	Lead finish/ Ball material (6)	MSL Peak Temp (3)	Op Temp (°C)	Device Marking (4/5)	Samples
SN75150D	ACTIVE	SOIC	D	8	75	RoHS & Green	NIPDAU	Level-1-260C-UNLIM	0 to 70	75150	Samples
SN75150DR	ACTIVE	SOIC	D	8	2500	RoHS & Green	NIPDAU	Level-1-260C-UNLIM	0 to 70	75150	Samples
SN75150P	ACTIVE	PDIP	P	8	50	RoHS & Green	NIPDAU	N / A for Pkg Type	0 to 70	SN75150P	Samples

(1) The marketing status values are defined as follows:

ACTIVE: Product device recommended for new designs.

LIFEBUY: TI has announced that the device will be discontinued, and a lifetime-buy period is in effect.

NRND: Not recommended for new designs. Device is in production to support existing customers, but TI does not recommend using this part in a new design.

PREVIEW: Device has been announced but is not in production. Samples may or may not be available.

OBSOLETE: TI has discontinued the production of the device.

(2) **RoHS:** TI defines "RoHS" to mean semiconductor products that are compliant with the current EU RoHS requirements for all 10 RoHS substances, including the requirement that RoHS substance do not exceed 0.1% by weight in homogeneous materials. Where designed to be soldered at high temperatures, "RoHS" products are suitable for use in specified lead-free processes. TI may reference these types of products as "Pb-Free".

RoHS Exempt: TI defines "RoHS Exempt" to mean products that contain lead but are compliant with EU RoHS pursuant to a specific EU RoHS exemption.

Green: TI defines "Green" to mean the content of Chlorine (Cl) and Bromine (Br) based flame retardants meet JS709B low halogen requirements of <=1000ppm threshold. Antimony trioxide based flame retardants must also meet the <=1000ppm threshold requirement.

(3) MSL, Peak Temp. - The Moisture Sensitivity Level rating according to the JEDEC industry standard classifications, and peak solder temperature.

(4) There may be additional marking, which relates to the logo, the lot trace code information, or the environmental category on the device.

(5) Multiple Device Markings will be inside parentheses. Only one Device Marking contained in parentheses and separated by a "~" will appear on a device. If a line is indented then it is a continuation of the previous line and the two combined represent the entire Device Marking for that device.

(6) Lead finish/Ball material - Orderable Devices may have multiple material finish options. Finish options are separated by a vertical ruled line. Lead finish/Ball material values may wrap to two lines if the finish value exceeds the maximum column width.

Important Information and Disclaimer:The information provided on this page represents TI's knowledge and belief as of the date that it is provided. TI bases its knowledge and belief on information provided by third parties, and makes no representation or warranty as to the accuracy of such information. Efforts are underway to better integrate information from third parties. TI has taken and continues to take reasonable steps to provide representative and accurate information but may not have conducted destructive testing or chemical analysis on incoming materials and chemicals. TI and TI suppliers consider certain information to be proprietary, and thus CAS numbers and other limited information may not be available for release.

In no event shall TI's liability arising out of such information exceed the total purchase price of the TI part(s) at issue in this document sold by TI to Customer on an annual basis.

TAPE AND REEL INFORMATION

QUADRANT ASSIGNMENTS FOR PIN 1 ORIENTATION IN TAPE

*All dimensions are nominal

Device	Package Type	Package Drawing	Pins	SPQ	Reel Diameter (mm)	Reel Width W1 (mm)	A0 (mm)	B0 (mm)	K0 (mm)	P1 (mm)	W (mm)	Pin1 Quadrant
SN75150DR	SOIC	D	8	2500	330.0	12.4	6.4	5.2	2.1	8.0	12.0	Q1

TAPE AND REEL BOX DIMENSIONS

*All dimensions are nominal

Device	Package Type	Package Drawing	Pins	SPQ	Length (mm)	Width (mm)	Height (mm)
SN75150DR	SOIC	D	8	2500	340.5	336.1	25.0

TUBE

*All dimensions are nominal

Device	Package Name	Package Type	Pins	SPQ	L (mm)	W (mm)	T (μm)	B (mm)
SN75150D	D	SOIC	8	75	507	8	3940	4.32
SN75150P	P	PDIP	8	50	506	13.97	11230	4.32

P (R-PDIP-T8)

PLASTIC DUAL-IN-LINE PACKAGE



- NOTES:
- A. All linear dimensions are in inches (millimeters).
 - B. This drawing is subject to change without notice.
 - C. Falls within JEDEC MS-001 variation BA.



D0008A

PACKAGE OUTLINE

SOIC - 1.75 mm max height

SMALL OUTLINE INTEGRATED CIRCUIT



4214825/C 02/2019

NOTES:

- Linear dimensions are in inches [millimeters]. Dimensions in parenthesis are for reference only. Controlling dimensions are in inches. Dimensioning and tolerancing per ASME Y14.5M.
- This drawing is subject to change without notice.
- This dimension does not include mold flash, protrusions, or gate burrs. Mold flash, protrusions, or gate burrs shall not exceed $.006$ [0.15] per side.
- This dimension does not include interlead flash.
- Reference JEDEC registration MS-012, variation AA.

EXAMPLE BOARD LAYOUT

D0008A

SOIC - 1.75 mm max height

SMALL OUTLINE INTEGRATED CIRCUIT



LAND PATTERN EXAMPLE
 EXPOSED METAL SHOWN
 SCALE:8X



SOLDER MASK DETAILS

4214825/C 02/2019

NOTES: (continued)

- 6. Publication IPC-7351 may have alternate designs.
- 7. Solder mask tolerances between and around signal pads can vary based on board fabrication site.

EXAMPLE STENCIL DESIGN

D0008A

SOIC - 1.75 mm max height

SMALL OUTLINE INTEGRATED CIRCUIT



SOLDER PASTE EXAMPLE
BASED ON .005 INCH [0.125 MM] THICK STENCIL
SCALE:8X

4214825/C 02/2019

NOTES: (continued)

8. Laser cutting apertures with trapezoidal walls and rounded corners may offer better paste release. IPC-7525 may have alternate design recommendations.
9. Board assembly site may have different recommendations for stencil design.

IMPORTANT NOTICE AND DISCLAIMER

TI PROVIDES TECHNICAL AND RELIABILITY DATA (INCLUDING DATA SHEETS), DESIGN RESOURCES (INCLUDING REFERENCE DESIGNS), APPLICATION OR OTHER DESIGN ADVICE, WEB TOOLS, SAFETY INFORMATION, AND OTHER RESOURCES "AS IS" AND WITH ALL FAULTS, AND DISCLAIMS ALL WARRANTIES, EXPRESS AND IMPLIED, INCLUDING WITHOUT LIMITATION ANY IMPLIED WARRANTIES OF MERCHANTABILITY, FITNESS FOR A PARTICULAR PURPOSE OR NON-INFRINGEMENT OF THIRD PARTY INTELLECTUAL PROPERTY RIGHTS.

These resources are intended for skilled developers designing with TI products. You are solely responsible for (1) selecting the appropriate TI products for your application, (2) designing, validating and testing your application, and (3) ensuring your application meets applicable standards, and any other safety, security, regulatory or other requirements.

These resources are subject to change without notice. TI grants you permission to use these resources only for development of an application that uses the TI products described in the resource. Other reproduction and display of these resources is prohibited. No license is granted to any other TI intellectual property right or to any third party intellectual property right. TI disclaims responsibility for, and you will fully indemnify TI and its representatives against, any claims, damages, costs, losses, and liabilities arising out of your use of these resources.

TI's products are provided subject to [TI's Terms of Sale](#) or other applicable terms available either on [ti.com](https://www.ti.com) or provided in conjunction with such TI products. TI's provision of these resources does not expand or otherwise alter TI's applicable warranties or warranty disclaimers for TI products.

TI objects to and rejects any additional or different terms you may have proposed.

Mailing Address: Texas Instruments, Post Office Box 655303, Dallas, Texas 75265
Copyright © 2024, Texas Instruments Incorporated