

TLV1391 SINGLE DIFFERENTIAL COMPARATORS

SLCS128F – APRIL 1996 – REVISED JUNE 2007

- **Low-Voltage and Single-Supply Operation**
 $V_{CC} = 2\text{ V to }7\text{ V}$
- **Common-Mode Voltage Range Includes Ground**
- **Fast Response Time . . . 0.7 μs Typ**
- **Low Supply Current . . . 80 μA Typ and 150 μA Max**
- **Fully Specified at 3-V and 5-V Supply Voltages**

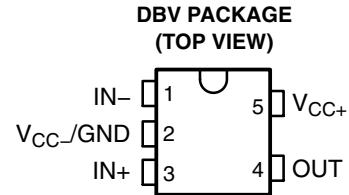

description/ordering informaton

The TLV1391 is a differential comparator built using a Texas Instruments low-voltage, high-speed bipolar process. These devices have been developed specifically for low-voltage, single-supply applications. Their enhanced performance makes them excellent replacements for the LM393 in the improved 3-V and 5-V system designs.

The TLV1391, with its typical supply current of only 80 μA , is ideal for low-power systems. Response time also has been improved to 0.7 μs .

ORDERING INFORMATION

T_A	PACKAGE†		ORDERABLE PART NUMBER	TOP-SIDE MARKING‡
-0°C to 70°C	SOT-23-5 (DBV)	Reel of 3000	TLV1391CDBVR	Y3D_
		Reel of 250	TLV1391CDBVT	
-40°C to 85°C	SOT-23-5 (DBV)	Reel of 3000	TLV1391IDBVR	Y3E_
		Reel of 250	TLV1391IDBVT	

† Package drawings, standard packing quantities, thermal data, symbolization, and PCB design guidelines are available at www.ti.com/sc/package.

‡ The actual top-side marking has one additional character that designates the wafer fab/assembly site.

symbol (each comparator)

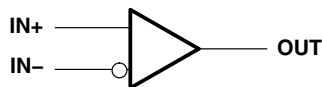

Please be aware that an important notice concerning availability, standard warranty, and use in critical applications of Texas Instruments semiconductor products and disclaimers thereto appears at the end of this data sheet.

PRODUCTION DATA information is current as of publication date. Products conform to specifications per the terms of Texas Instruments standard warranty. Production processing does not necessarily include testing of all parameters.

 **TEXAS
INSTRUMENTS**

POST OFFICE BOX 655303 • DALLAS, TEXAS 75265

Copyright © 2007, Texas Instruments Incorporated

TLV1391 SINGLE DIFFERENTIAL COMPARATORS

SLCS128F – APRIL 1996 – REVISED JUNE 2007

equivalent schematic

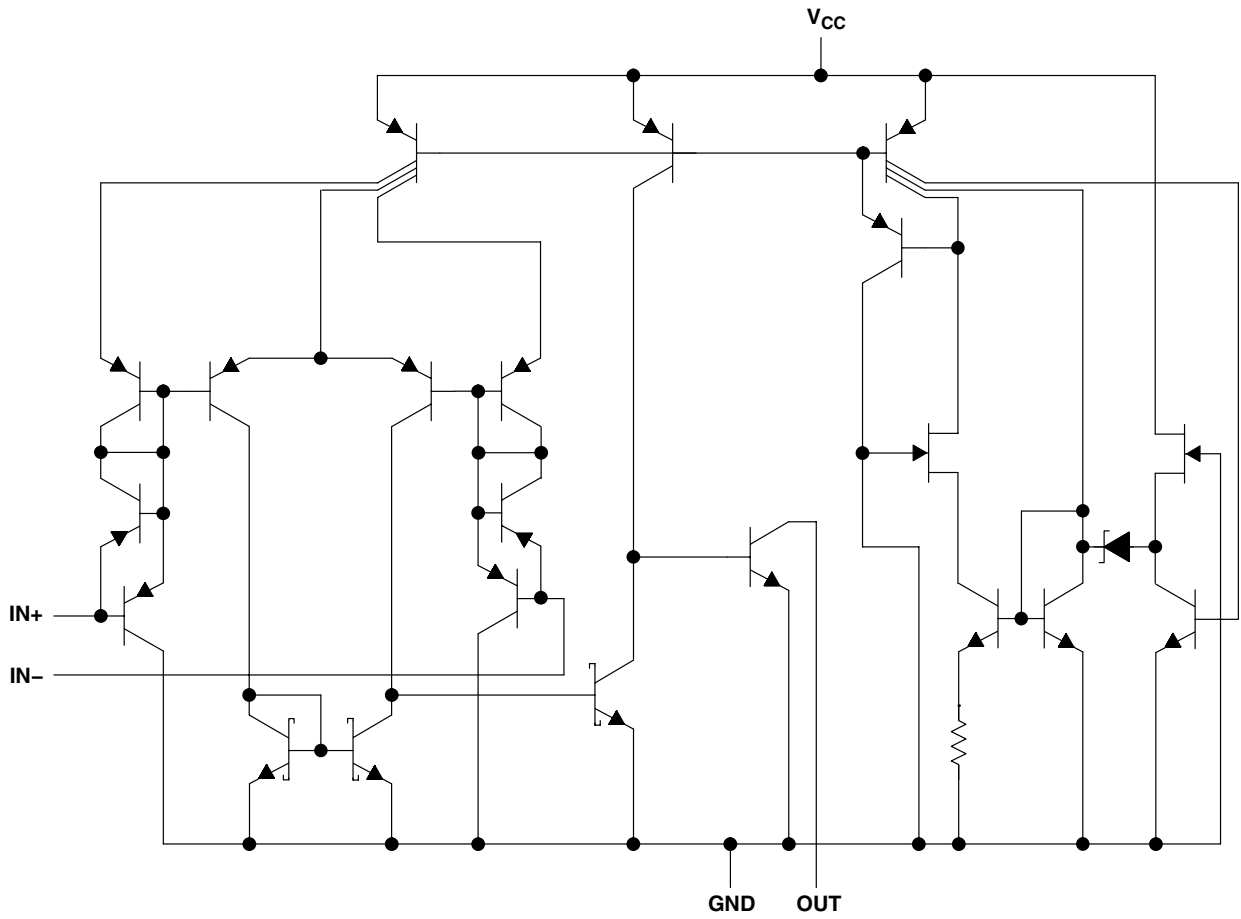

COMPONENT COUNT	
Transistors	26
Resistors	1
Diodes	4
Epi-FET	1

TLV1391 SINGLE DIFFERENTIAL COMPARATORS

SLCS128F – APRIL 1996 – REVISED JUNE 2007

absolute maximum ratings over operating free-air temperature range (unless otherwise noted)†

Supply voltage, V_{CC} (see Note 1)	7 V
Differential input voltage, V_{ID} (see Note 2)	± 7 V
Input voltage range, V_I (any input)	–0.3 V to V_{CC}
Output voltage, V_O	7 V
Output current, I_O (each output)	20 mA
Duration of short-circuit current to GND (see Note 3)	Unlimited
Package thermal impedance, θ_{JA} (see Note 4 and 5)	206°C/W
Operating virtual junction temperature, T_J	150°C
Lead temperature 1,6 mm (1/16 inch) from case for 10 seconds	260°C
Storage temperature range, T_{stg}	–65°C to 150°C

† Stresses beyond those listed under “absolute maximum ratings” may cause permanent damage to the device. These are stress ratings only, and functional operation of the device at these or any other conditions beyond those indicated under “recommended operating conditions” is not implied. Exposure to absolute-maximum-rated conditions for extended periods may affect device reliability.

- NOTES:
1. All voltage values, except differential voltages, are with respect to the network GND.
 2. Differential voltages are at the noninverting input with respect to the inverting input.
 3. Short circuits from the outputs to V_{CC} can cause excessive heating and eventual destruction of the chip.
 4. Maximum power dissipation is a function of $T_J(\text{max})$, θ_{JA} , and T_A . The maximum allowable power dissipation at any allowable ambient temperature is $P_D = (T_J(\text{max}) - T_A)/\theta_{JA}$. Operating at the absolute maximum T_J of 150°C can impact reliability.
 5. The package thermal impedance is calculated in accordance with JESD 51-7.

recommended operating conditions

		MIN	MAX	UNIT
V_{CC}	Supply voltage	2	7	V
T_A	Operating free-air temperature	TLV1391C	0	70
		TLV1391I	–40	85



TLV1391

SINGLE DIFFERENTIAL COMPARATORS

SLCS128F – APRIL 1996 – REVISED JUNE 2007

electrical characteristics, $V_{CC} = 3\text{ V}$

PARAMETER	TEST CONDITIONS	T_A	MIN	TYP	MAX	UNIT
V_{IO} Input offset voltage	$V_O = 1.4\text{ V}$, $V_{IC} = V_{ICR}(\text{min})$	25°C		1.5	5	mV
		Full range			9	
V_{ICR} Common-mode input voltage range		25°C	0 to $V_{CC}-1.5$	0 to $V_{CC}-1.2$		V
		Full range	0 to $V_{CC}-2$			
V_{OL} Low-level output voltage	$V_{ID} = -1\text{ V}$, $I_{OL} = 500\text{ }\mu\text{A}$	Full range		120	300	mV
I_{IO} Input offset current	$V_O = 1.4\text{ V}$	25°C		5	50	nA
		Full range			150	
I_{IB} Input bias current	$V_O = 1.4\text{ V}$	25°C		-40	-250	nA
		Full range			-400	
I_{OH} High-level output current	$V_{ID} = 1\text{ V}$, $V_{OH} = 3\text{ V}$	25°C		0.1		nA
	$V_{ID} = 1\text{ V}$, $V_{OH} = 5\text{ V}$	Full range			100	
I_{OL} Low-level output current	$V_{ID} = -1\text{ V}$, $V_{OL} = 1.5\text{ V}$	25°C	500			μA
$I_{CC(H)}$ High-level supply current	$V_O = V_{OH}$	25°C		80	125	μA
		Full range			150	
$I_{CC(L)}$ Low-level supply current	$V_O = V_{OL}$	25°C		80	125	μA
		Full range			150	

switching characteristics, $V_{CC} = 3\text{ V}$, $C_L = 15\text{ pF}^\dagger$, $T_A = 25^\circ\text{C}$

PARAMETER	TEST CONDITIONS	TYP	UNIT
Response time	100-mV input step with 5-mV overdrive, $R_L = 5.1\text{ k}\Omega$	0.7	μs

[†] C_L includes the probe and jig capacitance.



TLV1391 SINGLE DIFFERENTIAL COMPARATORS

SLCS128F – APRIL 1996 – REVISED JUNE 2007

electrical characteristics, $V_{CC} = 5\text{ V}$

PARAMETER		TEST CONDITIONS	T_A	MIN	TYP	MAX	UNIT
V_{IO}	Input offset voltage	$V_O = 1.4\text{ V}, V_{IC} = V_{ICR}(\text{min})$	25°C		1.5	5	mV
			Full range			9	
V_{ICR}	Common-mode input voltage range		25°C	0 to $V_{CC}-1.5$	0 to $V_{CC}-1.2$		V
			Full range	0 to $V_{CC}-2$			
V_{OL}	Low-level output voltage	$V_{ID} = -1\text{ V}, I_{OL} = 500\ \mu\text{A}$	Full range		120	300	mV
I_{IO}	Input offset current	$V_O = 1.4\text{ V}$	25°C		5	50	nA
			Full range			150	
I_{IB}	Input bias current	$V_O = 1.4\text{ V}$	25°C		-40	-250	nA
			Full range			-400	
I_{OH}	High-level output current	$V_{ID} = 1\text{ V}, V_{OH} = 3\text{ V}$	25°C		0.1		nA
		$V_{ID} = 1\text{ V}, V_{OH} = 5\text{ V}$	Full range			100	
I_{OL}	Low-level output current	$V_{ID} = -1\text{ V}, V_{OL} = 1.5\text{ V}$	25°C	600			μA
$I_{CC(H)}$	High-level supply current	$V_O = V_{OH}$	25°C		100	150	μA
			Full range			175	
$I_{CC(L)}$	Low-level supply current	$V_O = V_{OL}$	25°C		100	150	μA
			Full range			175	

switching characteristics, $V_{CC} = 5\text{ V}, C_L = 15\text{ pF}^\dagger, T_A = 25^\circ\text{C}$

PARAMETER	TEST CONDITIONS	TYP	UNIT
Response time	100-mV input step with 5-mV overdrive, $R_L = 5.1\text{ k}\Omega$	0.65	μs
	TTL-level input step, $R_L = 5.1\text{ k}\Omega$	0.18	

[†] C_L includes the probe and jig capacitance.



TLV1391 SINGLE DIFFERENTIAL COMPARATORS

SLCS128F – APRIL 1996 – REVISED JUNE 2007

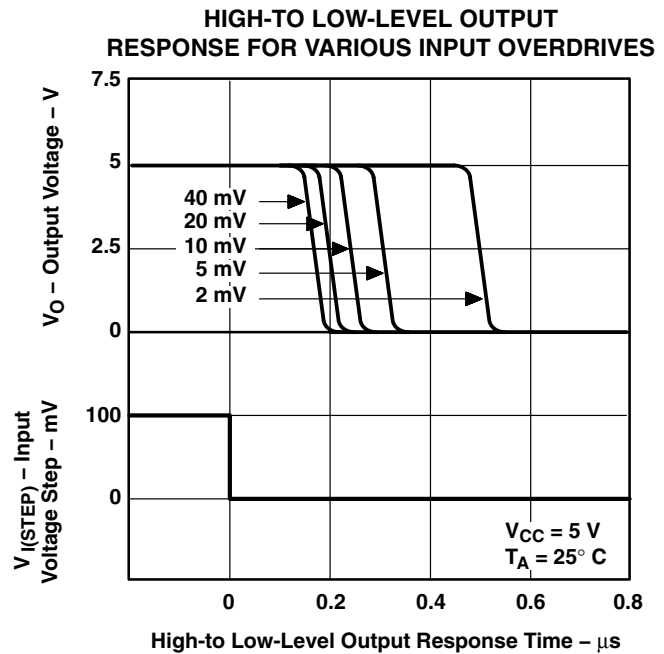
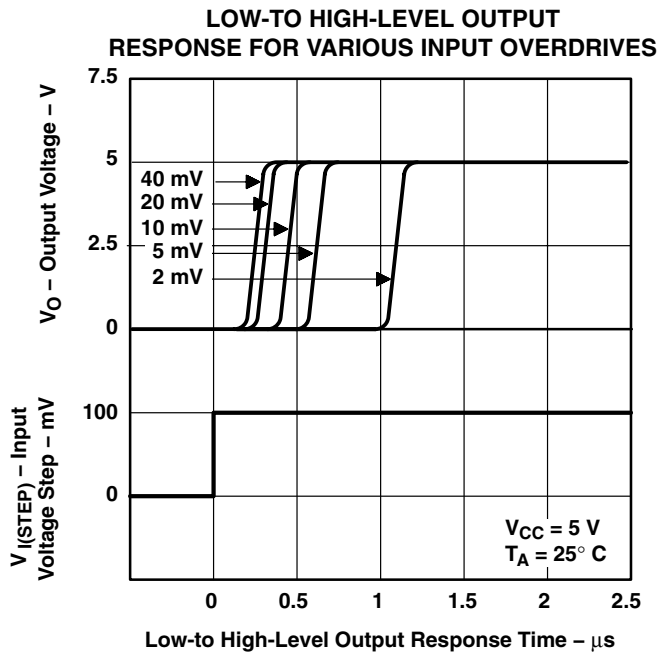
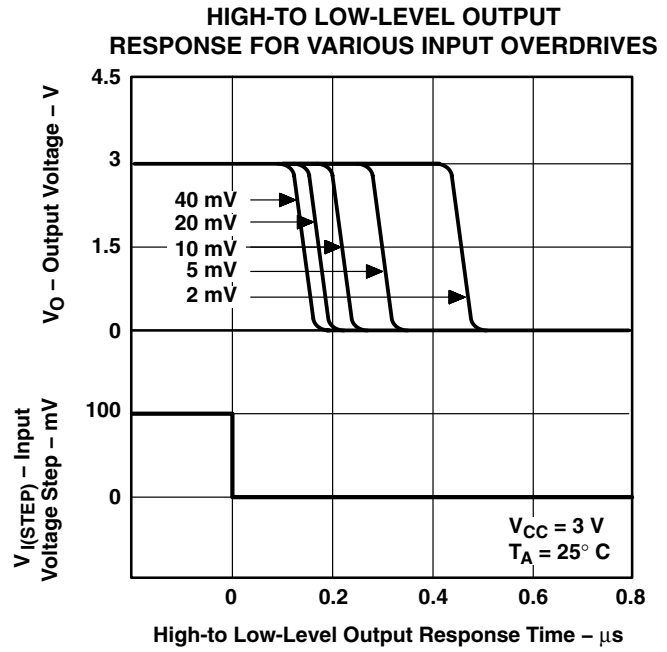
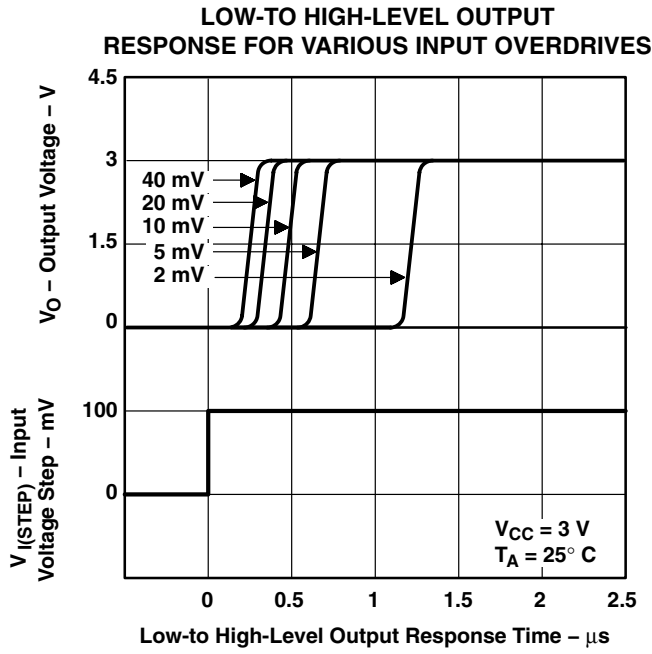
TYPICAL CHARACTERISTICS



PACKAGING INFORMATION

Orderable Device	Status (1)	Package Type	Package Drawing	Pins	Package Qty	Eco Plan (2)	Lead finish/ Ball material (6)	MSL Peak Temp (3)	Op Temp (°C)	Device Marking (4/5)	Samples
TLV1391CDBVR	ACTIVE	SOT-23	DBV	5	3000	RoHS & Green	NIPDAU SN	Level-1-260C-UNLIM	0 to 70	(1391, Y3D6, Y3DG, Y3DJ)	
TLV1391CDBVRG4	OBSOLETE	SOT-23	DBV	5		TBD	Call TI	Call TI	0 to 70	Y3DG	
TLV1391IDBVR	ACTIVE	SOT-23	DBV	5	3000	RoHS & Green	NIPDAU SN	Level-1-260C-UNLIM	-40 to 85	(1391, Y3E6, Y3EB, Y3EJ)	

(1) The marketing status values are defined as follows:

ACTIVE: Product device recommended for new designs.

LIFEBUY: TI has announced that the device will be discontinued, and a lifetime-buy period is in effect.

NRND: Not recommended for new designs. Device is in production to support existing customers, but TI does not recommend using this part in a new design.

PREVIEW: Device has been announced but is not in production. Samples may or may not be available.

OBSOLETE: TI has discontinued the production of the device.

(2) **RoHS:** TI defines "RoHS" to mean semiconductor products that are compliant with the current EU RoHS requirements for all 10 RoHS substances, including the requirement that RoHS substance do not exceed 0.1% by weight in homogeneous materials. Where designed to be soldered at high temperatures, "RoHS" products are suitable for use in specified lead-free processes. TI may reference these types of products as "Pb-Free".

RoHS Exempt: TI defines "RoHS Exempt" to mean products that contain lead but are compliant with EU RoHS pursuant to a specific EU RoHS exemption.

Green: TI defines "Green" to mean the content of Chlorine (Cl) and Bromine (Br) based flame retardants meet JS709B low halogen requirements of <=1000ppm threshold. Antimony trioxide based flame retardants must also meet the <=1000ppm threshold requirement.

(3) MSL, Peak Temp. - The Moisture Sensitivity Level rating according to the JEDEC industry standard classifications, and peak solder temperature.

(4) There may be additional marking, which relates to the logo, the lot trace code information, or the environmental category on the device.

(5) Multiple Device Markings will be inside parentheses. Only one Device Marking contained in parentheses and separated by a "-" will appear on a device. If a line is indented then it is a continuation of the previous line and the two combined represent the entire Device Marking for that device.

(6) Lead finish/Ball material - Orderable Devices may have multiple material finish options. Finish options are separated by a vertical ruled line. Lead finish/Ball material values may wrap to two lines if the finish value exceeds the maximum column width.

Important Information and Disclaimer:The information provided on this page represents TI's knowledge and belief as of the date that it is provided. TI bases its knowledge and belief on information provided by third parties, and makes no representation or warranty as to the accuracy of such information. Efforts are underway to better integrate information from third parties. TI has taken and continues to take reasonable steps to provide representative and accurate information but may not have conducted destructive testing or chemical analysis on incoming materials and chemicals. TI and TI suppliers consider certain information to be proprietary, and thus CAS numbers and other limited information may not be available for release.

In no event shall TI's liability arising out of such information exceed the total purchase price of the TI part(s) at issue in this document sold by TI to Customer on an annual basis.

TAPE AND REEL INFORMATION

QUADRANT ASSIGNMENTS FOR PIN 1 ORIENTATION IN TAPE

*All dimensions are nominal

Device	Package Type	Package Drawing	Pins	SPQ	Reel Diameter (mm)	Reel Width W1 (mm)	A0 (mm)	B0 (mm)	K0 (mm)	P1 (mm)	W (mm)	Pin1 Quadrant
TLV1391CDBVR	SOT-23	DBV	5	3000	178.0	9.0	3.3	3.2	1.4	4.0	8.0	Q3
TLV1391IDBVR	SOT-23	DBV	5	3000	178.0	9.0	3.3	3.2	1.4	4.0	8.0	Q3

TAPE AND REEL BOX DIMENSIONS

*All dimensions are nominal

Device	Package Type	Package Drawing	Pins	SPQ	Length (mm)	Width (mm)	Height (mm)
TLV1391CDBVR	SOT-23	DBV	5	3000	180.0	180.0	18.0
TLV1391IDBVR	SOT-23	DBV	5	3000	180.0	180.0	18.0

EXAMPLE BOARD LAYOUT

DBV0005A

SOT-23 - 1.45 mm max height

SMALL OUTLINE TRANSISTOR



LAND PATTERN EXAMPLE
EXPOSED METAL SHOWN
SCALE:15X

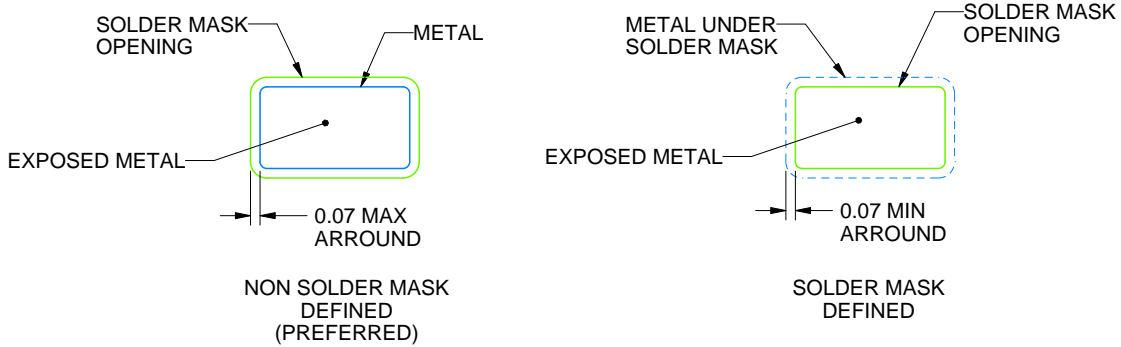

SOLDER MASK DETAILS

4214839/K 08/2024

NOTES: (continued)

- 6. Publication IPC-7351 may have alternate designs.
- 7. Solder mask tolerances between and around signal pads can vary based on board fabrication site.

EXAMPLE STENCIL DESIGN

DBV0005A

SOT-23 - 1.45 mm max height

SMALL OUTLINE TRANSISTOR



SOLDER PASTE EXAMPLE
BASED ON 0.125 mm THICK STENCIL
SCALE:15X

4214839/K 08/2024

NOTES: (continued)

8. Laser cutting apertures with trapezoidal walls and rounded corners may offer better paste release. IPC-7525 may have alternate design recommendations.
9. Board assembly site may have different recommendations for stencil design.

IMPORTANT NOTICE AND DISCLAIMER

TI PROVIDES TECHNICAL AND RELIABILITY DATA (INCLUDING DATA SHEETS), DESIGN RESOURCES (INCLUDING REFERENCE DESIGNS), APPLICATION OR OTHER DESIGN ADVICE, WEB TOOLS, SAFETY INFORMATION, AND OTHER RESOURCES "AS IS" AND WITH ALL FAULTS, AND DISCLAIMS ALL WARRANTIES, EXPRESS AND IMPLIED, INCLUDING WITHOUT LIMITATION ANY IMPLIED WARRANTIES OF MERCHANTABILITY, FITNESS FOR A PARTICULAR PURPOSE OR NON-INFRINGEMENT OF THIRD PARTY INTELLECTUAL PROPERTY RIGHTS.

These resources are intended for skilled developers designing with TI products. You are solely responsible for (1) selecting the appropriate TI products for your application, (2) designing, validating and testing your application, and (3) ensuring your application meets applicable standards, and any other safety, security, regulatory or other requirements.

These resources are subject to change without notice. TI grants you permission to use these resources only for development of an application that uses the TI products described in the resource. Other reproduction and display of these resources is prohibited. No license is granted to any other TI intellectual property right or to any third party intellectual property right. TI disclaims responsibility for, and you will fully indemnify TI and its representatives against, any claims, damages, costs, losses, and liabilities arising out of your use of these resources.

TI's products are provided subject to [TI's Terms of Sale](#) or other applicable terms available either on [ti.com](https://www.ti.com) or provided in conjunction with such TI products. TI's provision of these resources does not expand or otherwise alter TI's applicable warranties or warranty disclaimers for TI products.

TI objects to and rejects any additional or different terms you may have proposed.

Mailing Address: Texas Instruments, Post Office Box 655303, Dallas, Texas 75265
Copyright © 2024, Texas Instruments Incorporated