

LP50xx 18/24 チャンネル、12 ビット、PWM 超低静止電流、I²C RGB LED ドライバ

1 特長

- 動作電圧範囲:
 - V_{CC} 範囲: 2.7V~5.5V
 - EN、SDA、SCL ピンは 1.8V、3.3V、5V の電源レールに対応
 - 最大出力電圧: 6V
- 24 個の高精度定電流シンク
 - V_{CC} の全範囲で、チャンネルごとに最大 25.5mA
 - $V_{CC} \geq 3.3V$ のとき、チャンネルごとに最大 35mA
 - デバイス間誤差: $\pm 7\%$ 、チャンネル間誤差: $\pm 7\%$
- 非常に低い静止電流
 - シャットダウンモード: EN Low で最大値 1 μ A
 - パワーセーブモード: EN High、すべての LED が 30ms を超えてオフのとき標準値 10 μ A
- 各チャンネルに 12 ビット、29kHz の PWM ジェネレータを内蔵:
 - チャンネルごとに独立の色混合レジスタ
 - RGB LED モジュールごとに独立の輝度制御レジスタ
 - 対数的または線形的スケールの輝度制御を選択可能
 - 3 相 PWM シフト方式を搭載
- 3 つのプログラム可能バンク (R、G、B) により、各色をソフトウェアで簡単に制御
- 2 つの外部ハードウェアアドレスピンにより、最大 4 つのデバイスに接続可能
- ブロードキャストスレーブアドレスにより、複数のデバイスを同時に構成可能
- 自動インクリメント機能により、1 回の伝送で連続する複数のレジスタを書き込み / 読み取り可能
- 最大 400kHz のファストモード I²C 速度

2 アプリケーション

次のような機器の LED ライティング、インジケータライト、および装飾用ライト

- スマートスピーカ (音声アシスタント付き)
- スマートホーム家電
- ビデオドアベル
- 電子スマートロック
- 煙感知器と熱感知器
- STB および DVR
- スマートルータ
- ハンドヘルドデバイス

3 概要

スマートホームや、ヒューマンマシンインターフェイスを活用する他のアプリケーションでは、高性能の RGB LED ドライバが必要となります。フラッシュ、ブリージング、追跡などの LED アニメーション効果により、ユーザー向けの環境を大幅に改良できます。またシステムノイズが最小限であることは不可欠です。

LP50xx デバイスは、18 または 24 チャンネルの定電流シンク LED ドライバです。LP50xx デバイスにはカラーミキシングおよび輝度制御機能が内蔵されており、事前設定によりソフトウェアのコーディング処理を簡素化できます。12 ビット、29kHz の PWM ジェネレータが各チャンネルに内蔵されているため、LED で円滑に、鮮やかな色を再現でき、可聴ノイズが除去されます。

製品情報 (1)

部品番号	パッケージ	本体サイズ (公称)
LP5024	VQFN (32)	4.00mm × 4.00mm
LP5018	VQFN (32)	4.00mm × 4.00mm
	VSSOP (28)	7.30mm × 3.00mm

- (1) 利用可能なすべてのパッケージについては、データシートの末尾にある注文情報を参照してください。

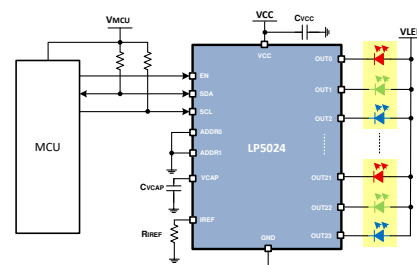

概略回路図



Table of Contents

1 特長	1	7.5 Programming.....	19
2 アプリケーション	1	7.6 Register Maps.....	23
3 概要	1	8 Application and Implementation	40
4 概要 (続き)	3	8.1 Application Information.....	40
5 Pin Configuration and Functions	4	8.2 Typical Application.....	40
6 Specifications	7	8.3 Power Supply Recommendations.....	42
6.1 Absolute Maximum Ratings.....	7	8.4 Layout.....	42
6.2 ESD Ratings.....	7	9 Device and Documentation Support	46
6.3 Recommended Operating Conditions.....	7	9.1 Related Links.....	46
6.4 Thermal Information.....	7	9.2 ドキュメントの更新通知を受け取る方法.....	46
6.5 Electrical Characteristics.....	8	9.3 サポート・リソース.....	46
6.6 Timing Requirements.....	9	9.4 Trademarks.....	46
6.7 Typical Characteristics.....	10	9.5 静電気放電に関する注意事項.....	46
7 Detailed Description	12	9.6 用語集.....	46
7.1 Overview.....	12	10 Revision History	47
7.2 Functional Block Diagram.....	12	11 Mechanical, Packaging, and Orderable Information	48
7.3 Feature Description.....	13		
7.4 Device Functional Modes.....	18		

4 概要 (続き)

LP50xx デバイスは、29kHz のスイッチング周波数、12 ビットの PWM 分解能で各 LED の出力を制御するので、スムーズな調光効果を達成でき、可聴周波数のノイズが排除されます。カラー ミキシングと輝度の制御レジスタを別々に制御できるため、ソフトウェアのコーディングが明快になります。フェードイン、フェードアウト型のブリージング効果を行う際、グローバルな R、G、B バンクの制御により、マイクロコントローラの負荷が大幅に減少します。また、LP50xx デバイスには PWM 位相シフト機能も実装されており、LED が同時にオンになるときの入力電力バジェットを低減するために役立ちます。

LP50xx デバイスには、自動パワーセービング モードが実装されており、非常に低い静止電流を実現しています。すべてのチャンネルが 30ms の間オフのとき、デバイスの合計消費電力は 10 μ A まで低下するため、LP50xx デバイスはバッテリー駆動の最終製品に適しています。

5 Pin Configuration and Functions



図 5-1. LP5018 RSM Package 32-Pin VQFN With Exposed Thermal Pad Top View



図 5-2. LP5024 RSM Package 32-Pin VQFN With Exposed Thermal Pad Top View

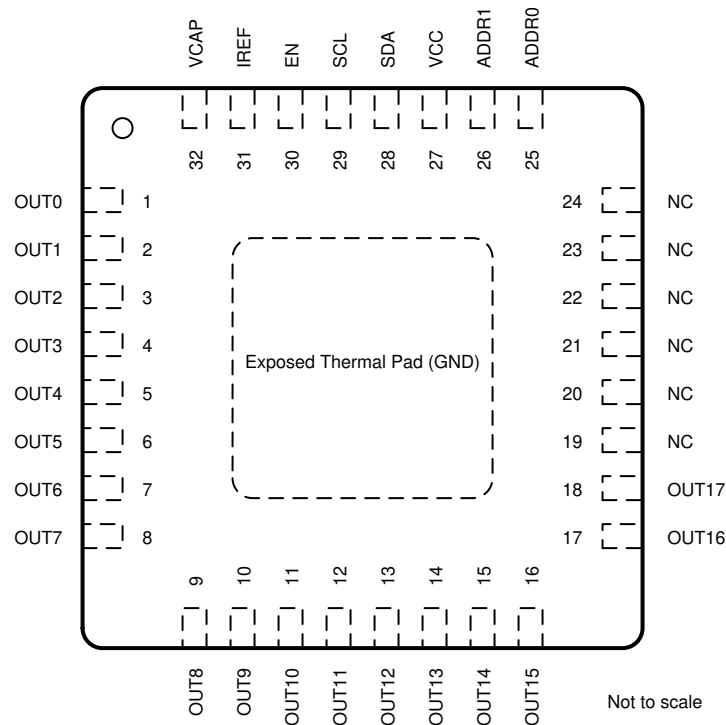

図 5-3. LP5018 DGS Package 28-pin VSSOP Top View

表 5-1. Pin Functions

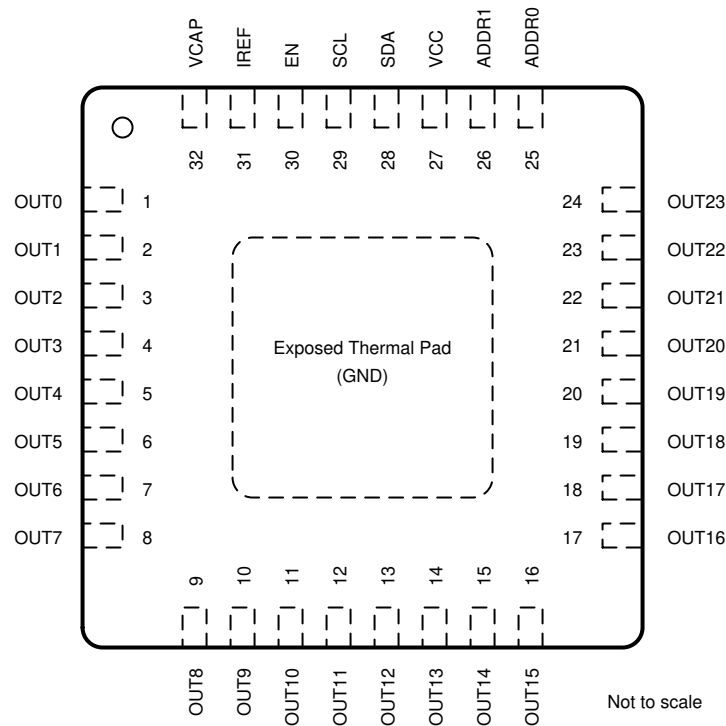
NAME	PIN			I/O	DESCRIPTION
	NO.				
	LP5018RSM	LP5024RSM	LP5018DGS		
ADDR0	25	25	11	—	I ² C slave-address selection pin. This pin must not be left floating.
ADDR1	26	26	12	—	I ² C slave-address selection pin. This pin must not be left floating.
EN	30	30	16	I	Chip enable input pin
IREF	31	31	17	—	Output current-reference global-setting pin
NC	19, 20, 21, 22, 23, 24	—	—	—	No internal connection
OUT0	1	1	19	O	Current sink output 0. If not used, this pin can be left floating.
OUT1	2	2	20	O	Current sink output 1. If not used, this pin can be left floating.
OUT2	3	3	21	O	Current sink output 2. If not used, this pin can be left floating.
OUT3	4	4	22	O	Current sink output 3. If not used, this pin can be left floating.
OUT4	5	5	23	O	Current sink output 4. If not used, this pin can be left floating.
OUT5	6	6	24	O	Current sink output 5. If not used, this pin can be left floating.
OUT6	7	7	25	O	Current sink output 6. If not used, this pin can be left floating.
OUT7	8	8	26	O	Current sink output 7. If not used, this pin can be left floating.
OUT8	9	9	27	O	Current sink output 8. If not used, this pin can be left floating.
OUT9	10	10	1	O	Current sink output 9. If not used, this pin can be left floating.
OUT10	11	11	2	O	Current sink output 10. If not used, this pin can be left floating.
OUT11	12	12	3	O	Current sink output 11. If not used, this pin can be left floating.
OUT12	13	13	4	O	Current sink output 12. If not used, this pin can be left floating.
OUT13	14	14	5	O	Current sink output 13. If not used, this pin can be left floating.
OUT14	15	15	6	O	Current sink output 14. If not used, this pin can be left floating.

表 5-1. Pin Functions (続き)

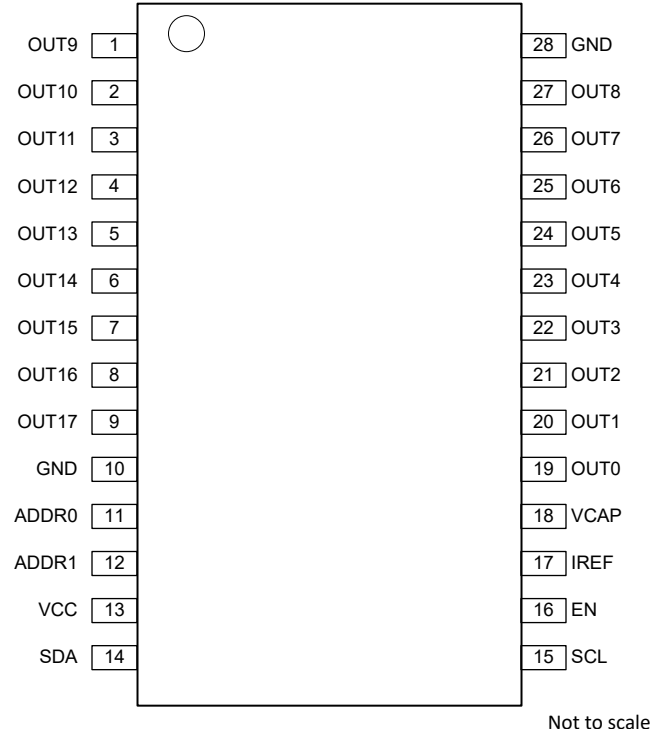
NAME	PIN			I/O	DESCRIPTION
	NO.				
	LP5018RSM	LP5024RSM	LP5018DGS		
OUT15	16	16	7	O	Current sink output 15. If not used, this pin can be left floating.
OUT16	17	17	8	O	Current sink output 16. If not used, this pin can be left floating.
OUT17	18	18	9	O	Current sink output 17. If not used, this pin can be left floating.
OUT18	—	19	—	O	Current sink output 18. If not used, this pin can be left floating.
OUT19	—	20	—	O	Current sink output 19. If not used, this pin can be left floating.
OUT20	—	21	—	O	Current sink output 20. If not used, this pin can be left floating.
OUT21	—	22	—	O	Current sink output 21. If not used, this pin can be left floating.
OUT22	—	23	—	O	Current sink output 22. If not used, this pin can be left floating.
OUT23	—	24	—	O	Current sink output 23. If not used, this pin can be left floating.
SCL	29	29	15	I	I ² C bus clock line. If not used, this pin must be connected to GND or VCC.
SDA	28	28	14	I/O	I ² C bus data line. If not used, this pin must be connected to GND or VCC.
VCAP	32	32	18	—	Internal LDO output pin, this pin must be connected to a 1μF capacitor to GND. Place the capacitor as close to the device as possible.
VCC	27	27	13	I	Input power.
GND	GND	GND	10, 28	—	Exposed thermal pad also serves the ground pin for the device.

6 Specifications

6.1 Absolute Maximum Ratings

over operating ambient temperature range (unless otherwise noted)⁽¹⁾

	MIN	MAX	UNIT
Voltage on EN, IREF, OUTx, SCL, SDA, VCC	-0.3	6	V
Voltage on ADDRx	-0.3	VCC+0.3	V
Voltage on VCAP	-0.3	2	V
Continuous power dissipation	Internally limited		
Junction temperature, T _{J-MAX}	-40	125	°C
Storage temperature, T _{stg}	-65	150	°C

- (1) Stresses beyond those listed under *Absolute Maximum Ratings* may cause permanent damage to the device. These are stress ratings only, which do not imply functional operation of the device at these or any other conditions beyond those indicated under *Recommended Operating Conditions*. Exposure to absolute-maximum-rated conditions for extended periods may affect device reliability.

6.2 ESD Ratings

			VALUE	UNIT
V _(ESD)	Electrostatic discharge	Human-body model (HBM), per ANSI/ESDA/JEDEC JS-001 ⁽¹⁾	±4000	V
		Charged-device model (CDM), per JEDEC specification JESD22-C101 ⁽²⁾	±1500	

- (1) JEDEC document JEP155 states that 500-V HBM allows safe manufacturing with a standard ESD control process. Pins listed as ±1500 V may actually have higher performance.
 (2) JEDEC document JEP157 states that 250-V CDM allows safe manufacturing with a standard ESD control process. Pins listed as ±500 V may actually have higher performance.

6.3 Recommended Operating Conditions

over operating ambient temperature range (unless otherwise noted)

	MIN	MAX	UNIT
Input voltage on VCC	2.7	5.5	V
Voltage on OUTx	0	5.5	V
Voltage on ADDRx, EN, SDA, SCL	0	5.5	V
Operating ambient temperature, T _A	-40	85	°C

6.4 Thermal Information

THERMAL METRIC ⁽¹⁾		LP5018 or LP5024		UNIT
		RSM (VQFN)	DGS (VSSOP)	
		32 PINS	28 PINS	
R _{θJA}	Junction-to-ambient thermal resistance	36.4	80.2	°C/W
R _{θJC(top)}	Junction-to-case (top) thermal resistance	34.8	40.8	°C/W
R _{θJB}	Junction-to-board thermal resistance	15.9	41.0	°C/W
ψ _{JT}	Junction-to-top characterization parameter	0.9	3.8	°C/W
ψ _{JB}	Junction-to-board characterization parameter	16	40.7	°C/W
R _{θJC(bot)}	Junction-to-case (bottom) thermal resistance	6.3	N/A	°C/W

- (1) For more information about traditional and new thermal metrics, see [Semiconductor and IC Package Thermal Metrics](#).

6.5 Electrical Characteristics

over operating ambient temperature range ($-40^{\circ}\text{C} < T_A < 85^{\circ}\text{C}$) (unless otherwise noted)

PARAMETER		TEST CONDITIONS	MIN	TYP	MAX	UNIT
POWER SUPPLIES (VCC)						
V_{VCC}	Supply voltage		2.7		5.5	V
I_{VCC}	Shutdown supply current	$V_{EN} = 0\text{ V}$		0.2	1	μA
	Standby supply current	$V_{EN} = 3.3\text{ V}$, Chip_EN = 0 (bit)		6	10	μA
	Normal-mode supply current	With 10-mA LED current per OUTx		5	8	mA
	Power-save mode supply current	$V_{EN} = 3.3\text{ V}$, Chip_EN = 1 (bit), Power_Save_EN = 1 (bit), all the LEDs off duration $> t_{PSM}$		6	10	μA
V_{UVR}	Undervoltage restart	V_{VCC} rising			2.5	V
V_{UVF}	Undervoltage shutdown	V_{VCC} falling	2			V
V_{UV_HYS}	Undervoltage shutdown hysteresis			0.2		V
OUTPUT STAGE (OUTx)						
I_{MAX}	Maximum sink current (OUT0–OUTx) (For LP5024, x = 23. For LP5018, x = 17.)	V_{VCC} in full range, Max_Current_Option = 0 (bit), PWM = 100%			25.5	mA
	Maximum sink current (OUT0–OUTx) (For LP5024, x = 23. For LP5018, x = 17.)	$V_{VCC} \geq 3.3\text{ V}$, Max_Current_Option = 1 (bit), PWM = 100%			35	
I_{LIM}	Internal sink current limit (OUT0–OUTx) (For LP5024, x = 23. For LP5018, x = 17.)	V_{VCC} in full range, Max_Current_Option = 0 (bit), $V_{IREF} = 0\text{ V}$	35	55	80	mA
	Internal sink current limit (OUT0–OUTx) (For LP5024, x = 23. For LP5018, x = 17.)	$V_{VCC} \geq 3.3\text{ V}$, Max_Current_Option = 1 (bit), $V_{IREF} = 0\text{ V}$	40	75	120	
I_{lkg}	Leakage current (OUT0–OUTx) (For LP5024, x = 23. For LP5018, x = 17.)	PWM = 0%		0.1	1	μA
I_{ERR_DD}	Device to device current error, $I_{ERR_DD} = (I_{AVE} - I_{SET}) / I_{SET} \times 100\%$	All channels' current set to 10 mA. PWM = 100%. Already includes the V_{IREF} and K_{IREF} tolerance	-7%		7%	
I_{ERR_CC}	Channel to channel current error, $I_{ERR_CC} = (I_{OUTx} - I_{AVE}) / I_{AVE} \times 100\%$	All channels' current set to 10 mA. PWM = 100%. Already includes the V_{IREF} and K_{IREF} tolerance	-7%		7%	
V_{IREF}	IREF voltage			0.7		V
K_{IREF}	IREF ratio			105		
f_{PWM}	PWM switching frequency		21	29		kHz
V_{SAT}	Output saturation voltage	V_{VCC} in full range, Max_Current_Option = 0 (bit), output current set to 20 mA, the voltage when the LED current has dropped 5%		0.25	0.35	V
		$V_{VCC} \geq 3.3\text{ V}$, Max_Current_Option = 1 (bit), output current set to 20 mA, the voltage when the LED current has dropped 5%		0.3	0.4	
LOGIC INPUTS (EN, SCL, SDA, ADDRx)						
V_{IL}	Low level input voltage				0.4	V
V_{IH}	High level input voltage		1.4			V
I_{LOGIC}	Input current		-1		1	μA
V_{SDA}	SDA output low level	$I_{PULLUP} = 5\text{ mA}$			0.4	V

6.5 Electrical Characteristics (続き)

over operating ambient temperature range ($-40^{\circ}\text{C} < T_A < 85^{\circ}\text{C}$) (unless otherwise noted)

PARAMETER		TEST CONDITIONS	MIN	TYP	MAX	UNIT
PROTECTION CIRCUITS						
$T_{(TSD)}$	Thermal-shutdown junction temperature			160		$^{\circ}\text{C}$
$T_{(HYS)}$	Thermal shutdown temperature hysteresis			15		$^{\circ}\text{C}$

6.6 Timing Requirements

over operating ambient temperature range ($-40^{\circ}\text{C} < T_A < 85^{\circ}\text{C}$) (unless otherwise noted)

PARAMETER		MIN	TYP	MAX	UNIT
f_{OSC}	Internal oscillator frequency		15		MHz
t_{PSM}	Power save mode deglitch time	20	30	40	ms
$t_{\text{EN_H}}$	EN first rising edge until first I ² C access			500	μs
$t_{\text{EN_L}}$	EN first falling edge until first I ² C reset			3	μs
f_{SCL}	I ² C clock frequency			400	kHz
1	Hold time (repeated) START condition	0.6			μs
2	Clock low time	1.3			μs
3	Clock high time	600			ns
4	Setup time for a repeated START condition	600			ns
5	Data hold time	0			ns
6	Data setup time	100			ns
7	Rise time of SDA and SCL	$20 + 0.1 C_b$		300	ns
8	Fall time of SDA and SCL	$15 + 0.1 C_b$		300	ns
9	Setup time for STOP condition	600			ns
10	Bus free time between a STOP and a START condition	1.3			μs
C_b	Capacitive load parameter for each bus line Load of 1 pF corresponds to one nanosecond.	10		200	pF



図 6-1. I²C Timing Parameters

6.7 Typical Characteristics



图 6-2. I_{OUT} Target vs R_{IREF}

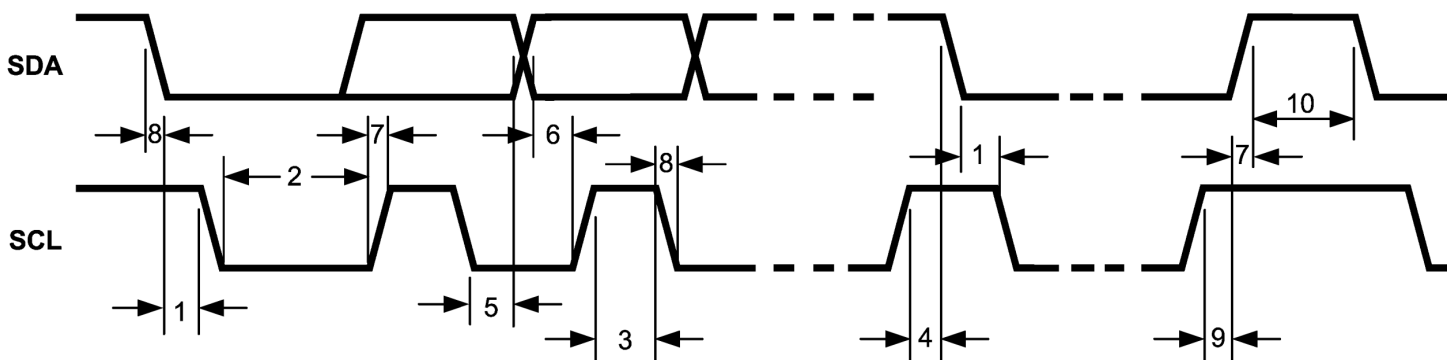

VCC = 3.3 V

图 6-3. Output Current vs Temperature

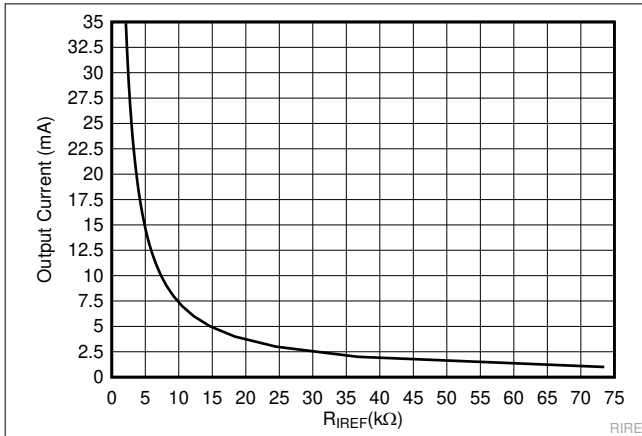
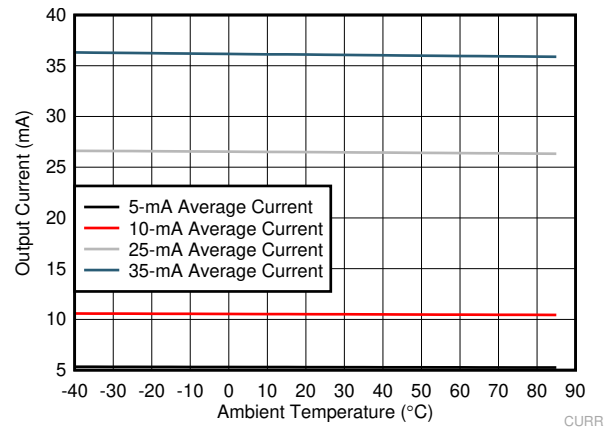
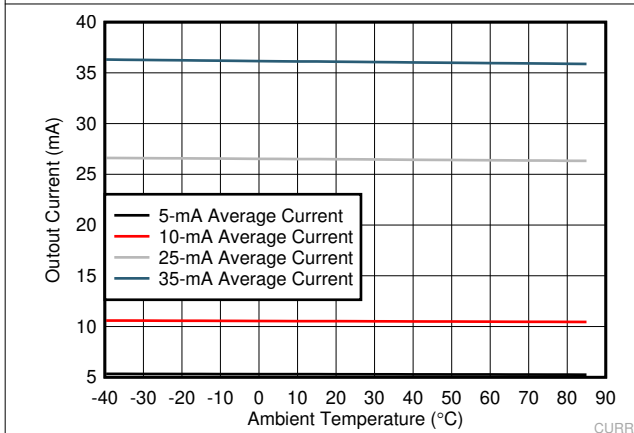

VCC = 5 V

图 6-4. Output Current vs Temperature

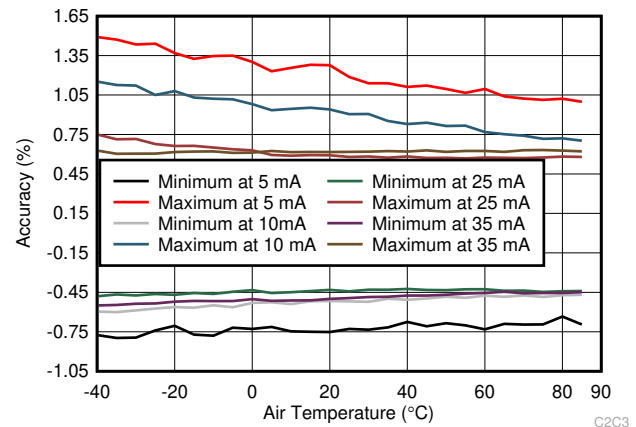

VCC = 3.3 V

图 6-5. Channel-to-Channel Current Accuracy

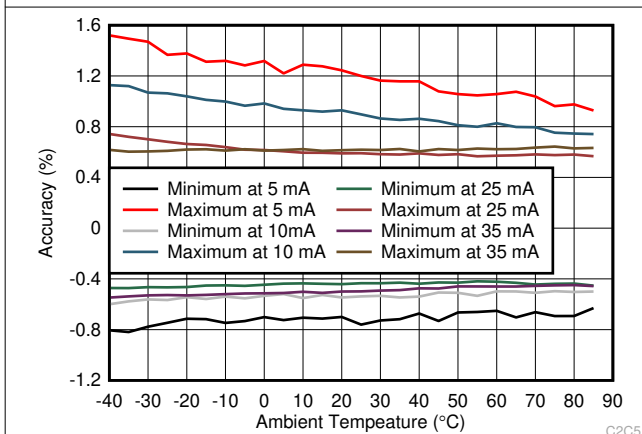

VCC = 5 V

图 6-6. Channel-to-Channel Current Accuracy vs Temperature

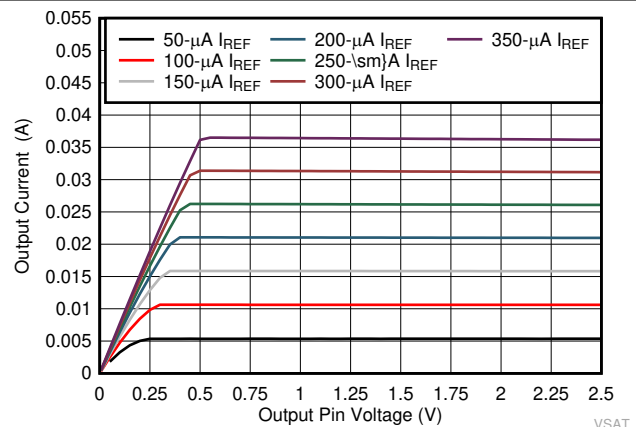

VCC = 3.3 V

图 6-7. OUT Pin Voltage vs Current

6.7 Typical Characteristics (continued)

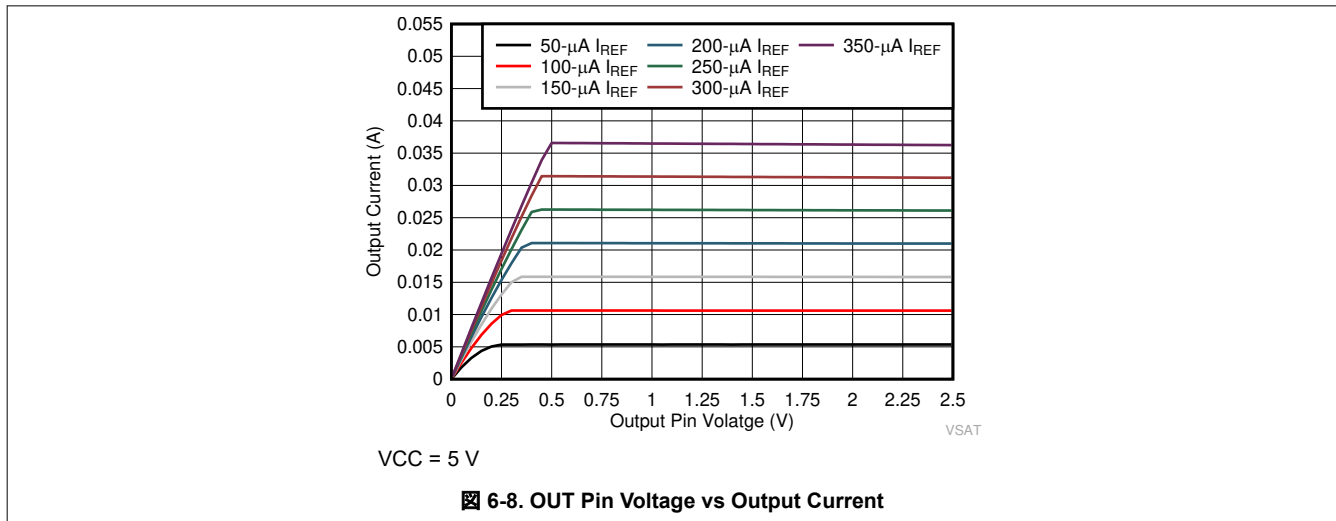

7 Detailed Description

7.1 Overview

The LP50xx device is an 18- or 24-channel constant-current-sink LED driver. The LP50xx device includes all necessary power rails, an on-chip oscillator, and a two-wire serial I²C interface. The maximum constant-current value of all channels is set by a single external resistor. Two hardware address pins allow up to four devices on the same bus. An automatic power-saving mode is implemented to keep the total current consumption under 10µA, which makes the LP50xx device a potential choice for battery-powered end-equipment.

The LP50xx device is optimized for RGB LEDs regarding to both live effects and software efforts. The LP50xx device controls each LED output with 12-bit PWM resolution at 29kHz switching frequency, which helps achieve a smooth dimming effect and eliminates audible noise. The independent color-mixing and intensity-control registers make the software coding straightforward. When targeting a fade-in, fade-out type breathing effect, the global RGB bank control reduces the microcontroller loading significantly. The LP50xx device also implements a PWM phase-shifting function to help reduce the input power budget when LEDs turn on simultaneously.

7.2 Functional Block Diagram

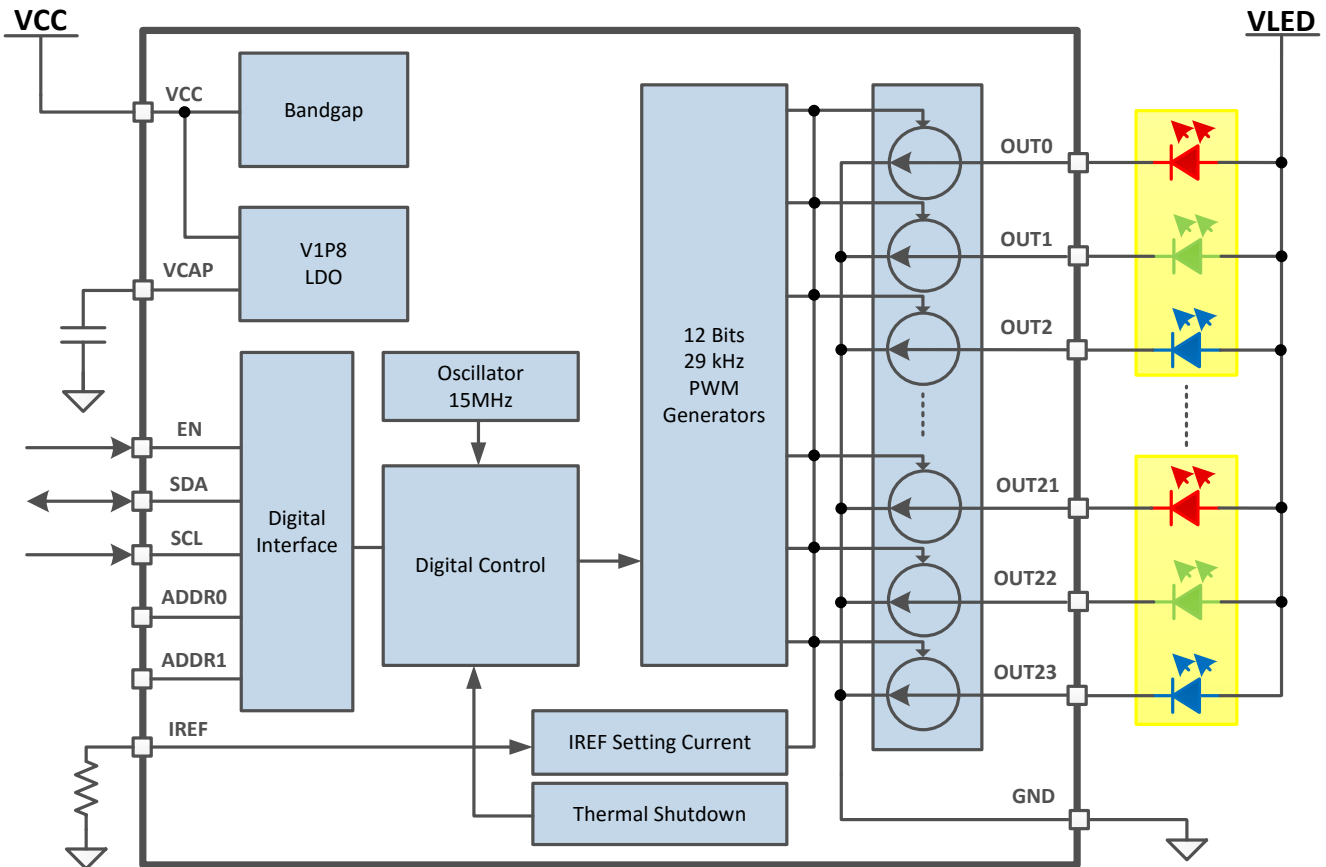

7.3 Feature Description

7.3.1 PWM Control for Each Channel

Most traditional LED drivers are designed for the single-color LEDs, in which the high-resolution PWM generator is used for intensity control only. However, for RGB LEDs, both the color mixing and intensity control should be addressed to achieve the target effect. With the traditional solution, the users must handle the color mixing and intensity control simultaneously with a single PWM register. Several undesired effects occur: the limited dimming steps, the complex software design, and the color distortion when using a logarithmic scale control.

The LP50xx device is designed with independent color mixing and intensity control, which makes the RGB LED effects fancy and the control experience straightforward. With the inputs of the color-mixing register and the intensity-control register, the final PWM generator output for each channel is 12-bit resolution and 29kHz dimming frequency, which helps achieve a smooth dimming effect and eliminates audible noise. See [Figure 7-1](#).



図 7-1. PWM Control Scheme for Each Channel

7.3.1.1 Independent Color Mixing Per RGB LED Module

Each output channel has its own individual 8-bit color-setting register (OUTx_COLOR). The device allows every RGB LED module to achieve >16 million ($256 \times 256 \times 256$) color-mixing.

7.3.1.2 Independent Intensity Control Per RGB LED Module

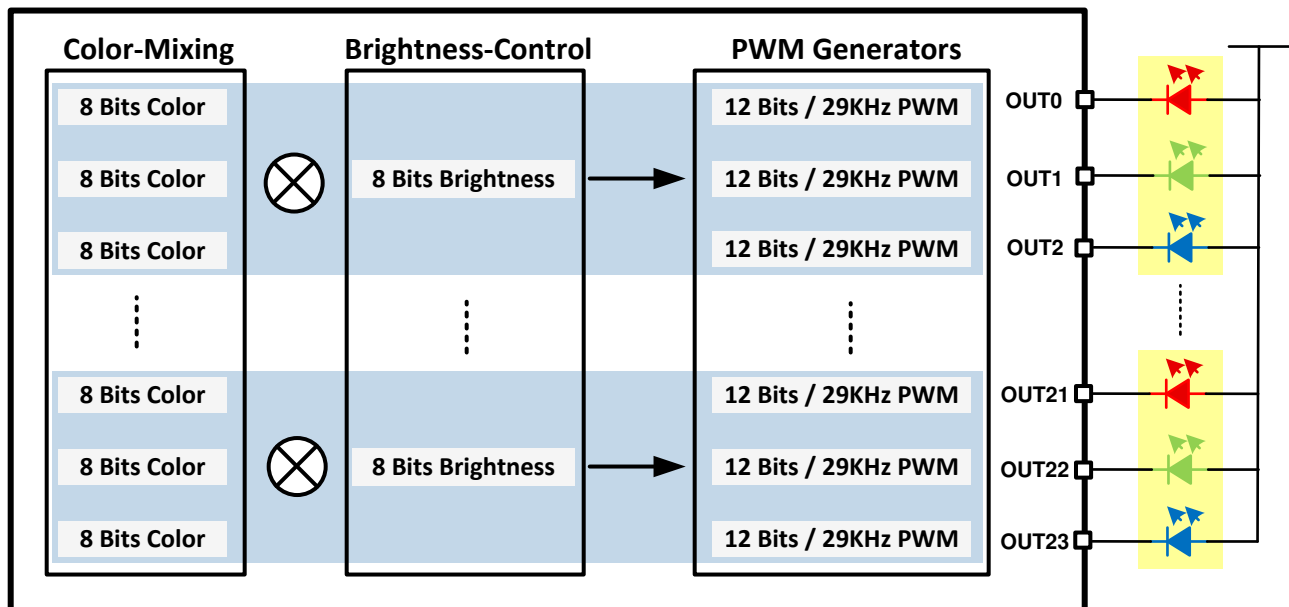
When color is fixed, the independent intensity-control is used to achieve accurate and flexible dimming control for every RGB LED module.

7.3.1.2.1 Intensity-Control Register Configuration

Every three consecutive output channels are assigned to their respective intensity-control register (LEDx_BRIGHTNESS). For example, OUT0, OUT1, and OUT2 are assigned to LED0_BRIGHTNESS, so it is recommended to connect the RGB LEDs in the sequence as shown in [LED Bank Control](#). The LP50xx device allows 256-step intensity control for each RGB LED module, which helps achieve a smooth dimming effect.

Keeping FFh (default value) in the LED0_BRIGHTNESS register results in 100% dimming duty cycle. With this setting, users can just configure the color mixing register by channel to achieve the target dimming effect in a single-color LED application.

7.3.1.2.2 Logarithmic- or Linear-Scale Intensity Control

For human-eye-friendly visual performance, a logarithmic-scale dimming curve is usually implemented in LED drivers. However, for RGB LEDs, if using a single register to achieve both color mixing and intensity control, color distortion can be observed easily when using a logarithmic scale. The LP50xx device, with independent color-mixing and intensity-control registers, implements the logarithmic scale dimming control inside the intensity control function, which solves the color distortion issue effectively. See [Figure 7-2](#). Also, the LP50xx device allows users to configure the dimming scale either logarithmically or linearly through the global Log_Scale_EN register. If a special dimming curve is desired, using the linear scale with software correction is the most flexible approach. See [Figure 7-3](#).

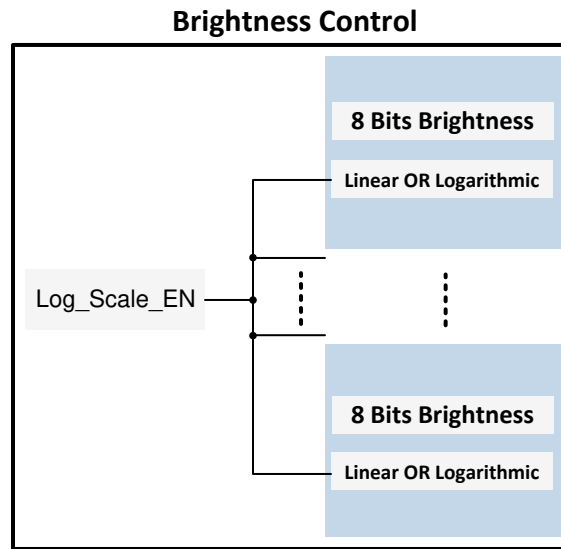

Figure 7-2. Logarithmic- or Linear-Scale Intensity Control

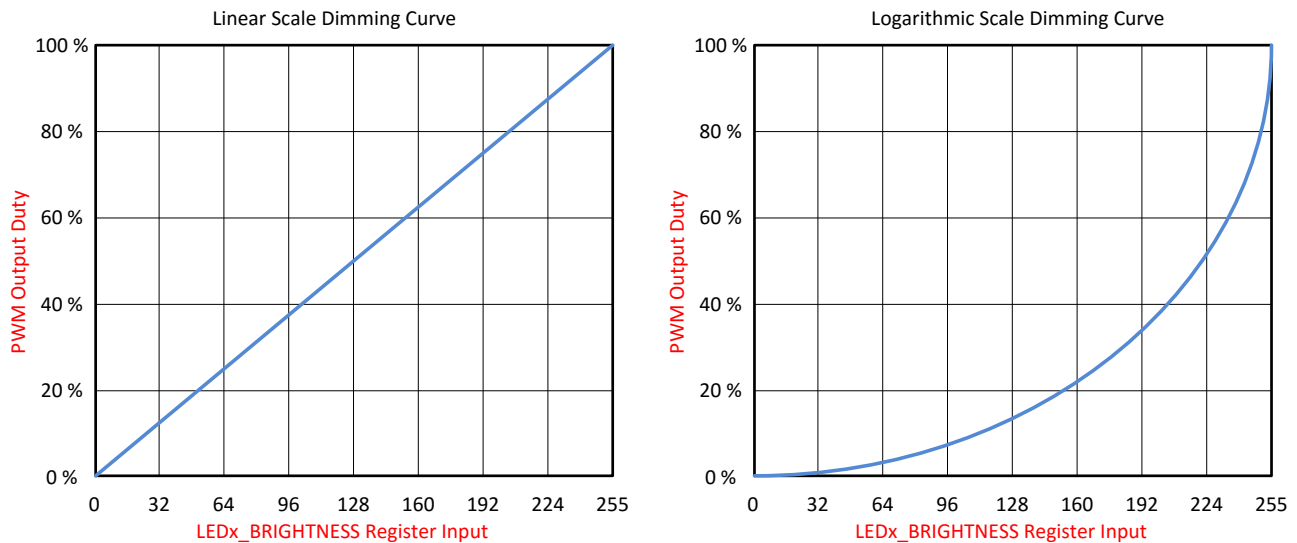

Figure 7-3. Logarithmic vs Linear Dimming Curve

7.3.1.3 12-Bit, 29-kHz PWM Generator Per Channel

7.3.1.3.1 PWM Generator

With the inputs of the color mixing and the intensity control, the final output PWM duty cycle is defined as the product obtained by multiplying the color-mixing register value by the related intensity-control register value. The

final output PWM duty cycle has 12 bits of control accuracy, which is achieved by a 9 bits of pure PWM resolution and 3 bits of digital dithering control. For 3-bit dithering, every eighth pulse is made 1 LSB longer to increase the average value by $1 / 8$ th. The LP50xx device allows users to enable or disable the dithering function through the PWM_Dithering_EN register. When enabled (default), the output PWM duty-cycle accuracy is 12 bits. When disabled, the output PWM duty-cycle accuracy is 9 bits.

To eliminate the audible noise due to the PWM switching, the LP50xx device sets the PWM switching frequency at 29-kHz, above the 20-kHz human hearing range.

7.3.1.4 PWM Phase-Shifting

A PWM phase-shifting scheme allows delaying the time when each LED driver is active. When the LED drivers are not activated simultaneously, the peak load current from the pre-stage power supply is significantly decreased. The scheme also reduces input-current ripple and ceramic-capacitor audible ringing. LED drivers are grouped into three different phases.

- Phase 1—the rising edge of the PWM pulse is fixed. The falling edge of the pulse is changed when the duty cycle changes. Phase 1 is applied to LED0, LED3, ..., LED21.
- Phase 2—the middle point of the PWM pulse is fixed. The pulse spreads in both directions when the PWM duty cycle is increased. Phase 2 is applied to LED1, LED4, ..., LED22.
- Phase 3—the falling edge of the PWM pulse is fixed. The rising edge of the pulse is changed when the duty cycle changes. Phase 3 is applied to LED2, LED5, ..., LED23.



図 7-4. PWM Phase-Shifting

7.3.2 LED Bank Control

For most LED-animation effects, like blinking and breathing, all the RGB LEDs have the same lighting pattern. Instead of controlling the individual LED separately, which occupies the microcontroller resources heavily, the LP50xx device provides an easy coding approach, the LED bank control.

Each channel can be configured as either independent control or bank control through the LEDx_Bank_EN register. When LEDx_Bank_EN = 0 (default), the LED is controlled independently by the related color-mixing and intensity-control registers. When LEDx_Bank_EN = 1, the LP50xx device drives the LEDs in LED bank-control mode. The LED bank has its own independent PWM control scheme, which is the same structure as the PWM

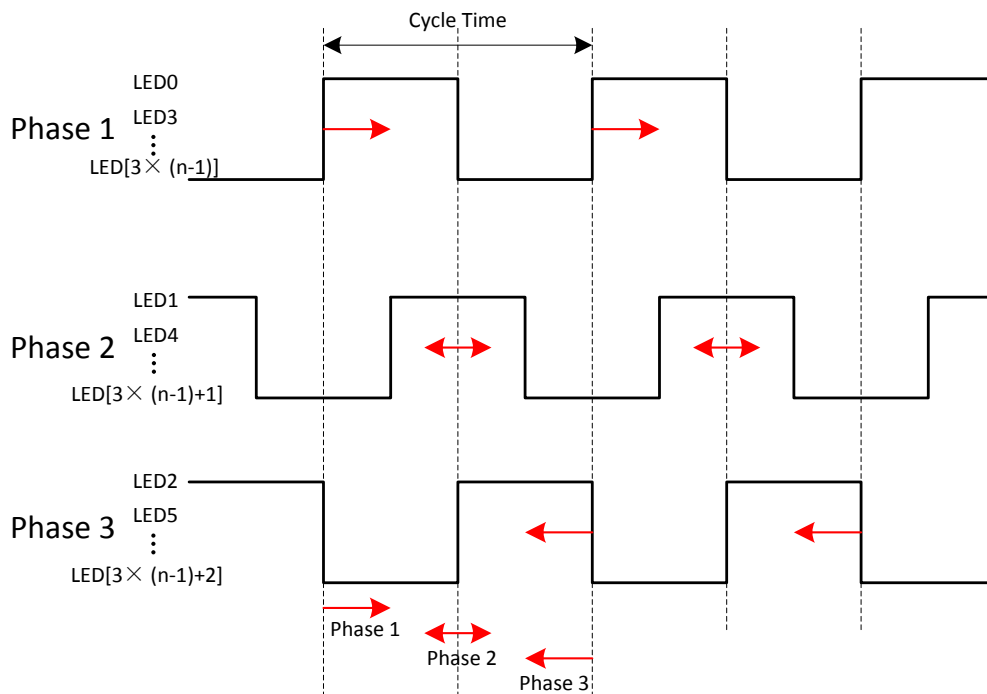
scheme of each channel. For more details, see [PWM Control for Each Channel](#) . When a channel is configured in LED bank-control mode, the related color mixing and intensity control is governed by the bank control registers (BANK_A_COLOR, BANK_B_COLOR, BANK_C_COLOR, and BANK_BRIGHTNESS) regardless of the inputs on its own color-mixing and intensity-control registers.



図 7-5. Bank PWM Control Scheme

表 7-1. Bank Number and LED Number Assignment

OUT NUMBER			OUT CORLOR	BANK Number	RGB LED MODULE NUMBER
LP5024VQFN	LP5018VQFN	LP5018VSSOP			
OUT0	OUT0	OUT0	OUT0_COLOR	Bank A	LED0
OUT1	OUT1	OUT1	OUT1_COLOR	Bank B	
OUT2	OUT2	—	OUT2_COLOR	Bank C	
OUT3	OUT3	OUT2	OUT3_COLOR	Bank A	LED1
OUT4	OUT4	OUT3	OUT4_COLOR	Bank B	
OUT5	OUT5	OUT4	OUT5_COLOR	Bank C	
OUT6	OUT6	—	OUT6_COLOR	Bank A	LED2
OUT7	OUT7	OUT5	OUT7_COLOR	Bank B	
OUT8	OUT8	OUT6	OUT8_COLOR	Bank C	
OUT9	OUT9	OUT7	OUT9_COLOR	Bank A	LED3
OUT10	OUT10	OUT8	OUT10_COLOR	Bank B	
OUT11	OUT11	—	OUT11_COLOR	Bank C	
OUT12	OUT12	OUT9	OUT12_COLOR	Bank A	LED4
OUT13	OUT13	OUT10	OUT13_COLOR	Bank B	
OUT14	OUT14	OUT11	OUT14_COLOR	Bank C	
OUT15	OUT15	OUT12	OUT15_COLOR	Bank A	LED5
OUT16	OUT16	—	OUT16_COLOR	Bank B	
OUT17	OUT17	OUT13	OUT17_COLOR	Bank C	
OUT18	—	—	OUT18_COLOR	Bank A	LED6
OUT19	—	OUT14	OUT19_COLOR	Bank B	
OUT20	—	OUT15	OUT20_COLOR	Bank C	
OUT21	—	OUT16	OUT21_COLOR	Bank A	LED7
OUT22	—	OUT17	OUT22_COLOR	Bank B	
OUT23	—	—	OUT23_COLOR	Bank C	

With the bank control configuration, the LP50xx device enables users to achieve smooth and live LED effects globally with an ultrasimple software effort. [Figure 7-6](#) shows an example using LED0 as an independent RGB indicator and others with group breathing effect.

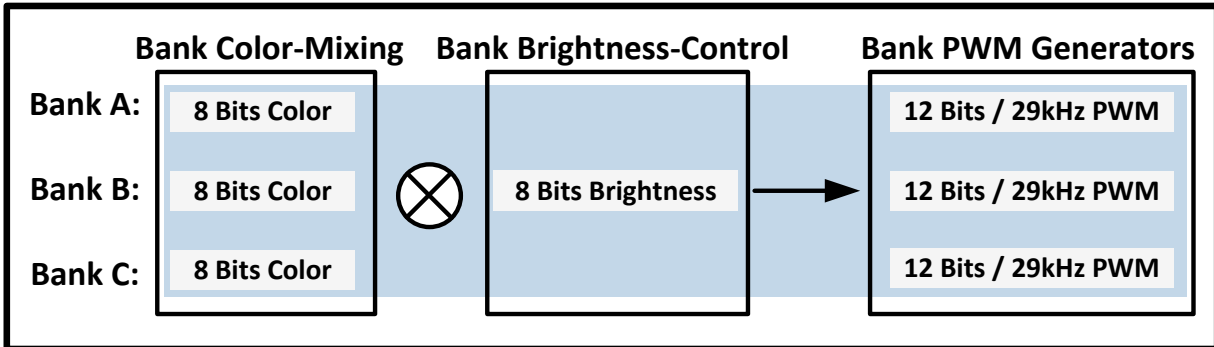
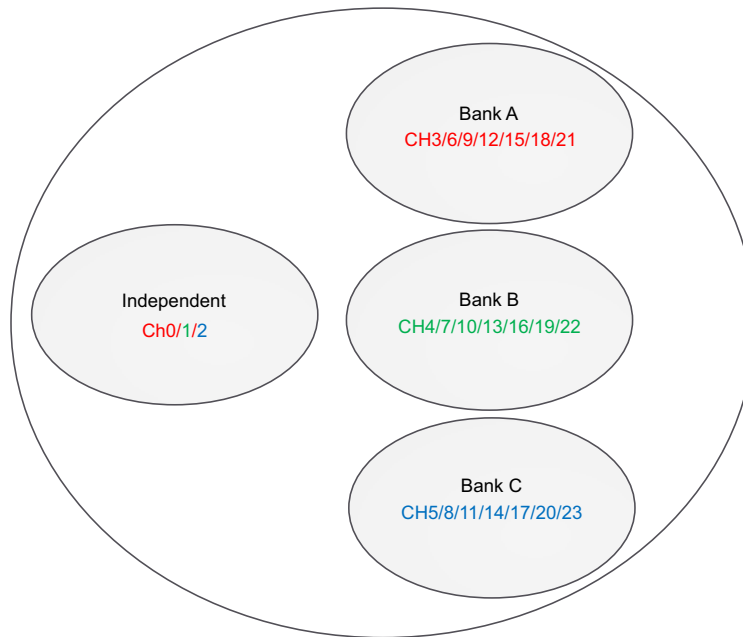

Figure 7-6. Bank PWM Control Example (Applicable to LP5024 VQFN and LP5018 VQFN only)

7.3.3 Current Range Setting

The constant-current value (I_{SET}) of all 24 channels is set by a single external resistor, R_{IREF} . The value of R_{IREF} can be calculated by [Equation 1](#).

$$R_{IREF} = K_{IREF} \times \frac{V_{IREF}}{I_{SET}} \quad (1)$$

where:

- $K_{IREF} = 105$
- $V_{IREF} = 0.7V$

With the IREF pin floating, the output current is close to zero. With the IREF pin shorted to GND, the LP50xx device provides internal current-limit protection, and the output-channel maximum current is limited to I_{LIM} .

The LP50xx device supports two levels of maximum output current, I_{MAX} .

- When V_{CC} is in the range from 2.7V to 5.5V, and the Max_Current_Option (bit) = 0, $I_{MAX} = 25.5mA$.
- When V_{CC} is in the range from 3.3V to 5.5V, and the Max_Current_Option (bit) = 1, $I_{MAX} = 35mA$.

7.3.4 Automatic Power-Save Mode

When all the LED outputs are inactive, the LP50xx device is able to enter power-save mode automatically, thus lowering idle-current consumption down to 10 μ A (typical). Automatic power-save mode is enabled when register bit Power_Save_EN = 1 (default) and all the LEDs are off for a duration of >30ms. Almost all analog blocks are powered down in power-save mode. If any I²C command to the device occurs, the LP50xx device returns to NORMAL mode.

7.3.5 Protection Features

7.3.5.1 Thermal Shutdown

The LP50xx device implements a thermal shutdown mechanism to protect the device from damage due to overheating. When the junction temperature rises to 160°C (typical), the device switches into shutdown mode. The LP50xx device releases thermal shutdown when the junction temperature of the device is reduced to 145°C (typical).

7.3.5.2 UVLO

The LP50xx device has an internal comparator that monitors the voltage at V_{CC} . When V_{CC} is below V_{UVF} , reset is active and the LP50xx device is in the INITIALIZATION state.

7.4 Device Functional Modes



图 7-7. Functional Modes

- **INITIALIZATION:** The device enters into INITIALIZATION mode when $EN = H$. In this mode, all the registers are reset. Entry can also be from any state, if the RESET (register) = FFh or UVLO is active.
- **NORMAL:** The device enters the NORMAL mode when Chip_EN (register) = 1. I_{CC} is 10mA (typical).
- **POWER SAVE:** The device automatically enters the POWER SAVE mode when Power_Save_EN (register) = 1 and all the LEDs are off for a duration of > 30ms. In POWER SAVE mode, analog blocks are disabled to minimize power consumption, but the registers retain the data and keep it available via I²C. I_{CC} is 10 μ A (typical). In case of any I²C command to this device, it returns to the NORMAL mode.
- **SHUTDOWN:** The device enters into SHUTDOWN mode from all states on V_{CC} power up or when $EN = L$. I_{CC} is < 1 μ A (maximum).
- **STANDBY:** The device enters the STANDBY mode when Chip_EN (register) = 0. In this mode, all the OUTx pins are shut down, but the registers retain the data and keep it available via I²C. STANDBY is the low-power-consumption mode, when all circuit functions are disabled. I_{CC} is 10 μ A (typical).

- **THERMAL SHUTDOWN:** The device automatically enters the THERMAL SHUTDOWN mode when the junction temperature exceeds 160°C (typical). In this mode, all the OUTx outputs are shut down. If the junction temperature decreases below 145°C (typical), the device returns to the NORMAL mode.

7.5 Programming

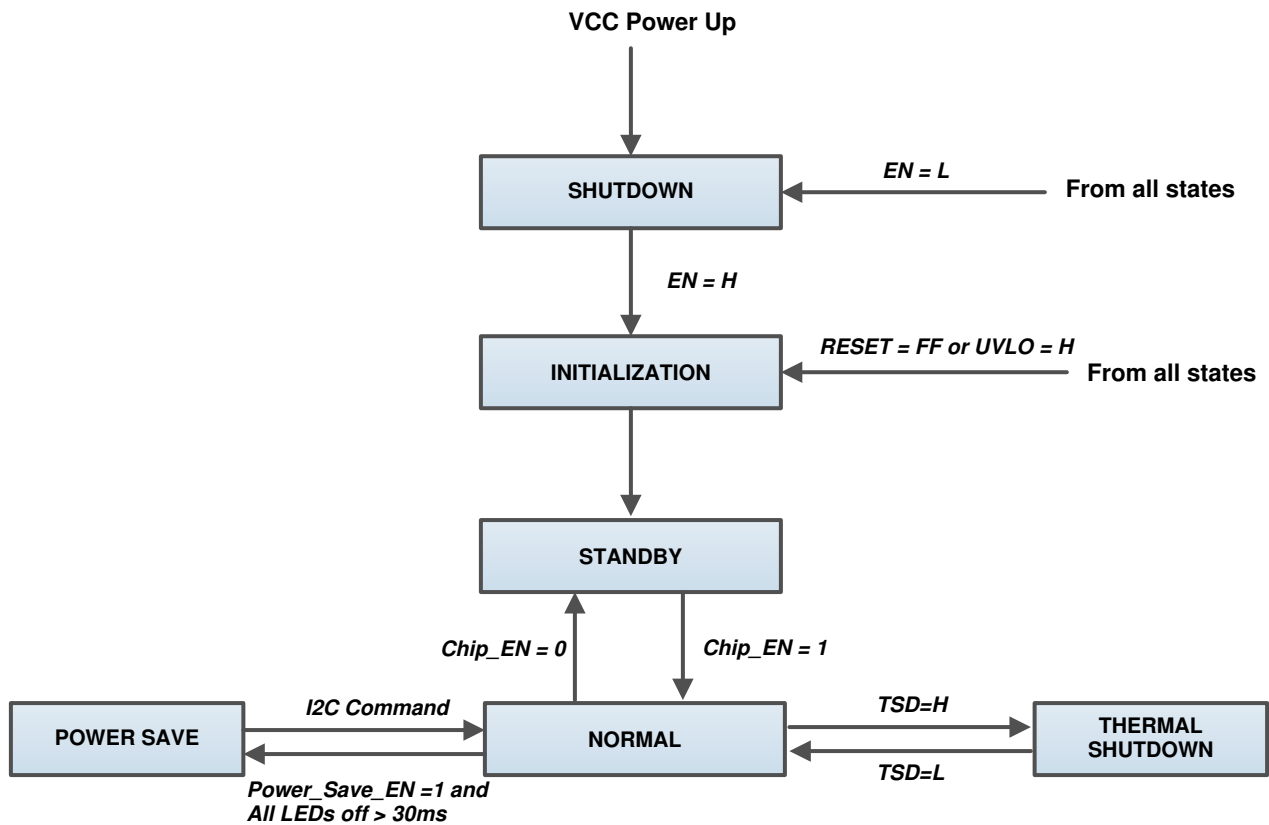
7.5.1 I²C Interface

The I²C-compatible two-wire serial interface provides access to the programmable functions and registers on the device. This protocol uses a two-wire interface for bidirectional communications between the devices connected to the bus. The two interface lines are the serial data line (SDA) and the serial clock line (SCL). Every device on the bus is assigned a unique address and acts as either a master or a slave depending on whether it generates or receives the serial clock, SCL. The SCL and SDA lines should each have a pullup resistor placed somewhere on the line and remain HIGH even when the bus is idle.

7.5.1.1 Data Validity

The data on SDA line must be stable during the HIGH period of the clock signal (SCL). In other words, the state of the data line can only be changed when the clock signal is LOW.

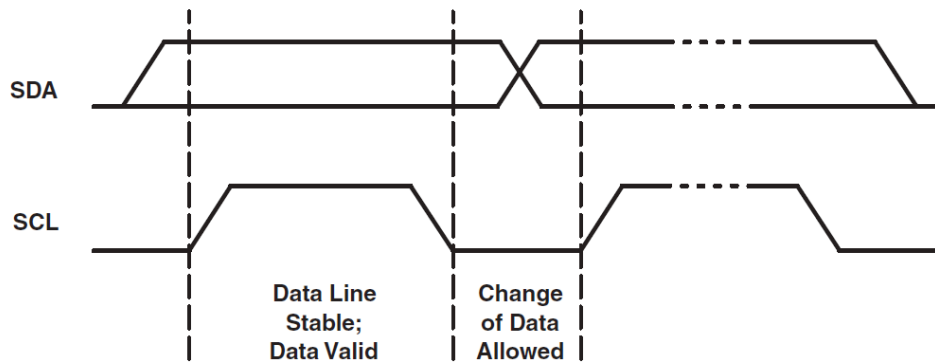

☒ 7-8. Data Validity

7.5.1.2 Start and Stop Conditions

START and STOP conditions classify the beginning and the end of the data transfer session. A START condition is defined as the SDA signal transitioning from HIGH to LOW while the SCL line is HIGH. A STOP condition is defined as the SDA transitioning from LOW to HIGH while SCL is HIGH. The bus master always generates START and STOP conditions. The bus is considered to be busy after a START condition and free after a STOP condition. During data transmission, the bus master can generate repeated START conditions. First START and repeated START conditions are functionally equivalent.

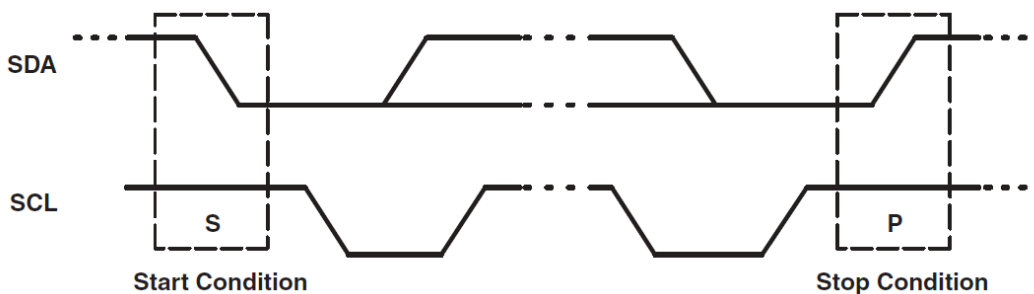

☒ 7-9. Start and Stop Conditions

7.5.1.3 Transferring Data

Every byte put on the SDA line must be eight bits long, with the most-significant bit (MSB) being transferred first. Each byte of data must be followed by an acknowledge bit. The acknowledge-related clock pulse is generated by the master. The master releases the SDA line (HIGH) during the acknowledge clock pulse. The device pulls down the SDA line during the ninth clock pulse, signifying an acknowledge. The device generates an acknowledge after each byte has been received.

There is one exception to the acknowledge-after-every-byte rule. When the master is the receiver, it must indicate to the transmitter an end of data by not acknowledging (negative acknowledge) the last byte clocked out of the slave. This negative acknowledge still includes the acknowledge clock pulse (generated by the master), but the SDA line is not pulled down.

After the START condition, the bus master sends a chip address. This address is seven bits long followed by an eighth bit which is a data direction bit (READ or WRITE). For the eighth bit, a 0 indicates a WRITE, and a 1 indicates a READ. The second byte selects the register to which the data is written. The third byte contains data to write to the selected register.



図 7-10. Acknowledge and Not Acknowledge on I²C Bus

7.5.1.4 I²C Slave Addressing

The device slave address is defined by connecting GND or VCC to the ADDR0 and ADDR1 pins. A total of four independent slave addresses can be realized by combinations when GND or VCC is connected to the ADDR0 and ADDR1 pins (see 表 7-2 and 表 7-3).

The device responds to a broadcast slave address regardless of the setting of the ADDR0 and ADDR1 pins. Global writes to the broadcast address can be used for configuring all devices simultaneously. The device supports global read using a broadcast address; however, the data read is only valid if all devices on the I²C bus contain the same value in the addressed register.

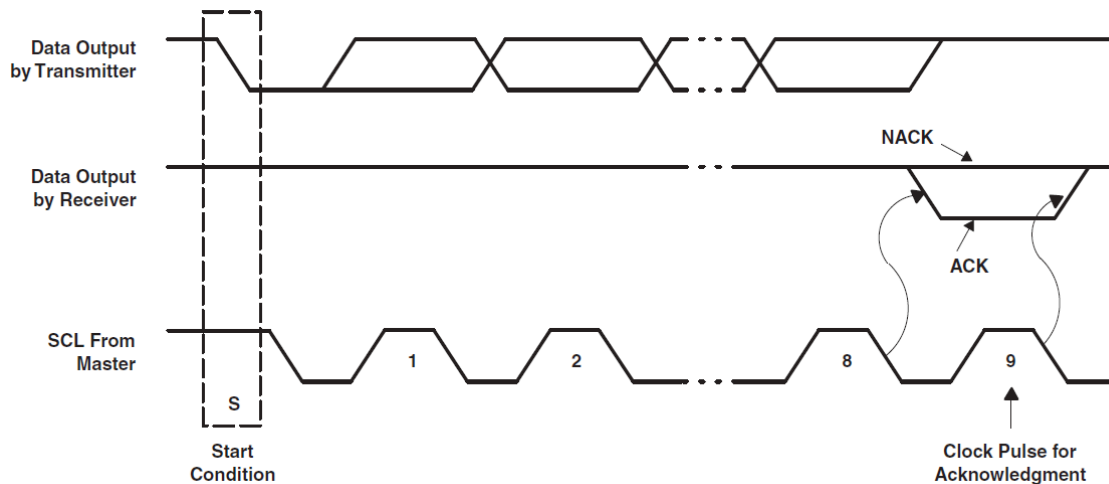
表 7-2. Slave-Address Combinations

ADDR1	ADDR0	SLAVE ADDRESS	
		INDEPENDENT	BROADCAST
GND	GND	010 1000	011 1100
GND	VCC	010 1001	
VCC	GND	010 1010	
VCC	VCC	010 1011	

表 7-3. Chip Address

	SLAVE ADDRESS							R/ \overline{W}
	Bit 7	Bit 6	Bit 5	Bit 4	Bit 3	Bit 2	Bit 1	Bit 0
Independent	0	1	0	1	0	ADDR1	ADDR0	1 or 0
Broadcast	0	1	1	1	1	0	0	1 or 0

7.5.1.5 Control-Register Write Cycle

- The master device generates a start condition.
- The master device sends the slave address (7 bits) and the data direction bit ($R/\overline{W} = 0$).
- The slave device sends an acknowledge signal if the slave address is correct.
- The master device sends the control register address (8 bits).
- The slave device sends an acknowledge signal.
- The master device sends the data byte to be written to the addressed register.
- The slave device sends an acknowledge signal.
- If the master device sends further data bytes, the control register address of the slave is incremented by 1 after the acknowledge signal. To reduce program load time, the device supports address auto incrementation. The register address is incremented after each 8 data bits.
- The write cycle ends when the master device creates a stop condition.



図 7-11. Write Cycle

7.5.1.6 Control-Register Read Cycle

- The master device generates a start condition.
- The master device sends the slave address (7 bits) and the data direction bit ($R/\overline{W} = 0$).
- The slave device sends an acknowledge signal if the slave address is correct.
- The master device sends the control register address (8 bits).
- The slave device sends an acknowledge signal.
- The master device generates a repeated-start condition.
- The master device sends the slave address (7 bits) and the data direction bit ($R/\overline{W} = 1$).
- The slave device sends an acknowledge signal if the slave address is correct.
- The slave device sends the data byte from the addressed register.
- If the master device sends an acknowledge signal, the control-register address is incremented by 1. The slave device sends the data byte from the addressed register. To reduce program load time, the device supports address auto incrementation. The register address is incremented after each 8 data bits.
- The read cycle ends when the master device does not generate an acknowledge signal after a data byte and generates a stop condition.

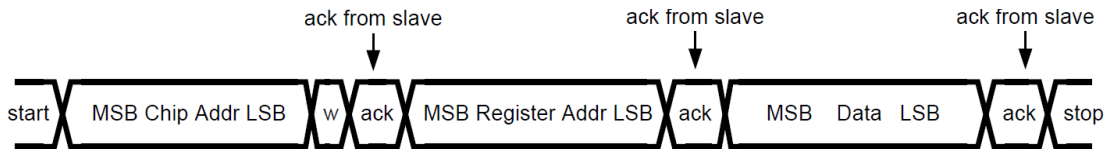

図 7-12. Read Cycle

7.5.1.7 Auto-Increment Feature

The auto-increment feature allows writing or reading several consecutive registers within one transmission. For example, when an 8-bit word is sent to the device, the internal address index counter is incremented by 1, and

the next register is written. The auto-increment feature is enabled by default and can be disabled by setting the Auto_Incr_EN bit = 0 in the DEVICE_CONFIG1 register. The auto-increment feature is applied for the full register address from 0h to FFh.

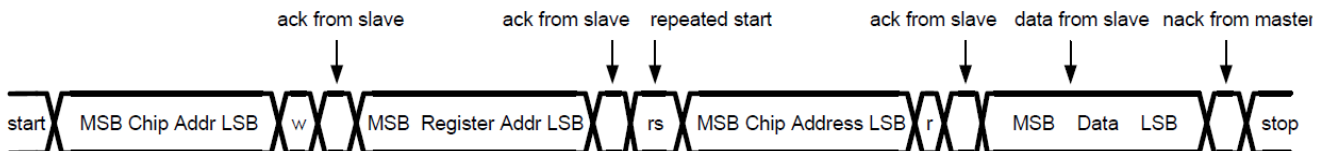
7.6 Register Maps

表 7-4 lists the memory-mapped registers of the device.

表 7-4. Register Maps

REGISTER NAME	ADDR	TYPE	D7	D6	D5	D4	D3	D2	D1	D0	DEF-AULT
DEVICE_CONFIG0	00h	R/ W	RESERVED	Chip_EN	RESERVED						00h
DEVICE_CONFIG1	01h	R/ W	RESERVED		Log_Scale_EN	Power_Save_EN	Auto_Incr_EN	PWM_Dithering_EN	Max_Current_Option	LED_Global Off	3Ch
LED_CONFIG0	02h	R/ W	LED7_Bank_EN	LED6_Bank_EN	LED5_Bank_EN	LED4_Bank_EN	LED3_Bank_EN	LED2_Bank_EN	LED1_Bank_EN	LED0_Bank_EN	00h
BANK_BRIGHTNESS	03h	R/ W	Bank_Brightness								FFh
BANK_A_COLOR	04h	R/ W	Bank_A_Color								00h
BANK_B_COLOR	05h	R/ W	Bank_B_Color								00h
BANK_C_COLOR	06h	R/ W	Bank_C_Color								00h
LED0_BRIGHTNESS	07h	R/ W	LED0_Brightness								FFh
LED1_BRIGHTNESS	08h	R/ W	LED1_Brightness								FFh
LED2_BRIGHTNESS	09h	R/ W	LED2_Brightness								FFh
LED3_BRIGHTNESS	0Ah	R/ W	LED3_Brightness								FFh
LED4_BRIGHTNESS	0Bh	R/ W	LED4_Brightness								FFh
LED5_BRIGHTNESS	0Ch	R/ W	LED5_Brightness								FFh
LED6_BRIGHTNESS	0Dh	R/ W	LED6_Brightness								FFh
LED7_BRIGHTNESS	0Eh	R/ W	LED7_Brightness								FFh
OUT0_COLOR	0Fh	R/ W	OUT0_Color								00h
OUT1_COLOR	10h	R/ W	OUT1_Color								00h
OUT2_COLOR	11h	R/ W	OUT2_Color								00h

表 7-4. Register Maps (続き)

REGISTER NAME	ADDR	TYPE	D7	D6	D5	D4	D3	D2	D1	D0	DEF-AULT	
OUT3_COLOR	12h	R/ \bar{W}									OUT3_Color	00h
OUT4_COLOR	13h	R/ \bar{W}									OUT4_Color	00h
OUT5_COLOR	14h	R/ \bar{W}									OUT5_Color	00h
OUT6_COLOR	15h	R/ \bar{W}									OUT6_Color	00h
OUT7_COLOR	16h	R/ \bar{W}									OUT7_Color	00h
OUT8_COLOR	17h	R/ \bar{W}									OUT8_Color	00h
OUT9_COLOR	18h	R/ \bar{W}									OUT9_Color	00h
OUT10_COLOR	19h	R/ \bar{W}									OUT10_Color	00h
OUT11_COLOR	1Ah	R/ \bar{W}									OUT11_Color	00h
OUT12_COLOR	1Bh	R/ \bar{W}									OUT12_Color	00h
OUT13_COLOR	1Ch	R/ \bar{W}									OUT13_Color	00h
OUT14_COLOR	1Dh	R/ \bar{W}									OUT14_Color	00h
OUT15_COLOR	1Eh	R/ \bar{W}									OUT15_Color	00h
OUT16_COLOR	1Fh	R/ \bar{W}									OUT16_Color	00h
OUT17_COLOR	20h	R/ \bar{W}									OUT17_Color	00h
OUT18_COLOR	21h	R/ \bar{W}									OUT18_Color	00h
OUT19_COLOR	22h	R/ \bar{W}									OUT19_Color	00h
OUT20_COLOR	23h	R/ \bar{W}									OUT20_Color	00h
OUT21_COLOR	24h	R/ \bar{W}									OUT21_Color	00h
OUT22_COLOR	25h	R/ \bar{W}									OUT22_Color	00h
OUT23_COLOR	26h	R/ \bar{W}									OUT23_Color	00h
RESET	27h	W									Reset	00h

表 7-5. Access Type Codes

ACCESS TYPE	CODE	DESCRIPTION
Read Type		
R	R	Read
Write Type		
W	W	Write
Reset or Default Value		
-n		Value after reset or the default value

7.6.1 DEVICE_CONFIG0 (Address = 0h) [reset = 0h]

DEVICE_CONFIG0 is shown in 図 7-13 and described in 表 7-6.

Return to 表 7-4.

図 7-13. DEVICE_CONFIG0 Register

7	6	5	4	3	2	1	0
RESERVED	Chip_EN	RESERVED					
R/ W-0h	R/ W-0h	R/ W-0h					

表 7-6. DEVICE_CONFIG0 Register Field Descriptions

Bit	Field	Type	Reset	Description
7	RESERVED	R/ W	0h	Reserved
6	Chip_EN	R/ W	0h	1 = LP50xx enabled 0 = LP50xx not enabled
5-0	RESERVED	R/ W	0h	Reserved

7.6.2 DEVICE_CONFIG1 (Address = 1h) [reset = 3Ch]

DEVICE_CONFIG1 is shown in 図 7-14 and described in 表 7-7.

Return to 表 7-4.

図 7-14. DEVICE_CONFIG1 Register

7	6	5	4	3	2	1	0
RESERVED	Log_Scale_EN	Power_Save_EN	Auto_Incr_EN	PWM_Dithering_EN	Optional_Headroom	LED_Global Off	
R/ W-0h	R/ W-1h	R/ W-1h	R/ W-1h	R/ W-1h	R/ W-1h	R/ W-0h	R/ W-0h

表 7-7. DEVICE_CONFIG1 Register Field Descriptions

Bit	Field	Type	Reset	Description
7-6	RESERVED	R/ W	0h	Reserved
5	Log_Scale_EN	R/ W	1h	1 = Logarithmic scale dimming curve enabled 0 = Linear scale dimming curve enabled
4	Power_Save_EN	R/ W	1h	1 = Automatic power-saving mode enabled 0 = Automatic power-saving mode not enabled
3	Auto_Incr_EN	R/ W	1h	1 = Automatic increment mode enabled 0 = Automatic increment mode not enabled
2	PWM_Dithering_EN	R/ W	1h	1 = PWM dithering mode enabled 0 = PWM dithering mode not enabled
1	Max_Current_Option	R/ W	0h	1 = Output maximum current I _{MAX} = 35 mA. 0 = Output maximum current I _{MAX} = 25.5 mA.
0	LED_Global Off	R/ W	0h	1 = Shut down all LEDs 0 = Normal operation

7.6.3 LED_CONFIG0 (Address = 2h) [reset = 00h]

LED_CONFIG0 is shown in 図 7-15 and described in 表 7-8.

Return to 表 7-4.

図 7-15. LED_CONFIG0 Register

7	6	5	4	3	2	1	0
LED7_Bank_EN	LED6_Bank_EN	LED5_Bank_EN	LED4_Bank_EN	LED3_Bank_EN	LED2_Bank_EN	LED1_Bank_EN	LED0_Bank_EN
N	N	N	N	N	N	N	N

図 7-15. LED_CONFIG0 Register (続き)

R/ W-0h	R/ W-0h	R/ W-0h	R/ W-0h	R/ W-0h	R/ W-0h	R/ W-0h	R/ W-0h
---------	---------	---------	---------	---------	---------	---------	---------

表 7-8. LED_CONFIG0 Register Field Descriptions

Bit	Field	Type	Reset	Description
7	LED7_Bank_EN	R/ W	0h	1 = LED7 bank control mode enabled 0 = LED7 independent control mode enabled
6	LED6_Bank_EN	R/ W	0h	1 = LED6 bank control mode enabled 0 = LED6 independent control mode enabled
5	LED5_Bank_EN	R/ W	0h	1 = LED5 bank control mode enabled 0 = LED5 independent control mode enabled
4	LED4_Bank_EN	R/ W	0h	1 = LED4 bank control mode enabled 0 = LED4 independent control mode enabled
3	LED3_Bank_EN	R/ W	0h	1 = LED3 bank control mode enabled 0 = LED3 Independent control mode enabled
2	LED2_Bank_EN	R/ W	0h	1 = LED2 bank control mode enabled 0 = LED2 independent control mode enabled
1	LED1_Bank_EN	R/ W	0h	1 = LED1 bank control mode enabled 0 = LED1 independent control mode enabled
0	LED0_Bank_EN	R/ W	0h	1 = LED0 bank control mode enabled 0 = LED0 independent control mode enabled

7.6.4 BANK_BRIGHTNESS (Address = 3h) [reset = FFh]

BANK_BRIGHTNESS is shown in 図 7-16 and described in 表 7-9.

Return to 表 7-4.

図 7-16. BANK_BRIGHTNESS Register

7	6	5	4	3	2	1	0
Bank_Brightness							
R/ W-FFh							

表 7-9. BANK_BRIGHTNESS Register Field Descriptions

Bit	Field	Type	Reset	Description
7-0	Bank_Brightness	R/ W	FFh	FFh = 100% of full brightness ... 80h = 50% of full brightness ... 00h = 0% of full brightness

7.6.5 BANK_A_COLOR (Address = 4h) [reset = 00h]

BANK_A_COLOR is shown in 図 7-17 and described in 表 7-10.

Return to 表 7-4.

図 7-17. BANK_A_COLOR Register

7	6	5	4	3	2	1	0
Bank_A_Color							
R/ W-0h							

表 7-10. BANK_A_COLOR Register Field Descriptions

Bit	Field	Type	Reset	Description
7–0	Bank_A_Color	R/ W	0h	FFh = The color mixing percentage is 100%. ... 80h = The color mixing percentage is 50%. ... 00h = The color mixing percentage is 0%.

7.6.6 BANK_B_COLOR (Address = 5h) [reset = 00h]

BANK_B_COLOR is shown in [図 7-18](#) and described in [表 7-11](#).

Return to [表 7-4](#).

図 7-18. BANK_B_COLOR Register

7	6	5	4	3	2	1	0
Bank_B_Color							
R/ W-0h							

表 7-11. BANK_B_COLOR Register Field Descriptions

Bit	Field	Type	Reset	Description
7–0	Bank_B_Color	R/ W	0h	FFh = The color mixing percentage is 100%. ... 80h = The color mixing percentage is 50%. ... 00h = The color mixing percentage is 0%.

7.6.7 BANK_C_COLOR (Address = 6h) [reset = 00h]

BANK_C_COLOR is shown in [図 7-19](#) and described in [表 7-12](#).

Return to [表 7-4](#).

図 7-19. BANK_C_COLOR Register

7	6	5	4	3	2	1	0
Bank_C_Color							
R/ W-0h							

表 7-12. BANK_C_COLOR Register Field Descriptions

Bit	Field	Type	Reset	Description
7–0	Bank_C_Color	R/ W	0h	FFh = The color mixing percentage is 100%. ... 80h = The color mixing percentage is 50%. ... 00h = The color mixing percentage is 0%.

7.6.8 LED0_BRIGHTNESS (Address = 7h) [reset = FFh]

LED0_BRIGHTNESS is shown in [図 7-20](#) and described in [表 7-13](#).

Return to [表 7-4](#).

図 7-20. LED0_BRIGHTNESS Register

7	6	5	4	3	2	1	0
LED0_Brightness							
R/ W-FFh							

表 7-13. LED0_BRIGHTNESS Register Field Descriptions

Bit	Field	Type	Reset	Description
7–0	LED0_Brightness	R/ W	FFh	FFh = 100% of full intensity ... 80h = 50% of full intensity ... 00h = 0% of full intensity

7.6.9 LED1_BRIGHTNESS (Address = 8h) [reset = FFh]

LED1_BRIGHTNESS is shown in [図 7-21](#) and described in [表 7-14](#).

Return to [表 7-4](#).

図 7-21. LED1_BRIGHTNESS Register

7	6	5	4	3	2	1	0
LED1_Brightness							
R/ W-FFh							

表 7-14. LED1_BRIGHTNESS Register Field Descriptions

Bit	Field	Type	Reset	Description
7–0	LED1_Brightness	R/ W	FFh	FFh = 100% of full intensity ... 80h = 50% of full intensity ... 00h = 0% of full intensity

7.6.10 LED2_BRIGHTNESS (Address = 9h) [reset = FFh]

LED2_BRIGHTNESS is shown in [図 7-22](#) and described in [表 7-15](#).

Return to [表 7-4](#).

図 7-22. LED2_BRIGHTNESS Register

7	6	5	4	3	2	1	0
LED2_Brightness							
R/ W-FFh							

表 7-15. LED2_BRIGHTNESS Register Field Descriptions

Bit	Field	Type	Reset	Description
7–0	LED2_Brightness	R/ W	FFh	FFh = 100% of full intensity ... 80h = 50% of full intensity ... 00h = 0% of full intensity

7.6.11 LED3_BRIGHTNESS (Address = 0Ah) [reset = FFh]

LED3_BRIGHTNESS is shown in [図 7-23](#) and described in [表 7-16](#).

Return to [表 7-4](#).

図 7-23. LED3_BRIGHTNESS Register

7	6	5	4	3	2	1	0
LED3_Brightness							
R/ W-FFh							

表 7-16. LED3_BRIGHTNESS Register Field Descriptions

Bit	Field	Type	Reset	Description
7-0	LED3_Brightness	R/ W	FFh	FFh = 100% of full intensity ... 80h = 50% of full intensity ... 00h = 0% of full intensity

7.6.12 LED4_BRIGHTNESS (Address = 0Bh) [reset = FFh]

LED4_BRIGHTNESS is shown in [図 7-24](#) and described in [表 7-17](#).

Return to [表 7-4](#).

図 7-24. LED4_BRIGHTNESS Register

7	6	5	4	3	2	1	0
LED4_Brightness							
R/ W-FFh							

表 7-17. LED4_BRIGHTNESS Register Field Descriptions

Bit	Field	Type	Reset	Description
7-0	LED4_Brightness	R/ W	FFh	FFh = 100% of full intensity ... 80h = 50% of full intensity ... 00h = 0% of full intensity

7.6.13 LED5_BRIGHTNESS (Address = 0Ch) [reset = FFh]

LED5_BRIGHTNESS is shown in [図 7-25](#) and described in [表 7-18](#).

Return to [表 7-4](#).

図 7-25. LED5_BRIGHTNESS Register

7	6	5	4	3	2	1	0
LED5_Brightness							
R/ W-FFh							

表 7-18. LED5_BRIGHTNESS Register Field Descriptions

Bit	Field	Type	Reset	Description
7-0	LED5_Brightness	R/ W	FFh	FFh = 100% of full intensity ... 80h = 50% of full intensity ... 00h = 0% of full intensity

7.6.14 LED6_BRIGHTNESS (Address = 0Dh) [reset = FFh]

LED6_BRIGHTNESS is shown in [図 7-26](#) and described in [表 7-19](#).

Return to [表 7-4](#).

図 7-26. LED6_BRIGHTNESS Register

7	6	5	4	3	2	1	0
LED6_Brightness							
R/ W-FFh							

表 7-19. LED6_BRIGHTNESS Register Field Descriptions

Bit	Field	Type	Reset	Description
7–0	LED6_Brightness	R/ W	FFh	FFh = 100% of full intensity ... 80h = 50% of full intensity ... 00h = 0% of full intensity

7.6.15 LED7_BRIGHTNESS (Address = 0Eh) [reset = FFh]

LED7_BRIGHTNESS is shown in 図 7-27 and described in 表 7-20.

Return to 表 7-4.

図 7-27. LED7_BRIGHTNESS Register

7	6	5	4	3	2	1	0
LED7_Brightness							
R/ W-FFh							

表 7-20. LED7_BRIGHTNESS Register Field Descriptions

Bit	Field	Type	Reset	Description
7–0	LED7_Brightness	R/ W	FFh	FFh = 100% of full intensity ... 80h = 50% of full intensity ... 00h = 0% of full intensity

7.6.16 OUT0_COLOR (Address = 0Fh) [reset = 00h]

OUT0_COLOR is shown in 図 7-28 and described in 表 7-21.

Return to 表 7-4.

図 7-28. OUT0_COLOR Register

7	6	5	4	3	2	1	0
OUT0_Color							
R/ W-00h							

表 7-21. OUT0_COLOR Register Field Descriptions

Bit	Field	Type	Reset	Description
7–0	OUT0_Color	R/ W	00h	FFh = The color mixing percentage is 100%. ... 80h = The color mixing percentage is 50%. ... 00h = The color mixing percentage is 0%.

7.6.17 OUT1_COLOR (Address = 10h) [reset = 00h]

OUT1_COLOR is shown in 図 7-29 and described in 表 7-22.

Return to 表 7-4.

図 7-29. OUT1_COLOR Register

7	6	5	4	3	2	1	0
OUT1_Color							
R/ W-00h							

表 7-22. OUT1_COLOR Register Field Descriptions

Bit	Field	Type	Reset	Description
7–0	OUT1_Color	R/ W	00h	FFh = The color mixing percentage is 100%. ... 80h =The color mixing percentage is 50%. ... 00h = The color mixing percentage is 0%.

7.6.18 OUT2_COLOR (Address = 11h) [reset = 00h]

OUT2_COLOR is shown in [図 7-30](#) and described in [表 7-23](#).

Return to [表 7-4](#).

図 7-30. OUT2_COLOR Register

7	6	5	4	3	2	1	0
OUT2_Color							
R/ W-00h							

表 7-23. OUT2_COLOR Register Field Descriptions

Bit	Field	Type	Reset	Description
7–0	OUT2_Color	R/ W	00h	FFh = The color mixing percentage is 100%. ... 80h =The color mixing percentage is 50%. ... 00h = The color mixing percentage is 0%.

7.6.19 OUT3_COLOR (Address = 12h) [reset = 00h]

OUT3_COLOR is shown in [図 7-31](#) and described in [表 7-24](#).

Return to [表 7-4](#).

図 7-31. OUT3_COLOR Register

7	6	5	4	3	2	1	0
OUT3_Color							
R/ W-00h							

表 7-24. OUT3_COLOR Register Field Descriptions

Bit	Field	Type	Reset	Description
7–0	OUT3_Color	R/ W	00h	FFh = The color mixing percentage is 100%. ... 80h =The color mixing percentage is 50%. ... 00h = The color mixing percentage is 0%.

7.6.20 OUT4_COLOR (Address = 13h) [reset = 00h]

OUT4_COLOR is shown in [図 7-32](#) and described in [表 7-25](#).

Return to [表 7-4](#).

図 7-32. OUT4_COLOR Register

7	6	5	4	3	2	1	0
OUT4_Color							
R/ W-00h							

表 7-25. OUT4_COLOR Register Field Descriptions

Bit	Field	Type	Reset	Description
7–0	OUT4_Color	R/ W	00h	FFh = The color mixing percentage is 100%. ... 80h =The color mixing percentage is 50%. ... 00h = The color mixing percentage is 0%.

7.6.21 OUT5_COLOR (Address = 14h) [reset = 00h]

OUT5_COLOR is shown in 図 7-33 and described in 表 7-26.

Return to 表 7-4.

図 7-33. OUT5_COLOR Register

7	6	5	4	3	2	1	0
OUT5_Color							
R/ W-00h							

表 7-26. OUT5_COLOR Register Field Descriptions

Bit	Field	Type	Reset	Description
7–0	OUT5_Color	R/ W	00h	FFh = The color mixing percentage is 100%. ... 80h =The color mixing percentage is 50%. ... 00h = The color mixing percentage is 0%.

7.6.22 OUT6_COLOR (Address = 15h) [reset = 00h]

OUT6_COLOR is shown in 図 7-34 and described in 表 7-27.

Return to 表 7-4.

図 7-34. OUT6_COLOR Register

7	6	5	4	3	2	1	0
OUT6_Color							
R/ W-00h							

表 7-27. OUT6_COLOR Register Field Descriptions

Bit	Field	Type	Reset	Description
7–0	OUT6_Color	R/ W	00h	FFh = The color mixing percentage is 100%. ... 80h =The color mixing percentage is 50%. ... 00h = The color mixing percentage is 0%.

7.6.23 OUT7_COLOR (Address = 16h) [reset = 00h]

OUT7_COLOR is shown in 図 7-35 and described in 表 7-28.

Return to 表 7-4.

図 7-35. OUT7_COLOR Register

7	6	5	4	3	2	1	0
OUT7_Color							
R/ W-00h							

表 7-28. OUT7_COLOR Register Field Descriptions

Bit	Field	Type	Reset	Description
7–0	OUT7_Color	R/ W	00h	FFh = The color mixing percentage is 100%. ... 80h =The color mixing percentage is 50%. ... 00h = The color mixing percentage is 0%.

7.6.24 OUT8_COLOR (Address = 17h) [reset = 00h]

OUT8_COLOR is shown in [図 7-36](#) and described in [表 7-29](#).

Return to [表 7-4](#).

図 7-36. OUT8_COLOR Register

7	6	5	4	3	2	1	0
OUT8_Color							
R/ W-00h							

表 7-29. OUT8_COLOR Register Field Descriptions

Bit	Field	Type	Reset	Description
7–0	OUT8_Color	R/ W	00h	FFh = The color mixing percentage is 100%. ... 80h =The color mixing percentage is 50%. ... 00h = The color mixing percentage is 0%.

7.6.25 OUT9_COLOR (Address = 18h) [reset = 00h]

OUT9_COLOR is shown in [図 7-37](#) and described in [表 7-30](#).

Return to [表 7-4](#).

図 7-37. OUT9_COLOR Register

7	6	5	4	3	2	1	0
OUT9_Color							
R/ W-00h							

表 7-30. OUT9_COLOR Register Field Descriptions

Bit	Field	Type	Reset	Description
7–0	OUT9_Color	R/ W	00h	FFh = The color mixing percentage is 100%. ... 80h =The color mixing percentage is 50%. ... 00h = The color mixing percentage is 0%.

7.6.26 OUT10_COLOR (Address = 19h) [reset = 00h]

OUT10_COLOR is shown in [図 7-38](#) and described in [表 7-31](#).

Return to [表 7-4](#).

図 7-38. OUT10_COLOR Register

7	6	5	4	3	2	1	0
OUT10_Color							
R/ W-00h							

表 7-31. OUT10_COLOR Register Field Descriptions

Bit	Field	Type	Reset	Description
7–0	OUT10_Color	R/ W	00h	FFh = The color mixing percentage is 100%. ... 80h =The color mixing percentage is 50%. ... 00h = The color mixing percentage is 0%.

7.6.27 OUT11_COLOR (Address = 1Ah) [reset = 00h]

OUT11_COLOR is shown in 図 7-39 and described in 表 7-32.

Return to 表 7-4.

図 7-39. OUT11_COLOR Register

7	6	5	4	3	2	1	0
OUT11_Color							
R/ W-00h							

表 7-32. OUT11_COLOR Register Field Descriptions

Bit	Field	Type	Reset	Description
7–0	OUT11_Color	R/ W	00h	FFh = The color mixing percentage is 100%. ... 80h =The color mixing percentage is 50%. ... 00h = The color mixing percentage is 0%.

7.6.28 OUT12_COLOR (Address = 1Bh) [reset = 00h]

OUT12_COLOR is shown in 図 7-40 and described in 表 7-33.

Return to 表 7-4.

図 7-40. OUT12_COLOR Register

7	6	5	4	3	2	1	0
OUT12_Color							
R/ W-00h							

表 7-33. OUT12_COLOR Register Field Descriptions

Bit	Field	Type	Reset	Description
7–0	OUT12_Color	R/ W	00h	FFh = The color mixing percentage is 100%. ... 80h =The color mixing percentage is 50%. ... 00h = The color mixing percentage is 0%.

7.6.29 OUT13_COLOR (Address = 1Ch) [reset = 00h]

OUT13_COLOR is shown in 図 7-41 and described in 表 7-34.

Return to 表 7-4.

図 7-41. OUT13_COLOR Register

7	6	5	4	3	2	1	0
OUT13_Color							
R/ W-00h							

表 7-34. OUT13_COLOR Register Field Descriptions

Bit	Field	Type	Reset	Description
7–0	OUT13_Color	R/ W	00h	FFh = The color mixing percentage is 100%. ... 80h =The color mixing percentage is 50%. ... 00h = The color mixing percentage is 0%.

7.6.30 OUT14_COLOR (Address = 1Dh) [reset = 00h]

OUT14_COLOR is shown in [図 7-42](#) and described in [表 7-35](#).

Return to [表 7-4](#).

図 7-42. OUT14_COLOR Register

7	6	5	4	3	2	1	0
OUT14_Color							
R/ W-00h							

表 7-35. OUT14_COLOR Register Field Descriptions

Bit	Field	Type	Reset	Description
7–0	OUT14_Color	R/ W	00h	FFh = The color mixing percentage is 100%. ... 80h =The color mixing percentage is 50%. ... 00h = The color mixing percentage is 0%.

7.6.31 OUT15_COLOR (Address = 1Eh) [reset = 00h]

OUT15_COLOR is shown in [図 7-43](#) and described in [表 7-36](#).

Return to [表 7-4](#).

図 7-43. OUT15_COLOR Register

7	6	5	4	3	2	1	0
OUT15_Color							
R/ W-00h							

表 7-36. OUT15_COLOR Register Field Descriptions

Bit	Field	Type	Reset	Description
7–0	OUT15_Color	R/ W	00h	FFh = The color mixing percentage is 100%. ... 80h =The color mixing percentage is 50%. ... 00h = The color mixing percentage is 0%.

7.6.32 OUT16_COLOR (Address = 1Fh) [reset = 00h]

OUT16_COLOR is shown in [図 7-44](#) and described in [表 7-37](#).

Return to [表 7-4](#).

図 7-44. OUT16_COLOR Register

7	6	5	4	3	2	1	0
OUT16_Color							
R/ W-00h							

表 7-37. OUT16_COLOR Register Field Descriptions

Bit	Field	Type	Reset	Description
7–0	OUT16_Color	R/ W	00h	FFh = The color mixing percentage is 100%. ... 80h =The color mixing percentage is 50%. ... 00h = The color mixing percentage is 0%.

7.6.33 OUT17_COLOR (Address = 20h) [reset = 00h]

OUT17_COLOR is shown in 図 7-45 and described in 表 7-38.

Return to 表 7-4.

図 7-45. OUT17_COLOR Register

7	6	5	4	3	2	1	0
OUT17_Color							
R/ W-00h							

表 7-38. OUT17_COLOR Register Field Descriptions

Bit	Field	Type	Reset	Description
7–0	OUT17_Color	R/ W	00h	FFh = The color mixing percentage is 100%. ... 80h =The color mixing percentage is 50%. ... 00h = The color mixing percentage is 0%.

7.6.34 OUT18_COLOR (Address = 21h) [reset = 00h]

OUT18_COLOR is shown in 図 7-46 and described in 表 7-39.

Return to 表 7-4.

図 7-46. OUT18_COLOR Register

7	6	5	4	3	2	1	0
OUT18_Color							
R/ W-00h							

表 7-39. OUT18_COLOR Register Field Descriptions

Bit	Field	Type	Reset	Description
7–0	OUT18_Color	R/ W	00h	FFh = The color mixing percentage is 100%. ... 80h =The color mixing percentage is 50%. ... 00h = The color mixing percentage is 0%.

7.6.35 OUT19_COLOR (Address = 22h) [reset = 00h]

OUT19_COLOR is shown in 図 7-47 and described in 表 7-40.

Return to 表 7-4.

図 7-47. OUT19_COLOR Register

7	6	5	4	3	2	1	0
OUT19_Color							
R/ W-00h							

表 7-40. OUT19_COLOR Register Field Descriptions

Bit	Field	Type	Reset	Description
7–0	OUT19_Color	R/ W	00h	FFh = The color mixing percentage is 100%. ... 80h =The color mixing percentage is 50%. ... 00h = The color mixing percentage is 0%.

7.6.36 OUT20_COLOR (Address = 23h) [reset = 00h]

OUT20_COLOR is shown in [図 7-48](#) and described in [表 7-41](#).

Return to [表 7-4](#).

図 7-48. OUT20_COLOR Register

7	6	5	4	3	2	1	0
OUT20_Color							
R/ W-00h							

表 7-41. OUT20_COLOR Register Field Descriptions

Bit	Field	Type	Reset	Description
7–0	OUT20_Color	R/ W	00h	FFh = The color mixing percentage is 100%. ... 80h =The color mixing percentage is 50%. ... 00h = The color mixing percentage is 0%.

7.6.37 OUT21_COLOR (Address = 24h) [reset = 00h]

OUT21_COLOR is shown in [図 7-49](#) and described in [表 7-42](#).

Return to [表 7-4](#).

図 7-49. OUT21_COLOR Register

7	6	5	4	3	2	1	0
OUT21_Color							
R/ W-00h							

表 7-42. OUT21_COLOR Register Field Descriptions

Bit	Field	Type	Reset	Description
7–0	OUT21_Color	R/ W	00h	FFh = The color mixing percentage is 100%. ... 80h =The color mixing percentage is 50%. ... 00h = The color mixing percentage is 0%.

7.6.38 OUT22_COLOR (Address = 25h) [reset = 00h]

OUT22_COLOR is shown in [図 7-50](#) and described in [表 7-43](#).

Return to [表 7-4](#).

図 7-50. OUT22_COLOR Register

7	6	5	4	3	2	1	0
OUT22_Color							
R/ W-00h							

表 7-43. OUT22_COLOR Register Field Descriptions

Bit	Field	Type	Reset	Description
7–0	OUT22_Color	R/ W	00h	FFh = The color mixing percentage is 100%. ... 80h =The color mixing percentage is 50%. ... 00h = The color mixing percentage is 0%.

7.6.39 OUT23_COLOR (Address = 26h) [reset = 00h]

OUT23_COLOR is shown in 図 7-51 and described in 表 7-44.

Return to 表 7-4.

図 7-51. OUT23_COLOR Register

7	6	5	4	3	2	1	0
OUT23_Color							
R/ W-00h							

表 7-44. OUT23_COLOR Register Field Descriptions

Bit	Field	Type	Reset	Description
7–0	OUT23_Color	R/ W	00h	FFh = The color mixing percentage is 100%. ... 80h =The color mixing percentage is 50%. ... 00h = The color mixing percentage is 0%.

7.6.40 RESET (Address = 27h) [reset = 00h]

RESET is shown in 図 7-52 and described in 表 7-45.

Return to 表 7-4.

図 7-52. RESET Register

7	6	5	4	3	2	1	0
Reset							
W-00h							

表 7-45. OUT14_COLOR Register Field Descriptions

Bit	Field	Type	Reset	Description
7–0	Reset	W	00h	FFh = Reset all the registers to default value.

8 Application and Implementation

注

以下のアプリケーション情報は、TI の製品仕様に含まれるものではなく、TI ではその正確性または完全性を保証いたしません。個々の目的に対する製品の適合性については、お客様の責任で判断していただくこととなります。お客様は自身の設計実装を検証しテストすることで、システムの機能を確認する必要があります。

8.1 Application Information

The LP50xx device is an 18- or 24-channel constant-current-sink LED driver. The LP50xx device improves the user experience in color mixing and intensity control, for both live effects and coding effort. The optimized performance for RGB LEDs makes it a good choice for human-machine interaction applications.

8.2 Typical Application

The LP50xx design supports up to four devices in parallel with different configurations on the ADDR0 and ADDR1 pins.



図 8-1. Driving Dual LP5024 Application Example

8.2.1 Design Requirements

Set the LED current to 15mA using the R_{IREF} resistor.

8.2.2 Detailed Design Procedure

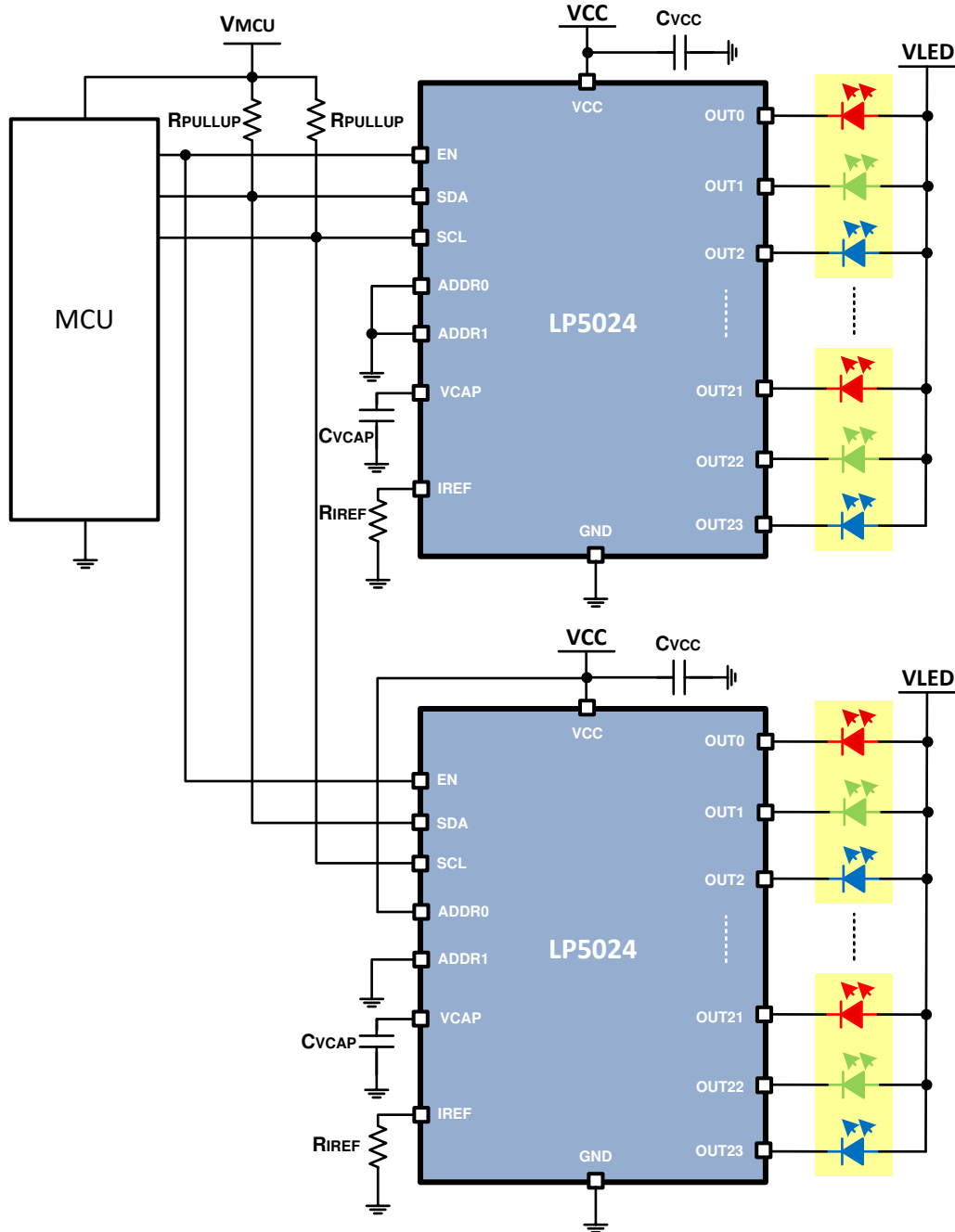
LP50xx scales up the reference current (I_{REF}) set by the external resistor (R_{IREF}) to sink the output current (I_{OUT}) at each output port. The following formula can be used to calculate the external resistor (R_{IREF}):

$$R_{IREF} = K_{IREF} \times \frac{V_{IREF}}{I_{SET}} \quad (2)$$

The SCL and SDA lines must each have a pullup resistor placed somewhere on the line (the pullup resistors are normally located on the bus master). In typical applications, values of 1.8k Ω to 4.7k Ω are used.

VCAP is internal LDO output pin. This pin must be connected through a 1 μ F capacitor to GND. Place the capacitor as close to the device as possible.

TI recommends having a 1 μ F capacitor between VCC and GND to ensure proper operation. Place the capacitor as close to the device as possible.

8.2.3 Application Curves

The test condition for Figure 9-2 is that the testing is under bank control, using the following register values: 0x02 (0xFF), 0x04 (0xA0), 0x05 (0xA0), 0x06 (0xA0).

The test condition for Figure 9-2 is that the testing is under bank control, using the following register values: 0x02 (0xFF), 0x04 (0x10), 0x05 (0x10), 0x06 (0x10).

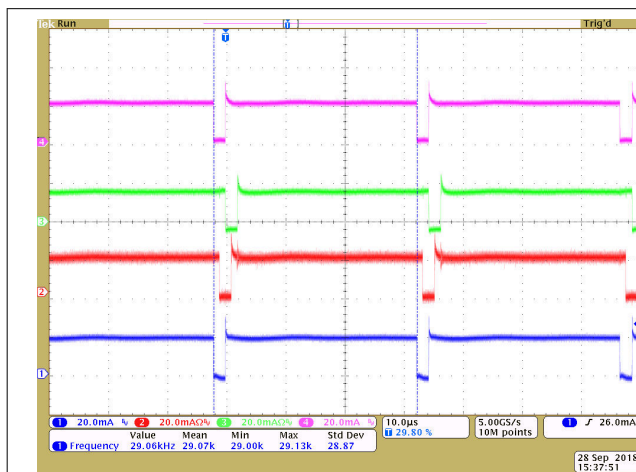

8-2. Current Waveform of OUT0, OUT1, OUT2 and OUT3

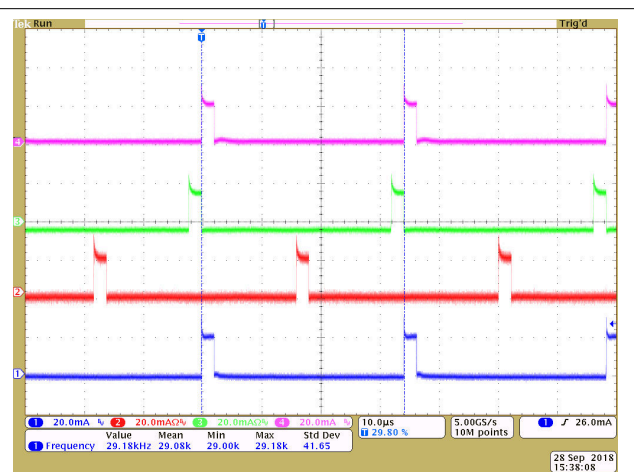

8-3. Current Waveform of OUT0, OUT1, OUT2 and OUT3

8.3 Power Supply Recommendations

The device is designed to operate from a V_{VCC} input-voltage supply range between 2.7V and 5.5V. This input supply must be well-regulated and able to withstand maximum input current and maintain stable voltage without voltage drop even in a load-transition condition (start-up or rapid intensity change). The resistance of the input supply rail must be low enough that the input-current transient does not cause a drop below a 2.7V level in the LP50xx V_{VCC} supply voltage.

8.4 Layout

8.4.1 Layout Guidelines

To prevent thermal shutdown, the junction temperature, T_J , must be less than $T_{(TSD)}$. If the voltage drop across the output channels is high, the device power dissipation can be large. The LP50xx device has very good thermal performance because of the thermal pad design; however, the PCB layout is also very important to ensure that the device has good thermal performance. Good PCB design can optimize heat transfer, which is essential for the long-term reliability of the device.

Use the following guidelines when designing the device layout:

- Place the C_{VCAP} , C_{VCC} and R_{IREF} as close to the device as possible. Also, TI recommends to put the ground plane as 8-4, 8-5 and 8-6.

- Maximize the copper coverage on the PCB to increase the thermal conductivity of the board. The major heat flow path from the package to the ambient is through copper on the PCB. Maximum copper density is extremely important when no heat sinks are attached to the PCB on the other side from the package.
- Add as many thermal vias as possible directly under the package ground pad to optimize the thermal conductivity of the board.
- Use either plated-shut or plugged and capped vias for all the thermal vias on both sides of the board to prevent solder voids.

8.4.2 Layout Examples

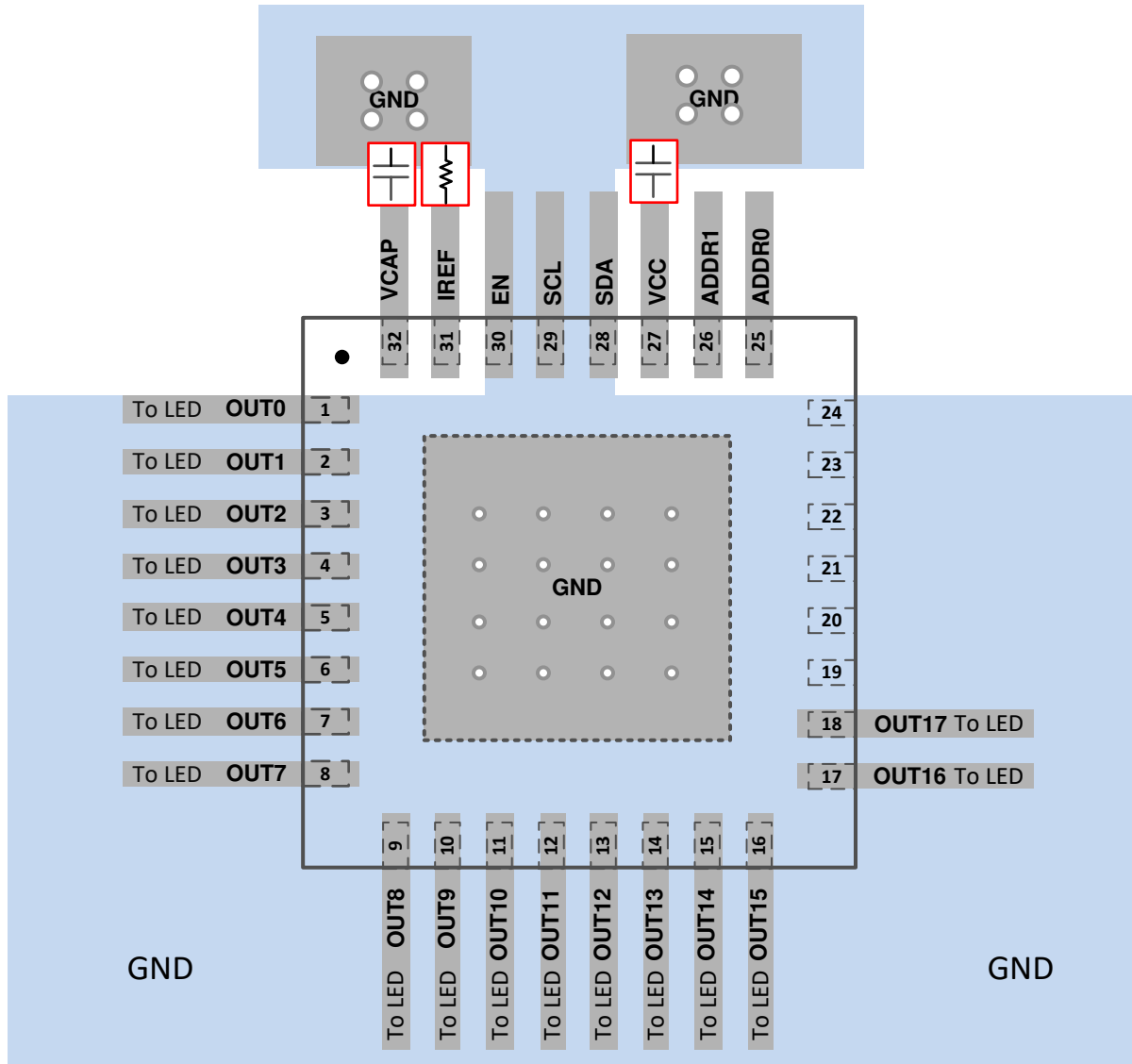

8-4. LP5018 VQFN Layout Example

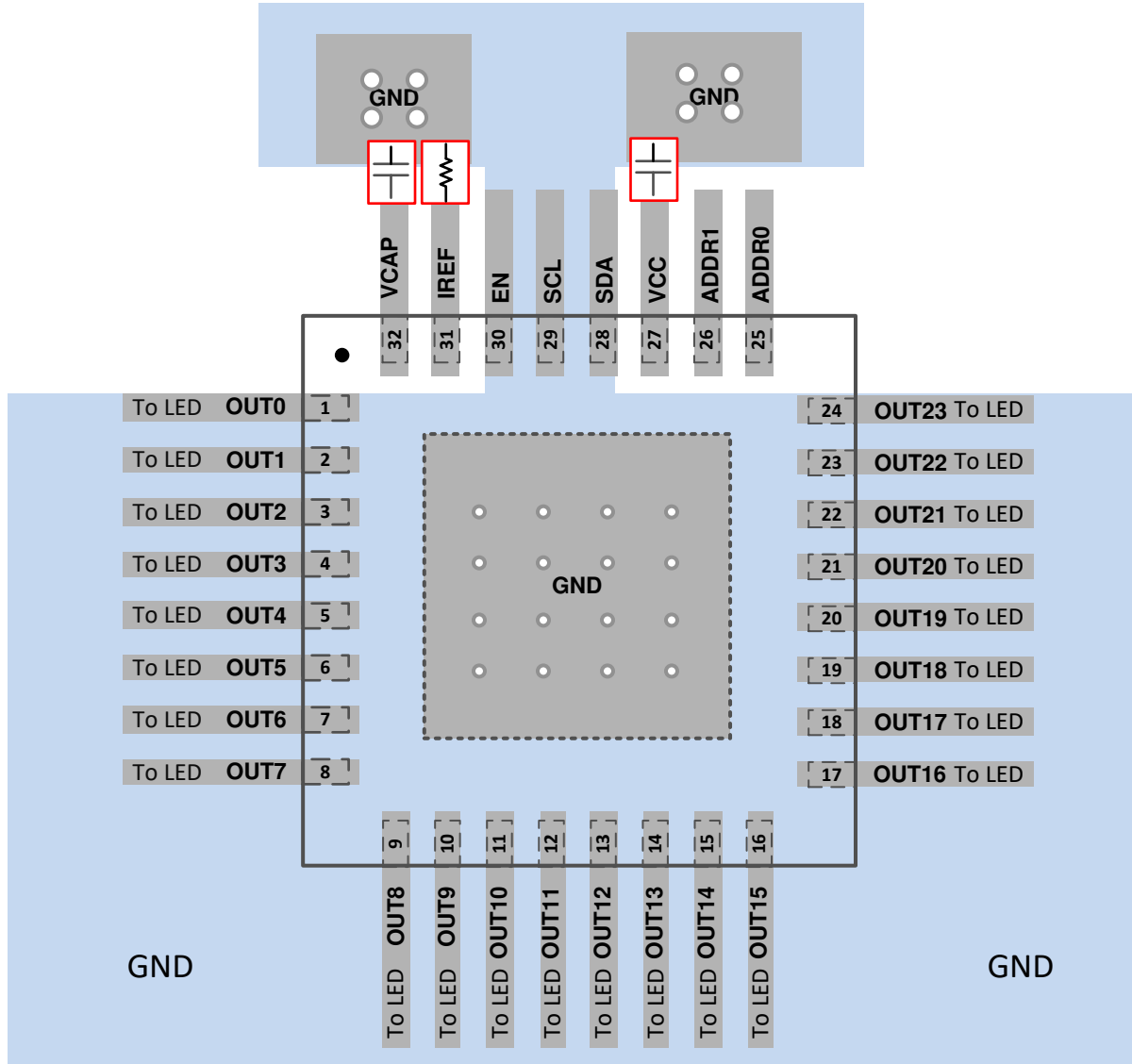

8-5. LP5024 VQFN Layout Example



図 8-6. LP5018 VSSOP Layout Example for Single Layer PCB

9 Device and Documentation Support

9.1 Related Links

The table below lists quick access links. Categories include technical documents, support and community resources, tools and software, and quick access to order now.

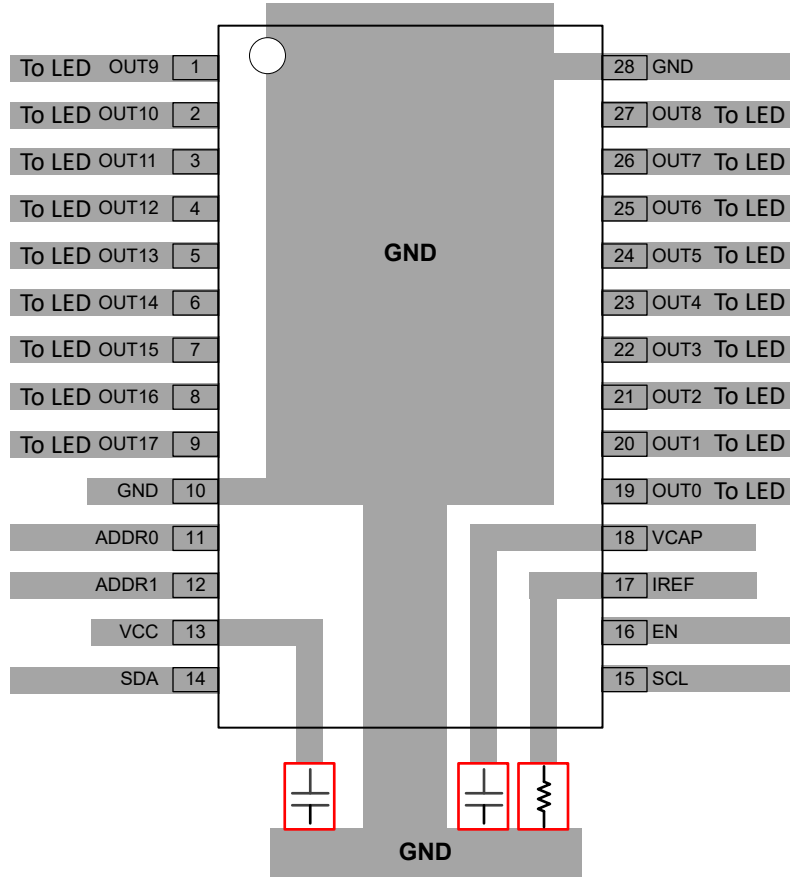
表 9-1. Related Links

PARTS	PRODUCT FOLDER	ORDER NOW	TECHNICAL DOCUMENTS	TOOLS & SOFTWARE	SUPPORT & COMMUNITY
LP5018	Click here	Click here	Click here	Click here	Click here
LP5024	Click here	Click here	Click here	Click here	Click here

9.2 ドキュメントの更新通知を受け取る方法

ドキュメントの更新についての通知を受け取るには、www.tij.co.jp のデバイス製品フォルダを開いてください。[通知] をクリックして登録すると、変更されたすべての製品情報に関するダイジェストを毎週受け取ることができます。変更の詳細については、改訂されたドキュメントに含まれている改訂履歴をご覧ください。

9.3 サポート・リソース

テキサス・インスツルメンツ E2E™ サポート・フォーラムは、エンジニアが検証済みの回答と設計に関するヒントをエキスパートから迅速かつ直接得ることができる場所です。既存の回答を検索したり、独自の質問をしたりすることで、設計に必要な支援を迅速に得ることができます。

リンクされているコンテンツは、各寄稿者により「現状のまま」提供されるものです。これらはテキサス・インスツルメンツの仕様を構成するものではなく、必ずしもテキサス・インスツルメンツの見解を反映したものではありません。テキサス・インスツルメンツの[使用条件](#)を参照してください。

9.4 Trademarks

テキサス・インスツルメンツ E2E™ is a trademark of Texas Instruments.

すべての商標は、それぞれの所有者に帰属します。

9.5 静電気放電に関する注意事項



この IC は、ESD によって破損する可能性があります。テキサス・インスツルメンツは、IC を取り扱う際には常に適切な注意を払うことを推奨します。正しい取り扱いおよび設置手順に従わない場合、デバイスを破損するおそれがあります。

ESD による破損は、わずかな性能低下からデバイスの完全な故障まで多岐にわたります。精密な IC の場合、パラメータがわずかに変化するだけで公表されている仕様から外れる可能性があるため、破損が発生しやすくなっています。

9.6 用語集

[テキサス・インスツルメンツ用語集](#)

この用語集には、用語や略語の一覧および定義が記載されています。

10 Revision History

資料番号末尾の英字は改訂を表しています。その改訂履歴は英語版に準じています。

Changes from Revision B (October 2018) to Revision C (July 2024)	Page
• ドキュメント全体にわたって表、図、相互参照の採番方法を更新.....	1
• LP5018 VSSOP (28) パッケージを追加.....	1
• Added pin configuration image for LP5018 VSSOP.....	4
• Added LP5018 VSSOP thermal information.....	7
• Updated Bank Number and LED Number Assignment.....	15
• Updated description of OUTX_COLOR registers throughout.....	23
• Updated the description in 表 7-21 through 表 7-44	31
• Removed the last sentence in the <i>Layout Guidelines</i> section.....	42
• Added LP5018 VSSOP layout example	43

Changes from Revision A (October 2018) to Revision B (October 2018)	Page
• Added % after 100 in Parameter for I _{ERR_DD} and I _{ERR_CC} under OUTPUT STAGE.....	8
• Changed value of "K _{IREF} = 100" to "K _{IREF} = 105"	17

Changes from Revision * (October 2018) to Revision A (October 2018)	Page
• 初版リリース.....	1

11 Mechanical, Packaging, and Orderable Information

The following pages include mechanical, packaging, and orderable information. This information is the most-current data available for the designated devices. This data is subject to change without notice and without revision of this document. For browser-based versions of this data sheet, see the left-hand navigation pane.

重要なお知らせと免責事項

テキサス・インスツルメンツは、技術データと信頼性データ (データシートを含みます)、設計リソース (リファレンス デザインを含みます)、アプリケーションや設計に関する各種アドバイス、Web ツール、安全性情報、その他のリソースを、欠陥が存在する可能性のある「現状のまま」提供しており、商品性および特定目的に対する適合性の黙示保証、第三者の知的財産権の非侵害保証を含むいかなる保証も、明示的または黙示的にかかわらず拒否します。

これらのリソースは、テキサス・インスツルメンツ製品を使用する設計の経験を積んだ開発者への提供を意図したものです。(1) お客様のアプリケーションに適した テキサス・インスツルメンツ製品の選定、(2) お客様のアプリケーションの設計、検証、試験、(3) お客様のアプリケーションに該当する各種規格や、その他のあらゆる安全性、セキュリティ、規制、または他の要件への確実な適合に関する責任を、お客様のみが単独で負うものとします。

上記の各種リソースは、予告なく変更される可能性があります。これらのリソースは、リソースで説明されている テキサス・インスツルメンツ製品を使用するアプリケーションの開発の目的でのみ、テキサス・インスツルメンツはその使用をお客様に許諾します。これらのリソースに関して、他の目的で複製することや掲載することは禁止されています。テキサス・インスツルメンツや第三者の知的財産権のライセンスが付与されている訳ではありません。お客様は、これらのリソースを自身で使用した結果発生するあらゆる申し立て、損害、費用、損失、責任について、テキサス・インスツルメンツおよびその代理人を完全に補償するものとし、テキサス・インスツルメンツは一切の責任を拒否します。

テキサス・インスツルメンツの製品は、[テキサス・インスツルメンツの販売条件](#)、または [ti.com](https://www.ti.com) やかかる テキサス・インスツルメンツ製品の関連資料などのいずれかを通じて提供する適用可能な条項の下で提供されています。テキサス・インスツルメンツがこれらのリソースを提供することは、適用されるテキサス・インスツルメンツの保証または他の保証の放棄の拡大や変更を意味するものではありません。

お客様がいかなる追加条項または代替条項を提案した場合でも、テキサス・インスツルメンツはそれらに異議を唱え、拒否します。

郵送先住所: Texas Instruments, Post Office Box 655303, Dallas, Texas 75265

Copyright © 2024, Texas Instruments Incorporated

PACKAGING INFORMATION

Orderable Device	Status (1)	Package Type	Package Drawing	Pins	Package Qty	Eco Plan (2)	Lead finish/ Ball material (6)	MSL Peak Temp (3)	Op Temp (°C)	Device Marking (4/5)	Samples
LP5018DGSR	ACTIVE	VSSOP	DGS	28	5000	RoHS & Green	NIPDAU	Level-2-260C-1 YEAR	-40 to 125	LP5018	Samples
LP5018RSMR	ACTIVE	VQFN	RSM	32	3000	RoHS & Green	NIPDAU NIPDAUAG	Level-2-260C-1 YEAR	-40 to 125	LP 5018	Samples
LP5024RSMR	ACTIVE	VQFN	RSM	32	3000	RoHS & Green	NIPDAU NIPDAUAG	Level-2-260C-1 YEAR	-40 to 85	LP 5024	Samples

(1) The marketing status values are defined as follows:

ACTIVE: Product device recommended for new designs.

LIFEBUY: TI has announced that the device will be discontinued, and a lifetime-buy period is in effect.

NRND: Not recommended for new designs. Device is in production to support existing customers, but TI does not recommend using this part in a new design.

PREVIEW: Device has been announced but is not in production. Samples may or may not be available.

OBSELETE: TI has discontinued the production of the device.

(2) **RoHS:** TI defines "RoHS" to mean semiconductor products that are compliant with the current EU RoHS requirements for all 10 RoHS substances, including the requirement that RoHS substance do not exceed 0.1% by weight in homogeneous materials. Where designed to be soldered at high temperatures, "RoHS" products are suitable for use in specified lead-free processes. TI may reference these types of products as "Pb-Free".

RoHS Exempt: TI defines "RoHS Exempt" to mean products that contain lead but are compliant with EU RoHS pursuant to a specific EU RoHS exemption.

Green: TI defines "Green" to mean the content of Chlorine (Cl) and Bromine (Br) based flame retardants meet JS709B low halogen requirements of <=1000ppm threshold. Antimony trioxide based flame retardants must also meet the <=1000ppm threshold requirement.

(3) MSL, Peak Temp. - The Moisture Sensitivity Level rating according to the JEDEC industry standard classifications, and peak solder temperature.

(4) There may be additional marking, which relates to the logo, the lot trace code information, or the environmental category on the device.

(5) Multiple Device Markings will be inside parentheses. Only one Device Marking contained in parentheses and separated by a "-" will appear on a device. If a line is indented then it is a continuation of the previous line and the two combined represent the entire Device Marking for that device.

(6) Lead finish/Ball material - Orderable Devices may have multiple material finish options. Finish options are separated by a vertical ruled line. Lead finish/Ball material values may wrap to two lines if the finish value exceeds the maximum column width.

Important Information and Disclaimer:The information provided on this page represents TI's knowledge and belief as of the date that it is provided. TI bases its knowledge and belief on information provided by third parties, and makes no representation or warranty as to the accuracy of such information. Efforts are underway to better integrate information from third parties. TI has taken and continues to take reasonable steps to provide representative and accurate information but may not have conducted destructive testing or chemical analysis on incoming materials and chemicals. TI and TI suppliers consider certain information to be proprietary, and thus CAS numbers and other limited information may not be available for release.

In no event shall TI's liability arising out of such information exceed the total purchase price of the TI part(s) at issue in this document sold by TI to Customer on an annual basis.

TAPE AND REEL INFORMATION

QUADRANT ASSIGNMENTS FOR PIN 1 ORIENTATION IN TAPE

*All dimensions are nominal

Device	Package Type	Package Drawing	Pins	SPQ	Reel Diameter (mm)	Reel Width W1 (mm)	A0 (mm)	B0 (mm)	K0 (mm)	P1 (mm)	W (mm)	Pin1 Quadrant
LP5018RSMR	VQFN	RSM	32	3000	330.0	12.4	4.25	4.25	1.15	8.0	12.0	Q2
LP5024RSMR	VQFN	RSM	32	3000	330.0	12.4	4.25	4.25	1.15	8.0	12.0	Q2

TAPE AND REEL BOX DIMENSIONS

*All dimensions are nominal

Device	Package Type	Package Drawing	Pins	SPQ	Length (mm)	Width (mm)	Height (mm)
LP5018RSMR	VQFN	RSM	32	3000	367.0	367.0	35.0
LP5024RSMR	VQFN	RSM	32	3000	367.0	367.0	35.0

GENERIC PACKAGE VIEW

RSM 32

VQFN - 1 mm max height

4 x 4, 0.4 mm pitch

PLASTIC QUAD FLATPACK - NO LEAD

This image is a representation of the package family, actual package may vary.
Refer to the product data sheet for package details.



4224982/A

RSM0032B



PACKAGE OUTLINE

VQFN - 1 mm max height

PLASTIC QUAD FLATPACK - NO LEAD



NOTES:

1. All linear dimensions are in millimeters. Any dimensions in parenthesis are for reference only. Dimensioning and tolerancing per ASME Y14.5M.
2. This drawing is subject to change without notice.
3. The package thermal pad must be soldered to the printed circuit board for thermal and mechanical performance.

EXAMPLE BOARD LAYOUT

RSM0032B

VQFN - 1 mm max height

PLASTIC QUAD FLATPACK - NO LEAD



LAND PATTERN EXAMPLE
EXPOSED METAL SHOWN
SCALE:20X



SOLDER MASK DETAILS

4219108/B 08/2019

NOTES: (continued)

4. This package is designed to be soldered to a thermal pad on the board. For more information, see Texas Instruments literature number SLUA271 (www.ti.com/lit/sluea271).
5. Vias are optional depending on application, refer to device data sheet. If any vias are implemented, refer to their locations shown on this view. It is recommended that vias under paste be filled, plugged or tented.

EXAMPLE STENCIL DESIGN

RSM0032B

VQFN - 1 mm max height

PLASTIC QUAD FLATPACK - NO LEAD



SOLDER PASTE EXAMPLE
BASED ON 0.1 mm THICK STENCIL

EXPOSED PAD 33:
77% PRINTED SOLDER COVERAGE BY AREA UNDER PACKAGE
SCALE:20X

4219108/B 08/2019

NOTES: (continued)

6. Laser cutting apertures with trapezoidal walls and rounded corners may offer better paste release. IPC-7525 may have alternate design recommendations.

DGS0028A



PACKAGE OUTLINE

VSSOP - 1.1 mm max height

SMALL OUTLINE PACKAGE

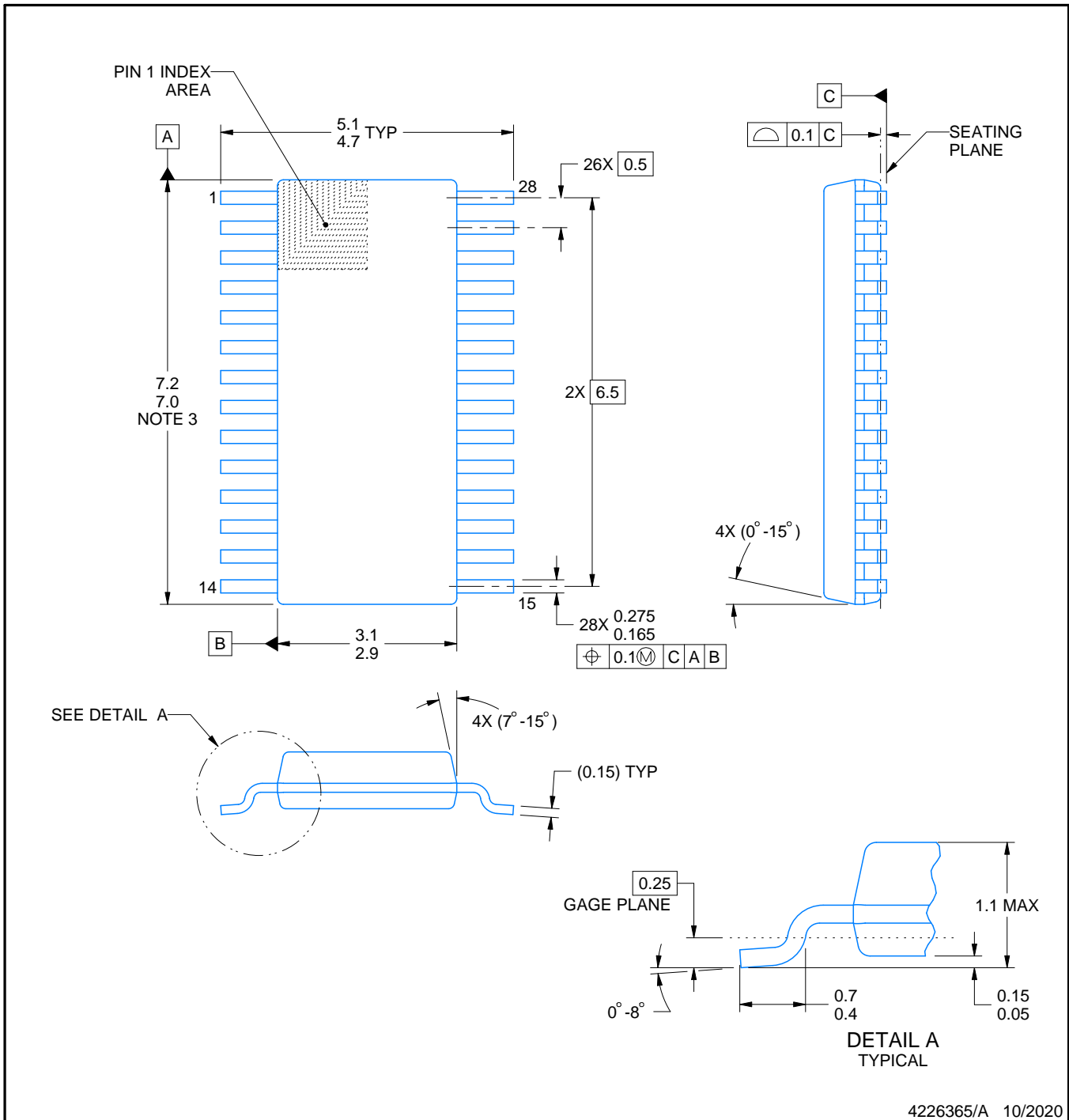

4226365/A 10/2020

NOTES:

PowerPAD is a trademark of Texas Instruments.

1. All linear dimensions are in millimeters. Any dimensions in parenthesis are for reference only. Dimensioning and tolerancing per ASME Y14.5M.
2. This drawing is subject to change without notice.
3. This dimension does not include mold flash, protrusions, or gate burrs. Mold flash, protrusions, or gate burrs shall not exceed 0.15 mm per side.
4. No JEDEC registration as of September 2020.
5. Features may differ or may not be present.

EXAMPLE BOARD LAYOUT

DGS0028A

VSSOP - 1.1 mm max height

SMALL OUTLINE PACKAGE

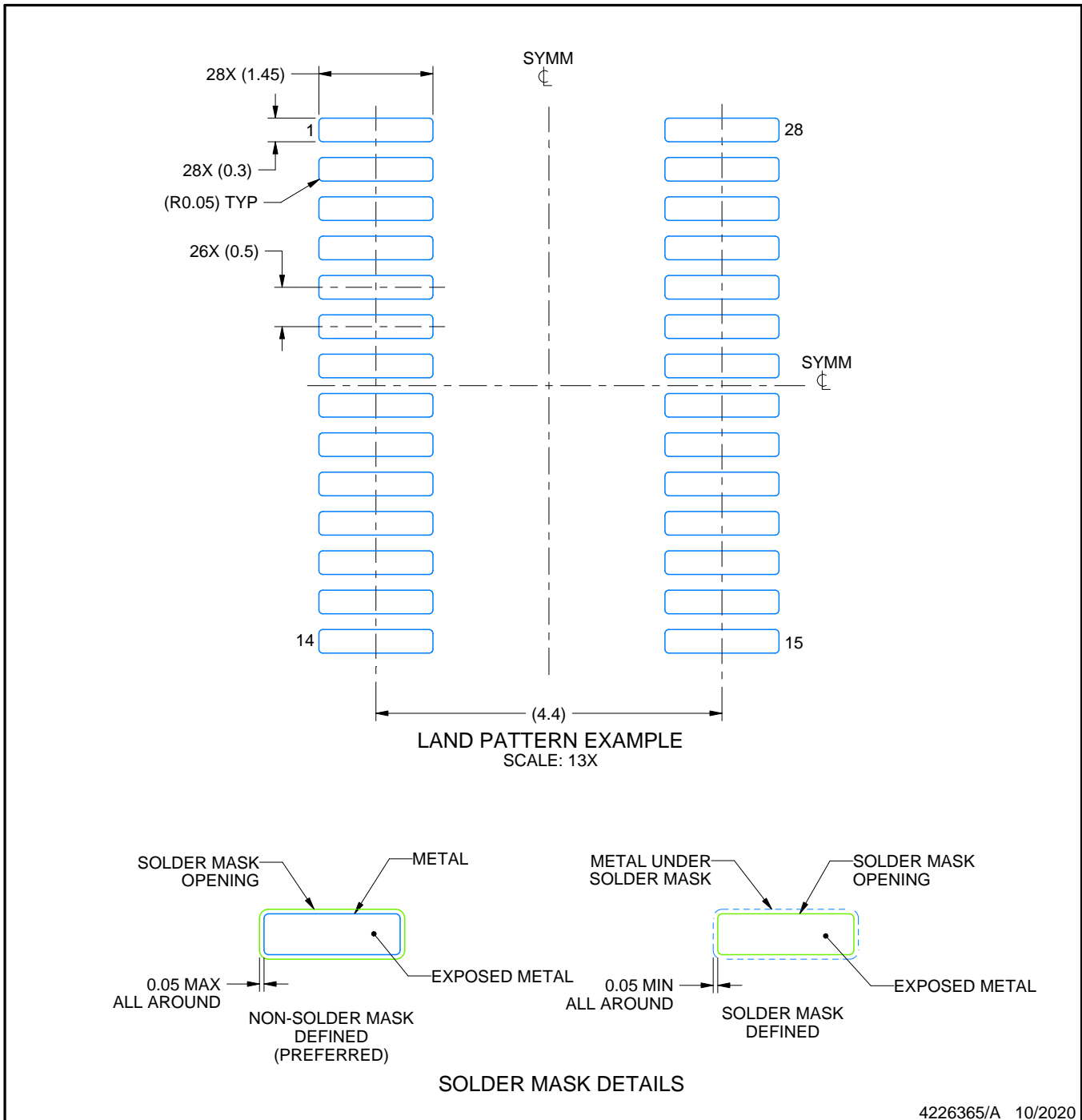

NOTES: (continued)

6. Publication IPC-7351 may have alternate designs.
7. Solder mask tolerances between and around signal pads can vary based on board fabrication site.
8. This package is designed to be soldered to a thermal pad on the board. For more information, see Texas Instruments literature numbers SLMA002 (www.ti.com/lit/slma002) and SLMA004 (www.ti.com/lit/slma004).
9. Size of metal pad may vary due to creepage requirement.
10. Vias are optional depending on application, refer to device data sheet. It is recommended that vias under paste be filled, plugged or tented.

EXAMPLE STENCIL DESIGN

DGS0028A

VSSOP - 1.1 mm max height

SMALL OUTLINE PACKAGE

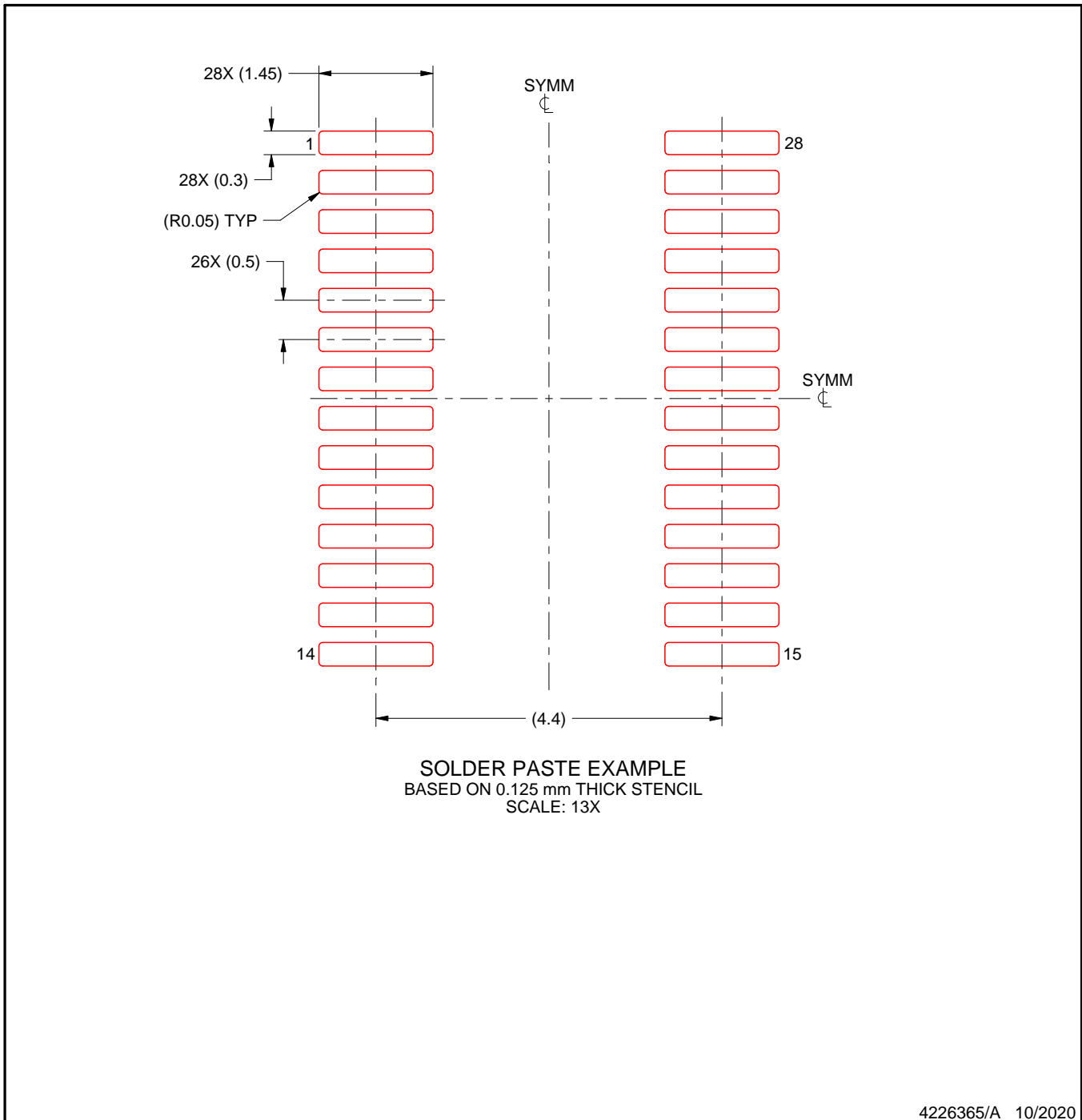

NOTES: (continued)

11. Laser cutting apertures with trapezoidal walls and rounded corners may offer better paste release. IPC-7525 may have alternate design recommendations.
12. Board assembly site may have different recommendations for stencil design.

重要なお知らせと免責事項

TI は、技術データと信頼性データ (データシートを含みます)、設計リソース (リファレンス・デザインを含みます)、アプリケーションや設計に関する各種アドバイス、Web ツール、安全性情報、その他のリソースを、欠陥が存在する可能性のある「現状のまま」提供しており、商品性および特定目的に対する適合性の黙示保証、第三者の知的財産権の非侵害保証を含むいかなる保証も、明示的または黙示的にかかわらず拒否します。

これらのリソースは、TI 製品を使用する設計の経験を積んだ開発者への提供を意図したものです。(1) お客様のアプリケーションに適した TI 製品の選定、(2) お客様のアプリケーションの設計、検証、試験、(3) お客様のアプリケーションに該当する各種規格や、その他のあらゆる安全性、セキュリティ、規制、または他の要件への確実な適合に関する責任を、お客様のみが単独で負うものとし、

上記の各種リソースは、予告なく変更される可能性があります。これらのリソースは、リソースで説明されている TI 製品を使用するアプリケーションの開発の目的でのみ、TI はその使用をお客様に許諾します。これらのリソースに関して、他の目的で複製することや掲載することは禁止されています。TI や第三者の知的財産権のライセンスが付与されている訳ではありません。お客様は、これらのリソースを自身で使用した結果発生するあらゆる申し立て、損害、費用、損失、責任について、TI およびその代理人を完全に補償するものとし、TI は一切の責任を拒否します。

TI の製品は、[TI の販売条件](#)、または [ti.com](#) やかかる TI 製品の関連資料などのいずれかを通じて提供する適用可能な条項の下で提供されています。TI がこれらのリソースを提供することは、適用される TI の保証または他の保証の放棄の拡大や変更を意味するものではありません。

お客様がいかなる追加条項または代替条項を提案した場合でも、TI はそれらに異議を唱え、拒否します。

郵送先住所 : Texas Instruments, Post Office Box 655303, Dallas, Texas 75265
Copyright © 2024, Texas Instruments Incorporated