

デザイン・ガイド: TIDM-02005

水流測定用に最適化された超音波センシング計測のリファレンス・デザイン



概要

このリファレンス・デザインは、内蔵の超音波センシング・ソリューション (USS) モジュールを使用し、低消費電力と最大限の統合によって、優れた計測性能を実現する超音波水量測定サブシステムの開発に役立ちます。このデザインは、64KB の [MSP430FR6043](#) マイクロコントローラ (MCU) を基礎としています。この MCU は高速な ADC ベースの信号収集機能および LEA (Low-Energy Accelerator) を搭載し、デジタル信号処理が最適化されています。

リソース

TIDM-02003	デザイン・フォルダ
MSP430FR6043	プロダクト・フォルダ
EVM430-FR6043	ツール・フォルダ
TS5A9411	プロダクト・フォルダ
OPA836	プロダクト・フォルダ
OPA838	プロダクト・フォルダ
TPS61240	プロダクト・フォルダ
TPS22860	プロダクト・フォルダ

特長

- クラス最高の計測性能: 25ps のゼロ流量ドリフト (ZFD) および 32ps のシングル・ショット標準偏差
- 低消費電力: 毎秒 1 回の測定で、1MHz トランスデューサを使用して約 2.5μA
- 各種のパイプとトランスデューサを柔軟にテスト、トランスデューサのペアと直接接続可能
- 超音波センシング・デザイン・センターのグラフィカル・ユーザー・インターフェイス (GUI) により簡単にテストとカスタマイズが可能
- 超音波センシング・ソフトウェア・ライブラリにタイム・オブ・フライト (ToF) アルゴリズムを内蔵
- 液晶ディスプレイ (LCD) を使用したスタンドアロンのデモ

アプリケーション

- [水道メーター](#)
- [流量トランスミッタ](#)



[Search Our E2E™ support forums](#)

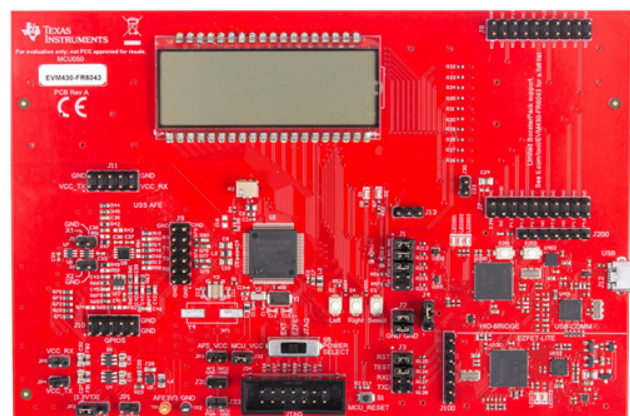
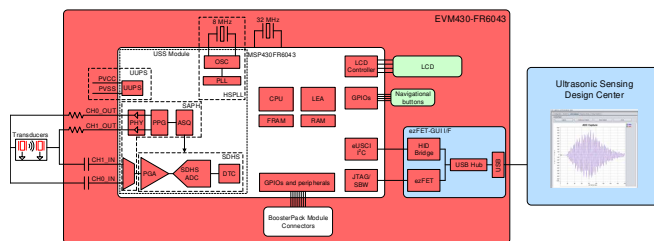

使用許可、知的財産、その他免責事項は、最終ページにあるIMPORTANT NOTICE (重要な注意事項)をご参照くださいますようお願いいたします。

1 System Description

The TIDM-02005 reference design is built using the MSP430FR6043 MCU from TI and other discrete components. The implementation is based on the calculation of differential time of flight (ToF) and uses two transducers for upstream and downstream paths. Transducer excitation and signal captures are implemented using the internal ultrasonic sensing solution (USS) module of the MSP430FR6043 MCU. The signal is then processed by a series of algorithms using the low-energy accelerator (LEA) of the MSP430™ MCU, to calculate the necessary output data in a quick and power-effective manner.

This reference design uses the [EVM430-FR6043](#) evaluation kit, targeted specifically for ultrasonic sensing applications like water-flow meters. The EVM includes a connector to interface with other BoosterPack™ plug-in modules to add features such as wireless communication. The reference design includes all the hardware files required.

The software is written in a modular and portable manner by using [MSP430Ware™ software](#) and [MSP430 Ultrasonic Sensing water Metering Library](#) from TI.

This reference design also includes the [Ultrasonic Design Center](#), that enables designers to modify and optimize different configuration parameters through an easy-to-use GUI. The USS Design Center allows users to implement and customize different transducers easily without modifying the application code in the example project.

The design files include source code for an application example and corresponding Code Composer Studio™ IDE and IAR Embedded Workbench® IDE projects.

1.1 Key System Specifications

表 1. Key System Specifications

PARAMETER	SPECIFICATIONS	DETAILS
Zero-flow drift (ZFD)	25 ps (typ)	3.3.2.2
Single-shot standard deviation (STD)	32 ps (typ)	3.3.2.1
Minimum detectable flow (MDF)	1 LPH	3.3.2.4
Average current consumption at one measurement per second (P_{AVG})	2.5 μ A (typ)	3.3.2.5

2 System Overview

2.1 Block Diagram

図 1. TIDM-02005 Block Diagram

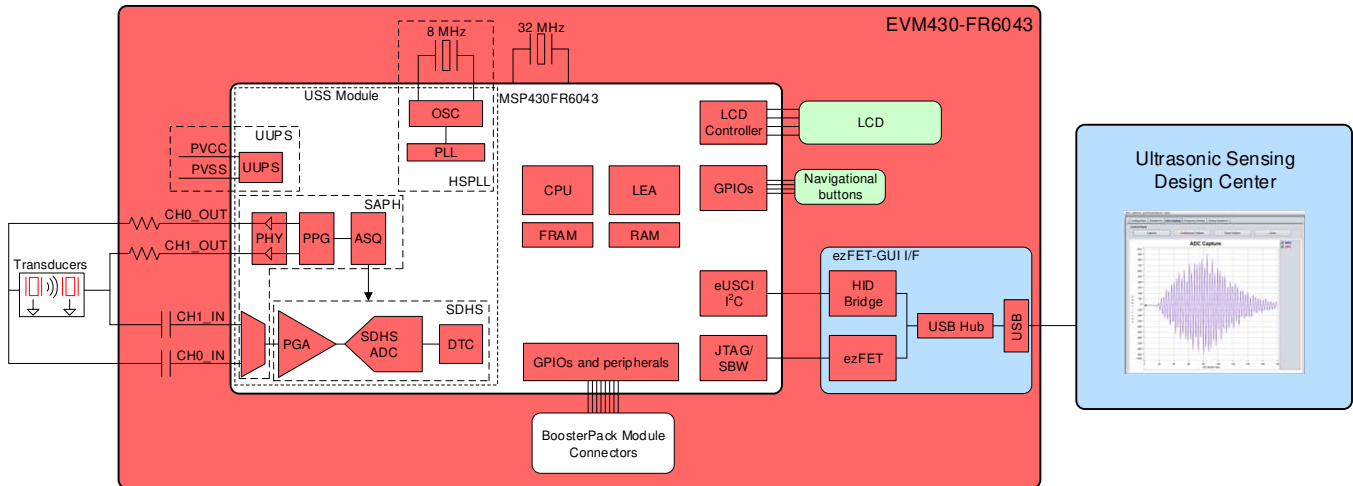

2.2 Design Considerations

2.2.1 Flow Measurement

The ultrasonic water-flow meter design is based on the principle of ToF measurement. This measurement refers to the time it takes a signal to travel from a transmitting transducer to a receiving transducer.

図 2 shows a flow pipe.

図 2. ToF in Flow Meter

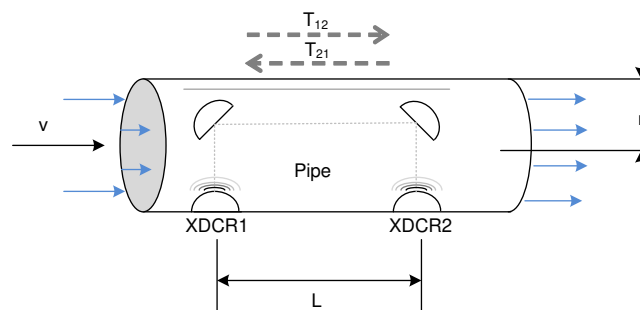

The propagation time of a signal traveling from the first transducer (XDR_1) to the second transducer (XDR_2) is given by T_{12} . T_{21} represents the propagation time in the opposite direction. Calculate these timings according to the following equations as a function of the velocity of the ultrasound in water and the velocity of water flow. Because this length is much larger than the radius of the pipe, r , the propagation length of the wave that is perpendicular to the flow is considered to be negligible in the following analysis.

$$T_{12} = \frac{L}{c+v} \quad (1)$$

$$T_{21} = \frac{L}{c-v} \quad (2)$$

$$\Delta t = T_{21} - T_{12} \quad (3)$$

where

- c is the velocity of the ultrasound in the medium.
- v is the velocity of water flow.
- L is the propagation length of the pipe along the flow of water.

Use 式 1 through 式 3 to derive the velocity of water flow (v), which is possible even without knowing the velocity of the ultrasound in the medium ©).

This reference design calculates water flow assuming that the velocity of the ultrasound is unknown. In this case, derive 式 4 from 式 1 and 式 2 by eliminating c .

$$v = \frac{L}{2} \times \left(\frac{1}{T_{12}} - \frac{1}{T_{21}} \right) = \frac{L}{2} \times \left(\frac{T_{21} - T_{12}}{T_{21}T_{12}} \right) = \frac{L}{2} \times \left(\frac{\Delta T}{T_{21}T_{12}} \right) \quad (4)$$

Using 式 4, calculate the actual propagation times, T_{12} and T_{21} , in the two directions along the cross section of the pipe.

2.2.2 ToF Measurement

In the implementation discussed in this reference design, the MSP430FR6043 MCU performs the complete acquisition process using the USS module in the device for signal conditioning.

At the beginning of the sequence, the MSP430FR6043 MCU sends a train of pulses to the first transducer, XDCR₁. The signal is then received by the second transceiver, XDCR₂, after propagation time T_{12} . The difference in time between transmission and reception determines the upstream (UPS) ToF, or ToF_{UPS}.

The MSP430FR6043 MCU repeats the same process in the opposite direction during the downstream stage, resulting in the propagation time, T_{21} , which represents the downstream (DNS) ToF, or ToF_{DNS}.

The DToF, Δt , can then be calculated as the difference between T_{12} and T_{21} , as described in 式 3.

The DToF is typically measured using two techniques: Zero-crossing using a time-to-digital converter (TDC) or through Correlation using the ADC captured signal

The TIDM-02005 design uses the ADC-based technique instead of the TDC technique due to the following advantages.

- Improved performance: the correlation acts as a digital filter to suppress noise, which results in a benefit of approximately three to four times lower noise standard deviation. Similarly, the correlation approach also acts as a low-pass filter that suppresses other interference like line noise.
- Improved robustness for signal amplitude variations: because the algorithm is insensitive to the received signal amplitude, transducer-to-transducer variation, and temperature variation.
- The envelope of the signal is obtained naturally. This signal enables tuning to the transducer frequencies, as well as slow variations in the envelope across time, which can be used to maintain performance even with aging transducers or meters.

2.2.2.1 ADC-Based Acquisition Process

The ADC-based acquisition process implemented in this reference design heavily uses the hardware capabilities of the USS module in the MSP430FR6043 MCU, including pulse generation and the high-speed sigma-delta ADC, to completely automate the sampling process. This process not only provides tighter control of the sampling process without dependencies on CPU latencies and compilers, but it also reduces the power consumption, because the CPU is in low-power mode 3 (LPM3) during the measurement.

1. At the start of the process (t_0), the device initializes the USS module that is running off the internal

- clock derived from USSXT and triggers the start of pulse generation.
2. The CPU goes into LPM0 low-power mode after starting the USS module, waiting for the measurement sequence to complete. This sequence also includes signal acquisition by the high-speed sigma-delta ADC, and the captured data is stored in the RAM shared between the CPU and LEA module.
 3. After the last sample, the USS module automatically wakes up the CPU through an interrupt mechanism.
 4. The CPU prepares to go into LPM3 mode at the end of conversion time (t_{EOC}).
 5. After a specified UPS-DNS gap ($t_{UPS-DNS-GAP}$), the CPU starts the USS module to process the other (DNS) channels. The CPU goes into LPM0 mode waiting for the DNS samples and measurement.
 6. After the last sample is received for the DNS, the USS module automatically wakes up the CPU through an interrupt mechanism.
 7. The CPU processes the data and obtains the delta time of flight (DToF) and absolute time of flight (AbsToF) for both the DNS and UPS channels, and the volume flow rate (VFR). After processing is complete, the CPU goes into LPM3 mode for the duration of $t_{DNS-UPS-GAP}$, which is the gap between the end of the current measurement and the start of the next measurement.

2.2.2.2 Ultrasonic Sensing Flow-Metering Library

This reference design is intended to explain some of the key concepts of implementing an ultrasonic, flow-metering, metrology solution, so it is important to note that the proposed solution makes use of the [Ultrasonic Sensing Flow Metering Library](#), which implements several proprietary algorithms from TI, to capture and process the signal as well as calculates the ToF and water flow rate.

The Ultrasonic Sensing Flow Metering Library and documentation are available for download from the [USSSWLibrary](#).

2.2.3 Low-Power Design

The USS module in the MSP430FR6043 MCU used in this design is intended to meet the low-power requirements of water meter applications. While the current consumption of the system depends on the meter, transducers, and configuration of the application, the solution was designed to consume approximately 2.5 μ A, using 1-MHz transducers taking one measurement per second. This includes one UPS and one DNS measurement per second and the associated signal processing. This is only for the metrology portion and does not include any current consumption in between the measurements that can be used for other unrelated application-level processing or when the device can be put in a low-power mode like LPM3. For more details on power consumption measurements, see [3.3.2.5](#).

The low-power features implemented by this reference design include:

- Energy-efficient software
- Optimized hardware design internal to the MSP430FR6043 MCU
- Efficient use of FRAM
- Uses the low-energy signal-processing capabilities of LEA

2.2.3.1 Energy-Efficient Software

The application software and Ultrasonic Sensing Water Flow Metering Library used by the TIDM-02005 design maximize the use of low-power modes. The MCU enters the lowest-power mode available when possible.

2.2.3.2 Optimized Hardware Design

The TIDM-02005 design uses not only the MSP430 platform, which combines high performance with industry leading ultra-low power consumption, but all external components were selected for their energy efficiency.

2.2.3.3 Efficient Use of FRAM

The MSP430FR6043 MCU uses FRAM technology, which combines the best features of flash and RAM. FRAM offers the nonvolatile nature of flash together with fast and low-power writes, a write endurance of 10^{15} cycles, resistance to radiation and electromagnetic fields, and unmatched flexibility.

This use of this technology results in an application that writes and logs data more efficiently than its flash-based counterparts.

The application provided in this software package uses FRAM to store several nonvolatile variables, such as the configuration received from the GUI. This storage lets users reconfigure the device on-the-fly and keeps the configuration after subsequent power cycles.

Developers of metering applications can use FRAM to implement many additional features including:

- Logging historical statistical data, such as differential ToF, absolute time of flight (absToF), or volume flow rate
- Logging errors and faults in nonvolatile memory
- Saving and restoring the state of the device before a power failure (see [TIDM-FRAM-CTPL](#))

2.2.3.4 The LEA Advantage

The TIDM-02005 design also makes efficient use of the LEA available in the MSP430FR6043 MCU.

The LEA is a 16-bit hardware engine designed to perform signal processing, matrix multiplications, and other operations that involve vector-based signal processing, such as FIR, IIR, and FFT, without CPU intervention. Efficient use of this module can result in improvements of up to 36.4 times for typical math intensive operations.

The LEA is used by the Ultrasonic Sensing Flow Metering Library to accelerate all vector operations in its proprietary algorithms. The LEA not only reduces the processing time of many operations, but LEA also allows the CPU to go into a low-power state.

For more information about the LEA, see [Low-Energy Accelerator \(LEA\) Frequently Asked Questions](#) and [Benchmarking the Signal Processing Capabilities of the Low-Energy Accelerator on MSP430 MCUs](#).

2.3 Highlighted Products

2.3.1 MSP430FR6043

The MSP430FR604x family of ultrasonic sensing and measurement system on chips (SoCs) from TI are powerful highly-integrated MCUs that are optimized for water and heat meters. The [MSP430FR6043](#) MCU offers an integrated USS module, which provides high accuracy for a wide range of flow rates. The USS module helps achieve ultra-low-power metering, combined with lower system costs, due to maximum integration requiring few external components. The MSP430FR6043 MCU implements a high-speed, ADC-based, signal acquisition followed by optimized digital signal processing using the integrated LEA module, to deliver a high-accuracy metering solution with ultra-low power optimum for battery-powered metering applications.

The USS module includes a programmable pulse generator (PPG) and a physical interface (PHY) with a low-impedance output driver for optimum sensor excitation and accurate impedance matching, to deliver the best results for ZFD. The module also includes a programmable gain amplifier (PGA) and a high-speed, 12-bit, 8-Msp/s, sigma-delta ($\Sigma\Delta$) ADC (SDHS) for accurate signal acquisition from industry standard ultrasonic transducers.

Additionally, the MSP430FR6043 MCU uses other peripherals to improve system integration for metering. The device has a metering test interface (MTIF) module, which implements pulse generation to indicate the flow measured by the meter. The MSP430FR6043 MCU also has the following:

- On-chip 8-MUX LCD driver
- RTC
- 12-bit SAR ADC with up to 16 external channels
- Analog comparator with up to 16 channels
- Four eUSCI_A to implement universal asynchronous receiver/transmitter (UART) IrDA or serial peripheral interface (SPI)
- Two eUSCI_B to implement I²C or SPI
- Six 16-bit timers
- Advanced encryption accelerator (AES256)
- Cyclic redundancy check (CRC) module

The MSP430 ultra-low-power FRAM MCU platform combines uniquely embedded FRAM and a holistic, ultra-low-power, system architecture, letting system designers increase performance while lowering energy consumption. FRAM technology combines the low-energy fast writes, flexibility, and endurance of RAM with the nonvolatile nature of flash.

The TIDM-02005 design uses the MSP430FR6043 MCU to not only act as a host processor communicating with a PC GUI, but also to perform measurements in an automated process. The powerful peripherals of the MSP430FR6043 MCU, particularly the USS module, together with FRAM technology and the LEA, allow for an accurate and efficient implementation of an ultrasonic water flow meter.

2.3.1.1 OPA836 and OPA838

Note: When using the EVM430-FR6043 in the water metering configuration, the OPA83x is not used. When using the EVM430-FR6043 in the gas metering configuration, the OPA83x is used.

The [OPA836](#) is a single, ultra-low power, rail-to-rail output, negative-rail input, voltage-feedback (VFB) operational amplifiers that operate over a power-supply range of 2.5 V to 5.5 V with a single supply or with ± 1.25 V to ± 2.75 V with a dual supply. Consuming only 1 mA per channel and with a unity-gain bandwidth of 205 MHz, this amplifier sets an industry-leading power-to-performance ratio for rail-to-rail amplifiers. Coupled with a power-savings mode to reduce current to <1.5 μ A, this device offers an attractive solution for high-frequency amplifiers in power-sensitive applications. The OPA838 and associated amplifier circuit should be used in applications requiring higher gains.

The TIDM-02005 design uses an OPA836 to implement an efficient two-stage amplifier providing the desired gain and bandwidth. A high-gain first stage amplifier is implemented using an OPA836 for the following reasons:

- Low input noise (4.6 nV/ $\sqrt{\text{Hz}}$ at 100 kHz)
- High bandwidth (205 MHz)
- Low power consumption: 0.5 μA in power-down mode and 1-mA quiescent current

Because the gain of the second stage amplifier is lower than the first stage, the low input noise and bandwidth requirements are not as critical. The MSP430FR6043 internal programmable gain amplifier (PGA) is used to provide the second stage amplification from -6.5 dB to 30.8 dB.

The OPA838 can provide enhanced standard deviation performance up to 2.5x lower than the OPA836 and is a drop-in replacement.

2.3.1.1.1 TS5A9411

The [TS5A9411](#) device is a bidirectional single-pole double-throw (SPDT) analog switch that operates from 2.25 V to 5.5 V. The device offers low ON-state resistance, low leakage, and low power with a break-before-make feature. These features make this device suitable for portable and power-sensitive applications. The TIDM-02005 uses the TS5A9411 to switch the transmission and reception signals from the MCU to the two transceivers in an efficient manner and without distortion.

When using the EVM430-FR6043 in the water metering configuration, the TS5A9411 is bypassed and not used. When using the EVM430-FR6043 in the gas metering configuration, the TS5A9411 is used.

2.4 System Design Theory

The ADC-based approach to estimate the differential ToF and AbsToF is based on correlation techniques.

2.4.1 Correlation Based Technique for Differential TOF Estimation

The correlation based TOF estimation involves the following steps:

1. A pulse train is transmitted from transducer 1 in [Figure 2](#).
2. At a certain pre-determined time, the ADC is started to capture the data at the receive transducer. Let the received data be indicated as [Equation 5](#).

$$\bar{r}_2 = \{r_2^1, r_2^2, r_2^3, \dots, r_2^N\}$$

where

- $r_2^i = r_2 \left(\frac{i}{f_s} \right)$
 - f_s = sampling rate of the ADC
 - i = index of the sample
- (5)

3. Similarly, transmit the pulse train from transducer 2 and receive the signal at the transducer. Let the sampled signal at transducer 1 be given by [Equation 6](#).

$$\bar{r}_1 = \{r_1^1, r_1^2, r_1^3, \dots, r_1^N\}$$
(6)

4. Based on \bar{r}_1 and \bar{r}_2 , a correlation value is calculated by 式 7.

$$\text{corr}(k) = \sum_{i=1}^N r_1^{i+k} r_2^k$$

where

- $k = \{-m, -(m-1), \dots, (m-1), m\}$

- $\text{corr}(k) = \sum_{i=1}^N r_1^{i+k} r_2^k$ for $i < 1$ and $i > N$ (7)

5. The maximum of the correlation is calculated by 式 8.

$$\hat{k} = \max_k(\text{corr}(k)) \quad (8)$$

6. Let $Z_{-1} = \text{corr}(\hat{k}-1)$, $Z_0 = \text{corr}(\hat{k})$, and $Z_1 = \text{corr}(\hat{k}+1)$ be the values of correlation at and around the maximum.

7. The real maximum of the correlation is now given by the interpolation in 式 9.

$$\delta = \text{int } \text{erp}_{\max} \{Z_{-1}, Z_0, Z_1\} \quad (9)$$

8. The net different time of flight is now given by 式 10.

$$T_{12}^{\text{corr}} = (\hat{k} - m + \delta) \quad (10)$$

9. In USS Software Library implementations, m is typically chosen to be $+1$, implying that only 3 correlations must be computed most of the time.

This correlation-based TOF calculation has been reported in the literature previously as given in [reference \[12\]](#) and [reference \[13\]](#). The details of the equations for δ in 式 10 can be found in [reference \[14\]](#) and provided in 2.4.2.1 for completeness. 図 3 shows a block diagram of the receiver for the correlation.

図 3. Block Diagram for Correlation-Based Differential TOF Estimator



図 4. Interpolation Step in the ADC-Based Correlation Technique for Differential TOF Estimation



Efficient interpolation techniques have been given in [reference \[4\]](#). As previously mentioned, for efficiency of implementation, the correlation is computed over few points leading to a low-power implementation.

To ensure that Z_0 is the maximum point, the correlation peak runs through a search algorithm sequentially computing the three adjacent correlation terms (Z_{-1} , Z_0 , and Z_{+1}) until it finds the maximum Z_0 that is larger than Z_{-1} and Z_{+1} and the earlier correlation terms. Typically, only an additional 1 or 2 adjacent correlation points are computed in addition to the 3 correlation points.

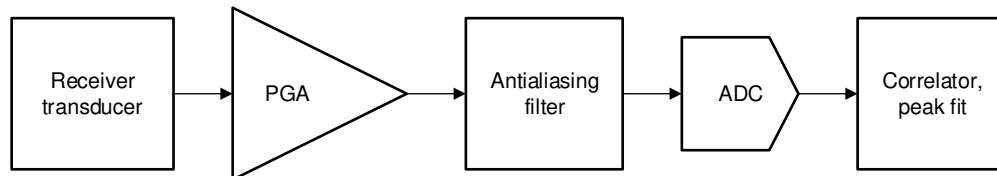
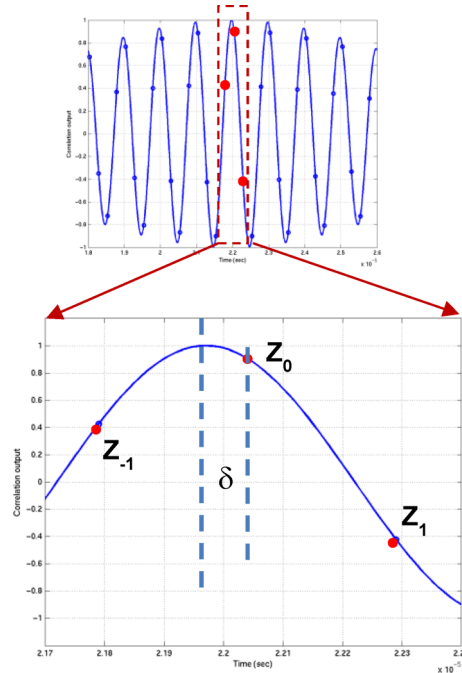
2.4.2 Absolute Time-of-Flight (AbsTOF) Measurement (T_{up} and T_{dn})

The absolute time of flight (AbsToF) is determined by a two-stage process, namely acquisition and tracking. The acquisition process is implemented when there is no previous memory of the absTOF value (for example during the first signal capture) or when the algorithm detects an anomaly in two consecutive measurements of AbsTOF. The acquisition process algorithm consumes more power, so it is not implemented during each measurement. Instead, the tracking algorithm is implemented during each measurement

2.4.2.1 Acquisition Algorithm for AbsTOF

As mentioned above, the acquisition algorithm is run when there is no previous memory of the AbsTOF value or when the algorithm detects an anomaly in two consecutive measurements of AbsTOF. [图 5](#) shows a representative captured ADC waveform. The small circles in this figure represent the captured points.

It is important to ensure there is some dead time in the capture prior to the ultrasonic signal. This additional dead time enables the algorithm to operate properly and also ensures the signal is still within the capture window at higher temperatures. The dead time between the start of capture and the signal for a DN-25 pipe should be around 5us.

図 5. Representative Captured Waveform

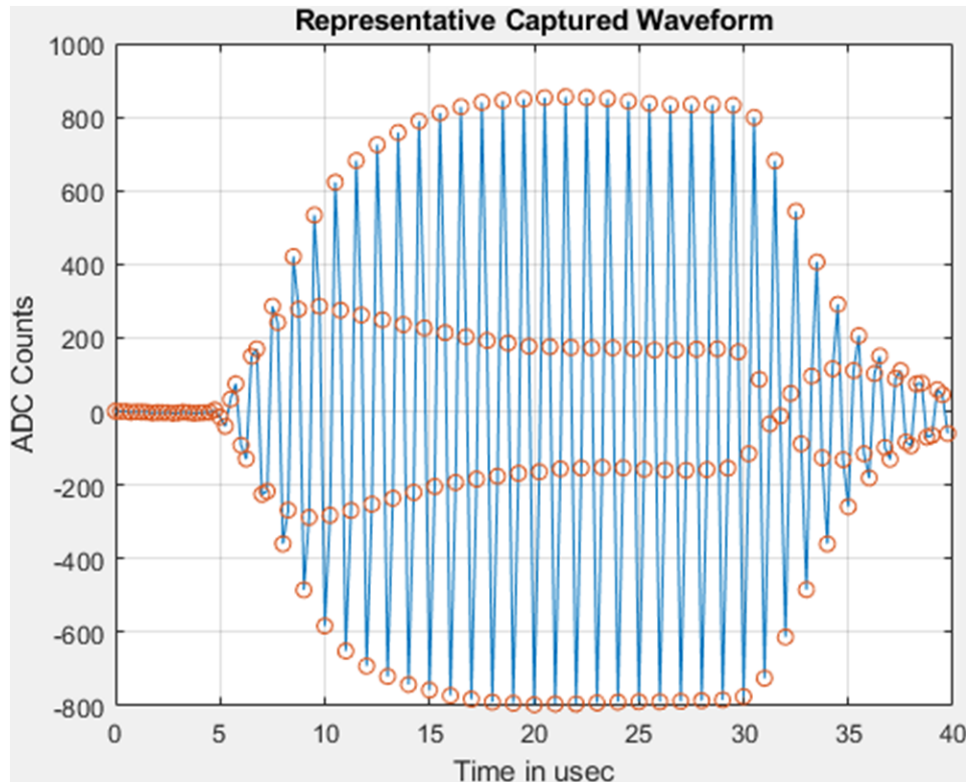

As given in 式 6, i is the time index for the signal capture and $\bar{r}_1 = \{r_1^1, r_1^2, r_1^3, \dots, r_1^N\}$ is the upstream captured signal.

The acquisition algorithm then employs the following steps:

1. For every i equal to 2 to $(N - 1)$, let $i = \{i_1, i_2, \dots, i_M\}$ for which $r_1^{i-1} \leq r_1^i$ and $r_1^{i+1} \leq r_1^i$.

This means the central value r_1^i is greater than or equal to the two points on either side. The algorithm

then uses parabolic interpolation between the $\{r_1^{i-1}, r_1^i, r_1^{i+1}\}$ for all such i . A parabolic interpolation is chosen (rather than the cosine interpolation for dTOF calculation) for reduced complexity, and the accuracy on AbsTOF estimation is not as tight as the dTOF estimation in terms of contribution to the overall flow error. The algorithm tabulates all these interpolated values. Letting \tilde{r} denote the

interpolated value these tabulated values can be given by $\{\tilde{r}_1^1, \tilde{r}_1^2, \dots, \tilde{r}_1^M\}$. These interpolated values would now correspond to the "maximum of lobe" values of each wave in 図 5. These are shown by dark red dots in 図 7 and 図 8.

2. The algorithm then computes the maximum over all these tabulated values $\{\tilde{r}_1^1, \tilde{r}_1^2, \dots, \tilde{r}_1^M\}$. This thus generates the maximum of the signal. Let this maximum of the signal be denoted by \tilde{r}_1^{\max} .
3. Let η denote the threshold for the wave lobe that we would like the AbsTOF algorithm to lock on to. This threshold would be a function of the type of transducers and should be set to a value where we expect the maximum rate of the change of the waveform to ensure the intended lobe is locked. This threshold is typically set to 0.1 in the USS Software Library. Then let $\eta^{\text{thresh}} = \eta \times \tilde{r}_1^{\max}$. This threshold can be controlled using the `#define USS_ALG_RATIO_OF_TRACK_LOBE` in `USS_userConfig.h` and maintained in `USS_Algorithms_User_Configuration`. `ratioOfTrackLobeToPeak`. 図 6 depicts an ADC

capture in which the peak of the signal is around 900 ADC counts. Assuming the maximum rate of change is on the first lobe, setting a threshold of 0.1 would give a threshold around 90 ADC counts (900×0.1). It is important to note that on some meters, there could be noise before the first lobe which could be inadvertently locked on to instead of the intended first lobe. In cases where noise is present before the first lobe, it is advised to set the threshold to lock to the second lobe to avoid locking to noise. In the example shown in [Figure 6](#) a threshold of 180 ADC counts (900×0.2) could be used to lock to the second lobe.

Figure 6. Determination of Threshold

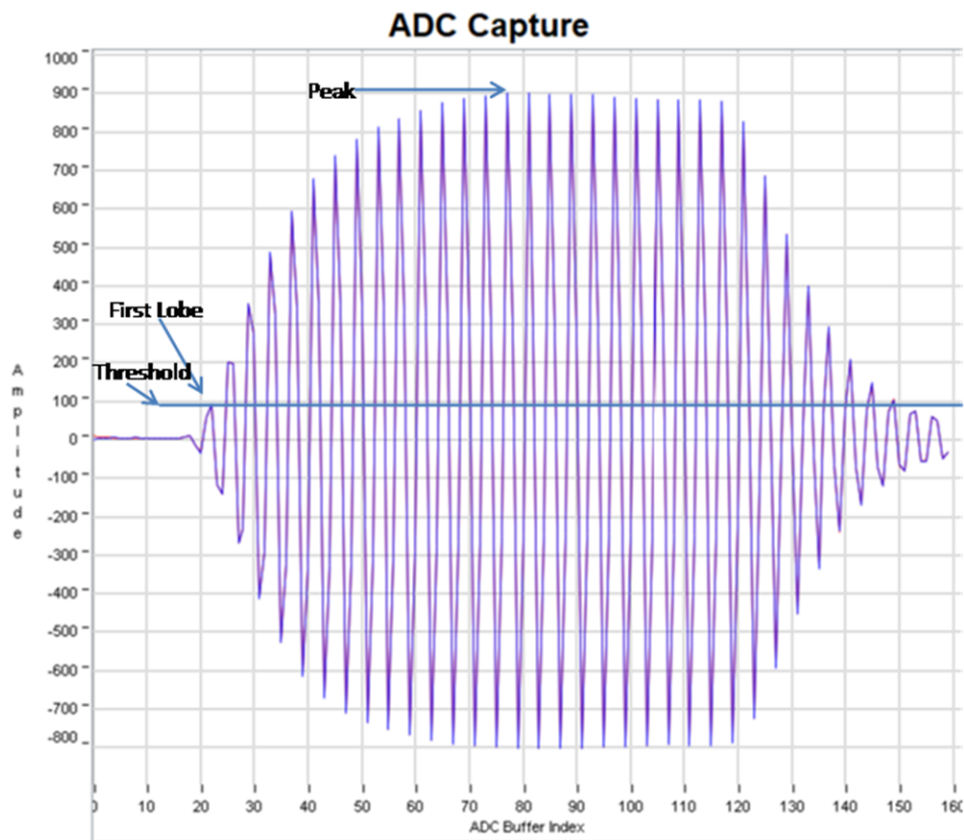

- For the tabulated interpolated values $\{\tilde{r}_1^{i_1}, \tilde{r}_1^{i_2}, \dots, \tilde{r}_1^{i_M}\}$, find that value of $i = i_k$ for which the tabulated value is closest to η^{thresh} that is the $\text{abs}(\eta^{\text{thresh}} - \tilde{r}_1^{i_k})$ is minimum. The offset delay of the maximum from index i_k is then calculated from the parabolic interpolation equation.

The value i_k would now be used as an index for the next signal capture. [Figure 7](#) and [Figure 8](#) show the acquisition process.

図 7. Interpolation in Acquisition Algorithm of AbsTOF



図 8. Data Points for Acquisition Algorithm for AbsTOF



2.4.2.1.1 Tracking Algorithm for AbsTOF

Let i_k denote the index from the previous capture (the procedure to get this during acquisition was described in 2.4.2.1) for previous burst $j-1$ and let j denote the current capture. Now, the algorithm has the following steps:

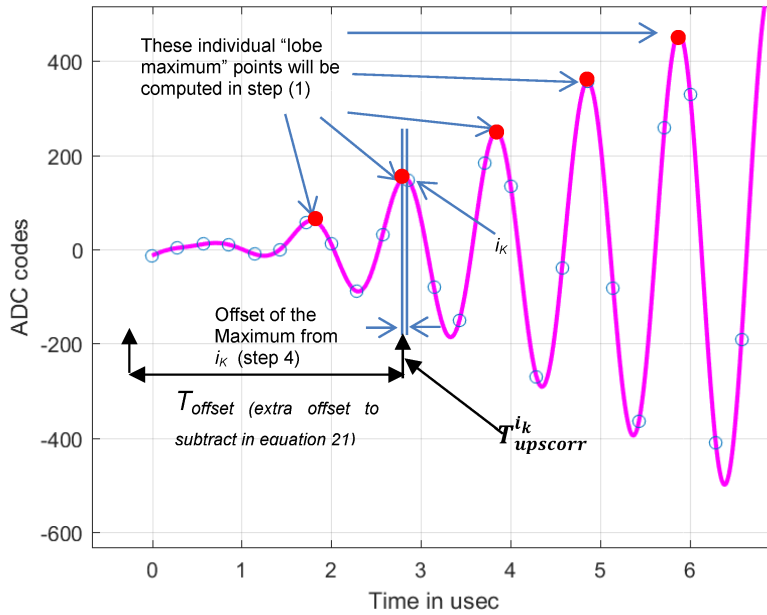
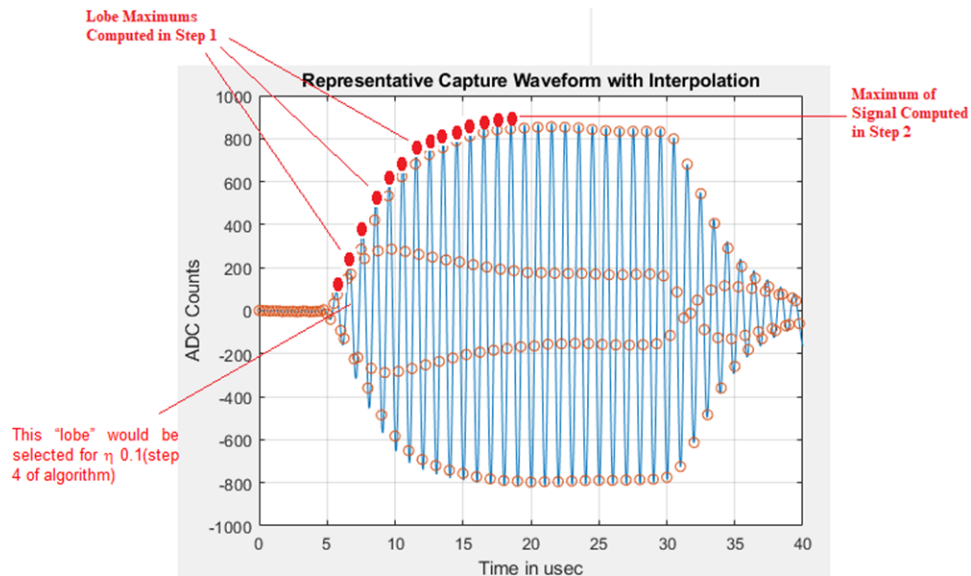
1. The algorithm checks if $r_1^{i_k-1} \leq r_1^{i_k}$ and $r_1^{i_k+1} \leq r_1^{i_k}$, if this is not true then it follows steps (2) and (3). If it is true, then the algorithm goes to step (4).
2. If however $r_1^{i_k-1} > r_1^{i_k}$ then i_k is set equal to i_k-1 and if $r_1^{i_k+1} > r_1^{i_k}$ then i_k is set equal to i_k+1 .
3. The check in step (1) is now repeated on this new index i_k . In the water flow meter USS Software Library, a maximum of one such update in step (2) is allowed. If the algorithm still does not satisfy the inequality in step (1) then a full acquisition as in 2.4.2.1 is triggered.
4. The offset delay of the maximum from index i_k is then calculated from the parabolic interpolation

equation. $T_{upscorr}^{i_k}$ denotes the effective time.

The upstream absolute time of flight is thus given by 式 11.

$$T_{ups}^{abs} = T_{prop} + T_{upscorr}^{i_k} - T_{offset} \quad (11)$$

In this equation, T_{prop} is the propagation time that is specified using `#define USS_ACOUSTIC_LENGTH` in `USS_userConfig.h` and is maintained in `USS_Meter_Configuration.acousticLength` as part of the application meter configuration. It corresponds to the approximate propagation time for ultrasound in the given meter. Typically T_{prop} is 35 to 40 μ s. T_{offset} corresponds to the number of cycles to back track from the lobe corresponding to the index i_k and is a function of the threshold η . In the USS Software Library, T_{offset} is set to 5 μ s and can be modified using the user configuration `#define USS_ALG_ADC_ADDITIONAL_CAP_DLY`. It is maintained in the variable `USS_Algorithms_User_Configuration.ADCAdditionalCaptureDelay`.

The calculations of acquisition and tracking for the upstream direction are repeated for the downstream direction. The software keeps track of another index i_k for the downstream data for each burst j .

3 Hardware, Software, Testing Requirements, and Test Results

3.1 Required Hardware and Software

3.1.1 Hardware

The hardware used for this reference design consists of the EVM430-FR6043 ultrasonic sensing evaluation module. To use this hardware for water metering, some changes are required from the default configuration that the board is shipped with. The required changes are described below.

3.1.1.1 EVM430-FR6043

To use the EVM430-FR6043 for water metering, there are some modifications which must be made to the board as described in 3.1.1.1.1.

The [EVM430-FR6043](#) evaluation kit is a development platform that can be used to evaluate the performance of the MSP430FR6043 MCU for ultrasonic sensing applications (for example, smart water meters). The kit provides a flexible solution to let engineers quickly evaluate and develop with the MSP430FR6043 MCU, with a variety of transducers up to 2.5 MHz. The EVM can display the measurement parameters using the onboard LCD and connectors for RF communication modules.

The EVM430-FR6043 kit can be USB-powered, but it also includes a provision for external power. The EVM also has headers for a BoosterPack plug-in module to interface with external boards through various interfaces like I²C, SPI, UART, or GPIO, as well as RF communication modules. The EVM has an onboard, segmented LCD and an onboard, eZ-FET emulation circuit to enable programming and debug.

When using USB as the power source, set the S5 switch to the middle position (*eZ-FET*) and set J2 and J4 as shown in [Figure 10](#). When using an external power source, set the S5 switch to the top position (*External*) (see [Figure 9](#)).

図 9. eZ-FET Power Selection

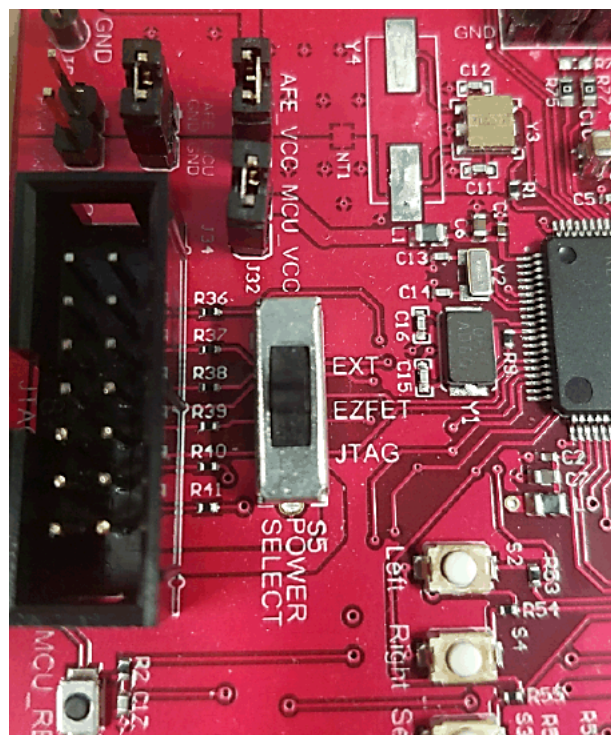

☒ 10 shows J1 and J3 set for the USB power source (ezFET).

☒ 10. USB (eZ-FET) Power Jumper Configuration

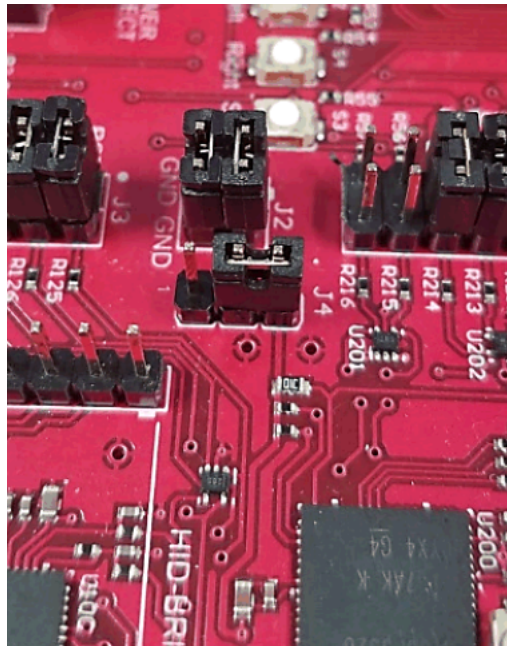

3.1.1.1.1 Hardware Modifications for Water Meter Operation

The EVM430-FR6043 requires some hardware modifications to be used for water metering. These are described and shown in ☒ 11.

1. Replace R75 and R80 with 1000pF cap, replace R77 and R78 with 200 ohm resistor, and place 0 ohm resistors on R76 and R79.
2. Remove all jumpers on J9. Transducers will connect to outside pins as pictured in ☒ 11.
3. Remove jumper from JP2, JP3, JP4, JP5, and J31.
4. The transducer connections on J9 can be seen in ☒ 19.

図 11. Jumper Configuration and Modifications for Water

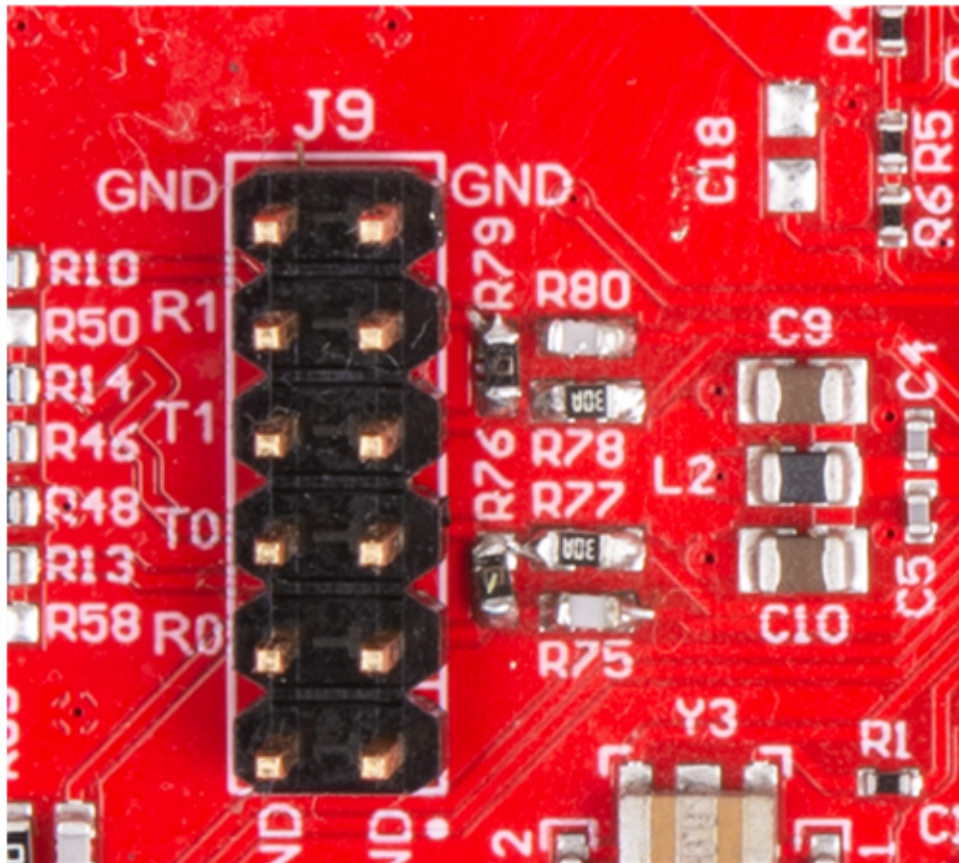

All test results presented in this design guide used an external power supply (EXT_POW).

3.1.2 Software

図 12 shows the software architecture implemented in this reference design. The software is implemented in a modular and portable manner. The main components include the MSP430 Driver library (DriverLib), Ultrasonic Sensing Flow Metering Library (USS SW LIB), Application, and Ultrasonic Sensing Design Center GUI.

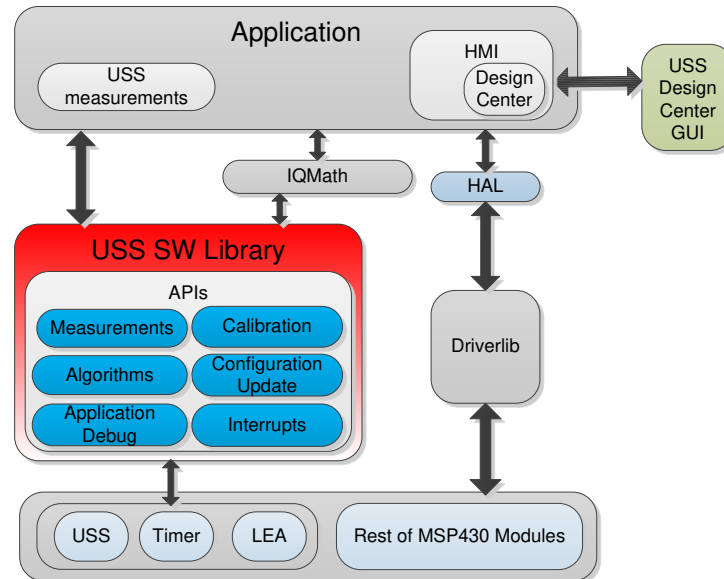
図 12. Software Architecture

This reference design only includes examples tested on the MSP430FR6043 MCU using the EVM430-FR6043 evaluation kit. The software package includes source code for the application, the Ultrasonic Sensing Flow Metering Library in binary format, and corresponding IAR and CCS projects. The main software components are discussed in the following sections.

3.1.2.1 *MSP Driver Library (MSP DriverLib)*

The driver library (DriverLib) includes APIs for selected MSP430 device families, providing easy-to-use function calls. Each API is thoroughly documented through a user's guide, API guide, and code examples.

The TIDM-02005 design uses the MSP Driver Library to interface with all hardware modules used by the application from eUSCI_A, which is used for asynchronous communication with the PC to the USS module, which is then used to sample the incoming signal. This feature not only allows for an easier migration to other MSP430FR604x MCUs, but it also makes the code easier to read and understand by using common language APIs.

The source code in the software package includes all DriverLib files used by this application. The MSP DriverLib and documentation are also available at [MSPDRIVERLIB](#).

3.1.2.2 *Ultrasonic Sensing Flow Metering Library*

The Ultrasonic Sensing Flow Metering Library includes proprietary algorithms to capture and process the signal received from the transceivers as well as to calculate the ToF and water flow rate. The library includes an easy-to-implement set of fully-documented APIs that hide the complexity behind ultrasonic measurement calculations and allow for a faster implementation of the application. A comprehensive list of parameters lets developers configure the system according to different hardware and transceiver requirements.

The Ultrasonic Sensing Flow Metering Library used by the application is included in CCS and IAR library format. This library and its documentation are available at [USSFlowLibrary](#).

3.1.2.3 Application

Figure 13 shows the flow diagram of the application.

Figure 13. Application Flow Diagram

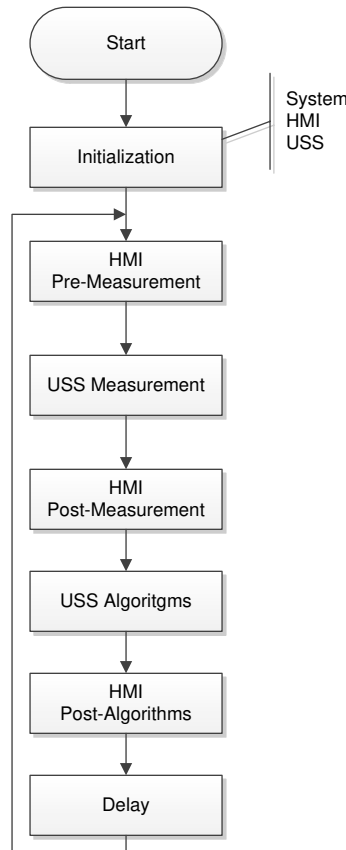

The application starts by initializing the basic functionality of the system including peripherals, clocks, and I/Os, followed by initializing the HMI peripherals including LCD, GUI communication, buttons, and LEDs. Finally, the system performs the initial configuration of the ultrasonic subsystem and its algorithms.

After initialization, the application stays in a continuous loop performing the following tasks:

- HMI pre-measurement: Performs user interaction functions before an ultrasonic measurement, such as checking if the GUI has a new configuration to send or if the user pressed a button.
- USS measurement: Performs an ultrasonic measurement. The result of this function is an ADC-sampled waveform.
- HMI post-measurement: Performs user interaction functions after a measurement such as sending the ADC waveform to the GUI.
- USS algorithms: Runs ultrasonic algorithms on the ADC-sampled waveform to calculate data such as the ToF and volume flow rate.
- HMI post-algorithms: Performs user interaction functions after the algorithms are executed. This includes sending the results to the GUI or displaying them on the LCD.
- Delay: The device goes to a low-power state waiting for the next iteration.

[Application Software \(SW\) for MSP430FR6043-Based Ultrasonic water Flow Meter](#) describes the architecture and implementation of the application in more detail.

3.1.2.3.1 Application Customization

The ultrasonic water-flow meter application included in this reference design is provided in source code to let developers customize it according to their needs. Although developers can customize the functionality and behavior of the application as needed, the most common customizations include:

- Changing the default USS configuration

Although the Design Center GUI lets developers modify different ultrasonic configuration parameters, as described in 3.1.2.4, the application includes source code of configuration files, which can be modified to customize the default configuration of the system.

- Customizing the hardware

The application is designed in a modular way, including a hardware abstraction layer (HAL) to encapsulate hardware interactions. This feature allows for easier customization of different hardware requirements from developers and an easier migration between TI platforms.

- Customizing data processing

The library includes proprietary algorithms, which are used to process captured ADC waveforms and obtain flow rate information. However, it is possible for developers to implement custom algorithms to add a proprietary IP or attempt to optimize the performance of the system.

- Changing the default application configuration

The application supports several features that can be enabled, disabled, or customized by developers. 表 2 lists the features.

表 2. Configuration of Application Features

FEATURE	DESCRIPTION	DEFINITIONS
Resonator calibration	The application periodically calibrates the resonator using the 32-kHz crystal as a reference. The resulting value is used as a correction term for ToF calculations.	USS_APP_RESONATOR_CALIBRATE
		USS_APP_RESONATOR_CALIBRATE_INTERVAL
Automatic gain control	The application periodically calculates the optimal gain setting.	USS_APP_AGC_CALIBRATE
		USS_APP_AGC_CALIBRATE_INTERVAL
DC offset cancellation	The application calculates and cancels the DC offset of the captured ADC signals.	USS_APP_DC_OFFSET_CANCELLATION
		USS_APP_DC_OFFSET_CANCELLATION_INTERVAL

The Library Users Guide included in the software package describes application customization in more detail.

3.1.2.3.2 LCD Stand-Alone Mode

The application supports a stand-alone mode that can be used to show different flow measurement results using the LCD and buttons. To enter this mode, press the SELECT navigational button. The LCD turns on to show the first of the measurements (instantaneous flow rate). Press the navigation buttons LEFT and RIGHT to scroll through the measurement results:

- Instantaneous flow rate
- Average flow rate
- Volume
- Battery voltage
- Instantaneous differential ToF

- Average differential ToF
- Standard deviation of differential ToF

Press the SELECT navigational button again to turn off the LCD and exit this mode.

☒ 14 shows the stand-alone flow chart.

☒ 14. LCD and Buttons State Machine

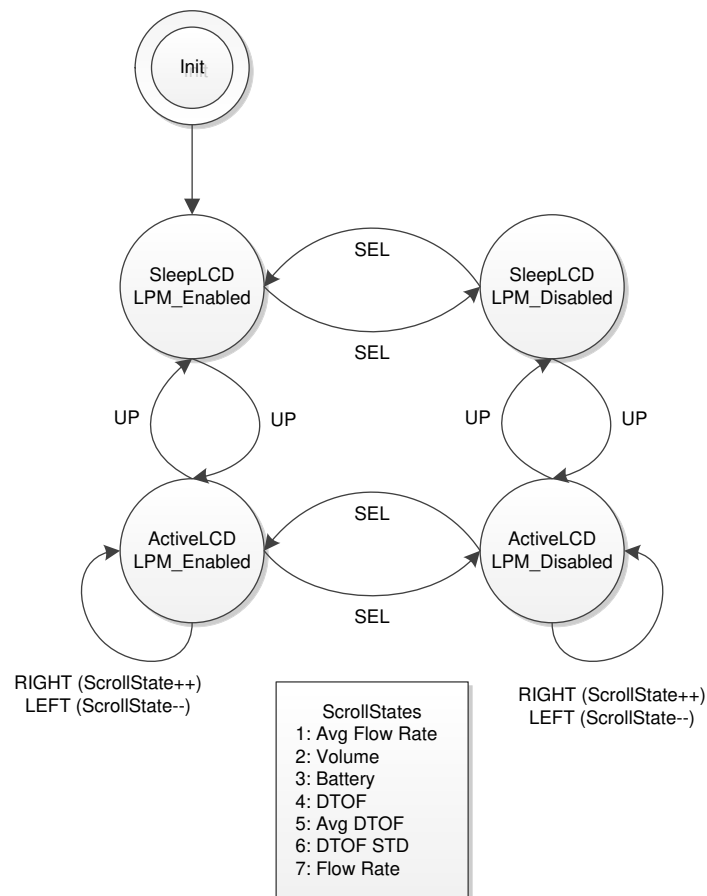

3.1.2.4 USS Design Center (PC GUI)

The MSP430 Ultrasonic Sensor Design Center Tool GUI included in this reference design lets developers modify some configuration parameters required to test different transducers, as well as observe the behavior of the system in real time.

The configuration window is shown by default when opening the application (see ☒ 15).

15. GUI Configuration Parameters Window

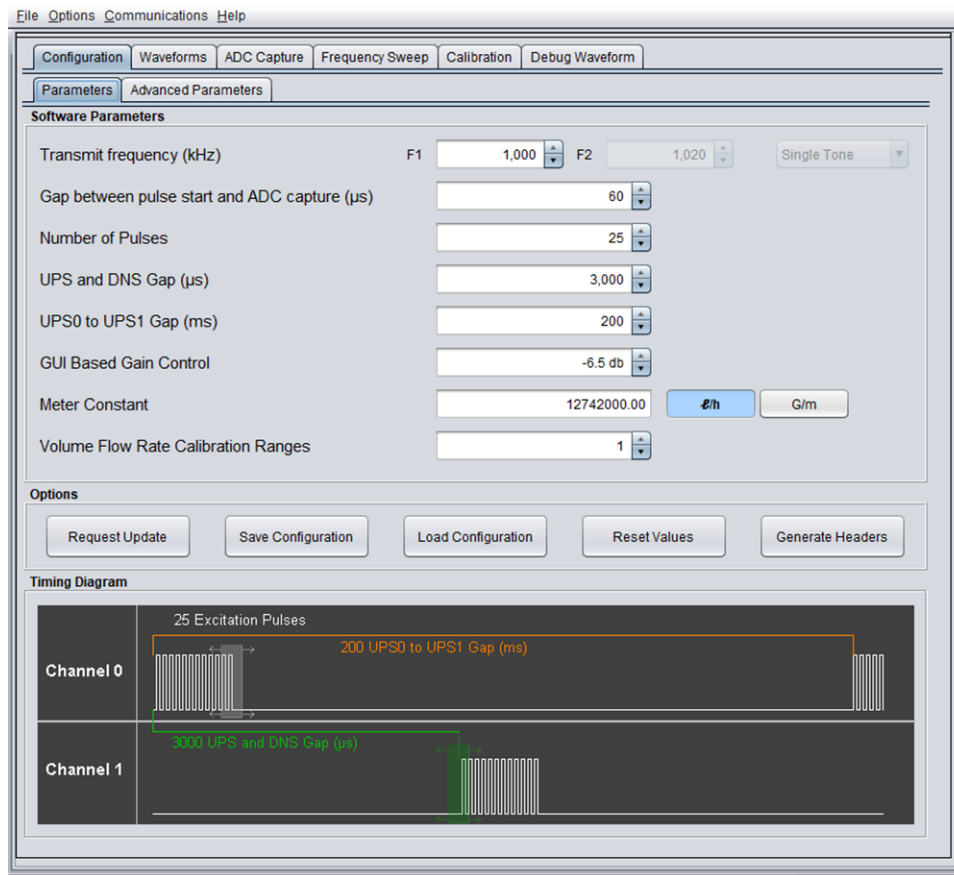

The configuration window lets developers configure the parameters detailed in 表 3.

表 3. GUI Configuration Parameters Description

PARAMETER	DESCRIPTION
Transmit Frequency (kHz)	Pulse output frequency (kHz) used to excite transducers
Gap between pulse start and ADC capture (µs)	Gap in microseconds between the generation of a pulse output and sampling of a received signal using SDHS
Number of Pulses	Number of pulses sent during pulse generation
UPS and DNS Gap (µs)	Gap in microseconds between upstream and downstream captures
UPS0 to UPS1 Gap (ms)	Gap in milliseconds between captures. This is measured from the end of the downstream capture to the start of the next upstream.
GUI-Based Gain Control	PGA gain setting in dB. This only takes specific values that are supported by the MSP430FR6043 MCU.
Meter Constant	Constant used to calculate the volume flow rate. This static constant is related to the cross section area of the meter that the vendor should provide as a one-time input. This also needs to vary depending on whether lph or gpm is used for the display.

☒ 16 shows the Advanced Parameters configuration panel.

☒ 16. GUI Advanced Parameters Configuration Window

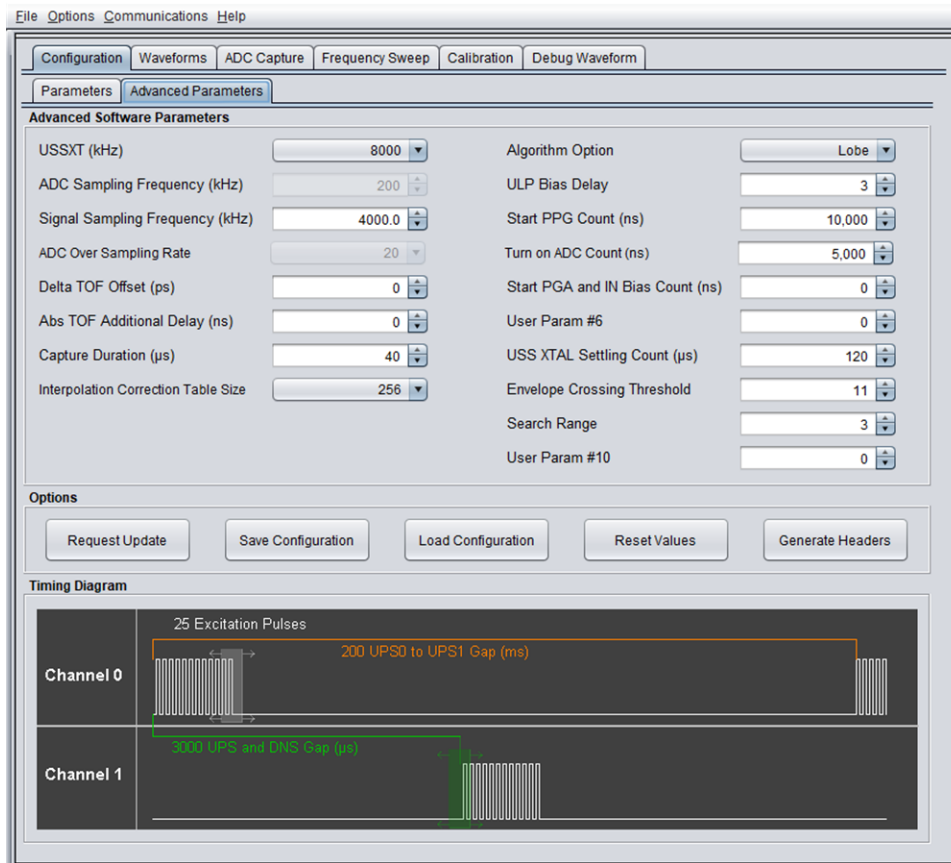

The Advanced Parameters Configuration panel lists the parameters in 表 4.

表 4. GUI Configuration Advanced Parameters Description

PARAMETER	DESCRIPTION
USSXT (kHz)	Frequency of X1 resonator in kHz connected to MSP430FR6043 on EVM430-FR6043
ADC Sampling Frequency (kHz)	Reserved
Signal Sampling Frequency (kHz)	Sampling frequency of the received signal in kHz
ADC Oversampling Rate	The design center GUI will automatically select the correct over sampling rate based on the signal sampling frequency selected. Oversampling ratio (OSR) of the SDHS. This is 10 for signal sampling frequency in the range of [6.8 to 8.0] MHz, and 20 for sampling frequency in the range of [3.4 to 4.0] MHz.
Delta ToF offset (ps)	Offset to compensate the delta ToF in picoseconds for any nonzero bias
Absolute ToF additional delay (ns)	Time in nanoseconds to compensate for unaccounted additional delays in absolute ToF
Capture Duration (μs)	Duration of the ADC capture in microseconds
Interpolation Correction Table Size	Used to enable the use of a look up table in the computation of AbsToF. This reduces the error bound of the AbsToF estimation. The error bound also reduces as the size of the table increases. The tradeoff is increase in the memory usage. Memory usage is 2xTableSize in Bytes. For example, for the table size 256, the memory usage is 512 Bytes.
Algorithm Option	Only Lobe algorithm is available for water metering
ULP Bias Delay	
Envelope Crossing Threshold	Threshold ratio from peak of AbsTOF correlation. Further details can be found in
Start PPG Count (ns)	Time to start PPG pulse trigger in nanoseconds
Turnon ADC Count (ns)	Time to turn ON the ADC in nanoseconds

表 4. GUI Configuration Advanced Parameters Description (continued)

PARAMETER	DESCRIPTION
Start PGA and IN Bias Count (ns)	Time to turn the PGA and input biasing in nanoseconds
USS XTAL Settling Count (μs)	Time allocated for USS crystal settling after initialization
User Param 8	Reserved
Search Range	Reserved
User Param 10	Reserved

The MSP430 Ultrasonic Sensor Design Center Tool lets developers observe the behavior of the system in real time by using the Waveforms window, shown in [Figure 17](#). This tool plots the delta time of flight (DTof) in the upper panel, the upstream absolute time of flight (AbsToFUPS) and downstream absolute time of flight (AbsToFDNS), and the volume flow rate (VFR). The plots include both the instantaneous measurement as well as the mean value of the measurements.

Figure 17. USS Design Center GUI Waveforms Window

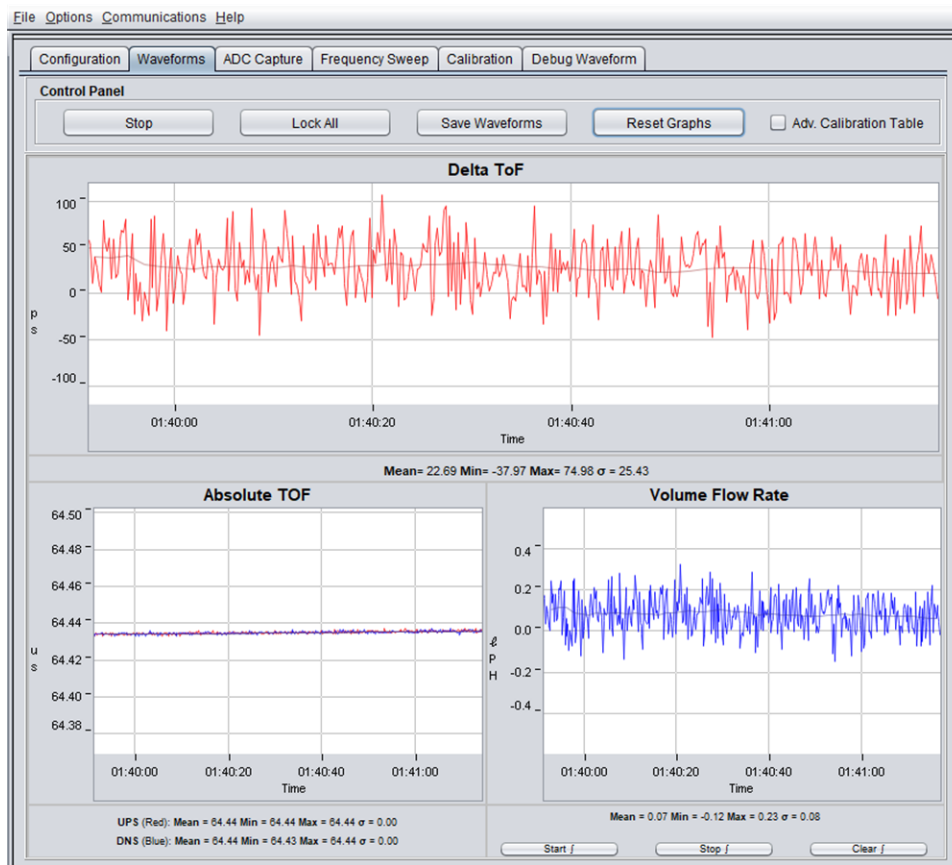

Additionally, it is also possible to obtain and plot a single capture to validate the integrity of the signal by using the ADC Capture panel (see [Figure 18](#)). The panel lets users obtain continuous captures of the ADC waveform of contiguous measurements and allows the user to do additional debugging if required.

図 18. USS Design Center ADC Waveform Capture Window

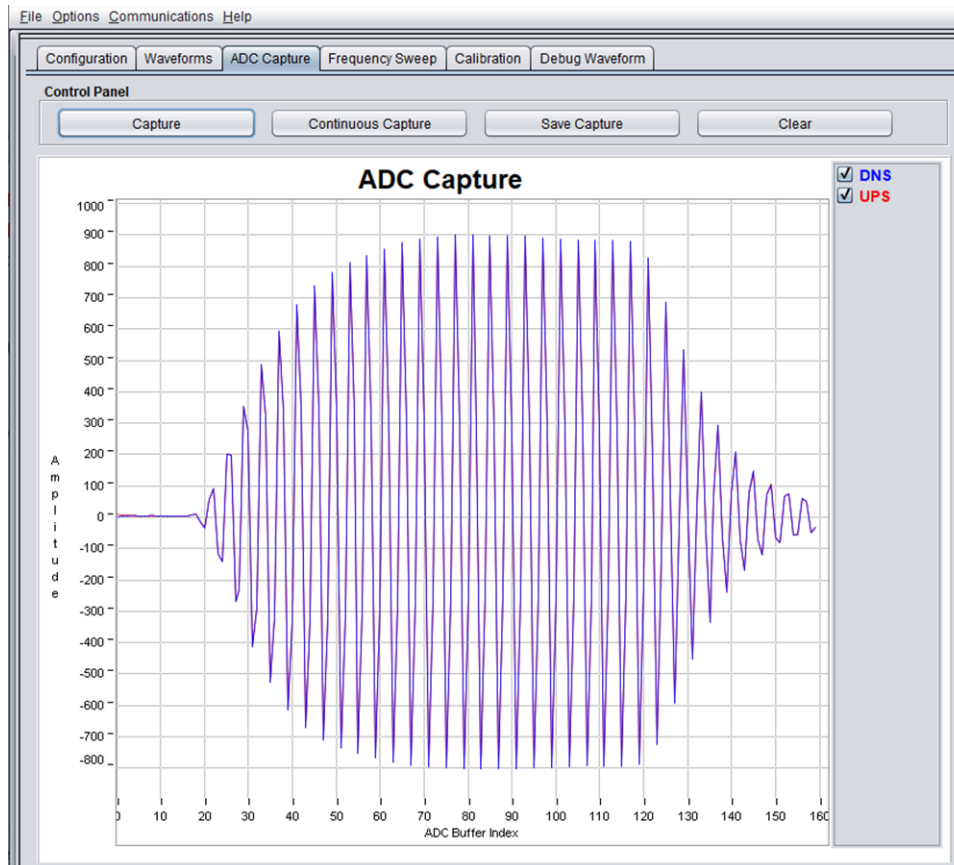

3.1.3 Transducer and Meter

The purpose of this reference design is to show the implementation of an ultrasonic front end for a flow-meter application, not the design of a transducer or meter. The test meters are based on a combination of off-the-shelf meters available from third party vendors like Audiowell. 図 19 shows the transducer connections between the meter and the EVM430-FR6043 device, with the meter in stationary (zero flow) conditions. The connections do not change even during the flow tests.

図 19. EVM430-FR6043 Connected to water-Flow Meter in Stationary Setup

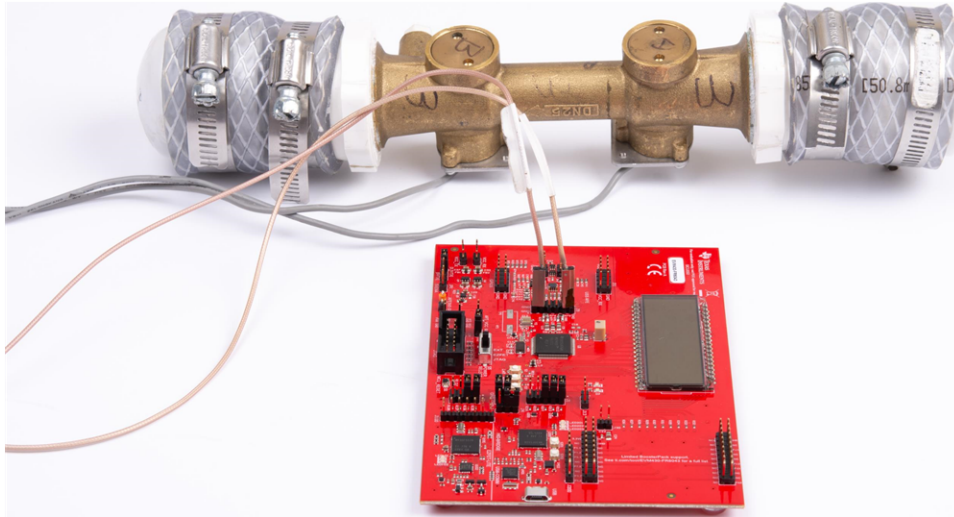

As explained in 2.2.1, an ultrasonic transmission is first generated by the first transducer and received by the second transducer after propagation through the water medium. The second transducer then emits an ultrasonic signal that is subsequently received by the first transducer. In both cases, the ultrasonic signal generated by the transducers is a result of the excitation (pulses generated) at the transducer frequency by the USS module on the MSP430FR6043 MCU.

3.1.3.1 Frequency Characterization of Transducer and Meter

Different meters and transducers have different responses; consequently, it is important to characterize the frequency response of the meter to obtain an optimal performance.

The MSP430 Ultrasonic Sensor Design Center Tool GUI provided in this reference design can be used for this purpose. The GUI includes a Frequency Sweep panel. [Ultrasonic Sensing Design Center User's Guide](#) describes the detailed operation, but a brief description is provided here for completeness.

To start a sweep, do the following:

1. Set the F1 Parameter on the Configuration tab, and then set the Number of Captures parameter in the Frequency Sweep tab to determine the range in which to sweep. For 1MHz transducers, it is recommended to sweep from 800kHz to 1200kHz
2. Click on the Frequency Sweep button and navigate to the desired location in the file system where the Frequency Sweep data is saved, and then click the Save button.

The Frequency Sweep tool helps to determine at which transducer excitation frequency the ADC capture achieves the maximum amplitude. The frequency at which the peak amplitude is reached should be used as the new F1 parameter to achieve the strongest signal for the meter configuration. For the example, in [图 20](#) a value of 1020 to 1030 should be placed into the F1 parameter.

図 20. Frequency Response Test Results

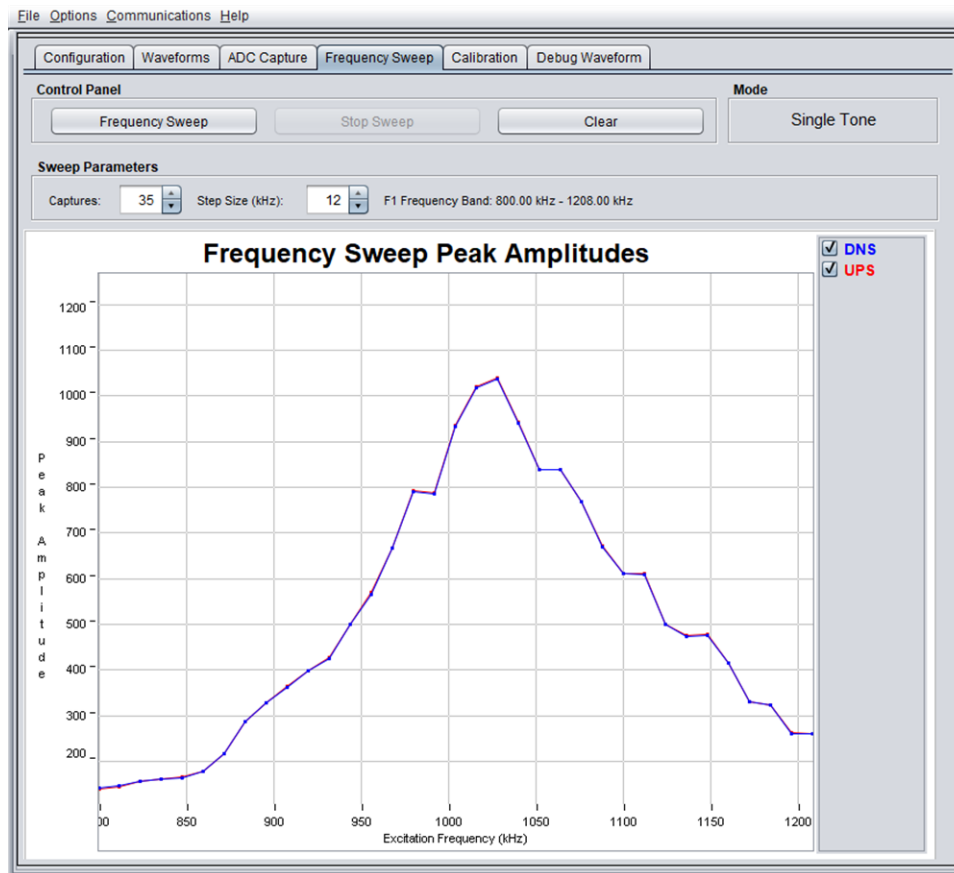

3.2 Meter Calibration

After the ultrasonic water meter parameters are set to give robust results, calibrate the meter.

To calibrate your meter using the run time calibration available in the Design Center GUI, do the following:

1. Start by setting the number of flow rate calibration ranges on the Configuration Parameters page as shown in 図 21.
2. Go to the “Waveforms” tab and select the “Adv. Calibration table” box in the top right corner.
3. Go back to the Configuration tab and click Generate Headers. Any time the number of flow rate calibration ranges changes, you must generate headers and rebuild.
4. Rebuild code with new headers and load to EVM.
5. Go to the “Waveforms” tab and be sure that “Adv. Calibration table” is not selected. This should not be selected while you are taking your calibration measurements.
6. Go to the “Calibration” tab. Enter the flow minimum and number of points for each range.
7. In the bottom section of the tab is the real-time calibration information. Take your first measurement by entering the expected VFR based on the reference meter you are using. The range number should automatically change to reflect the range this falls into. Enter the calibration point number.
8. Click “Start Calibration.” Let the calibration measurements run for the desired amount of time to get a good averaged VFR value. Click “Stop Calibration.” If you want to add the measurement to the calibration table, click “Update Calibration.” Since the actual reference flow rate during your measurements are likely not exactly the same value as entered in step 7, this expected VFR value should be updated with the actual averaged VFR from your reference. This can be accomplished by clicking the Range button and updating the expected VFR value. Repeat this step for each range and measurement point.

- When the measurements are complete and you have updated the calibration table with the values, you can go back to the “waveforms” tab and enable “Adv. Calibration table,” then click Start. The adjusted VFR results appear in the VFR graph. If you want to compare to the unadjusted results, disable the “Adv. Calibration table” box.

図 21. GUI Calibration Control Panel

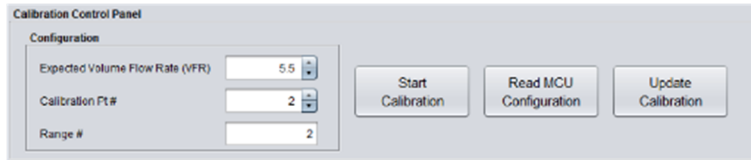

3.3 Testing and Results

3.3.1 Test Setup

This section describes how to run and demonstrate the ultrasonic flow-meter reference design.

3.3.1.1 Connecting Hardware

The following connections must be in place for the demo:

1. Configure the EVM430-FR6043 device according to the Programming configuration shown in 3.1.1.1.
2. Connect the transducers to J9 on the EVM as shown in [Figure 22](#). The GND connection is indicated on the PCB silkscreen.
3. Connect the USB of the EVM to the PC. The ultrasonic portion of the EVM430-FR6043 device is powered using an external power source for these tests and the results are presented later. When using external power, the POW_SEL switch must be set to the top position (External), see [Figure 22](#).

Figure 22. External Power to EVM

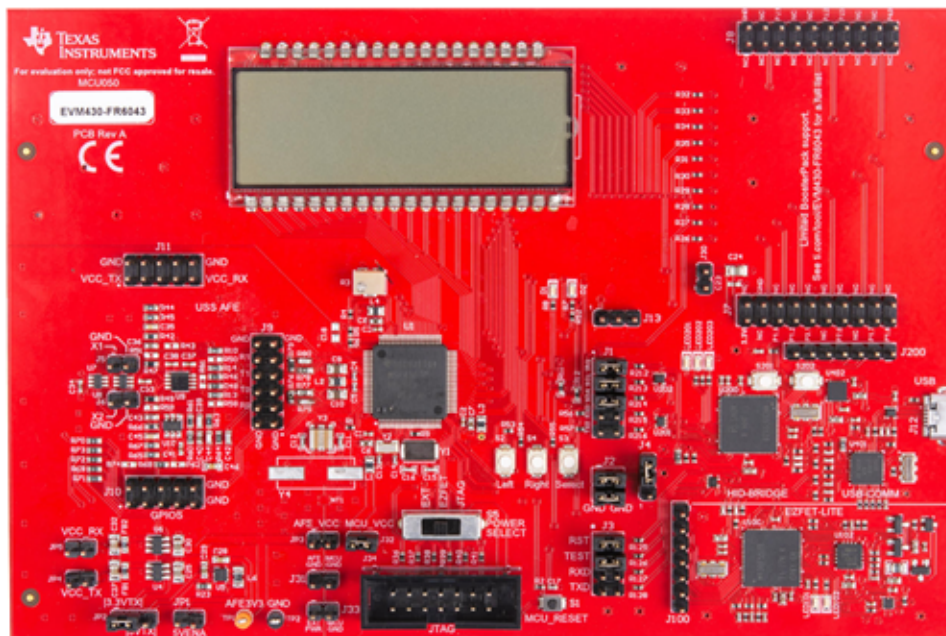

The external supply voltage must be applied to J33. GND on J1 and J3 must be connected. The TEST and RST jumpers on J3 must be connected to download code from the PC. Communication jumpers on J1 – COMM_IRQ, COMM_SDA, and COMM_SCL – are required, because the tests require communicating through USB over I²C, to collect the measurement data by the PC.

[EVM430-FR6043 Hardware Guide](#) describes the different capabilities of the EVM and the different configurations in more detail.

3.3.1.2 Building and Loading Software

The software package included in this reference design includes projects for CCS and IAR. The following sections explain how to build and load the software to the device. The latest software package can be found at [USS SW Package](#). CCS version 8.2 or newer is required.

3.3.1.2.1 Using Code Composer Studio IDE

1. Open or create a workspace.
2. Import the application project by selecting Menu → Project → Import CCS Projects, and then select the following path: <USS Flow Meter Library folder>\examples\USSLib_GUI_Demo\CCS\ (see [Figure 23](#)).

Figure 23. Import Project to CCS

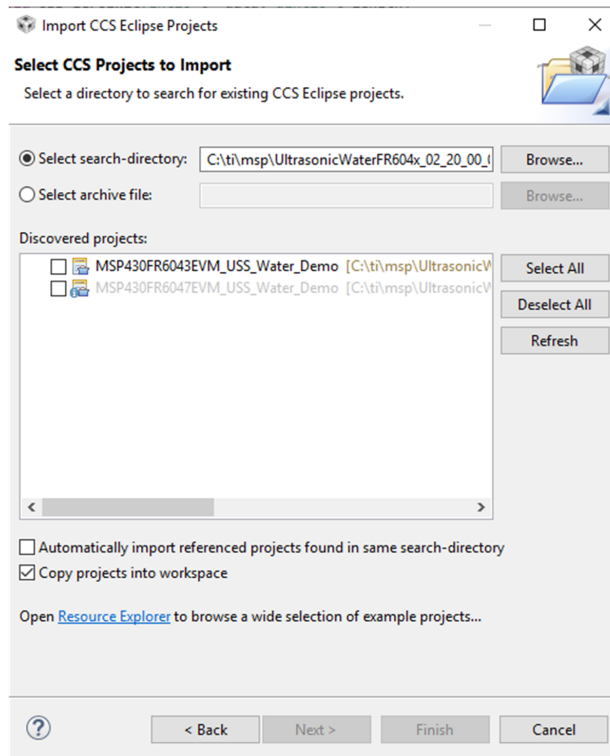

3. Build the project (Ctrl+B).
4. Download the code to the device (F11).
5. Close the debugger. It is also possible to execute or debug the application, but this design guide only shows the standalone execution.

3.3.1.2.2 Using IAR Embedded Workbench IDE

1. Open the project workspace from:
<USS Flow Meter Library folder>\examples\USSLib_GUI_Demo\IAR\USSLib_Workspace.eww.
2. Build the project (F7).
3. Download the code to the device (Ctrl+D).
4. Close the debugger. It is possible to execute or debug the application, but this design guide only shows the standalone execution.

3.3.1.3 Executing Application

1. To execute the application without debugger interaction, configure the EVM jumpers as shown in [Figure 19](#).
2. Press the EVM430-FR6043 reset button (MCU_RESET) to reset the device and execute the application. The device is programmed at this point, and the application always executes when pressing the reset button or after a power-on-reset.

3.3.1.4 Configure Device and Observe Results Using GUI

1. Launch the GUI application located in: <USS_GUI root>\USS.exe.
2. Click the *Communications* > *Connect* option in the GUI application menu.
3. Click the *Load Configuration* button to load one of the default configurations.
4. Select one of the configurations at: <Flow Library folder>\examples\gui_config\.
5. Click the *Request Update* button to send the configuration to the device.

The GUI will show a "Success" message when the configuration is successfully received by the EVM430-FR6043.

6. Check the integrity of the signal by using the *ADC Capture* window, as explained in [3.1.2.4](#).
7. Check the calculated ToF and volume in the *Waveforms* window, as explained in [3.1.2.4](#).
8. If desired, adjust the parameters and observe the impact on the captured waveform and calculations.

3.3.1.5 Customization and Optimization

The TIDM-02005 design was tested using third party meters and other proprietary meters described in 3.1.3. However, the system allows for easy customization and optimization using other transducers and meter designs.

Developers are encouraged to use the MSP430 Ultrasonic Design Center Tool GUI to adjust the different configuration parameters, to achieve the required balance between performance and power consumption.

For example, developers can select a signal sampling frequency (SIG_SAMPLING_FREQ) of 8 MHz to achieve higher resolution at the expense of higher current consumption; however, this may be unnecessary for transducers in the range of 1MHz. In such case, developers can select a sampling frequency of 3.6 or 4 MHz, which results in lower power consumption.

The following GUI parameters should be adjusted based on the characteristics of the meter and transducers:

- *Transmit Frequency (kHz)*: depends on the excitation frequency of the transducer. For example, selecting $f_1 = 1000$ kHz generates an excitation signal at 1000 kHz for a 1000-kHz transducer.
- *Gap between pulse start and ADC capture (μ s)*: depends on the dimensions of the meter and should be characterized to allow for an appropriate signal capture at different flow rates and temperature variations.
- *Number of Pulses*: affects the peak amplitude and, in turn, the energy received by the receiving transducer. This affects the SNR and the single-shot STD achieved by the meter; however, this parameter is also directly proportional to current consumption. Developers must adjust this value to generate an appropriate signal amplitude and standard deviation while meeting current consumption targets.
- *UPS and DNS gap (μ s)*: developers must select an appropriate delay, ensuring a idle channel, before the start of the next excitation.
- *UPS0 to UPS1 gap (ms)*: the gap between the end of a measurement and the start of the next measurement and it controls the measurement rate. A setting of 1000 ms gives an approximately 1-Hz measurement rate.
- *GUI based gain control*: selects the gain setting of the PGA in the USS module on the MSP430FR6043 MCU.
- *Meter constant*: constant used to calculate volume flow rate as a function of the ToF and the area of a given meter, as described in 式 4. A typical procedure to calculate this constant is to provide a constant flow (for example, 200 lph or 1 gpm) and adjust the meter constant to provide the corresponding volume flow rate using the GUI.
- *USSXT (kHz)*: selectable between 4 MHz and 8 MHz, depending on the frequency of the USSXT on the EVM430-FR6043 EVM. The EVM is usually shipped with an 8-MHz resonator and should use with this parameter set to 8 MHz. Users must set this value appropriately if using a different USSXT on the EVM.
- *SIG_SAMPLING_FREQ (kHz)*: selectable between 425 - 8,000 kHz and must be high enough to meet the Nyquist criterion for reduced error during interpolation. The recommended sampling rate is > 3.4 times of the transducer frequency. The MSP430FR6043 MCU only supports ADC sampling frequencies between [3.4 MHz to 4 MHz] or between [6.8 MHz to 8 MHz] for 1MHz or 2MHz transducers. Sampling frequencies between 4 MHz to 6.8 MHz are not supported by the device. Developers can modify it for a tradeoff between resolution and power consumption.

- *ADC Over Sampling Rate*: The design center GUI will automatically select the correct over sampling rate based on the signal sampling frequency selected. 3.4MHz to 4MHz will use over sampling rate of 20. 6.8MHz to 8MHz will use a oversampling rate of 10.
- *Delta ToF offset (ps)*: adjustment is made to the differential ToF during the calculation of volume flow rate inside the ultrasonic flow meter library. Developers can optionally make their custom calculation of the volume flow rate based on the ToF values provided by the library.
- *Absolute ToF additional delay (ns)*: adjustment is made to the absolute ToF to account for any additional delays. The value depends on the shape of the signal and the envelope threshold . Developers can optionally set this value to zero and make their own adjustments of the absolute ToF in the application layer.
- *Capture duration (μs)*: depends on the shape of the signal received from the transducer. Must be characterized to allow for an appropriate signal capture at different flow rates and temperature variations. When configuring a new pipe, it is recommended to set to a high value to find the signal. This can be reduced for lower current consumption once the signal has been identified.
- *Interpolation Correction Table Size*: used to enable the use of a look up table in the computation of AbsToF. This reduces the error bound of the AbsToF estimation. The error bound also reduces as the size of the table increases. The tradeoff is increase in the memory usage. Memory usage is 2xTableSize in Bytes. For example, for the table size 256, the memory usage is 512 Bytes.
- *ULPBiasDelay*: selects the delay in applying the bias after the initialization of the USS module. TI recommends setting this to 3 (representing 300 μs) and should not be modified.
- *Start PPG Count (ns)*: sets the delay between the start of the internal timer in the USS module in FR6043 and the start of the excitation pulses (PPG pulse trigger). TI recommends setting this to 10000 (for 10 μs) and it is not advised to modify.
- *Turn on ADC Count (ns)*: sets the delay between the start of the internal timer in the USS module in FR6043 and enables the sigma-delta high-speed ADC. TI recommends setting this to 5000 (for 5 μs) and it is not advised to modify.
- *Start PGA and IN Bias Count (ns)*: sets the delay between the start of the internal timer in the USS module in FR6043 and the start of the bias application. TI recommends setting this to 0 (for 0 μs) and it is not advised to modify.
- *USS XTAL Settling Count (μs)*: sets the settling time for USSXT. TI recommends setting this to 120 μs for the resonator (USSXT) on the EVM. Longer settling time is typically required for crystal oscillators.
- *Envelope Crossing Threshold*: Threshold ratio from peak of AbsTOF correlation. Further details can be found in

3.3.2 Test Results

This section details experimental results aggregated over multiple meters using 1-MHz transducers.

3.3.2.1 Single-Shot Standard Deviation

The single-shot standard deviation of the differential ToF is a measure used to express the expected variance of the output at zero-flow and ambient temperature (see [Figure 24](#)). The STD is calculated by executing the application at an ambient temperature and in a zero-flow condition.

☒ 24. Delta ToF Over Time

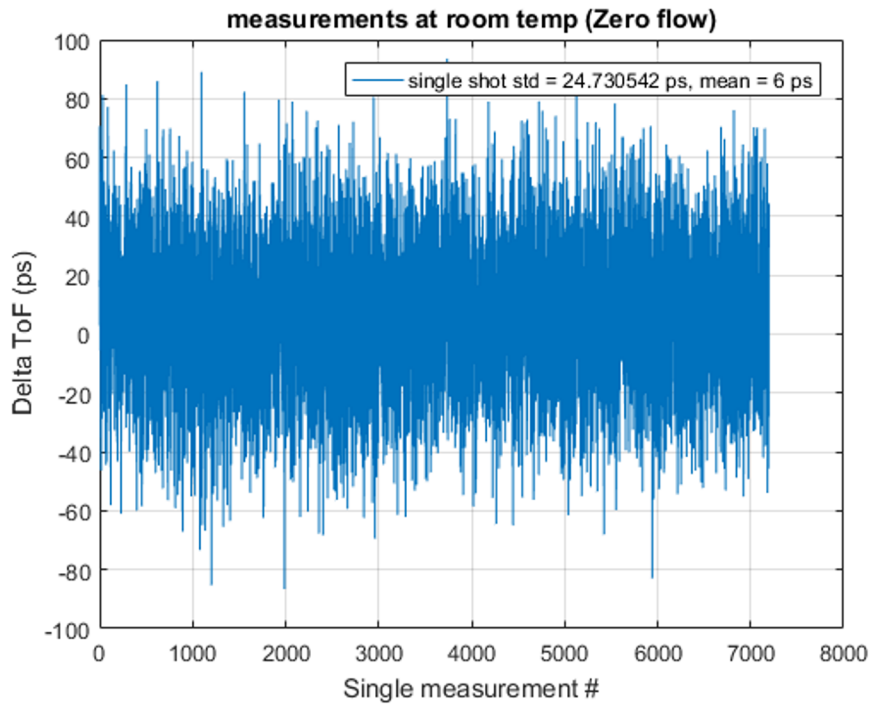

The MSP430 Ultrasonic Design Center GUI can then be used to capture the DToF for 5 to 30 minutes, and the STD can be calculated using a tool like MATLAB® or Excel®.

The single-shot STD of blocks of 200 measurements are computed and plotted in [Figure 25](#). Each plot represents single-shot STD of 200 measurements. The plot clearly shows the variation of single-shot STD is just ± 2 ps, and the average is < 25 ps.

Figure 25. Single-Shot Standard Deviation at Room Temperature

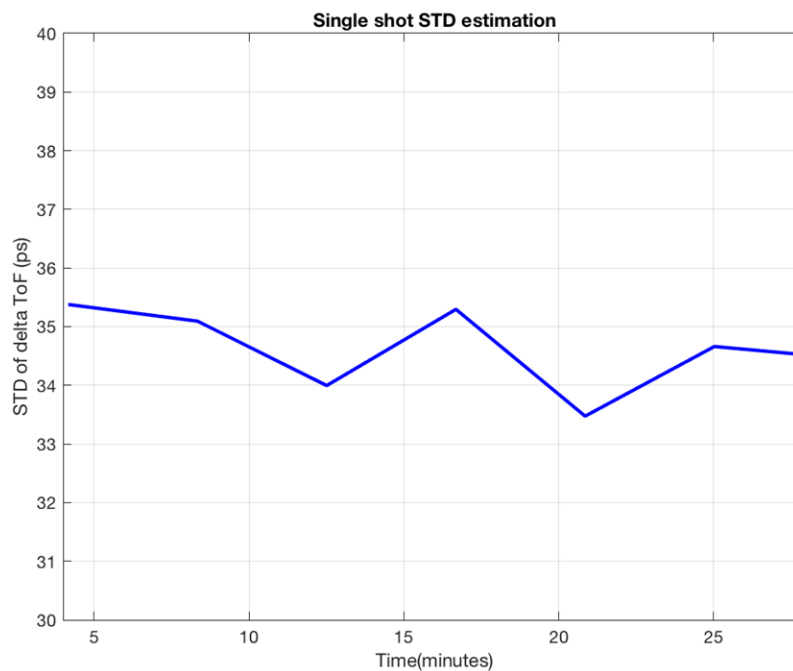

3.3.2.2 Zero-Flow Drift

Zero-flow drift (ZFD) is a measure used to express the expected drift of the DToF at zero-flow across temperature. This measure also impacts the minimal detectable flow of the meter over temperature.

With both the meter and the EVM430-FR6043 device at room temperature, the ZFD over a long duration of about 36 hours is only around 11 ps. This test is conducted where there can be small variations in ambient temperature within the test lab. The drift is within a small band of just about 6 ps.

図 26. Zero-Flow Drift of DToF at Room Temperature

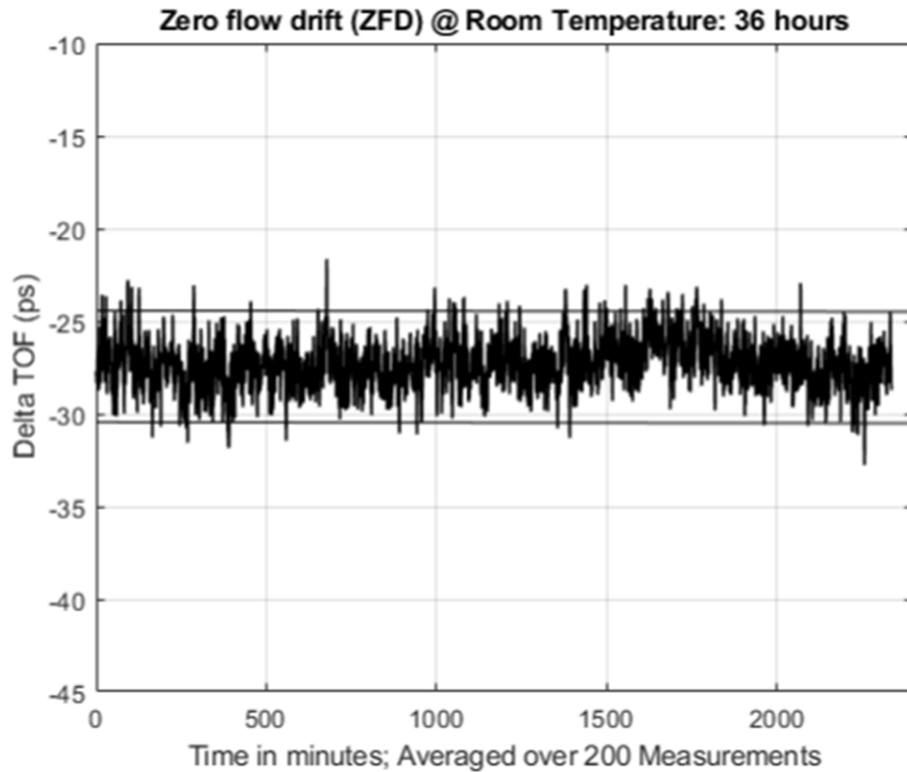

Two separate ZFD tests are conducted with variable temperature, both of which are at zero flow. A meter in-oven test varies the temperature of the water/meter over a 5°C to 85°C range, while the electronics (EVM430-FR6043) are at room temperature. The device in-oven test varies the temperature of the electronics over -40°C to +85°C, while the meter/water are placed at room temperature.

図 27. Zero Flow Drift of DToF With Meter In-Oven

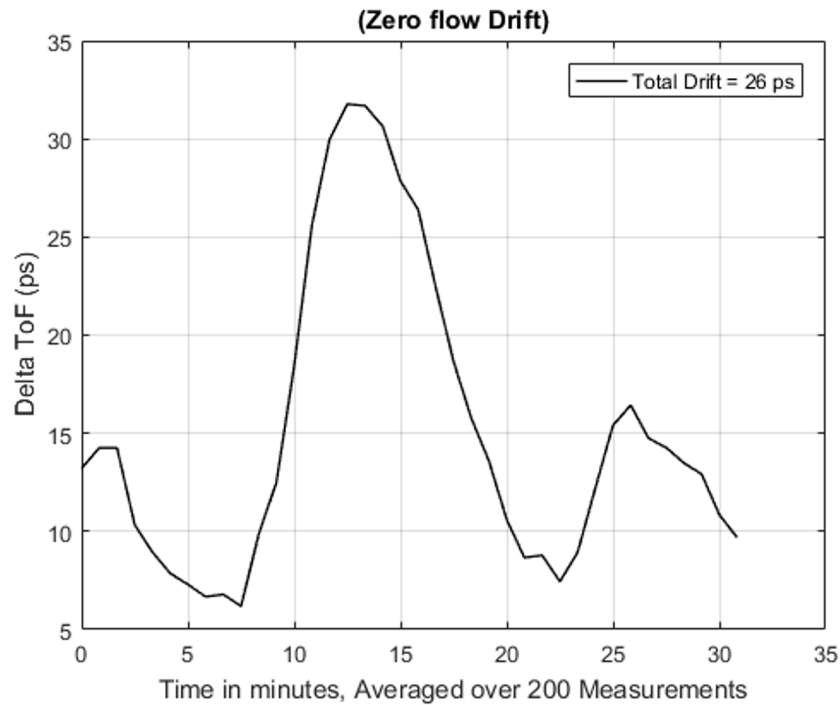

ZFD is calculated by obtaining the range of the differential ToF averaged over 200 samples. The MSP430 Ultrasonic Design Center GUI can be used to capture the differential ToF, while tools like MATLAB or Excel can be used to calculate the average over 200 samples and the total drift.

☒ 28 shows the resulting differential ToF across temperatures, averaged over 200 samples.

☒ 28. Zero Flow Drift of DToF With EVM430-FR6043 In-Oven

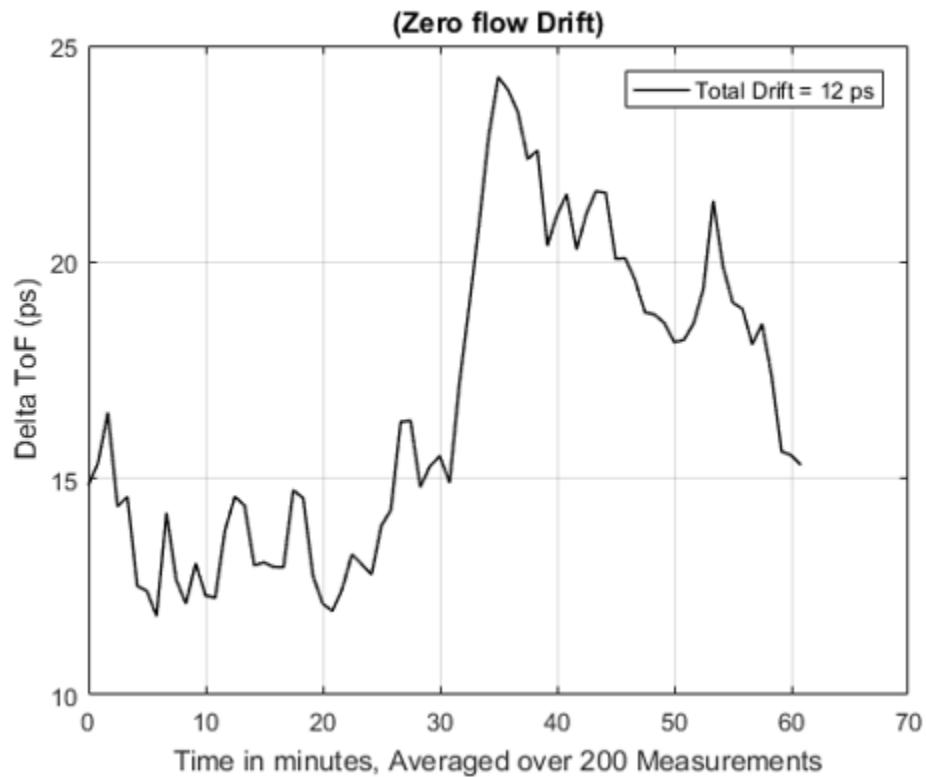

3.3.2.3 Absolute Time of Flight Measurements

Variation of the absolute time of flight (AbsToF) measurements is also an important metric in both flow meter applications as well as other applications like mixture analysis. The important metric in the case of AbsToF is also the drift over time as well as the standard deviation of the measurements. ☒ 29 shows a zoomed in plot of the drift over 36 hours of measurements.

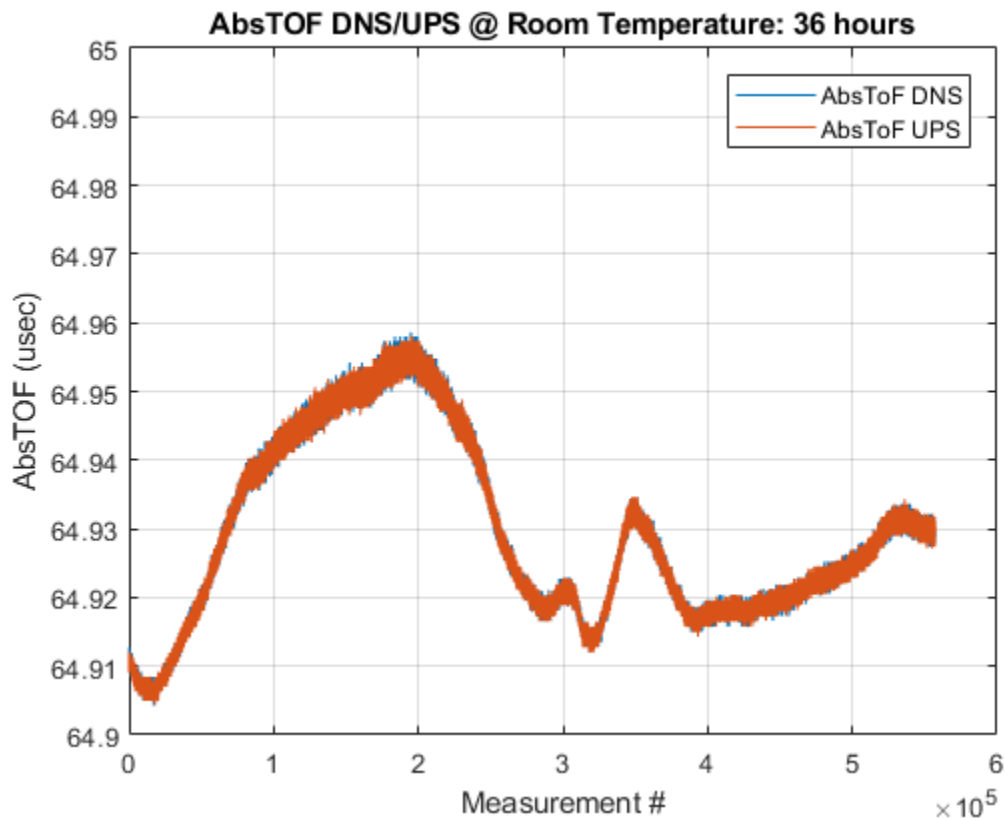
図 29. AbsToF Measurement Over 36 Hours

3.3.2.4 Flow Measurements

The flow measurements were performed on a third party DN-25 brass pipe (Audiowell) and transducer that is easily available and can be obtained independently of Texas Instruments. The Audiowell pipe housed transducers that have a nominal excitation frequency of 1 MHz.

The [MSP430FR6047 and Ultrasonic Software Based Water Flow Meter Measurement Results](#) application note contains more details of the flow test bench used for the flow measurements.

30. Flow Measurement

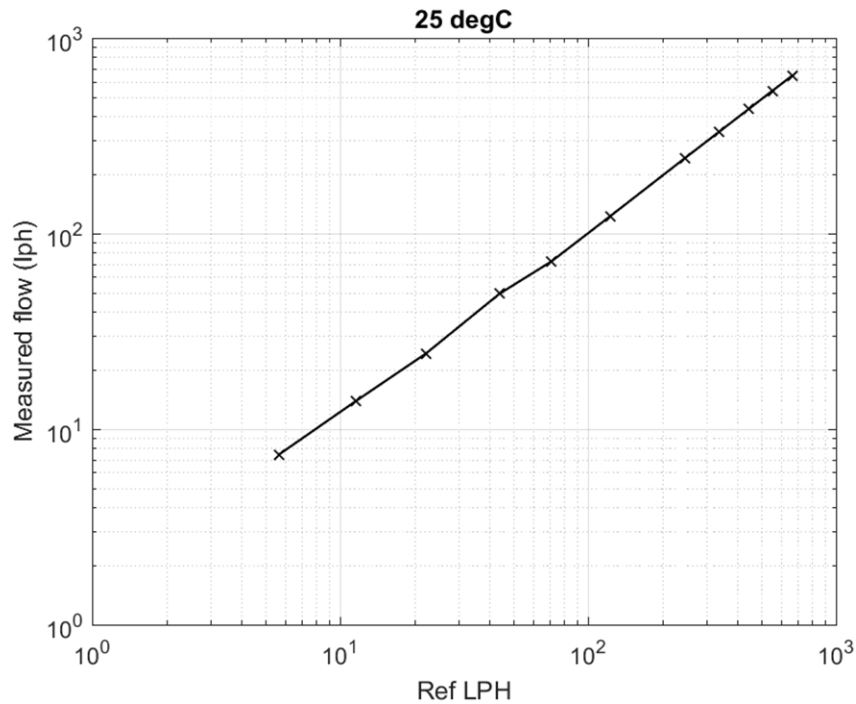

3.3.2.5 Average Power Consumption

The average power consumption is an important consideration for power-restricted systems, such as battery-operated water-flow meters.

The power consumption of the device depends on several different parameters, which can be configured using the MSP430 Ultrasonic Design Center GUI. These parameters include the transducer frequency, number of pulses, gap between UPS and DNS, measurement rate (DNS-UPS gap), signal sampling frequency, and capture duration.

The optimal configuration of these parameters depends on the meter and a trade-off between performance and power consumption exists (see [Figure 31](#)).

Figure 31. Profile of Current Consumption During Duration of Measurement

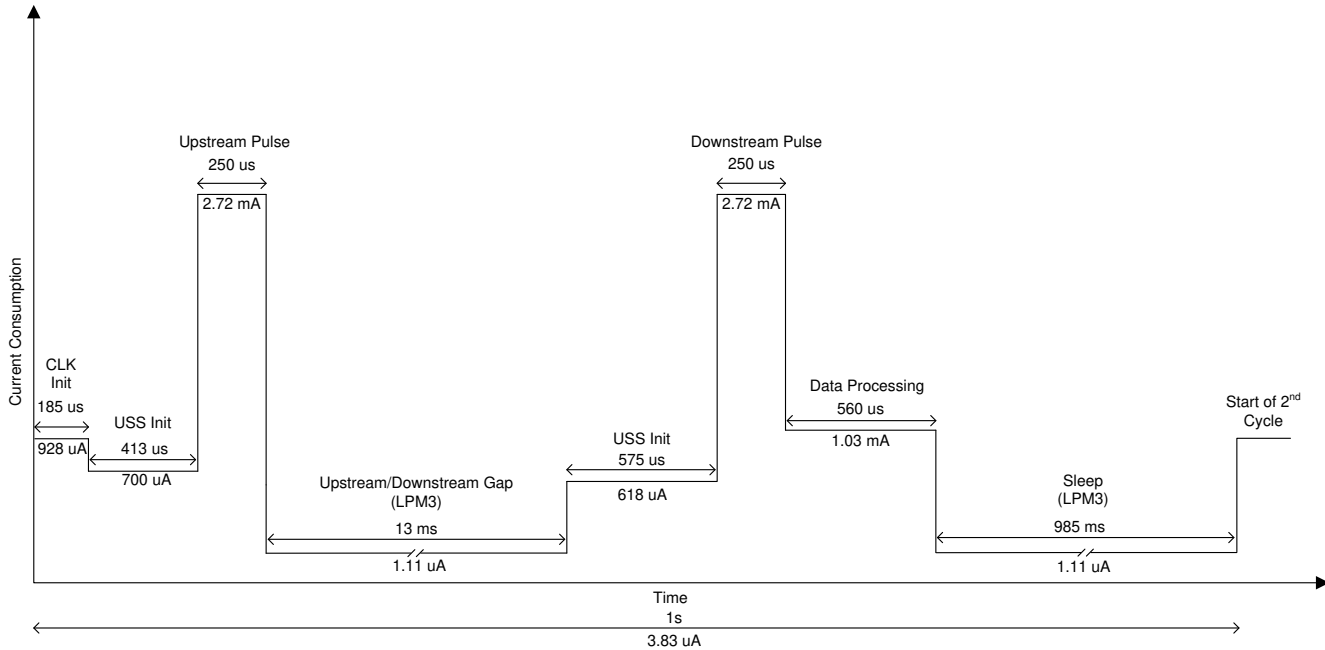

The current profile in [Figure 31](#) is based on a water meter pipe and the MSP430FR6043 device, with parameters configured as listed in [Table 5](#). For brevity, it does not include configuration parameters that have no impact on current consumption.

Table 5. Configuration for Current Measurements

TRANSMIT FREQUENCY (kHz)	1000 kHz
Gap between pulse start and ADC capture (μ s)	62 μ s
Number of pulses	20
UPS and DNS gap (μ s)	13,000 (for 13 ms)
UPS0 to UPS1 gap (ms)	990 ms
Signal Sampling Frequency (kHz)	3600 kHz
ADC Over Sampling Rate	20
Delta ToF offset (ps)	0
Absolute ToF additional delay (ns)	0
Capture duration (μ s)	40 μ s
ULP Bias Delay	3 (for 300 μ s)
Start PPG Count (ns)	10,000 (for 10 μ s)
Turn on ADC count (ns)	5,000 (for 5 μ s)
Start PGA and IN Bias Count (ns)	0
USS XTAL Settling Count (μ s)	120 μ s

As shown in [図 31](#), the instantaneous current consumption varies depending on the state of the software. The different states and the functionality of each state is enumerated in [表 6](#).

表 6. States in Each Measurement for Current Consumption

STATE	DURATION	CURRENT CONSUMPTION (INSTANTANEOUS, CONTRIBUTION)	DESCRIPTION OF STATE
CLK INIT	185 μ s	928 μ A (0.172 μ A)	Initialization of USSXT. The USS module is powered OFF.
USS INIT (UPS)	413 μ s	700 μ A (0.289 μ A)	The USS module is powered ON and registers of all submodules are initialized.
UPSTREAM PULSE	250 μ s	2.72 mA (0.68 μ A)	Upstream pulse firing and signal capture
UPSTREAM/DOWNSTREAM GAP	13 ms	1.11 μ A (0.014 μ A)	Gap between UPS and DNS. CPU is in LPM3 mode.
USS INIT (DNS)	575 μ s	618 μ A (0.355 μ A)	Prior to DNS firing, the USS module is powered ON and registers of all submodules are initialized.
DOWNSTREAM PULSE	250 μ s	2.72 mA (0.68 μ A)	DNS pulse firing and signal capture
DATA PROCESSING	560 μ s	1.03 mA (0.577 μ A)	DToF, AbsToF, and VFR computation; The USS module is powered DOWN.
SLEEP	985 ms	1.11 μ A (1.093 μ A)	Gap between the end of a measurement and start of the next measurement. CPU is in LPM3 mode. USS is OFF.

3.3.2.6 Memory Footprint

The memory footprint provides an estimate of the memory requirements for implementing an ultrasonic water flow meter application. [表 7](#) lists the memory use across FRAM, RAM, and LEARAM, as well as between the USSSW Library and the demonstration application that encapsulates the Library API calls and interfaces to the USS Design Center GUI. The memory size is listed in KB (Kilobytes). The memory footprint tabulates the memory used with the CCS IDE. The memory use is similar with the IAR IDE.

表 7. Memory Footprint

PARAMETER	BUILD CONDITIONS	TYPICAL MEMORY (KB)
Total FRAM used by demonstration application (MEM _{APP_FRAM})	Includes code and constants	58.5
Total RAM used by demonstration application (MEM _{APP_RAM})	Includes variables placed in RAM	2.6
LEARAM used by library (MEM _{LIB_LEARAM})	Includes all library variables and data structures used by the application and library	4.8

4 Design Files

4.1 Schematics

To download the schematics, see the design files at [TIDM-02005](#).

4.2 Bill of Materials

To download the bill of materials (BOM), see the design files at [TIDM-02005](#).

4.3 PCB Layout Recommendations

General PCB guidelines should be followed to ensure accurate measurements and proper operation. See [MSP430FR6043 data sheet](#) for detailed information regarding PCB layout recommendations.

4.3.1 Layout Prints

To download the layer plots, see the design files at [TIDM-02005](#).

4.4 Altium Project

To download the Altium project files, see the design files at [TIDM-02005](#).

4.5 Gerber Files

To download the Gerber files, see the design files at [TIDM-02005](#).

4.6 Assembly Drawings

To download the assembly drawings, see the design files at [TIDM-02005](#).

5 Software Files

To download the software files, see the design files at [TIDM-02005](#).

6 Related Documentation and References

1. [MSP430FR604x, MSP430FR504x ultrasonic sensing MSP430™ microcontrollers for water and water flow metering applications](#)
2. [MSP430FR58xx, MSP430FR59xx, and MSP430FR6xx Family User's Guide](#)
3. [Quick Start Guide for MSP430FR6043-Based Ultrasonic Water Flow Meter](#)
4. [EVM430-FR6043 Hardware Guide](#)
5. [Application software \(SW\) for MSP430FR6043-based ultrasonic water flow meter](#)
6. [Ultrasonic Design Center User's Guide](#)
7. [Low-Energy Accelerator \(LEA\) Frequently Asked Questions \(FAQ\)](#)
8. [Benchmarking the Signal Processing Capabilities of the Low-Energy Accelerator on MSP430 MCUs](#)
9. [MSP430FR6047 and Ultrasonic Software Based Water Flow Meter Measurement Results](#)
10. [Designing with MSP430 MCUs and Segment LCDs](#)
11. [National Physical Labs \(NPL\), Underwater Acoustics, Technical Guides - Speed of Sound in Pure Water](#)
12. [D.Marioli, C.Narduzzi, C.Offelli, D.Petri, E.Sardini, A.Taroni, Digital time of flight for ultrasonic sensors, IEEE Transactions on Instrumentation and Measurement, Vol. 41, No. 1, February 1992](#)
13. [Charles Knapp, Clifford Carter, The generalized correlation method for estimation of time delay, IEEE Transactions on Acoustics, Speech and Signal Processing, No. 4, August 1976](#)

14. *A Comparison of Time Delay Estimation Methods for Periodic Signals*, Travis Wiens, Stuart Bradley, *IEEE Transactions on Instrumentation and Measurement*, Vol. 41, No. 1, February 1992

6.1 商標

E2E, MSP430, BoosterPack, MSP430Ware, Code Composer Studio are trademarks of Texas Instruments. IAR Embedded Workbench is a registered trademark of IAR Systems.

MATLAB is a registered trademark of MathWorks, Inc.

Excel is a registered trademark of Microsoft Corporation.

すべての商標および登録商標はそれぞれの所有者に帰属します。

7 Terminology

ADC— analog-to-digital converter

DNS— Downstream acquisition

DToF— Delta (differential) time of flight

gpm— Gallons per minute

GUI— Graphical user interface

LCD— Liquid crystal display

LEA— Low energy accelerator

lph— Liters per hour

MCU— Microcontroller

MTIF— Metering test interface

SDHS— Sigma-delta high-speed ADC

ToF— Time of flight

UPS— Upstream acquisition

USS— Ultrasonic Sensing Solution module

8 About the Authors

Eddie LaCost is a systems applications engineer in the MSP430 FRAM Ultrasonic Applications team at Texas Instruments, where he is responsible for developing hardware reference design solutions and supporting customer applications for the ultrasonic flow metering market. Eddie has previously worked with NFC/RFID products at Texas Instruments where he published several application notes and reference designs using MSP430 MCUs.

Leonardo Estevez is a systems applications engineer in the MSP430 FRAM Ultrasonic Applications team at Texas Instruments, where he is responsible for developing system and software reference design solutions and supporting customer applications for the ultrasonic flow metering market. Leo has previously worked with various DSP and wireless products at Texas Instruments where he published several papers and reference designs for smartphone and wireless sensing applications.

改訂履歴

資料番号末尾の英字は改訂を表しています。その改訂履歴は英語版に準じています。

	Page
2019年8月発行のものから更新	
• paragraph 変更	11
• image 変更	12

重要なお知らせと免責事項

TI は、技術データと信頼性データ(データシートを含みます)、設計リソース(リファレンス・デザインを含みます)、アプリケーションや設計に関する各種アドバイス、Web ツール、安全性情報、その他のリソースを、欠陥が存在する可能性のある「現状のまま」提供しており、商品性および特定目的に対する適合性の黙示保証、第三者の知的財産権の非侵害保証を含むいかなる保証も、明示的または黙示的にかかわらず拒否します。

これらのリソースは、TI 製品を使用する設計の経験を積んだ開発者への提供を意図したものです。(1) お客様のアプリケーションに適した TI 製品の選定、(2) お客様のアプリケーションの設計、検証、試験、(3) お客様のアプリケーションに該当する各種規格や、その他のあらゆる安全性、セキュリティ、規制、または他の要件への確実な適合に関する責任を、お客様のみが単独で負うものとし、

上記の各種リソースは、予告なく変更される可能性があります。これらのリソースは、リソースで説明されている TI 製品を使用するアプリケーションの開発の目的でのみ、TI はその使用をお客様に許諾します。これらのリソースに関して、他の目的で複製することや掲載することは禁止されています。TI や第三者の知的財産権のライセンスが付与されている訳ではありません。お客様は、これらのリソースを自身で使用した結果発生するあらゆる申し立て、損害、費用、損失、責任について、TI およびその代理人を完全に補償するものとし、TI は一切の責任を拒否します。

TI の製品は、[TI の販売条件](#)、または [ti.com](https://www.ti.com) やかかる TI 製品の関連資料などのいずれかを通じて提供する適用可能な条項の下で提供されています。TI がこれらのリソースを提供することは、適用される TI の保証または他の保証の放棄の拡大や変更を意味するものではありません。

お客様がいかなる追加条項または代替条項を提案した場合でも、TI はそれらに異議を唱え、拒否します。

郵送先住所 : Texas Instruments, Post Office Box 655303, Dallas, Texas 75265

Copyright © 2022, Texas Instruments Incorporated