

Temperature Sensing PTC Circuit With MSP430™ Smart Analog Combo



Design Goals

Temperature		Output voltage		Supply		
T_{Min}	T_{Max}	V_{outMin}	V_{outMax}	V_{dd}	V_{ee}	V_{ref}
0°C	50°C	0.15V	3.15V	3.3V	0V	1.646V

Design Description

Some MSP430™ microcontrollers (MCUs) contain configurable integrated signal chain elements such as op-amps, DACs, and programmable gain stages. These elements make up a peripheral called the Smart Analog Combo (SAC). For information on the different types of SACs and how to leverage their configurable analog signal chain capabilities, visit [MSP430 MCUs Smart Analog Combo Training](#). To get started with your design, download the [MSP430 Temp Sense PTC Circuit Code Examples and SPICE Simulation File](#).

This temperature sensing circuit uses a resistor in series with a positive-temperature-coefficient (PTC) thermistor to form a voltage divider, which produces an output voltage that is linear over temperature. The circuit uses the [MSP430FR2311](#) SAC_L1 op-amp in a noninverting amplifier configuration with inverting reference to offset and amplify the signal, which helps to use the full ADC resolution and increase measurement accuracy. (Note: The [MSP430FR2355](#) features four SAC_L3 peripherals which each contain a built-in DAC and PGA, providing a single-chip solution for generating V_{ref} and measuring the thermistor circuit.) The output of the integrated SAC op-amp can be sampled directly by the on-board ADC or monitored by the on-board comparator for further processing inside the MCU.

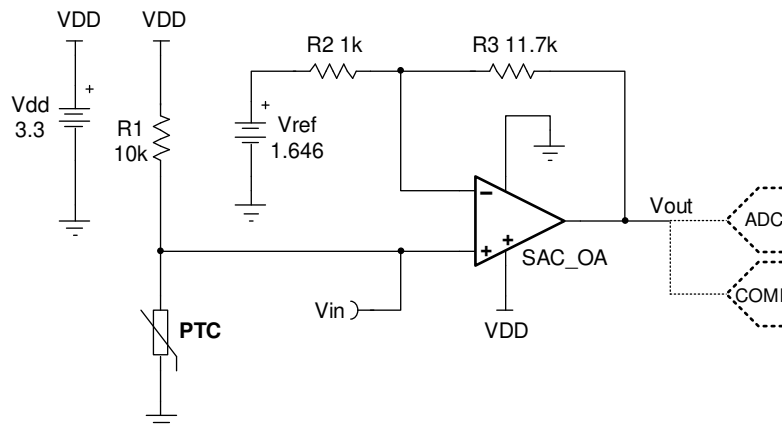

Design Notes

- The connection, V_{in} , is a positive temperature coefficient output voltage. To measure the output voltage of a negative-temperature-coefficient (NTC) thermistor, switch the position of R_1 and the PTC resistor.
- V_{ref} can be generated by the integrated SAC_L3 DACs in the MSP430FR2355 or a voltage divider. If a voltage divider is used, the equivalent resistance of the voltage divider affects the gain of the circuit.
- Using high-value resistors can degrade the phase margin of the amplifier and introduce additional noise in the circuit. It is recommended to use resistor values around 10kΩ or less.

- If the solution is implemented using the MSP430FR2311, the SAC_L1 op-amp is configured in general purpose mode to measure the thermistor circuit.
- If the solution is implemented using the MSP430FR2355, one SAC_L3 peripheral is configured in DAC mode to generate the reference voltage and another is configured in general purpose mode to measure the thermistor circuit.

Design Steps

$$V_{out} = V_{dd} \times \frac{R_{PTC}}{R_{PTC} + R_1} \times \frac{R_2 + R_3}{R_2} - \frac{R_3}{R_2} \times V_{ref} \quad (1)$$

1. Calculate the value of R_1 to produce a linear output voltage. Use the minimum and maximum values of the PTC to obtain a range of values for R_1 .

$$R_{PTC_Max} = R_{PTC} @ 50^\circ C = 11.611 \text{ k}\Omega \quad (2)$$

$$R_{PTC_Min} = R_{PTC} @ 0^\circ C = 8.525 \text{ k}\Omega$$

$$R_1 = \sqrt{R_{PTC} @ 0^\circ C \times R_{PTC} @ 50^\circ C} = \sqrt{8.525 \text{ k}\Omega \times 11.611 \text{ k}\Omega} = 9.95 \text{ k}\Omega \approx 10 \text{ k}\Omega$$

2. Calculate the input voltage range.

$$V_{inMin} = V_{dd} \times \frac{R_{PTC_Min}}{R_{PTC_Min} + R_1} = 3.3 \text{ V} \times \frac{8.525 \text{ k}\Omega}{8.525 \text{ k}\Omega + 10 \text{ k}\Omega} = 1.519 \text{ V} \quad (3)$$

$$V_{inMax} = V_{dd} \times \frac{R_{PTC_Max}}{R_{PTC_Max} + R_1} = 3.3 \text{ V} \times \frac{11.611 \text{ k}\Omega}{11.611 \text{ k}\Omega + 10 \text{ k}\Omega} = 1.773 \text{ V}$$

3. Calculate the gain required to produce the maximum output swing.

$$G_{ideal} = \frac{V_{outMax} - V_{outMin}}{V_{inMax} - V_{inMin}} = \frac{3.15 \text{ V} - 0.15 \text{ V}}{1.773 \text{ V} - 1.519 \text{ V}} = 11.811 \frac{\text{V}}{\text{V}} \quad (4)$$

4. Select R_2 and calculate R_3 to set the gain calculated in Step 3.

$$\text{Gain} = \frac{R_2 + R_3}{R_2} \quad (5)$$

$$R_2 = 1 \text{ k}\Omega$$

$$R_3 = R_2 \times (G_{ideal} - 1) = 1 \text{ k}\Omega \times (11.811 - 1) = 10.811 \text{ k}\Omega$$

$$\text{Choose } R_3 = 10.7 \text{ k}\Omega \text{ (Standard value)}$$

5. Calculate the actual gain based on standard values of R_2 and R_3 .

$$G_{actual} = \frac{R_2 + R_3}{R_2} = \frac{1 \text{ k}\Omega + 10.7 \text{ k}\Omega}{1 \text{ k}\Omega} = 11.7 \frac{\text{V}}{\text{V}} \quad (6)$$

6. Calculate the output voltage swing based on the actual gain.

$$V_{out_swing} = (V_{inMax} - V_{inMin}) \times G_{actual} = (1.773 \text{ V} - 1.519 \text{ V}) \times 11.7 \frac{\text{V}}{\text{V}} = 2.9718 \text{ V} \quad (7)$$

7. Calculate the maximum output voltage when the output voltage is symmetrical around mid-supply.

$$V_{outMax} = V_{mid - supply} + \frac{V_{out_swing}}{2} = \frac{V_{dd} - V_{ee}}{2} + \frac{V_{out_swing}}{2} = \frac{3.3 \text{ V} - 0 \text{ V}}{2} + \frac{2.9718 \text{ V}}{2} = 3.136 \text{ V} \quad (8)$$

8. Calculate the reference voltage.

$$V_{outMax} = V_{inMax} \times G_{actual} - \frac{R_3}{R_2} \times V_{ref} \quad (9)$$

$$3.136 \text{ V} = 1.773 \text{ V} \times 11.7 \frac{\text{V}}{\text{V}} - \frac{10.7 \text{ k}\Omega}{1 \text{ k}\Omega} \times V_{ref}$$

$$V_{ref} = \frac{1.773 \text{ V} \times 11.7 \frac{\text{V}}{\text{V}} - 3.136 \text{ V}}{\frac{10.7 \text{ k}\Omega}{1 \text{ k}\Omega}} = 1.646 \text{ V}$$

Design Simulations

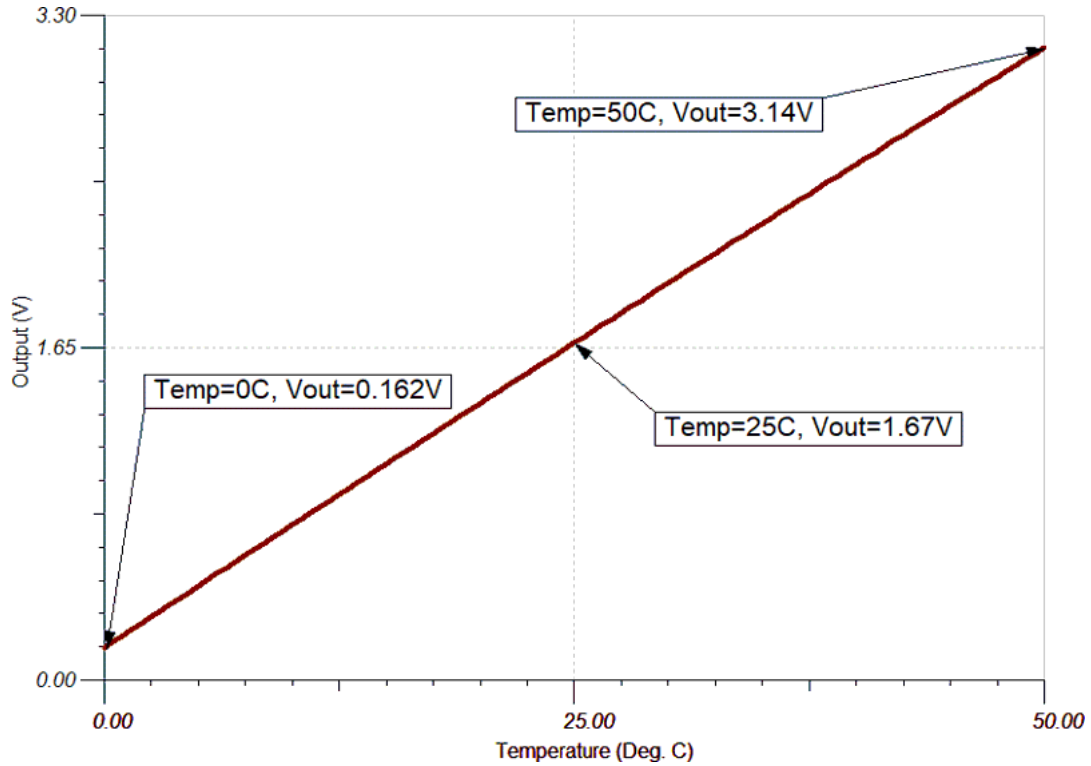

DC Transfer Results

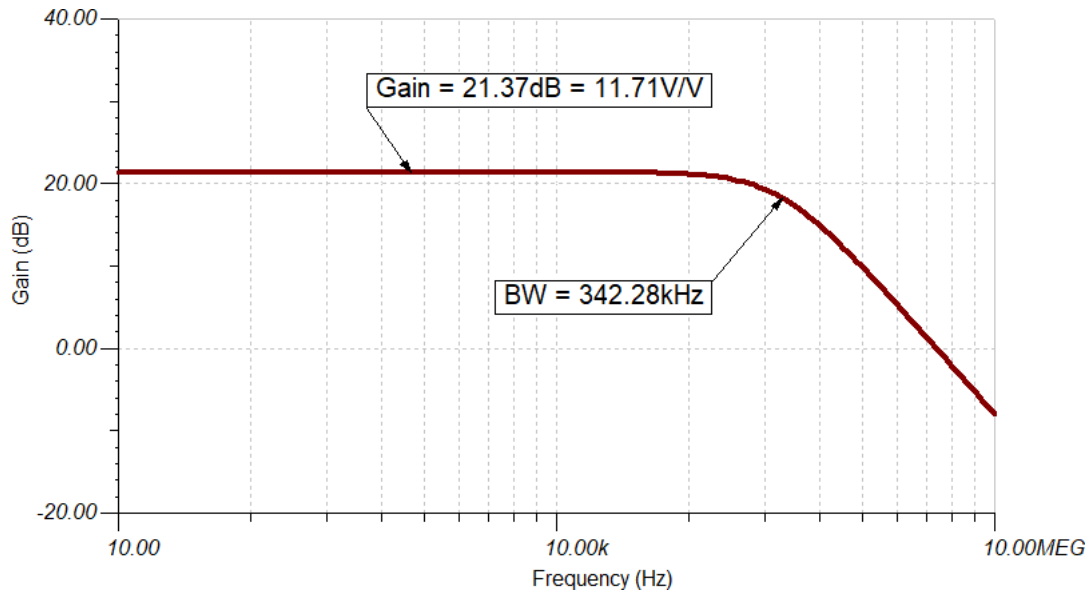

AC Simulation Results

Target Applications

- [Field temperature transmitters](#)
- [Thermostats](#)
- [Thermometers](#)
- [Thermistor probes](#)
- [System temperature monitor](#)

References

Texas Instruments, [MSP430 MCUs Smart Analog Combo Training](#), video

Texas Instruments, [TINA-TI](#), analog simulation program

Texas Instruments, [MSP430 Temp Sense PTC Circuit Code Examples and SPICE Simulation File](#), software support

Design Featured Op Amp

MSP430FRxx Smart Analog Combo		
	MSP430FR2311 SAC_L1	MSP430FR2355 SAC_L3
V_{CC}	2.0V to 3.6V	
V_{CM}	-0.1V to $V_{CC} + 0.1V$	
V_{out}	Rail-to-rail	
V_{os}	$\pm 5mV$	
A_{OL}	100dB	
I_q	350 μA (high-speed mode)	
	120 μA (low-power mode)	
I_b	50pA	
UGBW	4MHz (high-speed mode)	2.8MHz (high-speed mode)
	1.4MHz (low-power mode)	1MHz (low-power mode)
SR	3V/ μs (high-speed mode)	
	1V/ μs (low-power mode)	
Number of channels	1	4
	MSP430FR2311	MSP430FR2355

Design Alternate Op Amp





MSP430FR2311 Transimpedance Amplifier	
V_{CC}	2.0V to 3.6V
V_{CM}	-0.1V to $V_{CC}/2V$
V_{out}	Rail-to-rail
V_{os}	$\pm 5mV$
A_{OL}	100dB
I_q	350 μA (high-speed mode)
	120 μA (low-power mode)
I_b	5pA (TSSOP-16 with OA-dedicated pin input)
	50pA (TSSOP-20 and VQFN-16)
UGBW	5MHz (high-speed mode)
	1.8MHz (low-power mode)
SR	4V/ μs (high-speed mode)
	1V/ μs (low-power mode)
Number of channels	1
	MSP430FR2311

Design Featured Thermistor

TMP61	
V_{CC}	Up to 5.5V
R_{25}	10k Ω
R_{TOL}	1%

TMP61	
I_{SNS}	400 μ A
Operating temperature range	-40°C to 125°C
TMP61	

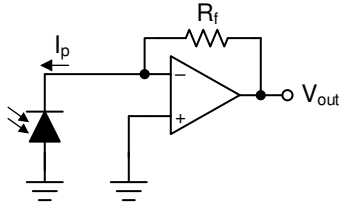
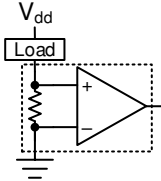
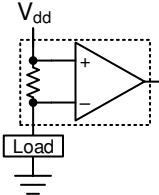
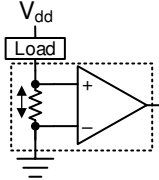
Related MSP430 Circuits

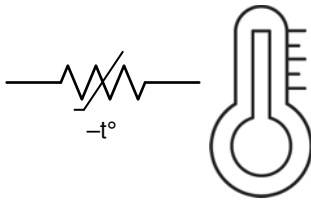
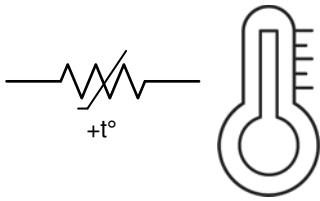
<p>Low-noise and long-range PIR sensor conditioner circuit</p> 	<p>Bridge amplifier circuit</p> 	<p>Transimpedance amplifier circuit</p> 
<p>Single-supply, low-side, unidirectional current-sensing circuit</p> 	<p>High-side current sensing with discrete difference amplifier circuit</p> 	<p>Low-side, bidirectional current-sensing circuit</p> 
<p>Half-wave rectifier circuit</p> 	<p>Temperature sensing with NTC thermistor circuit</p> 	<p>Temperature sensing with PTC thermistor circuit</p> 

Trademarks

MSP430™ is a trademark of Texas Instruments.
All trademarks are the property of their respective owners.

Revision History

NOTE: Page numbers for previous revisions may differ from page numbers in the current version.

Changes from Revision B (March 2020) to Revision C (September 2024)	Page
• Updated the format for tables, figures, and cross-references throughout the document.....	1

Changes from Revision A (September 2019) to Revision B (March 2020)	Page
• Added <i>Related MSP430 Circuits</i> section.....	1

Changes from Revision * (September 2019) to Revision A (October 2019)	Page
• Updated the first paragraph in <i>Design Description</i>	1

IMPORTANT NOTICE AND DISCLAIMER

TI PROVIDES TECHNICAL AND RELIABILITY DATA (INCLUDING DATA SHEETS), DESIGN RESOURCES (INCLUDING REFERENCE DESIGNS), APPLICATION OR OTHER DESIGN ADVICE, WEB TOOLS, SAFETY INFORMATION, AND OTHER RESOURCES "AS IS" AND WITH ALL FAULTS, AND DISCLAIMS ALL WARRANTIES, EXPRESS AND IMPLIED, INCLUDING WITHOUT LIMITATION ANY IMPLIED WARRANTIES OF MERCHANTABILITY, FITNESS FOR A PARTICULAR PURPOSE OR NON-INFRINGEMENT OF THIRD PARTY INTELLECTUAL PROPERTY RIGHTS.

These resources are intended for skilled developers designing with TI products. You are solely responsible for (1) selecting the appropriate TI products for your application, (2) designing, validating and testing your application, and (3) ensuring your application meets applicable standards, and any other safety, security, regulatory or other requirements.

These resources are subject to change without notice. TI grants you permission to use these resources only for development of an application that uses the TI products described in the resource. Other reproduction and display of these resources is prohibited. No license is granted to any other TI intellectual property right or to any third party intellectual property right. TI disclaims responsibility for, and you will fully indemnify TI and its representatives against, any claims, damages, costs, losses, and liabilities arising out of your use of these resources.

TI's products are provided subject to [TI's Terms of Sale](#) or other applicable terms available either on [ti.com](https://www.ti.com) or provided in conjunction with such TI products. TI's provision of these resources does not expand or otherwise alter TI's applicable warranties or warranty disclaimers for TI products.

TI objects to and rejects any additional or different terms you may have proposed.

Mailing Address: Texas Instruments, Post Office Box 655303, Dallas, Texas 75265
Copyright © 2024, Texas Instruments Incorporated