

Application Note

TPS257xx-Q1 System Power Management



Seong Kim

ABSTRACT

The USB Type-C® and Power Delivery (PD) specification has expanded the capability of USB ports including support for higher power delivery over USB connection. With the widespread adoption of USB Type-C and PD applications and portable devices that can charge over USB, it has become increasingly important for single or multi-port charger systems to intelligently manage power schemes for reliable and safe operation.

This application note describes how the TPS2576x-Q1 and TPS2577x-Q1 family of USB Type-C PD controllers enable power delivery over USB for robust and reliable system operation using the System Power Management (SPM) Engine.

Table of Contents

| | |
|--|----|
| 1 Introduction | 3 |
| 1.1 Terms and Abbreviations..... | 3 |
| 2 SPM Engine Overview | 4 |
| 3 Multi-Port Power Allocation Policy | 5 |
| 3.1 Assured Capacity Policy..... | 6 |
| 3.2 Shared Capacity Policy..... | 8 |
| 3.3 Hybrid Mode..... | 11 |
| 4 Power Foldback Policy | 13 |
| 4.1 Thermal Foldback Operation..... | 13 |
| 4.2 Engine On/Off Transition Management..... | 16 |
| 5 Multi-Port Power Allocation Policy Examples | 20 |
| 5.1 Assured Capacity Policy Example..... | 20 |
| 5.2 Fair Share Power Policy Example..... | 23 |
| 5.3 Hybrid Mode Example..... | 35 |
| 6 References | 39 |
| 7 Revision History | 39 |

List of Figures

| | |
|--|----|
| Figure 2-1. TPS257xx-Q1 SPM Engine Block Diagram..... | 4 |
| Figure 3-1. SPM Engine Configurable Parameters – Advanced Configuration..... | 5 |
| Figure 3-2. Assured Capacity Policy..... | 6 |
| Figure 3-3. Assured Policy GUI Selection – Advanced Configuration..... | 7 |
| Figure 3-4. Shared Capacity Policy..... | 8 |
| Figure 3-5. Shared Capacity GUI Selection – Advanced Configuration..... | 8 |
| Figure 3-6. Hybrid Mode GUI Selection - Advanced Configuration..... | 11 |
| Figure 3-7. USB Type-C Current – Advanced Configuration..... | 12 |
| Figure 4-1. NTC Input Voltage Threshold and Thermal Phase..... | 13 |
| Figure 4-2. Thermistor Implementation Options..... | 14 |
| Figure 4-3. Thermal Foldback GUI Entry Example | 14 |
| Figure 4-4. I2C Temp Sensor and Thermistor Configuration Example..... | 15 |
| Figure 4-5. VIN Level and Engine On or Off Power Transition..... | 17 |
| Figure 4-6. Engine On or Off GUI Entry Example..... | 18 |
| Figure 5-1. Assured Capacity Policy Negotiation Flow - Port A Connected..... | 21 |
| Figure 5-2. Assured Capacity Policy Negotiation Flow - Port B Connected..... | 22 |
| Figure 5-3. FSP Negotiation Flow - Scenario 1..... | 24 |
| Figure 5-4. FSP Negotiation Flow - Scenario 2..... | 25 |
| Figure 5-5. FSP Negotiation Flow With Blind Sink Support – Scenario 1..... | 28 |

| | |
|--|----|
| Figure 5-6. FSP Negotiation Flow With Blind Sink Support – Scenario 2..... | 29 |
| Figure 5-7. FSP Negotiation Flow With Blind Sink Support – Scenario 3..... | 30 |
| Figure 5-8. FSP Negotiation With Blind Sink Support and Max Power - Scenario 1..... | 32 |
| Figure 5-9. FSP Negotiation With Blind Sink Support and Max Power - Scenario 2..... | 33 |
| Figure 5-10. FSP Negotiation With Blind Sink Support and Max Power - Scenario 3..... | 34 |
| Figure 5-11. Hybrid Mode Negotiation Flow - Scenario 1..... | 36 |
| Figure 5-12. Hybrid Mode Negotiation Flow - Scenario 2..... | 37 |
| Figure 5-13. Hybrid Mode Negotiation Flow - Scenario 3..... | 38 |

List of Tables

| | |
|--|----|
| Table 1-1. Terms and Abbreviations..... | 3 |
| Table 3-1. SPM Engine Parameters..... | 5 |
| Table 3-2. Fair Share Power Policy Parameters..... | 9 |
| Table 3-3. Example Scenarios and Corresponding Power Distribution..... | 9 |
| Table 3-4. Difference Between Blind Sink Disable and Enable..... | 10 |
| Table 3-5. Hybrid Mode Parameters..... | 11 |
| Table 4-1. Thermal Phase Parameters..... | 14 |
| Table 4-2. NTC Thermistor Phase Configured Values..... | 15 |
| Table 4-3. I2C Temperature Sensor Phase Configured Values..... | 15 |
| Table 4-4. VIN Threshold Parameters..... | 16 |
| Table 4-5. Configurable Timer Parameters..... | 16 |
| Table 4-6. SPM Engine Parameters - Engine On/Off Power Foldback Example..... | 19 |
| Table 4-7. Engine On/Off Power Foldback Operation Example..... | 19 |
| Table 5-1. SPM Engine Parameters - Assured Capacity Policy Example..... | 20 |
| Table 5-2. Assured Capacity Policy Example..... | 20 |
| Table 5-3. SPM Engine Parameters - FSP Example With Good Sinks..... | 23 |
| Table 5-4. Fair Share Power Policy Parameters..... | 23 |
| Table 5-5. FSP Example with Good Sinks..... | 23 |
| Table 5-6. SPM Engine Parameters - FSP Example with a Blind Sink..... | 26 |
| Table 5-7. Fair Share Power Policy Parameters..... | 26 |
| Table 5-8. FSP Example With Blind Sink Support..... | 26 |
| Table 5-9. FSP Example With Blind Sink Support and Max Power..... | 31 |
| Table 5-10. SPM Engine Parameters - Hybrid Mode Example..... | 35 |
| Table 5-11. Hybrid Mode Parameters..... | 35 |
| Table 5-12. Hybrid Mode Example..... | 35 |

Trademarks

USB Type-C® is a registered trademark of USB Implementers Forum.
 All trademarks are the property of their respective owners.

1 Introduction

The TPS2576x-Q1 and TPS2577x-Q1 devices belong to a family of USB Type-C PD controllers for use in single or multi-port charging or data USB system applications. The TPS2576x-Q1 and TPS2577x-Q1 family supports an integrated System Power Management (SPM) Engine that manages multi-port power allocation policies (in the case of the TPS25772-Q1 dual-port PD controller) and dynamically adjusts USB port power based on events such as these: Connect or disconnect of a Sink device and its Sink Capabilities, thermal events measured through an external thermistor or temperature sensor, and engine status detected through a change in input supply voltage.

1.1 Terms and Abbreviations

Table 1-1. Terms and Abbreviations

| Term | Description |
|---------------------|--|
| Blind Sink | A Sink not returning Sink Capabilities per system power requirement. |
| Contract | An agreement on power level reached between a Source and Sink. |
| FSP | Fair Share Power |
| Good Sink | A Sink correctly returning Sink Capabilities per system power requirement. |
| Negotiation | The PD process between a Sink and Source: <ul style="list-style-type: none"> The Sources advertises its Source Capabilities. The Sink requests one of the advertised capabilities. The Source accepts the request and provides power accordingly <p>The results of the negotiation is a Contract for power delivery/consumption between the TPS257xx-Q1 and Sink devices.</p> |
| PD | USB Power Delivery |
| Port Partner | A USB Type-C PD device or host that is connected to a TPS257xx-Q1 port. In the scope of this application note, Port Partner is used to indicate a Sink. |
| PDO | Power Data Object. What is used to expose a Source's power capabilities or a Sink's power requirements. |
| Sink | The Port Partner consuming power from VBUS; most commonly a device. In this application note, Sink refers to devices connected to the TPS257xx-Q1. |
| Sink Capabilities | A PD message reported by the Sink, which includes PDO to convey Sink's operational power requirements. Also referred to as Sink Cap. |
| Source | The Port Partner supplying power over VBUS; most commonly a downstream facing port. In this application note, Source refers to the TPS257xx-Q1. |
| Source Capabilities | A PD message reported by the Source, which includes PDO to convey Source's capabilities to provide power. Also referred to as Source Cap. |
| SPM Engine | The TPS257xx-Q1's integrated subsystem responsible for the operational function of the System Power Management |

2 SPM Engine Overview

The TPS257xx-Q1's SPM Engine contains two main subsystems (Figure 2-1): the Multi-Port Power Allocation Policy and the Power Foldback Policy. Note that the Multi-Port Power Allocation Policy is specific to the TPS25772-Q1 dual-port PD controller as the TPS2576x-Q1 device is a single-port PD controller and contains only the Power Foldback Policy block. For the TPS25772-Q1, the two subsystems of the SPM Engine work in conjunction to support dynamic power adjustments in response to different types of power events.

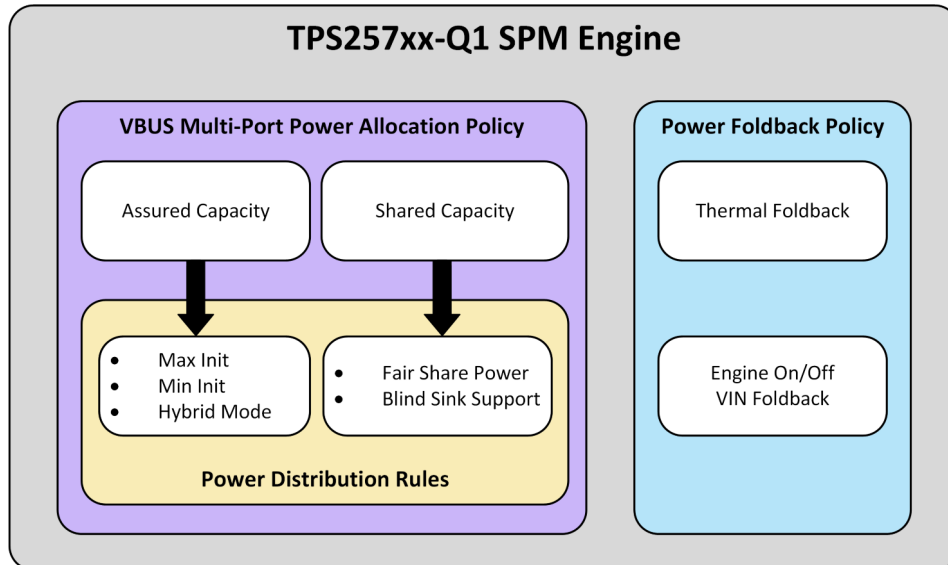

Figure 2-1. TPS257xx-Q1 SPM Engine Block Diagram

There are two types of Multi-Port Power Allocation Policies supported by the TPS25772-Q1: Assured Capacity Policy and Shared Capacity Policy. Only one policy can be enabled per SPM system. The Assured Capacity Policy allows power to be allocated to a port independent of the second port's status while Shared Capacity Policy allows the total available system power to be shared by both ports.

- Assured Capacity Policy: Source port has a fixed allocated amount of power and able to deliver its max power capacity independent of the second port's status. For more details, see [Section 3.1](#).
- Shared Capacity Policy: Source port has a dynamically allocated amount of power and able to deliver up to its max power capacity depending on the remaining available system power that is shared with the second port. For more details, see [Section 3.2](#).

The Multi-Port Power Allocation Policies regulates how the total system power is allocated to the ports. The Power Distribution Rules determine how the allocated power is distributed to connected Sinks. The Assured Capacity Policy and Shared Capacity Policy can be enabled with one of their respective power distribution methods as listed in the Power Distribution Rules block in [Figure 2-1](#). These Power Distribution Rules are discussed in more detail in the subsequent sections.

The Power Foldback Policy supports dynamic power adjustment in response to power related activities such as thermal and supply voltage events to meet operational safety requirements and works in conjunction with the Multi-Port Power Allocation Policy. For more details, see [Section 4](#).

Note

The SPM Engine is responsible for managing VBUS power only. VCONN power is outside the scope of the SPM operation. The system shall allocate power budget for the VCONN power separately. For more information, see the device-specific data sheets.

3 Multi-Port Power Allocation Policy

The SPM Engine, which contains the Multi-port Power Allocation Policy, is configurable using the [TPS257XX-Q1-GUI](#). The following parameters are configured per system requirements for correct SPM operations.

Table 3-1. SPM Engine Parameters

| SPM Engine Parameters | Description |
|-----------------------|---|
| System Max Power | Total system power capacity that is allocated to all ports |
| Port Max Power | Maximum VBUS power for each port. Power contract is limited to the maximum value configured in this parameter |
| Port Min Power | Minimum VBUS power for each port. Minimum power configured in this parameter is designed for each port. |

The SPM Engine parameters can be configured from the GUI's Advanced Configuration View menu. Refer to the [TPS257xx-Q1 GUI Configuration Guide](#) for more information. [Figure 3-1](#) shows the GUI's SPM power parameter configuration in the Advanced Configuration view.

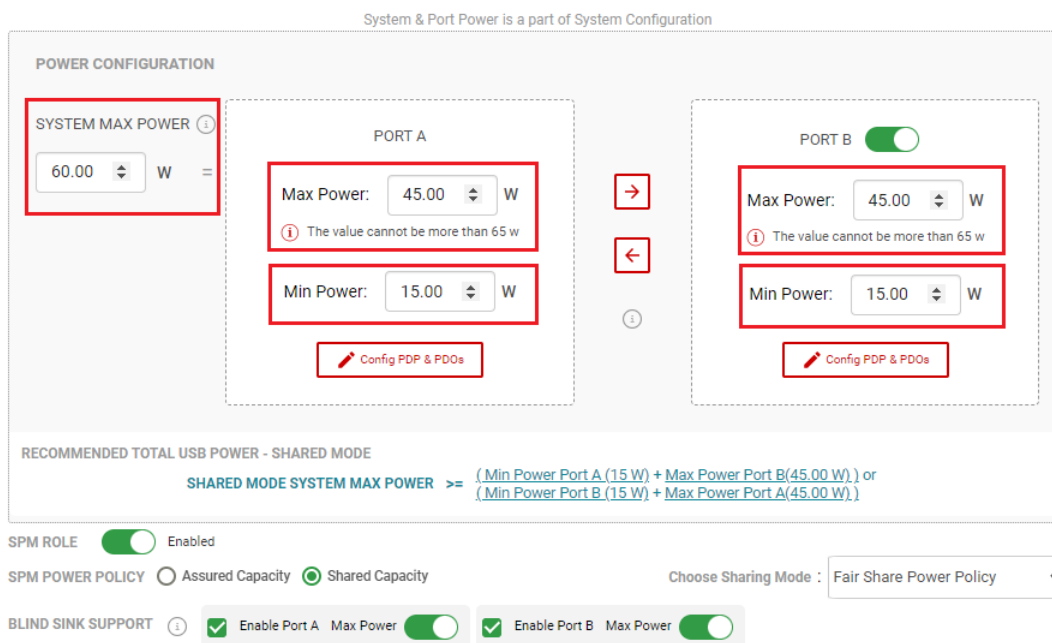

Figure 3-1. SPM Engine Configurable Parameters – Advanced Configuration

3.1 Assured Capacity Policy

The Assured Capacity Policy is where the sum of the Port Max Power, as designed, is equal to the System Max Power.

$$\text{System Max Power} = \text{Port A Max Power} + \text{Port B Max Power} \quad (1)$$

When the Source ports are configured as Assured Capacity, Port Max Power is **guaranteed** and each port is able to deliver up to its Port Max Power independent of the second port's status. An example of the Assured Capacity Policy is shown in [Figure 3-2](#) where the System Max Power is 60W, Port A's Max Power is 40W, and Port B's Max Power is 20W.

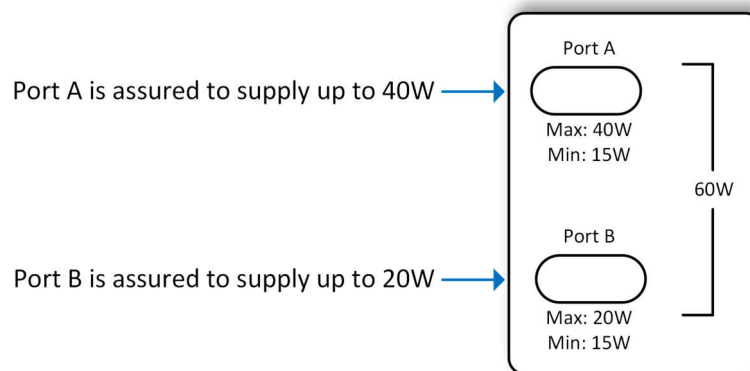

Figure 3-2. Assured Capacity Policy

The TPS25772-Q1 dual-port PD controller supports two Assured Capacity power modes configurable using the [TPS257XX-Q1-GUI](#). The options are:

- Max Init (Initialization) Power: Upon connection, the Source will initially send Source Capabilities advertising the maximum power as configured in the GUI.
- Min Init (Initialization) Power: Upon connection, the Source will initially send Source Capabilities advertising the minimum power as configured in the GUI. Depending upon the responding Sink Capability, the TPS257xx will resend Source Capabilities accordingly.

The recommendation is to always configure for *Max Init Power* (default GUI setting) unless a different operational mode is preferred based on system requirements. [Figure 3-3](#) shows the Assured Capacity Policy selection in the GUI's Advanced Configuration view.

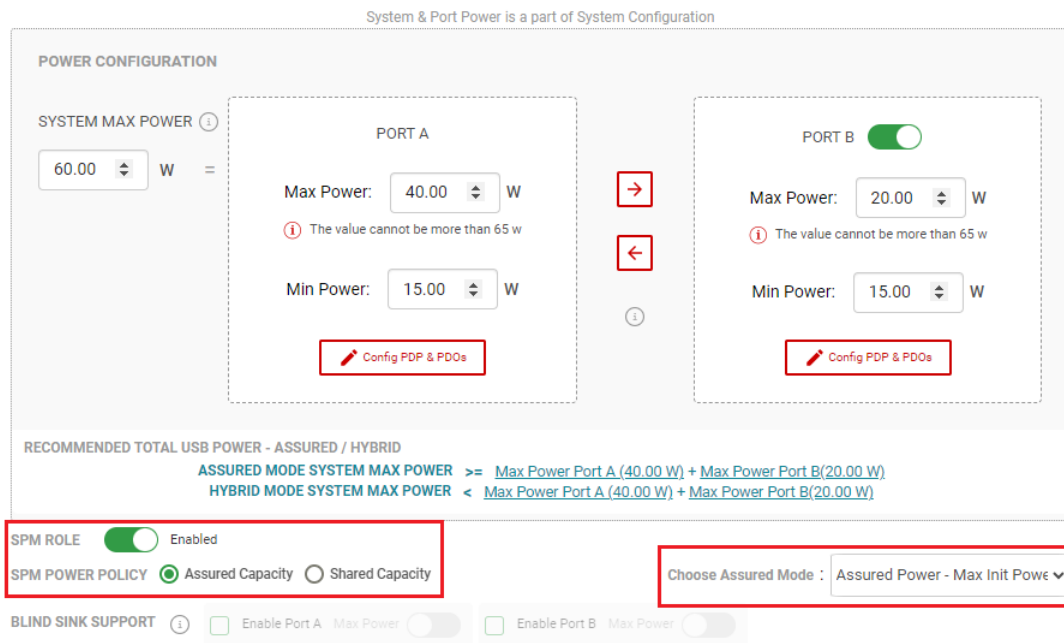

Figure 3-3. Assured Policy GUI Selection – Advanced Configuration

For example scenarios of the Assured Capacity Policy to better understand how system power is allocated and distributed when this SPM Power Policy is selected, see [Section 5.1](#).

3.2 Shared Capacity Policy

The Shared Capacity Policy is where the sum of the Port Max Power, as designed, is less than the System Max Power. When the Source ports are configured in Shared Capacity, Port Min Power is **guaranteed** for each port while the remaining power stored in Power Reserve is shared between Port A and Port B.

$$\text{System Max Power} = \text{Port A Min power} + \text{Port B Min power} + \text{Power Reserve} \quad (2)$$

An example of the Shared Capacity Policy is shown in [Figure 3-4](#) where the System Max Power is 75W, Port A and B's Min Power are both 15W, and there is 45W in Power Reserve. Port A connects to a Sink that requests 45W. Port A's Min Power of 15W is guaranteed, so 30W is distributed from Power Reserve to deliver a total of 45W, the Sink's requested power. The remaining power in Power Reserve is now 15W, so with Port B's Min Power of 15W, a total of 30W is available for Port B. From this point, what occurs when a second Sink connects to Port B is dependent on the Port Partner's Sink Capabilities and is discussed in the following subsections.

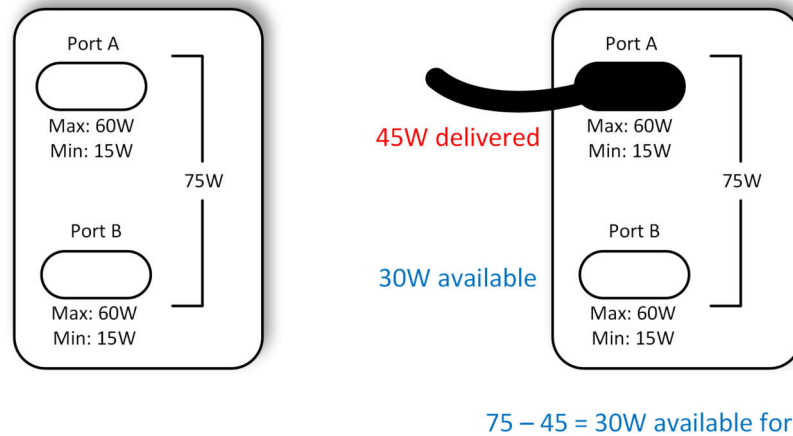

Figure 3-4. Shared Capacity Policy

[Figure 3-5](#) shows the Shared Capacity Policy selection in the GUI's Advanced Configuration view.

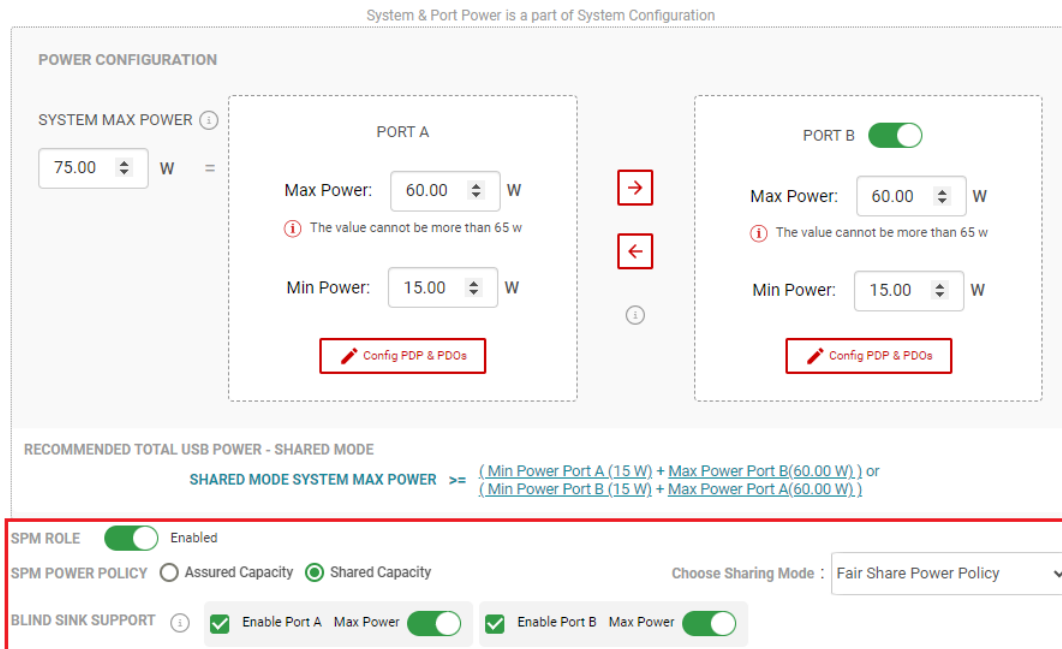

Figure 3-5. Shared Capacity GUI Selection – Advanced Configuration

Note that although freely configurable in the GUI, according to the *USB Type-C Cable and Connector Specification Release 2.2*, the following behavioral rules must apply for Source ports configured with Shared Capacity Policy:

- Both Source ports must have the same power capabilities; each port must be capable of the same Port Max Power, Port Min Power, and able to harvest power from Power Reserve equally.
- Port Min Power must be at least 7.5W.
- Ports that initially offer 1.5A must increase to 3A after a connection with a Sink if there is sufficient power remaining in Power Reserve within one second.

3.2.1 Fair Share Power Policy

Fair Share Power (FSP) Policy is the Shared Capacity Policy's Power Distribution Rule. When using FSP, Port Min Power is guaranteed for each Source port and the remaining power in Power Reserve is intelligently distributed to ports according to their Port Partners' Sink Capabilities.

The FSP parameters shown in [Table 3-2](#) are used in the power distribution method and to achieve FSP between two Sinks.

Table 3-2. Fair Share Power Policy Parameters

| Fair Share Power Policy Parameters | Description |
|------------------------------------|---|
| Port Min Power | Configurable minimum VBUS power for each port |
| Equally Divided Shared Power | Equally Shared Power from Power Reserve that can be distributed to each port. Power Reserve / Total number of ports. |
| Per Port Guaranteed FSP | Guaranteed Shared Power for each port. Equally Divided Shared Power + Minimum Port Power |

The typical flow of the Fair Share Power Policy power distribution is as follows:

1. The first connected Source port initially advertises Port Min Power and sends a *Get Sink Capabilities* request to its Port Partner.
2. The Sink responds by returning a Sink Capabilities message and receives power accordingly.
3. The remaining power is stored in Power Reserve.
4. The second connected Source port initially advertises Port Min Power and sends a *Get Sink Capabilities* request to its Port Partner. After receiving the Sink Capabilities, the SPM begins the power distribution process. During the power distribution process, power is harvested from or contributed to Power Reserve to fulfill the Sinks' requirements as shown in [Table 3-3](#).

Table 3-3. Example Scenarios and Corresponding Power Distribution

| | Example Scenario | Corresponding Power Distribution |
|---|--|--|
| 1 | Both Port Partners' Sink Capabilities are less than the Per Port Guaranteed FSP. | The SPM distributes power to meet the Sink Capabilities and stores the remaining power to Power Reserve. |
| 2 | Both Port Partners' Sink Capabilities are higher than the Per Port Guaranteed FSP. | The SPM distributes the Per Port Guaranteed FSP to each Sink. |
| 3 | One Port Partner's Sink Capabilities is higher than the Per Port Guaranteed FSP and the other Port Partner's Sink Capabilities is less than the Per Port Guaranteed FSP. | The SPM distributes power to the Sink requesting lower power and the remaining power to the other Sink. |

Note

It is required per USB PD specification for Sink devices to report a Capability Mismatch if the power offered by the Source does not satisfy its power requirements. Once the Source receives the request with a Capability Mismatch flag from the Sink, it requests the Sink Capabilities by sending a *Get Sink Capabilities* message. Some Sinks, however, are unable to report a Capability Mismatch. Therefore, although a Sink may report a Capability Mismatch or present limitations to accurately communicate its full power needs, the TPS25772-Q1 always attempts to fetch the Sink Capabilities from the Port Partner by sending a *Get Sink Capabilities* message to better fulfill the Sink's power requirements.

For example scenarios of FSP to better understand this policy's power distribution methods, see [Section 5.2](#).

3.2.1.1 Blind Sink Support

The Fair Share Power Policy can be configured with an option to enable or disable Blind Sink Support. The FSP operation principal is the same with Blind Sink support, but the power distribution mechanism can vary depending on a Port Partner's Sink Capabilities.

Enabling Blind Sink Support allows the FSP Policy to take an additional step to determine if a connected Port Partner is a Blind Sink. As previously mentioned, the FSP always starts by initially advertising the Port Min Power and sends a *Get Sink Capabilities* request. If the Port Partner returns valid Sink Capabilities and is identified as a Good Sink, a new Source Capabilities message with PDOs that sufficiently meet the Sink Capabilities is sent back. However, when a Port Partner is identified as a Blind Sink, the FSP policy will offer Port Max Power instead if the second port is open and Per Port Guaranteed FSP if the second port is connected.

The following is how the TPS25772-Q1 identifies a Port Partner to be a Blind Sink:

- Power reported from the first Sink Capabilities is less than the current contract power.
 - When a port connects to a Sink and it returns Sink Capabilities that is less than the initial contract power, the Port Partner is identified as a Blind Sink.
 - Inversely, when a port connects to a Sink and it returns Sink Capabilities that is higher than the initial contract power, the Port Partner is identified as a Good Sink. However, from the second Sink Capabilities onward, if the Port Partner reduces power from the current contract power, it will still be recognized as a Good Sink.
- Power reported in the Sink Capabilities is less than the current Source Capabilities.
- The Sink Capabilities is blindly copied from the Source Capabilities.
- Sink Capabilities are not returned after a *Get Sink Capabilities* request.
- *Not supported* is returned after a *Get Sink Capabilities* request.

The [Table 3-4](#) highlights the Fair Share Power Policy operation and the difference when Blink Sink support is disabled and enabled.

Table 3-4. Difference Between Blind Sink Disable and Enable

| | FSP With Blind Sink Support Disabled | FSP With Blind Sink Support Enabled |
|-----------------------------|---|---|
| Initial Source Capabilities | Minimum Port Power | |
| Sink Capabilities Handling | Honor Sink Capabilities | |
| | Sink devices not reporting Cap Mismatch | |
| | Source sends <i>Get Sink Capabilities</i> request | |
| | Correct Sink Capabilities received | Incorrect Sink Capabilities received |
| | Offer power according to Sink Capabilities. | When the second port is open, offer Port Max Power to the Blind Sink. When the second port is also connected: take the Blind Sink as a device whose Sink Capabilities is higher than the Per Port Guaranteed FSP and offer FSP to the Blind Sink as described in the 2nd and 3rd condition in Table 3-3 . |

When Blind Sink Support is enabled in the GUI either from the Advanced Configuration view, an additional option to enable or disable "Max Power" becomes active. This enables the charging port to treat every Port Partner as a Blind Sink and always offer Port Max Power regardless of behavior. In addition, when two Sinks are connected, Per Port Guaranteed FSP is always advertised to Port Partners regardless of their Sink Capabilities. Some Sink devices return a Sink Capabilities message that is lower than what they are actually able to consume. The Max Power option can be adopted to support higher power charging for Sink devices such as these.

Blind Sink Support and the Max Power option can be enabled via the GUI's Advanced Configuration view. For more information, see [Figure 3-5](#).

[Section 5.2.1](#) provides example scenarios of FSP to better understand this policy's power distribution method when Blind Sink Support is enabled. For examples when Blind Sink Support and Max Power are both enabled, see [Section 5.2.2](#).

3.3 Hybrid Mode

Hybrid Mode is an optional power policy that behaves as a hybrid of the Assured Capacity Policy and Shared Capacity Policy. It provides the benefit of the Assured Capacity Policy by initially advertising the Port Max Power when one Sink is connected, while allowing equal distribution of the System Max Power, similar to the Shared Capacity Policy, when two Sinks are connected.

There are some Sink devices that request power based on the first Source Capabilities received and do not attempt to renegotiate for a more favorable contract when higher PDOs are offered in following Source Capabilities messages. This is a problem when FSP is desired, where Source ports are configured as Shared Capacity and Port Min Power is advertised in the initial Source Capabilities message. With Hybrid Mode, FSP is possible while ensuring that a Sink's power requirements are met.

Hybrid Mode can be enabled from the Advanced Configuration view. After the SPM Engine parameters are entered with Assured Capacity Policy selected, Hybrid Mode can be enabled by modifying the System Max Power to a value less than the sum of Port A and Port B's Max Power. The GUI then displays *Hybrid Mode* in red text to indicate that Hybrid Mode is active as shown in [Figure 3-6](#).

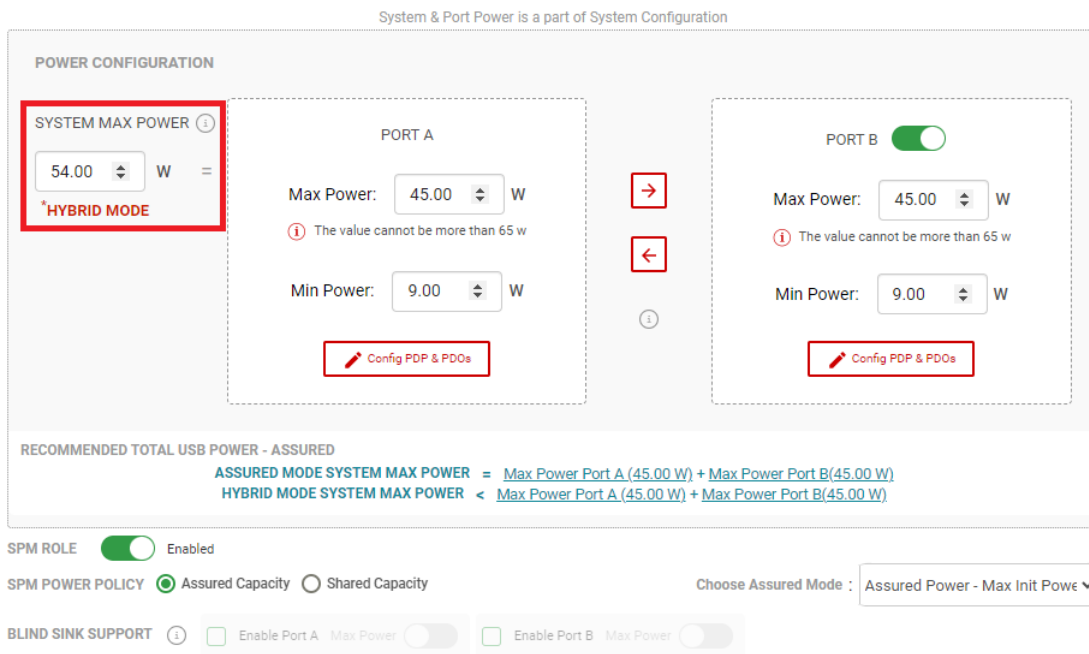

Figure 3-6. Hybrid Mode GUI Selection - Advanced Configuration

The Hybrid Mode parameters shown in [Table 3-5](#) are used in the power distribution method.

Table 3-5. Hybrid Mode Parameters

| Hybrid Mode Parameters | Description |
|--------------------------------|--|
| Equally Divided System Power | Equally divided System Max Power allocated to each port when two PD-Sinks are connected: System Max Power / Total number of ports. |
| Single Port Max Power Capacity | Maximum VBUS power for a port when a single PD-Sink is connected: <ul style="list-style-type: none"> When System Max Power >= sum of Port A and B's Min Power, the connected port power is set by the lowest value defined by Port Max Power OR System Max Power that is available. When System Max Power < sum of Port A and B's Min Power, Port B is disabled and Port A's power is equal to the System Max Power - Port B Min Power (limited up to the Port Max Power). |
| Non-PD USB-C Power | USB Type-C 5V output for non-PD based USB Type-C charging; 7.5W or 15W. |

The typical flow of the Hybrid Mode power distribution is as follows:

1. The first connected Source port initially advertises Port Max Power and sends a *Get Sink Capabilities* request
2. The Sink responds by returning the Sink Capabilities and receives power accordingly (up to the Single Port Max Power Capacity).
3. The second Source port connects to another Sink and the SPM Engine immediately distributes the Equally Divided System Power to each Port Partner. Unlike FSP, any unused remaining power does not get stored in Power Reserve and allocated to the other port.

In the event where one PD Sink and one non-PD Sink are connected to the ports, the Equally Divided System Power is initially allocated to each Sink. This connection takes roughly 8.5 seconds for the TPS257xx-Q1 firmware to identify a non-PD Sink. Once a non-PD Sink is identified, the SPM Engine can reallocate and redistribute system power; Non-PD USB-C Power is distributed to the non-PD Sink and the remaining power (the difference between the System Max Power and the Non-PD USB-C Power) is allocated to the PD Sink. The Non-PD USB-C Power can be selected by configuring the USB Type-C Current parameter from the GUI's USB PORT(S) window (see [Figure 3-7](#)).

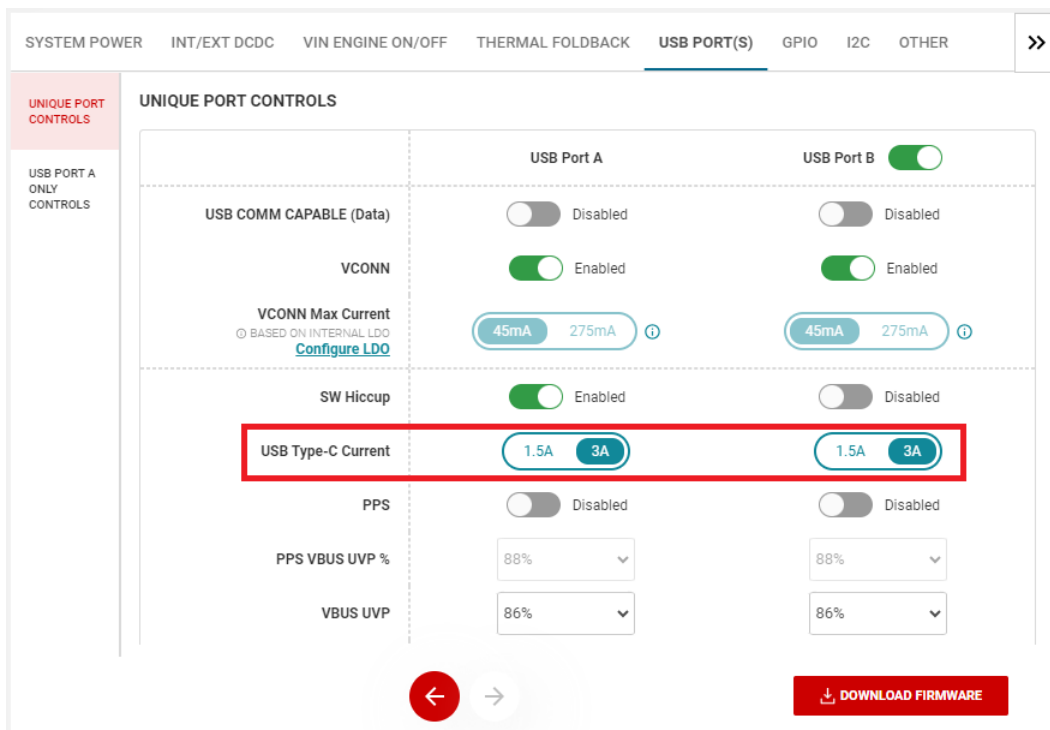

Figure 3-7. USB Type-C Current – Advanced Configuration

For example scenarios of Hybrid Mode to better understand this mode's power distribution method, see [Section 5.3](#).

4 Power Foldback Policy

The TPS2576x-Q1 and TPS2577x-Q1 PD controllers support Power Foldback Policies based on system temperature and VIN supply voltage levels. The Power Foldback Policies are managed by the integrated SPM Engine alongside the Multi-Port Power Allocation Policy (in the case of the TPS25772-Q1). Upon entry into a Power Foldback condition, the SPM uses the System Max Power for the corresponding Power Foldback phase the TPS257xx-Q1 has entered then distributes port power accordingly.

4.1 Thermal Foldback Operation

The TPS257xx-Q1 PD controller monitors system temperature using an external thermistor or I2C temperature sensor. Based on the configurable temperature thresholds, the SPM can reduce USB port power in response to temperature increases. Depending on the feedback from the thermistor/temperature sensor, the SPM enters or exits an appropriate thermal phase and re-negotiates the contract with a connected Port Partner to help with the thermal performance of the system.

In systems that use both an external thermistor and I2C temperature sensor, the SPM collects a thermal phase value from each device then uses the highest phase parameter to enter the appropriate power mode for all ports. The temperature thresholds for the thermal phases for each temperature sensing device can be varied. This is to accommodate variations in temperature that would be dependent upon the placement of the thermistor/temperature sensor, USB PD controller, and other temperature related physical properties.

There are three default thermal phases based on the voltage level detected on the TPS257xx-Q1's NTC pin input or readings from an I2C temperature sensor, but three additional thermal phases can be added using the GUI for a total of six. The GUI is also used to configure the voltage thresholds and the max power for each phase. Figure 4-1 shows the NTC input voltage thresholds of a three thermal phase configuration where Phase3 represents the worst case with the highest temperature.

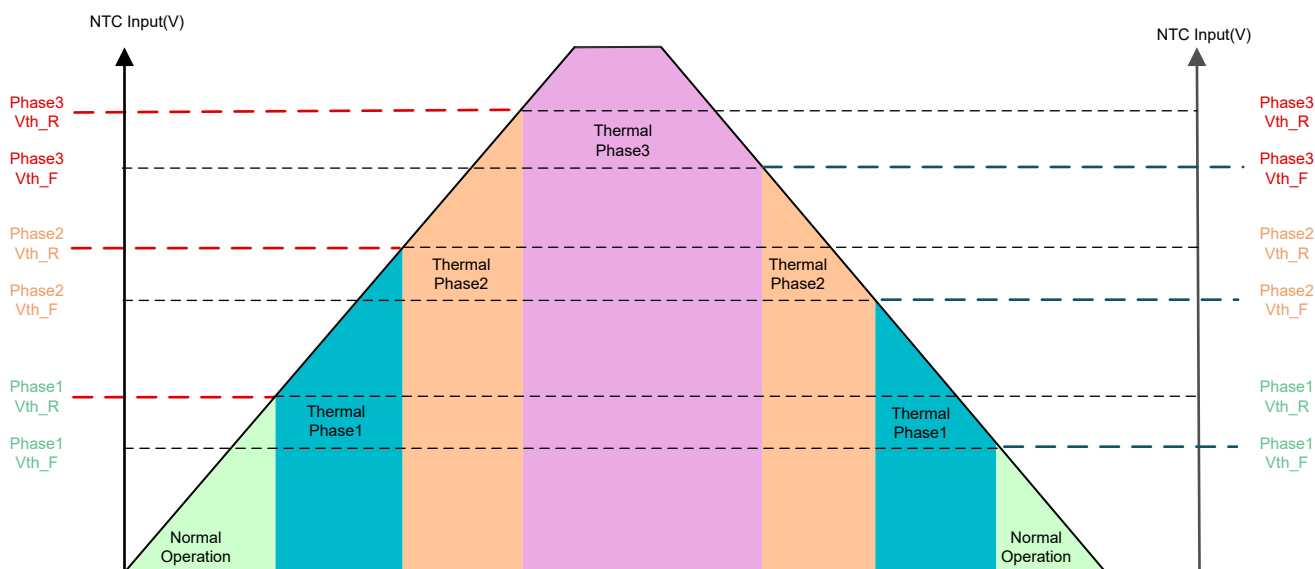

Figure 4-1. NTC Input Voltage Threshold and Thermal Phase

Rising or falling voltages on the NTC pin indicate increasing or decreasing system temperatures, respectively. To achieve a positive temperature slope on the TPS25772-Q1 NTC pin, thermistor resistor networks should be connected to LDO_3v3 as shown in Figure 4-2. The device firmware monitors the voltage level on the NTC pin then enters or exits the thermal phase per the configured values. For more information on the NTC input, see the device-specific data sheets.

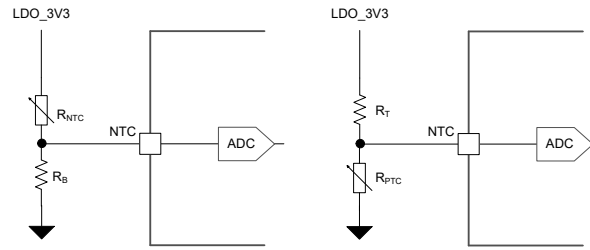

Figure 4-2. Thermistor Implementation Options

Table 4-1 shows the Thermal Phase Parameters that are configured through the GUI.

Table 4-1. Thermal Phase Parameters

| Thermal Phase Parameters | Description |
|---------------------------------|--|
| Phasen Vth_R ⁽¹⁾ | Thermal Phasen entry threshold. Device enters Thermal Phasen upon detection of rising edge above this voltage threshold. |
| Phasen Vth_F ⁽¹⁾ | Thermal Phasen exit threshold. Device exits Thermal Phasen upon detection of falling edge below this voltage threshold. |
| Phasen Max Power ⁽¹⁾ | Maximum total power in Thermal Phasen. SPM uses Thermal Phasen Max Power to execute port power management actions once device enters Thermal Phasen. |

(1) *n* ranges from 1 to 6. There are three default thermal phases and up to three additional phases can be added using the GUI.

Figure 4-3 shows the GUI entry example in Advanced Configuration View where the *No. of Phases* is configured to 6.

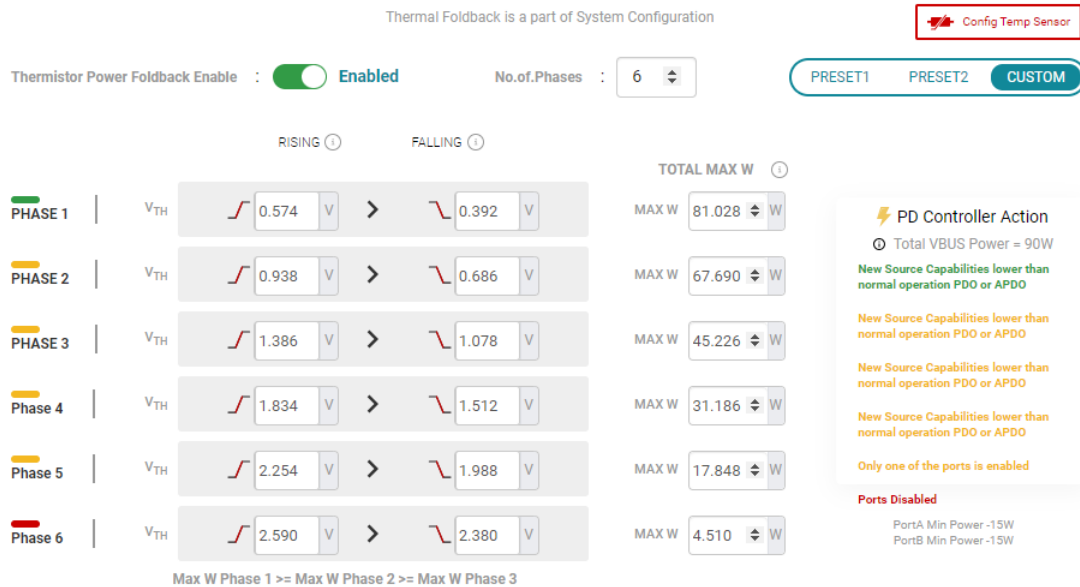

Figure 4-3. Thermal Foldback GUI Entry Example

The Thermal Phase Parameters must be configured per the rules described below:

- Thermal Phase6 power(W)≤Thermal Phase5 power(W)≤Thermal Phase4 power (W)≤Thermal Phase3 power (W)≤Thermal Phase2 power (W)≤Thermal Phase1 power (W)
- Phasen_Vth_R (V) > Phasen_Vth_F (V)

In the case for the TPS2577x-Q1, if *Total Max W* for any phase is less than SUM (Port Min Power) but higher than Port A Min Power, only Port A will be enabled upon entry into the corresponding phase. For either the TPS2576x-Q1 or TPS2577x-Q1, if *Total Max W* for any phase is less than Port A Min Power, VBUS is completely disabled (0V) upon entry into the corresponding phase. For example, if Phase6 Max Power = 4.5W while Port A Min Power = 15W, VBUS will be disabled upon entry into Phase6.

The TPS257xx-Q1 is designed to work with LM75 type temperature sensor: [TMP75-Q1](#). The SPM polls the I2C sensor ADC register at a configured interval, with a default typical polling interval value of 250ms. The ADC reading from the temperature sensor is converted to 1°C resolution.

Figure 4-4 depicts the connection of the thermistor and I2C temperature sensor to the TPS257xx-Q1.

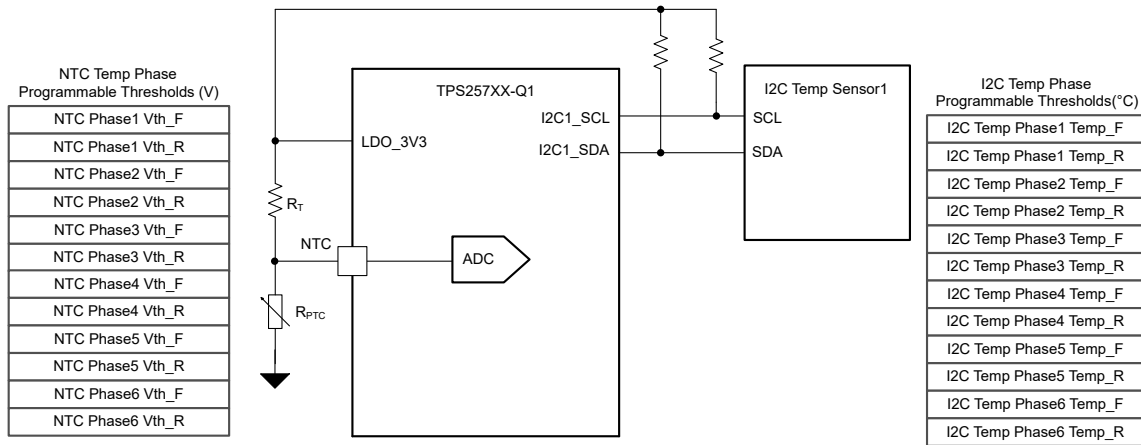

Figure 4-4. I2C Temp Sensor and Thermistor Configuration Example

TPS257xx-Q1 supports multiple thermal detection devices in one system. A thermistor and an I2C temperature sensor can be both connected and monitored as shown in Figure 4-4. The NTC Phase and I2C temperature phase thresholds can be configured separately. Thermistor phase thresholds are configured in voltage while I2C temperature sensor phase thresholds are configured in the Celsius temperature scale. The SPM chooses the worst value of the Thermistor and I2C Temperature thermal phase, then takes action to reduce power per the worst phase configuration.

Table 4-2 and Table 4-3 show a three-phase NTC thermistor and I2C temperature sensor parameters for the following example scenarios. Note that the temperature thresholds and a phase's *Total Max Power* can be configured independently of each other.

Table 4-2. NTC Thermistor Phase Configured Values

| | Vth | Correlated Temperature | Total Max Power |
|------------------|-------|------------------------|-----------------|
| NTC Phase1 Vth_F | 0.83V | 65°C | 45W |
| NTC Phase1 Vth_R | 1.1V | 70°C | |
| NTC Phase2 Vth_F | 1.2V | 78°C | 30W |
| NTC Phase2 Vth_R | 1.4V | 90°C | |
| NTC Phase3 Vth_F | 1.5V | 95°C | 7.5W |
| NTC Phase3 Vth_R | 1.7V | 105°C | |

Table 4-3. I2C Temperature Sensor Phase Configured Values

| | Temperature | Total Max Power |
|--------------------------|-------------|-----------------|
| I2C temp sensor Phase1 F | 42°C | 45W |
| I2C temp sensor Phase1 R | 45°C | |
| I2C temp sensor Phase2 F | 49°C | 30W |
| I2C temp sensor Phase2 R | 53°C | |
| I2C temp sensor Phase3 F | 59°C | 15W |
| I2C temp sensor Phase3 R | 64°C | |

The following are two examples of Thermal Foldback where the NTC and I2C temperature sensor readings steadily increased and have crossed their rising thresholds.

Case 1. NTC thermistor Vth reading = 1.3V(around 85°C), I2C temperature sensor temperature reading = 63°C.

Per the configuration shown in [Table 4-2](#) and [Table 4-3](#), the NTC reading indicates the thermistor is in Phase1 while the I2C temperature sensor is in Phase2. The SPM uses the I2C temperature Phase2 as its worse phase, then reduces power per I2C temp sensor Phase2 configuration of 30W.

Case 2. NTC Phase Vth reading = 1.72V (around 106°C), I2C temperature sensor temperature reading = 65°C.

Per the configuration shown [Table 4-2](#) and [Table 4-3](#), both NTC and I2C sensor readings are in Phase3. The Phase3 power configuration for NTC thermistor is 7.5W while I2C temp sensor is 15W. The SPM takes the lower of two then reduces power to 7.5W.

4.2 Engine On/Off Transition Management

The TPS257xx-Q1 supports a dynamic port power management scheme for VIN supply voltage fluctuations in case of Engine On/Off transition events. Through dynamic detection of the supply voltage input level, the SPM takes action to enter or exit the appropriate power level. Upon detection of low VIN below normal operating range, the SPM enters a lower power mode to protect the system from overheating and excessive input current draw. The SPM also filters a fluctuation or temporary glitch on VIN to prevent an abrupt loss of USB port power which in turn enhances the end user experience. [Table 4-4](#) and [Table 4-5](#) show the VIN threshold and timer parameters for the TPS257xx-Q1 D version devices. All parameters are configured via the GUI except for VIN UVLO. [Figure 4-5](#) depicts an example of how different power modes, as determined by the VIN threshold levels, work in conjunction with the deglitch filter and timers.

Table 4-4. VIN Threshold Parameters

| VIN Threshold Parameters | Description |
|--------------------------|---|
| RANGE 3 to 4 | Full Power RANGE 4 entry threshold (for example, Engine fully ON condition with Car Key Knob in ON position) |
| RANGE 4 to 3 | RANGE 3 entry from RANGE 4 (Full Power) falling threshold (such that, Car key knob in accessory position with nominal VIN accessory mode voltage level) |
| RANGE 2 to 3 | RANGE 3 entry from RANGE 2 rising threshold |
| RANGE 3 to 2 | RANGE 2 entry from RANGE 3 falling threshold |
| RANGE 1 to 2 | RANGE 1 (No Power) to RANGE 2 (Low Power) rising threshold. This transition triggers entry into Low Power state immediately. If VIN remains above this threshold but below the RANGE 2 to 3 threshold for the Power Off Grace Period Timer duration, VBUS is disabled after the timer expiration. (for example, Car key knob in accessory position with lower VIN accessory mode voltage level) |
| RANGE 2 to 1 | No Power RANGE 1 entry threshold after Engine Off Delay expiration. (for example, Car key knob in accessory position with lower VIN accessory mode voltage level) |
| Vin(UVLO_R) | Hardware VIN UVLO voltage level. The SPM Controller is disabled. |

Table 4-5. Configurable Timer Parameters

| Engine On/Off Timer Parameters | Description |
|--------------------------------|---|
| Rising VIN Deglitch | Deglitch time to enter a higher RANGE from a lower RANGE after VIN reaches threshold. |
| Falling VIN Deglitch | Deglitch time to enter a lower RANGE from a higher RANGE after VIN reaches threshold. |
| Power On (Range 1 to 2) | Power On (Grace Period) timer. Timer starts after RANGE 2 is entered from RANGE 1. Once this timer expires and the system is still in RANGE 2, RANGE 1 will be entered and VBUS will be disabled. |
| Power Off (Range 3 to 2) | Power Off (Grace Period) timer. Timer starts when RANGE 2 is entered from RANGE 3. Once this timer expires and the system is still in RANGE 2, RANGE 1 will be entered and VBUS will be disabled. |
| Engine Off Delay | Engine Off Delay timer. Delay time to enter RANGE 1 (No Power) after VIN falls under the RANGE 2 to 1 threshold. |

- FW takes action based upon voltage sampled after EngVth or EngOffTimer polling period/expiration
- While Grace Period Timers are running, VIN will be continuously monitored, then action is taken based upon the VIN sampled.
- The Power On (GracePeriod) Timer is triggered when VIN>RANGE 1 to 2, but stops when the SPM enters RANGE 4 (Full Power). It continues to run only if the SPM stays in Low Power (RANGE 3 or RANGE 4). Once Power On (Grace Period) expires after the configured time, the SPM will enter No Power (RANGE 1).

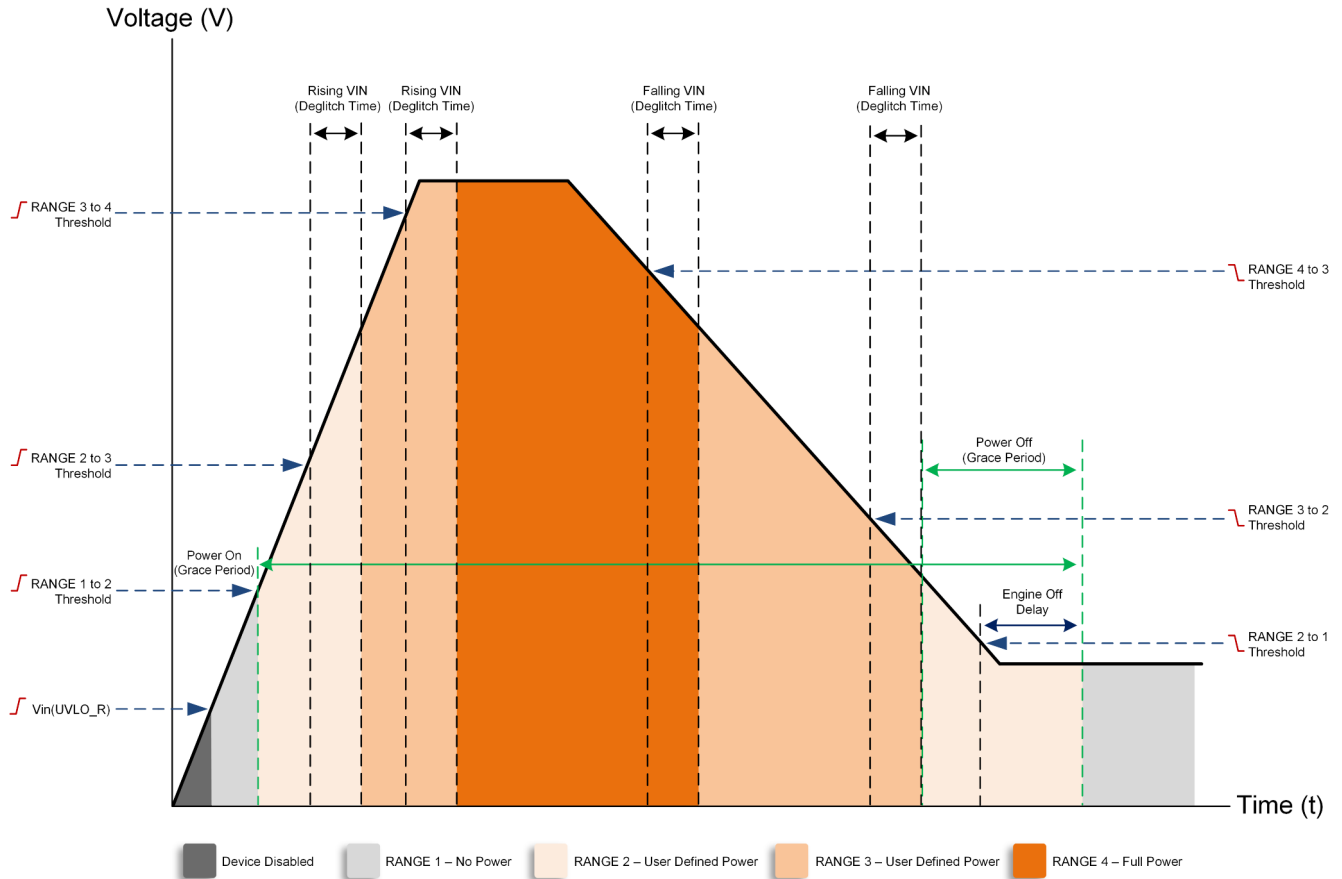

Figure 4-5. VIN Level and Engine On or Off Power Transition

Note

The VIN Engine On/Off VIN threshold and timer parameters mentioned in this section apply to TPS257xx-Q1 D version devices only. The TPS257x2-Q1 C version devices' VIN Engine On/Off parameters are not the same. For more information, see Appendix B in the [TPS257XX-Q1-GUI Configuration Guide](#).

Figure 4-6 shows the GUI entry example in the Advanced Configuration view.

Engine Start Stop is a part of System Configuration

VIN and Power Settings:

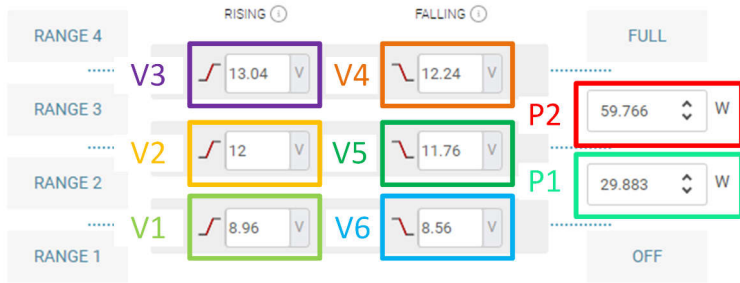

Timing Settings:

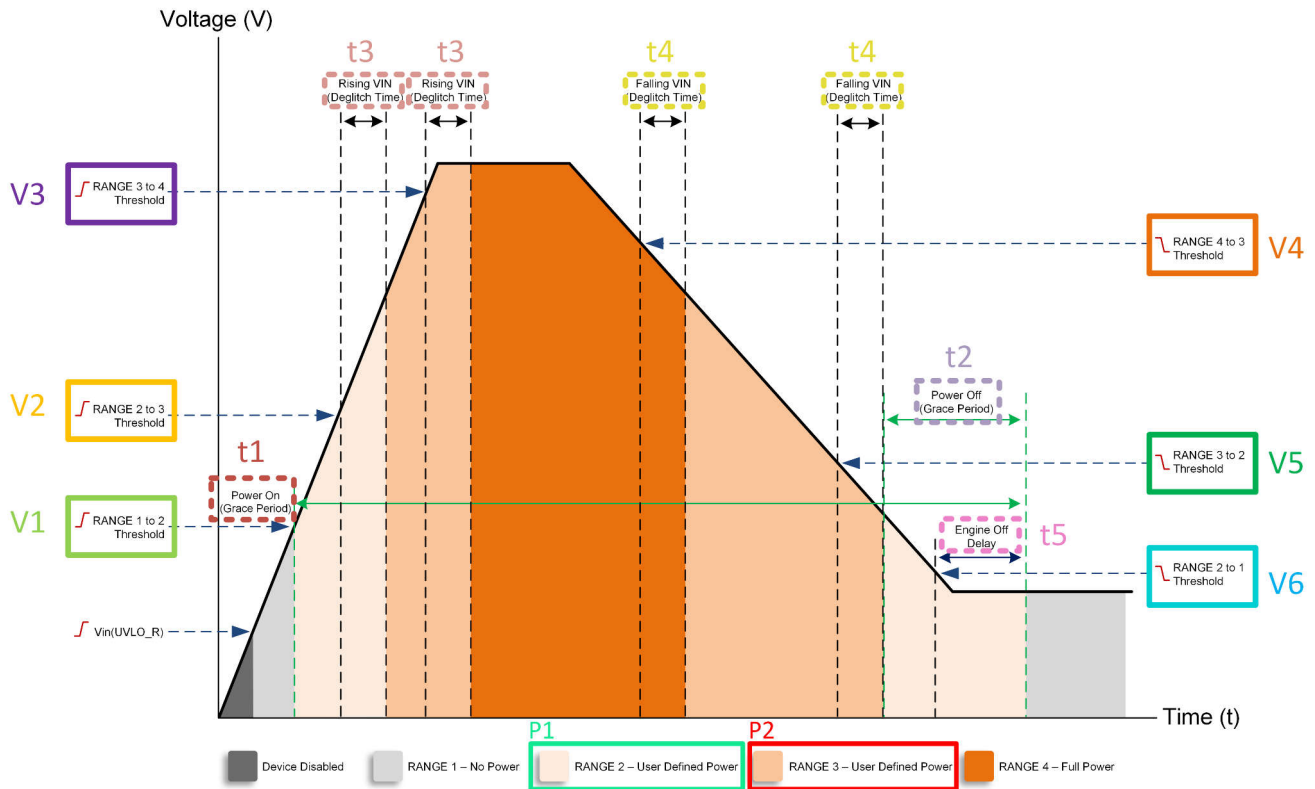
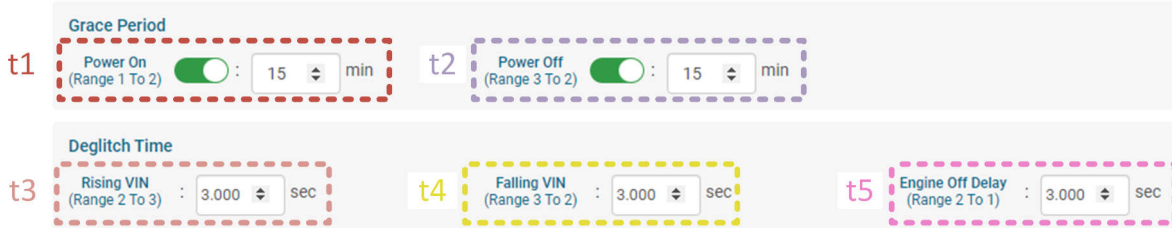

Figure 4-6. Engine On or Off GUI Entry Example

4.2.1 Engine On/Off Power Foldback Operation Example

The example below depicts the Power Foldback operation upon detection of VIN voltage level changes. [Table 4-6](#) shows the configurable SPM Engine parameters used in this section's example.

Table 4-6. SPM Engine Parameters - Engine On/Off Power Foldback Example

| SPM Engine Parameters | Configuration | Description |
|----------------------------|-------------------------|---|
| System Max Power (RANGE 4) | 75W | Total system power capacity that is allocated for Port A and Port B |
| Port A Max Power | 60W | Maximum Port A Power |
| Port B Max Power | 60W | Maximum Port B Power |
| Port A Min Power | 15W | Minimum Port A power |
| Port B Min Power | 15W | Minimum Port B power |
| RANGE 3 | 60W | Total VBUS Power allocated for Port A and B when VIN < RANGE 3 to 4 Threshold |
| RANGE 2 | 30W | Total VBUS Power allocated for Port A and B when VIN < RANGE 2 to 3 Threshold |
| Sharing Mode | Fair Share Power Policy | Port Min Power is guaranteed for each port and remaining power is intelligently distributed |

Table 4-7. Engine On/Off Power Foldback Operation Example

| | Port A | Port B |
|---|--------|--------|
| Scenario 1: Port A connects in Normal Operation in RANGE 4 (VIN > RANGE 3 to 4 Threshold) | | |
| Power Required by Sink | 60W | |
| Power Distributed to Sink | 60W | |
| Scenario 2: Port B connects in Normal Operation in RANGE 4 (VIN > RANGE 3 to 4 Threshold) | | |
| Power Required by Sinks | 60W | 60W |
| Power Distributed to Sinks | 37.5W | 37.5W |
| Scenario 3: Start of Power Foldback Operation | | |
| VIN < RANGE 4 to 3 Threshold w/ reduced power = 60W | 37.5W | 37.5W |
| After Falling VIN Deglitch time, 30W Source Capabilities resent to Port A and Port B | 37.5W | 37.5W |
| Sink accepts | 30W | 30W |
| Scenario 4: Power Foldback Operation (continued) | | |
| VIN < RANGE 3 to 2 Threshold w/ reduced power = 30W | 30W | 30W |
| After Falling VIN Deglitch time, 15W Source Capabilities resent to Port A and Port B | 30W | 30W |
| Sink accepts and Power Off (Grace Period) starts | 15W | 15W |
| VIN remains < RANGE 3 to 2 Threshold | 15W | 15W |
| Ports disable after Power Off (Grace Period) expires | 0W | 0 W |
| VIN transitions to > RANGE 3 to 4 Threshold | 0W | 0 W |
| After Rising VIN Deglitch time, 15W Source Capabilities is sent to both ports | 15W | 15W |
| Sink Accepts | 15W | 15W |
| Power Required by Sinks = 60W | 15W | 15W |
| 37.5W Source Capabilities resent to Port A and Port B | 15W | 15W |
| Sink Accepts | 37.5W | 37.5W |

5 Multi-Port Power Allocation Policy Examples

This section includes example scenarios of port power allocation and distribution when using the different Multi-Port Power Allocation Policy and Power Distribution Rule options. The examples of when one or two Sinks are connected are shown in table format followed by a flow diagram. The tables concisely summarize what occurs when Sink devices connect to TPS25772-Q1 Source ports: the power requested by the Sinks and the power distributed to the Sinks. The flow diagrams that follow illustrate the PD negotiation between the Source and Sink using the same example scenarios.

A negotiation between Port Partners must successfully complete to establish a PD power contract. Port Partners communicate over the USB Type-C connector's CC wire and the typical PD negotiation process between a Sink and Source is outlined below:

1. The Source advertises the initial Source Capabilities to the Sink. Assured Capacity Policy, with Max Init Power enabled, will always advertise the Port Max Power upon connection. On the other hand, Shared Capacity Policy will always advertise the Port Min Power first.
2. The Sink requests power based on the PDOs offered from the advertised Source Capabilities.
3. The Source accepts the request and provides power accordingly.
4. The Source follows up with a *Get Sink Capabilities* message.
5. After obtaining the Sink Capabilities, the Source resends a new Source Capabilities message based on the Sink's power requirements.

Each time power is reallocated for Source ports via power harvesting or redistribution events, new Source Capabilities messages are automatically sent to Port Partners per the new allocated power. Power harvesting and redistribution events occur upon port connect/disconnect or Power Foldback phase entry/exit.

5.1 Assured Capacity Policy Example

This section provides examples of power distribution when Source ports are configured as Assured Capacity Policy and Max Init Power mode is selected. [Table 5-1](#) shows the SPM Engine parameters used in this section's example.

Table 5-1. SPM Engine Parameters - Assured Capacity Policy Example

| SPM Engine Parameters | Configuration | Description |
|-----------------------|---------------------|--|
| System Max Power | 105W ⁽¹⁾ | Total system power capacity allocated for Port A and B |
| Port A Max Power | 60W | Maximum Port A Power |
| Port B Max Power | 45W | Maximum Port B Power |
| Port A Min Power | 15W | Minimum Port A power |
| Port B Min Power | 15W | Minimum Port B power |
| Assured Mode | Max Init Power | Source initially sends Source Capabilities advertising max power |

(1) The System Max Power is 105W; the sum of Port A Max Power and Port B Max Power.

Three example scenarios of Assured Capacity Policy are listed in [Table 5-2](#). Note that the power distributed to each port is independent of the other port's status as is expected with the Assured Capacity Policy.

Table 5-2. Assured Capacity Policy Example

| | Port A | Port B |
|---|--------|--------|
| Initially Allocated | 60W | 45W |
| Scenario 1: Port A connects to a Sink that requires 27 W. Port B is unconnected. | | |
| Power Required by Sink | 27W | |
| Power Distributed to Sink | 27W | |
| Scenario 2: Port B connects to a Sink that requires 45 W. | | |
| Power Required by Sink | 27W | 45W |
| Power Distributed to Sinks | 27W | 45W |
| Scenario 3: Port A changes the requirement to 60 W. | | |
| Power Required by Sink | 60W | 45W |

Table 5-2. Assured Capacity Policy Example (continued)

| | Port A | Port B |
|----------------------------|--------|--------|
| Power Distributed to Sinks | 60W | 45W |

The following diagrams show the flow of the PD negotiation when Assured Capacity Policy is enabled and where one Sink first connects to Port A (Figure 5-1) and a second Sink connects to Port B (Figure 5-2).

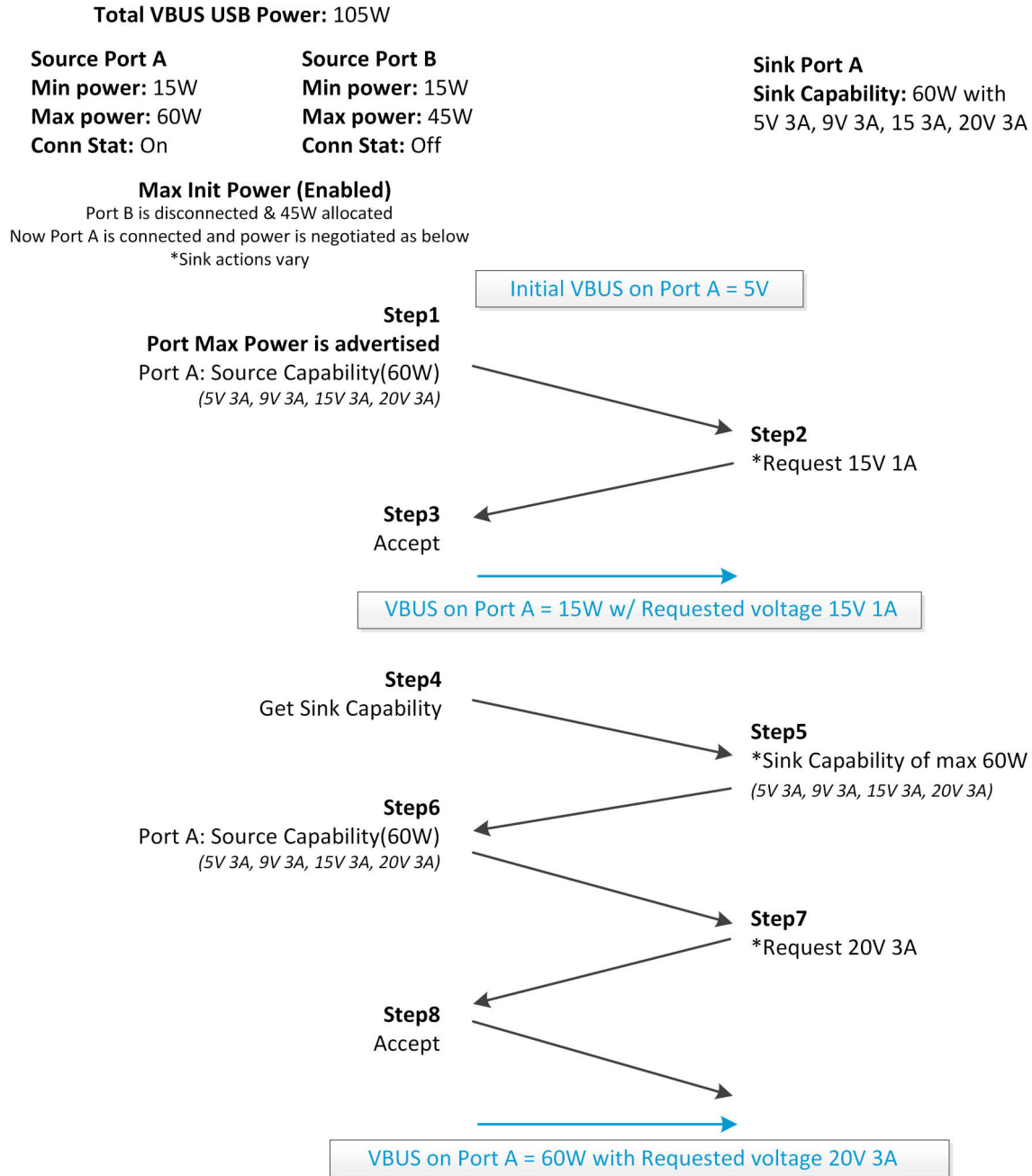

Figure 5-1. Assured Capacity Policy Negotiation Flow - Port A Connected

Total VBUS USB Power: 105W

Source Port A
Min power: 15W
Max power: 60W
Conn Stat: On

Source Port B
Min power: 15W
Max power: 45W
Conn Stat: On

Sink Port B
Sink Capability: 45W with
5V 3A, 9V 3A, 15 3A

Max Init Power (Enabled)

Port A is already connected and has a 60W contract
Now Port B is connected and power is negotiated as below
*Sink actions vary

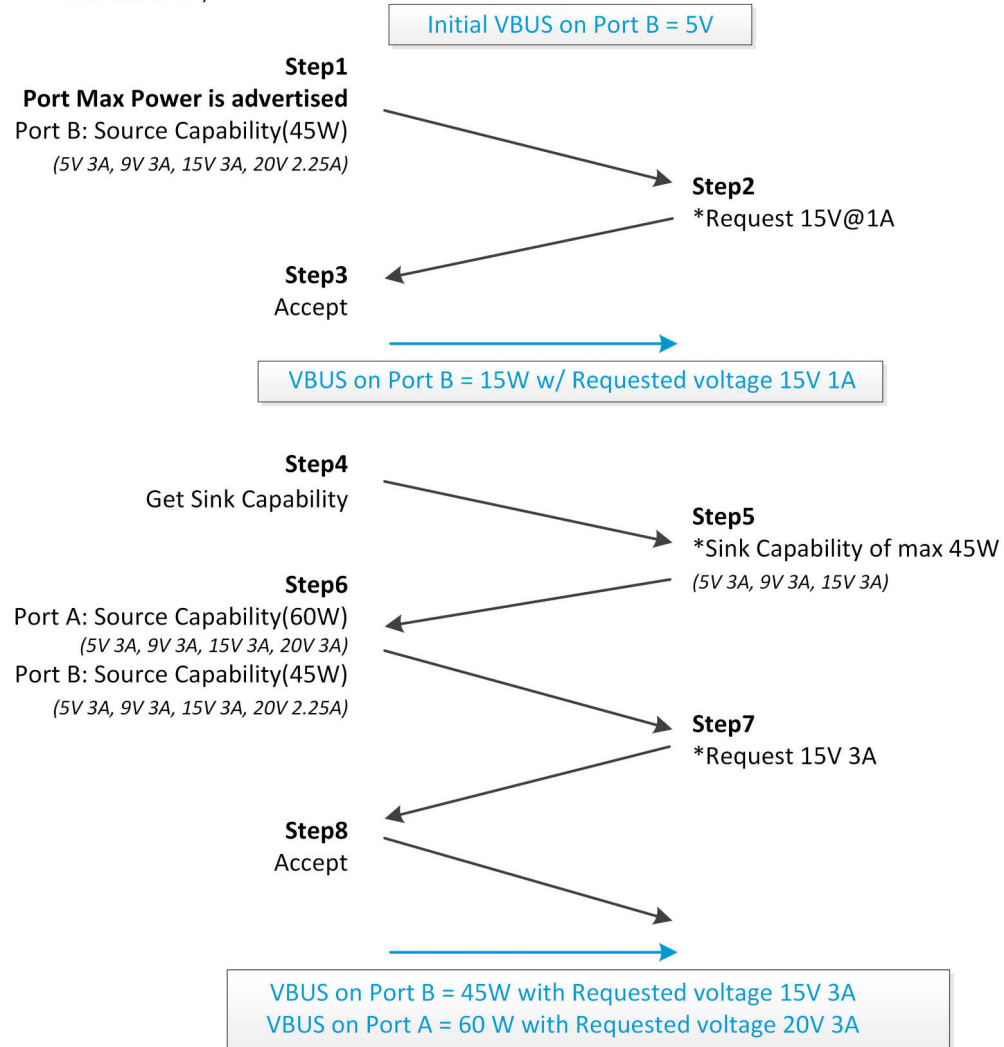

Figure 5-2. Assured Capacity Policy Negotiation Flow - Port B Connected

5.2 Fair Share Power Policy Example

This section provides examples of power sharing between two ports configured with Fair Share Power Policy and when connected to Port Partners that are Good Sinks. When Port Partners are Good Sinks, the power distribution is the same whether Blind Sink Support is enabled or disabled. [Table 5-3](#) shows the SPM Engine parameters used in this section's example. The FSP Parameters shown in [Table 5-4](#) are used in the power distribution method and to achieve FSP between two Sinks.

Table 5-3. SPM Engine Parameters - FSP Example With Good Sinks

| SPM Engine Parameters | Configuration | Description |
|-----------------------|--|---|
| System Max Power | 75W | Total system power capacity allocated for Port A and B |
| Port A Max Power | 60W | Maximum Port A Power |
| Port B Max Power | 60W | Maximum Port B Power |
| Port A Min Power | 15W | Minimum Port A power |
| Port B Min Power | 15W | Minimum Port B power |
| Shared Mode | Fair Share Power Policy without Blind Sink Support | Port Min Power is guaranteed for each port and remaining power is intelligently distributed |

Table 5-4. Fair Share Power Policy Parameters

| Fair Share Power Policy Parameters | Value | Description |
|------------------------------------|------------------------|---|
| Equally Divided Shared Power | $(75-(15+15))/2=22.5W$ | Equally shared power for each port that can be distributed: $(\text{Total VBUS power} - \text{Sum of Port A and B's Min Power})/\text{Total number of ports}$ |
| Per Port Guaranteed FSP | $15+22.5W=37.5W$ | Guaranteed Shared Power for each port: Equally Divided Shared Power + Port Min Power |

Four example scenarios of Fair Share Power Policy power distribution are concisely summarized in [Table 5-5](#).

Table 5-5. FSP Example with Good Sinks

| | Port A | Port B |
|--|--------|--------|
| Initially Allocated | 15W | 15W |
| Scenario 1: Port A connects to a Sink that requires 60W. Port B is unconnected. | | |
| Power Required by Sink | 60W | |
| Power Distributed to Sink | 60W | |
| Scenario 2: Port B connects to a Sink that also requires 60W Sink Cap. | | |
| Power Required by Sink | 60W | 60W |
| Power Distributed to Sinks ⁽¹⁾ | 37.5W | 37.5W |
| Scenario 3: Port B changes the requirement to 15W. | | |
| Power Required by Sink | 60W | 15W |
| Power Distributed to Sinks ⁽²⁾ | 60W | 15W |
| Scenario 4: Port B changes the requirement to 25W. | | |
| Power Required by Sink | 60W | 25W |
| Power Distributed to Sinks ⁽³⁾ | 50W | 25W |

- (1) Per Port Guaranteed FSP of 37.5W are distributed. See second example scenario in [Table 3-3](#).
- (2) Distribute 15W to Port B and reallocate surplus power 22.5W from Port B to Power Reserve (Per Guaranteed FSP of 37.5W - Power Distributed to Port B 15W = 22.5W). Port A is now granted with 22.5W power from Power Reserve and therefore able to fulfill 60W power request.
- (3) 10W from Port A is yielded and redistributed to Port B. See the third example scenario in [Table 3-3](#).

Figure 5-3 and Figure 5-4 show the PD negotiation flow following the FSP examples from Scenario 1 and Scenario 2 of Table 5-5, respectively.

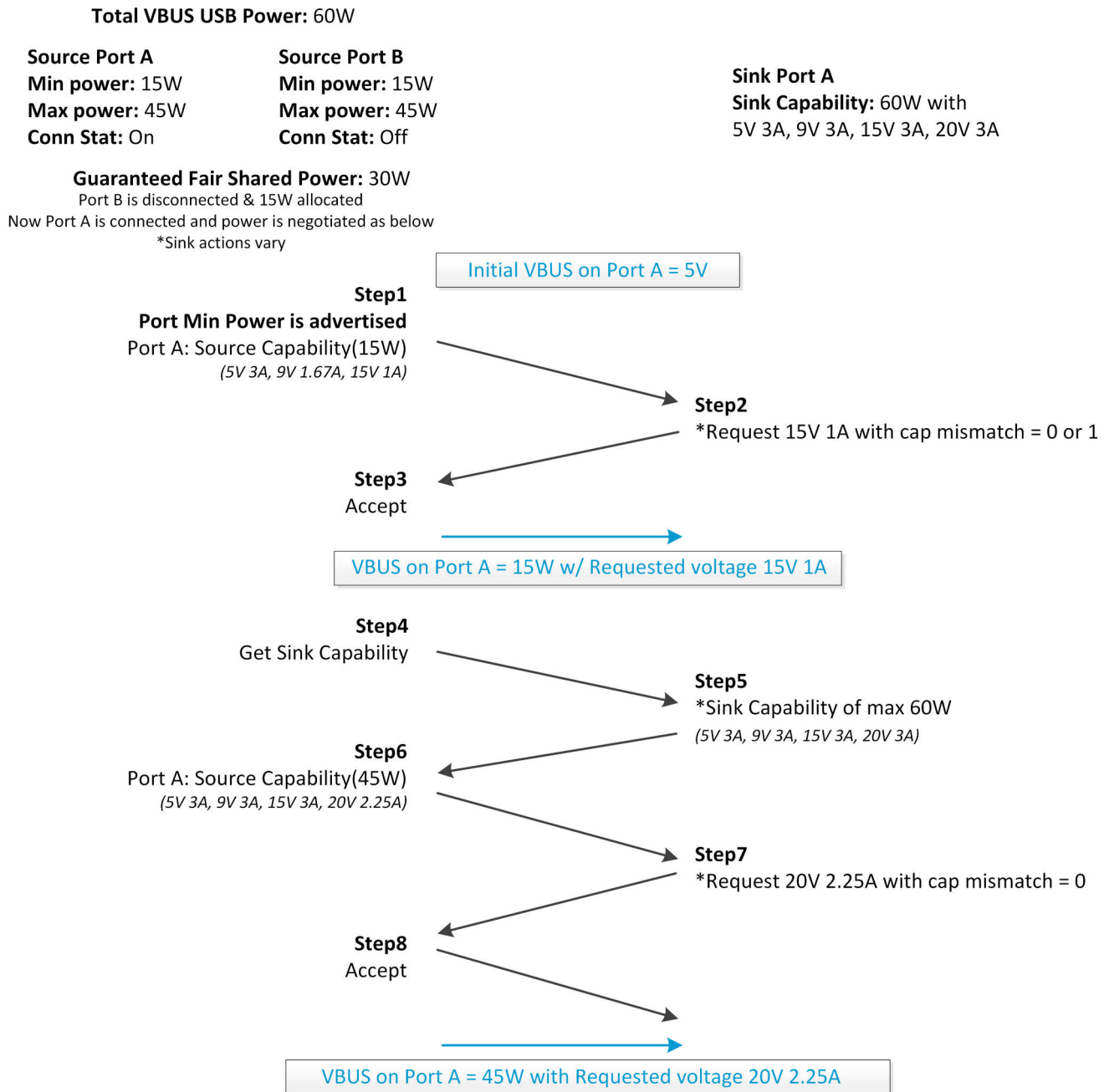

Figure 5-3. FSP Negotiation Flow - Scenario 1

Total VBUS USB Power: 60W

Source Port A
Min power: 15W
Max power: 45W
Conn Stat: On

Source Port B
Min power: 15W
Max power: 45W
Conn Stat: On

Sink Port B
Sink Capability: 60W with
5V 3A, 9V 3A, 15V 3A, 20V 3A

Guaranteed Fair Shared Power: 30W

Port A is already connected and has a 45W contract
Now Port B is connected and power is negotiated as below
*Sink actions vary

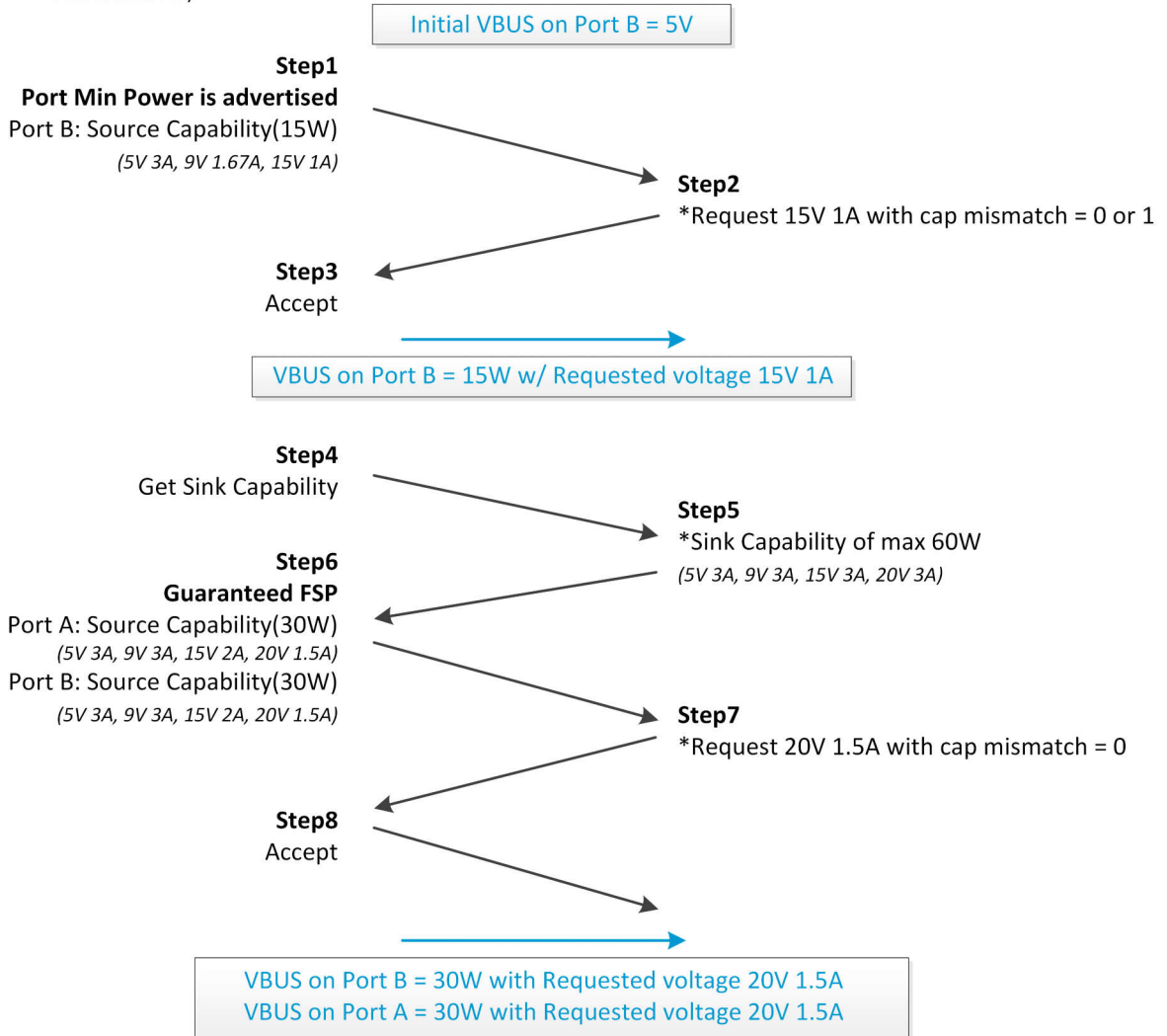

Figure 5-4. FSP Negotiation Flow - Scenario 2

5.2.1 FSP Policy Example – Blind Sink Support

This section provides examples of Fair Share Power Policy's power distribution with Blind Sink Support enabled for both ports and in the event of a port connecting to a Sink that fails to return Sink Capabilities correctly. Note that the Max Power option is not enabled in these examples. [Table 5-6](#) shows the SPM Engine parameters used in this section's example. The FSP Parameters shown in [Table 5-7](#) are used in the Fair Share Power Policy's power distribution to achieve FSP between two Sinks.

Table 5-6. SPM Engine Parameters - FSP Example with a Blind Sink

| SPM Engine Parameters | Configuration | Description |
|-----------------------|-----------------------------|--|
| System Max Power | 75W | Total system power capacity allocated for Port A and B |
| Port A Max Power | 60W | Maximum Port A Power |
| Port B Max Power | 60W | Maximum Port B Power |
| Port A Min Power | 15W | Minimum Port A power |
| Port B Min Power | 15W | Minimum Port B power |
| Shared Mode | FSP with Blind Sink Support | Port Max Power is offered to Blind Sinks |

Table 5-7. Fair Share Power Policy Parameters

| Fair Share Power Policy Parameter | Value | Description |
|-----------------------------------|--------------------------------|---|
| Equally Divided Shared Power | $(75 - (15 + 15)) / 2 = 22.5W$ | Shared power for each port that can be distributed if available: (Total VBUS power – Sum of Port A and B's Min Power)/Total number of ports |
| Per Port Guaranteed FSP | $15 + 22.5W = 37.5W$ | Port Min Power + Per Port Equally Divided Shared Power = Per Port Guaranteed FSP |

Three example scenarios of Fair Share Power Policy operation (when Blind Sink Support is enabled) are shown in [Table 5-8](#). The table format in this section is structured differently to show how Blind Sinks are handled and supported by the SPM.

Table 5-8. FSP Example With Blind Sink Support

| | Port A | Port B | SPM Operation Description |
|--|--------|--------|---|
| Initially Allocated | 15W | 15 W | Min Power is initially allocated for Port A and Port B. |
| Scenario 1: Port A connects to Good Sink #1. Port B is unconnected. | | | |
| Source Cap 1 | 15W | | The first Source Cap is sent to Port A's Sink with Port Min Power. |
| Sink Request | 15W | | Grant 15W to Port A. |
| Sink Cap | 45W | | Source sends Get Sink Cap message to Port A and max 45W Sink Cap is returned. |
| Source Cap 2 | 45W | | A 45W Source Cap is sent again based on Sink Cap. |
| Sink Request | 45W | | Port A Sink requests 45W. |
| Power Distributed to Sink | 45W | | 45W distributed to Port A Sink. |

Table 5-8. FSP Example With Blind Sink Support (continued)

| | Port A | Port B | SPM Operation Description |
|---|--------|--------|---|
| Scenario 2: Port A is replaced with a Blind Sink. Port B is still unconnected. | | | |
| Source Cap 1 | 15W | | The first Source Cap is sent to Port A's Sink with Port Min Power. |
| Sink Request | 15W | | Grant 15W to Port A. |
| Sink Cap | 15W | | Source sends Get Sink Cap message to Port A. Source Cap = Sink Cap is returned. Port A Sink is identified as a Blind Sink. |
| Source Cap 2 | 60W | | A Source Cap is sent again with Port Max Power. |
| Sink Request | 60W | | Port A Sink requests 60W. |
| Power Distributed to Sink | 60W | | 60W is distributed to Port A Sink. |
| Scenario 3: Port B connects to Good Sink #2. Port A continues to deliver 60 W to Blind Sink. | | | |
| Source Cap 1 | | 15W | The first Source Cap is sent to Port B's Sink with Port Min Power. |
| Sink Request | | 15W | Grant 15W to Port B. |
| Sink Cap | | 20W | Source sends Get Sink Cap message to Port B and max 20W Sink Cap is returned. |
| Source Cap 2 | 55W | 20W | Port A Sink's required power is less than the Per Port Guaranteed FSP. Port B's required power is higher. The SPM distributes power to the Port A's Sink requesting lower power and the remaining power to Port B's Sink. |
| Sink Request | 55W | 20W | Port A Sink requests 55W and Port B Sink requests 20W. |
| Power Distributed to Sinks | 55W | 20W | 55W distributed to Port A Sink. 20W distributed to Port B Sink. |

Figure 5-5, Figure 5-6, and Figure 5-7 show the PD negotiation flow of the FSP examples from Scenario 1, Scenario 2, and Scenario 3 of Table 5-8, respectively.

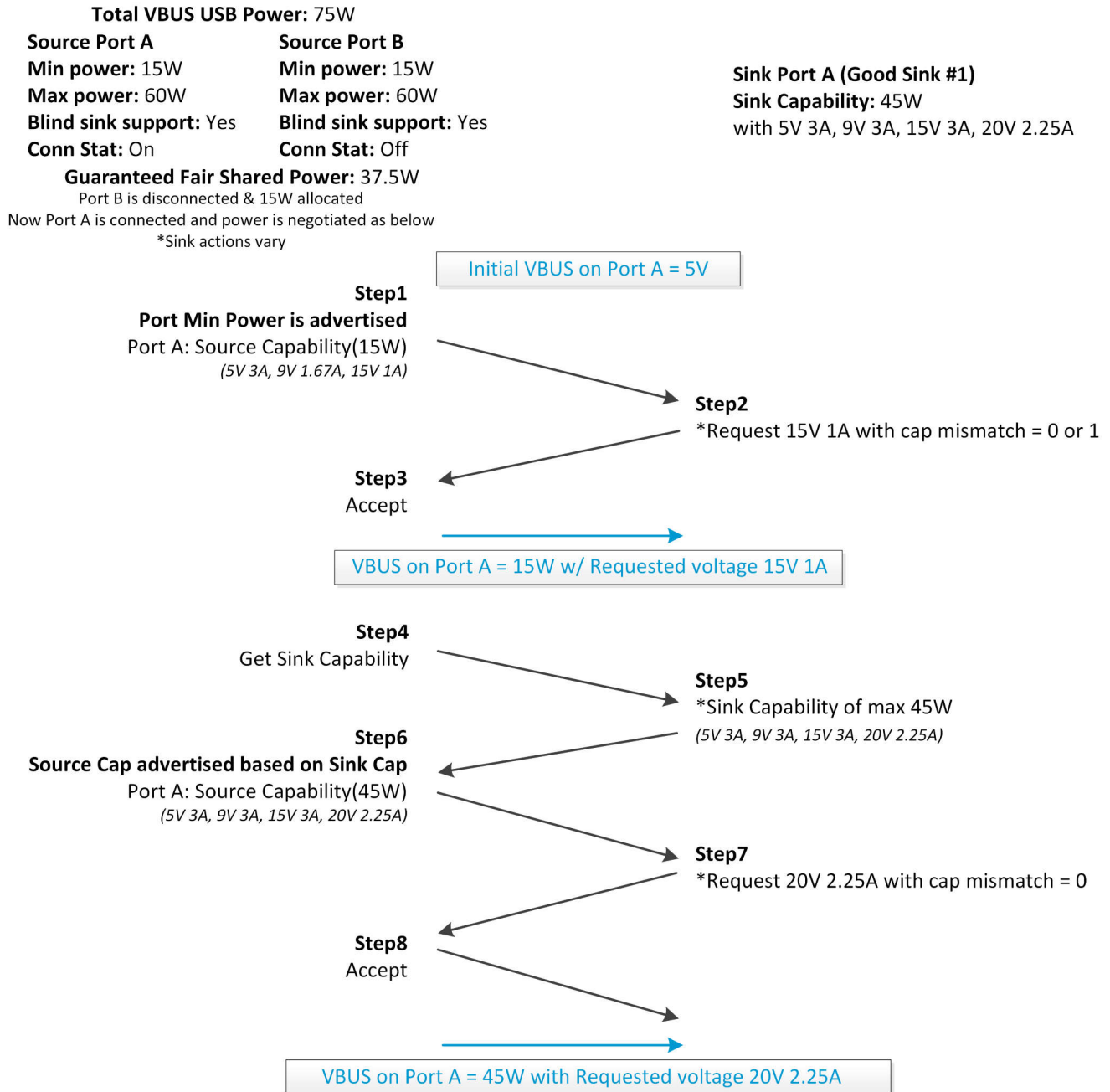

Figure 5-5. FSP Negotiation Flow With Blind Sink Support – Scenario 1

Total VBUS USB Power: 75W

Source Port A

Min power: 15W

Max power: 60W

Blind sink support: Yes

Conn Stat: On

Source Port B

Min power: 15W

Max power: 60W

Blind sink support: Yes

Conn Stat: Off

Guaranteed Fair Shared Power: 37.5W

Port B is still disconnected & 15W allocated

Port A is replaced with a Blind Sink and power is negotiated as below

*Sink actions vary

Sink Port A (Blind Sink)

Possible Blind Sink Capability:

- 5V 1.5A (less than requested power);
- 5V 3A, 9V 1.67A, 15V 1A(blindly copy);
- "Not supported";
- No response

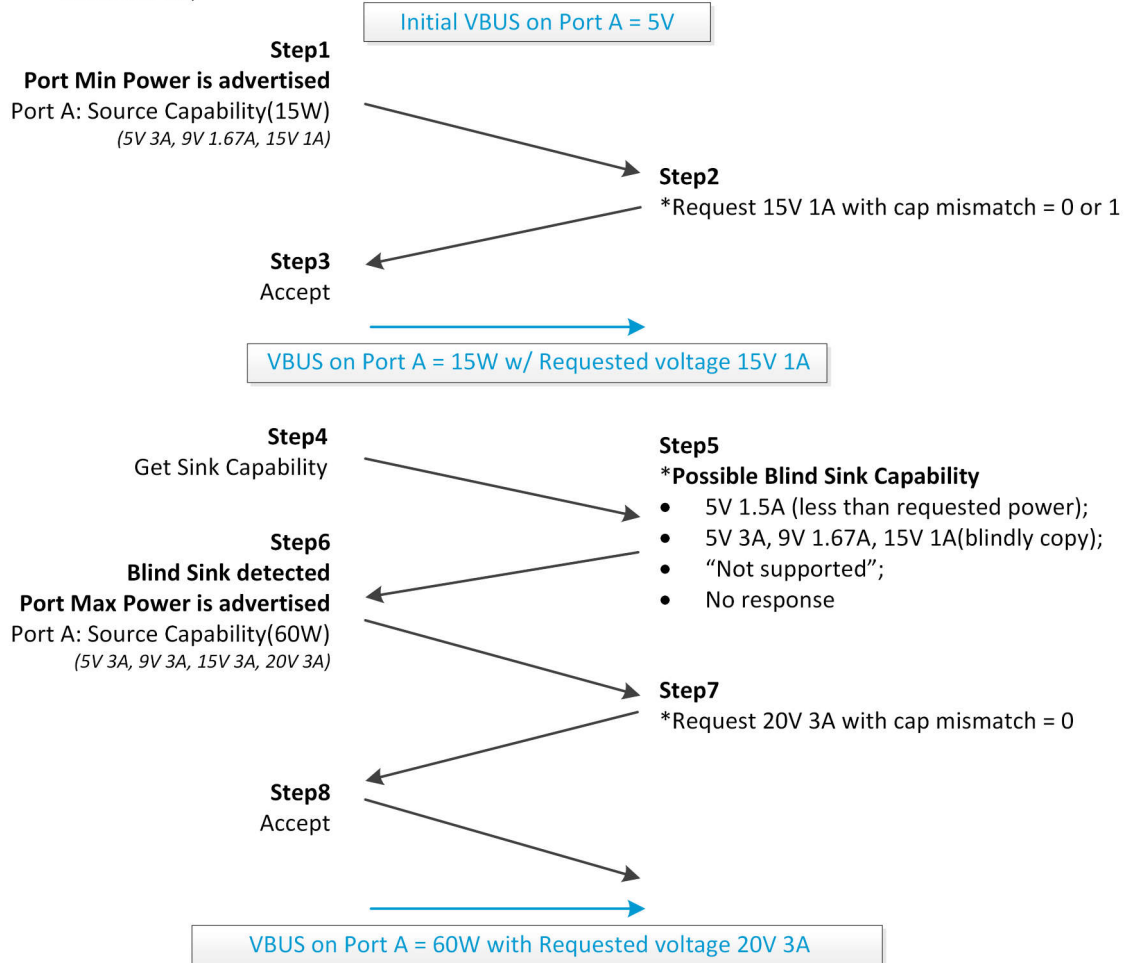

Figure 5-6. FSP Negotiation Flow With Blind Sink Support – Scenario 2

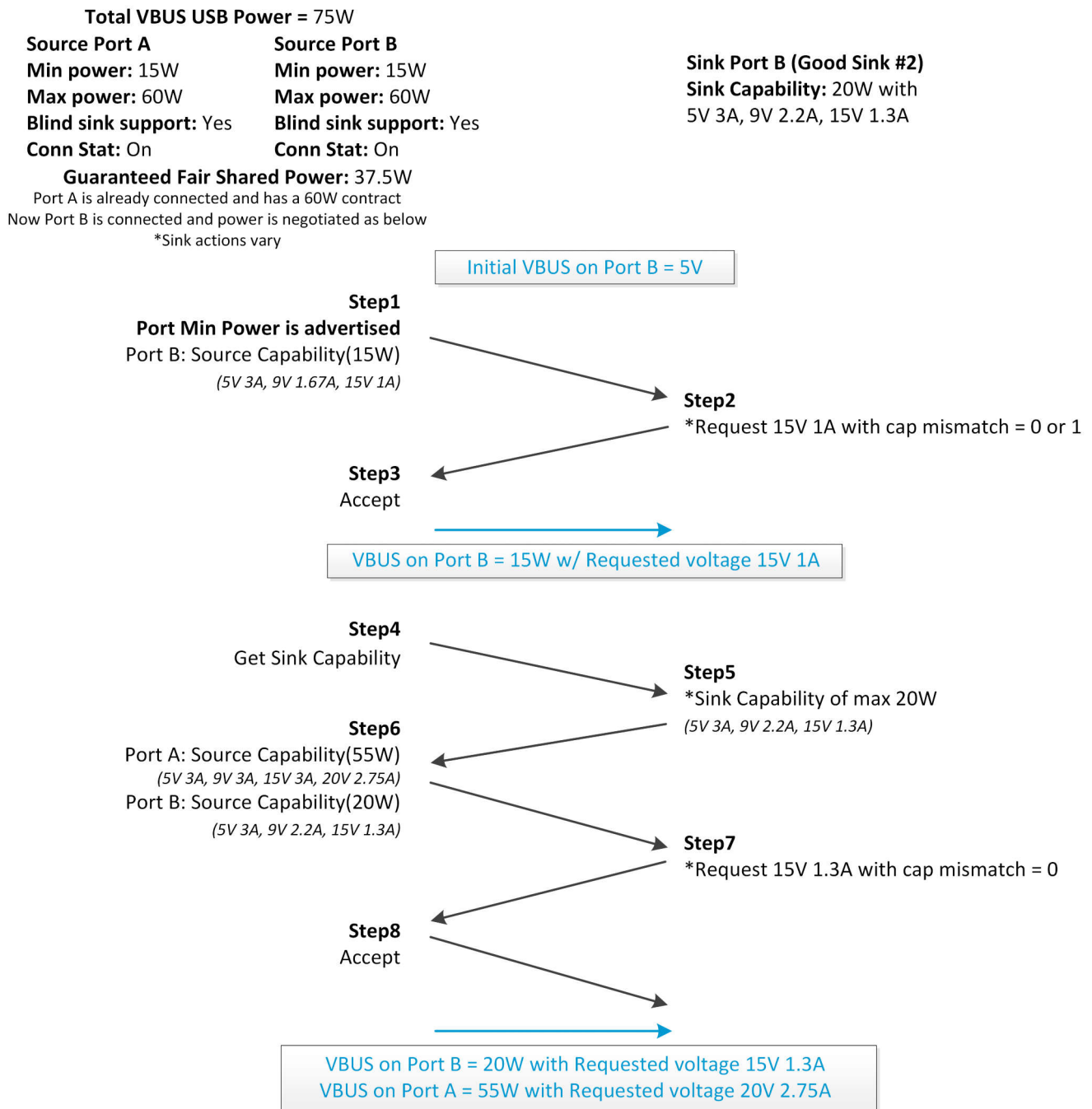

Figure 5-7. FSP Negotiation Flow With Blind Sink Support – Scenario 3

5.2.2 FSP Policy Example – Blind Sink Support With Max Power

This section provides three additional examples of Fair Share Power Policy's power distribution, but with Blind Sink Support and Max Power enabled for both ports, and are shown in [Table 5-9](#). With these two FSP settings enabled, Port Max Power is always advertised after the initial Source Capabilities message regardless of the Sink's behavior. The SPM Engine Parameters for these examples are the same as shown in [Table 5-6](#)

Table 5-9. FSP Example With Blind Sink Support and Max Power

| | Port A | Port B | SPM Operation Description |
|---|--------|----------------------|---|
| Initially Allocated | 15W | 15W | Min Power is initially allocated for Port A and Port B. |
| Scenario 1: Port A connects to Good Sink 1. Port B is unconnected. | | | |
| Source Cap 1 | 15W | | The first Source Cap is sent to Port A's Sink with Port Min Power. |
| Sink Request | 15W | | Grant 15W to Port A. |
| Sink Cap | 45W | | Source sends Get Sink Cap message to Port A and max 45W Sink Cap is returned. |
| Source Cap 2 | 60W | | Source Cap is sent again with Port Max Power since Max Power is enabled. |
| Sink Request | 60W | | Port A Sink requests 60W. |
| Power Distributed to Sink | 60W | | 60W delivered to Port A Sink. |
| Scenario 2: Port A is replaced with a Blind Sink. Port B is still unconnected. | | | |
| Source Cap 1 | 15W | | The first Source Cap is sent to Port A's Sink with Port Min Power. |
| Sink Request | 15W | | Grant 15W to Port A. |
| Sink Cap | 15W | | Source sends Get Sink Cap message to Port A. Source Cap = Sink Cap is returned, but is a don't care with Max Power enabled. |
| Source Cap 2 | 60W | | A Source Cap is sent again with Port Max Power. |
| Sink Request | 60W | | Port A Sink requests 60W. |
| Power Distributed to Sink | 60W | | 60W is distributed to Port A Sink. |
| Scenario 3: Port B connects to Good Sink 2. Port A continues to deliver 60W to Blind Sink. | | | |
| Source Cap 1 | | 15W | The first Source Cap is sent to Port B's Sink with Port Min Power. |
| Sink Request | | 15W | Grant 15W to Port B. |
| Sink Cap | | 20W | Source sends Get Sink Cap message to Port B and max 20W Sink Cap is returned. |
| Source Cap 2 | 37.5W | 37.5W | Max Power is enabled, so Per Port Guaranteed FSP is advertised to both Sinks regardless of Sink Capabilities. |
| Sink Request | 37.5W | 37.5W | Port A and B's Sinks request 37.5W. |
| Power Distributed to Sinks | 37.5W | 37.5W ⁽¹⁾ | Each Sink gets Per Port Guaranteed FSP of 37.5W. |

(1) Some Sink devices return a Sink Capabilities message that is lower than what they are actually able to consume. The Max Power option can be adopted to support higher power charging for Sink devices such as these.

Figure 5-8, Figure 5-9, and Figure 5-10 show the PD negotiation flow of the FSP examples from Scenario 1, Scenario 2, and Scenario 3 of Table 5-9, respectively.

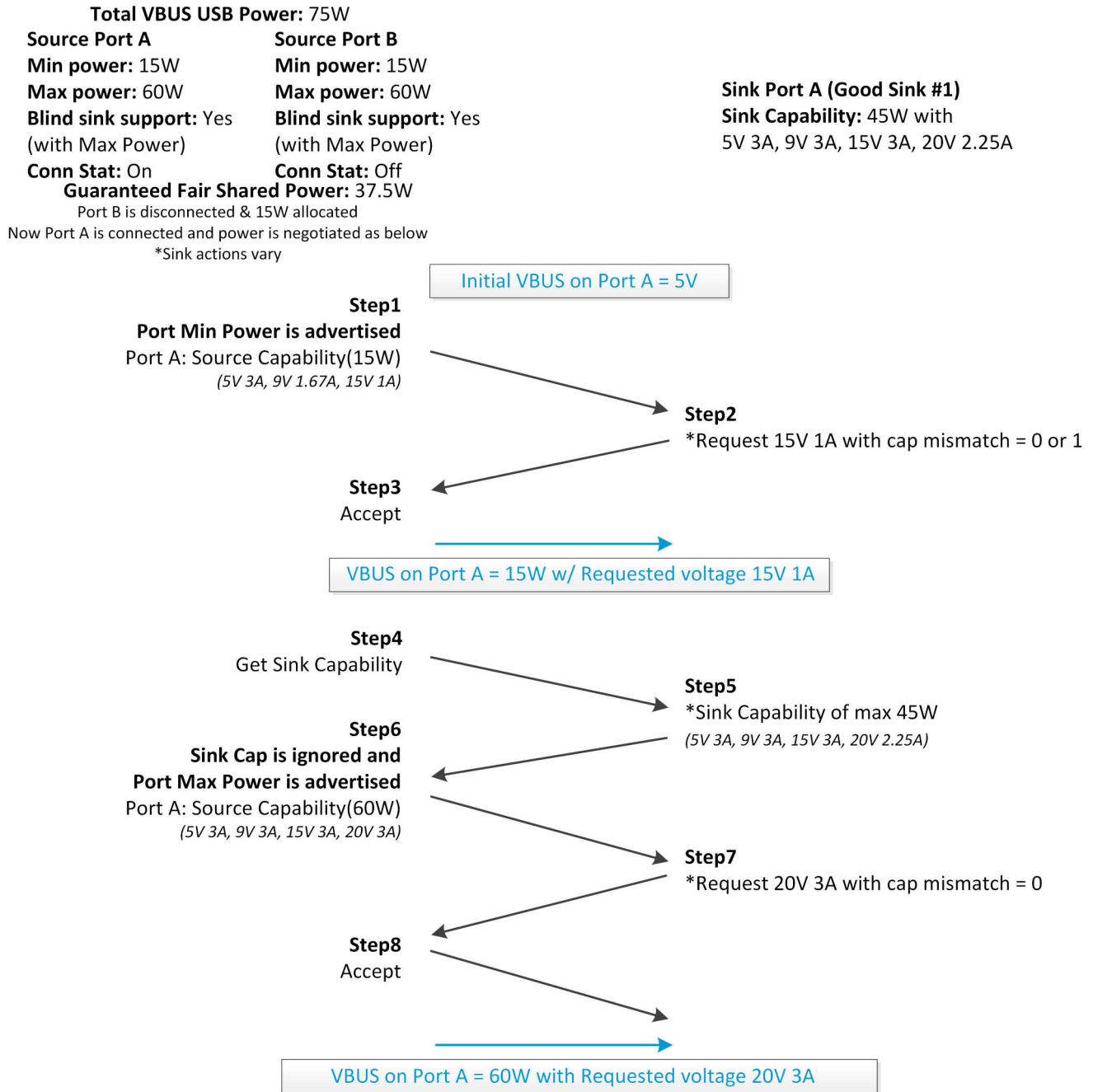

Figure 5-8. FSP Negotiation With Blind Sink Support and Max Power - Scenario 1

Total VBUS USB Power = 75W

Source Port A

Min power: 15W

Max power: 60W

Blind sink support: Yes
(with Max Power)

Conn Stat: On

Guaranteed Fair Shared Power: 37.5W

Port B is still disconnected & 15W allocated

Port A is replaced with a Blind Sink and power is negotiated as below

*Sink actions vary

Source Port B

Min power: 15W

Max power: 60W

Blind sink support: Yes
(with Max Power)

Conn Stat: Off

Sink Port A (Blind Sink)

Possible Blind Sink Capability:

5V 1.5A (less than requested power);

5V 3A, 9V 1.67A, 15V 1A(blindly copy);

“Not supported”;

No response

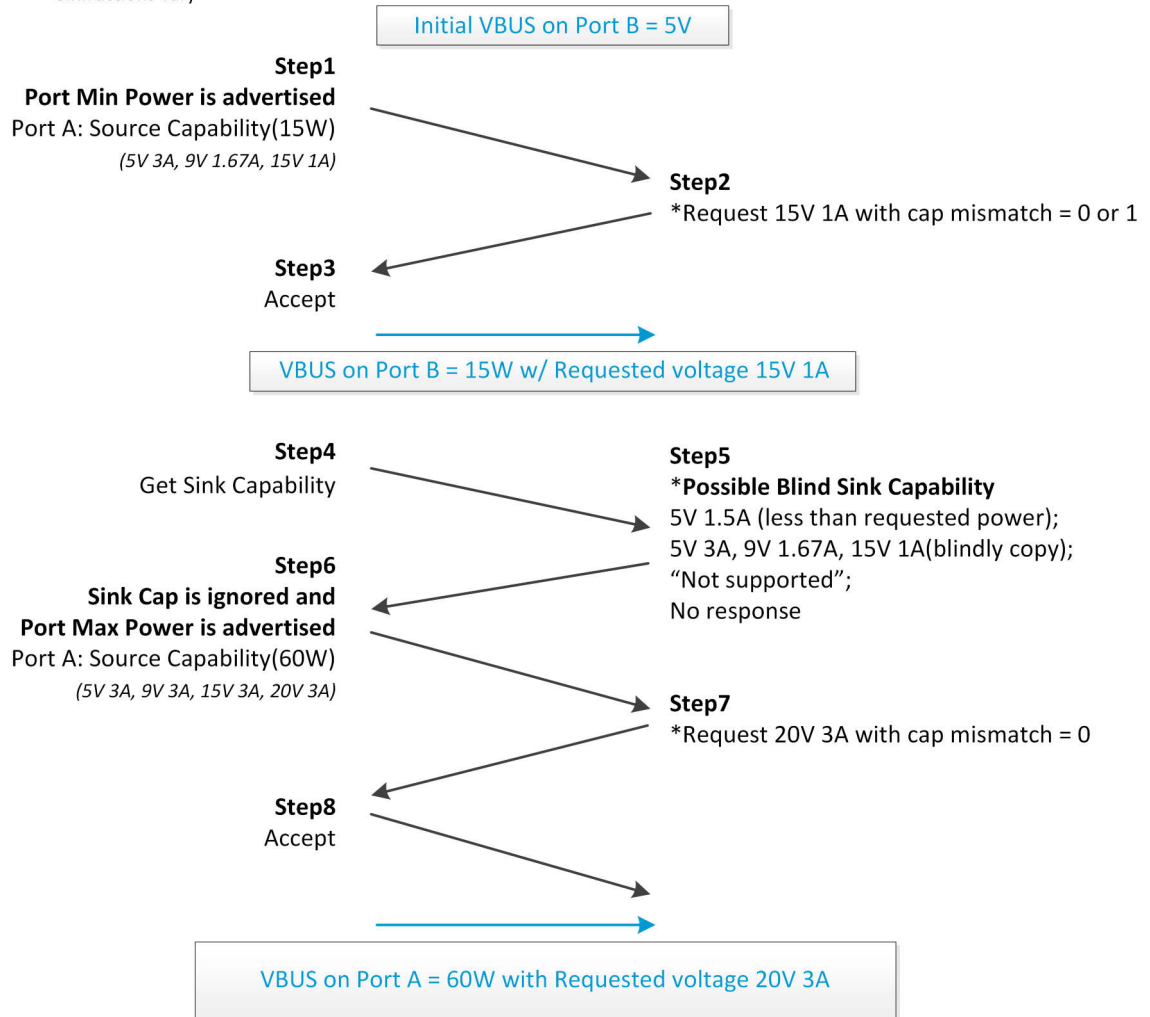

Figure 5-9. FSP Negotiation With Blind Sink Support and Max Power - Scenario 2

Total VBUS USB Power = 75W

Source Port A

Min power: 15W

Max power: 60W

Blind sink support: Yes
(with Max Power)

Conn Stat: On

Source Port B

Min power: 15W

Max power: 60W

Blind sink support: Yes
(with Max Power)

Conn Stat: On

Guaranteed Fair Shared Power: 37.5W

Port A is already connected and has a 60W contract
Now Port B is connected and power is negotiated as below

Sink Port B (Good Sink #2)

Sink Capability: 20W with
5V 3A, 9V 3A, 15V 1.3A

*Sink actions vary

**Regardless of Sink Capabilities, Guaranteed FSP will be distributed to both ports when Max Power is enabled.

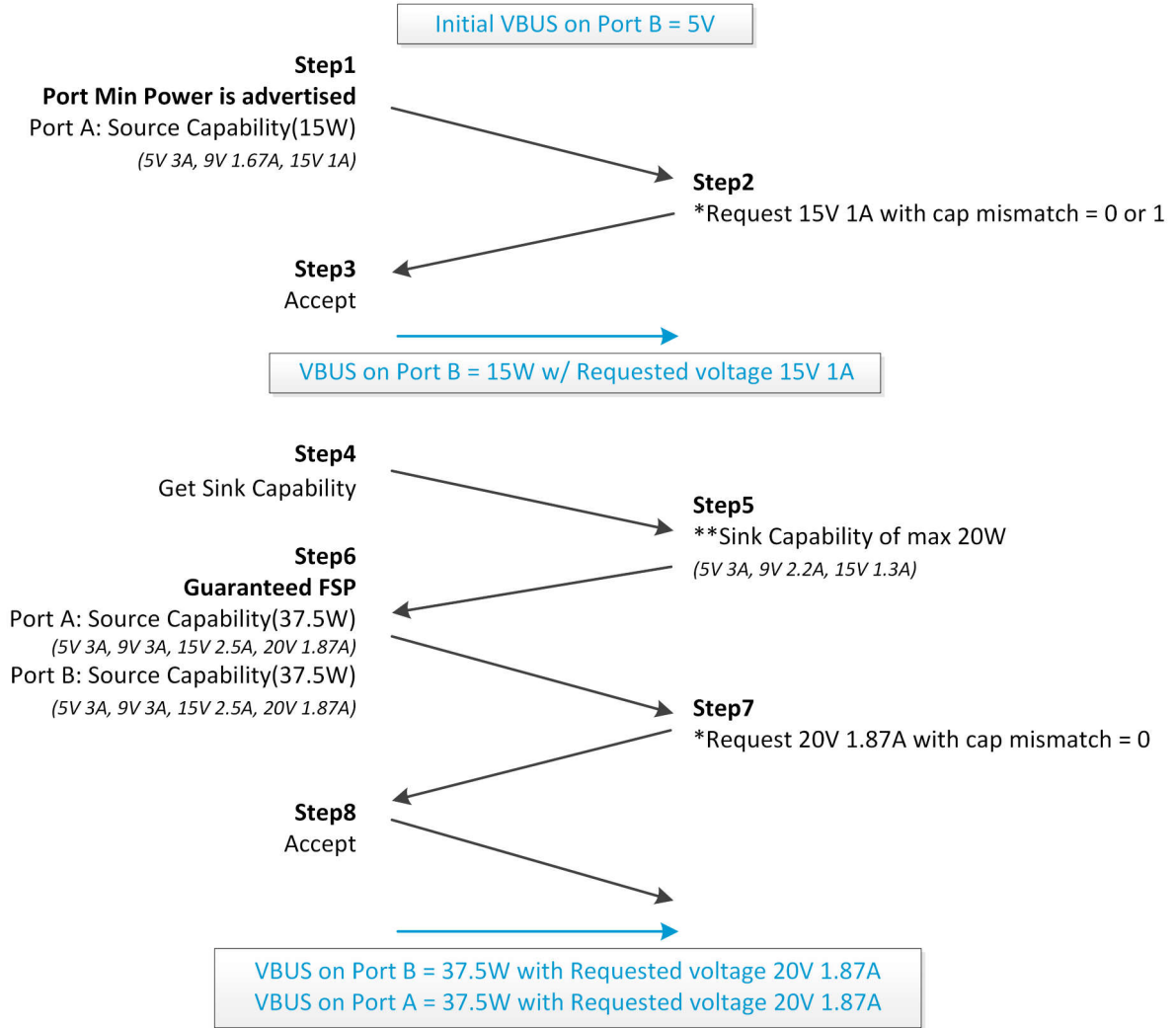

Figure 5-10. FSP Negotiation With Blind Sink Support and Max Power - Scenario 3

5.3 Hybrid Mode Example

This section provides examples of power distribution when the Source ports are in Hybrid Mode. [Table 5-10](#) shows the configurable SPM Engine parameters used in this section's example. [Table 5-11](#) shows the Hybrid Mode parameters used in the power distribution method.

Table 5-10. SPM Engine Parameters - Hybrid Mode Example

| SPM Engine Parameters | Configuration | Description |
|-----------------------------|--------------------|--|
| System Max Power | 54W ⁽¹⁾ | Total system power capacity allocated for Port A and B |
| Port A Max Power | 45W | Maximum Port A Power |
| Port B Max Power | 45W | Maximum Port B Power |
| Port A Min Power | 9W | Minimum Port A power |
| Port B Min Power | 9W | Minimum Port B power |
| Assured Mode ⁽²⁾ | Max Init Power | Source initially sends Source Capabilities advertising max power |

- (1) The System Max Power is 54W; less than the sum of Port A Max Power and Port B Max Power. This is how Hybrid Mode is enabled from the GUI.
- (2) Hybrid Mode is enabled with the Assured Capacity Policy selected in the GUI configurations.

Table 5-11. Hybrid Mode Parameters

| Fair Share Power Policy Parameters | Value | Description |
|------------------------------------|--------------|---|
| Equally Divided System Power | $54/2=27W$ | Equally divided System Max Power that is distributed to each port when two PD-Sinks are connected: System Max Power / Total number of ports. |
| Single Port Max Power Capacity | $54-9 W=45W$ | System Max Power - Port Min Power (limited up to Port Max Power) |
| Non-PD USB-C Power | 15W | USB Type-C 5V output for non-PD based USB Type-C charging |

Three scenarios of Hybrid Mode power distribution are listed in [Table 5-12](#) as examples.

Table 5-12. Hybrid Mode Example

| | Port A | Port B |
|--|--------|--------|
| Initially Allocated | 27W | 27W |
| Scenario 1: Port A is unconnected. Port B connects to a Sink that requires 45W. | | |
| Power Required by Sink | | 45W |
| Power Distributed to Sink | | 45W |
| Scenario 2: Port A connects to a Sink that also requires 45W. | | |
| Power Required by Sinks | 45W | 45W |
| Power Distributed to Sinks | 27W | 27W |
| Scenario 3: Port B's Port Partner is replaced with a non-PD Sink. | | |
| Power Required by Sink | 45W | |
| Power Distributed to Sinks ⁽¹⁾ | 39W | 15W |

- (1) Power distribution updates after roughly 8.5 seconds when the TPS257xx-Q1 firmware identifies a non-PD Sink.

Figure 5-11, Figure 5-12, and Figure 5-13 show the PD negotiation flow following the Hybrid Mode examples from Scenario 1, Scenario 2, and Scenario 3 of Table 5-12, respectively.

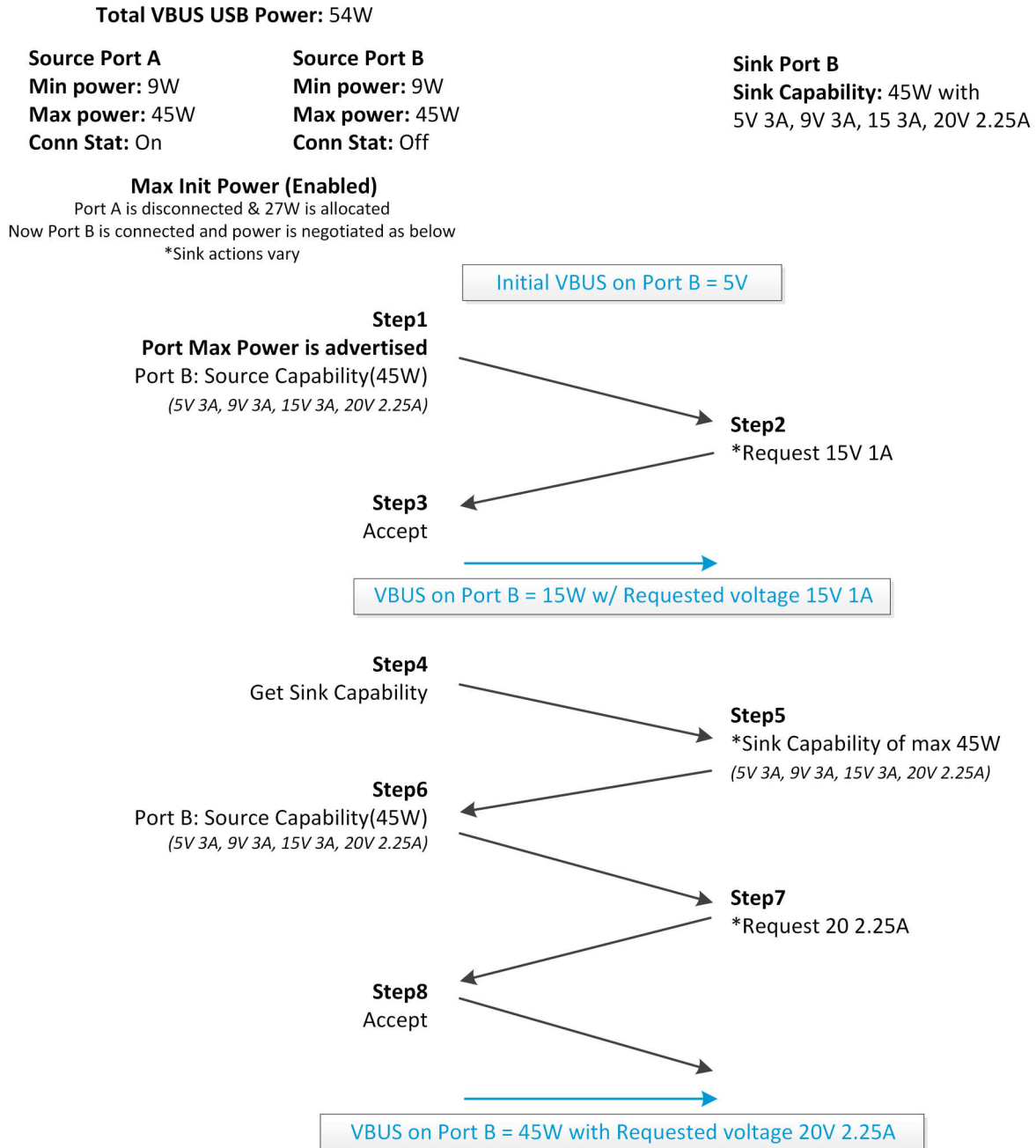

Figure 5-11. Hybrid Mode Negotiation Flow - Scenario 1

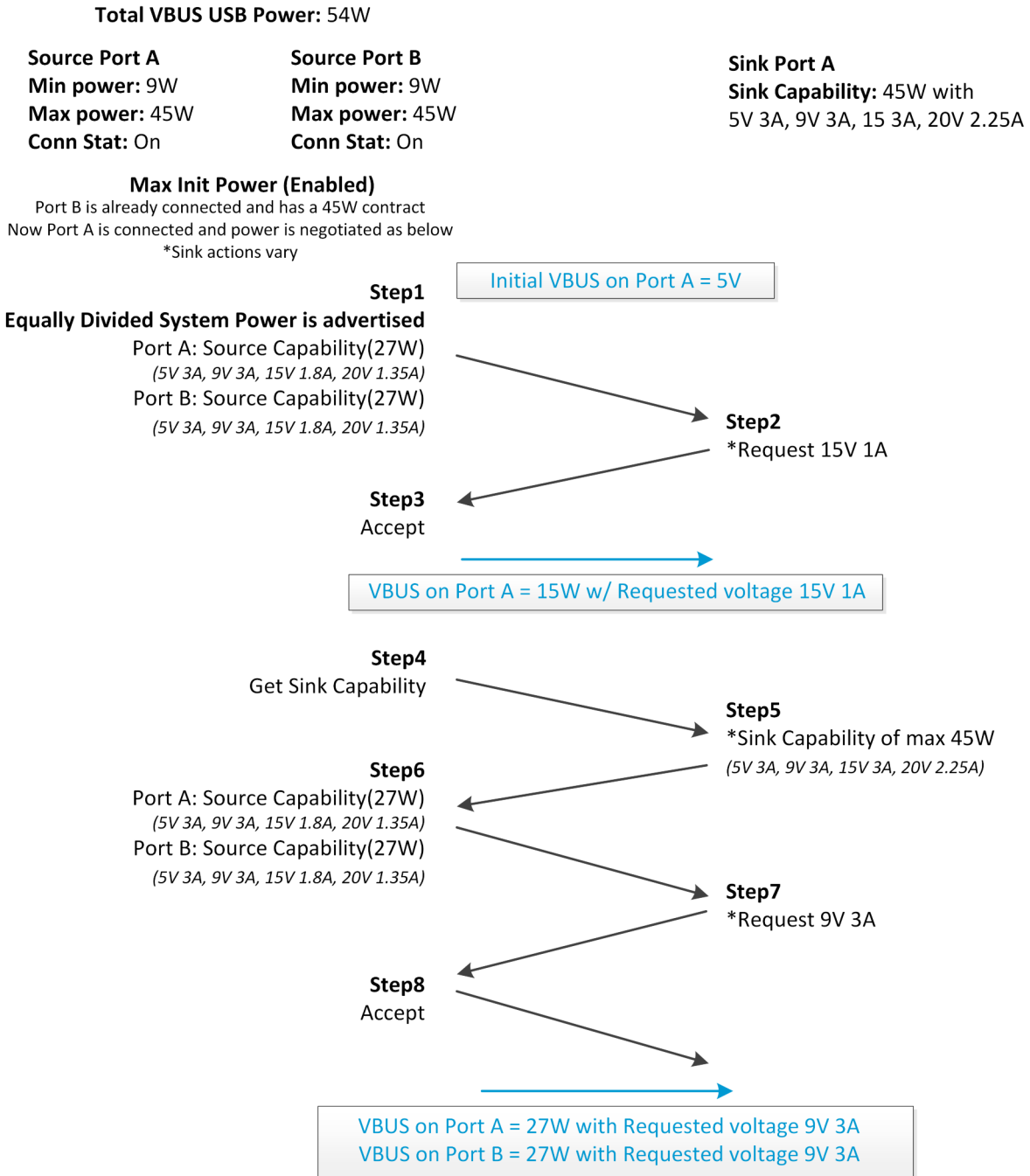

Figure 5-12. Hybrid Mode Negotiation Flow - Scenario 2

Total VBUS USB Power: 54W

Source Port A
Min power: 9W
Max power: 45W
Conn Stat: On

Source Port B
Min power: 9W
Max power: 45W
Conn Stat: On

Sink Port A
Sink Capability: 45W

Sink Port B (Non-PD Sink)
Sink Capability: n/a

Max Init Power (Enabled)

Now Port B is replaced with a non-PD Sink

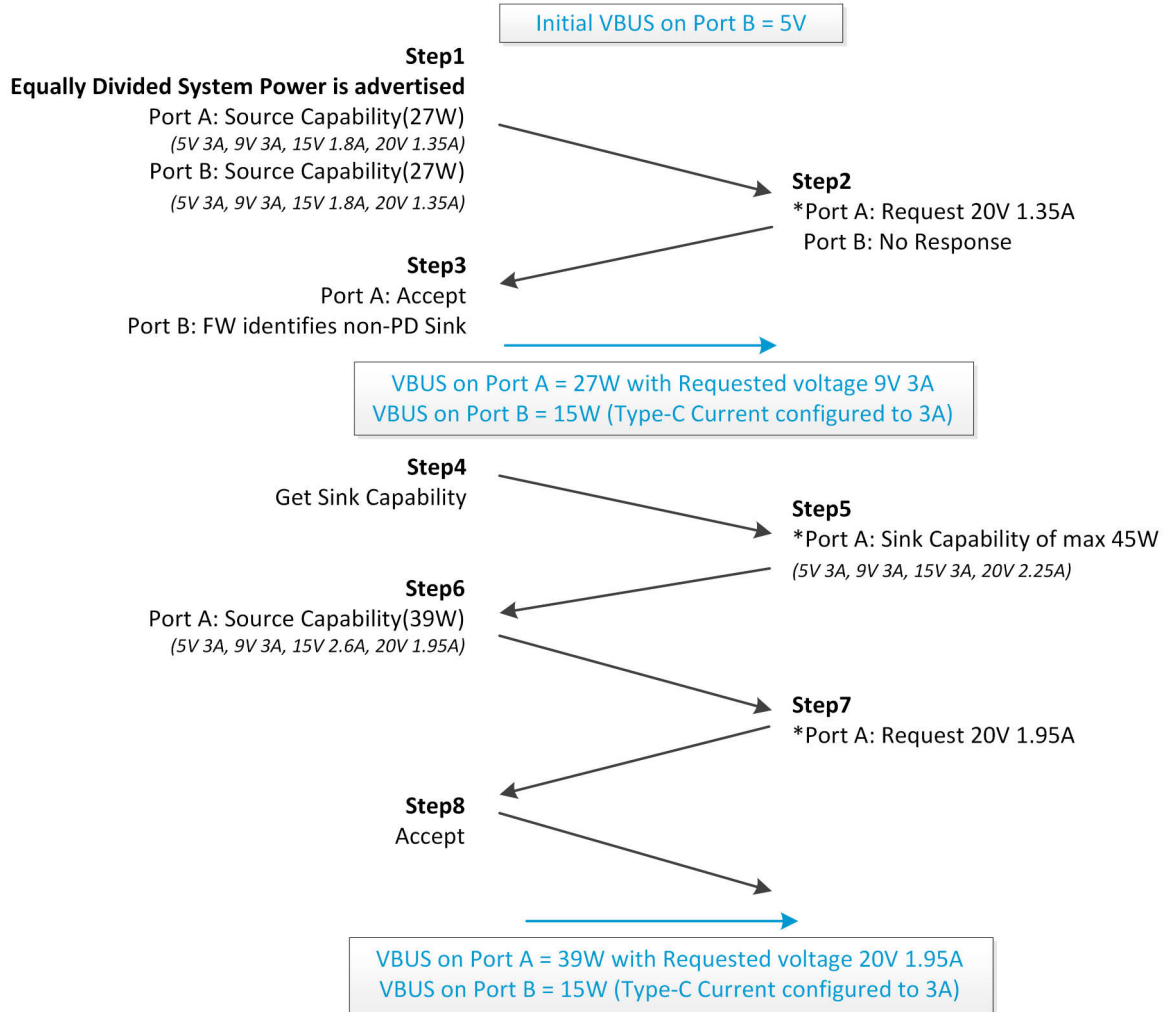

Figure 5-13. Hybrid Mode Negotiation Flow - Scenario 3

6 References

- Texas Instruments, [TPS25772-Q1 Automotive Dual USB Type-C® Power Delivery Controller with Buck-Boost Regulator](#) data sheet.
- Texas Instruments, [TPS25763-Q1 Automotive Dual USB Type-C® Power Delivery Controller with Buck-Boost Regulator and DisplayPort Alt Mode](#) data sheet.
- Texas Instruments, [TPS25762-Q1 Automotive USB Type-C® Power Delivery Controller with Buck-Boost Regulator](#) data sheet.
- Texas Instruments, [TPS257XX-Q1-GUI Configuration Guide](#) user's guide.
- [Universal Serial Bus Type-C Cable and Connector Specification, Revision 2.4](#).
- [Universal Serial Bus Power Delivery Specification, Revision 3.2](#).

7 Revision History

| Changes from Revision A (November 2023) to Revision B (November 2024) | Page |
|---|-------------|
| • Changed "Total USB VBUS Power" to "System Max Power" throughout the document..... | 1 |
| • Updated Figure 4-1 and Figure 4-2 | 13 |
| • Updated Figure 4-4 | 13 |
| • Updated Table 4-4 and Table 4-5 | 16 |
| • Updated Figure 4-5 and Figure 4-6 | 16 |

IMPORTANT NOTICE AND DISCLAIMER

TI PROVIDES TECHNICAL AND RELIABILITY DATA (INCLUDING DATA SHEETS), DESIGN RESOURCES (INCLUDING REFERENCE DESIGNS), APPLICATION OR OTHER DESIGN ADVICE, WEB TOOLS, SAFETY INFORMATION, AND OTHER RESOURCES "AS IS" AND WITH ALL FAULTS, AND DISCLAIMS ALL WARRANTIES, EXPRESS AND IMPLIED, INCLUDING WITHOUT LIMITATION ANY IMPLIED WARRANTIES OF MERCHANTABILITY, FITNESS FOR A PARTICULAR PURPOSE OR NON-INFRINGEMENT OF THIRD PARTY INTELLECTUAL PROPERTY RIGHTS.

These resources are intended for skilled developers designing with TI products. You are solely responsible for (1) selecting the appropriate TI products for your application, (2) designing, validating and testing your application, and (3) ensuring your application meets applicable standards, and any other safety, security, regulatory or other requirements.

These resources are subject to change without notice. TI grants you permission to use these resources only for development of an application that uses the TI products described in the resource. Other reproduction and display of these resources is prohibited. No license is granted to any other TI intellectual property right or to any third party intellectual property right. TI disclaims responsibility for, and you will fully indemnify TI and its representatives against, any claims, damages, costs, losses, and liabilities arising out of your use of these resources.

TI's products are provided subject to [TI's Terms of Sale](#) or other applicable terms available either on [ti.com](https://www.ti.com) or provided in conjunction with such TI products. TI's provision of these resources does not expand or otherwise alter TI's applicable warranties or warranty disclaimers for TI products.

TI objects to and rejects any additional or different terms you may have proposed.

Mailing Address: Texas Instruments, Post Office Box 655303, Dallas, Texas 75265
Copyright © 2024, Texas Instruments Incorporated