

LMP7707/LMP7708/LMP7709 Precision, CMOS Input, RRIO, Wide Supply Range Decompensated Amplifiers

Check for Samples: [LMP7707](#), [LMP7708](#), [LMP7709](#)

FEATURES

- Unless Otherwise Noted, Typical Values at $V_S = 5V$.
- Input Offset Voltage (LMP7707) $\pm 200 \mu V$ (Max)
- Input Offset Voltage (LMP7708/LMP7709) $\pm 220 \mu V$ (Max)
- Input Bias Current $\pm 200 fA$
- Input Voltage Noise $9 nV/\sqrt{Hz}$
- CMRR 130 dB
- Open Loop Gain 130 dB
- Temperature Range $-40^\circ C$ to $125^\circ C$
- Gain Bandwidth Product ($A_V = 10$) 14 MHz
- Stable at a Gain of 10 or Higher
- Supply Current (LMP7707) 715 μA
- Supply Current (LMP7708) 1.5 mA
- Supply Current (LMP7709) 2.9 mA
- Supply Voltage Range 2.7V to 12V
- Rail-to-Rail Input and Output

APPLICATIONS

- High Impedance Sensor Interface
- Battery Powered Instrumentation
- High Gain Amplifiers
- DAC Buffer
- Instrumentation Amplifier
- Active Filters

DESCRIPTION

The LMP7707/LMP7708/LMP7709 devices are single, dual, and quad low offset voltage, rail-to-rail input and output precision amplifiers which each have a CMOS input stage and a wide supply voltage range. The LMP7707/LMP7708/LMP7709 are part of the LMP™ precision amplifier family and are ideal for sensor interface and other instrumentation applications. These decompensated amplifiers are stable at a gain of 6 and higher.

The ensured low offset voltage of less than $\pm 200 \mu V$ along with the ensured low input bias current of less than $\pm 1 pA$ make the LMP7707/LMP7708/LMP7709 ideal for precision applications. The LMP7707/LMP7708/LMP7709 are built utilizing VIP50 technology, which allows the combination of a CMOS input stage and a supply voltage range of 12V with rail-to-rail common mode voltage capability. The LMP7707/LMP7708/LMP7709 are the perfect choice in many applications where conventional CMOS parts cannot operate due to the voltage conditions.

The unique design of the rail-to-rail input stage of each of the LMP7707/LMP7708/LMP7709 significantly reduces the CMRR glitch commonly associated with rail-to-rail input amplifiers. Both sides of the complimentary input stage have been trimmed, thereby reducing the difference between the NMOS and PMOS offsets. The output swings within 40 mV of either rail to maximize the signal dynamic range in applications requiring low supply voltage.

The LMP7707 is offered in the space-saving 5-pin SOT-23 and 8-pin SOIC packages, the LMP7708 is offered in the 8-pin VSSOP and 8-pin SOIC packages, and the quad LMP7709 is offered in the 14-pin TSSOP and 14-pin SOIC packages. These small packages are ideal solutions for area constrained PC boards and portable electronics.



Please be aware that an important notice concerning availability, standard warranty, and use in critical applications of Texas Instruments semiconductor products and disclaimers thereto appears at the end of this data sheet.

LMP is a trademark of Texas Instruments.

All other trademarks are the property of their respective owners.

Open Loop Frequency Response

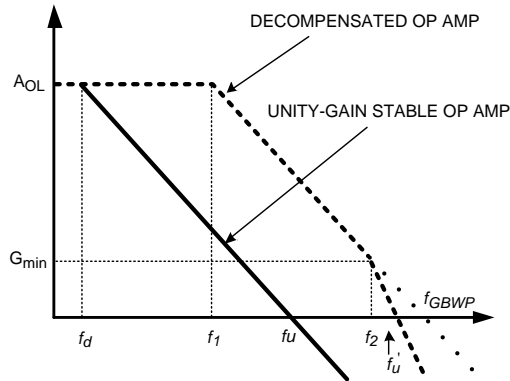

Figure 1. Increased Bandwidth for Same Supply Current at $A_V > 10$



These devices have limited built-in ESD protection. The leads should be shorted together or the device placed in conductive foam during storage or handling to prevent electrostatic damage to the MOS gates.

Absolute Maximum Ratings⁽¹⁾⁽²⁾

ESD Tolerance ⁽³⁾	Human Body Model	2000V
	Machine Model	200V
	Charge Device Model	1000V
V_{IN} Differential		± 300 mV
Supply Voltage ($V_S = V^+ - V^-$)		13.2V
Voltage at Input/Output Pins		$V^+ + 0.3V$ to $V^- - 0.3V$
Input Current		10 mA
Storage Temperature Range		-65°C to $+150^\circ\text{C}$
Junction Temperature ⁽⁴⁾		$+150^\circ\text{C}$
Soldering Information	Infrared or Convection (20 sec)	235°C
	Wave Soldering Lead Temp. (10 sec)	260°C

- (1) Absolute Maximum Ratings indicate limits beyond which damage to the device may occur. Operating Ratings indicate conditions for which the device is intended to be functional, but specific performance is not ensured. For ensured specifications and the test conditions, see the Electrical Characteristics tables.
- (2) If Military/Aerospace specified devices are required, please contact the Texas Instruments Sales Office/ Distributors for availability and specifications.
- (3) Human Body Model, applicable std. MIL-STD-883, Method 3015.7. Machine Model, applicable std. JESD22-A115-A (ESD MM std. of JEDEC) Field-Induced Charge-Device Model, applicable std. JESD22-C101-C (ESD FICDM std. of JEDEC).
- (4) The maximum power dissipation is a function of $T_{J(\text{MAX})}$, θ_{JA} . The maximum allowable power dissipation at any ambient temperature is $P_D = (T_{J(\text{MAX})} - T_A) / \theta_{JA}$. All numbers apply for packages soldered directly onto a PC board.

Operating Ratings⁽¹⁾

Temperature Range ⁽²⁾		-40°C to $+125^\circ\text{C}$
Supply Voltage ($V_S = V^+ - V^-$)		2.7V to 12V
Package Thermal Resistance (θ_{JA}) ⁽²⁾	5-Pin SOT-23	$265^\circ\text{C}/\text{W}$
	8-Pin SOIC	$190^\circ\text{C}/\text{W}$
	8-Pin VSSOP	$235^\circ\text{C}/\text{W}$
	14-Pin TSSOP	$122^\circ\text{C}/\text{W}$
	14-Pin SOIC	$145^\circ\text{C}/\text{W}$

- (1) Absolute Maximum Ratings indicate limits beyond which damage to the device may occur. Operating Ratings indicate conditions for which the device is intended to be functional, but specific performance is not ensured. For ensured specifications and the test conditions, see the Electrical Characteristics tables.
- (2) The maximum power dissipation is a function of $T_{J(\text{MAX})}$, θ_{JA} . The maximum allowable power dissipation at any ambient temperature is $P_D = (T_{J(\text{MAX})} - T_A) / \theta_{JA}$. All numbers apply for packages soldered directly onto a PC board.

3V Electrical Characteristics⁽¹⁾

Unless otherwise specified, all limits are ensured for $T_A = 25^\circ\text{C}$, $V^+ = 3\text{V}$, $V^- = 0\text{V}$, $V_{\text{CM}} = V^+/2$, and $R_L > 10\text{ k}\Omega$ to $V^+/2$.

Boldface limits apply at the temperature extremes.

Symbol	Parameter	Conditions	Min ⁽²⁾	Typ ⁽³⁾	Max ⁽²⁾	Units
V_{OS}	Input Offset Voltage	LMP7707		± 37	± 200 ± 500	μV
		LMP7708/LMP7709		± 56	± 220 ± 520	
TCV_{OS}	Input Offset Voltage Drift ⁽⁴⁾			± 1	± 5	$\mu\text{V}/^\circ\text{C}$
I_{B}	Input Bias Current ⁽⁴⁾⁽⁵⁾			± 0.2	± 1	pA
		$-40^\circ\text{C} \leq T_A \leq 85^\circ\text{C}$			± 50	
		$-40^\circ\text{C} \leq T_A \leq 125^\circ\text{C}$			± 400	
I_{OS}	Input Offset Current			40		fA
CMRR	Common Mode Rejection Ratio	$0\text{V} \leq V_{\text{CM}} \leq 3\text{V}$ LMP7707	86 80	130		dB
		$0\text{V} \leq V_{\text{CM}} \leq 3\text{V}$ LMP7708/LMP7709	84 78	130		
PSRR	Power Supply Rejection Ratio	$2.7\text{V} \leq V^+ \leq 12\text{V}$, $V_{\text{O}} = V^+/2$	86 82	98		dB
CMVR	Input Common-Mode Voltage Range	CMRR $\geq 80\text{ dB}$	-0.2		3.2	V
		CMRR $\geq 77\text{ dB}$	-0.2		3.2	
A_{VOL}	Open Loop Voltage Gain	$R_L = 2\text{ k}\Omega$ (LMP7707) $V_{\text{O}} = 0.3\text{V}$ to 2.7V	100 96	114		dB
		$R_L = 2\text{ k}\Omega$ (LMP7708/LMP7709) $V_{\text{O}} = 0.3\text{V}$ to 2.7V	100 94	114		
		$R_L = 10\text{ k}\Omega$ $V_{\text{O}} = 0.2\text{V}$ to 2.8V	100 96	124		
V_{O}	Output Swing High	$R_L = 2\text{ k}\Omega$ to $V^+/2$ LMP7707		40	80 120	mV from V^+
		$R_L = 2\text{ k}\Omega$ to $V^+/2$ LMP7708/LMP7709		40	80 150	
		$R_L = 10\text{ k}\Omega$ to $V^+/2$ LMP7707		30	40 60	
		$R_L = 10\text{ k}\Omega$ to $V^+/2$ LMP7708/LMP7709		35	50 100	
	Output Swing Low	$R_L = 2\text{ k}\Omega$ to $V^+/2$ LMP7707		40	60 80	mV
		$R_L = 2\text{ k}\Omega$ to $V^+/2$ LMP7708/LMP7709		45	100 170	
		$R_L = 10\text{ k}\Omega$ to $V^+/2$ LMP7707		20	40 50	
		$R_L = 10\text{ k}\Omega$ to $V^+/2$ LMP7708/LMP7709		20	50 90	

- (1) Electrical table values apply only for factory testing conditions at the temperature indicated. Factory testing conditions result in very limited self-heating of the device.
- (2) Limits are 100% production tested at 25°C . Limits over the operating temperature range are ensured through correlations using the Statistical Quality Control (SQC) method.
- (3) Typical values represent the most likely parametric norm as determined at the time of characterization. Actual typical values may vary over time and will also depend on the application and configuration. The typical values are not tested and are not ensured on shipped production material.
- (4) This parameter is specified by design and/or characterization and is not tested in production.
- (5) Positive current corresponds to current flowing into the device.

3V Electrical Characteristics⁽¹⁾ (continued)

Unless otherwise specified, all limits are ensured for $T_A = 25^\circ\text{C}$, $V^+ = 3\text{V}$, $V^- = 0\text{V}$, $V_{\text{CM}} = V^+/2$, and $R_L > 10\text{ k}\Omega$ to $V^+/2$.

Boldface limits apply at the temperature extremes.

Symbol	Parameter	Conditions	Min ⁽²⁾	Typ ⁽³⁾	Max ⁽²⁾	Units
I_O	Output Short Circuit Current ⁽⁶⁾⁽⁷⁾	Sourcing $V_O = V^+/2$ $V_{\text{IN}} = 100\text{ mV}$	25 15	42		mA
		Sinking $V_O = V^+/2$ $V_{\text{IN}} = -100\text{ mV}$ (LMP7707)	25 20	42		
		Sinking $V_O = V^+/2$ $V_{\text{IN}} = -100\text{ mV}$ (LMP7708/LMP7709)	25 15	42		
I_S	Supply Current	LMP7707		0.670	1.0 1.2	mA
		LMP7708		1.4	1.8 2.1	
		LMP7709		2.9	3.5 4.5	
SR	Slew Rate ⁽⁸⁾	$V_O = 2 V_{\text{PP}}$, 10% to 90%		5.1		V/ μs
GBWP	Gain Bandwidth Product	$A_V = 10$		13		MHz
THD+N	Total Harmonic Distortion + Noise	$f = 1\text{ kHz}$, $A_V = 10$, $V_O = 2.5\text{V}$, $R_L = 10\text{ k}\Omega$		0.024		%
e_n	Input-Referred Voltage Noise	$f = 1\text{ kHz}$		9		nV/ $\sqrt{\text{Hz}}$
i_n	Input-Referred Current Noise	$f = 100\text{ kHz}$		1		fA/ $\sqrt{\text{Hz}}$

(6) The maximum power dissipation is a function of $T_{\text{J(MAX)}}$, θ_{JA} . The maximum allowable power dissipation at any ambient temperature is $P_D = (T_{\text{J(MAX)}} - T_A) / \theta_{\text{JA}}$. All numbers apply for packages soldered directly onto a PC board.

(7) The short circuit test is a momentary test.

(8) The number specified is the slower of positive and negative slew rates.

5V Electrical Characteristics⁽¹⁾

Unless otherwise specified, all limits are ensured for $T_A = 25^\circ\text{C}$, $V^+ = 5\text{V}$, $V^- = 0\text{V}$, $V_{\text{CM}} = V^+/2$, and $R_L > 10\text{ k}\Omega$ to $V^+/2$.

Boldface limits apply at the temperature extremes.

Symbol	Parameter	Conditions	Min ⁽²⁾	Typ ⁽³⁾	Max ⁽²⁾	Units
V_{OS}	Input Offset Voltage	LMP7707		± 37	± 200 ± 500	μV
		LMP7708/LMP7709		± 32	± 220 ± 520	
TCV _{OS}	Input Offset Voltage Drift ⁽⁴⁾			± 1	± 5	$\mu\text{V}/^\circ\text{C}$
I_B	Input Bias Current ⁽⁴⁾⁽⁵⁾			± 0.2	± 1	pA
		$-40^\circ\text{C} \leq T_A \leq 85^\circ\text{C}$			± 50	
		$-40^\circ\text{C} \leq T_A \leq 125^\circ\text{C}$			± 400	
I_{OS}	Input Offset Current			40		fA
CMRR	Common Mode Rejection Ratio	$0\text{V} \leq V_{\text{CM}} \leq 5\text{V}$ LMP7707	88 83	130		dB
		$0\text{V} \leq V_{\text{CM}} \leq 5\text{V}$ LMP7708/LMP7709	86 81	130		
PSRR	Power Supply Rejection Ratio	$2.7\text{V} \leq V^+ \leq 12\text{V}$, $V_O = V^+/2$	86 82	100		dB

(1) Electrical table values apply only for factory testing conditions at the temperature indicated. Factory testing conditions result in very limited self-heating of the device.

(2) Limits are 100% production tested at 25°C . Limits over the operating temperature range are ensured through correlations using the Statistical Quality Control (SQC) method.

(3) Typical values represent the most likely parametric norm as determined at the time of characterization. Actual typical values may vary over time and will also depend on the application and configuration. The typical values are not tested and are not ensured on shipped production material.

(4) This parameter is specified by design and/or characterization and is not tested in production.

(5) Positive current corresponds to current flowing into the device.

5V Electrical Characteristics⁽¹⁾ (continued)

 Unless otherwise specified, all limits are ensured for $T_A = 25^\circ\text{C}$, $V^+ = 5\text{V}$, $V^- = 0\text{V}$, $V_{\text{CM}} = V^+/2$, and $R_L > 10\text{ k}\Omega$ to $V^+/2$.

Boldface limits apply at the temperature extremes.

Symbol	Parameter	Conditions	Min ⁽²⁾	Typ ⁽³⁾	Max ⁽²⁾	Units
CMVR	Input Common-Mode Voltage Range	CMRR $\geq 80\text{ dB}$	-0.2		5.2	V
		CMRR $\geq 78\text{ dB}$	-0.2		5.2	
A _{VOL}	Open Loop Voltage Gain	R _L = 2 k Ω (LMP7707) V _O = 0.3V to 4.7V	100 96	119		dB
		R _L = 2 k Ω (LMP7708/LMP7709) V _O = 0.3V to 4.7V	100 94	119		
		R _L = 10 k Ω V _O = 0.2V to 4.8V	100 96	130		
V _O	Output Swing High	R _L = 2 k Ω to V ⁺ /2 LMP7707		60	110 130	mV from V ⁺
		R _L = 2 k Ω to V ⁺ /2 LMP7708/LMP7709		60	120 200	
		R _L = 10 k Ω to V ⁺ /2 LMP7707		40	50 70	
		R _L = 10 k Ω to V ⁺ /2 LMP7708/LMP7709		40	60 120	
	Output Swing Low	R _L = 2 k Ω to V ⁺ /2 LMP7707		50	80 90	mV
		R _L = 2 k Ω to V ⁺ /2 LMP7708/LMP7709		50	120 190	
		R _L = 10 k Ω to V ⁺ /2 LMP7707		30	40 50	
		R _L = 10 k Ω to V ⁺ /2 LMP7708/LMP7709		30	50 100	
I _O	Output Short Circuit Current ⁽⁶⁾⁽⁷⁾	Sourcing V _O = V ⁺ /2 V _{IN} = 100 mV (LMP7707)	40 28	66		mA
		Sourcing V _O = V ⁺ /2 V _{IN} = 100 mV (LMP7708/LMP7709)	38 25	66		
		Sinking V _O = V ⁺ /2 V _{IN} = -100 mV (LMP7707)	40 28	76		
		Sinking V _O = V ⁺ /2 V _{IN} = -100 mV (LMP7708/LMP7709)	40 23	76		
I _S	Supply Current	LMP7707		0.715	1.0 1.2	mA
		LMP7708		1.5	1.9 2.2	
		LMP7709		2.9	3.7 4.6	
SR	Slew Rate ⁽⁸⁾	V _O = 4 V _{PP} , 10% to 90%		5.6		V/ μs
GBWP	Gain Bandwidth Product	A _V = 10		14		MHz
THD+N	Total Harmonic Distortion + Noise	f = 1 kHz, A _V = 10, V _O = 4.5V, R _L = 10 k Ω		0.024		%
e _n	Input-Referred Voltage Noise	f = 1 kHz		9		nV/ $\sqrt{\text{Hz}}$
i _n	Input-Referred Current Noise	f = 100 kHz		1		fA/ $\sqrt{\text{Hz}}$

(6) The maximum power dissipation is a function of $T_{\text{J(MAX)}}$, θ_{JA} . The maximum allowable power dissipation at any ambient temperature is $P_D = (T_{\text{J(MAX)}} - T_A) / \theta_{\text{JA}}$. All numbers apply for packages soldered directly onto a PC board.

(7) The short circuit test is a momentary test.

(8) The number specified is the slower of positive and negative slew rates.

±5V Electrical Characteristics⁽¹⁾

Unless otherwise specified, all limits are ensured for $T_A = 25^\circ\text{C}$, $V^+ = 5\text{V}$, $V^- = -5\text{V}$, $V_{CM} = 0\text{V}$, and $R_L > 10\text{ k}\Omega$ to 0V .

Boldface limits apply at the temperature extremes.

Symbol	Parameter	Conditions	Min ⁽²⁾	Typ ⁽³⁾	Max ⁽²⁾	Units
V_{OS}	Input Offset Voltage	LMP7707		±37	±200 ±500	μV
		LMP7708/LMP7709		±37	±220 ±520	
TCV_{OS}	Input Offset Voltage Drift ⁽⁴⁾			±1	±5	$\mu\text{V}/^\circ\text{C}$
I_B	Input Bias Current ⁽⁴⁾⁽⁵⁾			±0.2	1	pA
		$-40^\circ\text{C} \leq T_A \leq 85^\circ\text{C}$			±50	
		$-40^\circ\text{C} \leq T_A \leq 125^\circ\text{C}$			±400	
I_{OS}	Input Offset Current			40		fA
CMRR	Common Mode Rejection Ratio	$-5\text{V} \leq V_{CM} \leq 5\text{V}$ LMP7707	92 88	138		dB
		$-5\text{V} \leq V_{CM} \leq 5\text{V}$ LMP7708/LMP7709	90 86	138		
PSRR	Power Supply Rejection Ratio	$2.7\text{V} \leq V^+ \leq 12\text{V}$, $V^- = 0\text{V}$, $V_O = V^+/2$	86 82	98		dB
CMVR	Input Common-Mode Voltage Range	CMRR $\geq 80\text{ dB}$	-5.2		5.2	V
		CMRR $\geq 78\text{ dB}$	-5.2		5.2	
A_{VOL}	Open Loop Voltage Gain	$R_L = 2\text{ k}\Omega$ (LMP7707) $V_O = -4.7\text{V}$ to 4.7V	100 98	121		dB
		$R_L = 2\text{ k}\Omega$ (LMP7708/LMP7709) $V_O = -4.7\text{V}$ to 4.7V	100 94	121		
		$R_L = 10\text{ k}\Omega$ (LMP7707) $V_O = -4.8\text{V}$ to 4.8V	100 98	134		
		$R_L = 10\text{ k}\Omega$ (LMP7708/LMP7709) $V_O = -4.8\text{V}$ to 4.8V	100 97	134		
V_O	Output Swing High	$R_L = 2\text{ k}\Omega$ to 0V LMP7707		90	150 170	mV from V^+
		$R_L = 2\text{ k}\Omega$ to 0V LMP7708/LMP7709		90	180 290	
		$R_L = 10\text{ k}\Omega$ to 0V LMP7707		40	80 100	
		$R_L = 10\text{ k}\Omega$ to 0V LMP7708/LMP7709		40	80 150	
	Output Swing Low	$R_L = 2\text{ k}\Omega$ to 0V LMP7707		90	130 150	mV from V^-
		$R_L = 2\text{ k}\Omega$ to 0V LMP7708/LMP7709		90	180 290	
		$R_L = 10\text{ k}\Omega$ to 0V LMP7707		40	50 60	
		$R_L = 10\text{ k}\Omega$ to 0V LMP7708/LMP7709		40	60 110	

- (1) Electrical table values apply only for factory testing conditions at the temperature indicated. Factory testing conditions result in very limited self-heating of the device.
- (2) Limits are 100% production tested at 25°C . Limits over the operating temperature range are ensured through correlations using the Statistical Quality Control (SQC) method.
- (3) Typical values represent the most likely parametric norm as determined at the time of characterization. Actual typical values may vary over time and will also depend on the application and configuration. The typical values are not tested and are not ensured on shipped production material.
- (4) This parameter is specified by design and/or characterization and is not tested in production.
- (5) Positive current corresponds to current flowing into the device.

±5V Electrical Characteristics⁽¹⁾ (continued)

 Unless otherwise specified, all limits are ensured for $T_A = 25^\circ\text{C}$, $V^+ = 5\text{V}$, $V^- = -5\text{V}$, $V_{\text{CM}} = 0\text{V}$, and $R_L > 10\text{ k}\Omega$ to 0V .

Boldface limits apply at the temperature extremes.

Symbol	Parameter	Conditions	Min ⁽²⁾	Typ ⁽³⁾	Max ⁽²⁾	Units
I_O	Output Short Circuit Current ⁽⁶⁾⁽⁷⁾	Sourcing $V_O = 0\text{V}$ $V_{\text{IN}} = 100\text{ mV}$ (LMP7707)	50 35	86		mA
		Sourcing $V_O = 0\text{V}$ $V_{\text{IN}} = 100\text{ mV}$ (LMP7708/LMP7709)	48 33	86		
		Sinking $V_O = 0\text{V}$ $V_{\text{IN}} = -100\text{ mV}$	50 35	84		
I_S	Supply Current	LMP7707		0.790	1.1 1.3	mA
		LMP7708		1.7	2.1 2.5	
		LMP7709		3.2	4.2 5.0	
SR	Slew Rate ⁽⁸⁾	$V_O = 9\text{ V}_{\text{PP}}$, 10% to 90%		5.9		V/ μs
GBWP	Gain Bandwidth Product	$A_V = 10$		15		MHz
THD+N	Total Harmonic Distortion + Noise	$f = 1\text{ kHz}$, $A_V = 10$, $V_O = 9\text{V}$, $R_L = 10\text{ k}\Omega$		0.024		%
e_n	Input-Referred Voltage Noise	$f = 1\text{ kHz}$		9		$\text{nV}/\sqrt{\text{Hz}}$
i_n	Input-Referred Current Noise	$f = 100\text{ kHz}$		1		$\text{fA}/\sqrt{\text{Hz}}$

(6) The maximum power dissipation is a function of $T_{\text{J(MAX)}}$, θ_{JA} . The maximum allowable power dissipation at any ambient temperature is $P_D = (T_{\text{J(MAX)}} - T_A) / \theta_{\text{JA}}$. All numbers apply for packages soldered directly onto a PC board.

(7) The short circuit test is a momentary test.

(8) The number specified is the slower of positive and negative slew rates.

Connection Diagrams

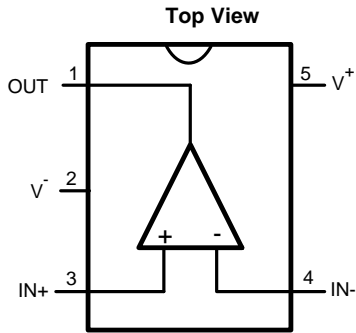

Figure 2. LMP7707 5-Pin SOT-23
See DBV Package

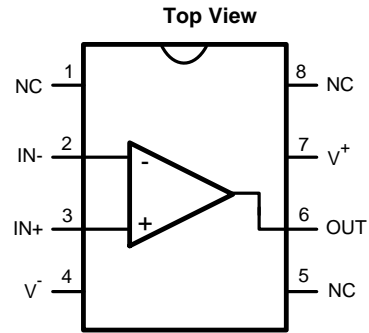

Figure 3. LMP7707 8-Pin SOIC
See D Package

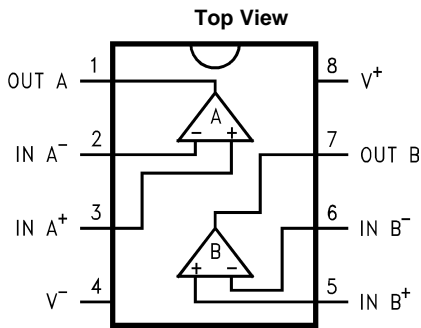

Figure 4. LMP7708 8-Pin VSSOP (See DGK Package)
LMP7708 8-Pin SOIC (See D Package)

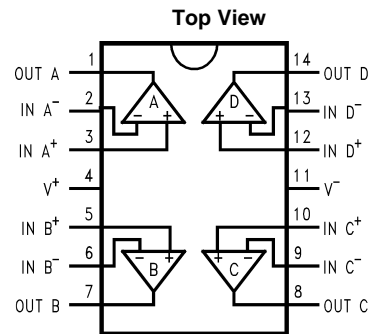

Figure 5. LMP7709 14-Pin TSSOP (See PW Package)
LMP7709 14-Pin SOIC (See D Package)

Typical Performance Characteristics

Unless otherwise specified, $T_A = 25^\circ\text{C}$, $V_{CM} = V_S/2$, $R_L > 10\text{ k}\Omega$ connected to $(V^+ + V^-)/2$

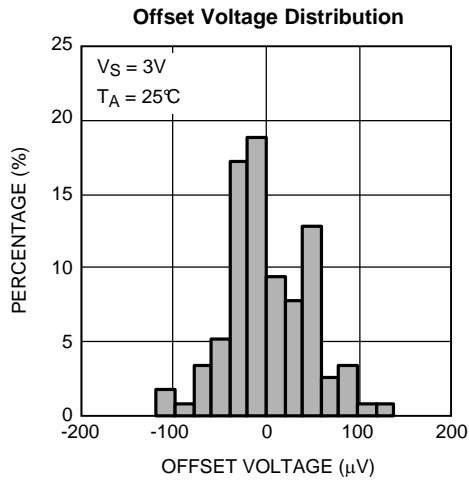

Figure 6.

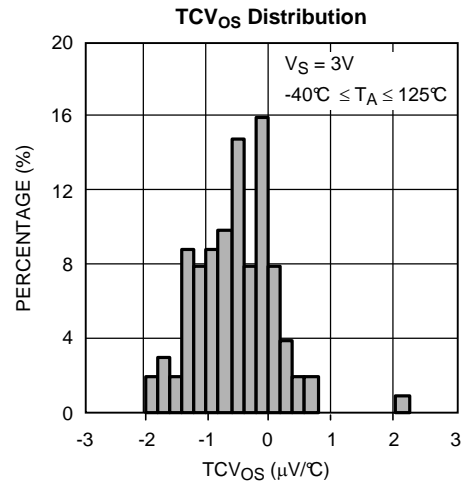

Figure 7.

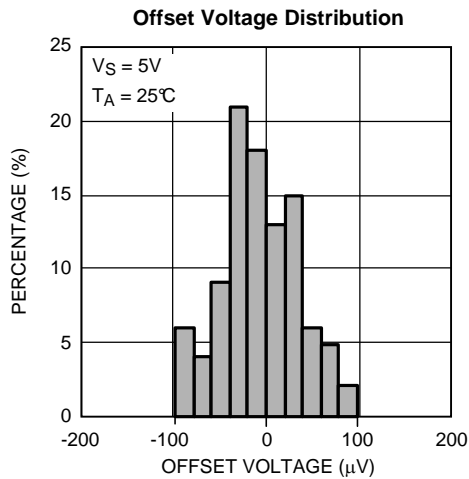

Figure 8.

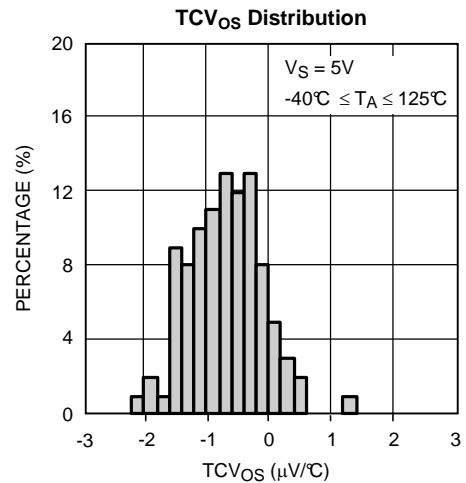

Figure 9.

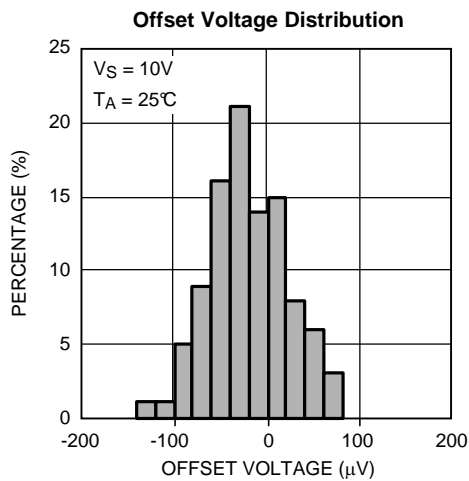

Figure 10.

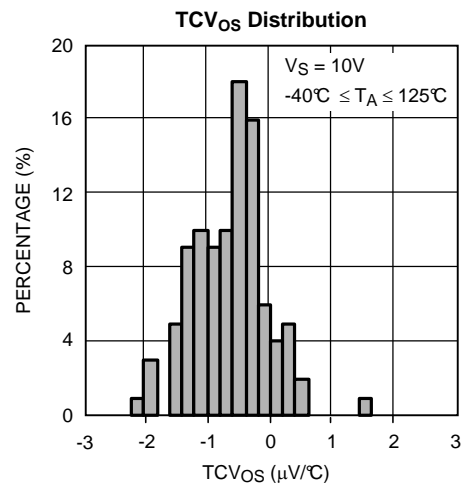

Figure 11.

Typical Performance Characteristics (continued)

Unless otherwise specified, $T_A = 25^\circ\text{C}$, $V_{CM} = V_S/2$, $R_L > 10\text{ k}\Omega$ connected to $(V^+ + V^-)/2$

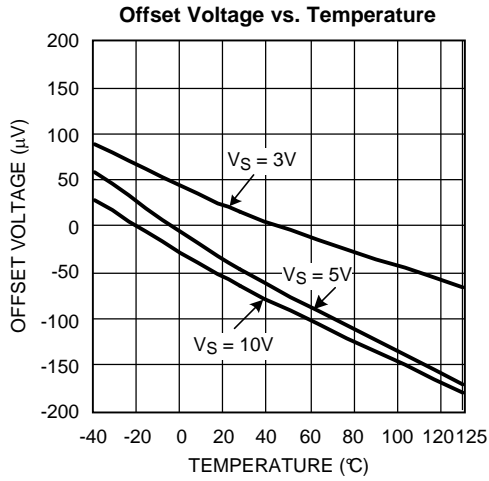

Figure 12.

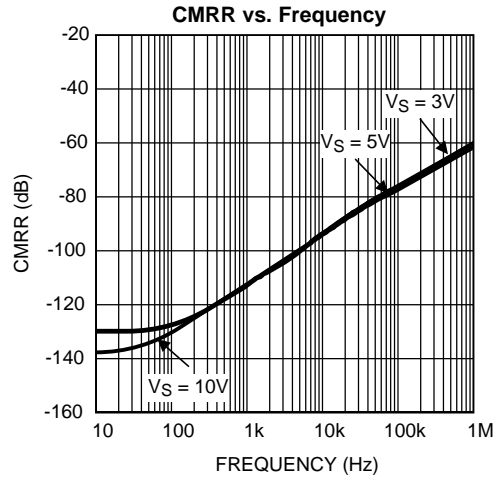

Figure 13.

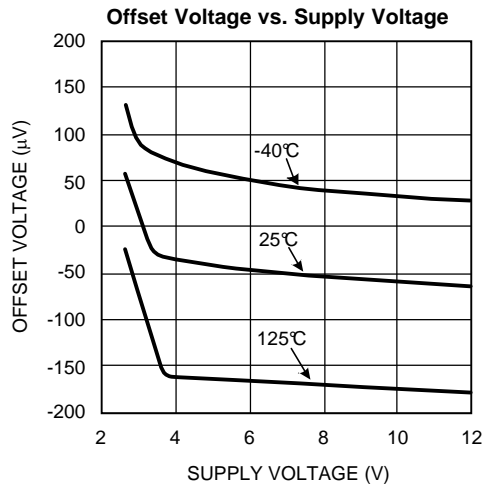

Figure 14.

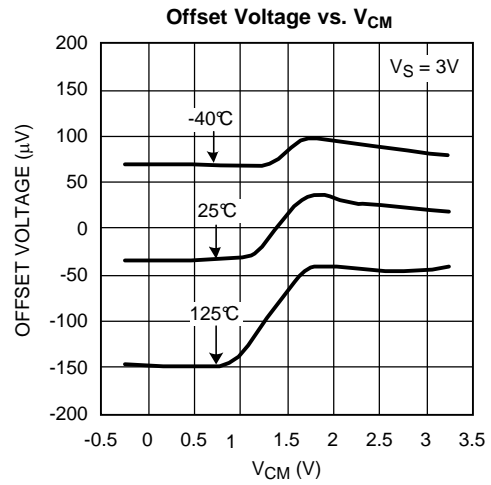

Figure 15.

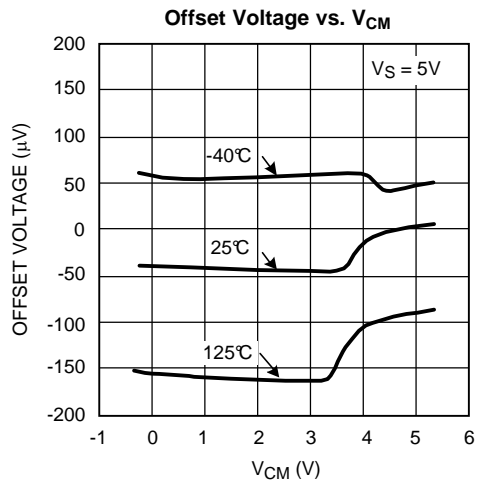

Figure 16.

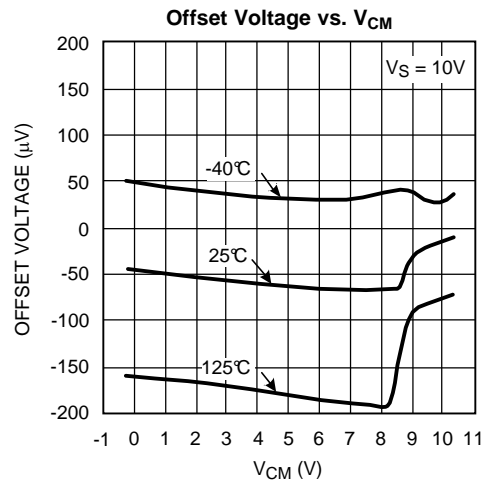

Figure 17.

Typical Performance Characteristics (continued)

Unless otherwise specified, $T_A = 25^\circ\text{C}$, $V_{CM} = V_S/2$, $R_L > 10\text{ k}\Omega$ connected to $(V^+ + V^-)/2$

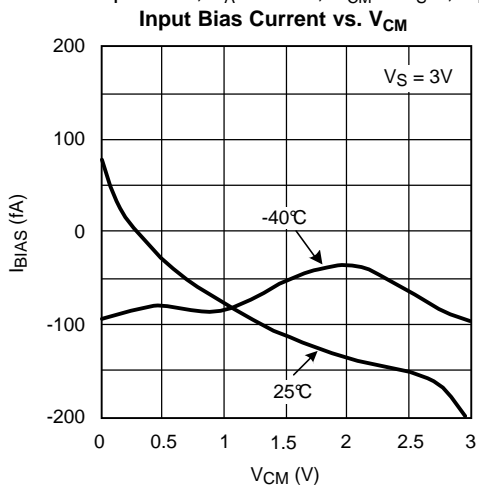

Figure 18.

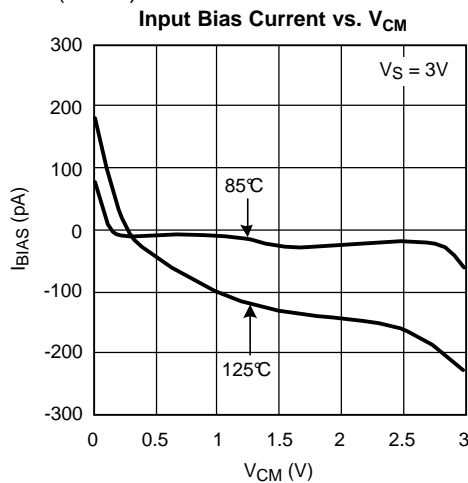

Figure 19.

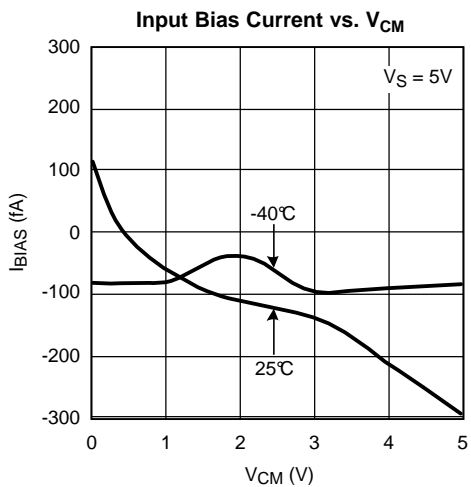

Figure 20.

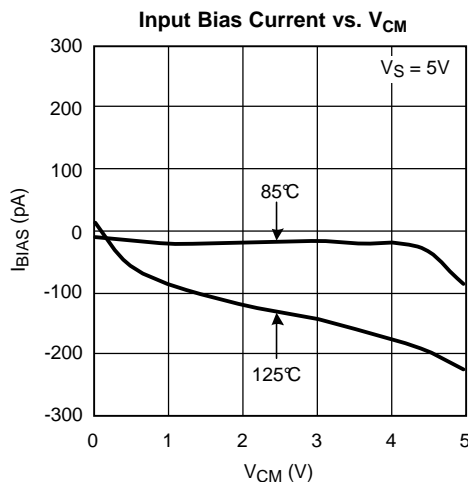

Figure 21.

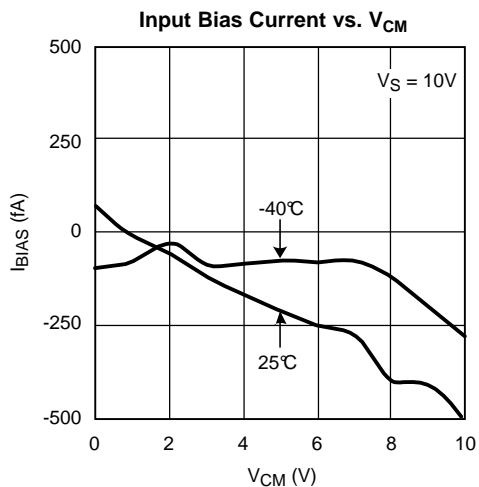

Figure 22.

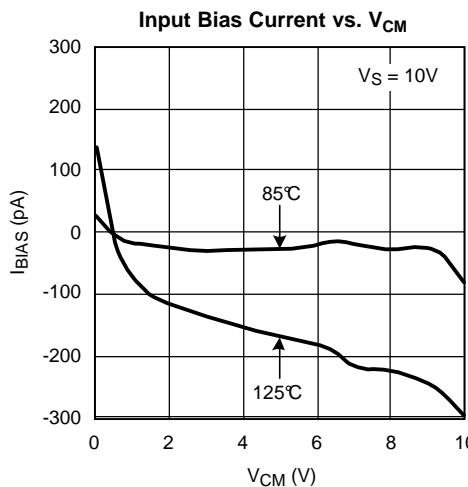

Figure 23.

Typical Performance Characteristics (continued)

Unless otherwise specified, $T_A = 25^\circ\text{C}$, $V_{CM} = V_S/2$, $R_L > 10\text{ k}\Omega$ connected to $(V^+ + V^-)/2$

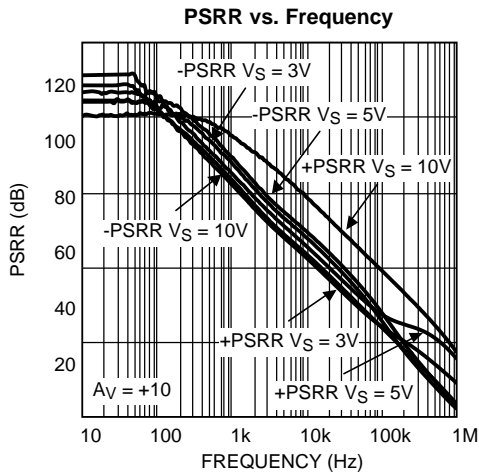

Figure 24.

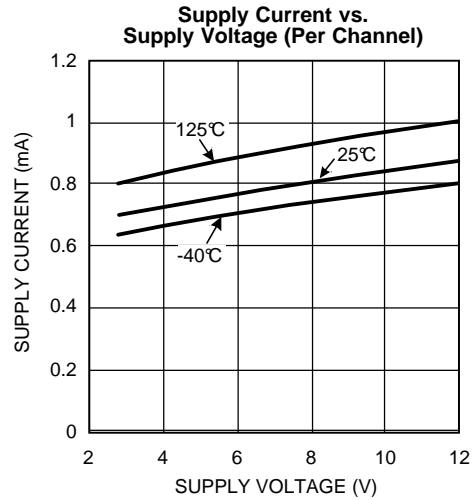

Figure 25.

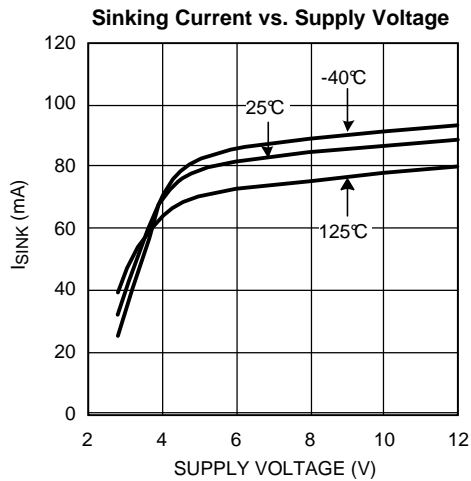

Figure 26.

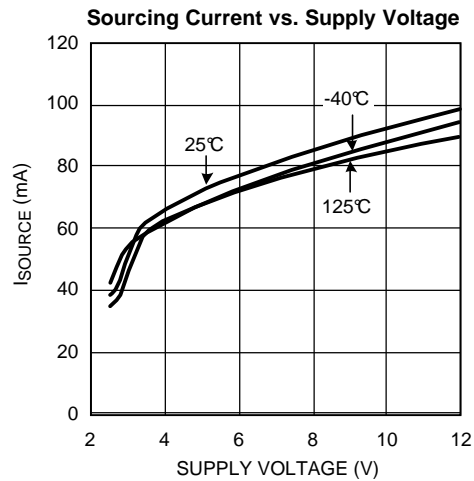

Figure 27.

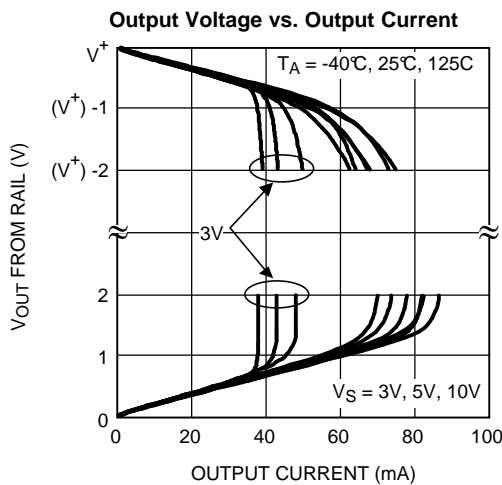

Figure 28.

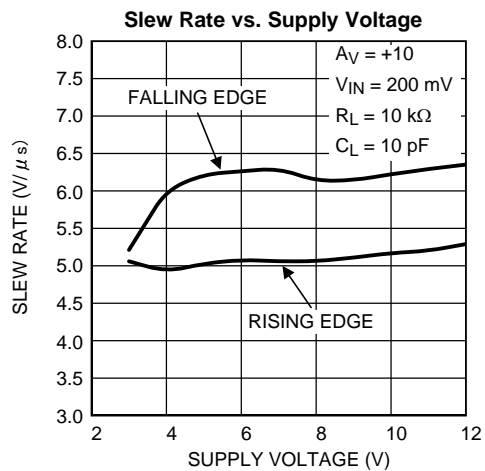

Figure 29.

Typical Performance Characteristics (continued)

Unless otherwise specified, $T_A = 25^\circ\text{C}$, $V_{CM} = V_S/2$, $R_L > 10\text{ k}\Omega$ connected to $(V^+ + V^-)/2$

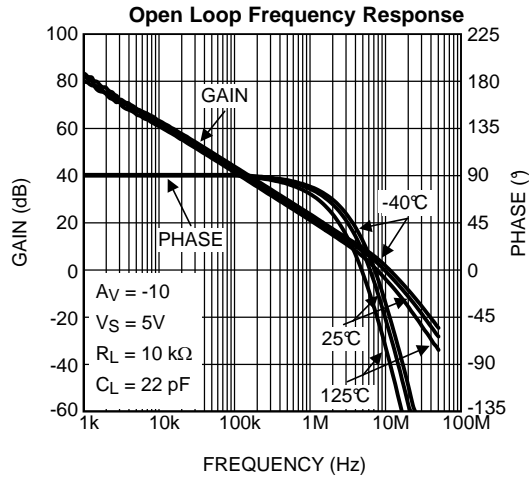

Figure 30.

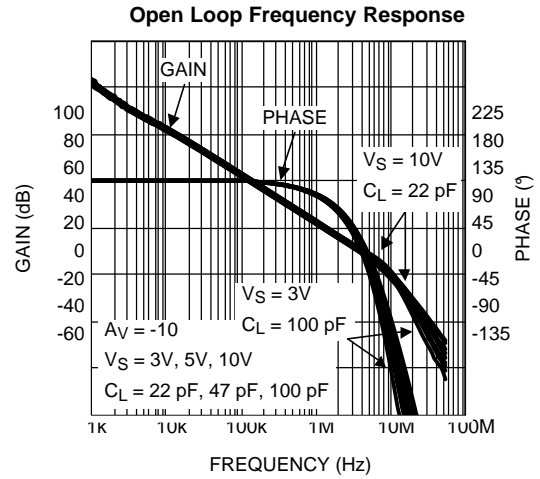

Figure 31.

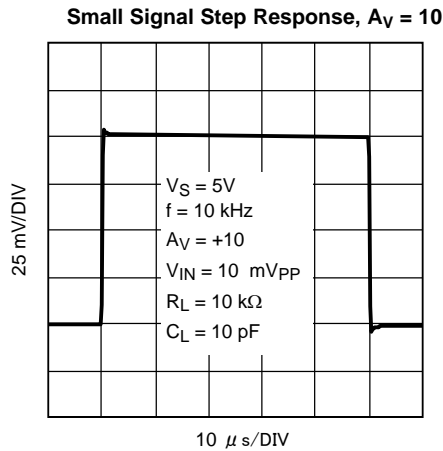

Figure 32.

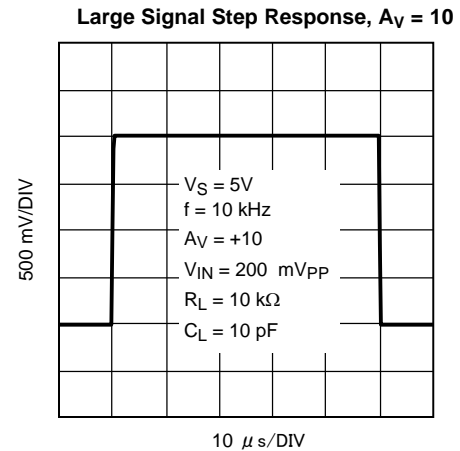

Figure 33.

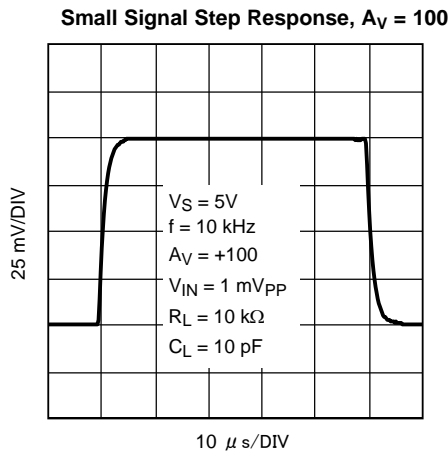

Figure 34.

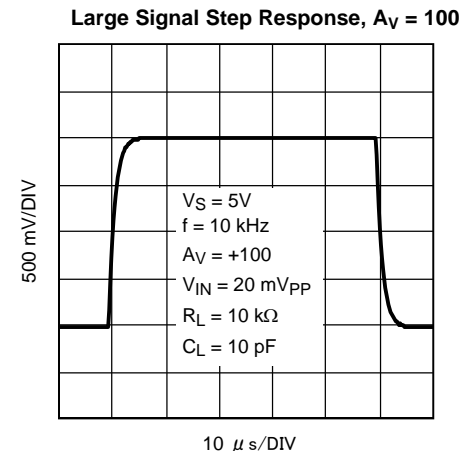

Figure 35.

Typical Performance Characteristics (continued)

Unless otherwise specified, $T_A = 25^\circ\text{C}$, $V_{CM} = V_S/2$, $R_L > 10\text{ k}\Omega$ connected to $(V^+ + V^-)/2$

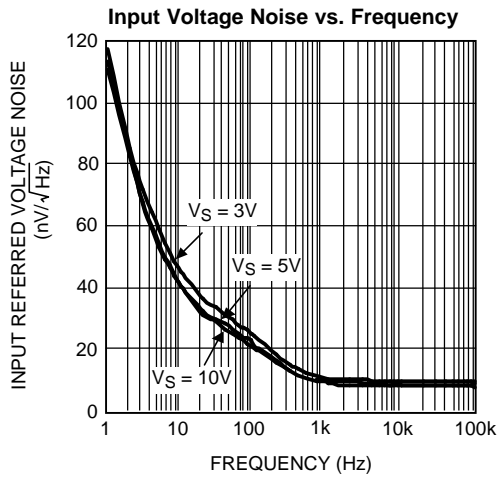

Figure 36.

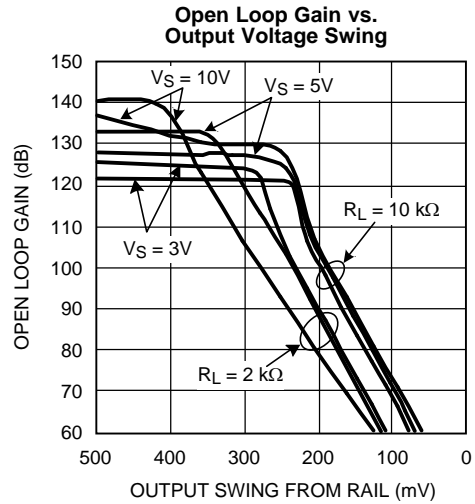

Figure 37.

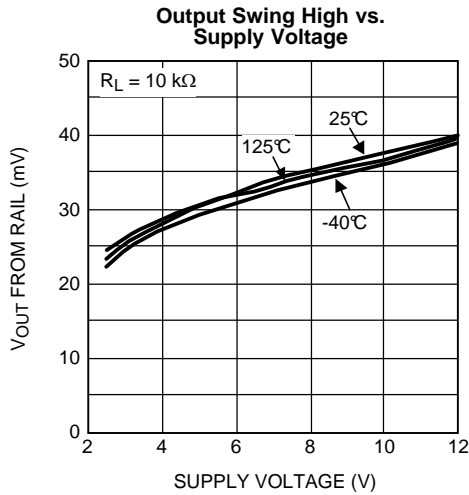

Figure 38.

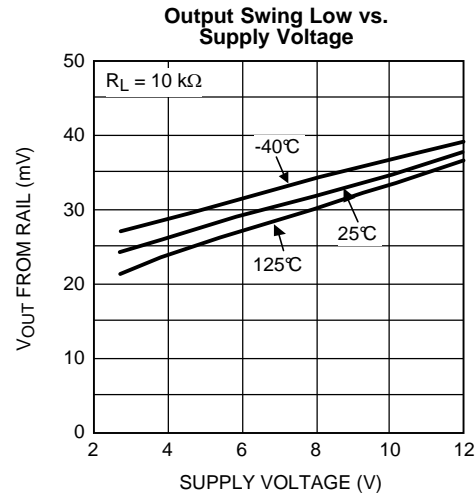

Figure 39.

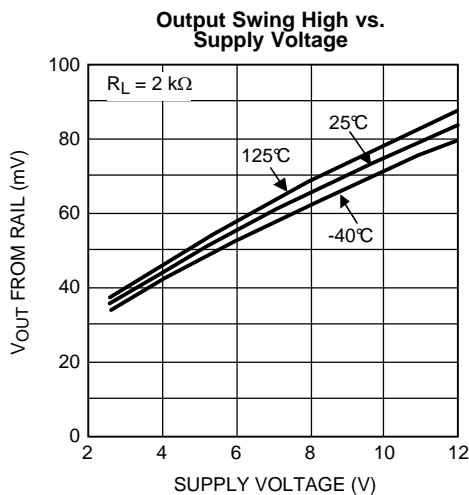

Figure 40.

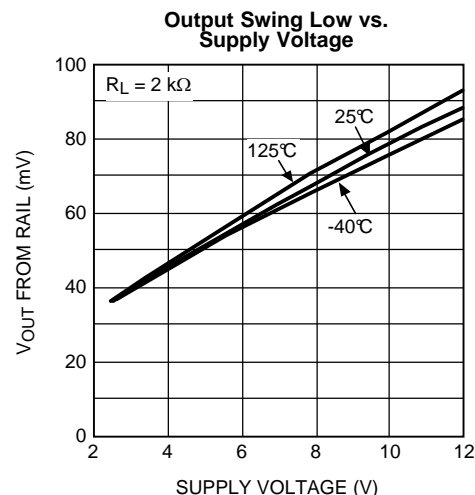

Figure 41.

Typical Performance Characteristics (continued)

Unless otherwise specified, $T_A = 25^\circ\text{C}$, $V_{CM} = V_S/2$, $R_L > 10\text{ k}\Omega$ connected to $(V^+ + V^-)/2$

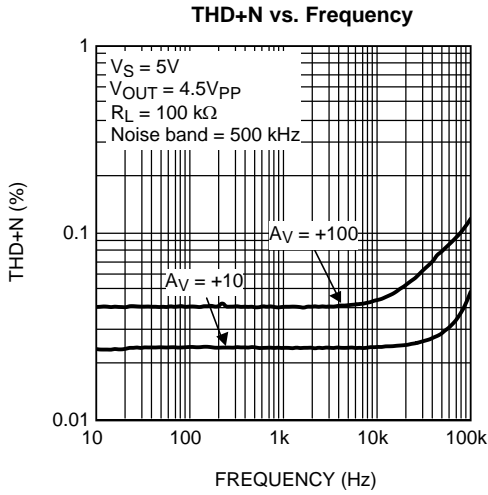

Figure 42.

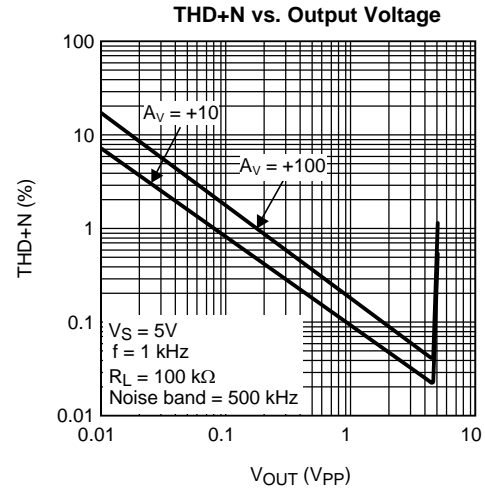

Figure 43.

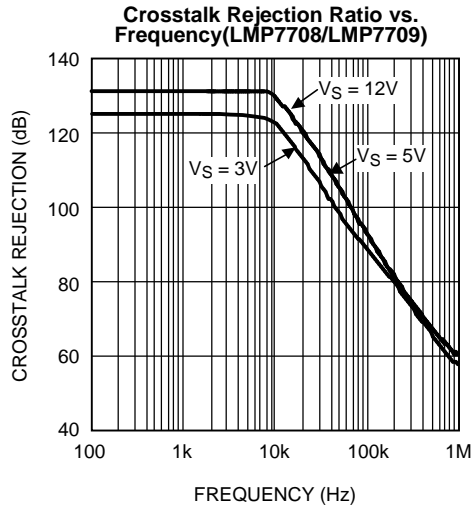

Figure 44.

APPLICATION INFORMATION

LMP7707/LMP7708/LMP7709

The LMP7707/LMP7708/LMP7709 devices are single, dual and quad low offset voltage, rail-to-rail input and output precision amplifiers each with a CMOS input stage and the wide supply voltage range of 2.7V to 12V. The LMP7707/LMP7708/LMP7709 have a very low input bias current of only ± 200 fA at room temperature.

The wide supply voltage range of 2.7V to 12V over the extensive temperature range of -40°C to 125°C makes either the LMP7707, LMP7708 or LMP7709 an excellent choice for low voltage precision applications with extensive temperature requirements.

The LMP7707/LMP7708/LMP7709 have only ± 37 μV of typical input referred offset voltage and this offset is ensured to be less than ± 500 μV for the single and ± 520 μV for the dual and quad over temperature. This minimal offset voltage allows more accurate signal detection and amplification in precision applications.

The low input bias current of only ± 200 fA along with the low input referred voltage noise of $9\text{ nV}/\sqrt{\text{Hz}}$ give the LMP7707/LMP7708/LMP7709 superior qualities for use in sensor applications. Lower levels of noise introduced by the amplifier mean better signal fidelity and a higher signal-to-noise ratio.

The LMP7707/LMP7708/LMP7709 are stable for a gain of 6 or higher. With proper compensation though, the LMP7707, LMP7708 or LMP7709 can be operational at a gain of ± 1 and still maintain much faster slew rates than comparable fully compensated amplifiers. The increase in bandwidth and slew rate is obtained without any additional power consumption.

Texas Instruments is heavily committed to precision amplifiers and the market segment they serve. Technical support and extensive characterization data is available for sensitive applications or applications with a constrained error budget.

The LMP7707 is offered in the space-saving 5-pin SOT-23 and 8-pin SOIC packages, the LMP7708 comes in the 8-pin VSSOP and 8-pin SOIC packages, and the LMP7709 is offered in the 14-pin TSSOP and 14-pin SOIC packages. These small packages are ideal solutions for area constrained PC boards and portable electronics.

CAPACITIVE LOAD

The LMP7707/LMP7708/LMP7709 devices can each be connected as a non-inverting voltage follower. This configuration is the most sensitive to capacitive loading.

The combination of a capacitive load placed on the output of an amplifier along with the amplifier's output impedance creates a phase lag which in turn reduces the phase margin of the amplifier. If the phase margin is significantly reduced, the response will be either underdamped or it will oscillate.

In order to drive heavier capacitive loads, an isolation resistor, R_{ISO} , as shown in the circuit in [Figure 45](#) should be used. By using this isolation resistor, the capacitive load is isolated from the amplifier's output, and hence, the pole caused by C_L is no longer in the feedback loop. The larger the value of R_{ISO} , the more stable the output voltage will be. If values of R_{ISO} are sufficiently large, the feedback loop will be stable, independent of the value of C_L . However, larger values of R_{ISO} result in reduced output swing and reduced output current drive.

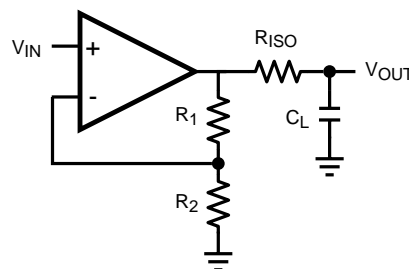

Figure 45. Isolating Capacitive Load

INPUT CAPACITANCE

CMOS input stages inherently have low input bias current and higher input referred voltage noise. The LMP7707/LMP7708/LMP7709 enhances this performance by having the low input bias current of only ± 200 fA, as well as a very low input referred voltage noise of $9 \text{ nV}/\sqrt{\text{Hz}}$. In order to achieve this a large input stage has been used. This large input stage increases the input capacitance of the LMP7707/LMP7708/LMP7709. The typical value of this input capacitance, C_{IN} , for the LMP7707/LMP7708/LMP7709 is 25 pF . The input capacitance will interact with other impedances such as gain and feedback resistors, which are seen on the inputs of the amplifier, to form a pole. This pole will have little or no effect on the output of the amplifier at low frequencies and DC conditions, but will play a bigger role as the frequency increases. At higher frequencies, the presence of this pole will decrease phase margin and will also cause gain peaking. In order to compensate for the input capacitance, care must be taken in choosing the feedback resistors. In addition to being selective in picking values for the feedback resistor, a capacitor can be added to the feedback path to increase stability.

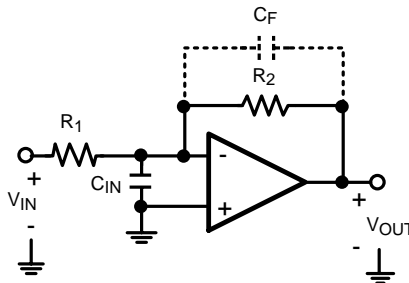

Figure 46. Compensating for Input Capacitance

Using this compensation method will have an impact on the high frequency gain of the op amp, due to the frequency dependent feedback of this amplifier. Low gain settings can, again, introduce instability issues.

DIODES BETWEEN THE INPUTS

The LMP7707/LMP7708/LMP7709 have a set of anti-parallel diodes between the input pins, as shown in Figure 47. These diodes are present to protect the input stage of the amplifier. At the same time, they limit the amount of differential input voltage that is allowed on the input pins. A differential signal larger than one diode voltage drop might damage the diodes. The differential signal between the inputs needs to be limited to $\pm 300 \text{ mV}$ or the input current needs to be limited to $\pm 10 \text{ mA}$. Exceeding these limits will damage the part.

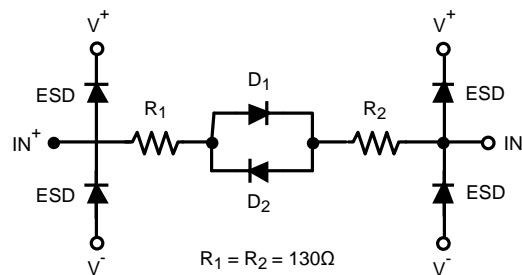

Figure 47. Input of the LMP7707

TOTAL NOISE CONTRIBUTION

The LMP7707/LMP7708/LMP7709 have very low input bias current, very low input current noise and very low input voltage noise. As a result, these amplifiers are ideal choices for circuits with high impedance sensor applications.

Figure 48 shows the typical input noise of the LMP7707/LMP7708/LMP7709 as a function of source resistance. The total noise at the input can be calculated using Equation 1.

$$e_{ni} = \sqrt{e_n^2 + e_i^2 + e_t^2}$$

where

- e_{ni} is the total noise on the input
 - e_n denotes the input referred voltage noise
 - e_i is the voltage drop across source resistance due to input referred current noise or $e_i = R_S * i_n$
 - e_t is the thermal noise of the source resistance
- (1)

The input current noise of the LMP7707/LMP7708/LMP7709 is so low that it will not become the dominant factor in the total noise unless source resistance exceeds 300 M Ω , which is an unrealistically high value.

As is evident in [Figure 48](#), at lower R_S values, the total noise is dominated by the amplifier's input voltage noise. Once R_S is larger than a few kilo-Ohms, then the dominant noise factor becomes the thermal noise of R_S . As mentioned before, the current noise will not be the dominant noise factor for any practical application.

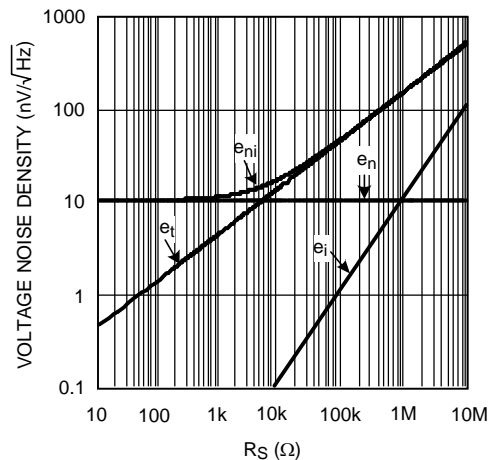

Figure 48. Total Input Noise

HIGH IMPEDANCE SENSOR INTERFACE

Many sensors have high source impedances that may range up to 10 M Ω . The output signal of sensors often needs to be amplified or otherwise conditioned by means of an amplifier. The input bias current of this amplifier can load the sensor's output and cause a voltage drop across the source resistance as shown in [Figure 49](#), where $V_{IN} = V_S - I_{BIAS} * R_S$

The last term, $I_{BIAS} * R_S$, shows the voltage drop across R_S . To prevent errors introduced to the system due to this voltage, an op amp with very low input bias current must be used with high impedance sensors. This is to keep the error contribution by $I_{BIAS} * R_S$ less than the input voltage noise of the amplifier, so that it will not become the dominant noise factor. The LMP7707/LMP7708/LMP7709 have very low input bias current, typically 200 fA.

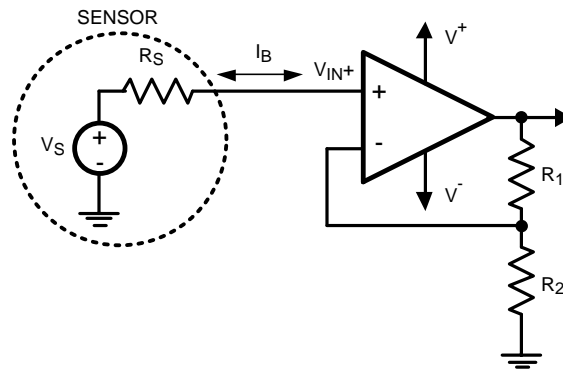

Figure 49. Noise Due to I_{BIAS}

USAGE OF DECOMPENSATED AMPLIFIERS

This section discusses the differences between compensated and decompensated op amps and presents the advantages of decompensated amplifiers. In high gain applications decompensated amplifiers can be used without any changes compared to standard amplifiers. However, for low gain applications special frequency compensation measures have to be taken to ensure stability.

Feedback circuit theory is discussed in detail, in particular as it applies to decompensated amplifiers. Bode plots are presented for a graphical explanation of stability analysis. Two solutions are given for creating a feedback network for decompensated amplifiers when relatively low gains are required: A simple resistive feedback network and a more advanced frequency dependent feedback network with improved noise performance. Finally, a design example is presented resulting in a practical application. The results are compared to fully compensated amplifiers (Texas Instruments LMP7701/LMP7702/LMP7704).

COMPENSATED AMPLIFIERS

A (fully) compensated op amp is designed to operate with good stability down to gains of ± 1 . For this reason, the compensated op amp is also called a unity gain stable op amp.

Figure 50 shows the Open Loop Response of a compensated amplifier.

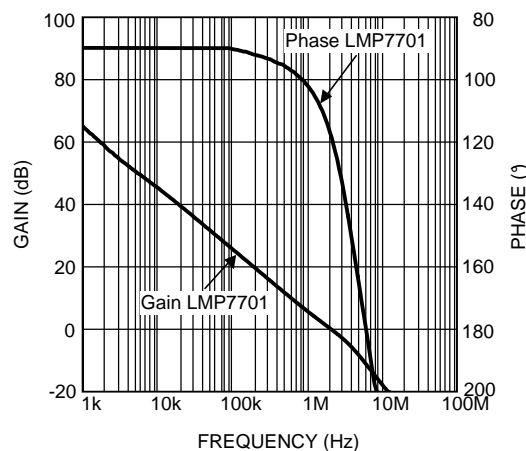

Figure 50. Open Loop Frequency Response Compensated Amplifier (LMP7701)

This amplifier is unity gain stable, because the phase shift is still $< 180^\circ$, when the gain crosses 0 dB (unity gain).

Stability can be expressed in two different ways:

Phase Margin This is the phase difference between the actual phase shift and 180°, at the point where the gain is 0 dB.

Gain Margin This is the gain difference relative to 0 dB, at the frequency where the phase shift crosses the 180°.

The amplifier is supposed to be used with negative feedback but a phase shift of 180° will turn the negative feedback into positive feedback, resulting in oscillations. A phase shift of 180° is not a problem when the gain is smaller than 0 dB, so the critical point for stability is 180° phase shift at 0 dB gain. The gain margin and phase margin express the margin enhancing overall stability between the amplifiers response and this critical point.

DECOMPENSATED AMPLIFIERS

Decompensated amplifiers, such as the LMP7707/LMP7708/LMP7709, are designed to maximize the bandwidth and slew rate without any additional power consumption over the unity gain stable op amp. That is, a decompensated op amp has a higher bandwidth to power ratio than an equivalent compensated op amp. Compared with the unity gain stable amplifier, the decompensated version has the following advantages:

1. A wider closed loop bandwidth
2. Better slew rate due to reduced compensation capacitance within the op amp
3. Better Full Power Bandwidth, given with [Equation 2](#)

$$FPBW = \frac{SR}{2\pi V_P} \quad (2)$$

[Figure 51](#) shows the frequency response of the decompensated amplifier.

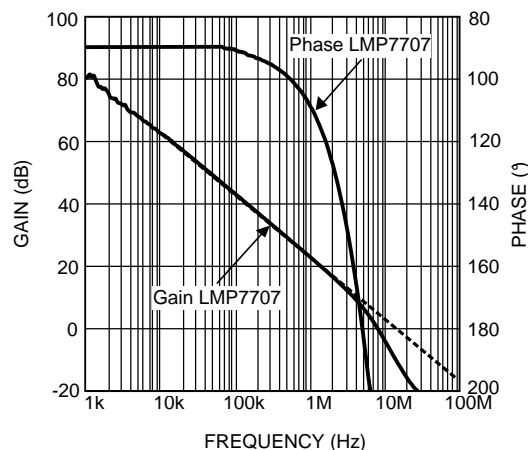

Figure 51. Open Loop Frequency Response Decompensated Amplifier (LMP7707)

As shown in [Figure 51](#), the reduced internal compensation moves the first pole to higher frequencies. The second open loop pole for the LMP7707/LMP7708/LMP7709 occurs at 4 MHz. The extrapolated unity gain (see dashed line in [Figure 51](#)) occurs at 14 MHz. An ideal two pole system would give a phase margin of > 45° at the location of the second pole. Unfortunately, the LMP7707/LMP7708/LMP7709 have parasitic poles close to the second pole, giving a phase margin closer to 0°. The LMP7707/LMP7708/LMP7709 can be used at frequencies where the phase margin is > 45°. The frequency where the phase margin is 45° is at 2.4 MHz. The corresponding value of the open loop gain (also called G_{MIN}) is 6 times.

Stability has only to do with the loop gain and not with the forward gain (G) of the op amp. For high gains, the feedback network is attenuating and this reduces the loop gain; therefore the op amp will be stable for $G > G_{MIN}$ and no special measures are required. For low gains the feedback network attenuation may not be sufficient to ensure loop stability for a decompensated amplifier. However, with an external compensation network decompensated amplifiers can still be made stable while maintaining their advantages over unity gain stable amplifiers.

EXTERNAL COMPENSATION FOR GAINS LOWER THAN G_{MIN} .

This section explains how uncompensated amplifiers can be used in configurations requiring a gain lower than G_{MIN} . In the next sections the concept of the feedback factor is introduced. Subsequently, an explanation is given how stability can be determined using the frequency response curve of the op amp together with the feedback factor. Using the circuit theory, it will be explained how uncompensated amplifiers can be stabilized at lower gains.

FEEDBACK THEORY

Stability issues can be analyzed by verifying the loop gain function GF , where G is the open loop gain of the amplifier and F is the feedback factor of the feedback circuit.

The feedback function (F) of arbitrary electronic circuits, as shown in Figure 52, is defined as the ratio of the input and output signal of the same circuit.

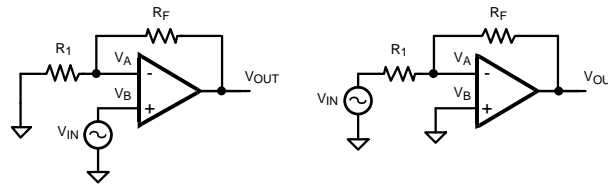

Figure 52. Op Amp with Resistive Feedback. (a) Non-inverting (b) Inverting

The feedback function for a three-terminal op amp as shown in Figure 52 is the feedback voltage $V_A - V_B$ across the op amp input terminals relative to the op amp output voltage, V_{OUT} . That is

$$F = \frac{V_A - V_B}{V_{OUT}} \quad (3)$$

GRAPHICAL EXPLANATION OF STABILITY ANALYSIS

Stability issues can be observed by verifying the closed loop gain function GF . In the frequencies of interest, the open loop gain (G) of the amplifier is a number larger than 1 and therefore positive in dB. The feedback factor (F) of the feedback circuit is an attenuation and therefore negative in dB. For calculating the closed loop gain GF in dB we can add the values of G and F (both in dB).

One practical approach to stabilizing the system, is to assign a value to the feedback factor F such that the remaining loop gain GF equals one (unity gain) at the frequency of G_{MIN} . This realizes a phase margin of 45° or greater. This results in the following requirement for stability: $1/F > G_{MIN}$. The inverse feedback factor $1/F$ is constant over frequency and should intercept the open loop gain at a value in dB that is greater than or equal to G_{MIN} .

The inverse feedback factor for both configurations shown in Figure 52, is given by:

$$\frac{1}{F} = 1 + \frac{R_F}{R_1} \quad (4)$$

The closed loop gain for the non-inverting configuration (a) is:

$$A_{CL} = 1 + \frac{R_F}{R_1} = \frac{1}{F} \quad (5)$$

The closed loop gain for the inverting configuration (b) is:

$$A_{CL} = - \frac{R_F}{R_1} = 1 - \frac{1}{F} \quad (6)$$

For stable operation the phase margin must be equal to or greater than 45° . The corresponding closed loop gain G_{MIN} , for a non-inverting configuration, is

$$|A_{CL}|(\min) = G_{min} \quad (7)$$

For an inverting configuration:

$$|A_{CL}|(\min) = G_{\min} - 1 \quad (8)$$

If R_1 and R_F are chosen so that the closed loop gain is lower than the minimum gain required for stability, then $1/F$ intersects the open loop gain curve for a value that is lower than G_{\min} . For example, assume the G_{\min} is equal to 10 V/V (20 dB). This is shown as the dashed line in Figure 53. The resistor choice of $R_F = R_1 = 2 \text{ k}\Omega$ makes the inverse feedback equal 2 V/V (6 dB), shown in Figure 53 as the solid line. The intercept of G and $1/F$ represents the frequency for which the loop gain is identical to 1 (0 dB). Consequently, the total phase shift at the frequency of this intercept determines the phase margin and the overall system stability. In this system example $1/F$ crosses the open loop gain at a frequency which is larger than the frequency where G_{\min} occurs, therefore this system has less than 45° phase margin and is most likely unstable.

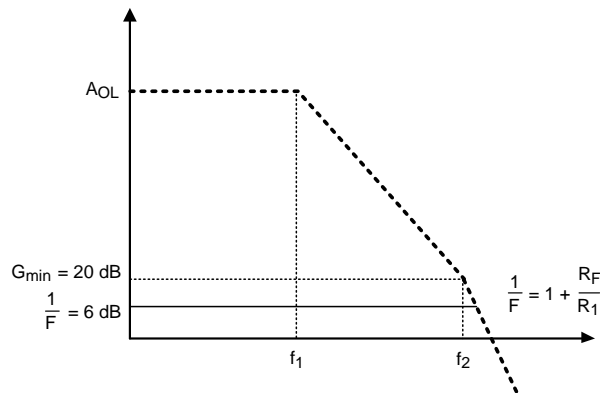

Figure 53. $1/F$ for $R_F = R_1$ and Open Loop Gain Plot

RESISTIVE COMPENSATION

A straightforward way to achieve a stable amplifier configuration is to add a resistor R_C between the inverting and the non-inverting inputs as shown in Figure 54.

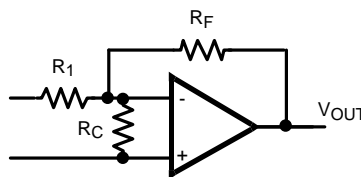

Figure 54. Op Amp with Compensation Resistor between Inputs

This additional resistor R_C will not affect the closed loop gain of the amplifier but it will have positive impact on the feedback network.

The inverse feedback function of this circuit is:

$$\frac{1}{F} = 1 + \frac{R_F}{R_1 // R_C} = 1 + \frac{R_F}{R_1} + \frac{R_F}{R_C} \quad (9)$$

Proper selection of the value of R_C results in the shifting of the $1/F$ function to G_{MIN} or greater, thus fulfilling the condition for circuit stability. The compensation technique of reducing the loop gain may be used to stabilize the circuit for the values given in the previous example, that is $G_{MIN} = 20$ dB and $R_F = R_1 = 2$ k Ω . A resistor value of 250 Ω applied between the amplifier inputs shifts the $1/F$ curve to the value G_{MIN} (20 dB) as shown by the dashed line in Figure 55. This results in overall stability for the circuit. This figure shows a combination of the open and closed loop gain and the inverse feedback function.

This example, represented by Figure 52 and Figure 53, is generic in the sense that the G_{MIN} as specified did not distinguish between inverting and non-inverting configurations.

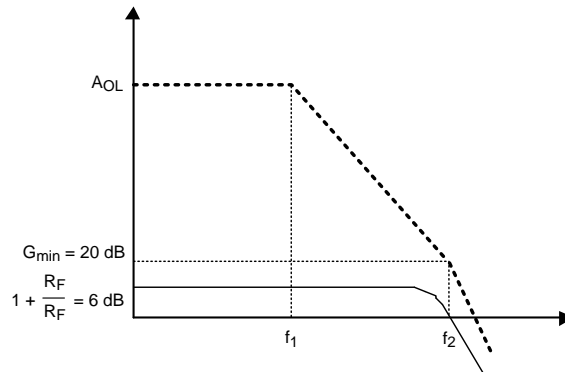

Figure 55. Compensation with Reduced Loop Gain

The technique of reducing loop gain to stabilize a decompensated op amp circuit will be illustrated using the non-inverting input configuration shown in Figure 56.

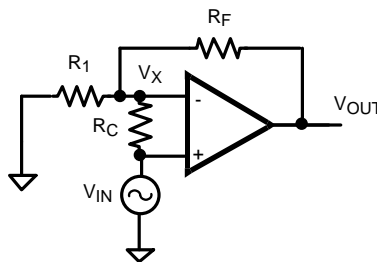

Figure 56. Closed Loop Gain Analysis with R_C

The effect of the choice of resistor R_C in Figure 56 on the closed loop gain can be analyzed in the following manner:

Assume the voltage at the inverting input of the op amp is V_X . Then,

$$(V_{IN} - V_X) G = V_{OUT}$$

where

- G is the open loop gain of the op amp (10)

$$\frac{V_X}{R_1} + \frac{V_X - V_{IN}}{R_C} = \frac{V_{OUT} - V_X}{R_F} \tag{11}$$

Combining Equation 10, Equation 11, and Equation 9 produces the following equation for closed loop gain,

$$\frac{V_{OUT}}{V_{IN}} = \frac{1 + \frac{R_F}{R_1}}{1 + \frac{1}{GF}} \quad (12)$$

By inspection of Equation 12, R_C does not affect the ideal closed loop gain. In this example where $R_F = R_1$, the closed loop gain remains at 6 dB as long as $GF \gg 1$. The closed loop gain curve is shown as the solid line in Figure 55.

The addition of R_C affects the circuit in the following ways:

1. $1/F$ is moved to a higher gain, resulting in overall system stability.

However, adding R_C results in reduced loop gain and increased noise gain. The noise gain is defined as the inverse of the feedback factor, F . The noise gain is the gain from the amplifier input referred noise to the output. In effect, loop gain is traded for stability.

2. The ideal closed loop gain retains the same value as the circuit without the compensation resistor R_C .

LEAD-LAG COMPENSATION

This section presents a more advanced compensation technique that can be used to stabilize amplifiers. The increased noise gain of the prior circuit is prevented by reducing the low frequency attenuation of the feedback circuit. This compensation method is called Lead-Lag compensation. Lead-lag compensation components will be analyzed and a design example using this procedure will be discussed.

The feedback function in a lead-lag compensation circuit is shaped using a resistor and a capacitor. They are chosen in a way that ensures sufficient phase margin.

Figure 57 shows a Bode plot containing: the open loop gain of the decompensated amplifier, a feedback function without compensation and a feedback function with lead-lag compensation.

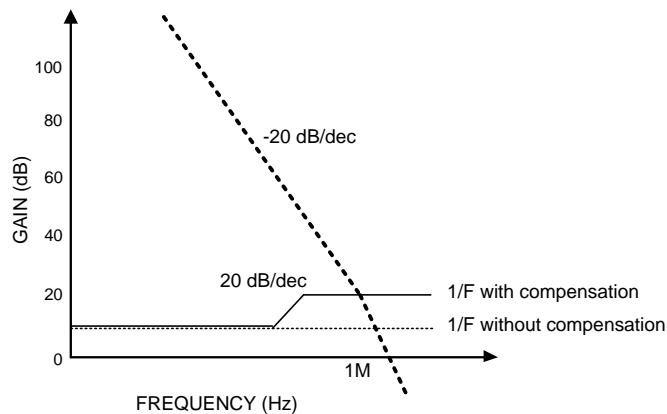

Figure 57. Bode Plot of Open Loop gain G and $1/F$ with and without Lead-Lag Compensation

The shaped feedback function presented in Figure 57 can be realized using the amplifier configuration in Figure 58. Note that resistor R_P is only used for compensation of the input voltage caused by the I_{BIAS} current. R_P can be used to introduce more freedom for calculating the lead-lag components. This will be discussed later in this section.

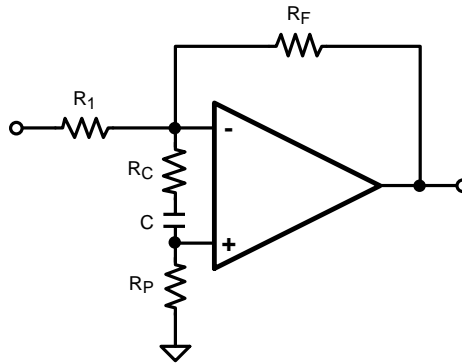

Figure 58. LMP7707 with Lead-Lag Compensation for Inverting Configuration

The inverse feedback factor of the circuit in [Figure 58](#) is:

$$\frac{1}{F} = \left(1 + \frac{R_F}{R_1}\right) \left(\frac{1 + s(R_C + R_1//R_F + R_P)C}{1 + sR_C C}\right) \quad (13)$$

The pole of the inverse feedback function is located at:

$$f_P = \frac{1}{2\pi R_C C} \quad (14)$$

The zero of the inverse feedback function is located at:

$$f_Z = \frac{1}{2\pi(R_C + R_1//R_F + R_P) C} \quad (15)$$

The low frequency inverse feedback factor is given by:

$$\frac{1}{F} \Big|_{f=0} = 1 + \frac{R_F}{R_1} \quad (16)$$

The high frequency inverse feedback factor is given by:

$$\frac{1}{F} \Big|_{f=\infty} = \left(1 + \frac{R_F}{R_1}\right) \left(1 + \frac{R_P + R_1//R_F}{R_C}\right) \quad (17)$$

From these formulas, we can tell that

1. The $1/F$'s zero is located at a lower frequency compared to $1/F$'s pole.
2. The intersection point of $1/F$ and the open loop gain G is determined by the choice of resistor values for R_P and R_C if the values of R_1 and R_F are set before compensation.
3. This procedure results in the creation of a pole-zero pair, the positions of which are interdependent.
4. This pole-zero pair is used to:
 - Raise the $1/F$ value to a greater value in the region immediately to the left of its intercept with the A function in order to meet the G_{min} requirement.
 - Achieve the preceding with no additional loop phase delay.
5. The location of the $1/F$ zero is determined by the following conditions:
 - The value of $1/F$ at low frequency.
 - The value of $1/F$ at the intersection point.
 - The location of $1/F$ pole.

Note that the constraint $1/F \geq G_{\min}$ needs to be satisfied only in the vicinity of the intersection of G and $1/F$; $1/F$ can be shaped elsewhere as needed. Two rules must be satisfied in order to maintain adequate phase margin.

Rule 1 The plot of $1/F$ should intersect with the plot of the open loop gain at a value larger than G_{\min} . At that point, the open loop gain G has a phase margin of 45° .

The location f_2 in [Figure 59](#) illustrates the proper intersection point for the LMP7707/LMP7708/LMP7709 using the circuit of [Figure 58](#). The intersection of G and $1/F$ at the op amp's second pole location is the 45° phase margin reference point.

Rule 2 The $1/F$ pole (see [Figure 59](#)) should be positioned at the frequency that is at least one decade below the intersection point f_2 of $1/F$ and G . This positioning takes full advantage of the 90° of phase lead brought about by the $1/F$ pole. This additional phase lead accompanies the increase in magnitude of $1/F$ observed at frequencies greater than the $1/F$ pole.

The resulting system has approximately 45° of phase margin, based upon the fact that the open loop gain's dominant pole and the second pole are more than one decade apart and that the open loop gain has no other pole within one decade of its intersection point with $1/F$. If there is a third pole in the open loop gain G at a frequency greater than f_2 and if it occurs less than a decade above that frequency, then there will be an effect on phase margin.

DESIGN EXAMPLE

The input lead-lag compensation method can be applied to an application using the LMP7707, LMP7708 or LMP7709 in an inverting configuration, as shown in [Figure 58](#).

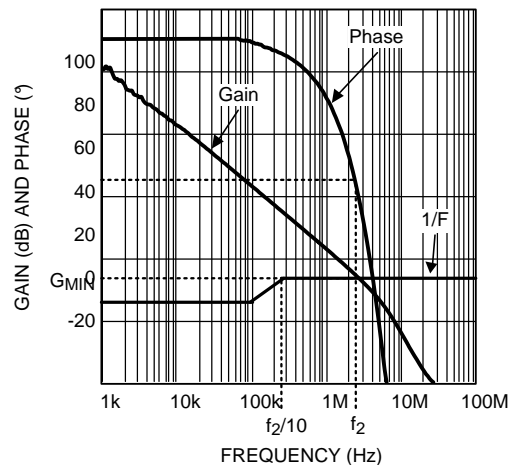

Figure 59. LMP7707 Open Loop Gain and $1/F$ Lead-Lag Feedback Network.

[Figure 59](#) shows that $G_{\min} = 16$ dB and f_2 (intersection point) = 2.4 MHz.

A gain of 6 dB (or a magnitude of -1) is well below the LMP7707's G_{\min} . Without external lead-lag compensation, the inverse feedback factor is found using [Equation 4](#) which applies to both inverting and non-inverting configurations. Unity gain implementation for the inverting configuration means $R_F = R_1$, and $1/F = 2$ (6 dB).

Procedure:

The compensation circuit shown in [Figure 58](#) is implemented. The inverse feedback function is shaped by the solid line in [Figure 59](#). The $1/F$ plot is 6 dB at low frequencies. At higher frequencies, it is made to intersect the loop gain G at frequency f_2 with gain amplitude of 16 dB (G_{\min}), which equals a magnitude of six times. This follows the recommendations in Rule 1. The $1/F$ pole f_p is set one decade below the intersection point ($f_2 = 2.4$ MHz) as given in Rule 2, and results in a frequency $f_p = 240$ kHz. The next steps should be taken to calculate the values of the compensation components:

Step 1) Set $1/F$ equal to G_{\min} using [Equation 17](#). This gives a value for resistor R_C .

Step 2) Set the $1/F$ pole one decade below the intersection point using [Equation 14](#). This gives a value for capacitor C .

This method uses bode plot approximation. Some fine-tuning may be needed to get the best results.

Calculations:

As described in Step 1, use [Equation 17](#):

$$\frac{1}{F} \Big|_{f=\infty} = \left(1 + \frac{R_F}{R_1}\right) \left(1 + \frac{R_P + R_1 // R_F}{R_C}\right) = 6 \text{ V/V} \quad (18)$$

Now substitute $R_F/R_1 = 1$ into the equation above since this is a unity gain, inverting amplifier, then

$$R_P + R_1 // R_F = 2 R_C \quad (19)$$

According to Step 2 use [Equation 14](#):

$$f_P = \frac{1}{2\pi R_C C} = 240 \text{ kHz} \quad (20)$$

which leads to:

$$C = \frac{1}{2\pi f R_C} \quad (21)$$

Choose a value of R_F that is below 2 k Ω , in order to minimize the possibility of shunt capacitance across high value resistors producing a negative effect on high frequency operation. If $R_F = R_1 = 1 \text{ k}\Omega$, then $R_F // R_1 = 500 \Omega$. For simplicity, choose $R_P = 0 \Omega$. The value of R_C is derived from [Equation 19](#) and has a value of $R_C = 250 \Omega$. This is not a standard value. A value of $R_C = 330 \Omega$ is a first choice (using 10% tolerance components).

The value of capacitor C is 2.2 nF. This value is significantly higher than the parasitic capacitances associated with passive components and board layout, and is therefore a good solution.

Bench results:

For bench evaluation the LMP7707 in an inverting configuration has been verified under three different conditions:

- Uncompensated
- Lead-lag compensation resulting in a phase margin of 45°
- Lead lag overcompensation resulting in a phase margin larger than 45°

The calculated components for these three conditions are

Condition	R_C	C
Uncompensated	NA	NA
Compensated	330 Ω	2.2 nF
Overcompensated	240 Ω	3.3 nF

Figure 60 shows the results of the compensation of the LMP7707.

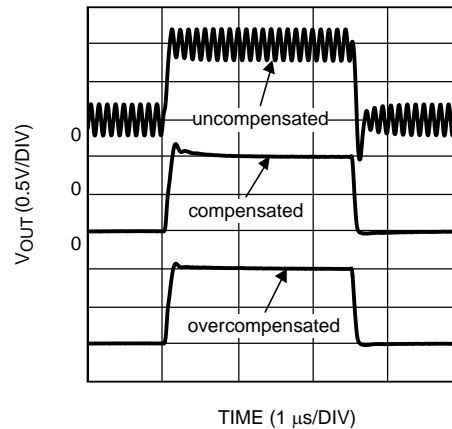

Figure 60. Bench Results for Lead- Lag Compensation

The top waveform shows the output response of a uncompensated LMP7707 using no external compensation components. This trace shows ringing and is unstable (as expected). The middle waveform is the response of a compensated LMP7707 using the compensation components calculated with the described procedure. The response is reasonably well behaved. The bottom waveform shows the response of an overcompensated LMP7707.

Finally, Figure 61 compares the step response of the compensated LMP7707 to that of the unity gain stable LMP7701. The increase in dynamic performance is clear.

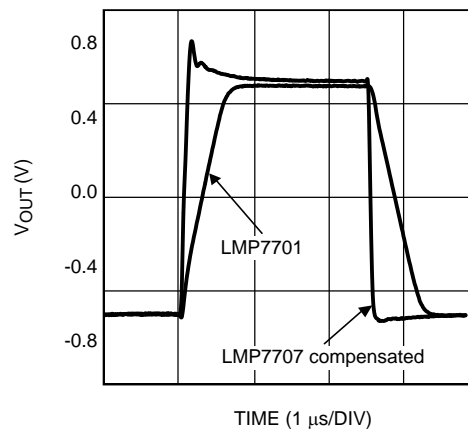

Figure 61. Bench Results for Comparison of LMP7701 and LMP7707

The application of input lead-lag compensation to a decompensated op amp enables the realization of circuit gains of less than the minimum specified by the manufacturer. This is accomplished while retaining the advantageous speed versus power characteristic of decompensated op amps.

REVISION HISTORY

Changes from Revision A (March 2013) to Revision B	Page
• Changed layout of National Data Sheet to TI format	28

PACKAGING INFORMATION

Orderable Device	Status (1)	Package Type	Package Drawing	Pins	Package Qty	Eco Plan (2)	Lead finish/ Ball material (6)	MSL Peak Temp (3)	Op Temp (°C)	Device Marking (4/5)	Samples
LMP7707MA/NOPB	ACTIVE	SOIC	D	8	95	RoHS & Green	SN	Level-1-260C-UNLIM		LMP7707MA	Samples
LMP7707MAX/NOPB	ACTIVE	SOIC	D	8	2500	RoHS & Green	SN	Level-1-260C-UNLIM		LMP7707MA	Samples
LMP7707MF/NOPB	ACTIVE	SOT-23	DBV	5	1000	RoHS & Green	SN	Level-1-260C-UNLIM	-40 to 125	AH4A	Samples
LMP7707MFX/NOPB	ACTIVE	SOT-23	DBV	5	3000	RoHS & Green	SN	Level-1-260C-UNLIM	-40 to 125	AH4A	Samples
LMP7708MA/NOPB	ACTIVE	SOIC	D	8	95	RoHS & Green	SN	Level-1-260C-UNLIM	-40 to 125	LMP7708MA	Samples
LMP7708MAX/NOPB	ACTIVE	SOIC	D	8	2500	RoHS & Green	SN	Level-1-260C-UNLIM	-40 to 125	LMP7708MA	Samples
LMP7708MM/NOPB	ACTIVE	VSSOP	DGK	8	1000	RoHS & Green	SN	Level-1-260C-UNLIM	-40 to 125	AJ4A	Samples
LMP7708MME/NOPB	ACTIVE	VSSOP	DGK	8	250	RoHS & Green	SN	Level-1-260C-UNLIM	-40 to 125	AJ4A	Samples
LMP7708MMX/NOPB	ACTIVE	VSSOP	DGK	8	3500	RoHS & Green	SN	Level-1-260C-UNLIM	-40 to 125	AJ4A	Samples
LMP7709MA/NOPB	ACTIVE	SOIC	D	14	55	RoHS & Green	SN	Level-1-260C-UNLIM		LMP7709MA	Samples
LMP7709MAX/NOPB	ACTIVE	SOIC	D	14	2500	RoHS & Green	SN	Level-1-260C-UNLIM		LMP7709MA	Samples
LMP7709MT/NOPB	ACTIVE	TSSOP	PW	14	94	RoHS & Green	SN	Level-1-260C-UNLIM	-40 to 125	LMP7709MT	Samples
LMP7709MTX/NOPB	ACTIVE	TSSOP	PW	14	2500	RoHS & Green	SN	Level-1-260C-UNLIM	-40 to 125	LMP7709MT	Samples

(1) The marketing status values are defined as follows:

ACTIVE: Product device recommended for new designs.

LIFEBUY: TI has announced that the device will be discontinued, and a lifetime-buy period is in effect.

NRND: Not recommended for new designs. Device is in production to support existing customers, but TI does not recommend using this part in a new design.

PREVIEW: Device has been announced but is not in production. Samples may or may not be available.

OBSELETE: TI has discontinued the production of the device.

(2) **RoHS:** TI defines "RoHS" to mean semiconductor products that are compliant with the current EU RoHS requirements for all 10 RoHS substances, including the requirement that RoHS substance do not exceed 0.1% by weight in homogeneous materials. Where designed to be soldered at high temperatures, "RoHS" products are suitable for use in specified lead-free processes. TI may reference these types of products as "Pb-Free".

RoHS Exempt: TI defines "RoHS Exempt" to mean products that contain lead but are compliant with EU RoHS pursuant to a specific EU RoHS exemption.

Green: TI defines "Green" to mean the content of Chlorine (Cl) and Bromine (Br) based flame retardants meet JS709B low halogen requirements of ≤ 1000 ppm threshold. Antimony trioxide based flame retardants must also meet the ≤ 1000 ppm threshold requirement.

(3) MSL, Peak Temp. - The Moisture Sensitivity Level rating according to the JEDEC industry standard classifications, and peak solder temperature.

(4) There may be additional marking, which relates to the logo, the lot trace code information, or the environmental category on the device.

(5) Multiple Device Markings will be inside parentheses. Only one Device Marking contained in parentheses and separated by a "~" will appear on a device. If a line is indented then it is a continuation of the previous line and the two combined represent the entire Device Marking for that device.

(6) Lead finish/Ball material - Orderable Devices may have multiple material finish options. Finish options are separated by a vertical ruled line. Lead finish/Ball material values may wrap to two lines if the finish value exceeds the maximum column width.

Important Information and Disclaimer: The information provided on this page represents TI's knowledge and belief as of the date that it is provided. TI bases its knowledge and belief on information provided by third parties, and makes no representation or warranty as to the accuracy of such information. Efforts are underway to better integrate information from third parties. TI has taken and continues to take reasonable steps to provide representative and accurate information but may not have conducted destructive testing or chemical analysis on incoming materials and chemicals. TI and TI suppliers consider certain information to be proprietary, and thus CAS numbers and other limited information may not be available for release.

In no event shall TI's liability arising out of such information exceed the total purchase price of the TI part(s) at issue in this document sold by TI to Customer on an annual basis.

TAPE AND REEL INFORMATION

QUADRANT ASSIGNMENTS FOR PIN 1 ORIENTATION IN TAPE

*All dimensions are nominal

Device	Package Type	Package Drawing	Pins	SPQ	Reel Diameter (mm)	Reel Width W1 (mm)	A0 (mm)	B0 (mm)	K0 (mm)	P1 (mm)	W (mm)	Pin1 Quadrant
LMP7707MAX/NOPB	SOIC	D	8	2500	330.0	12.4	6.5	5.4	2.0	8.0	12.0	Q1
LMP7707MF/NOPB	SOT-23	DBV	5	1000	178.0	8.4	3.2	3.2	1.4	4.0	8.0	Q3
LMP7707MFX/NOPB	SOT-23	DBV	5	3000	178.0	8.4	3.2	3.2	1.4	4.0	8.0	Q3
LMP7708MAX/NOPB	SOIC	D	8	2500	330.0	12.4	6.5	5.4	2.0	8.0	12.0	Q1
LMP7708MM/NOPB	VSSOP	DGK	8	1000	178.0	12.4	5.3	3.4	1.4	8.0	12.0	Q1
LMP7708MME/NOPB	VSSOP	DGK	8	250	178.0	12.4	5.3	3.4	1.4	8.0	12.0	Q1
LMP7708MMX/NOPB	VSSOP	DGK	8	3500	330.0	12.4	5.3	3.4	1.4	8.0	12.0	Q1
LMP7709MAX/NOPB	SOIC	D	14	2500	330.0	16.4	6.5	9.35	2.3	8.0	16.0	Q1
LMP7709MTX/NOPB	TSSOP	PW	14	2500	330.0	12.4	6.95	5.6	1.6	8.0	12.0	Q1

TAPE AND REEL BOX DIMENSIONS

*All dimensions are nominal

Device	Package Type	Package Drawing	Pins	SPQ	Length (mm)	Width (mm)	Height (mm)
LMP7707MAX/NOPB	SOIC	D	8	2500	356.0	356.0	35.0
LMP7707MF/NOPB	SOT-23	DBV	5	1000	208.0	191.0	35.0
LMP7707MFX/NOPB	SOT-23	DBV	5	3000	208.0	191.0	35.0
LMP7708MAX/NOPB	SOIC	D	8	2500	356.0	356.0	35.0
LMP7708MM/NOPB	VSSOP	DGK	8	1000	208.0	191.0	35.0
LMP7708MME/NOPB	VSSOP	DGK	8	250	208.0	191.0	35.0
LMP7708MMX/NOPB	VSSOP	DGK	8	3500	356.0	356.0	35.0
LMP7709MAX/NOPB	SOIC	D	14	2500	356.0	356.0	35.0
LMP7709MTX/NOPB	TSSOP	PW	14	2500	356.0	356.0	35.0

TUBE

*All dimensions are nominal

Device	Package Name	Package Type	Pins	SPQ	L (mm)	W (mm)	T (μm)	B (mm)
LMP7707MA/NOPB	D	SOIC	8	95	495	8	4064	3.05
LMP7708MA/NOPB	D	SOIC	8	95	495	8	4064	3.05
LMP7709MA/NOPB	D	SOIC	14	55	495	8	4064	3.05
LMP7709MT/NOPB	PW	TSSOP	14	94	495	8	2514.6	4.06

EXAMPLE BOARD LAYOUT

DBV0005A

SOT-23 - 1.45 mm max height

SMALL OUTLINE TRANSISTOR



LAND PATTERN EXAMPLE
EXPOSED METAL SHOWN
SCALE:15X



SOLDER MASK DETAILS

4214839/K 08/2024

NOTES: (continued)

- 6. Publication IPC-7351 may have alternate designs.
- 7. Solder mask tolerances between and around signal pads can vary based on board fabrication site.

EXAMPLE STENCIL DESIGN

DBV0005A

SOT-23 - 1.45 mm max height

SMALL OUTLINE TRANSISTOR



SOLDER PASTE EXAMPLE
BASED ON 0.125 mm THICK STENCIL
SCALE:15X

4214839/K 08/2024

NOTES: (continued)

8. Laser cutting apertures with trapezoidal walls and rounded corners may offer better paste release. IPC-7525 may have alternate design recommendations.
9. Board assembly site may have different recommendations for stencil design.

DGK0008A



PACKAGE OUTLINE

VSSOP - 1.1 mm max height

SMALL OUTLINE PACKAGE



4214862/A 04/2023

NOTES:

PowerPAD is a trademark of Texas Instruments.

1. All linear dimensions are in millimeters. Any dimensions in parenthesis are for reference only. Dimensioning and tolerancing per ASME Y14.5M.
2. This drawing is subject to change without notice.
3. This dimension does not include mold flash, protrusions, or gate burrs. Mold flash, protrusions, or gate burrs shall not exceed 0.15 mm per side.
4. This dimension does not include interlead flash. Interlead flash shall not exceed 0.25 mm per side.
5. Reference JEDEC registration MO-187.

EXAMPLE BOARD LAYOUT

DGK0008A

™ VSSOP - 1.1 mm max height

SMALL OUTLINE PACKAGE



LAND PATTERN EXAMPLE
EXPOSED METAL SHOWN
SCALE: 15X



SOLDER MASK DETAILS

4214862/A 04/2023

NOTES: (continued)

6. Publication IPC-7351 may have alternate designs.
7. Solder mask tolerances between and around signal pads can vary based on board fabrication site.
8. Vias are optional depending on application, refer to device data sheet. If any vias are implemented, refer to their locations shown on this view. It is recommended that vias under paste be filled, plugged or tented.
9. Size of metal pad may vary due to creepage requirement.

EXAMPLE STENCIL DESIGN

DGK0008A

™ VSSOP - 1.1 mm max height

SMALL OUTLINE PACKAGE



SOLDER PASTE EXAMPLE
SCALE: 15X

4214862/A 04/2023

NOTES: (continued)

11. Laser cutting apertures with trapezoidal walls and rounded corners may offer better paste release. IPC-7525 may have alternate design recommendations.
12. Board assembly site may have different recommendations for stencil design.



D0014A

PACKAGE OUTLINE

SOIC - 1.75 mm max height

SMALL OUTLINE INTEGRATED CIRCUIT



4220718/A 09/2016

NOTES:

1. All linear dimensions are in millimeters. Dimensions in parenthesis are for reference only. Dimensioning and tolerancing per ASME Y14.5M.
2. This drawing is subject to change without notice.
3. This dimension does not include mold flash, protrusions, or gate burrs. Mold flash, protrusions, or gate burrs shall not exceed 0.15 mm, per side.
4. This dimension does not include interlead flash. Interlead flash shall not exceed 0.43 mm, per side.
5. Reference JEDEC registration MS-012, variation AB.

EXAMPLE BOARD LAYOUT

D0014A

SOIC - 1.75 mm max height

SMALL OUTLINE INTEGRATED CIRCUIT



LAND PATTERN EXAMPLE
SCALE:8X



SOLDER MASK DETAILS

4220718/A 09/2016

NOTES: (continued)

- 6. Publication IPC-7351 may have alternate designs.
- 7. Solder mask tolerances between and around signal pads can vary based on board fabrication site.

EXAMPLE STENCIL DESIGN

D0014A

SOIC - 1.75 mm max height

SMALL OUTLINE INTEGRATED CIRCUIT



SOLDER PASTE EXAMPLE
BASED ON 0.125 mm THICK STENCIL
SCALE:8X

4220718/A 09/2016

NOTES: (continued)

8. Laser cutting apertures with trapezoidal walls and rounded corners may offer better paste release. IPC-7525 may have alternate design recommendations.
9. Board assembly site may have different recommendations for stencil design.



D0008A

PACKAGE OUTLINE

SOIC - 1.75 mm max height

SMALL OUTLINE INTEGRATED CIRCUIT



4214825/C 02/2019

NOTES:

- Linear dimensions are in inches [millimeters]. Dimensions in parenthesis are for reference only. Controlling dimensions are in inches. Dimensioning and tolerancing per ASME Y14.5M.
- This drawing is subject to change without notice.
- This dimension does not include mold flash, protrusions, or gate burrs. Mold flash, protrusions, or gate burrs shall not exceed $.006$ [0.15] per side.
- This dimension does not include interlead flash.
- Reference JEDEC registration MS-012, variation AA.

EXAMPLE BOARD LAYOUT

D0008A

SOIC - 1.75 mm max height

SMALL OUTLINE INTEGRATED CIRCUIT



LAND PATTERN EXAMPLE
EXPOSED METAL SHOWN
SCALE:8X



SOLDER MASK DETAILS

4214825/C 02/2019

NOTES: (continued)

- 6. Publication IPC-7351 may have alternate designs.
- 7. Solder mask tolerances between and around signal pads can vary based on board fabrication site.

EXAMPLE STENCIL DESIGN

D0008A

SOIC - 1.75 mm max height

SMALL OUTLINE INTEGRATED CIRCUIT



SOLDER PASTE EXAMPLE
BASED ON .005 INCH [0.125 MM] THICK STENCIL
SCALE:8X

4214825/C 02/2019

NOTES: (continued)

8. Laser cutting apertures with trapezoidal walls and rounded corners may offer better paste release. IPC-7525 may have alternate design recommendations.
9. Board assembly site may have different recommendations for stencil design.

PW0014A



PACKAGE OUTLINE
TSSOP - 1.2 mm max height

SMALL OUTLINE PACKAGE



4220202/B 12/2023

NOTES:

1. All linear dimensions are in millimeters. Any dimensions in parenthesis are for reference only. Dimensioning and tolerancing per ASME Y14.5M.
2. This drawing is subject to change without notice.
3. This dimension does not include mold flash, protrusions, or gate burrs. Mold flash, protrusions, or gate burrs shall not exceed 0.15 mm per side.
4. This dimension does not include interlead flash. Interlead flash shall not exceed 0.25 mm per side.
5. Reference JEDEC registration MO-153.

EXAMPLE BOARD LAYOUT

PW0014A

TSSOP - 1.2 mm max height

SMALL OUTLINE PACKAGE



LAND PATTERN EXAMPLE
EXPOSED METAL SHOWN
SCALE: 10X



4220202/B 12/2023

NOTES: (continued)

- 6. Publication IPC-7351 may have alternate designs.
- 7. Solder mask tolerances between and around signal pads can vary based on board fabrication site.

EXAMPLE STENCIL DESIGN

PW0014A

TSSOP - 1.2 mm max height

SMALL OUTLINE PACKAGE



SOLDER PASTE EXAMPLE
BASED ON 0.125 mm THICK STENCIL
SCALE: 10X

4220202/B 12/2023

NOTES: (continued)

8. Laser cutting apertures with trapezoidal walls and rounded corners may offer better paste release. IPC-7525 may have alternate design recommendations.
9. Board assembly site may have different recommendations for stencil design.

IMPORTANT NOTICE AND DISCLAIMER

TI PROVIDES TECHNICAL AND RELIABILITY DATA (INCLUDING DATA SHEETS), DESIGN RESOURCES (INCLUDING REFERENCE DESIGNS), APPLICATION OR OTHER DESIGN ADVICE, WEB TOOLS, SAFETY INFORMATION, AND OTHER RESOURCES "AS IS" AND WITH ALL FAULTS, AND DISCLAIMS ALL WARRANTIES, EXPRESS AND IMPLIED, INCLUDING WITHOUT LIMITATION ANY IMPLIED WARRANTIES OF MERCHANTABILITY, FITNESS FOR A PARTICULAR PURPOSE OR NON-INFRINGEMENT OF THIRD PARTY INTELLECTUAL PROPERTY RIGHTS.

These resources are intended for skilled developers designing with TI products. You are solely responsible for (1) selecting the appropriate TI products for your application, (2) designing, validating and testing your application, and (3) ensuring your application meets applicable standards, and any other safety, security, regulatory or other requirements.

These resources are subject to change without notice. TI grants you permission to use these resources only for development of an application that uses the TI products described in the resource. Other reproduction and display of these resources is prohibited. No license is granted to any other TI intellectual property right or to any third party intellectual property right. TI disclaims responsibility for, and you will fully indemnify TI and its representatives against, any claims, damages, costs, losses, and liabilities arising out of your use of these resources.

TI's products are provided subject to [TI's Terms of Sale](#) or other applicable terms available either on [ti.com](https://www.ti.com) or provided in conjunction with such TI products. TI's provision of these resources does not expand or otherwise alter TI's applicable warranties or warranty disclaimers for TI products.

TI objects to and rejects any additional or different terms you may have proposed.

Mailing Address: Texas Instruments, Post Office Box 655303, Dallas, Texas 75265
Copyright © 2024, Texas Instruments Incorporated