

OPA810 140-MHz, Rail-to-Rail Input and Output, FET-Input Operational Amplifier

1 Features

- Gain-Bandwidth Product: 70 MHz
- Small-Signal Bandwidth: 140 MHz
- Slew Rate: 200 V/ μ s
- Wide Supply Range: 4.75 V to 27 V
- Low Noise:
 - Input Voltage Noise: 6.3 nV/ $\sqrt{\text{Hz}}$ (f = 500 kHz)
 - Input Current Noise: 5 fA/ $\sqrt{\text{Hz}}$ (f = 10 kHz)
- Rail-to-Rail Input and Output:
 - FET Input Stage: 2-pA Input Bias Current (Typical)
 - High Linear Output Current: 75 mA
- Input Offset: ± 500 μ V (Maximum)
- Offset Drift: ± 2.5 μ V/ $^{\circ}$ C (Typical)
- Low Power: 3.7 mA/Channel
- Extended Temperature Operation: -40° C to $+125^{\circ}$ C
- Dual-Channel Version: [OPA2810](#)

2 Applications

- [Wideband Photodiode Transimpedance Amplifiers](#)
- [Analog Input and Output Modules](#)
- [Impedance Measurements](#)
- [Power Analyzers and Meters](#)
- [High-Z Voltage and Current Measurements](#)
- [Data Acquisition](#)
- [Multichannel Sensor Interfaces](#)
- [Optoelectronic Drivers](#)

3 Description

The OPA810 is a single-channel, field-effect transistor (FET)-input, voltage-feedback operational amplifier with bias current in the picoampere (pA) range. The OPA810 is unity-gain stable with a small-signal, unity-gain bandwidth of 140 MHz, and offers excellent DC precision and dynamic AC performance at a low quiescent current (I_Q) of 3.7 mA per channel. The OPA810 is fabricated on Texas Instrument's proprietary, high-speed SiGe BiCMOS process and achieves significant performance improvements over comparable FET-input amplifiers at similar levels of quiescent power. With a gain-bandwidth product (GBWP) of 70 MHz, slew rate of 200 V/ μ s, and low-noise voltage of 6.3 nV/ $\sqrt{\text{Hz}}$, the OPA810 is well suited for use in a wide range of high-fidelity data acquisition and signal processing applications.

The OPA810 features rail-to-rail inputs and outputs and delivers 75 mA of linear output current, suitable for driving optoelectronics components and analog-to-digital converter (ADC) inputs or buffering digital-to-analog converter (DAC) outputs into heavy loads.

The OPA810 is rated over the extended industrial temperature range of -40° C to $+125^{\circ}$ C. The [OPA2810](#) is a dual-channel variant of this device, available in 8-pin SOIC, SOT-23, and VSSOP packages.

Device Information

| PART NUMBER ⁽¹⁾ | PACKAGE | BODY SIZE (NOM) |
|----------------------------|------------|--------------------------|
| OPA810 | SOIC (8) | 4.90 mm \times 3.91 mm |
| | SOT-23 (5) | 2.90 mm \times 1.60 mm |
| | SC70 (5) | 2.00 mm \times 1.25 mm |

(1) For all available packages, see the orderable addendum at the end of the data sheet.

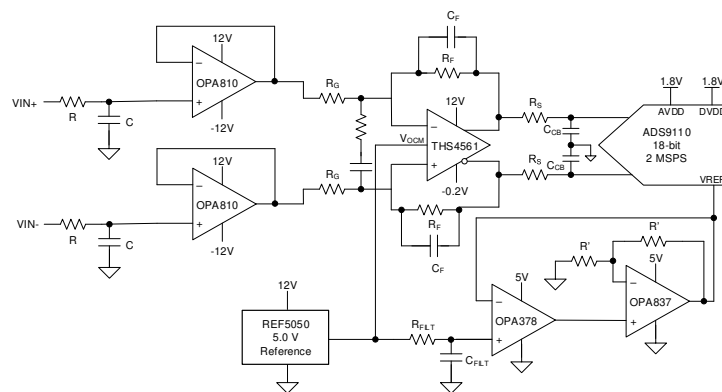

High-Z Input Data Acquisition Front-End



Table of Contents

| | | | |
|--|----------|--|-----------|
| 1 Features | 1 | 8 Detailed Description | 22 |
| 2 Applications | 1 | 8.1 Overview..... | 22 |
| 3 Description | 1 | 8.2 Functional Block Diagram..... | 22 |
| 4 Revision History | 2 | 8.3 Feature Description..... | 23 |
| 5 Device Comparison Table | 3 | 8.4 Device Functional Modes..... | 24 |
| 6 Pin Configuration and Functions | 3 | 9 Application and Implementation | 25 |
| Pin Functions..... | 3 | 9.1 Application Information..... | 25 |
| 7 Specifications | 4 | 9.2 Typical Applications..... | 30 |
| 7.1 Absolute Maximum Ratings..... | 4 | 10 Power Supply Recommendations | 34 |
| 7.2 ESD Ratings..... | 4 | 11 Layout | 34 |
| 7.3 Recommended Operating Conditions..... | 4 | 11.1 Layout Guidelines..... | 34 |
| 7.4 Thermal Information..... | 4 | 11.2 Layout Example..... | 36 |
| 7.5 Electrical Characteristics: 10 V..... | 5 | 12 Device and Documentation Support | 37 |
| 7.6 Electrical Characteristics: 24 V..... | 7 | 12.1 Third-Party Products Disclaimer..... | 37 |
| 7.7 Electrical Characteristics: 5 V..... | 9 | 12.2 Documentation Support..... | 37 |
| 7.8 Typical Characteristics: $V_S = 10\text{ V}$ | 11 | 12.3 Receiving Notification of Documentation Updates.. | 37 |
| 7.9 Typical Characteristics: $V_S = 24\text{ V}$ | 14 | 12.4 Support Resources..... | 37 |
| 7.10 Typical Characteristics: $V_S = 5\text{ V}$ | 17 | 12.5 Trademarks..... | 37 |
| 7.11 Typical Characteristics: $\pm 2.375\text{-V}$ to $\pm 12\text{-V}$ Split Supply..... | 19 | 12.6 Electrostatic Discharge Caution..... | 37 |
| | | 12.7 Glossary..... | 38 |

4 Revision History

NOTE: Page numbers for previous revisions may differ from page numbers in the current version.

| Changes from Revision B (June 2020) to Revision C (July 2020) | Page |
|--|-------------|
| • Changed the status of the DCK package From: <i>Preview</i> To: <i>Production</i> | 1 |
| <hr/> | |
| Changes from Revision A (December 2019) to Revision B (June 2020) | Page |
| • Changed the status of the DBV package From: <i>Preview</i> To: <i>Production</i> | 1 |
| • Added noise corner information to 10 V, 24 V and 5 V electrical characteristics tables..... | 5 |
| • Changed offset voltage test conditions for 10 V, 24 V and 5 V supplies for SOIC, SOT23 and SC70 packages. | 5 |
| • Updated Figure 62. Noninverting Amplifier | 25 |
| <hr/> | |
| Changes from Revision * (August 2019) to Revision A (December 2019) | Page |
| • Changed document status From: <i>Advance Information</i> To: <i>Production Data</i> | 1 |

5 Device Comparison Table

| DEVICE | $V_{S\pm}$ (V) | I_Q / CHANNEL (mA) | GBWP (MHz) | SLEW RATE (V/ μ s) | VOLTAGE NOISE (nV/ $\sqrt{\text{Hz}}$) | AMPLIFIER DESCRIPTION |
|---------|----------------|----------------------|------------|------------------------|---|--|
| OPA2810 | ± 12 | 3.6 | 70 | 192 | 6 | Unity-gain stable FET input |
| OPA607 | ± 2.5 | 0.9 | 50 | 24 | 3.8 | Gain of 6, stable, low-cost CMOS amplifier |
| THS4631 | ± 15 | 13 | 210 | 900 | 7 | Unity-gain stable FET input |
| OPA859 | ± 2.625 | 20.5 | 1800 | 1150 | 3.3 | Unity-gain stable FET input |
| OPA818 | ± 6.5 | 27.7 | 2700 | 1400 | 2.2 | Gain of 7, stable FET input |

6 Pin Configuration and Functions

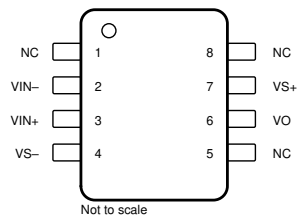

Figure 6-1. 8-Pin SOIC (D) Package

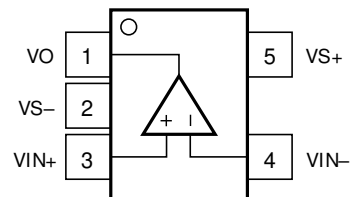

Figure 6-2. 5-Pin SOT23 (DBV) and SC70 (DCK) Packages

Pin Functions

| NAME | PIN | | TYPE ⁽¹⁾ | DESCRIPTION |
|------|------|-----------------|---------------------|---------------------------|
| | SOIC | SOT-23 and SC70 | | |
| NC | 1 | — | — | No internal connection |
| VIN- | 2 | 4 | I | Inverting input pin |
| VIN+ | 3 | 3 | I | Noninverting input pin |
| VS- | 4 | 2 | P | Negative power-supply pin |
| NC | 5 | — | — | No internal connection |
| VO | 6 | 1 | O | Output pin |
| VS+ | 7 | 5 | P | Positive power-supply pin |
| NC | 8 | — | — | No internal connection |

(1) I = input, O = output, and P = power.

7 Specifications

7.1 Absolute Maximum Ratings

Over operating free-air temperature range (unless otherwise noted).⁽¹⁾

| | | MIN | MAX | UNIT |
|----------------------|--|---------------------------------|-----------------------|------|
| V _S | Supply voltage (total bipolar supplies) ⁽⁴⁾ | | ±14 | V |
| V _{IN} | Input voltage | V _{S-} - 0.5 | V _{S+} + 0.5 | V |
| V _{IN,Diff} | Differential input voltage ⁽²⁾ | | ±7 | V |
| I _I | Continuous input current | | ±10 | mA |
| I _O | Continuous output current ⁽³⁾ | T _A = -40°C to +85°C | ±40 | mA |
| | | T _A = 125°C | ±15 | mA |
| P _D | Continuous power dissipation | See Section 7.4 | | |
| T _J | Junction temperature | | 150 | °C |
| T _{stg} | Storage temperature | -65 | 125 | °C |

- (1) Stresses beyond those listed under *Absolute Maximum Ratings* may cause permanent damage to the device. These are stress ratings only, which do not imply functional operation of the device at these or any other conditions beyond those indicated under *Recommended Operating Conditions*. Exposure to absolute-maximum-rated conditions for extended periods may affect device reliability.
- (2) Equal to the lower of ±7 V or total supply voltage.
- (3) Long-term continuous output current for electromigration limits.
- (4) V_S is the total supply voltage given by V_S = V_{S+} - V_{S-}.

7.2 ESD Ratings

| | | | VALUE | UNIT |
|--------------------|-------------------------|--|-------|------|
| V _(ESD) | Electrostatic discharge | Human-body model (HBM), per ANSI/ESDA/JEDEC JS-001 ⁽¹⁾ | ±2500 | V |
| | | Charged-device model (CDM), per JEDEC specification JESD22-C101 ⁽²⁾ | ±1500 | |

- (1) JEDEC document JEP155 states that 500-V HBM allows safe manufacturing with a standard ESD control process.
- (2) JEDEC document JEP157 states that 250-V CDM allows safe manufacturing with a standard ESD control process.

7.3 Recommended Operating Conditions

Over operating free-air temperature range (unless otherwise noted).

| | | MIN | NOM | MAX | UNIT |
|----------------|----------------------|------|-----|-----|------|
| V _S | Total supply voltage | 4.75 | | 27 | V |
| T _A | Ambient temperature | -40 | 25 | 125 | °C |

7.4 Thermal Information

| THERMAL METRIC ⁽¹⁾ | | OPA810 | | | UNIT |
|-------------------------------|--|----------|--------------|------------|------|
| | | D (SOIC) | DBV (SOT-23) | DCK (SC70) | |
| | | 8 PINS | 5 PINS | 5 PINS | |
| R _{θJA} | Junction-to-ambient thermal resistance | 134.8 | 174.3 | 190.8 | °C/W |
| R _{θJC(top)} | Junction-to-case (top) thermal resistance | 75.2 | 94.7 | 140.1 | °C/W |
| R _{θJB} | Junction-to-board thermal resistance | 78.2 | 45.4 | 69.0 | °C/W |
| ψ _{JT} | Junction-to-top characterization parameter | 25.2 | 21.6 | 45.9 | °C/W |
| ψ _{JB} | Junction-to-board characterization parameter | 77.4 | 45.0 | 68.8 | °C/W |

- (1) For more information about traditional and new thermal metrics, see the [Semiconductor and IC Package Thermal Metrics](#) application report.

7.5 Electrical Characteristics: 10 V

Test conditions unless otherwise noted: $T_A = 25^\circ\text{C}$, $V_{S+} = 5\text{ V}$, $V_{S-} = -5\text{ V}$, common-mode voltage (V_{CM}) = mid-supply, $R_L = 1\text{ k}\Omega$ connected to mid-supply⁽⁵⁾.

| PARAMETER | | TEST CONDITIONS | MIN | TYP | MAX | UNIT | TEST LEVEL ⁽³⁾ |
|-----------------------|--------------------------------------|--|----------------|----------------|-----|------------------------------|---------------------------|
| AC PERFORMANCE | | | | | | | |
| SSBW | Small-signal bandwidth | $G = 1$, $V_O = 20\text{ mV}_{PP}$, $R_F = 0\ \Omega$ | | 135 | | MHz | C |
| | | $G = 1$, $V_O = 20\text{ mV}_{PP}$, $R_F = 0\ \Omega$, $C_L = 10\text{ pF}$ | | 140 | | | C |
| | | $G = -1$, $V_O = 20\text{ mV}_{PP}$ | | 68 | | | C |
| LSBW | Large-signal bandwidth | $G = 2$, $V_O = 2\text{ V}_{PP}$ | | 41 | | MHz | C |
| GBWP | Gain-bandwidth product | | | 70 | | MHz | C |
| | Bandwidth for 0.1-dB flatness | $G = 2$, $V_O = 20\text{ mV}_{PP}$ | | 16 | | MHz | C |
| SR | Slew rate (20%-80%) ⁽⁴⁾ | $G = 2$, $V_O = -2\text{ V}$ to 2 V step | | 200 | | V/ μs | C |
| | Rise time | $V_O = 200\text{-mV}$ step | | 4 | | ns | C |
| | Fall time | $V_O = 200\text{-mV}$ step | | 4 | | ns | C |
| | Settling time to 0.1% | $G = 2$, $V_O = 2\text{-V}$ step | | 47 | | ns | C |
| | | $G = 2$, $V_O = 8\text{-V}$ step | | 65 | | | C |
| | Settling time to 0.001% | $G = 2$, $V_O = 2\text{-V}$ step | | 330 | | ns | C |
| | | $G = 2$, $V_O = 8\text{-V}$ step | | 230 | | | C |
| | Input overdrive recovery | $G = 1$, $R_F = 0\ \Omega$, ($V_{S-} - 0.5\text{ V}$) to ($V_{S+} + 0.5\text{ V}$) input | | 55 | | ns | C |
| | Output overdrive recovery | $G = -1$, ($V_{S-} - 0.5\text{ V}$) to ($V_{S+} + 0.5\text{ V}$) input | | 55 | | ns | C |
| HD2 | Second-order harmonic distortion | $f = 100\text{ kHz}$, $R_L = 1\text{ k}\Omega$, $V_O = 2\text{ V}_{PP}$ | | -120 | | dBc | C |
| | | $f = 1\text{ MHz}$, $R_L = 1\text{ k}\Omega$, $V_O = 2\text{ V}_{PP}$ | | -101 | | | C |
| HD3 | Third-order harmonic distortion | $f = 100\text{ kHz}$, $R_L = 1\text{ k}\Omega$, $V_O = 2\text{ V}_{PP}$ | | -137 | | dBc | C |
| | | $f = 1\text{ MHz}$, $R_L = 1\text{ k}\Omega$, $V_O = 2\text{ V}_{PP}$ | | -101 | | | C |
| e_n | Input-referred voltage noise | Flatband, 1/f corner at 1.5 kHz | | 6.3 | | nV/ $\sqrt{\text{Hz}}$ | C |
| i_n | Input-referred current noise | $f = 10\text{ kHz}$ | | 5 | | fA/ $\sqrt{\text{Hz}}$ | C |
| Z_O | Closed-loop output impedance | $f = 100\text{ kHz}$ | | 0.007 | | Ω | C |
| DC PERFORMANCE | | | | | | | |
| A_{OL} | Open-loop voltage gain | $f = \text{DC}$, $V_O = \pm 2.5\text{ V}$ | 108 | 120 | | dB | A |
| V_{OS} | Input offset voltage | SOIC package | | 100 | 500 | μV | A |
| | | DBV and DCK packages | | 100 | 715 | | |
| | Input offset voltage drift | $T_A = -40^\circ\text{C}$ to $+125^\circ\text{C}$ | | 2.5 | 10 | $\mu\text{V}/^\circ\text{C}$ | B |
| | Input bias current | | | 2 | 20 | pA | A |
| | Input offset current | | | 1 | 20 | pA | A |
| CMRR | Common-mode rejection ratio | $f = \text{DC}$, $V_{CM} = -3\text{ V}$ to 1 V , SOIC package | 80 | 100 | | dB | A |
| | | $T_A = -40^\circ\text{C}$ to $+125^\circ\text{C}$, SOIC package | 80 | | | | B |
| INPUT | | | | | | | |
| | Allowable input differential voltage | See Figure 7-54 | | ± 7 | | V | C |
| | Common-mode input impedance | In closed-loop configuration | | 12 2 | | G Ω pF | C |
| | Differential input capacitance | In open-loop configuration | | 0.5 | | pF | C |
| | Most positive input voltage | $\Delta V_{OS} < 5\text{ mV}$ ⁽¹⁾ | $V_{S+} + 0.2$ | $V_{S+} + 0.3$ | | V | A |

| PARAMETER | | TEST CONDITIONS | MIN | TYP | MAX | UNIT | TEST LEVEL ⁽³⁾ |
|-----------------------------------|---|---|-----------------|-----------------|-----------------|------------------------------|---------------------------|
| | Most negative input voltage | $\Delta V_{OS} < 5 \text{ mV}^{(1)}$ | $V_{S-} - 0.2$ | $V_{S-} - 0.3$ | | V | A |
| | Most positive input voltage for main-JFET stage | See Figure 7-17 | $V_{S+} - 2.9$ | $V_{S+} - 2.5$ | | V | C |
| OUTPUT | | | | | | | |
| V_{OCRH} | Output voltage range high | $R_L = 667 \Omega$ | $V_{S+} - 0.18$ | $V_{S+} - 0.11$ | | V | A |
| V_{OCRH} | Output voltage range high | $T_A = -40^\circ\text{C to } +125^\circ\text{C}, R_L = 667 \Omega$ | $V_{S+} - 0.2$ | | | V | B |
| V_{OCRL} | Output voltage range low | $R_L = 667 \Omega$ | | $V_{S-} + 0.08$ | $V_{S-} + 0.15$ | V | A |
| V_{OCRL} | Output voltage range low | $T_A = -40^\circ\text{C to } +125^\circ\text{C}, R_L = 667 \Omega$ | | $V_{S-} + 0.2$ | | V | B |
| $I_{O(max)}$ | Linear output drive (sourcing and sinking) | $V_O = 2.65 \text{ V}, R_L = 51 \Omega, \Delta V_{OS} < 1 \text{ mV}$ | 52 | 75 | | mA | A |
| I_{SC} | Output short-circuit current | | | 100 | | mA | B |
| C_L | Capacitive load drive | $< 3\text{-dB peaking}, R_S = 0 \Omega$ | | 10 | | pF | C |
| POWER SUPPLY | | | | | | | |
| I_Q | Quiescent current per channel | | | 3.7 | 4.6 | mA | A |
| PSRR | Power-supply rejection ratio | $\Delta V_S = \pm 2 \text{ V}^{(2)}, \text{SOIC package}$ | 79 | 100 | | dB | A |
| | | $T_A = -40^\circ\text{C to } +125^\circ\text{C}, \text{SOIC package}$ | 79 | | | | B |
| AUXILIARY CMOS INPUT STAGE | | | | | | | |
| | Gain-bandwidth product | | | 27 | | MHz | C |
| | Input-referred voltage noise | $f = 1 \text{ MHz}$ | | 20 | | $\text{nV}/\sqrt{\text{Hz}}$ | C |
| | Input offset voltage | $V_{CM} = V_{S+} - 1.5 \text{ V}, \text{no load, SOIC Package}$ | | | 1.6 | mV | A |
| | Input bias current | $V_{CM} = V_{S+} - 1.5 \text{ V}$ | | 2 | 20 | pA | A |

- (1) Change in input offset from its value when input is biased to midsupply.
- (2) Change in supply voltage from the default test condition with only one of the positive or negative supplies changing corresponding to +PSRR and -PSRR.
- (3) Test levels (all values set by characterization and simulation): (A) 100% tested at 25°C, overtemperature limits by characterization and simulation; (B) Not tested in production, limits set by characterization and simulation; (C) Typical value only for information.
- (4) Lower of the measured positive and negative slew rate.
- (5) For AC specifications, $G = 2 \text{ V/V}$, $R_F = 1 \text{ k}\Omega$ and $C_L = 4.7 \text{ pF}$ (unless otherwise noted).

7.6 Electrical Characteristics: 24 V

Test conditions unless otherwise noted: $T_A = 25^\circ\text{C}$, $V_{S+} = 12\text{ V}$, $V_{S-} = -12\text{ V}$, common-mode voltage (V_{CM}) = mid-supply, $R_L = 1\text{ k}\Omega$ connected to mid-supply⁽⁵⁾.

| PARAMETER | | TEST CONDITIONS | MIN | TYP | MAX | UNIT | Test Level ⁽³⁾ |
|-----------------------|------------------------------------|--|-----|-------|-----|------------------------------|---------------------------|
| AC PERFORMANCE | | | | | | | |
| SSBW | Small-signal bandwidth | $G = 1$, $V_o = 20\text{ mV}_{PP}$, $R_F = 0\ \Omega$ | | 135 | | MHz | C |
| | | $G = 1$, $V_o = 20\text{ mV}_{PP}$, $R_F = 0\ \Omega$, $C_L = 10\text{ pF}$ | | 140 | | | C |
| | | $G = -1$, $V_o = 20\text{ mV}_{PP}$ | | 68 | | | C |
| LSBW | Large-signal bandwidth | $G = 2$, $V_o = 2\text{ V}_{PP}$ | | 44 | | MHz | C |
| | | $G = 2$, $V_o = 10\text{ V}_{PP}$ | | 14 | | | C |
| GBWP | Gain-bandwidth product | | | 70 | | MHz | C |
| | Bandwidth for 0.1-dB flatness | $G = 2$, $V_o = 20\text{ mV}_{PP}$ | | 16 | | MHz | C |
| SR | Slew rate (20%-80%) ⁽⁴⁾ | $G = 2$, $V_o = -2\text{-V to } 2\text{-V step}$ | | 237 | | V/ μs | C |
| | | $G = -1$, $V_o = -2\text{-V to } 2\text{-V step}$ | | 222 | | | C |
| | | $G = 2$, $V_o = -4.5\text{-V to } 3.5\text{-V step}$ | | 254 | | | C |
| | Rise time | $V_o = 200\text{-mV step}$ | | 4 | | ns | C |
| | Fall time | $V_o = 200\text{-mV step}$ | | 4 | | ns | C |
| | Settling time to 0.1% | $G = 2$, $V_o = 2\text{-V step}$ | | 47 | | ns | C |
| | | $G = 2$, $V_o = 10\text{-V step}$ | | 70 | | | C |
| | Settling time to 0.001% | $G = 2$, $V_o = 2\text{-V step}$ | | 320 | | ns | C |
| | | $G = 2$, $V_o = 10\text{-V step}$ | | 200 | | | C |
| | Input overdrive recovery | $G = 1$, $R_F = 0\ \Omega$, ($V_{S-} - 0.5\text{ V}$) to ($V_{S+} + 0.5\text{ V}$) input | | 35 | | ns | C |
| | Output overdrive recovery | $G = -1$, ($V_{S-} - 0.5\text{ V}$) to ($V_{S+} + 0.5\text{ V}$) input | | 45 | | ns | C |
| HD2 | Second-order harmonic distortion | $f = 100\text{ kHz}$, $R_L = 1\text{ k}\Omega$, $V_o = 2\text{ V}_{PP}$ | | -118 | | dBc | C |
| | | $f = 100\text{ kHz}$, $R_L = 1\text{ k}\Omega$, $V_o = 10\text{ V}_{PP}$ | | -108 | | | C |
| | | $f = 1\text{ MHz}$, $R_L = 1\text{ k}\Omega$, $V_o = 2\text{ V}_{PP}$ | | -112 | | | C |
| | | $f = 1\text{ MHz}$, $R_L = 1\text{ k}\Omega$, $V_o = 10\text{ V}_{PP}$ | | -91 | | | C |
| HD3 | Third-order harmonic distortion | $f = 100\text{ kHz}$, $R_L = 1\text{ k}\Omega$, $V_o = 2\text{ V}_{PP}$ | | -136 | | dBc | C |
| | | $f = 100\text{ kHz}$, $R_L = 1\text{ k}\Omega$, $V_o = 10\text{ V}_{PP}$ | | -130 | | | C |
| | | $f = 1\text{ MHz}$, $R_L = 1\text{ k}\Omega$, $V_o = 2\text{ V}_{PP}$ | | -104 | | | C |
| | | $f = 1\text{ MHz}$, $R_L = 1\text{ k}\Omega$, $V_o = 10\text{ V}_{PP}$ | | -91 | | | C |
| e_n | Input-referred voltage noise | Flatband, 1/f corner at 1.5 kHz | | 6.3 | | nV/ $\sqrt{\text{Hz}}$ | C |
| i_n | Input-referred current noise | $f = 10\text{ kHz}$ | | 5 | | fA/ $\sqrt{\text{Hz}}$ | C |
| z_o | Closed-loop output impedance | $f = 100\text{ kHz}$ | | 0.007 | | Ω | C |
| DC PERFORMANCE | | | | | | | |
| A_{OL} | Open-loop voltage gain | $f = \text{DC}$, $V_o = \pm 8\text{ V}$ | 108 | 120 | | dB | A |
| V_{OS} | Input offset voltage | SOIC package | | 100 | 500 | μV | A |
| | | DBV and DCK packages | | 100 | 550 | | |
| | Input offset voltage drift | $T_A = -40^\circ\text{C to } +125^\circ\text{C}$ | | 2.5 | 10 | $\mu\text{V}/^\circ\text{C}$ | B |
| | Input bias current | | | 2 | 20 | pA | A |
| | Input offset current | | | 1 | 20 | pA | A |
| CMRR | Common-mode rejection ratio | $f = \text{DC}$, $V_{CM} = \pm 5\text{ V}$, SOIC package | 90 | 105 | | dB | A |
| | | $T_A = -40^\circ\text{C to } +125^\circ\text{C}$, SOIC package | 90 | | | | B |

| PARAMETER | | TEST CONDITIONS | MIN | TYP | MAX | UNIT | Test Level ⁽³⁾ |
|-----------------------------------|---|--|-----------------|-----------------|-----------------|------------------------|---------------------------|
| INPUT | | | | | | | |
| | Allowable input differential voltage | see Figure 7-54 | | ±7 | | V | C |
| | Common-mode input impedance | In closed-loop configuration | | 12 2.5 | | GΩ pF | C |
| | Differential input capacitance | In open-loop configuration | | 0.5 | | pF | C |
| | Most positive input voltage | $\Delta V_{OS} < 5 \text{ mV}^{(1)}$ | $V_{S+} + 0.2$ | $V_{S+} + 0.3$ | | V | A |
| | Most negative input voltage | $\Delta V_{OS} < 5 \text{ mV}^{(1)}$ | $V_{S-} - 0.2$ | $V_{S-} - 0.3$ | | V | A |
| | Most positive input voltage for main-JFET stage | See Figure 7-33 | $V_{S+} - 2.9$ | $V_{S+} - 2.5$ | | V | C |
| OUTPUT | | | | | | | |
| V_{OCRH} | Output voltage range high | $R_L = 667 \Omega$ | $V_{S+} - 0.33$ | $V_{S+} - 0.22$ | | V | A |
| | | $T_A = -40^\circ\text{C}$ to $+125^\circ\text{C}$, $R_L = 667 \Omega$ | $V_{S+} - 0.36$ | | | | B |
| V_{OCRL} | Output voltage range low | $R_L = 667 \Omega$ | | $V_{S-} + 0.15$ | $V_{S-} + 0.23$ | V | A |
| | | $T_A = -40^\circ\text{C}$ to $+125^\circ\text{C}$, $R_L = 667 \Omega$ | | | $V_{S-} + 0.33$ | | B |
| $I_{O(max)}$ | Linear output drive (sourcing and sinking) | $V_o = 7.25 \text{ V}$, $R_L = 151 \Omega$, $\Delta V_{OS} < 1 \text{ mV}$ | 48 | 64 | | mA | A |
| I_{SC} | Output short-circuit current | | | 108 | | mA | B |
| C_L | Capacitive load drive | < 3-dB peaking, $R_S = 0 \Omega$ | | 10 | | pF | C |
| POWER SUPPLY | | | | | | | |
| I_Q | Quiescent current per channel | | | 3.8 | 4.7 | mA | A |
| PSRR | Power supply rejection ratio | $\Delta V_S = \pm 2 \text{ V}^{(2)}$, SOIC package | 90 | 105 | | dB | A |
| | | $T_A = -40^\circ\text{C}$ to $+125^\circ\text{C}$, SOIC package | 90 | | | | B |
| AUXILIARY CMOS INPUT STAGE | | | | | | | |
| | Gain-bandwidth product | | | 27 | | MHz | C |
| | Input-referred voltage noise | $f = 1 \text{ MHz}$ | | 20 | | nV/ $\sqrt{\text{Hz}}$ | C |
| | Input offset voltage | $V_{CM} = V_{S+} - 1.5 \text{ V}$, no load, SOIC Package | | | 1.6 | mV | A |
| | Input bias current | $V_{CM} = V_{S+} - 1.5 \text{ V}$ | | 2 | 24 | pA | A |

- (1) Change in input offset from its value when input is biased to midsupply.
- (2) Change in supply voltage from the default test condition with only one of the positive or negative supplies changing corresponding to +PSRR and -PSRR.
- (3) Test levels (all values set by characterization and simulation): (A) 100% tested at 25°C, overtemperature limits by characterization and simulation; (B) Not tested in production, limits set by characterization and simulation; (C) Typical value only for information.
- (4) Lower of the measured positive and negative slew rate.
- (5) For AC specifications, $G = 2 \text{ V/V}$, $R_F = 1 \text{ k}\Omega$ and $C_L = 4.7 \text{ pF}$ (unless otherwise noted).

7.7 Electrical Characteristics: 5 V

Test conditions unless otherwise noted: $T_A = 25^\circ\text{C}$, $V_{S+} = 5\text{ V}$, $V_{S-} = 0\text{ V}$, common-mode voltage (V_{CM}) = 1.25 V, $R_L = 1\text{ k}\Omega$ connected to 1.25 V⁽⁵⁾.

| PARAMETER | | TEST CONDITIONS | MIN | TYP | MAX | UNIT | Test Level ⁽¹⁾ |
|-----------------------|--------------------------------------|---|-----|--------------------|-----|------------------------------|---------------------------|
| AC PERFORMANCE | | | | | | | |
| SSBW | Small-signal bandwidth | $G = 1$, $V_o = 20\text{ mV}_{PP}$, $R_F = 0\ \Omega$ | | 133 | | MHz | C |
| | | $G = 1$, $V_o = 20\text{ mV}_{PP}$, $R_F = 0\ \Omega$, $C_L = 10\text{ pF}$ | | 135 | | | C |
| | | $G = -1$, $V_o = 20\text{ mV}_{PP}$ | | 65 | | | C |
| LSBW | Large-signal bandwidth | $G = 2$, $V_o = 2\text{ V}_{PP}$ | | 36 | | MHz | C |
| GBWP | Gain-bandwidth product | | | 70 | | MHz | C |
| | Bandwidth for 0.1-dB flatness | $G = 2$, $V_o = 20\text{ mV}_{PP}$ | | 16 | | MHz | C |
| SR | Slew rate (20%-80%) ⁽⁴⁾ | $G = 2$, $V_o = -1\text{ V}$ to 1 V step | | 134 | | V/ μs | C |
| | | $G = 2$, $V_o = -2\text{ V}$ to 2 V step, $V_S = \pm 2.5\text{ V}$ | | 78 | | | C |
| | Rise time | $V_o = 200\text{-mV}$ step | | 4 | | ns | C |
| | Fall time | $V_o = 200\text{-mV}$ step | | 4 | | ns | C |
| | Settling time to 0.1% | $G = 2$, $V_o = -2\text{ V}$ to 0-V step, $V_S = \pm 2.5\text{ V}$ | | 100 | | ns | C |
| | Settling time to 0.001% | $G = 2$, $V_o = -2\text{ V}$ to 0-V step, $V_S = \pm 2.5\text{ V}$ | | 565 | | ns | C |
| | Input overdrive recovery | $G = 1$, ($V_{S-} - 0.5\text{ V}$) to ($V_{S+} + 0.5\text{ V}$) input, $V_S = \pm 2.5\text{ V}$ | | 76 | | ns | C |
| | Output overdrive recovery | $G = -1$, ($V_{S-} - 0.5\text{ V}$) to ($V_{S+} + 0.5\text{ V}$) input, $V_S = \pm 2.5\text{ V}$ | | 93 | | ns | C |
| HD2 | Second-order harmonic distortion | $f = 100\text{ kHz}$, $R_L = 1\text{ k}\Omega$, $V_o = 2\text{ V}_{PP}$ | | -102 | | dBc | C |
| | | $f = 1\text{ MHz}$, $R_L = 1\text{ k}\Omega$, $V_o = 2\text{ V}_{PP}$ | | -81 | | | C |
| HD3 | Third-order harmonic distortion | $f = 100\text{ kHz}$, $R_L = 1\text{ k}\Omega$, $V_o = 2\text{ V}_{PP}$ | | -114 | | dBc | C |
| | | $f = 1\text{ MHz}$, $R_L = 1\text{ k}\Omega$, $V_o = 2\text{ V}_{PP}$ | | -92 | | | C |
| e_n | Input-referred voltage noise | Flatband, 1/f corner at 1.5 kHz | | 6.3 | | nV/ $\sqrt{\text{Hz}}$ | C |
| i_n | Input-referred current noise | $f = 10\text{ kHz}$ | | 5 | | fA/ $\sqrt{\text{Hz}}$ | C |
| z_o | Closed-loop output impedance | $f = 100\text{ kHz}$ | | 0.007 | | Ω | C |
| DC PERFORMANCE | | | | | | | |
| A_{OL} | Open-loop voltage gain | $f = \text{DC}$, $V_o = 1.25\text{ V}$ to 3.25 V | 104 | 118 | | dB | A |
| V_{OS} | Input offset voltage | SOIC package | | 100 | 550 | μV | A |
| | | DBV and DCK packages | | 100 | 760 | | |
| | Input offset voltage drift | $T_A = -40^\circ\text{C}$ to $+125^\circ\text{C}$ | | 2.5 | 10 | $\mu\text{V}/^\circ\text{C}$ | B |
| | Input bias current | | | 2 | 20 | pA | A |
| | Input offset current | | | 1 | 20 | pA | A |
| CMRR | Common-mode rejection ratio | $f = \text{DC}$, $V_{CM} = 0.75\text{ V}$ to 1.75 V , SOIC package | 73 | 92 | | dB | A |
| | | $T_A = -40^\circ\text{C}$ to $+125^\circ\text{C}$, SOIC package | 73 | | | | B |
| INPUT | | | | | | | |
| | Allowable input differential voltage | See Figure 7-54 | | ± 5 | | V | C |
| | Common-mode input impedance | In closed-loop configuration | | $12 \parallel 2.5$ | | G Ω pF | C |
| | Differential input capacitance | In open-loop configuration | | 0.5 | | pF | C |

| PARAMETER | | TEST CONDITIONS | MIN | TYP | MAX | UNIT | Test Level ⁽¹⁾ |
|-----------------------------------|---|---|-----------------|-----------------|-----------------|------------------------------|---------------------------|
| | Most positive input voltage | $\Delta V_{OS} < 5 \text{ mV}^{(2)}$ | $V_{S+} + 0.2$ | $V_{S+} + 0.3$ | | V | A |
| | Most negative input voltage | $\Delta V_{OS} < 5 \text{ mV}^{(2)}$ | $V_{S-} - 0.2$ | $V_{S-} - 0.3$ | | V | A |
| | Most positive input voltage for main-JFET stage | See Figure 7-41 | $V_{S+} - 2.9$ | $V_{S+} - 2.5$ | | V | C |
| OUTPUT | | | | | | | |
| V_{OCRH} | Output voltage range high | $R_L = 667 \Omega$ | $V_{S+} - 0.12$ | $V_{S+} - 0.09$ | | V | A |
| | | $T_A = -40^\circ\text{C to } +125^\circ\text{C}, R_{LOAD} = 667 \Omega$ | $V_{S+} - 0.15$ | | | | B |
| $V_{OCR L}$ | Output voltage range low | $R_L = 667 \Omega$ | | $V_{S-} + 0.06$ | $V_{S-} + 0.11$ | V | A |
| | | $T_A = -40^\circ\text{C to } +125^\circ\text{C}, R_L = 667 \Omega$ | | | $V_{S-} + 0.15$ | | B |
| $I_{O(max)}$ | Linear output drive (sourcing and sinking) | $V_O = 1.4 \text{ V}, R_L = 27.5 \Omega, \Delta V_{OS} < 1 \text{ mV}, V_{S+} = 3 \text{ V and } V_{S-} = -2 \text{ V}$ | 50 | 64 | | mA | A |
| I_{SC} | Output short-circuit current | | | 96 | | mA | B |
| C_L | Capacitive load drive | $< 3\text{-dB peaking}, R_S = 0 \Omega$ | | 10 | | pF | C |
| POWER SUPPLY | | | | | | | |
| I_Q | Quiescent current per channel | | 3.15 | 3.7 | 4.5 | mA | A |
| PSRR | Power-supply rejection ratio | $\Delta V_S = \pm 0.5 \text{ V}^{(3)}, \text{SOIC package}$ | 78 | 100 | | dB | A |
| | | $T_A = -40^\circ\text{C to } +125^\circ\text{C}, \text{SOIC package}$ | 78 | | | | B |
| AUXILIARY CMOS INPUT STAGE | | | | | | | |
| | Gain-bandwidth product | | | 27 | | MHz | C |
| | Input-referred voltage noise | $f = 1 \text{ MHz}$ | | 20 | | $\text{nV}/\sqrt{\text{Hz}}$ | C |
| | Input offset voltage | $V_{CM} = V_{S+} - 1.5 \text{ V}, \text{no load, SOIC Package}$ | | | 1.6 | mV | A |
| | Input bias current | $V_{CM} = V_{S+} - 1.5 \text{ V}$ | | 2 | 20 | pA | A |

- (1) Test levels (all values set by characterization and simulation): (A) 100% tested at 25°C, overtemperature limits by characterization and simulation; (B) Not tested in production, limits set by characterization and simulation; (C) Typical value only for information.
- (2) Change in input offset from its value when input is biased to 0 V.
- (3) Change in supply voltage from the default test condition with only one of the positive or negative supplies changing corresponding to +PSRR and -PSRR.
- (4) Lower of the measured positive and negative slew rate.
- (5) For AC specifications, $V_{S+} = 3.5 \text{ V}, V_{S-} = -1.5 \text{ V}, G = 2 \text{ V/V}, R_F = 1 \text{ k}\Omega, C_L = 4.7 \text{ pF}, V_{CM} = 0 \text{ V}$ (unless otherwise noted).

7.8 Typical Characteristics: $V_S = 10\text{ V}$

At $V_{S+} = 5\text{ V}$, $V_{S-} = -5\text{ V}$, $R_L = 1\text{ k}\Omega$, input and output are biased to midsupply, and $T_A \approx 25^\circ\text{C}$. For AC specifications, $V_O = 2\text{ V}_{PP}$, $G = 2\text{ V/V}$, $R_F = 1\text{ k}\Omega$, and $C_L = 4.7\text{ pF}$ (unless otherwise noted).

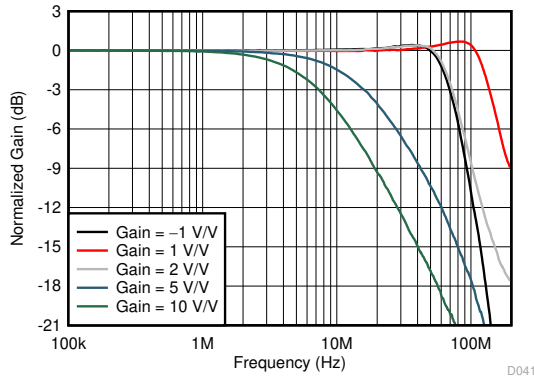

See Figure 9-1 and Figure 9-2, $V_O = 20\text{ mV}_{PP}$

Figure 7-1. Small-Signal Frequency Response vs Gain

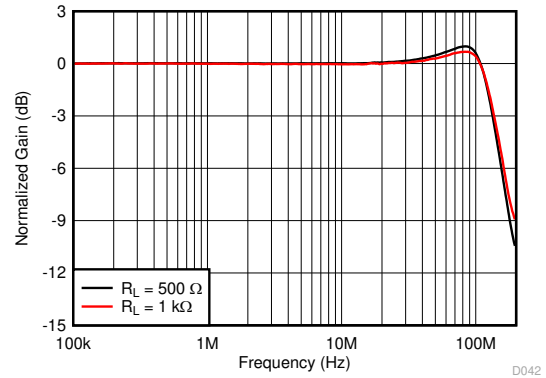

See Figure 9-1, $V_O = 20\text{ mV}_{PP}$, gain = 1 V/V, $R_F = 0\ \Omega$

Figure 7-2. Small-Signal Frequency Response vs Output Load

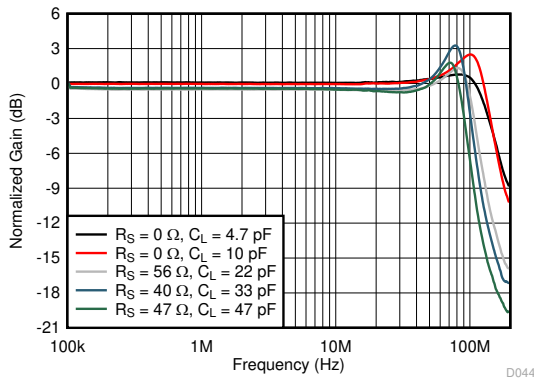

See Figure 9-1 and Figure 8-1,
 $V_O = 20\text{ mV}_{PP}$, gain = 1 V/V, $R_F = 0\ \Omega$

Figure 7-3. Small-Signal Frequency Response vs C_L

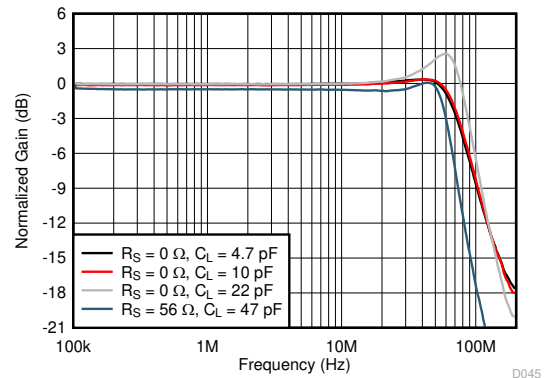

See Figure 9-1 and Figure 8-1, $V_O = 20\text{ mV}_{PP}$, gain = 2 V/V

Figure 7-4. Small-Signal Frequency Response vs C_L

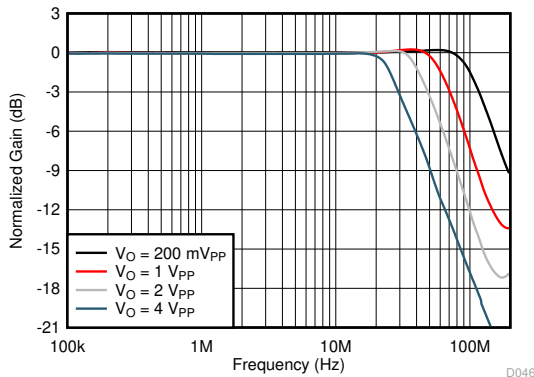

See Figure 9-1, gain = 1 V/V, $R_F = 0\ \Omega$

Figure 7-5. Large-Signal Frequency Response vs Output Voltage

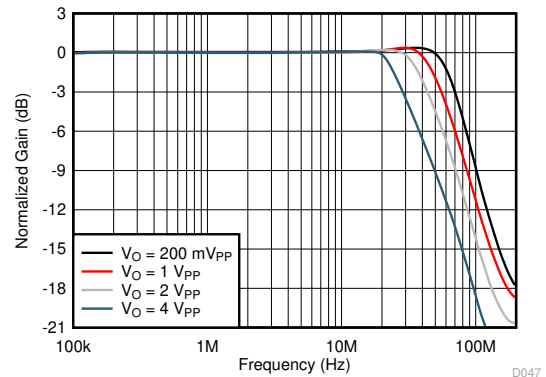

See Figure 9-1, gain = 2 V/V

Figure 7-6. Large-Signal Frequency Response vs Output Voltage

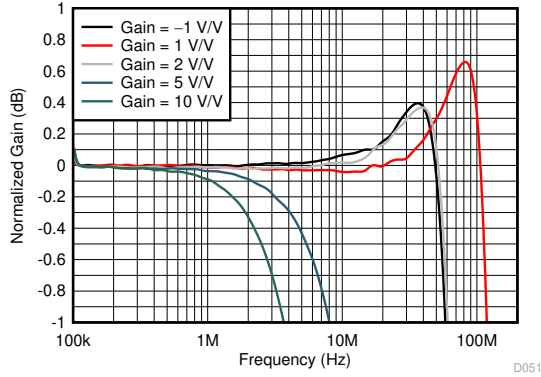

See Figure 9-1 and Figure 9-2, $V_O = 20\text{ mV}_{PP}$

Figure 7-7. Small-Signal Response Flatness vs Gain

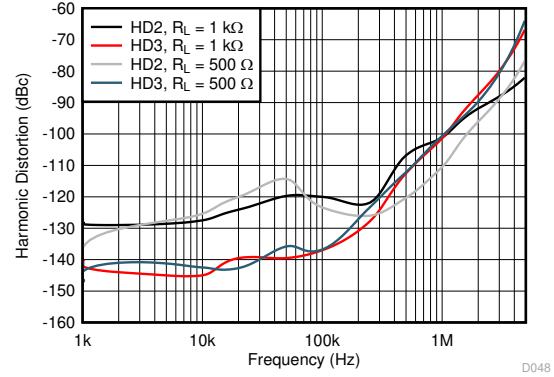

See Figure 9-1, gain = 2 V/V

Figure 7-8. Harmonic Distortion vs Frequency

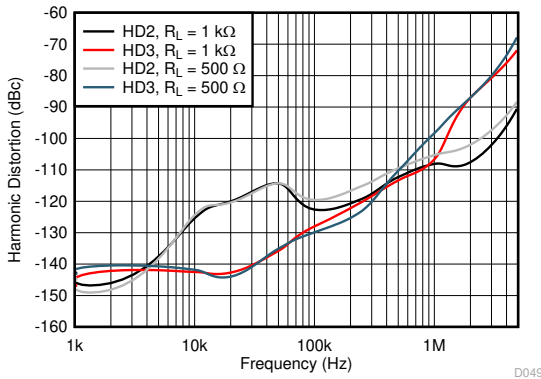

See Figure 9-2, gain = -1 V/V

Figure 7-9. Harmonic Distortion vs Frequency

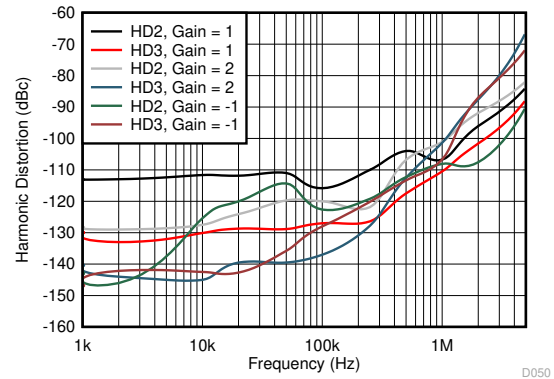

See Figure 9-1 and Figure 9-2, $R_F = 0\ \Omega$

Figure 7-10. Harmonic Distortion vs Gain

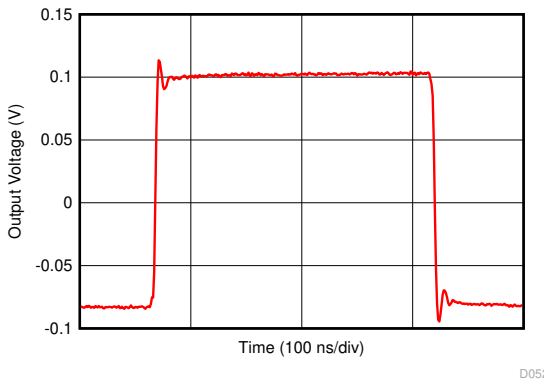

See Figure 9-1, gain = 1 V/V, $R_F = 0\ \Omega$, $C_L = 10\text{ pF}$

Figure 7-11. Small-Signal Transient Response

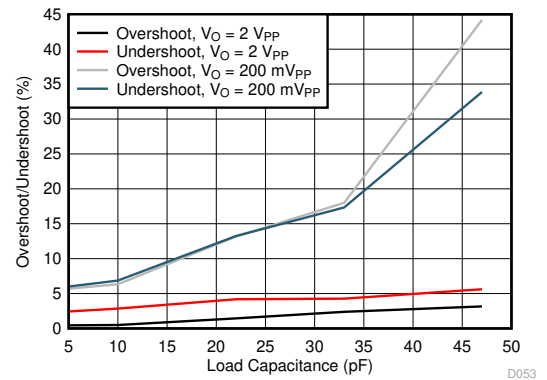

See Figure 9-1, gain = 1 V/V, $R_F = 0\ \Omega$

Figure 7-12. Overshoot and Undershoot vs C_L

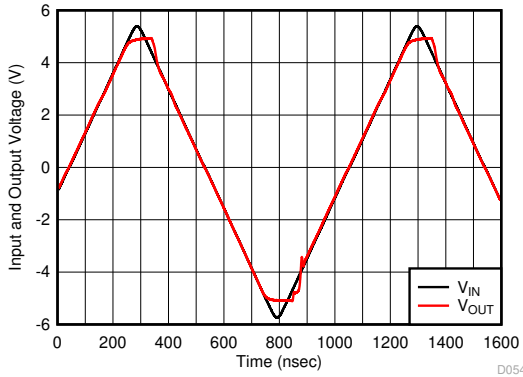

See Figure 9-1, gain = 1 V/V, $R_F = 0 \Omega$

Figure 7-13. Input Overdrive Recovery

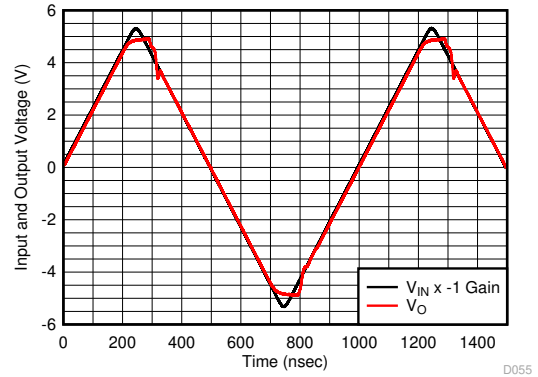

See Figure 9-2, gain = -1 V/V

Figure 7-14. Output Overdrive Recovery

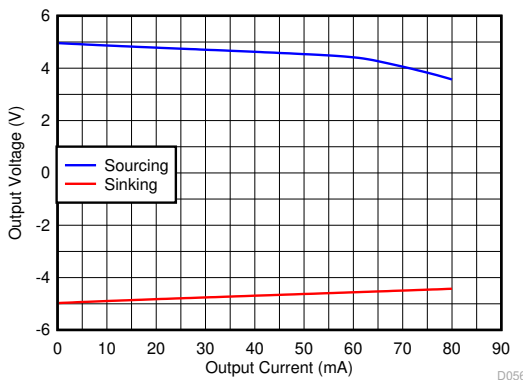
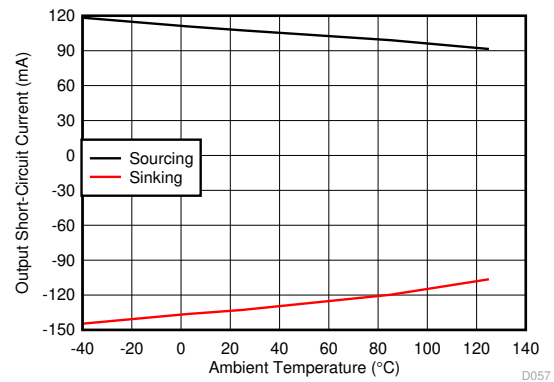

Figure 7-15. Output Voltage vs Load Current



Output saturated and then short-circuited

Figure 7-16. Output Short-Circuit Current vs Ambient Temperature

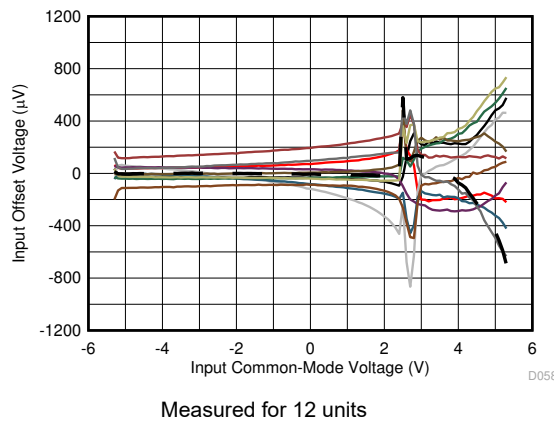
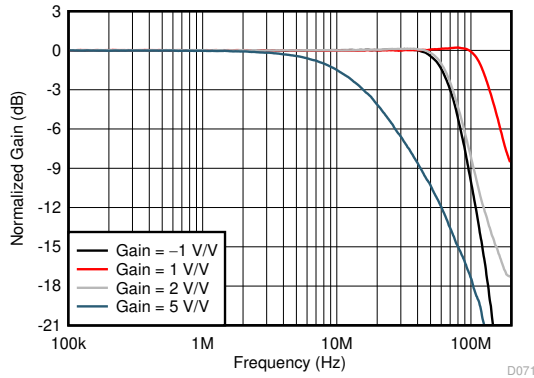

Figure 7-17. Input Offset Voltage vs Input Common-Mode Voltage

7.9 Typical Characteristics: $V_S = 24\text{ V}$

At $V_{S+} = 12\text{ V}$, $V_{S-} = -12\text{ V}$, $R_L = 1\text{ k}\Omega$, input and output are biased to midsupply, and $T_A \approx 25^\circ\text{C}$. For AC specifications, $V_O = 2\text{ V}_{PP}$, $G = 2\text{ V/V}$, $R_F = 1\text{ k}\Omega$, and $C_L = 4.7\text{ pF}$ (unless otherwise noted).



See Figure 9-1 and Figure 9-2, $V_O = 20\text{ mV}_{PP}$

Figure 7-18. Noninverting Small-Signal Frequency Response vs Gain

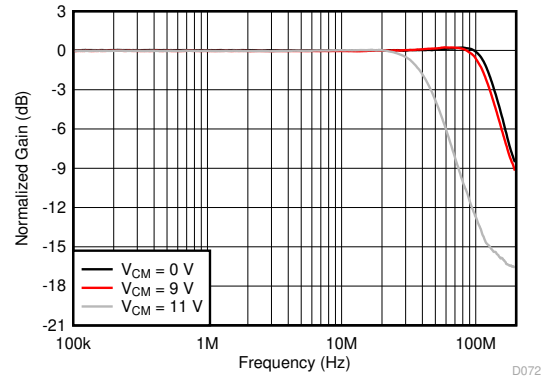

See Figure 9-1, $V_O = 20\text{ mV}_{PP}$, gain = 1 V/V, $C_L = 4.7\text{ pF}$, $R_F = 0\ \Omega$

Figure 7-19. Small-Signal Frequency Response vs Output Common-Mode Voltage

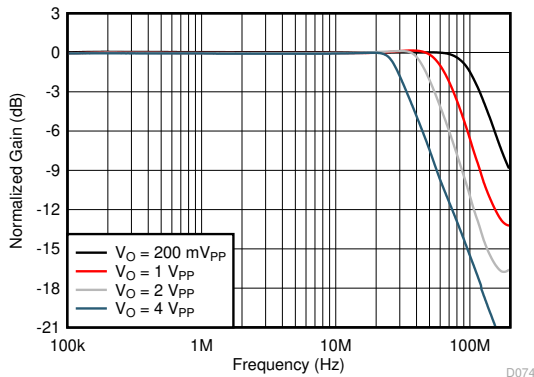

See Figure 9-1, gain = 1 V/V, $R_F = 0\ \Omega$

Figure 7-20. Large-Signal Frequency Response vs Output Voltage

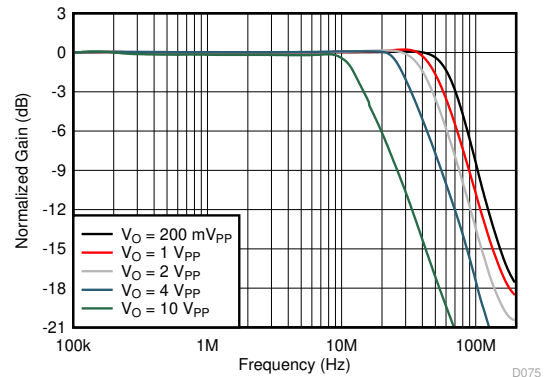

See Figure 9-1, gain = 2 V/V

Figure 7-21. Large-Signal Frequency Response vs V_O

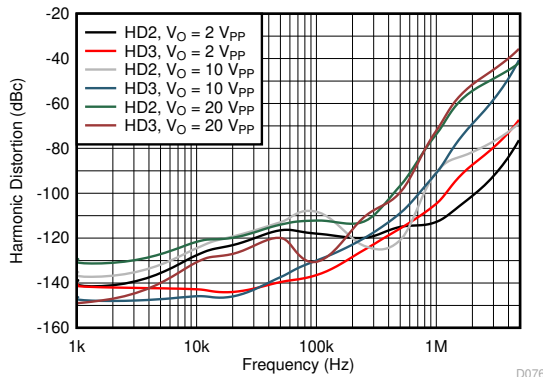

See Figure 9-1, gain = 2 V/V

Figure 7-22. Harmonic Distortion vs Frequency vs V_O

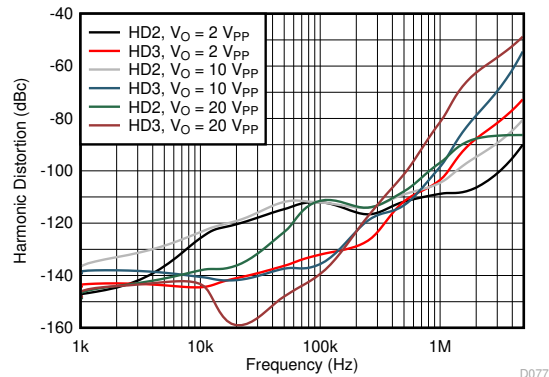

See Figure 9-2, gain = -1 V/V

Figure 7-23. Harmonic Distortion vs Frequency vs V_O

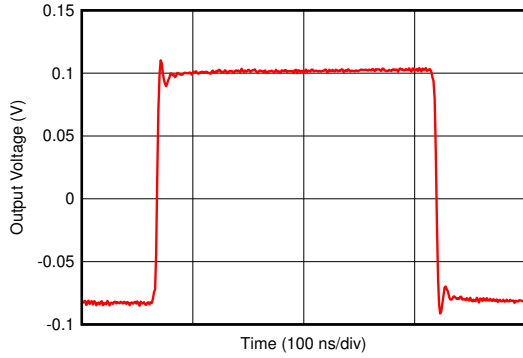

D078

See Figure 9-1, gain = 1 V/V, $R_F = 0 \Omega$, $C_L = 10 \text{ pF}$

Figure 7-24. Small-Signal Transient Response

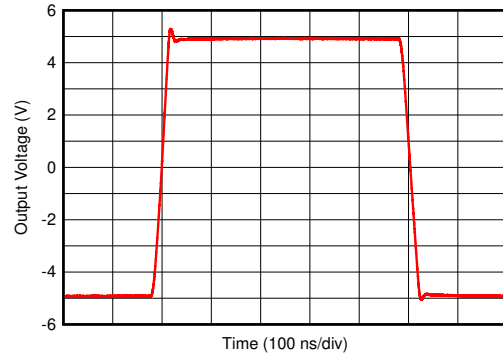

D079

See Figure 9-1, gain = 1 V/V, $R_F = 0 \Omega$

Figure 7-25. Large-Signal Transient Response

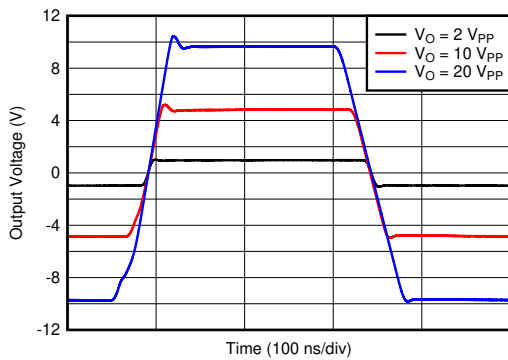

D080

See Figure 9-1, gain = 2 V/V

Figure 7-26. Large-Signal Transient Response

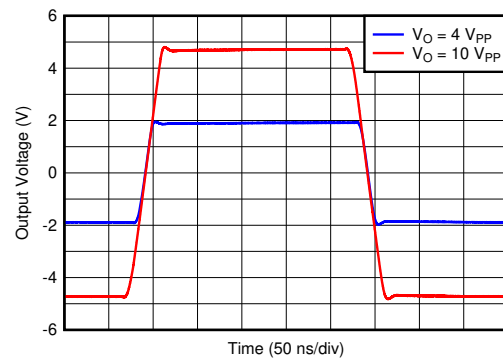

D081

See Figure 9-2, gain = -1 V/V

Figure 7-27. Large-Signal Transient Response

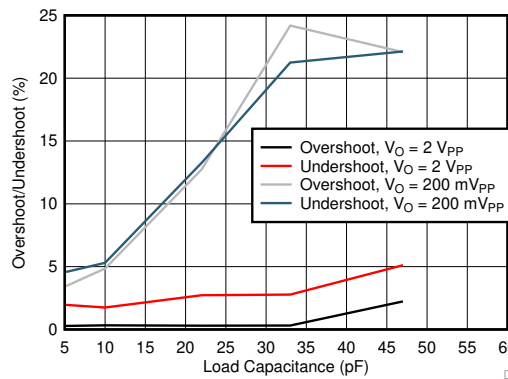

D082

See Figure 9-1, gain = 1 V/V, $R_F = 0 \Omega$

Figure 7-28. Overshoot and Undershoot vs C_L

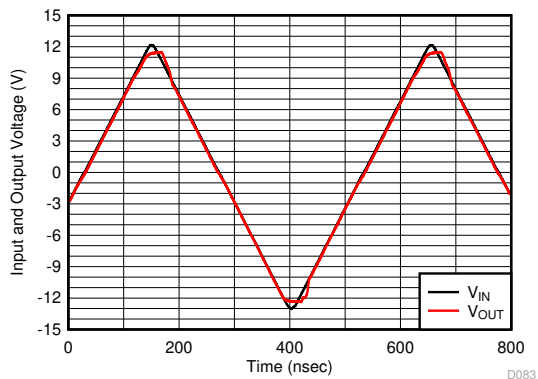

D083

See Figure 9-1, gain = 1 V/V, $R_F = 0 \Omega$

Figure 7-29. Input Overdrive Recovery

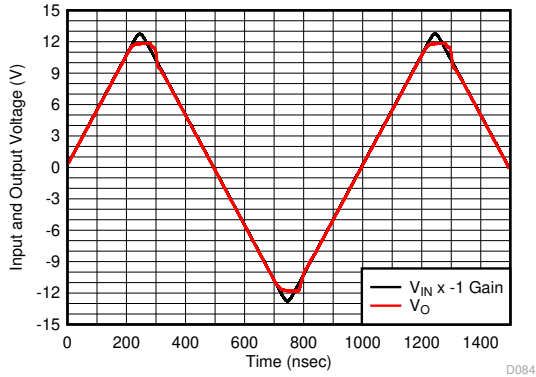

See Figure 9-2, gain = -1 V/V

Figure 7-30. Output Overdrive Recovery

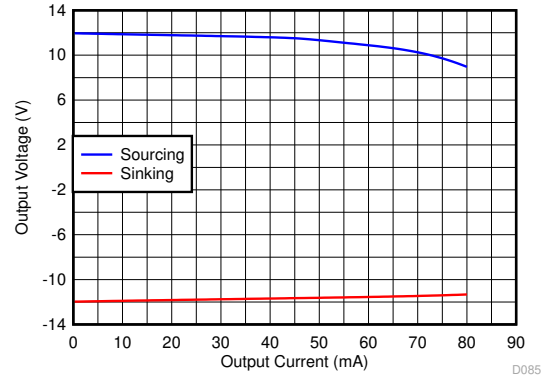
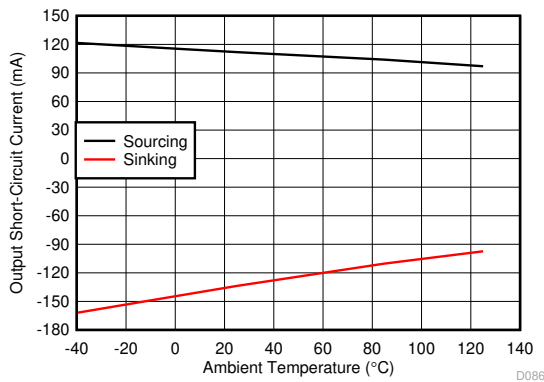
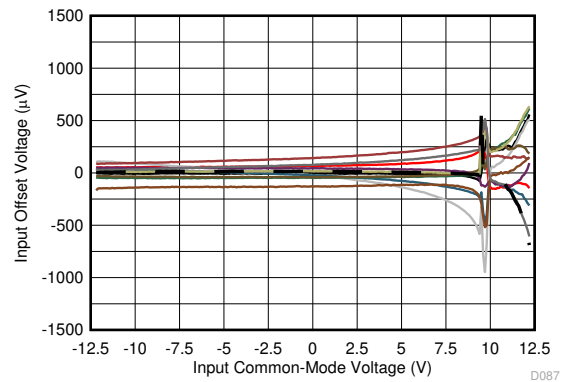

Figure 7-31. Output Voltage Range vs Load Current



Output saturated and then short-circuited

Figure 7-32. Output Short-Circuit Current vs Ambient Temperature



Measured for 12 units

Figure 7-33. Input Offset Voltage vs Input Common-Mode Voltage

7.10 Typical Characteristics: $V_S = 5\text{ V}$

At $V_{S+} = 5\text{ V}$, $V_{S-} = 0\text{ V}$, $V_{CM} = 1.25\text{ V}$, $R_L = 1\text{ k}\Omega$, output is biased to midsupply, and $T_A \approx 25^\circ\text{C}$. For AC specifications, $V_{S+} = 3.5\text{ V}$, $V_{S-} = -1.5\text{ V}$, $V_{CM} = 0\text{ V}$, $V_O = 2\text{ V}_{PP}$, $G = 2\text{ V/V}$, $R_F = 1\text{ k}\Omega$, and $C_L = 4.7\text{ pF}$ (unless otherwise noted).

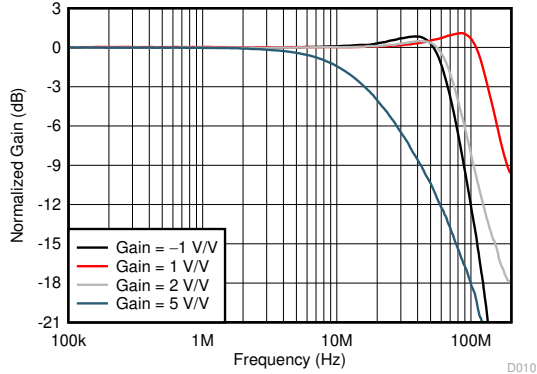

See Figure 9-1 and Figure 9-2, $V_O = 20\text{ mV}_{PP}$

Figure 7-34. Small-Signal Response vs Gain

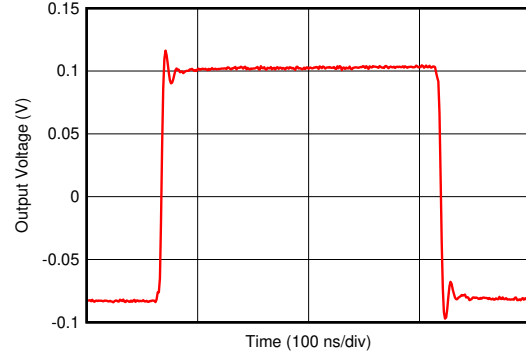

See Figure 9-1, gain = 1 V/V, $R_F = 0\ \Omega$, $C_L = 10\text{ pF}$

Figure 7-35. Small-Signal Transient Response

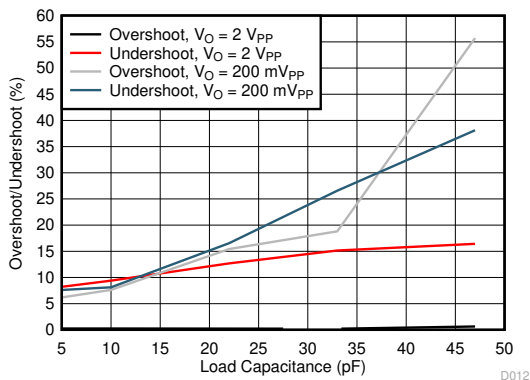

See Figure 9-1, gain = 1 V/V, $R_F = 0\ \Omega$

Figure 7-36. Overshoot and Undershoot vs C_L

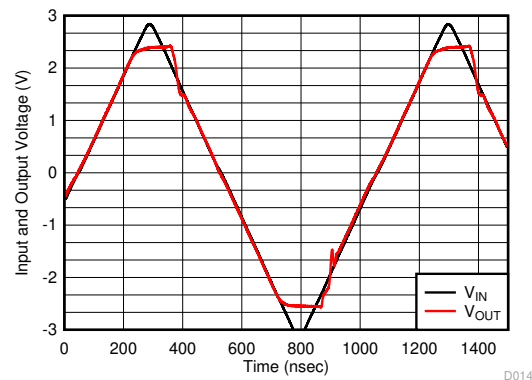

See Figure 9-1, gain = 1 V/V, $R_F = 0\ \Omega$

Figure 7-37. Input Overdrive Recovery

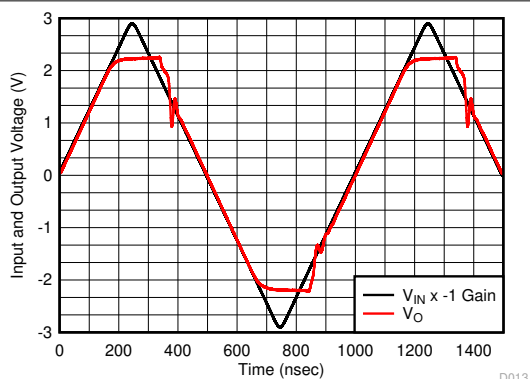

See Figure 9-2, gain = -1 V/V

Figure 7-38. Output Overdrive Recovery

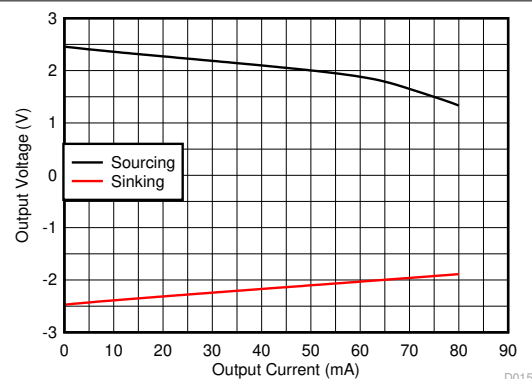
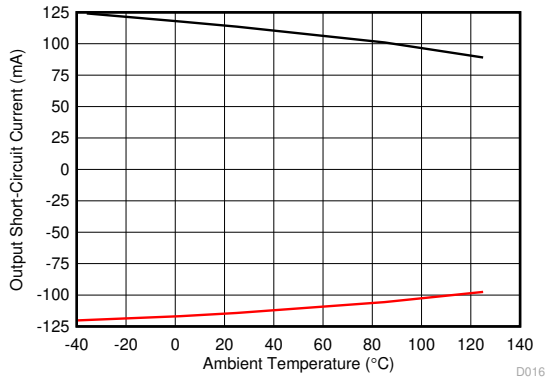
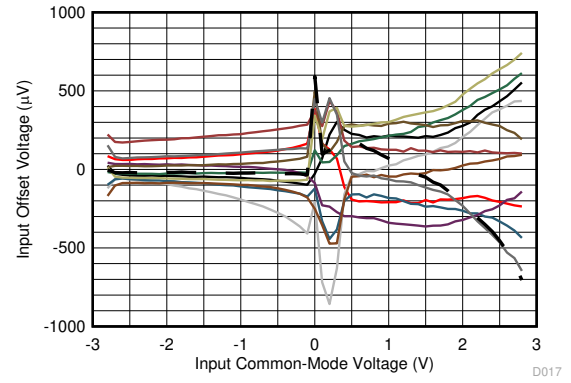

Figure 7-39. Output Voltage Range vs Output Current



Output saturated and then short-circuited

Figure 7-40. Output Short-Circuit Current vs Ambient Temperature



Measured for 12 units

Figure 7-41. Input Offset Voltage vs Input Common-Mode Voltage

7.11 Typical Characteristics: $\pm 2.375\text{-V}$ to $\pm 12\text{-V}$ Split Supply

At $V_O = 2 V_{PP}$, $R_F = 1\text{ k}\Omega$, $R_L = 1\text{ k}\Omega$ and $T_A \approx 25^\circ\text{C}$ (unless otherwise noted).

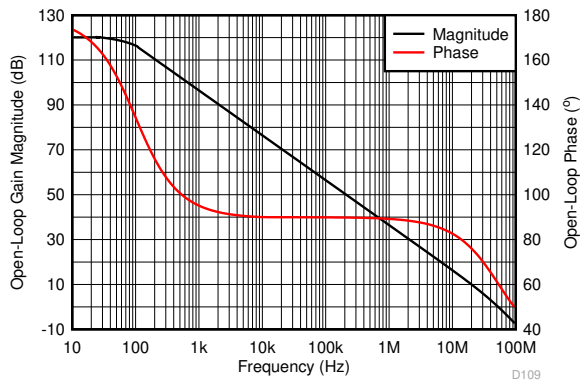

Simulated with no output load

Figure 7-42. Open-Loop Gain and Phase vs Frequency

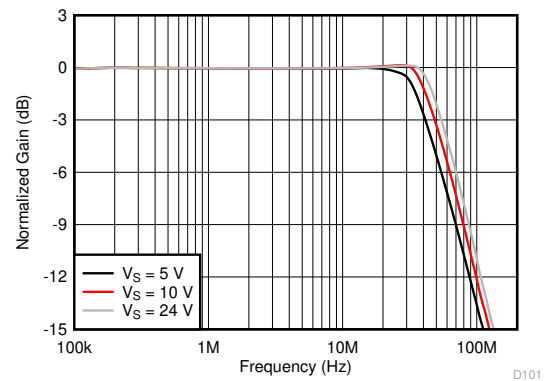

See Figure 9-1, gain = 1 V/V, $R_F = 0\ \Omega$

Figure 7-43. Large-Signal Response vs Supply Voltage

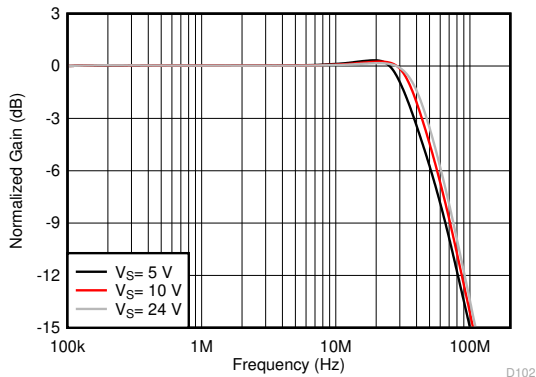

See Figure 9-1, gain = 2 V/V

Figure 7-44. Large-Signal Response vs Supply Voltage

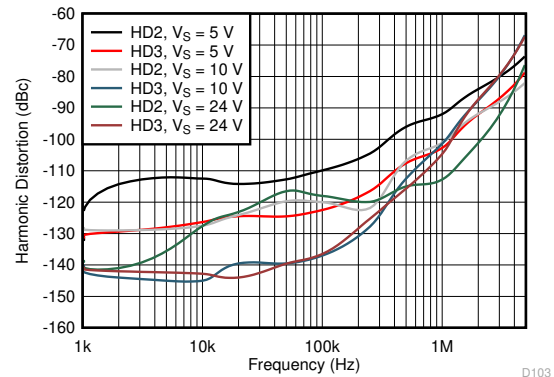

See Figure 9-1, gain = 2 V/V

Figure 7-45. Harmonic Distortion vs Frequency vs Supply Voltage

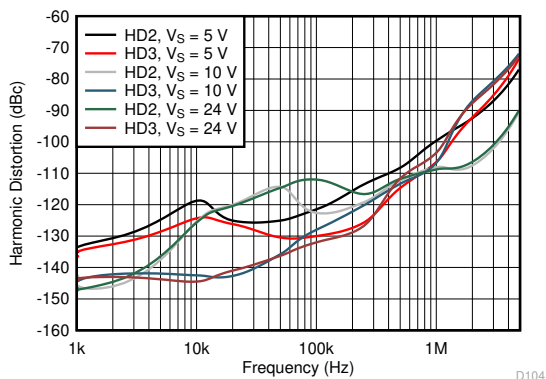

See Figure 9-2, gain = -1 V/V

Figure 7-46. Harmonic Distortion vs Frequency vs Supply Voltage

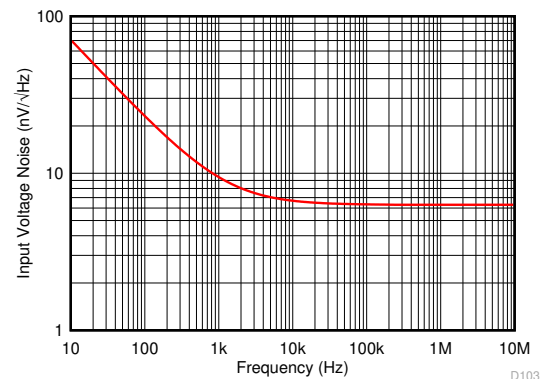

Measured then fit to ideal 1/f model

Figure 7-47. Input Voltage Noise Density vs Frequency

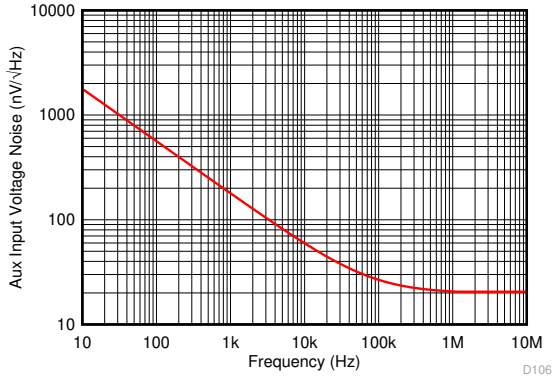

Measured then fit to ideal 1/f model

Figure 7-48. Auxiliary Input Stage Voltage Noise Density vs Frequency

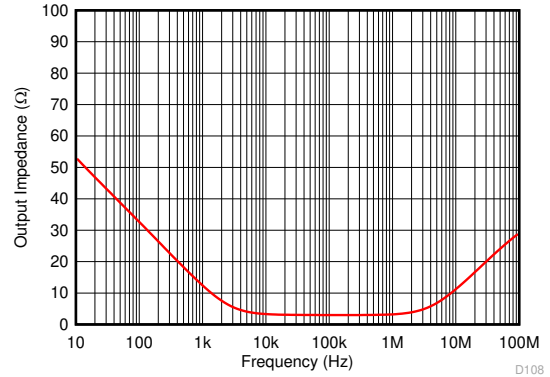
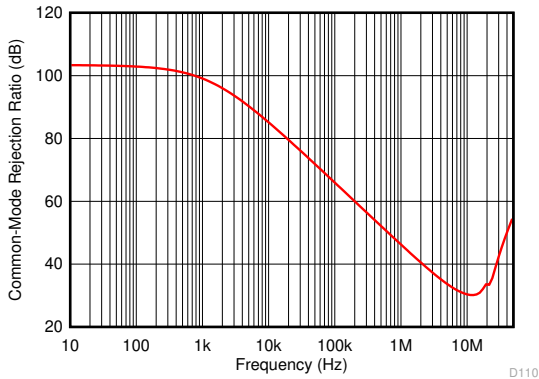
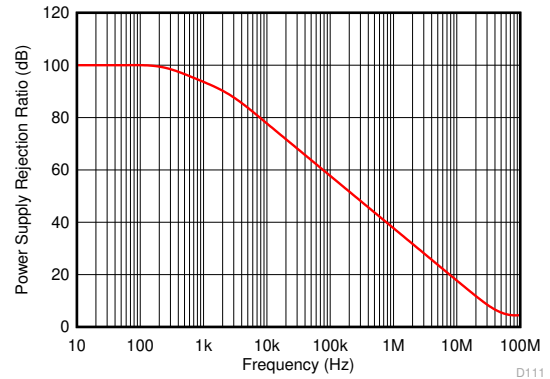

Figure 7-49. Open-Loop Output Impedance vs Frequency



$V_S = 10\text{ V and }24\text{ V}$

Figure 7-50. Common-Mode Rejection Ratio vs Frequency



$V_S = 5\text{ V and }10\text{ V}$

Figure 7-51. Power Supply Rejection Ratio vs Frequency

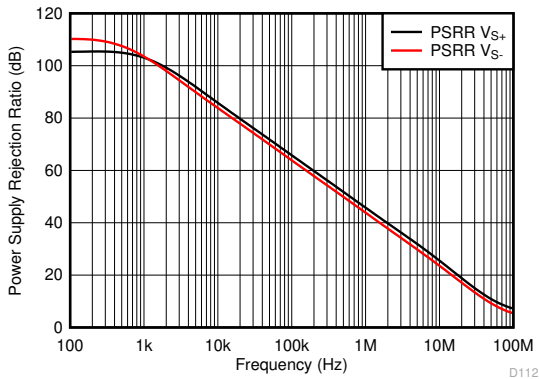

Simulated curves, $V_S = 24\text{ V}$

Figure 7-52. Power Supply Rejection Ratio vs Frequency

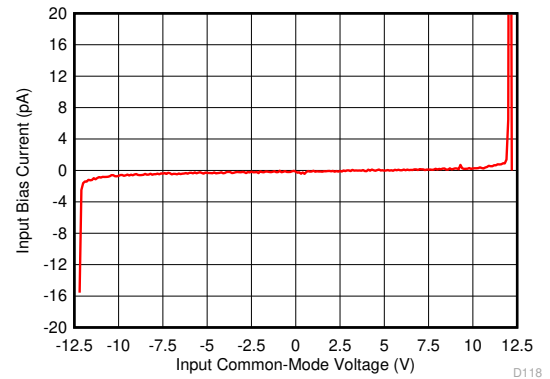

$V_S = \pm 12\text{ V}$

Figure 7-53. Input Bias Current vs Input Common-Mode Voltage

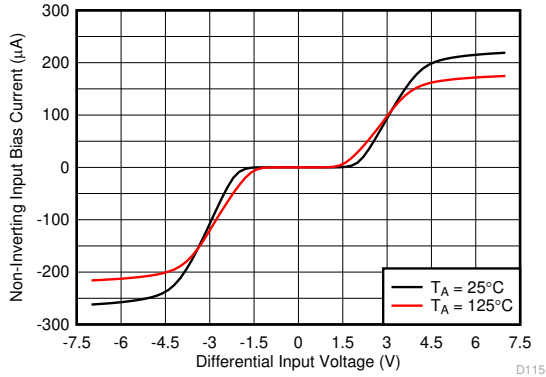

Abs ($V_{IN,Diff(max)}$) = V_S when $V_S < 7\text{ V}$

Figure 7-54. Input Bias Current vs Differential Input Voltage

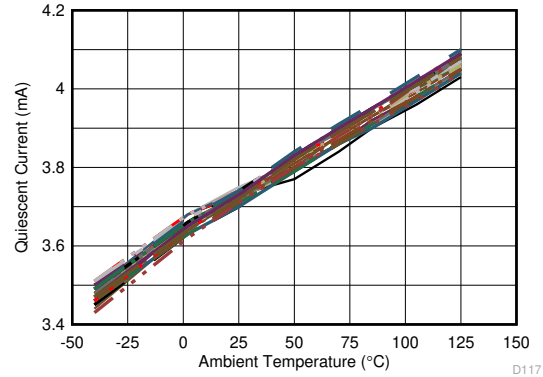

32 units, SOIC package, $V_S = \pm 5\text{ V}$

Figure 7-55. Quiescent Current vs Ambient Temperature

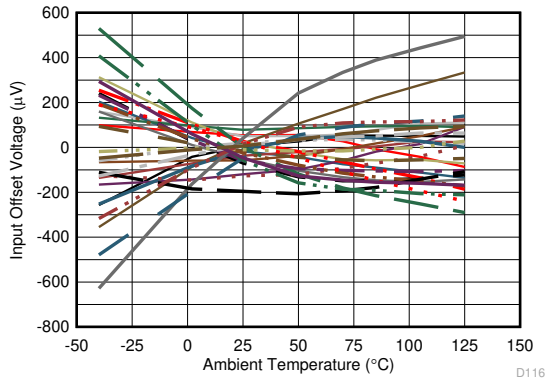

32 units, SOIC package

Figure 7-56. Input Offset Voltage vs Ambient Temperature

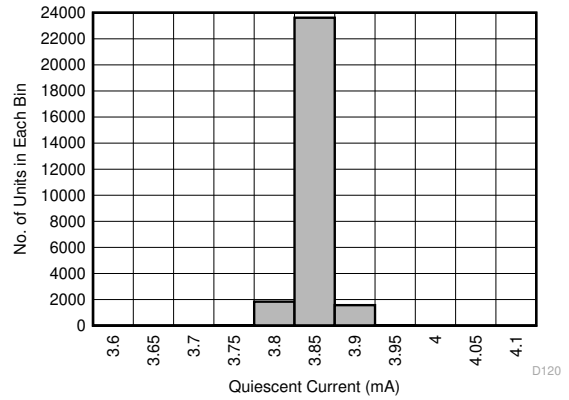

27000 units, $\mu = 3.82\text{ mA}$, $\sigma = 17\text{ }\mu\text{A}$, $V_S = 24\text{ V}$

Figure 7-57. Quiescent Current Distribution

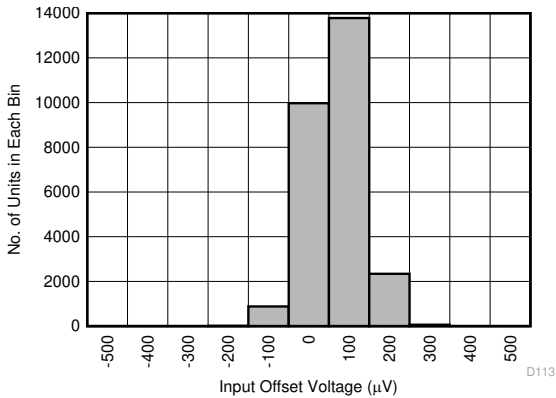

27000 units, $\mu = 16\text{ }\mu\text{V}$, $\sigma = 63\text{ }\mu\text{V}$, $V_S = 24\text{ V}$

Figure 7-58. Input Offset Voltage Distribution

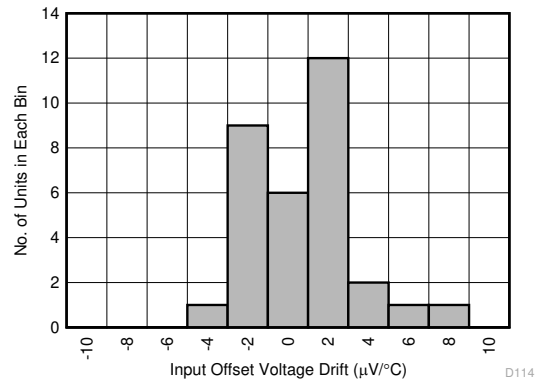

-40°C to $+125^\circ\text{C}$ fit, 32 units, $\mu = -0.15\text{ }\mu\text{V}/^\circ\text{C}$, $\sigma = 2.5\text{ }\mu\text{V}/^\circ\text{C}$

Figure 7-59. Input Offset Voltage Drift Distribution

8 Detailed Description

8.1 Overview

The OPA810 is a single-channel, field-effect transistor (FET)-input, unity-gain stable, voltage-feedback operational amplifier with extremely low input bias current across its common-mode input voltage range. The OPA810, characterized to operate over a wide supply range of 4.75 V to 27 V, has a small-signal, unity-gain bandwidth of 140 MHz and offers both excellent DC precision and dynamic AC performance at low quiescent power. The OPA810 is fabricated on Texas Instrument's proprietary, high-speed SiGe BiCMOS process and achieves significant performance improvements over comparable FET-input amplifiers at similar levels of quiescent power. With a gain-bandwidth product (GBWP) of 70 MHz, extremely high slew rate (200 V/ μ s), and low noise (6.3 nV/ $\sqrt{\text{Hz}}$), the OPA810 is ideal in a wide range of data acquisition and signal processing applications. The OPA810 includes input clamps to allow maximum input differential voltage of up to 7 V, making the device suitable for use with multiplexers and for processing signals with fast transients. The device achieves these benchmark levels of performance while consuming a typical quiescent current (I_Q) of 3.7 mA per channel.

The OPA810 can source and sink large amounts of current without degradation in its linearity performance. The wide bandwidth of the OPA810 implies that the device has low output impedance across a wide frequency range, thereby allowing the amplifier to drive capacitive loads up to 10 pF without requiring output isolation. This device is suitable for a wide range of data acquisition, test and measurement front-end buffer, impedance measurement, power analyzer, wideband photodiode transimpedance, and signal processing applications.

8.2 Functional Block Diagram

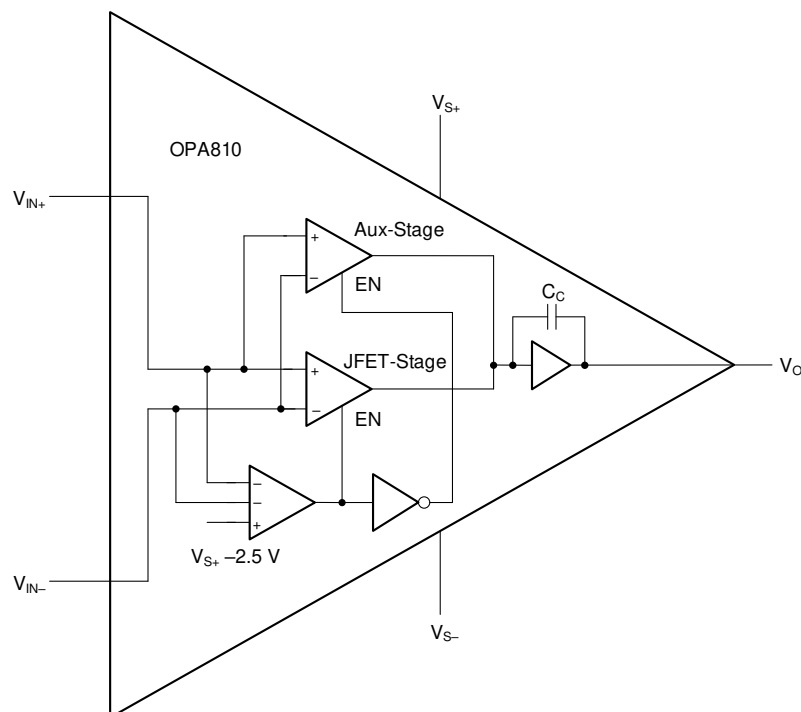

8.3 Feature Description

8.3.1 OPA810 Architecture

The OPA810 features a true high-impedance input stage including a JFET differential-input pair main stage and a CMOS differential-input auxiliary (aux) stage operational within 2.5 V of the positive supply voltage. The bias current is limited to a maximum of 20 pA throughout the common-mode input range of the amplifier. The [Section 8.2](#) section provides a block diagram representation for the input stage of the OPA810. The amplifier exhibits superior performance for high-speed signals (distortion, noise, and input offset voltage) while the aux stage enables rail-to-rail inputs and prevents phase reversal. The device exhibits a CMRR and PSRR of 75 dB (typical) when the input common-mode is in aux stage.

The OPA810 also includes input clamps that enable the maximum input differential voltage of up to 7 V (lower of 7 V and total supply voltage). This architecture offers significantly greater differential input voltage capability as compared to one to two times the diode forward voltage drop maximum rating in standard amplifiers, and makes this device suitable for use with multiplexers and processing of signals with fast transients. The input bias currents are also clamped to maximum 300 μ A, as [Figure 7-54](#) shows, which does not load the previous driver stage or require current-limiting resistors (except limiting current through the input ESD diodes when input common-mode voltages are greater than the supply voltages). This feature also enables this amplifier to be used as a comparator in systems that require an amplifier and a comparator for signal gain and fault detection, respectively. For the lowest offset, distortion, and noise performance, limit the common-mode input voltage to the main JFET-input stage (greater than 2.5 V away from the positive supply).

The OPA810 is a rail-to-rail output amplifier and swings to either of the rails at the output, as shown in [Figure 7-15](#) for 10-V supply operation. This is particularly useful for inputs biased near the rails or when the amplifier is configured in a closed-loop gain such that the output approaches the supply voltage. When the output saturates, it recovers with 55 ns when inputs exceed the supply voltages by 0.5 V in an $G = -1$ V/V inverting gain with a 10-V supply. The outputs are short-circuit protected with the limits of [Figure 7-16](#).

As [Figure 8-1](#) shows, an amplifier phase margin reduces and becomes unstable when driving a capacitive load (C_L) at its output. Using a series resistor (R_S) between the amplifier output and load capacitance introduces a zero that cancels the pole formed by the amplifier output impedance and C_L in the open-loop transfer function. The OPA810 drives capacitive loads of up to 10 pF without causing instability. It is recommended to use a series resistor for larger load capacitance values, as [Figure 7-3](#) shows for OPA810 configured as a unity-gain buffer. As [Figure 7-4](#) shows, when used in a gain larger than 1 V/V, the OPA810 is able to drive a load capacitance larger than 10 pF without the need for a series resistor at its output.

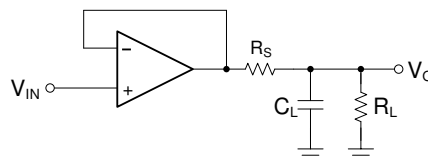

Figure 8-1. OPA810 Driving Capacitive Load

8.3.2 ESD Protection

As [Figure 8-2](#) shows, all device pins are protected with internal ESD protection diodes to the power supplies. These diodes provide moderate protection to input overdrive voltages above the supplies. The protection diodes can typically support 10-mA continuous input and output currents. The differential input clamps only limit the bias current when the input common-mode voltages are within the supply voltage range, whereas current-limiting series resistors must be added at the inputs if common-mode voltages higher than the supply voltages are possible. Keep these resistor values as low as possible because using high values degrades noise performance and frequency response.

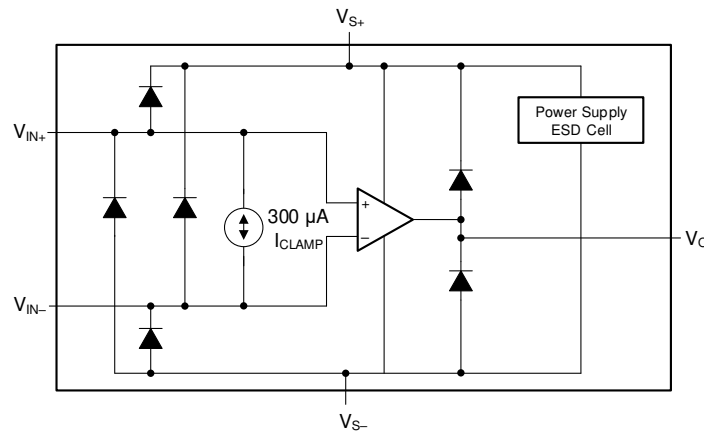

Figure 8-2. Internal ESD Protection

8.4 Device Functional Modes

8.4.1 Split-Supply Operation (± 2.375 V to ± 13.5 V)

To facilitate testing with common lab equipment, the OPA810 can be configured to allow for split-supply operation (see the [OPA2810DGK Evaluation Module user guide](#)). This configuration eases lab testing because the mid-point between the power rails is ground, and most signal generators, network analyzers, oscilloscopes, spectrum analyzers, and other lab equipment reference the inputs and outputs to ground. [Figure 9-1](#) depicts the OPA810 configured as a noninverting amplifier and [Figure 9-2](#) illustrates the OPA810 configured as an inverting amplifier. For split-supply operation referenced to ground, the power supplies V_{S+} and V_{S-} are symmetrical around ground and V_{REF} is at GND. Split-supply operation is preferred in systems where the signals swing around ground because of the ease-of-use; however, the system requires two supply rails.

8.4.2 Single-Supply Operation (4.75 V to 27 V)

Many newer systems use a single power supply to improve efficiency and reduce the cost of the extra power supply. The OPA810 can be used with a single supply (with the negative supply set to ground) with no change in performance if the input and output are biased within the linear operation of the device. To change the circuit from split supply to a balanced, single-supply configuration, level shift all voltages by half the difference between the power-supply rails. An additional advantage of configuring an amplifier for single-supply operation is that the effects of PSRR are minimized because the low-supply rail is grounded. See the [Single-Supply Op Amp Design Techniques application report](#) for examples of single-supply designs.

9 Application and Implementation

Note

Information in the following applications sections is not part of the TI component specification, and TI does not warrant its accuracy or completeness. TI's customers are responsible for determining suitability of components for their purposes. Customers should validate and test their design implementation to confirm system functionality.

9.1 Application Information

9.1.1 Amplifier Gain Configurations

The OPA810 is a classic voltage-feedback amplifier with each channel having two high-impedance inputs and a low-impedance output. Standard application circuits (as shown in [Figure 9-1](#) and [Figure 9-2](#)) include the noninverting and inverting gain configurations. The DC operating point for each configuration is level-shifted by the reference voltage V_{REF} that is typically set to midsupply in single-supply operation. V_{REF} is often connected to ground in split-supply applications.

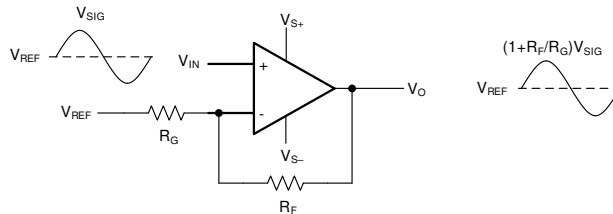

Figure 9-1. Noninverting Amplifier

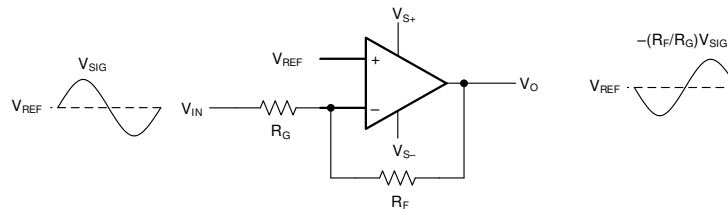

Figure 9-2. Inverting Amplifier

[Equation 1](#) shows the closed-loop gain of an amplifier in a noninverting configuration.

$$V_O = V_{IN} \left(1 + \frac{R_F}{R_G} \right) + V_{REF} \quad (1)$$

[Equation 2](#) shows the closed-loop gain of an amplifier in an inverting configuration.

$$V_O = V_{IN} \left(-\frac{R_F}{R_G} \right) + V_{REF} \quad (2)$$

9.1.2 Selection of Feedback Resistors

The OPA810 is a classic voltage feedback amplifier with each channel having two high-impedance inputs and a low-impedance output. Standard application circuits (as shown in [Figure 9-3](#) and [Figure 9-4](#)) include the noninverting and inverting gain configurations. The DC operating point for each configuration is level-shifted by the reference voltage V_{REF} which is typically set to midsupply in single-supply operation. V_{REF} is often connected to ground in split-supply applications.

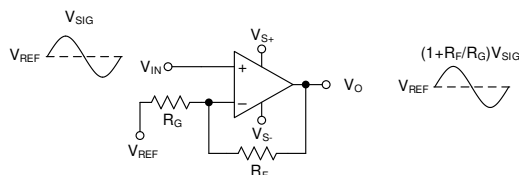

Figure 9-3. Noninverting Amplifier

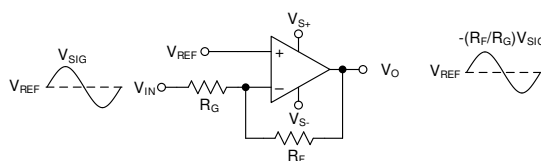

Figure 9-4. Inverting Amplifier

[Equation 3](#) shows the closed-loop gain of an amplifier in noninverting configuration.

$$V_O = V_{IN} \left(1 + \frac{R_F}{R_G} \right) + V_{REF} \quad (3)$$

[Equation 4](#) shows the closed-loop gain of an amplifier in an inverting configuration.

$$V_O = V_{IN} \left(-\frac{R_F}{R_G} \right) + V_{REF} \quad (4)$$

The magnitude of the low-frequency gain is determined by the ratio of the magnitudes of the feedback resistor (R_F) and the gain setting resistor R_G . The order of magnitudes of the individual values of R_F and R_G offer a trade-off between amplifier stability, power dissipated in the feedback resistor network, and total output noise. The feedback network increases the loading on the amplifier output. Using large values of the feedback resistors reduces the power dissipated at the amplifier output. On the other hand, this increases the inherent voltage and amplifier current noise contribution seen at the output while lowering the frequency at which a pole occurs in the feedback factor (β). This pole causes a decrease in the phase margin at zero-gain crossover frequency and potential instability. Using small feedback resistors increases power dissipation and also degrades amplifier linearity due to a heavier amplifier output load. [Figure 9-5](#) illustrates a representative schematic of the OPA810 in an inverting configuration with the input capacitors shown.

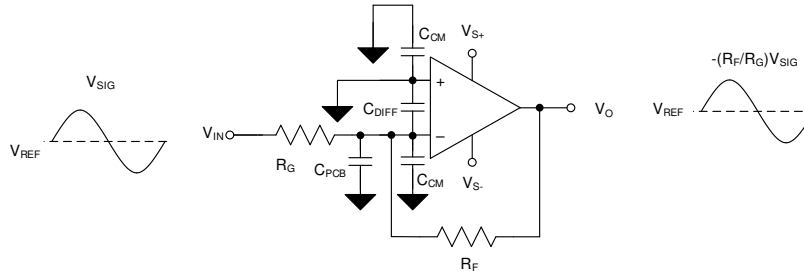

Figure 9-5. Inverting Amplifier with Input Capacitors

The effective capacitance at the amplifier inverting input pin is shown in Equation 5, which forms a pole in β at a cut-off frequency of Equation 6.

$$C_{IN} = C_{CM} + C_{DIFF} + C_{PCB} \quad (5)$$

where

- C_{CM} is the amplifier common-mode input capacitance
- C_{DIFF} is the amplifier differential input capacitance
- C_{PCB} is the PCB parasitic capacitance

$$F_C = \frac{1}{2\pi R_F C_{IN}} \quad (6)$$

For low-power systems, greater the values of the feedback resistors, the earlier in frequency does the phase margin begin to reduce and cause instability. Figure 9-6 and Figure 9-7 illustrate the loop gain magnitude and phase plots, respectively, for the OPA810 simulation in TINA-TI configured as an inverting amplifier with values of feedback resistors varying by orders of magnitudes.

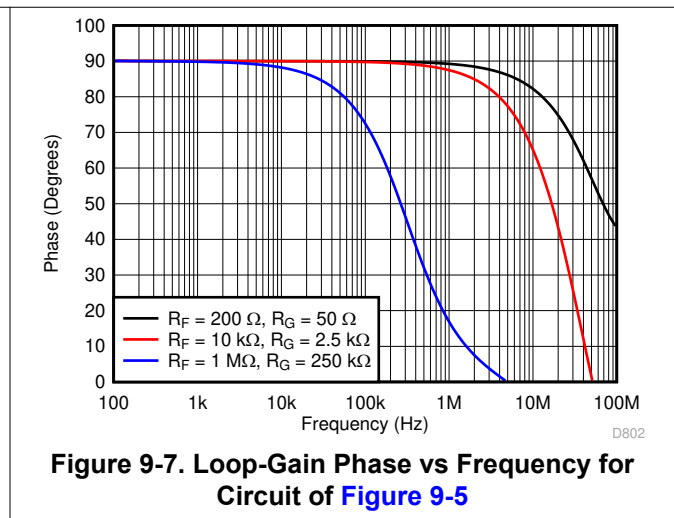
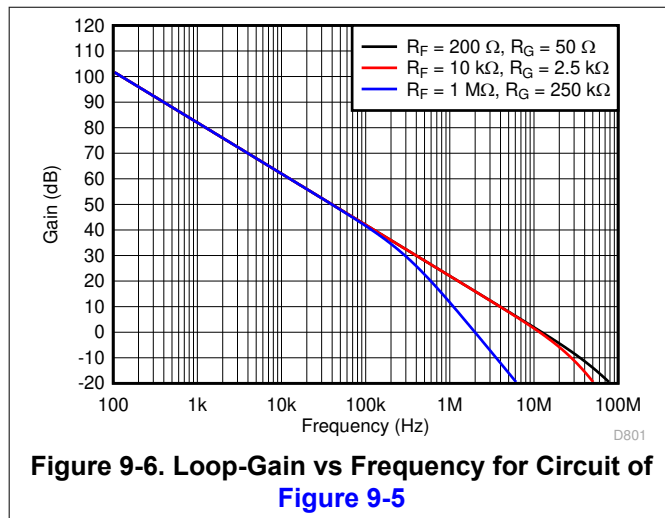

A lower phase margin results in peaking in the frequency response and lower bandwidth as Figure 9-8 shows, which is synonymous with overshoot and ringing in the pulse response results. The OPA810 offers a flat-band voltage noise density of $6.3 \text{ nV}/\sqrt{\text{Hz}}$. TI recommends selecting an R_F so the voltage noise contribution does not exceed that of the amplifier. Figure 9-9 shows the voltage noise density variation with value of resistance at 25°C . A $2\text{-k}\Omega$ resistor exhibits a thermal noise density of $5.75 \text{ nV}/\sqrt{\text{Hz}}$ which is comparable to the flatband noise of the OPA810. Hence, TI recommends using an R_F lower than $2 \text{ k}\Omega$ while being large enough to not dissipate

excessive power for the output voltage swing and supply current requirements of the application. The [Section 9.1.3](#) section shows a detailed analysis of the various contributors to noise.

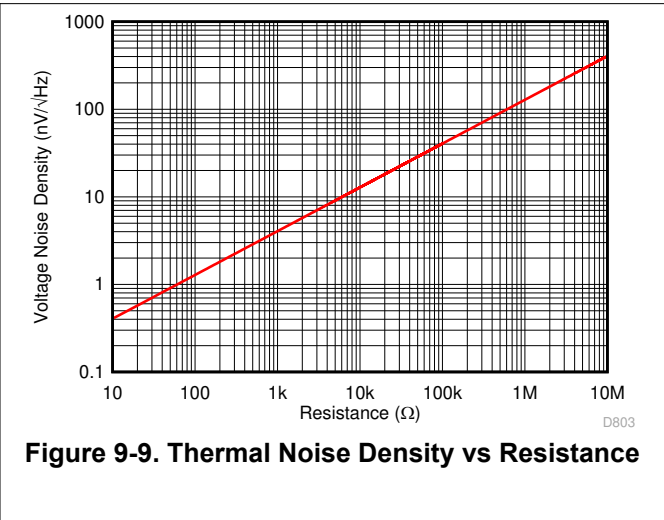
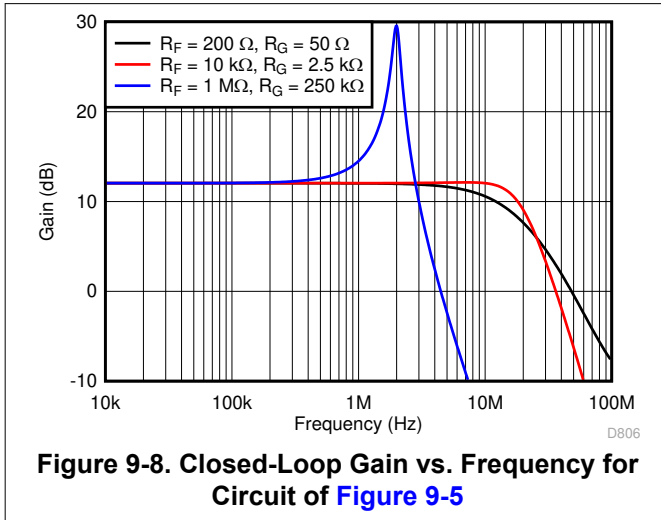

9.1.3 Noise Analysis and the Effect of Resistor Elements on Total Noise

The OPA810 provides a low input-referred broadband noise voltage density of 6.3 nV/√Hz while requiring a low 3.7-mA quiescent supply current. To take full advantage of this low input noise, careful attention to the other possible noise contributors is required. [Figure 9-10](#) shows the operational amplifier noise analysis model with all the noise terms included. In this model, all the noise terms are taken to be noise voltage or current density terms in nV/√Hz or pA/√Hz.

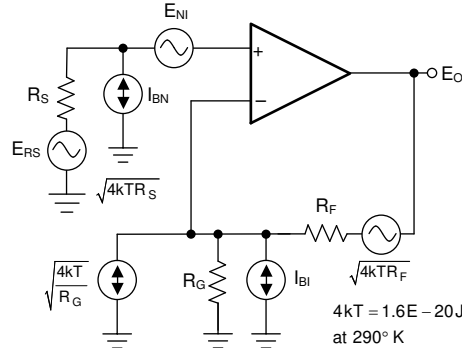

Figure 9-10. Operational Amplifier Noise Analysis Model

The total output spot noise voltage is computed as the square root of the squared contributing terms to the output noise voltage. This computation adds all the contributing noise powers at the output by superposition, then calculates the square root to get back to a spot noise voltage. [Figure 9-10](#) shows the general form for this output noise voltage using the terms shown in [Equation 7](#).

$$E_O = \sqrt{\left(E_{NI}^2 + (I_{BN}R_S)^2 + 4kTR_S\right)NG^2 + (I_{BI}R_F)^2 + 4kTR_F} \quad (7)$$

Dividing this expression by the noise gain ($NG = 1 + R_F / R_G$) shows the equivalent input referred spot noise voltage at the noninverting input; see [Equation 8](#).

$$E_N = \sqrt{E_{NI}^2 + (I_{BN}R_S)^2 + 4kTR_S + \left(\frac{I_{BI}R_F}{NG}\right)^2 + \frac{4kTR_F}{NG}} \quad (8)$$

Substituting large resistor values into Equation 8 can quickly dominate the total equivalent input referred noise. A source impedance on the noninverting input of 2-kΩ adds a Johnson voltage noise term similar to that of the amplifier (6.3 nV/√ Hz).

Table 9-1 compares the noise contributions from the various terms when the OPA810 is configured in a noninverting gain of 5 V/V as Figure 9-11 shows. Two cases are considered where the resistor values in case 2 are 10x the resistor values in case 1. The total output noise in case 1 is 34 nV/√ Hz while the noise in case 2 is 51.5 nV/√ Hz. The large value resistors in case 2 dilute the benefits of selecting a low noise amplifier like the OPA810. To minimize total system noise, reduce the size of the resistor values. This increases the amplifiers output load and results in a degradation of distortion performance. The increased loading increases the dynamic power consumption of the amplifier. The circuit designer must make the appropriate tradeoffs to maximize the overall performance of the amplifier to match the system requirements.

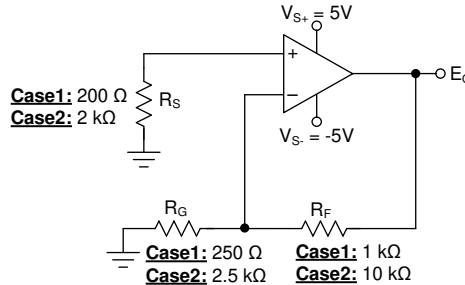

Figure 9-11. Comparing Noise Contributors for Two Cases with the Amplifier in a Noninverting Gain of 5 V/V

Table 9-1. Comparing Noise Contributions for the Circuit in Figure 9-11

| NOISE SOURCE | OUTPUT NOISE EQUATION | CASE 1 | | | | CASE 2 | | | |
|---------------------------------|------------------------------|--------------------|--------------------------------------|--|------------------|--------------------|--------------------------------------|--|------------------|
| | | NOISE SOURCE VALUE | VOLTAGE NOISE CONTRIBUTION (nV/√ Hz) | NOISE POWER CONTRIBUTION (nV ² /Hz) | CONTRIBUTION (%) | NOISE SOURCE VALUE | VOLTAGE NOISE CONTRIBUTION (nV/√ Hz) | NOISE POWER CONTRIBUTION (nV ² /Hz) | CONTRIBUTION (%) |
| Source resistor, RS | $E_{RS} (1 + R_F / R_G)$ | 1.82 nV/√ Hz | 9.1 | 82.81 | 7.15 | 5.76 nV/√ Hz | 28.8 | 829.44 | 31.29 |
| Gain resistor, RG | $E_{RG} (R_F / R_G)$ | 2.04 nV/√ Hz | 8.16 | 66.59 | 5.75 | 6.44 nV/√ Hz | 25.76 | 663.58 | 25.03 |
| Feedback resistor, RF | E_{RF} | 4.07 nV/√ Hz | 4.07 | 16.57 | 1.43 | 12.87 nV/√ Hz | 12.87 | 165.64 | 6.25 |
| Amplifier voltage noise, ENI | $E_{NI} (1 + R_F / R_G)$ | 6.3 nV/√ Hz | 31.5 | 992.25 | 85.67 | 6.3 nV/√ Hz | 31.5 | 992.25 | 37.43 |
| Inverting current noise, IBI | $I_{BI} (R_F R_G)$ | 5 fA/√ Hz | 5.0E-3 | — | — | 5 fA/√ Hz | 50E-3 | — | — |
| Noninverting current noise, IBN | $I_{BN} R_S (1 + R_F / R_G)$ | 5 fA/√ Hz | 1.0E-3 | — | — | 5 fA/√ Hz | 10E-3 | — | — |

9.2 Typical Applications

9.2.1 Transimpedance Amplifier

The high GBWP and low input voltage and current noise for the OPA810 make the device an ideal wideband transimpedance amplifier for moderate to high transimpedance gains.

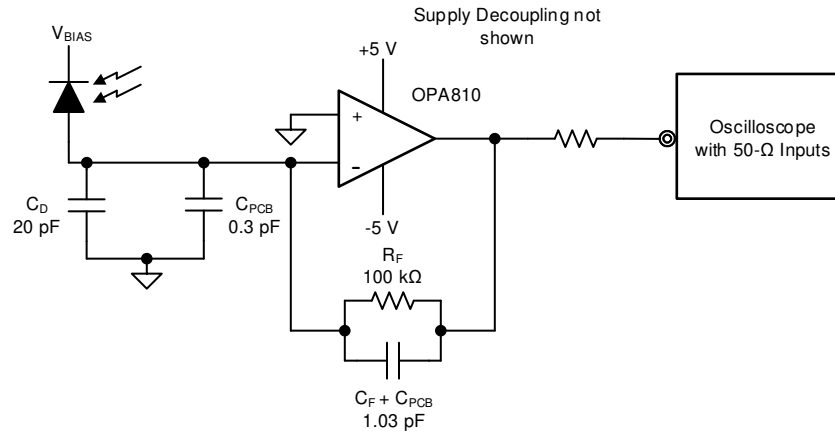

Figure 9-12. Wideband, High-Sensitivity, Transimpedance Amplifier

9.2.1.1 Design Requirements

Table 9-2 lists the design requirements for a high-bandwidth, high-gain transimpedance amplifier circuit.

Table 9-2. Design Requirements

| PARAMETER | DESIGN REQUIREMENT |
|------------------------|--------------------|
| Target bandwidth | > 2 MHz |
| Transimpedance gain | 100 kΩ |
| Photodiode capacitance | 20 pF |

9.2.1.2 Detailed Design Procedure

Designs that require high bandwidth from a large area detector with relatively high transimpedance gain benefit from the low input voltage noise of the OPA810. This input voltage noise is peaked up over frequency by the diode source capacitance, and can (in many cases) become the limiting factor to input sensitivity. The key elements to the design are the expected diode capacitance (C_D) with the reverse bias voltage (V_{BIAS}) applied, the desired transimpedance gain, R_F , and the GBWP for the OPA810 (70 MHz). Figure 9-12 shows a transimpedance circuit with the parameters as described in Table 9-2. With these three variables set (and including the parasitic input capacitance for the OPA810 and the printed circuit board (PCB) added to C_D), the feedback capacitor value (C_F) can be set to control the frequency response. The [Transimpedance Considerations for High-Speed Amplifiers application report](#) discusses using high-speed amplifiers for transimpedance applications. Set the feedback pole according to Equation 9 in order to achieve a maximally-flat second-order Butterworth frequency response:

$$\frac{1}{2\pi R_F C_F} = \sqrt{\frac{GBWP}{4\pi R_F C_D}} \quad (9)$$

The input capacitance of the amplifier is the sum of the common-mode and differential capacitance (2.0 + 0.5) pF. The parasitic capacitance from the photodiode package and the PCB is approximately 0.3 pF. Using Equation 5 gives a total input capacitance of $C_D = 22.8$ pF. From Equation 9, set the feedback pole at 1.55 MHz. Setting the pole at 1.55 MHz requires a total feedback capacitance of 1.03 pF.

Equation 10 shows the approximate –3-dB bandwidth of the transimpedance amplifier circuit:

$$f_{-3dB} = \sqrt{GBWP / (2\pi R_F C_D)} Hz \tag{10}$$

Equation 10 estimates a closed-loop bandwidth of 2.19 MHz. Figure 9-13 and Figure 9-14 show the loop-gain magnitude and phase plots from the TINA-TI simulations of the transimpedance amplifier circuit of Figure 9-12. The $1/\beta$ gain curve has a zero from R_F and C_{IN} at 70 kHz and a pole from R_F and C_F cancelling the $1/\beta$ zero at 1.5 MHz, resulting in a 20-dB per decade rate-of-closure at the loop-gain crossover frequency (the frequency where A_{OL} equals $1/\beta$), ensuring a stable circuit. A phase margin of 62° is obtained with a closed-loop bandwidth of 3 MHz and a 100-k Ω transimpedance gain.

9.2.1.3 Application Curves

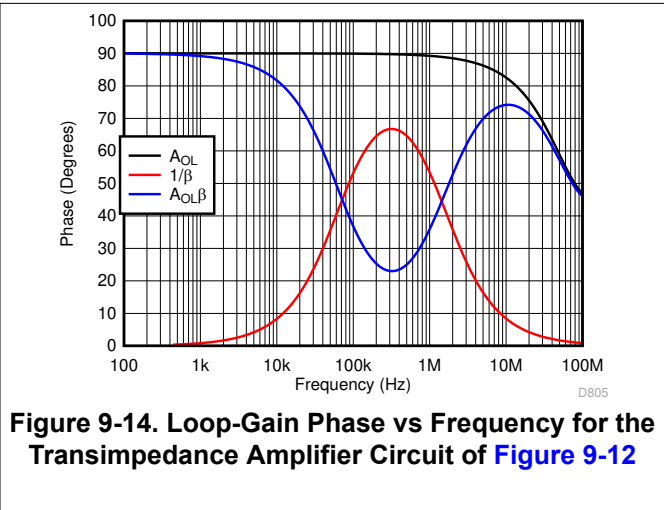
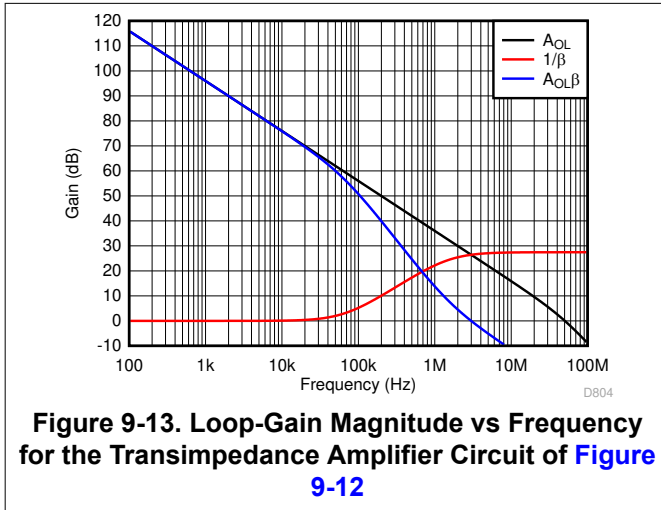

9.2.2 High-Z Input Data Acquisition Front-End

An ideal data acquisition system must measure a parameter without altering the measurand. When measuring a voltage or current from sensors with a large output impedance, an extremely high input impedance front-end with a pA range bias current is needed. [Figure 9-15](#) shows an example circuit with the OPA810 used at the front-end. For systems with large input voltage attenuated with the MΩ range resistor divider, the OPA810 with its pA range bias currents adds negligible offset voltage and distortion because of the bias current induced resistor voltage drops. This circuit shows a funneling architecture with the OPA810 FET-input amplifier used as a unity-gain buffer, followed by attenuation to the [ADS9110](#) 5-V, full-scale input range and the ADC input drive using the [THS4561](#) fully-differential amplifier (FDA). The THS4561 helps achieve better SNR and ENOB than a similar 5-V FDA, with a higher 12.6-V supply voltage and signal swings up to the ADC full-scale input range.

As a result of the capacitive switching and current inrush on the ADC VREF input pin, a wide bandwidth amplifier such as the [OPA837](#) is used with the [OPA378](#) in a composite loop as a reference buffer. The [OPA378](#), driven from the [REF5050](#) 5-V voltage reference, offers high precision and the [OPA837](#) gives fast-settling performance for the ADC reference input drive. See the [Reference Design Maximizing Signal Dynamic Range for True 10 Vpp Differential Input to 20 bit ADC design guide](#) for more a detailed analysis of this high-Z front-end.

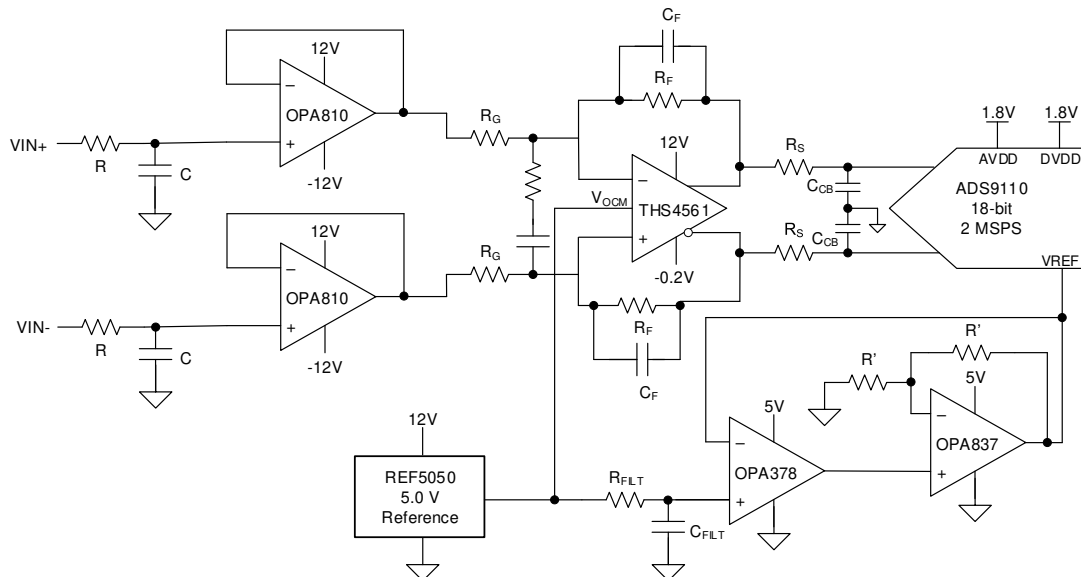

Figure 9-15. High-Z Input Data Acquisition Front-End

9.2.3 Multichannel Sensor Interface

High-Z input amplifiers are particularly useful when interfaced with sensors that have relatively high output impedance. Such multichannel systems usually interface these sensors with the signal chain through a multiplexer. Figure 9-16 shows one such implementation using an amplifier for the interface with each sensor, and driving into an ADC through a multiplexer. An alternate circuit, shown in Figure 9-17, can use a single higher GBWP and fast-settling amplifier at the output of the multiplexer. This architecture gives rise to large signal transients when switching between channels, where the settling performance of the amplifier and maximum allowed differential input voltage limits signal chain performance and amplifier reliability, respectively.

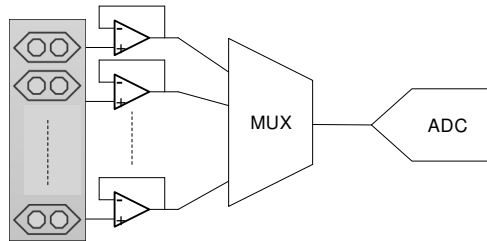

Figure 9-16. Multichannel Sensor Interface Using Multiple Amplifiers

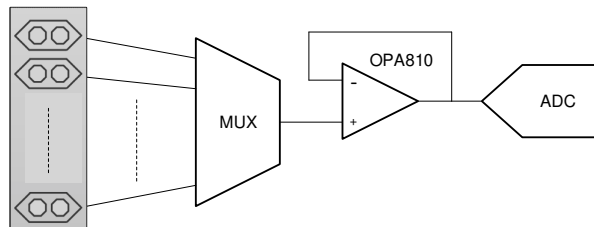
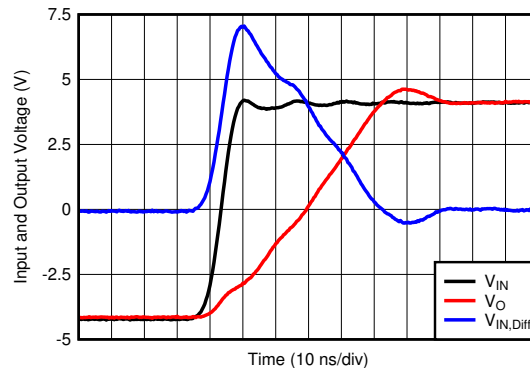

Figure 9-17. Multichannel Sensor Interface Using a Single Higher GBWP Amplifier

Figure 9-18 shows the output voltage and input differential voltage when a 8-V step is applied at the noninverting terminal of the OPA810 configured as a unity-gain buffer of Figure 9-17.



BD_M

Figure 9-18. Large-Signal Transient Response Using the OPA810

Because of the fast input transient, the amplifier is slew-limited and the inputs cease to track each other (a maximum $V_{IN,Diff}$ of 7 V is shown in Figure 9-18) until the output reaches its final value and the negative feedback loop is closed. For standard amplifiers with a 0.7-V to 1.5-V maximum $V_{IN,Diff}$ rating, current-limiting resistors must be used in series with the input pins to protect the device from irreversible damage, which also limits the device frequency response. The OPA810 has built-in input clamps that allow the application of as much as 7 V of $V_{IN,Diff}$, with no external resistors required and no damage to the device or a shift in performance specifications. Such an input-stage architecture, coupled with its fast settling performance, makes the OPA810 a good fit for multichannel sensor multiplexed systems.

10 Power Supply Recommendations

The OPA810 is intended for operation on supplies ranging from 4.75 V to 27 V. The OPA810 can be operated on single-sided supplies, split and balanced bipolar supplies, or unbalanced bipolar supplies. Operating from a single supply can have numerous advantages. With the negative supply at ground, the DC errors resulting from the $-PSRR$ term can be minimized. Typically, AC performance improves slightly at 10-V operation with minimal increase in supply current. Minimize the distance (< 0.1 in) from the power-supply pins to high-frequency, 0.01- μF decoupling capacitors. A larger capacitor (2.2 μF typical) is used along with a high-frequency, 0.01- μF , supply-decoupling capacitor at the device supply pins. For single-supply operation, only the positive supply has these capacitors. When a split supply is used, use these capacitors from each supply to ground. If necessary, place the larger capacitors further from the device and share these capacitors among several devices in the same area of the printed circuit board (PCB). An optional supply decoupling capacitor across the two power supplies (for split-supply operation) reduces second harmonic distortion.

11 Layout

11.1 Layout Guidelines

Achieving optimum performance with a high-frequency amplifier such as the OPA810 requires careful attention to board layout parasitics and external component types. The [OPA2810EVM](#) can be used as a reference when designing the circuit board. Recommendations that optimize performance include:

1. **Minimize parasitic capacitance** to any AC ground for all signal I/O pins. Parasitic capacitance on the output and inverting input pins can cause instability—on the noninverting input, this capacitance can react with the source impedance to cause unintentional band-limiting. To reduce unwanted capacitance, open a window around the signal I/O pins in all ground and power planes around those pins. Otherwise, ground and power planes must be unbroken elsewhere on the board.
2. **Minimize the distance** (< 0.1 in) from the power-supply pins to high-frequency, 0.01- μF decoupling capacitors. At the device pins, do not allow the ground and power plane layout to be in close proximity to the signal I/O pins. Avoid narrow power and ground traces to minimize inductance between the pins and the decoupling capacitors. The power-supply connections must always be decoupled with these capacitors. Larger (2.2- μF to 6.8- μF) decoupling capacitors, effective at lower frequency, must also be used on the supply pins. These capacitors can be placed somewhat farther from the device and shared among several devices in the same area of the PC board.
3. **Careful selection and placement of external components preserve the high-frequency performance of the OPA810.** Resistors must be a low reactance type. Surface-mount resistors work best and allow a tighter overall layout. Metal film and carbon composition axially leaded resistors can also provide good high-frequency performance. Again, keep their leads and PCB trace length as short as possible. Never use wirewound type resistors in a high-frequency application. Because the output pin and inverting input pin are the most sensitive to parasitic capacitance, always position the feedback and series output resistor, if any, as close as possible to the output pin. Other network components, such as noninverting input termination resistors, must also be placed close to the package. Even with a low parasitic capacitance shunting the external resistors, excessively high resistor values can create significant time constants that can degrade performance. Good axial metal film or surface-mount resistors have approximately 0.2 pF in shunt with the resistor. For resistor values greater than 10 k Ω , this parasitic capacitance can add a pole or zero close to the GBWP of 70 MHz and subsequently affects circuit operation. Keep resistor values as low as possible and consistent with load driving considerations. Lowering the resistor values keeps the resistor noise terms low, and minimizes the effect of parasitic capacitance, however lower resistor values increase the dynamic power consumption because R_F and R_G become part of the amplifiers output load network. Transimpedance applications (see the [Section 9.2.1](#) section) can use whatever feedback resistor is required by the application as long as the feedback compensation capacitor is set considering all parasitic capacitance terms on the inverting node.

4. **Connections to other wideband devices** on the board can be made with short direct traces or through onboard transmission lines. For short connections, consider the trace and the input to the next device as a lumped capacitive load. Relatively wide traces (50 mils to 100 mils) must be used, preferably with ground and power planes opened up around them. Estimate the total capacitive load and set R_S for sufficient phase margin and stability. Low parasitic capacitive loads (< 10 pF) may not need an R_S because the OPA810 is nominally compensated to operate with a 10-pF parasitic load. Higher parasitic capacitive loads without an R_S are allowed with increase in signal gain (increasing the unloaded phase margin). If a long trace is required, and the 6-dB signal loss intrinsic to a doubly-terminated transmission line is acceptable, implement a matched impedance transmission line using microstrip or stripline techniques (consult an ECL design handbook for microstrip and stripline layout techniques). A 50- Ω environment is normally not necessary onboard, and a higher impedance environment improves distortion. With a characteristic board trace impedance defined based on board material and trace dimensions, a matching series resistor into the trace from the output of the OPA810 is used as well as a terminating shunt resistor at the input of the destination device. Remember also that the terminating impedance is the parallel combination of the shunt resistor and the input impedance of the destination device—this total effective impedance must be set to match the trace impedance. If the 6-dB attenuation of a doubly-terminated transmission line is unacceptable, a long trace can be series-terminated at the source end only. Treat the trace as a capacitive load in this case and set the series resistor value to obtain sufficient phase margin and stability. This does not preserve signal integrity as well as a doubly-terminated line. If the input impedance of the destination device is low, the signal attenuates because of the voltage divider formed by the series output into the terminating impedance.
5. **Take care to design the PCB layout for optimal thermal dissipation.** For the extreme case of 125°C operating ambient, using the approximate 134.8°C/W for the SOIC package, and an internal power of 24-V supply \times 4.7-mA 125°C supply current gives a maximum internal power dissipation of 113 mW. This power gives a 15°C increase from ambient to junction temperature. Load power adds to this value and this dissipation must also be calculated to determine the worst-case safe operating point.
6. **Socketing a high-speed device such as the OPA810 is not recommended.** The additional lead length and pin-to-pin capacitance introduced by the socket can create an extremely troublesome parasitic network that can almost make achieving a smooth, stable frequency response impossible. Best results are obtained by soldering the OPA810 onto the board.

11.1.1 Thermal Considerations

The OPA810 does not require heat sinking or airflow in most applications. Maximum allowed junction temperature sets the maximum allowed internal power dissipation. Do not allow the maximum junction temperature to exceed 150°C.

Operating junction temperature (T_J) is given by $T_A + P_D \times \theta_{JA}$. The total internal power dissipation (P_D) is the sum of quiescent power (P_{DQ}) and additional power dissipated in the output stage (P_{DL}) to deliver load power. Quiescent power is the specified no-load supply current times the total supply voltage across the part. P_{DL} depends on the required output signal and load but would, for a grounded resistive load, be at a maximum when the output is fixed at a voltage equal to half of either supply voltage (for equal split-supplies). Under this condition $P_{DL} = V_S^2 / (4 \times R_L)$ where R_L includes feedback network loading.

The power in the output stage and not into the load that determines internal power dissipation.

As a worst-case example, compute the maximum T_J using a DCK (SC70 package) configured as a unity gain buffer, operating on ± 12 -V supplies at an ambient temperature of 25°C and driving a grounded 500- Ω load.

$$P_D = 24 \text{ V} \times 4.7 \text{ mA} + 12^2 / (4 \times 500 \text{ } \Omega) = 184.8 \text{ mW}$$

Maximum $T_J = 25^\circ\text{C} + (0.185 \text{ W} \times 190.8^\circ\text{C/W}) = 60^\circ\text{C}$, which is well below the maximum allowed junction temperature of 150°C.

11.2 Layout Example

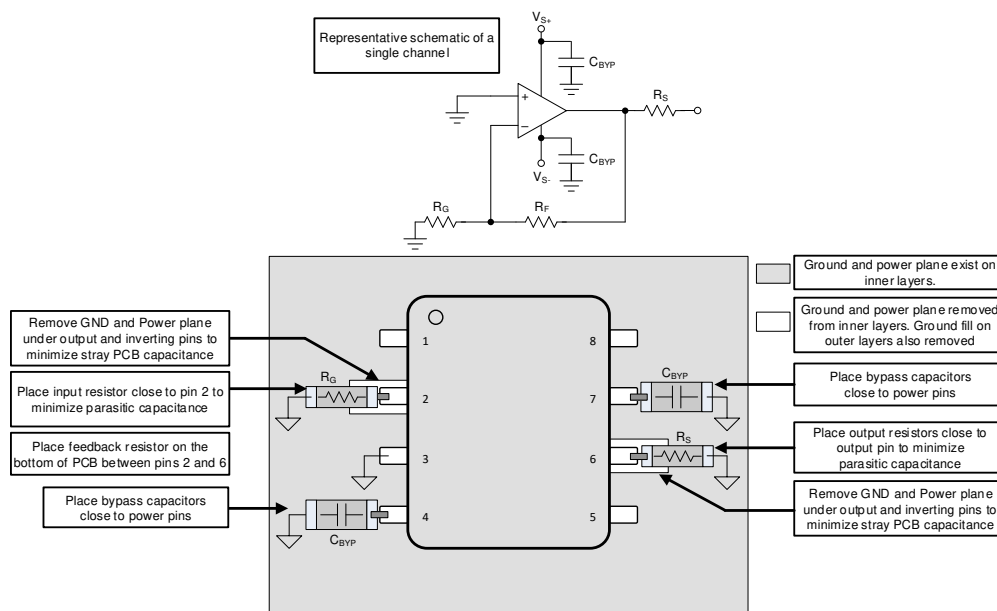

Figure 11-1. Layout Recommendation

12 Device and Documentation Support

12.1 Third-Party Products Disclaimer

TI'S PUBLICATION OF INFORMATION REGARDING THIRD-PARTY PRODUCTS OR SERVICES DOES NOT CONSTITUTE AN ENDORSEMENT REGARDING THE SUITABILITY OF SUCH PRODUCTS OR SERVICES OR A WARRANTY, REPRESENTATION OR ENDORSEMENT OF SUCH PRODUCTS OR SERVICES, EITHER ALONE OR IN COMBINATION WITH ANY TI PRODUCT OR SERVICE.

12.2 Documentation Support

12.2.1 Related Documentation

For related documentation see the following:

- Texas Instruments, [OPA2810 Dual-Channel, 27-V, Rail-to-Rail Input/Output FET-Input Operational Amplifier data sheet](#).
- Texas Instruments, [ADS9110 18-Bit, 2-MSPS, 15-mW, SAR ADC With Enhanced Performance Features data sheet](#)
- Texas Instruments, [THS4561 Low-Power, High Supply Range, 70-MHz, Fully Differential Amplifier data sheet](#)
- Texas Instruments, [OPAx837 Low-Power, Precision, 105-MHz, Voltage-Feedback Op Amp data sheet](#)
- Texas Instruments, [OPAx378 Low-Noise, 900kHz, RRIO, Precision Operational Amplifier Zero-Drift Series data sheet](#)
- Texas Instruments, [REF50xx Low-Noise, Very Low Drift, Precision Voltage Reference data sheet](#)
- Texas Instruments, [OPA2810DGK Evaluation Module user's guide](#)
- Texas Instruments, [Single-Supply Op Amp Design Techniques application report](#)
- Texas Instruments, [Transimpedance Considerations for High-Speed Amplifiers application report](#)
- Texas Instruments, [Blog: What you need to know about transimpedance amplifiers – part 1](#)
- Texas Instruments, [Blog: What you need to know about transimpedance amplifiers – part 2](#)
- Texas Instruments, [Noise Analysis for High-Speed Op Amps application report](#)
- Texas Instruments, [TINA model and simulation tool](#)
- Texas Instruments, [TIDA-01057 Reference Design Maximizing Signal Dynamic Range for True 10 Vpp Differential Input to 20 bit ADC](#)

12.3 Receiving Notification of Documentation Updates

To receive notification of documentation updates, navigate to the device product folder on [ti.com](#). Click on *Subscribe to updates* to register and receive a weekly digest of any product information that has changed. For change details, review the revision history included in any revised document.

12.4 Support Resources

TI E2E™ [support forums](#) are an engineer's go-to source for fast, verified answers and design help — straight from the experts. Search existing answers or ask your own question to get the quick design help you need.

Linked content is provided "AS IS" by the respective contributors. They do not constitute TI specifications and do not necessarily reflect TI's views; see TI's [Terms of Use](#).

12.5 Trademarks

TI E2E™ is a trademark of Texas Instruments.

All other trademarks are the property of their respective owners.

12.6 Electrostatic Discharge Caution



This integrated circuit can be damaged by ESD. Texas Instruments recommends that all integrated circuits be handled with appropriate precautions. Failure to observe proper handling and installation procedures can cause damage.

ESD damage can range from subtle performance degradation to complete device failure. Precision integrated circuits may be more susceptible to damage because very small parametric changes could cause the device not to meet its published specifications.

12.7 Glossary

[TI Glossary](#) This glossary lists and explains terms, acronyms, and definitions.

Mechanical, Packaging, and Orderable Information

The following pages include mechanical, packaging, and orderable information. This information is the most current data available for the designated devices. This data is subject to change without notice and revision of this document. For browser-based versions of this data sheet, refer to the left-hand navigation.

PACKAGING INFORMATION

| Orderable Device | Status (1) | Package Type | Package Drawing | Pins | Package Qty | Eco Plan (2) | Lead finish/ Ball material (6) | MSL Peak Temp (3) | Op Temp (°C) | Device Marking (4/5) | Samples |
|------------------|---------------|--------------|-----------------|------|-------------|-----------------|--------------------------------------|----------------------|--------------|-------------------------|-------------------------|
| OPA810IDBVR | ACTIVE | SOT-23 | DBV | 5 | 3000 | RoHS & Green | NIPDAU | Level-2-260C-1 YEAR | -40 to 125 | 1ZQ5 | Samples |
| OPA810IDBVT | ACTIVE | SOT-23 | DBV | 5 | 250 | RoHS & Green | NIPDAU | Level-2-260C-1 YEAR | -40 to 125 | 1ZQ5 | Samples |
| OPA810IDCKR | ACTIVE | SC70 | DCK | 5 | 3000 | RoHS & Green | NIPDAU | Level-2-260C-1 YEAR | -40 to 125 | 1GG | Samples |
| OPA810IDR | ACTIVE | SOIC | D | 8 | 2500 | RoHS & Green | NIPDAU | Level-2-260C-1 YEAR | -40 to 125 | 810 | Samples |
| OPA810IDT | ACTIVE | SOIC | D | 8 | 250 | RoHS & Green | NIPDAU | Level-2-260C-1 YEAR | -40 to 125 | 810 | Samples |

(1) The marketing status values are defined as follows:

ACTIVE: Product device recommended for new designs.

LIFEBUY: TI has announced that the device will be discontinued, and a lifetime-buy period is in effect.

NRND: Not recommended for new designs. Device is in production to support existing customers, but TI does not recommend using this part in a new design.

PREVIEW: Device has been announced but is not in production. Samples may or may not be available.

OBSELETE: TI has discontinued the production of the device.

(2) **RoHS:** TI defines "RoHS" to mean semiconductor products that are compliant with the current EU RoHS requirements for all 10 RoHS substances, including the requirement that RoHS substance do not exceed 0.1% by weight in homogeneous materials. Where designed to be soldered at high temperatures, "RoHS" products are suitable for use in specified lead-free processes. TI may reference these types of products as "Pb-Free".

RoHS Exempt: TI defines "RoHS Exempt" to mean products that contain lead but are compliant with EU RoHS pursuant to a specific EU RoHS exemption.

Green: TI defines "Green" to mean the content of Chlorine (Cl) and Bromine (Br) based flame retardants meet JS709B low halogen requirements of <=1000ppm threshold. Antimony trioxide based flame retardants must also meet the <=1000ppm threshold requirement.

(3) MSL, Peak Temp. - The Moisture Sensitivity Level rating according to the JEDEC industry standard classifications, and peak solder temperature.

(4) There may be additional marking, which relates to the logo, the lot trace code information, or the environmental category on the device.

(5) Multiple Device Markings will be inside parentheses. Only one Device Marking contained in parentheses and separated by a "~" will appear on a device. If a line is indented then it is a continuation of the previous line and the two combined represent the entire Device Marking for that device.

(6) Lead finish/Ball material - Orderable Devices may have multiple material finish options. Finish options are separated by a vertical ruled line. Lead finish/Ball material values may wrap to two lines if the finish value exceeds the maximum column width.

Important Information and Disclaimer: The information provided on this page represents TI's knowledge and belief as of the date that it is provided. TI bases its knowledge and belief on information provided by third parties, and makes no representation or warranty as to the accuracy of such information. Efforts are underway to better integrate information from third parties. TI has taken and continues to take reasonable steps to provide representative and accurate information but may not have conducted destructive testing or chemical analysis on incoming materials and chemicals. TI and TI suppliers consider certain information to be proprietary, and thus CAS numbers and other limited information may not be available for release.

In no event shall TI's liability arising out of such information exceed the total purchase price of the TI part(s) at issue in this document sold by TI to Customer on an annual basis.

TAPE AND REEL INFORMATION

QUADRANT ASSIGNMENTS FOR PIN 1 ORIENTATION IN TAPE

*All dimensions are nominal

| Device | Package Type | Package Drawing | Pins | SPQ | Reel Diameter (mm) | Reel Width W1 (mm) | A0 (mm) | B0 (mm) | K0 (mm) | P1 (mm) | W (mm) | Pin1 Quadrant |
|-------------|--------------|-----------------|------|------|--------------------|--------------------|---------|---------|---------|---------|--------|---------------|
| OPA810IDBVR | SOT-23 | DBV | 5 | 3000 | 178.0 | 9.0 | 3.3 | 3.2 | 1.4 | 4.0 | 8.0 | Q3 |
| OPA810IDBVT | SOT-23 | DBV | 5 | 250 | 178.0 | 9.0 | 3.3 | 3.2 | 1.4 | 4.0 | 8.0 | Q3 |
| OPA810IDCKR | SC70 | DCK | 5 | 3000 | 180.0 | 8.4 | 2.47 | 2.3 | 1.25 | 4.0 | 8.0 | Q3 |
| OPA810IDR | SOIC | D | 8 | 2500 | 330.0 | 12.4 | 6.4 | 5.2 | 2.1 | 8.0 | 12.0 | Q1 |
| OPA810IDT | SOIC | D | 8 | 250 | 180.0 | 12.4 | 6.4 | 5.2 | 2.1 | 8.0 | 12.0 | Q1 |

TAPE AND REEL BOX DIMENSIONS



*All dimensions are nominal

| Device | Package Type | Package Drawing | Pins | SPQ | Length (mm) | Width (mm) | Height (mm) |
|-------------|--------------|-----------------|------|------|-------------|------------|-------------|
| OPA810IDBVR | SOT-23 | DBV | 5 | 3000 | 190.0 | 190.0 | 30.0 |
| OPA810IDBVT | SOT-23 | DBV | 5 | 250 | 190.0 | 190.0 | 30.0 |
| OPA810IDCKR | SC70 | DCK | 5 | 3000 | 213.0 | 191.0 | 35.0 |
| OPA810IDR | SOIC | D | 8 | 2500 | 356.0 | 356.0 | 35.0 |
| OPA810IDT | SOIC | D | 8 | 250 | 210.0 | 185.0 | 35.0 |

EXAMPLE BOARD LAYOUT

DBV0005A

SOT-23 - 1.45 mm max height

SMALL OUTLINE TRANSISTOR



LAND PATTERN EXAMPLE
EXPOSED METAL SHOWN
SCALE:15X



SOLDER MASK DETAILS

4214839/J 02/2024

NOTES: (continued)

- 6. Publication IPC-7351 may have alternate designs.
- 7. Solder mask tolerances between and around signal pads can vary based on board fabrication site.

EXAMPLE STENCIL DESIGN

DBV0005A

SOT-23 - 1.45 mm max height

SMALL OUTLINE TRANSISTOR



SOLDER PASTE EXAMPLE
BASED ON 0.125 mm THICK STENCIL
SCALE:15X

4214839/J 02/2024

NOTES: (continued)

8. Laser cutting apertures with trapezoidal walls and rounded corners may offer better paste release. IPC-7525 may have alternate design recommendations.
9. Board assembly site may have different recommendations for stencil design.



D0008A

PACKAGE OUTLINE

SOIC - 1.75 mm max height

SMALL OUTLINE INTEGRATED CIRCUIT



4214825/C 02/2019

NOTES:

- Linear dimensions are in inches [millimeters]. Dimensions in parenthesis are for reference only. Controlling dimensions are in inches. Dimensioning and tolerancing per ASME Y14.5M.
- This drawing is subject to change without notice.
- This dimension does not include mold flash, protrusions, or gate burrs. Mold flash, protrusions, or gate burrs shall not exceed $.006$ [0.15] per side.
- This dimension does not include interlead flash.
- Reference JEDEC registration MS-012, variation AA.

EXAMPLE BOARD LAYOUT

D0008A

SOIC - 1.75 mm max height

SMALL OUTLINE INTEGRATED CIRCUIT



LAND PATTERN EXAMPLE
EXPOSED METAL SHOWN
SCALE:8X



SOLDER MASK DETAILS

4214825/C 02/2019

NOTES: (continued)

- 6. Publication IPC-7351 may have alternate designs.
- 7. Solder mask tolerances between and around signal pads can vary based on board fabrication site.

EXAMPLE STENCIL DESIGN

D0008A

SOIC - 1.75 mm max height

SMALL OUTLINE INTEGRATED CIRCUIT



SOLDER PASTE EXAMPLE
BASED ON .005 INCH [0.125 MM] THICK STENCIL
SCALE:8X

4214825/C 02/2019

NOTES: (continued)

8. Laser cutting apertures with trapezoidal walls and rounded corners may offer better paste release. IPC-7525 may have alternate design recommendations.
9. Board assembly site may have different recommendations for stencil design.

EXAMPLE BOARD LAYOUT

DCK0005A

SOT - 1.1 max height

SMALL OUTLINE TRANSISTOR

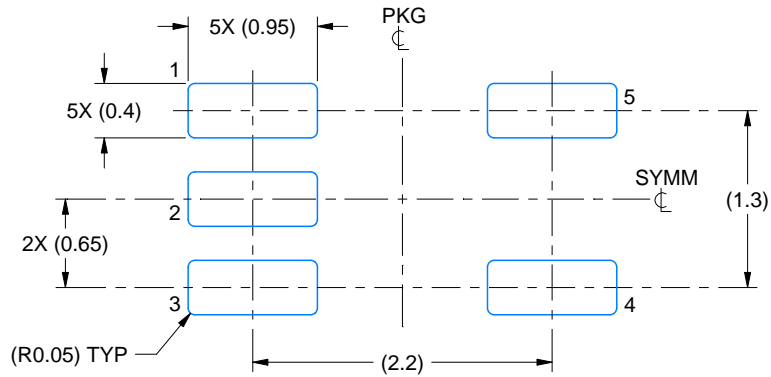

LAND PATTERN EXAMPLE
EXPOSED METAL SHOWN
SCALE:18X

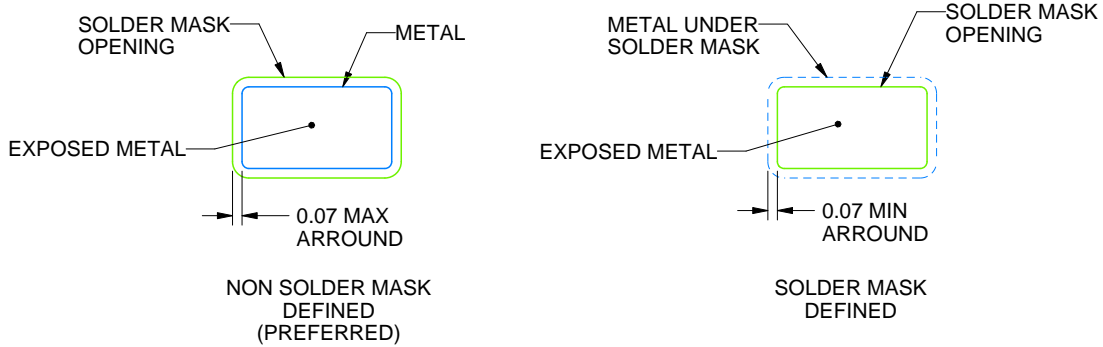

SOLDER MASK DETAILS

4214834/E 06/2024

NOTES: (continued)

- 7. Publication IPC-7351 may have alternate designs.
- 8. Solder mask tolerances between and around signal pads can vary based on board fabrication site.

EXAMPLE STENCIL DESIGN

DCK0005A

SOT - 1.1 max height

SMALL OUTLINE TRANSISTOR

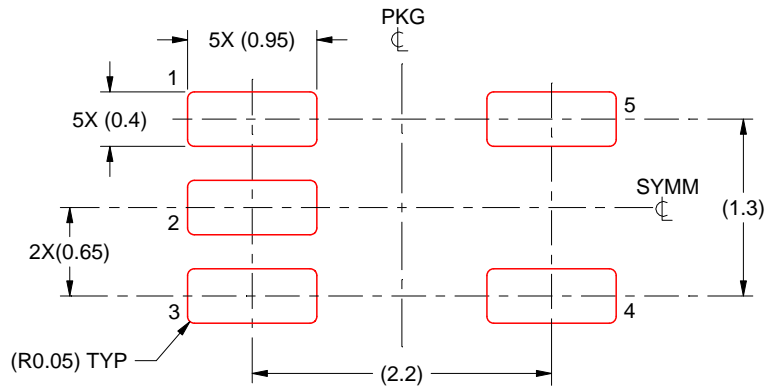

SOLDER PASTE EXAMPLE
BASED ON 0.125 THICK STENCIL
SCALE: 18X

4214834/E 06/2024

NOTES: (continued)

9. Laser cutting apertures with trapezoidal walls and rounded corners may offer better paste release. IPC-7525 may have alternate design recommendations.
10. Board assembly site may have different recommendations for stencil design.

IMPORTANT NOTICE AND DISCLAIMER

TI PROVIDES TECHNICAL AND RELIABILITY DATA (INCLUDING DATA SHEETS), DESIGN RESOURCES (INCLUDING REFERENCE DESIGNS), APPLICATION OR OTHER DESIGN ADVICE, WEB TOOLS, SAFETY INFORMATION, AND OTHER RESOURCES "AS IS" AND WITH ALL FAULTS, AND DISCLAIMS ALL WARRANTIES, EXPRESS AND IMPLIED, INCLUDING WITHOUT LIMITATION ANY IMPLIED WARRANTIES OF MERCHANTABILITY, FITNESS FOR A PARTICULAR PURPOSE OR NON-INFRINGEMENT OF THIRD PARTY INTELLECTUAL PROPERTY RIGHTS.

These resources are intended for skilled developers designing with TI products. You are solely responsible for (1) selecting the appropriate TI products for your application, (2) designing, validating and testing your application, and (3) ensuring your application meets applicable standards, and any other safety, security, regulatory or other requirements.

These resources are subject to change without notice. TI grants you permission to use these resources only for development of an application that uses the TI products described in the resource. Other reproduction and display of these resources is prohibited. No license is granted to any other TI intellectual property right or to any third party intellectual property right. TI disclaims responsibility for, and you will fully indemnify TI and its representatives against, any claims, damages, costs, losses, and liabilities arising out of your use of these resources.

TI's products are provided subject to [TI's Terms of Sale](#) or other applicable terms available either on [ti.com](https://www.ti.com) or provided in conjunction with such TI products. TI's provision of these resources does not expand or otherwise alter TI's applicable warranties or warranty disclaimers for TI products.

TI objects to and rejects any additional or different terms you may have proposed.

Mailing Address: Texas Instruments, Post Office Box 655303, Dallas, Texas 75265
Copyright © 2024, Texas Instruments Incorporated