

LM2941QML 1A Low Dropout Adjustable Regulator

 Check for Samples: [LM2941QML](#), [LM2941QML-SP](#)

FEATURES

- Available with Radiation Ensure
 - ELDRS Free 100 krad(Si)
- Output Voltage Adjustable from 5V to 20V
- Dropout Voltage Typically 0.5V at $I_O = 1A$
- Output Current in Excess of 1A
- Trimmed Reference Voltage
- Reverse Battery Protection
- Internal Short Circuit Current Limit
- Mirror Image Insertion Protection
- TTL, CMOS Compatible ON/OFF Switch

DESCRIPTION

The LM2941 positive voltage regulator features the ability to source 1A of output current with a typical dropout voltage of 0.5V and a maximum of 1V over the entire temperature range. Furthermore, a quiescent current reduction circuit has been included which reduces the ground pin current when the differential between the input voltage and the output voltage exceeds approximately 3V. The quiescent current with 1A of output current and an input-output differential of 5V is therefore only 30mA. Higher quiescent currents only exist when the regulator is in the dropout mode ($V_I - V_O \leq 3V$).

Originally designed for vehicular applications, the LM2941 and all regulated circuitry are protected from reverse battery installations or two-battery jumps. During line transients, such as load dump when the input voltage can momentarily exceed the specified maximum operating voltage, the regulator will automatically shut down to protect both the internal circuits and the load. Familiar regulator features such as short circuit and thermal overload protection are also provided.

Connection Diagram

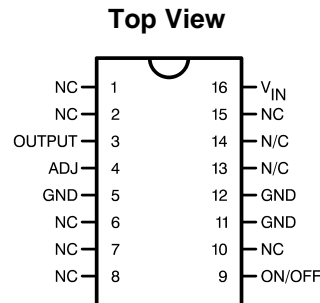

Figure 1. 16-Lead CFP Package



Please be aware that an important notice concerning availability, standard warranty, and use in critical applications of Texas Instruments semiconductor products and disclaimers thereto appears at the end of this data sheet.

All trademarks are the property of their respective owners.

Equivalent Schematic Diagram

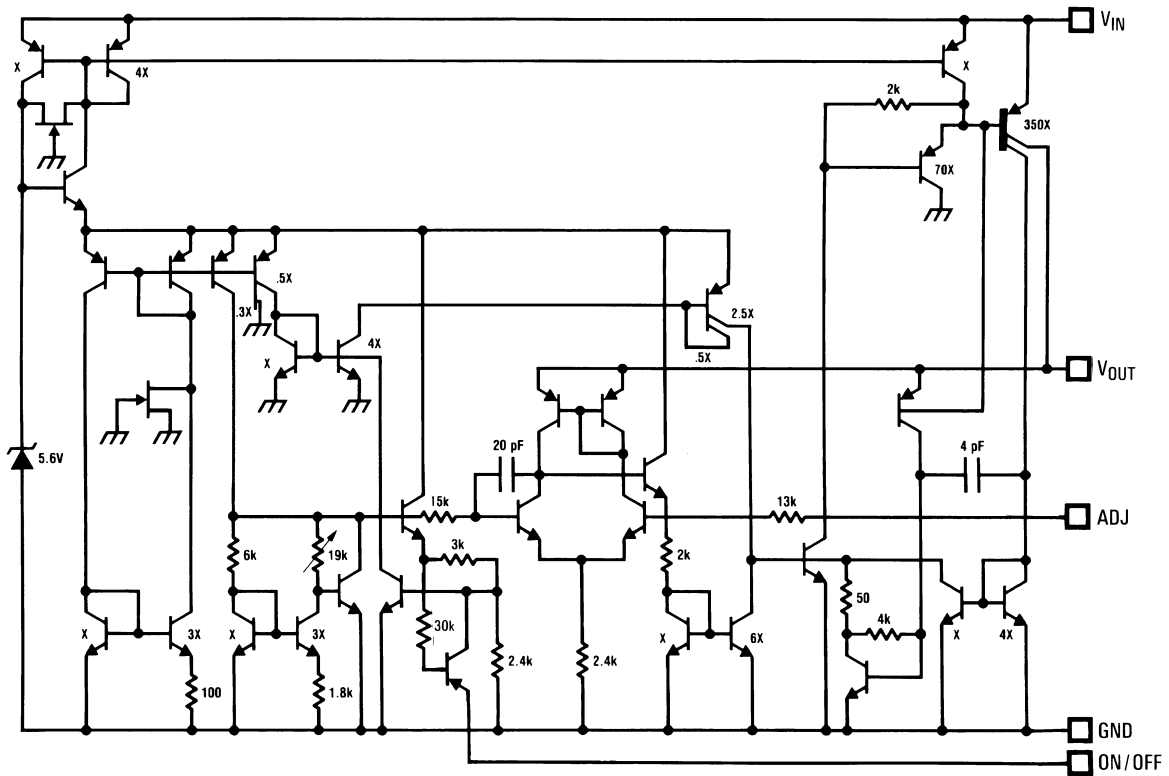

These devices have limited built-in ESD protection. The leads should be shorted together or the device placed in conductive foam during storage or handling to prevent electrostatic damage to the MOS gates.

Absolute Maximum Ratings⁽¹⁾

Input Voltage (Survival Voltage, $\leq 100\text{ms}$)		60V	
Internal Power Dissipation ⁽²⁾		Internally Limited	
Maximum Junction Temperature		150°C	
Storage Temperature Range		$-65^\circ\text{C} \leq T_J \leq +150^\circ\text{C}$	
Lead Temperature (Soldering, 10 seconds)		300°C	
Thermal Resistance	θ_{JA}	CFP "WG" (device 01, 02) (Still Air)	122°C/W
		CFP "WG" (device 01, 02) (500LF/Min Air Flow)	77°C/W
		CFP "GW" (device 03, 04) (Still Air)	136°C/W
		CFP "GW" (device 03, 04) (500LF/Min Air Flow)	87°C/W
	θ_{JC}	CFP "WG" (device 01, 02) ⁽³⁾	5°C/W
		CFP "GW" (device 03, 04)	13°C/W
Package Weight (Typ)	CFP "WG" (device 01, 02)	360mg	
	CFP "GW" (device 03, 04)	410mg	
ESD susceptibility to be determined ⁽⁴⁾		500V	

- (1) Absolute Maximum Ratings indicate limits beyond which damage to the device may occur. Operating Ratings indicate conditions for which the device is functional, but do not ensure specific performance limits. For specified specifications and test conditions, see the Electrical Characteristics. The ensured specifications apply only for the test conditions listed. Some performance characteristics may degrade when the device is not operated under the listed test conditions.
- (2) The maximum power dissipation must be derated at elevated temperatures and is dictated by T_{Jmax} (maximum junction temperature), θ_{JA} (package junction to ambient thermal resistance), and T_A (ambient temperature). The maximum allowable power dissipation at any temperature is $P_{Dmax} = (T_{Jmax} - T_A)/\theta_{JA}$ or the number given in the Absolute Maximum Ratings, whichever is lower.
- (3) The package material for these devices allows much improved heat transfer over our standard ceramic packages. In order to take full advantage of this improved heat transfer, heat sinking must be provided between the package base (directly beneath the die), and either metal traces on, or thermal vias through, the printed circuit board. Without this additional heat sinking, device power dissipation must be calculated using θ_{JA} , rather than θ_{JC} , thermal resistance. It must not be assumed that the device leads will provide substantial heat transfer out of the package, since the thermal resistance of the lead frame material is very poor, relative to the material of the package base. The stated θ_{JC} thermal resistance is for the package material only, and does not account for the additional thermal resistance between the package base and the printed circuit board. The user must determine the value of the additional thermal resistance and must combine this with the stated value for the package, to calculate the total allowed power dissipation for the device.
- (4) Human body model, 1.5 k Ω in series with 100 pF.

Recommended Operating Conditions

Maximum Input Voltage	26V
Temperature Range	$-55^\circ\text{C} \leq T_A \leq 125^\circ\text{C}$

Table 1. Quality Conformance Inspection Mil-Std-883, Method 5005 - Group A

Subgroup	Description	Temp °C
1	Static tests at	+25
2	Static tests at	+125
3	Static tests at	-55
4	Dynamic tests at	+25
5	Dynamic tests at	+125
6	Dynamic tests at	-55
7	Functional tests at	+25
8A	Functional tests at	+125
8B	Functional tests at	-55
9	Switching tests at	+25
10	Switching tests at	+125
11	Switching tests at	-55
12	Settling time at	+25
13	Settling time at	+125
14	Settling time at	-55

LM2941 Electrical Characteristics DC Parameters

The following conditions apply, unless otherwise specified.

DC: $5V \leq V_O \leq 20V$, $V_{IN} = V_O + 5V$, $C_O = 22\mu F$

Parameter		Test Conditions	Notes	Min	Max	Unit	Sub-groups
V _{Ref}	Reference Voltage	$5mA \leq I_O \leq 1A$		1.237	1.313	V	1
				1.211	1.339	V	2, 3
V _{RLine}	Line Regulation	$V_O + 2V \leq V_{IN} \leq 26V$, $I_O = 5mA$	See ⁽¹⁾		10	mV/V	1, 2, 3
V _{RLoad}	Load Regulation	$50mA \leq I_O \leq 1A$, $V_{IN} = 10V$, $V_{OUT} = 5V$	See ⁽¹⁾		10	mV/V	1, 2, 3
		$50mA \leq I_O \leq 1A$, $V_{IN} = 25V$, $V_{OUT} = 20V$			10	mV/V	1, 2, 3
I _Q	Quiescent Current	$V_O + 2V \leq V_{IN} \leq 26V$, $I_O = 5mA$			15	mA	1
					20	mA	2, 3
		$V_{IN} = V_O + 5V$, $I_O = 1A$			45	mA	1
V _{DO}	Dropout Voltage	$I_O = 1A$			0.8	V	1
					1.0	V	2, 3
					200	mV	1
I _{SC}	Short Circuit Current	$V_{IN Max} = 26V$		1.6	3.5	A	1
				1.3	3.7	A	2, 3
	Maximum Operational Input Voltage		See ⁽²⁾		26	V _{DC}	1, 2, 3
	Reverse Polarity DC Input Voltage	$R_O = 100\Omega$, $V_O \geq -0.6V$	See ⁽³⁾	-15		V	1, 2, 3
V _{TH On}	ON/OFF Threshold Voltage ON	$I_O \leq 1A$	See ⁽³⁾		0.8	V	1, 2, 3
V _{Th Off}	ON/OFF Threshold Voltage OFF	$I_O \leq 1A$	See ⁽³⁾	2.00		V	1, 2, 3
	ON/OFF Threshold Current	$V_{ON/OFF} = 2.0V$, $I_O \leq 1A$			100	μA	1
					300	μA	2, 3

- (1) Limit = mV per volt of V_O.
- (2) Condition for V_{IN}
- (3) Functional test go-no-go only.

LM2941 Electrical Characteristics AC Parameters

The following conditions apply, unless otherwise specified.

AC: $5V \leq V_O \leq 20V$, $V_{IN} = V_O + 5V$, $C_O = 22\mu F$

Parameter		Test Conditions	Notes	Min	Max	Unit	Sub-groups
	Maximum Line Transient	$V_{O\ Max}$ 1V above nominal V_O , $R_O = 100\Omega$, $t \leq 100mS$		60		V	4, 5, 6
	Reverse Polarity Transient Input Voltage	$t \leq 100mS$, $R_O = 100\Omega$		-50		V	4, 5, 6
RR	Ripple Rejection	$f_O = 1KHz$, $1 V_{RMS}$, $I_L = 100mA$	See ⁽¹⁾		0.02	%/V	4
		$f_O = 1KHz$, $1 V_{RMS}$, $I_L = 100mA$	See ⁽¹⁾		0.04	%/V	5, 6

(1) %/V = % of V_{IN} per Volt of V_O .

LM2941 Electrical Characteristics DC Drift Parameters

The following conditions apply, unless otherwise specified.

DC: $5V \leq V_O \leq 20V$, $V_{IN} = V_O + 5V$, $C_O = 22\mu F$

Delta calculations performed on QMLV devices at group B , subgroup 5.

Parameter		Test Conditions	Notes	Min	Max	Unit	Sub-groups
V_{Ref}	Reference Voltage	$5mA \leq I_O \leq 1A$		-25	+25	mV	1

Typical Performance Characteristics

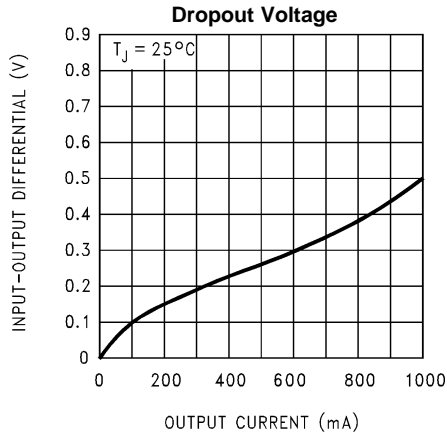

Figure 2.

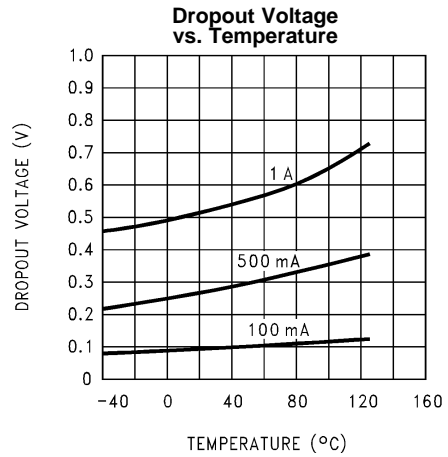

Figure 3.

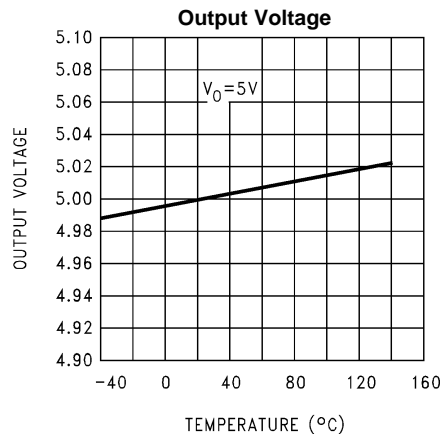

Figure 4.

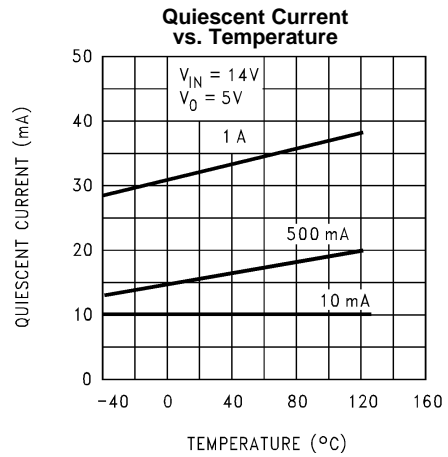

Figure 5.

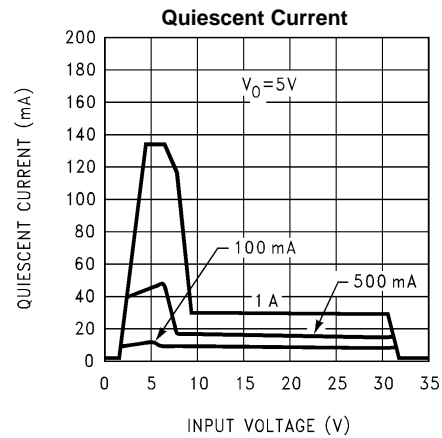

Figure 6.

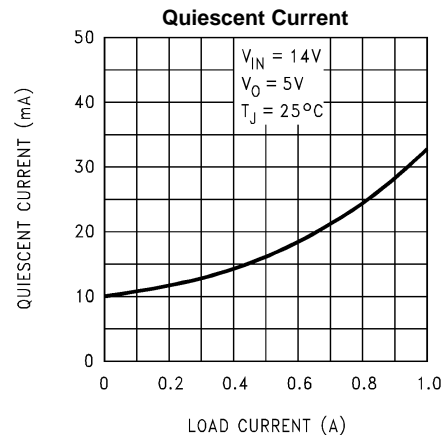

Figure 7.

Typical Performance Characteristics (continued)

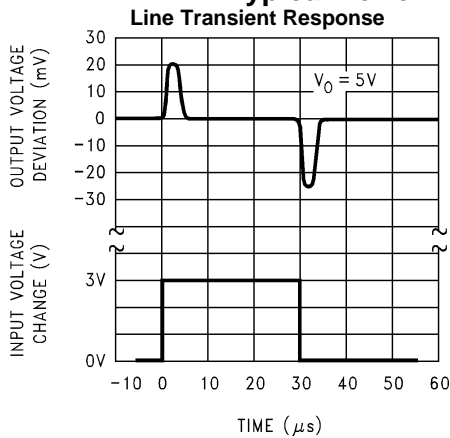

Figure 8.

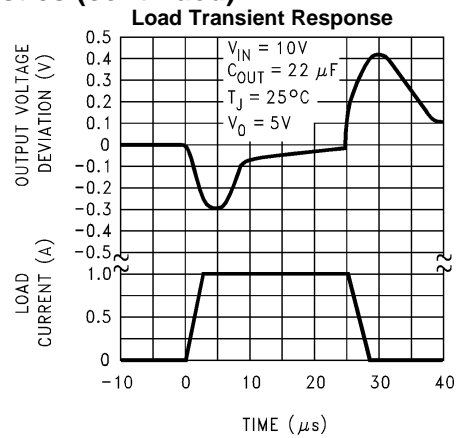

Figure 9.

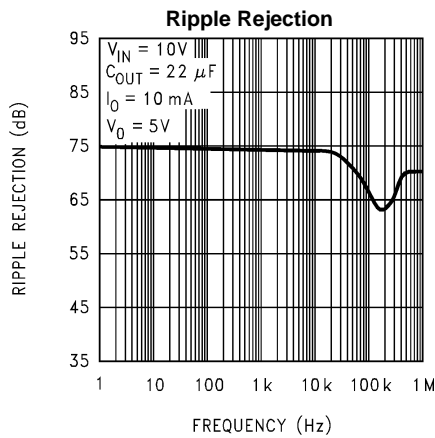

Figure 10.

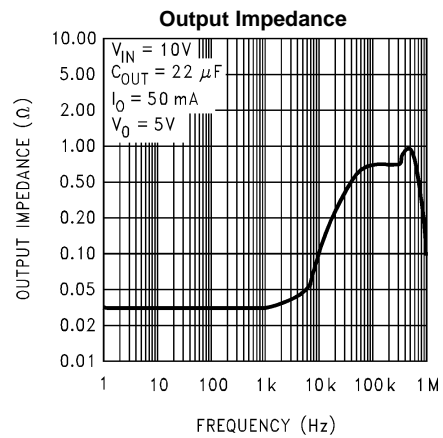

Figure 11.

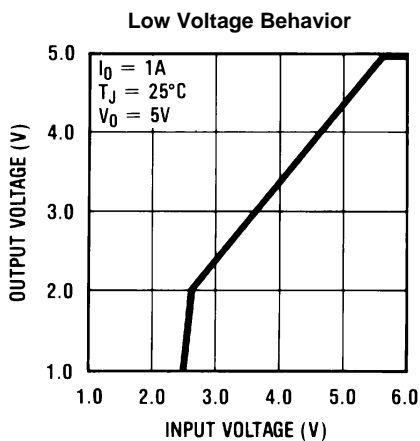

Figure 12.

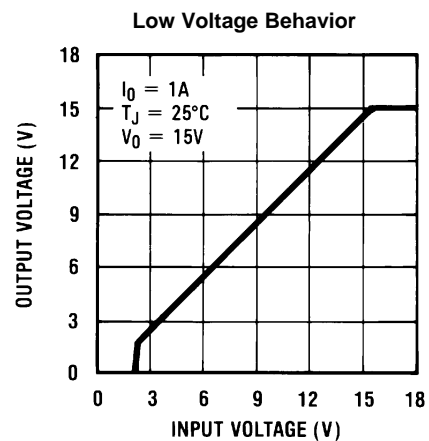

Figure 13.

Typical Performance Characteristics (continued)

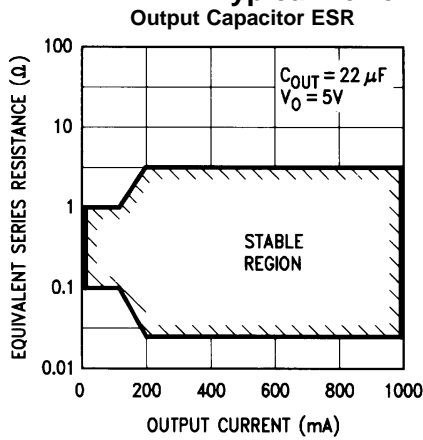

Figure 14.

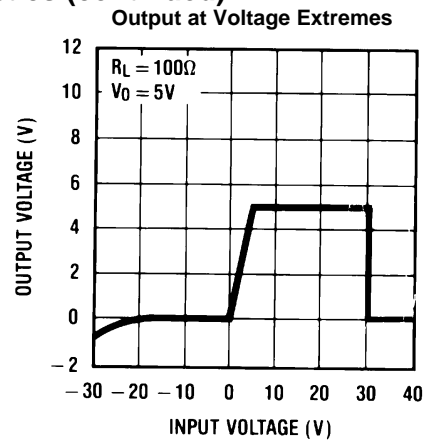

Figure 15.

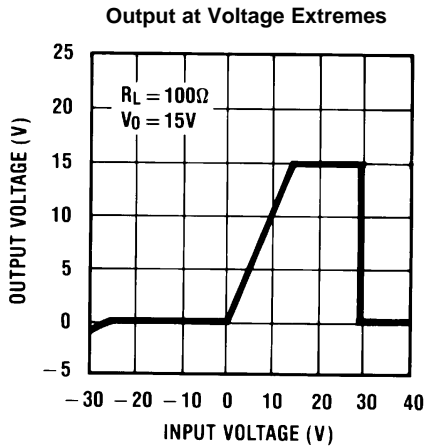

Figure 16.

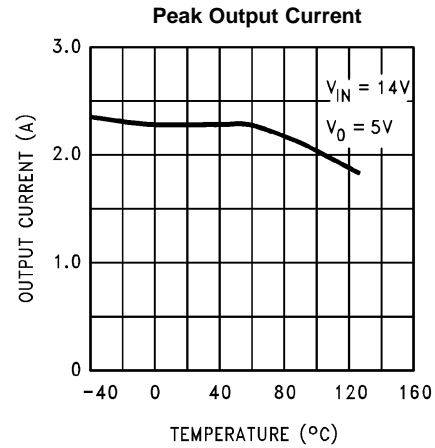
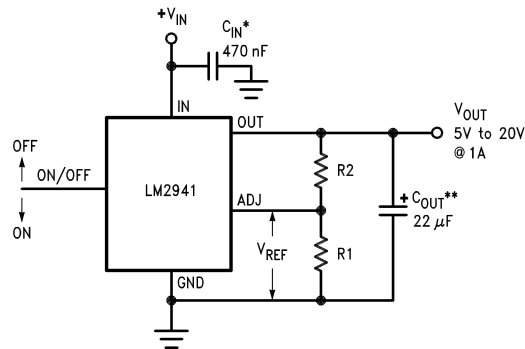

Figure 17.

Typical Applications



$$V_{OUT} = \text{Reference voltage} \times \frac{R1 + R2}{R1} \text{ where } V_{REF} = 1.275 \text{ typical}$$

$$\text{Solving for R2: } R2 = R1 \left(\frac{V_O}{V_{REF}} - 1 \right)$$

Note: Using 1KΩ for R1 will ensure that the input bias current error of the adjust pin will be negligible. Do not bypass R1 or R2. This will lead to instabilities.

* Required if regulator is located far from power supply filter.

** C_O must be at least 22μF to maintain stability. May be increased without bound to maintain regulation during transients. Locate as close as possible to the regulator. This capacitor must be rated over the same operating temperature range as the regulator and the ESR is critical; see curve.

Figure 18. 5V to 20V Adjustable Regulator

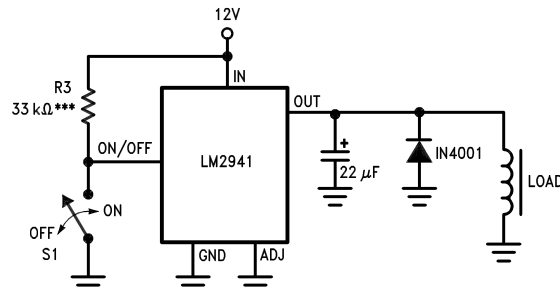

*** To assure shutdown, select Resistor R3 to ensure at least 300μA of pull-up current when S1 is open. (Assume 2V at the ON/OFF pin.)

Figure 19. 1A Switch

REVISION HISTORY SECTION

Released	Revision	Section	Changes
08/25/09	A	New Release, Corporate format	1 MDS data sheet converted into one Corp. data sheet format. Added Radiation products to ordering table. MNLM2941-X Rev 4A1 will be archived.
12–Oct-2011	B	Ordering Information, Absolute Max Ratings	Ordering Information — Added LM2941GW/883, LM2941GW-QMLV and LM2941GWRLQMLV. Absolute Max — Added Theta JA and Theta JC along with Package weight of 'GW' devices. RatingsLM2941QML Rev A will be archived.

REVISION HISTORY

Changes from Revision A (April 2013) to Revision B	Page
• Changed layout of National Data Sheet to TI format	9

PACKAGING INFORMATION

Orderable Device	Status (1)	Package Type	Package Drawing	Pins	Package Qty	Eco Plan (2)	Lead finish/ Ball material (6)	MSL Peak Temp (3)	Op Temp (°C)	Device Marking (4/5)	Samples
5962-9166703QYA	ACTIVE	CFP	NAC	16	88	Non-RoHS & Green	Call TI	Level-1-NA-UNLIM	-55 to 125	LM2941GW /883 Q 5962-91667 03QYA ACO 03QYA >T	Samples
5962-9166703VYA	ACTIVE	CFP	NAC	16	88	Non-RoHS & Green	Call TI	Level-1-NA-UNLIM	-55 to 125	LM2941GW- QMLV Q 5962-91667 03VYA ACO 03VYA >T	Samples
5962R9166702V9A	ACTIVE	DIESALE	Y	0	34	RoHS & Green	Call TI	Level-1-NA-UNLIM	-55 to 125		Samples
5962R9166704VYA	ACTIVE	CFP	NAC	16	88	Non-RoHS & Green	Call TI	Level-1-NA-UNLIM	-55 to 125	LM2941GWRL QMLV Q 5962R91667 04VYA ACO 04VYA >T	Samples
LM2941 MDE	ACTIVE	DIESALE	Y	0	34	RoHS & Green	Call TI	Level-1-NA-UNLIM	-55 to 125		Samples
LM2941-MD8	ACTIVE	DIESALE	Y	0	221	RoHS & Green	Call TI	Level-1-NA-UNLIM			Samples
LM2941GW-QMLV	ACTIVE	CFP	NAC	16	88	Non-RoHS & Green	Call TI	Level-1-NA-UNLIM	-55 to 125	LM2941GW- QMLV Q 5962-91667 03VYA ACO 03VYA >T	Samples
LM2941GW/883	ACTIVE	CFP	NAC	16	88	Non-RoHS & Green	Call TI	Level-1-NA-UNLIM	-55 to 125	LM2941GW /883 Q 5962-91667 03QYA ACO 03QYA >T	Samples
LM2941GWRLQMLV	ACTIVE	CFP	NAC	16	88	Non-RoHS & Green	Call TI	Level-1-NA-UNLIM	-55 to 125	LM2941GWRL QMLV Q 5962R91667 04VYA ACO 04VYA >T	Samples

(1) The marketing status values are defined as follows:

ACTIVE: Product device recommended for new designs.

LIFEBUY: TI has announced that the device will be discontinued, and a lifetime-buy period is in effect.

NRND: Not recommended for new designs. Device is in production to support existing customers, but TI does not recommend using this part in a new design.

PREVIEW: Device has been announced but is not in production. Samples may or may not be available.

OBSOLETE: TI has discontinued the production of the device.

(2) **RoHS:** TI defines "RoHS" to mean semiconductor products that are compliant with the current EU RoHS requirements for all 10 RoHS substances, including the requirement that RoHS substance do not exceed 0.1% by weight in homogeneous materials. Where designed to be soldered at high temperatures, "RoHS" products are suitable for use in specified lead-free processes. TI may reference these types of products as "Pb-Free".

RoHS Exempt: TI defines "RoHS Exempt" to mean products that contain lead but are compliant with EU RoHS pursuant to a specific EU RoHS exemption.

Green: TI defines "Green" to mean the content of Chlorine (Cl) and Bromine (Br) based flame retardants meet JS709B low halogen requirements of ≤ 1000 ppm threshold. Antimony trioxide based flame retardants must also meet the ≤ 1000 ppm threshold requirement.

(3) MSL, Peak Temp. - The Moisture Sensitivity Level rating according to the JEDEC industry standard classifications, and peak solder temperature.

(4) There may be additional marking, which relates to the logo, the lot trace code information, or the environmental category on the device.

(5) Multiple Device Markings will be inside parentheses. Only one Device Marking contained in parentheses and separated by a "~" will appear on a device. If a line is indented then it is a continuation of the previous line and the two combined represent the entire Device Marking for that device.

(6) Lead finish/Ball material - Orderable Devices may have multiple material finish options. Finish options are separated by a vertical ruled line. Lead finish/Ball material values may wrap to two lines if the finish value exceeds the maximum column width.

Important Information and Disclaimer: The information provided on this page represents TI's knowledge and belief as of the date that it is provided. TI bases its knowledge and belief on information provided by third parties, and makes no representation or warranty as to the accuracy of such information. Efforts are underway to better integrate information from third parties. TI has taken and continues to take reasonable steps to provide representative and accurate information but may not have conducted destructive testing or chemical analysis on incoming materials and chemicals. TI and TI suppliers consider certain information to be proprietary, and thus CAS numbers and other limited information may not be available for release.

In no event shall TI's liability arising out of such information exceed the total purchase price of the TI part(s) at issue in this document sold by TI to Customer on an annual basis.

OTHER QUALIFIED VERSIONS OF LM2941QML, LM2941QML-SP :

● Military : [LM2941QML](#)

● Space : [LM2941QML-SP](#)

NOTE: Qualified Version Definitions:

- Military - QML certified for Military and Defense Applications
- Space - Radiation tolerant, ceramic packaging and qualified for use in Space-based application

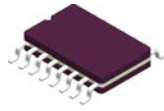

NAC0016A

PACKAGE OUTLINE

CFP - 2.33mm max height

CERAMIC FLATPACK

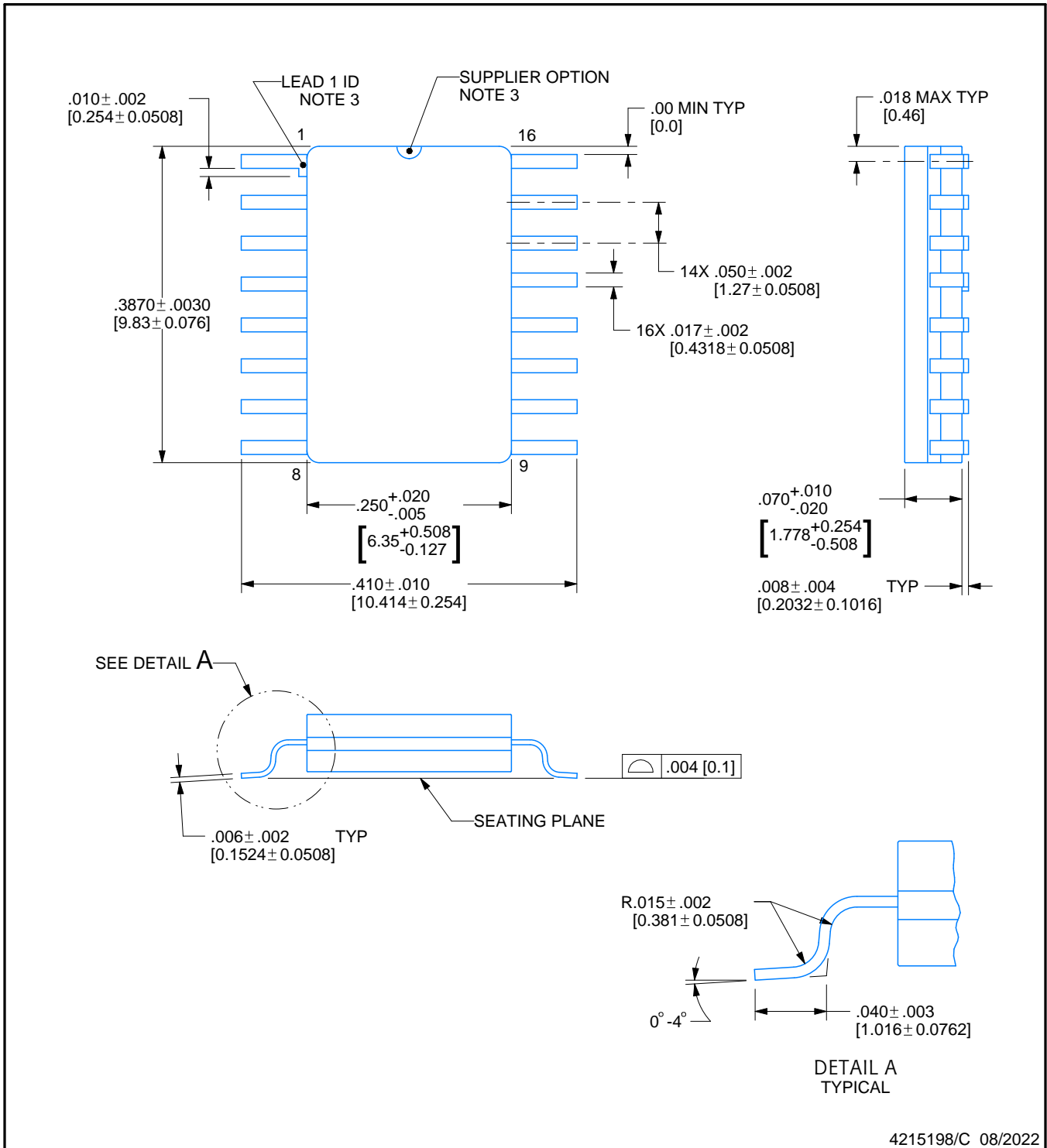

4215198/C 08/2022

NOTES:

- Controlling dimension is Inch. Values in [] are millimeters. Dimensions in () for reference only.
- For solder thickness and composition, see the "Lead Finish Composition/Thickness" link in the packaging section of the Texas Instruments website
- Lead 1 identification shall be:
 - A notch or other mark within this area
 - A tab on lead 1, either side
- No JEDEC registration as of December 2021

EXAMPLE BOARD LAYOUT

NAC0016A

CFP - 2.33mm max height

CERAMIC FLATPACK

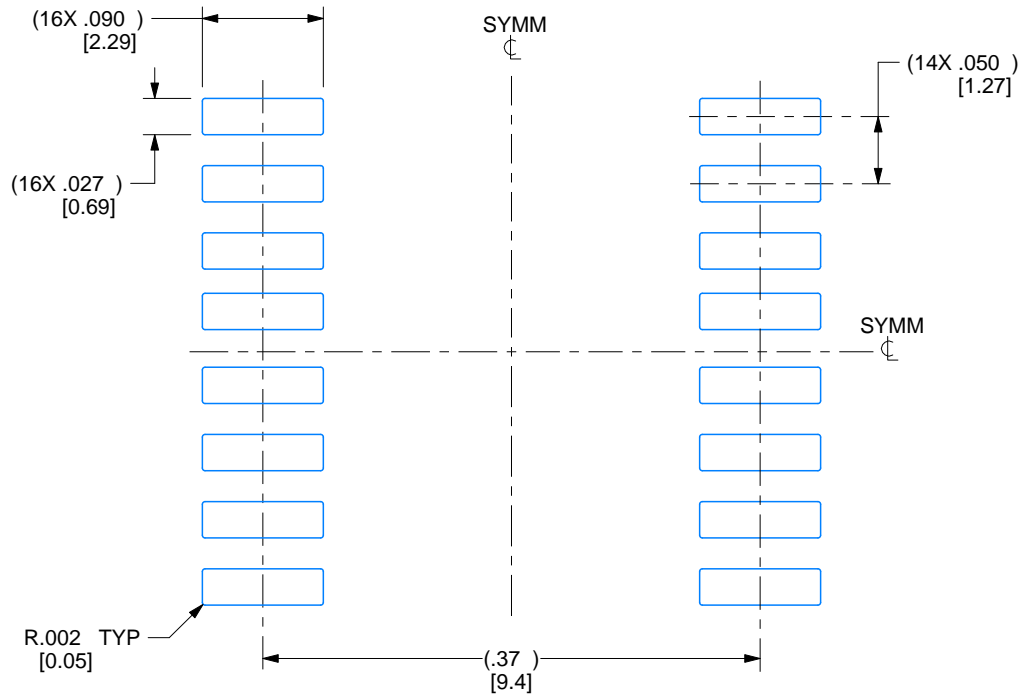

RECOMMENDED LAND PATTERN

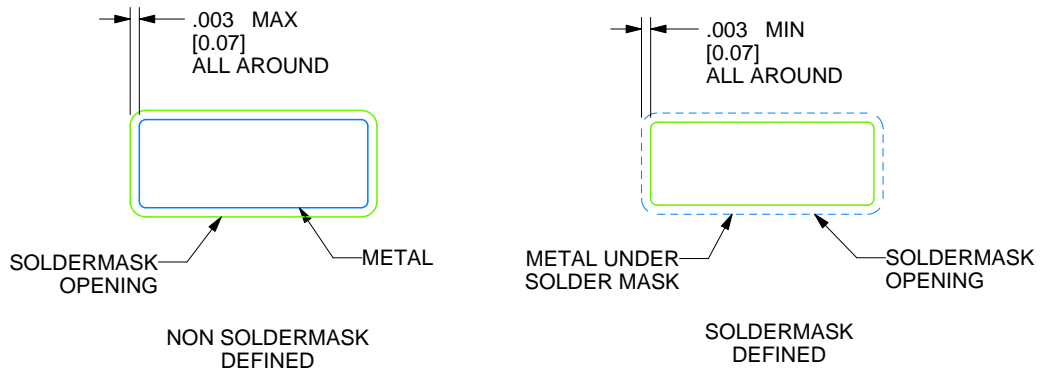

4215198/C 08/2022

REVISIONS

REV	DESCRIPTION	E.C.N.	DATE	BY/APP'D
A	RELEASE TO DOCUMENT CONTROL	2197879	12/30/2021	TINA TRAN / ANIS FAUZI
B	NO CHANGE TO DRAWING; REVISION FOR YODA RELEASE;	2198832	02/15/2022	K. SINCERBOX
C	.387±.003 WAS .39000±.00012;	2200917	08/08/2022	D. CHIN / K. SINCERBOX

IMPORTANT NOTICE AND DISCLAIMER

TI PROVIDES TECHNICAL AND RELIABILITY DATA (INCLUDING DATA SHEETS), DESIGN RESOURCES (INCLUDING REFERENCE DESIGNS), APPLICATION OR OTHER DESIGN ADVICE, WEB TOOLS, SAFETY INFORMATION, AND OTHER RESOURCES "AS IS" AND WITH ALL FAULTS, AND DISCLAIMS ALL WARRANTIES, EXPRESS AND IMPLIED, INCLUDING WITHOUT LIMITATION ANY IMPLIED WARRANTIES OF MERCHANTABILITY, FITNESS FOR A PARTICULAR PURPOSE OR NON-INFRINGEMENT OF THIRD PARTY INTELLECTUAL PROPERTY RIGHTS.

These resources are intended for skilled developers designing with TI products. You are solely responsible for (1) selecting the appropriate TI products for your application, (2) designing, validating and testing your application, and (3) ensuring your application meets applicable standards, and any other safety, security, regulatory or other requirements.

These resources are subject to change without notice. TI grants you permission to use these resources only for development of an application that uses the TI products described in the resource. Other reproduction and display of these resources is prohibited. No license is granted to any other TI intellectual property right or to any third party intellectual property right. TI disclaims responsibility for, and you will fully indemnify TI and its representatives against, any claims, damages, costs, losses, and liabilities arising out of your use of these resources.

TI's products are provided subject to [TI's Terms of Sale](#) or other applicable terms available either on [ti.com](https://www.ti.com) or provided in conjunction with such TI products. TI's provision of these resources does not expand or otherwise alter TI's applicable warranties or warranty disclaimers for TI products.

TI objects to and rejects any additional or different terms you may have proposed.

Mailing Address: Texas Instruments, Post Office Box 655303, Dallas, Texas 75265
Copyright © 2023, Texas Instruments Incorporated