

OPAx205 4- μV , 0.08- $\mu\text{V}/^\circ\text{C}$, Low-Power, Super Beta, Bipolar, e-trim™ Op Amps

1 Features

- e-trim™ operational amplifier performance
 - Low offset voltage: 25 μV (max), 15 μV (max, high grade)
 - Low offset voltage drift: $\pm 0.5 \mu\text{V}/^\circ\text{C}$ (max), $\pm 0.2 \mu\text{V}/^\circ\text{C}$ (max, high grade)
- Super beta inputs
 - Input bias current: 500 pA (max)
 - Input current noise: 110 fA/ $\sqrt{\text{Hz}}$
- Low noise
 - 0.1 to 10-Hz: 0.2 μV_{PP}
 - Voltage noise: 7.2 nV/ $\sqrt{\text{Hz}}$
- A_{OL} , CMRR, and PSRR: > 126 dB (full temperature range)
- Gain bandwidth product: 3.6 MHz
- Low quiescent current: 240 μA (max)
- Slew rate: 4 V/ μs
- Overload power limiter
- Rail-to-rail output
- EMI and RFI filtered inputs
- Wide supply: 4.5 V to 36 V
- Temperature range: -40°C to $+125^\circ\text{C}$
- Available in standard grade (OPAx205A) and high grade (OPA2205, preview)
- Available with $\pm 40\text{-V}$ overvoltage protection in the [OPA206](#) and [OPA2206](#)

2 Applications

- [Flow transmitter](#)
- [String inverter](#)
- [Data acquisition \(DAQ\)](#)
- [Source measurement unit \(SMU\)](#)
- [Lab and field instrumentation](#)
- [Battery test](#)
- [Analog input module](#)
- [Pressure transmitter](#)

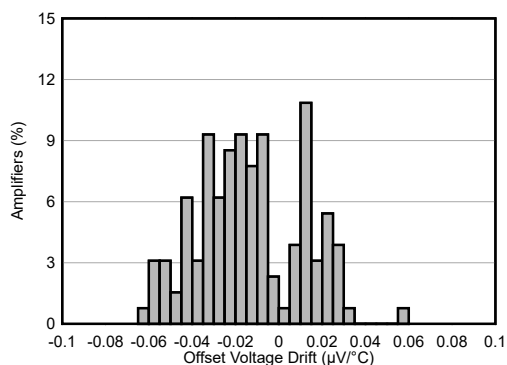

OPAx205 Offset Voltage Drift

3 Description

The OPA205, OPA2205, and OPA4205 (OPAx205) are the next generation of the industry-standard OPAx277 family. The [OPA206](#) and [OPA2206](#) are related devices with the same op-amp core, but with the added feature of input overvoltage protection $\pm 40 \text{ V}$ above the supplies. These devices are precision, bipolar e-trim™ op amps with super-beta inputs. TI's proprietary trimming technology is used to achieve a typical input offset voltage of $\pm 4 \mu\text{V}$ ($\pm 2 \mu\text{V}$, high grade), and a typical input offset voltage drift of $\pm 0.08 \mu\text{V}$ ($\pm 0.04 \mu\text{V}$, high grade).

Designed on a bipolar process, the OPAx205 provide 3.6-MHz gain bandwidth for a mere 220 μA of quiescent current. The devices also achieve a low voltage noise density of only 7.2 nV/ $\sqrt{\text{Hz}}$ at 1 kHz. The super-beta inputs of the OPAx205 have a very low input bias current of 100 pA (typical) and a current noise density of 110 fA/ $\sqrt{\text{Hz}}$.

The high performance of the OPAx205 makes these devices an excellent choice for systems requiring high precision and low power consumption, such as flow and pressure transmitters, portable data acquisition (DAQ) systems, and high-density source measurement units (SMU).

Device Information

PART NUMBER	CHANNELS	PACKAGE ⁽¹⁾
OPA205	Single	D (SOIC, 8)
OPA2205 ⁽²⁾	Dual	D (SOIC, 8)
	Dual	DGK (VSSOP, 8)
OPA4205	Quad	D (SOIC, 14)
	Quad	PW (TSSOP, 14)

- For all available packages, see the package option addendum at the end of the data sheet.
- High-grade version is preview (not Production Data).

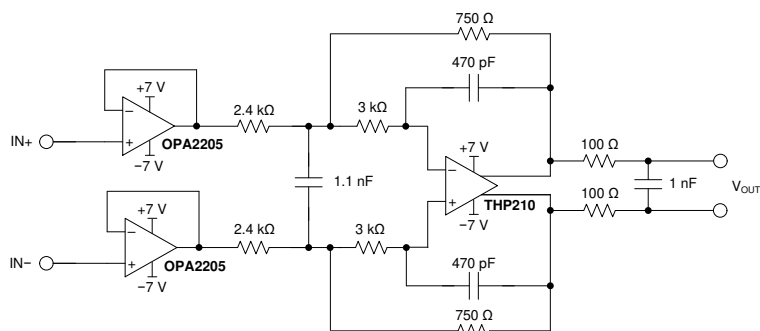

OPA2205 Typical Application



Table of Contents

1 Features	1	8.2 Functional Block Diagram.....	22
2 Applications	1	8.3 Feature Description.....	23
3 Description	1	8.4 Device Functional Modes.....	24
4 Revision History	2	9 Application and Implementation	25
5 Pin Configuration and Functions	4	9.1 Application Information.....	25
6 Specifications	6	9.2 Typical Applications.....	25
6.1 Absolute Maximum Ratings.....	6	9.3 Power Supply Recommendations.....	28
6.2 ESD Ratings.....	6	9.4 Layout.....	28
6.3 Recommended Operating Conditions.....	6	10 Device and Documentation Support	30
6.4 Thermal Information: OPA205.....	7	10.1 Device Support.....	30
6.5 Thermal Information: OPA2205.....	7	10.2 Documentation Support.....	30
6.6 Thermal Information: OPA4205.....	7	10.3 Receiving Notification of Documentation Updates.....	30
6.7 Electrical Characteristics: $V_S = \pm 5\text{ V}$	8	10.4 Support Resources.....	30
6.8 Electrical Characteristics: $V_S = \pm 15\text{ V}$	10	10.5 Trademarks.....	30
6.9 Typical Characteristics.....	12	10.6 Electrostatic Discharge Caution.....	30
7 Parameter Measurement Information	21	10.7 Glossary.....	30
7.1 Typical Specifications and Distributions.....	21	11 Mechanical, Packaging, and Orderable Information	30
8 Detailed Description	22		
8.1 Overview.....	22		

4 Revision History

NOTE: Page numbers for previous revisions may differ from page numbers in the current version.

Changes from Revision E (December 2022) to Revision F (March 2023)	Page
• Changed title to align with standard-grade device specifications.....	1
• Added OPA2205 D (SOIC, 8) package and associated content as production data.....	1
• Added OPA4205 D (SOIC, 14) package and associated content as production data.....	1
• Changed maximum input bias from $\pm 0.4\text{ nA}$ to $\pm 0.5\text{ nA}$	21
• Changed offset and offset drift values to match standard-grade device specifications in <i>Detailed Design Description</i>	26
• Changed Figure 9-6 to show correct V_{S+} connection.....	29
Changes from Revision D (September 2022) to Revision E (December 2022)	Page
• Added OPA4205 TSSOP package and associated content as production data.....	1
• Changed typical input offset voltage from $8\text{ }\mu\text{V}$ to $4\text{ }\mu\text{V}$ in <i>Electrical Characteristics</i>	8
• Changed maximum input offset voltage from $50\text{ }\mu\text{V}$ to $25\text{ }\mu\text{V}$ in <i>Electrical Characteristics</i>	8
• Changed maximum input offset voltage over temperature from $80\text{ }\mu\text{V}$ to $55\text{ }\mu\text{V}$ in <i>Electrical Characteristics</i>	8
• Changed typical input offset voltage from $8\text{ }\mu\text{V}$ to $4\text{ }\mu\text{V}$ in <i>Electrical Characteristics</i>	10
• Changed maximum input offset voltage from $50\text{ }\mu\text{V}$ to $25\text{ }\mu\text{V}$ in <i>Electrical Characteristics</i>	10
• Changed maximum input offset voltage over temperature from $80\text{ }\mu\text{V}$ to $55\text{ }\mu\text{V}$ in <i>Electrical Characteristics</i>	10
Changes from Revision C (July 2022) to Revision D (September 2022)	Page
• Changed OPA205 (SOIC) from preview to production data (active).....	1
Changes from Revision B (August 2021) to Revision C (July 2022)	Page
• Added OPA205 D (SOIC) package as advanced information (preview).....	1
Changes from Revision A (May 2021) to Revision B (August 2021)	Page
• Changed Figure 6-22, <i>Voltage Noise Density vs Frequency</i> , to show voltage noise density instead of current noise density.....	12

Changes from Revision * (April 2020) to Revision A (May 2021)	Page
• Updated the numbering format for tables, figures, and cross-references throughout the document.....	1
• Changed OPA2205 from advanced information (preview) to production data (active).....	1
• Changed both <i>Electrical Characteristics</i> tables to show differentiated performance between OPA2205 (high grade) and OPA2205A (standard grade).....	8

5 Pin Configuration and Functions

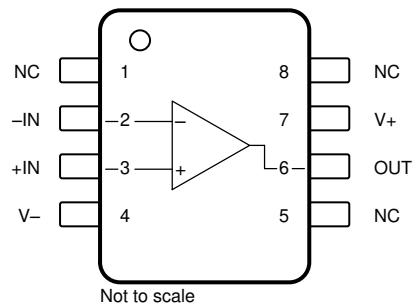

Figure 5-1. OPA205 D Package, 8-Pin SOIC (Top View)

Table 5-1. Pin Functions: OPA205

PIN		TYPE	DESCRIPTION
NAME	NO.		
+IN	3	Input	Noninverting input
-IN	2	Input	Inverting input
NC	1, 5, 8	—	No internal connection (can be left floating)
OUT	6	Output	Output
V+	7	—	Positive (highest) power supply
V-	4	—	Negative (lowest) power supply

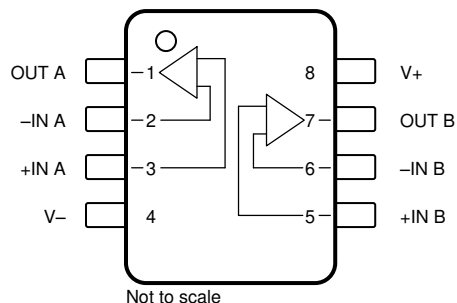

Figure 5-2. OPA2205 DGK Package, 8-Pin VSSOP and D Package, 8-pin SOIC (Top View)

Table 5-2. Pin Functions: OPA2205

PIN		TYPE	DESCRIPTION
NAME	NO.		
+IN A	3	Input	Noninverting input, channel A
-IN A	2	Input	Inverting input, channel A
+IN B	5	Input	Noninverting input, channel B
-IN B	6	Input	Inverting input, channel B
OUT A	1	Output	Output, channel A
OUT B	7	Output	Output, channel B
V+	8	—	Positive (highest) power supply
V-	4	—	Negative (lowest) power supply

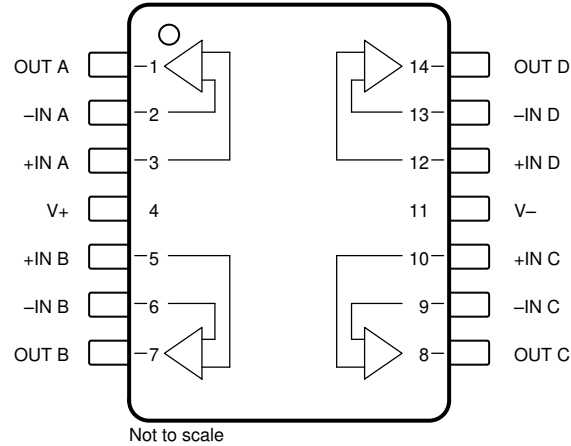

Figure 5-3. OPA4205 PW Package, 14-Pin TSSOP and D Package, 14-Pin SOIC (Top View)

Pin Functions: OPA4205

PIN		TYPE	DESCRIPTION
NAME	NO.		
+IN A	3	Input	Noninverting input, channel A
+IN B	5	Input	Noninverting input, channel B
+IN C	10	Input	Noninverting input, channel C
+IN D	12	Input	Noninverting input, channel D
-IN A	2	Input	Inverting input, channel A
-IN B	6	Input	Inverting input, channel B
-IN C	9	Input	Inverting input, channel C
-IN D	13	Input	Inverting input, channel D
OUT A	1	Output	Output, channel A
OUT B	7	Output	Output, channel B
OUT C	8	Output	Output, channel C
OUT D	14	Output	Output, channel D
V+	4	—	Positive (highest) power supply
V-	11	—	Negative (lowest) power supply

6 Specifications

6.1 Absolute Maximum Ratings

over operating free-air temperature range (unless otherwise noted)⁽¹⁾

			MIN	MAX	UNIT
V _S	Supply voltage, V _S = (V+) – (V–)	Single supply		40	V
		Dual supply		±20	
	Signal input pin voltage	Common-mode	(V–) – 0.5	(V+) + 0.5	V
		Differential		±0.5	
	Signal input pin current			±10	mA
	Output short-circuit ⁽²⁾		Continuous		
T _A	Operating temperature		–40	150	°C
T _J	Junction temperature			150	°C
T _{STG}	Storage temperature		–65	150	°C

- (1) Operation outside the Absolute Maximum Ratings may cause permanent device damage. Absolute Maximum Ratings do not imply functional operation of the device at these or any other conditions beyond those listed under Recommended Operating Conditions. If used outside the Recommended Operating Conditions but within the Absolute Maximum Ratings, the device may not be fully functional, and this may affect device reliability, functionality, performance, and shorten the device lifetime.
- (2) Short-circuit to ground, one amplifier per package.

6.2 ESD Ratings

			VALUE	UNIT
V _(ESD)	Electrostatic discharge	Human-body model (HBM), per ANSI/ESDA/JEDEC JS-001 ⁽¹⁾	±2000	V
		Charged-device model (CDM), per ANSI/ESDA/JEDEC JS-002 ⁽²⁾	±1000	

- (1) JEDEC document JEP155 states that 500-V HBM allows safe manufacturing with a standard ESD control process.
- (2) JEDEC document JEP157 states that 250-V CDM allows safe manufacturing with a standard ESD control process.

6.3 Recommended Operating Conditions

over operating free-air temperature range (unless otherwise noted)

			MIN	NOM	MAX	UNIT
V _S	Supply voltage, V _S = (V+) – (V–)	Single supply	4.5		36	V
		Dual supply	±2.25		±18	
T _A	Operating temperature		–40		125	°C

6.4 Thermal Information: OPA205

THERMAL METRIC ⁽¹⁾		OPA205		UNIT
		D (SOIC)		
		8 PINS		
R _{θJA}	Junction-to-ambient thermal resistance	121.5		°C/W
R _{θJC(top)}	Junction-to-case (top) thermal resistance	64.3		°C/W
R _{θJB}	Junction-to-board thermal resistance	65.0		°C/W
ψ _{JT}	Junction-to-top characterization parameter	18.2		°C/W
ψ _{JB}	Junction-to-board characterization parameter	64.3		°C/W
R _{θJC(bot)}	Junction-to-case (bottom) thermal resistance	N/A		°C/W

(1) For more information about traditional and new thermal metrics, see the [Semiconductor and IC Package Thermal Metrics](#) application report.

6.5 Thermal Information: OPA2205

THERMAL METRIC ⁽¹⁾		OPA2205		UNIT
		D (SOIC)	DGK (VSSOP)	
		8 PINS	8 PINS	
R _{θJA}	Junction-to-ambient thermal resistance	126.9	175.6	°C/W
R _{θJC(top)}	Junction-to-case (top) thermal resistance	67.1	63.1	°C/W
R _{θJB}	Junction-to-board thermal resistance	70.3	97.2	°C/W
ψ _{JT}	Junction-to-top characterization parameter	18.8	7.8	°C/W
ψ _{JB}	Junction-to-board characterization parameter	69.5	95.5	°C/W
R _{θJC(bot)}	Junction-to-case (bottom) thermal resistance	N/A	N/A	°C/W

(1) For more information about traditional and new thermal metrics, see the [Semiconductor and IC Package Thermal Metrics](#) application report.

6.6 Thermal Information: OPA4205

THERMAL METRIC ⁽¹⁾		OPA4205		UNIT
		D (SOIC)	PW (TSSOP)	
		14 PINS	14 PINS	
R _{θJA}	Junction-to-ambient thermal resistance	86.5	117.1	°C/W
R _{θJC(top)}	Junction-to-case (top) thermal resistance	38.5	36.0	°C/W
R _{θJB}	Junction-to-board thermal resistance	43.5	59.3	°C/W
ψ _{JT}	Junction-to-top characterization parameter	7.4	2.6	°C/W
ψ _{JB}	Junction-to-board characterization parameter	42.9	58.3	°C/W
R _{θJC(bot)}	Junction-to-case (bottom) thermal resistance	N/A	N/A	°C/W

(1) For more information about traditional and new thermal metrics, see the [Semiconductor and IC Package Thermal Metrics](#) application report.

6.7 Electrical Characteristics: $V_S = \pm 5\text{ V}$

at $T_A = 25^\circ\text{C}$, $V_{CM} = V_{OUT} = \text{midsupply}$, and $R_L = 10\text{ k}\Omega$ connected to $V_S / 2$ (unless otherwise noted)

PARAMETER		TEST CONDITIONS		MIN	TYP	MAX	UNIT	
OFFSET VOLTAGE								
V_{OS}	Input offset voltage	OPA2205			± 2	± 15	μV	
			$T_A = -40^\circ\text{C to } +125^\circ\text{C}$			± 25		
		OPAx205A			± 4	± 25		
			$T_A = -40^\circ\text{C to } +125^\circ\text{C}$			± 55		
dV_{OS}/dT	Input offset voltage drift	OPA2205	$T_A = -40^\circ\text{C to } +125^\circ\text{C}$		± 0.04	± 0.2	$\mu\text{V}/^\circ\text{C}$	
		OPAx205A	$T_A = -40^\circ\text{C to } +125^\circ\text{C}$		± 0.08	± 0.5		
PSRR	Power supply rejection ratio	OPA2205, $V_S = \pm 2.25\text{ V to } \pm 18\text{ V}$			± 0.05	± 0.25	$\mu\text{V/V}$	
			$T_A = -40^\circ\text{C to } +125^\circ\text{C}$					± 0.5
		OPAx205A, $V_S = \pm 2.25\text{ V to } \pm 18\text{ V}$			± 0.05	± 0.5		
			$T_A = -40^\circ\text{C to } +125^\circ\text{C}$			± 1		
	Channel separation, (dual, quad)	f = dc			130	dB		
		f = 100 kHz			110			
INPUT BIAS CURRENT								
I_B	Input bias current	OPA2205			± 0.1	± 0.4	nA	
			$T_A = 0^\circ\text{C to } 85^\circ\text{C}$					± 0.6
			$T_A = -40^\circ\text{C to } +125^\circ\text{C}$					± 0.9
		OPAx205A			± 0.1	± 0.5		
			$T_A = 0^\circ\text{C to } 85^\circ\text{C}$			± 0.75		
			$T_A = -40^\circ\text{C to } +125^\circ\text{C}$			± 1		
I_{OS}	Input offset current				± 0.1	± 0.4	nA	
		$T_A = 0^\circ\text{C to } 85^\circ\text{C}$				± 0.5		
		$T_A = -40^\circ\text{C to } +125^\circ\text{C}$				± 0.6		
NOISE								
	Input voltage noise	f = 0.1 Hz to 10 Hz			0.2		μV_{PP}	
e_n	Input voltage noise density	f = 10 Hz			7.4	$\text{nV}/\sqrt{\text{Hz}}$		
		f = 100 Hz			7.2			
		f = 1 kHz			7.2			
i_n	Input current noise density	f = 1 kHz			110	$\text{fA}/\sqrt{\text{Hz}}$		
INPUT VOLTAGE								
V_{CM}	Common-mode voltage			$(V-) + 1$		$(V+) - 1.4$	V	
CMRR	Common-mode rejection ratio	OPA2205, $(V-) + 1\text{ V} < V_{CM} < (V+) - 1.4\text{ V}$, $T_A = -40^\circ\text{C to } +125^\circ\text{C}$		124	140	dB		
		OPAx205A, $(V-) + 1\text{ V} < V_{CM} < (V+) - 1.4\text{ V}$, $T_A = -40^\circ\text{C to } +125^\circ\text{C}$		124	140			
INPUT IMPEDANCE								
Z_{ID}	Differential				$9 \parallel 4.4$		$\text{M}\Omega \parallel \text{pF}$	
Z_{ICM}	Common-mode				$300 \parallel 4.4$		$\text{G}\Omega \parallel \text{pF}$	

6.7 Electrical Characteristics: $V_S = \pm 5\text{ V}$ (continued)

at $T_A = 25^\circ\text{C}$, $V_{CM} = V_{OUT} = \text{mid supply}$, and $R_L = 10\text{ k}\Omega$ connected to $V_S / 2$ (unless otherwise noted)

PARAMETER		TEST CONDITIONS		MIN	TYP	MAX	UNIT
OPEN-LOOP GAIN							
A_{OL}	Open-loop voltage gain	OPA2205, $T_A = -40^\circ\text{C}$ to $+125^\circ\text{C}$, $(V-) + 200\text{ mV} < V_O < (V+) - 200\text{ mV}$	$R_L = 10\text{ k}\Omega$	126	132		dB
			$R_L = 2\text{ k}\Omega$	126	130		
		OPAx205A, $T_A = -40^\circ\text{C}$ to $+125^\circ\text{C}$, $(V-) + 200\text{ mV} < V_O < (V+) - 200\text{ mV}$	$R_L = 10\text{ k}\Omega$	126	132		
			$R_L = 2\text{ k}\Omega$	126	130		
FREQUENCY RESPONSE							
GBW	Gain-bandwidth product				3.6		MHz
SR	Slew rate	4-V step, gain = -1			3.2		V/ μs
	Phase margin	$R_L = 10\text{ k}\Omega$, $C_L = 25\text{ pF}$			67		degrees
t_s	Settling time	To 0.024% (12-bit), 4-V step, gain = 1, $C_L = 30\text{ pF}$	Falling		2.2		μs
			Rising		2.8		
	Overload recovery time	Gain = -10			0.3		μs
THD+N	Total harmonic distortion + noise	$V_O = 5\text{ V}_{PP}$, gain = +1, $f = 1\text{ kHz}$, $R_L = 2\text{ k}\Omega$			0.0004		%
OUTPUT							
	Voltage output swing from rail	$A_{OL} > 126\text{ dB}$	$R_L = 10\text{ k}\Omega$	$(V-) + 0.2$		$(V+) - 0.2$	V
			$R_L = 2\text{ k}\Omega$	$(V-) + 0.2$		$(V+) - 0.2$	
		$T_A = -40^\circ\text{C}$ to $+125^\circ\text{C}$, $R_L = 10\text{ k}\Omega$		$(V-) + 0.2$		$(V+) - 0.2$	
I_{SC}	Short-circuit current				± 25		mA
C_{LOAD}	Capacitive load drive				See Typical Characteristics		
R_O	Open-loop output impedance				See Typical Characteristics		
POWER SUPPLY							
I_Q	Quiescent current per amplifier	$I_O = 0\text{ mA}$			220	240	μA
			$T_A = -40^\circ\text{C}$ to $+125^\circ\text{C}$			310	

6.8 Electrical Characteristics: $V_S = \pm 15\text{ V}$

at $T_A = 25^\circ\text{C}$, $V_{CM} = V_{OUT} = \text{mid supply}$, and $R_L = 10\text{ k}\Omega$ connected to $V_S / 2$ (unless otherwise noted)

PARAMETER		TEST CONDITIONS		MIN	TYP	MAX	UNIT	
OFFSET VOLTAGE								
V_{OS}	Input offset voltage	OPA2205			± 2	± 15	μV	
			$T_A = -40^\circ\text{C to } +125^\circ\text{C}$			± 25		
		OPAx205A			± 4	± 25		
			$T_A = -40^\circ\text{C to } +125^\circ\text{C}$			± 55		
dV_{OS}/dT	Input offset voltage drift	OPA2205	$T_A = -40^\circ\text{C to } +125^\circ\text{C}$		± 0.04	± 0.2	$\mu\text{V}/^\circ\text{C}$	
		OPAx205A	$T_A = -40^\circ\text{C to } +125^\circ\text{C}$		± 0.08	± 0.5		
PSRR	Power supply rejection ratio	OPA2205, $V_S = \pm 2.25\text{ V to } \pm 18\text{ V}$			± 0.05	± 0.25	$\mu\text{V/V}$	
			$T_A = -40^\circ\text{C to } +125^\circ\text{C}$					± 0.5
		OPAx205A, $V_S = \pm 2.25\text{ V to } \pm 18\text{ V}$			± 0.05	± 0.5		
			$T_A = -40^\circ\text{C to } +125^\circ\text{C}$			± 1		
	Channel separation, (dual, quad)	f = dc			130		dB	
		f = 100 kHz			110			
INPUT BIAS CURRENT								
I_B	Input bias current	OPA2205			± 0.1	± 0.4	nA	
			$T_A = 0^\circ\text{C to } 85^\circ\text{C}$					± 0.6
			$T_A = -40^\circ\text{C to } +125^\circ\text{C}$					± 0.9
		OPAx205A			± 0.1	± 0.5		
			$T_A = 0^\circ\text{C to } 85^\circ\text{C}$					± 1
			$T_A = -40^\circ\text{C to } +125^\circ\text{C}$					± 1.2
I_{OS}	Input offset current				± 0.1	± 0.4	nA	
		$T_A = 0^\circ\text{C to } 85^\circ\text{C}$				± 0.8		
		$T_A = -40^\circ\text{C to } +125^\circ\text{C}$				± 0.9		
NOISE								
	Input voltage noise	f = 0.1 Hz to 10 Hz			0.2		μV_{PP}	
e_n	Input voltage noise density	f = 10 Hz			7.4		$\text{nV}/\sqrt{\text{Hz}}$	
		f = 100 Hz			7.2			
		f = 1 kHz			7.2			
i_n	Input current noise density	f = 1 kHz			110		$\text{fA}/\sqrt{\text{Hz}}$	
INPUT VOLTAGE								
V_{CM}	Common-mode voltage			$(V-) + 1$		$(V+) - 1.4$	V	
CMRR	Common-mode rejection ratio	OPA2205, $(V-) + 1\text{ V} < V_{CM} < (V+) - 1.4\text{ V}$			126	140	dB	
			$T_A = -40^\circ\text{C to } +125^\circ\text{C}$			124		140
		OPAx205A, $(V-) + 1\text{ V} < V_{CM} < (V+) - 1.4\text{ V}$			126	140		
			$T_A = -40^\circ\text{C to } +125^\circ\text{C}$			124		140
INPUT IMPEDANCE								
Z_{ID}	Differential				9 4.4		$\text{M}\Omega \text{pF}$	
Z_{ICM}	Common-mode				300 4.3		$\text{G}\Omega \text{pF}$	

6.8 Electrical Characteristics: $V_S = \pm 15\text{ V}$ (continued)

at $T_A = 25^\circ\text{C}$, $V_{CM} = V_{OUT} = \text{mid supply}$, and $R_L = 10\text{ k}\Omega$ connected to $V_S / 2$ (unless otherwise noted)

PARAMETER		TEST CONDITIONS		MIN	TYP	MAX	UNIT
OPEN-LOOP GAIN							
A_{OL}	Open-loop voltage gain	OPA2205, $T_A = -40^\circ\text{C}$ to $+125^\circ\text{C}$	$R_L = 10\text{ k}\Omega$, $(V_-) + 200\text{ mV} < V_O < (V_+) - 200\text{ mV}$	132	135		dB
			$R_L = 2\text{ k}\Omega$, $(V_-) + 350\text{ mV} < V_O < (V_+) - 350\text{ mV}$	132	135		
		OPAx205A, $T_A = -40^\circ\text{C}$ to $+125^\circ\text{C}$	$R_L = 10\text{ k}\Omega$, $(V_-) + 200\text{ mV} < V_O < (V_+) - 200\text{ mV}$	126	132		
			$R_L = 2\text{ k}\Omega$, $(V_-) + 350\text{ mV} < V_O < (V_+) - 350\text{ mV}$	126	130		
FREQUENCY RESPONSE							
GBW	Gain-bandwidth product	$C_L = 30\text{ pF}$			3.6		MHz
SR	Slew rate	10-V step, gain = -1			4		V/ μs
	Phase margin	$R_L = 10\text{ k}\Omega$, $C_L = 25\text{ pF}$			58		degrees
t_s	Settling time	To 0.024% (12-bit), 10-V step, gain = 1, $C_L = 30\text{ pF}$	Falling		2.8		μs
			Rising		4.5		
	Overload recovery time	Gain = -10			0.2		μs
THD+N	Total harmonic distortion + noise	$V_O = 5\text{ V}_{PP}$, gain = +1, f = 1 kHz, $R_L = 2\text{ k}\Omega$			0.0004		%
OUTPUT							
	Voltage output swing from rail	$A_{OL} > 126\text{ dB}$	$R_L = 10\text{ k}\Omega$	$(V_-) + 0.2$	$(V_+) - 0.2$		V
			$R_L = 2\text{ k}\Omega$	$(V_-) + 0.35$	$(V_+) - 0.35$		
		$T_A = -40^\circ\text{C}$ to $+125^\circ\text{C}$, $R_L = 10\text{ k}\Omega$		$(V_-) + 0.2$	$(V_+) - 0.2$		
I_{SC}	Short-circuit current				± 25		mA
C_{LOAD}	Capacitive load drive				See Typical Characteristics		
R_O	Open-loop output impedance				See Typical Characteristics		
POWER SUPPLY							
I_Q	Quiescent current per amplifier	$I_O = 0\text{ mA}$			220	240	μA
			$T_A = -40^\circ\text{C}$ to $+125^\circ\text{C}$			310	

6.9 Typical Characteristics

at $T_A = 25^\circ\text{C}$, $V_S = \pm 15\text{V}$, $V_{CM} = V_{OUT} = \text{mid supply}$, and $R_L = 10\text{ k}\Omega$ (unless otherwise noted)

Table 6-1. Table of Graphs

DESCRIPTION	FIGURE
Offset Voltage Production Distribution at 25°C	Figure 6-1
Offset Voltage at 125°C	Figure 6-2
Offset Voltage at -40°C	Figure 6-3
Offset Voltage vs Temperature	Figure 6-4
Offset Voltage Drift Distribution	Figure 6-5
Offset Voltage vs Output Voltage	Figure 6-6
Offset Voltage vs Power Supply Voltage	Figure 6-7
Power-Supply Rejection Ratio vs Temperature	Figure 6-8
Power-Supply and Common-Mode Rejection Ratio vs Frequency	Figure 6-9
Common-Mode Rejection Ratio vs Temperature	Figure 6-10
Offset Voltage vs Common-Mode Voltage	Figure 6-11
Offset Voltage vs V_{CM} at Low Supply	Figure 6-12
Offset Voltage vs V_{CM} at High Supply	Figure 6-13
Open-Loop Gain and Phase vs Frequency	Figure 6-14
Open-Loop Gain vs Swing From the Rail	Figure 6-15
Open-Loop Gain vs Temperature	Figure 6-16
Closed-Loop Gain vs Frequency	Figure 6-17
Input Bias Production Distribution	Figure 6-18
Input Bias vs Common-Mode Voltage	Figure 6-19
Input Bias and Input Offset Current vs Temperature	Figure 6-20
Input Offset Current Production Distribution	Figure 6-21
Voltage Noise Density vs Frequency	Figure 6-22
0.1-Hz to 10-Hz Noise	Figure 6-23
Total Harmonic Distortion + Noise Ratio vs Frequency	Figure 6-24
Total Harmonic Distortion + Noise Ratio vs Output Amplitude	Figure 6-25
Current Noise vs Frequency	Figure 6-26
Maximum Output Voltage vs Frequency	Figure 6-27
Output Voltage Swing vs Output Sourcing Current	Figure 6-28
Output Voltage Swing vs Output Sinking Current	Figure 6-29
Open-Loop Output Impedance vs Frequency	Figure 6-30
No Phase Reversal	Figure 6-31
Small-Signal Overshoot vs Capacitive Load, Gain = +1	Figure 6-32
Small-Signal Overshoot vs Capacitive Load, Gain = -1	Figure 6-33
Phase Margin vs Capacitive Load	Figure 6-34
Positive Overload Recovery, Gain = -1	Figure 6-35
Negative Overload Recovery, Gain = -1	Figure 6-36
Settling Time	Figure 6-37
Small-Signal Step Response, Gain = +1	Figure 6-38
Small-Signal Step Response, Gain = -1	Figure 6-39
Large-Signal Step Response, Gain = +1	Figure 6-40
Large-Signal Step Response, Gain = -1	Figure 6-41
Short-Circuit Current vs Temperature	Figure 6-42
Electromagnetic Interference Rejection (EMIRR)	Figure 6-43
Quiescent Current vs Supply Voltage	Figure 6-44
Quiescent Current vs Temperature	Figure 6-45

6.9 Typical Characteristics (continued)

at $T_A = 25^\circ\text{C}$, $V_S = \pm 15\text{V}$, $V_{CM} = V_{OUT} = \text{mid supply}$, and $R_L = 10\text{ k}\Omega$ (unless otherwise noted)

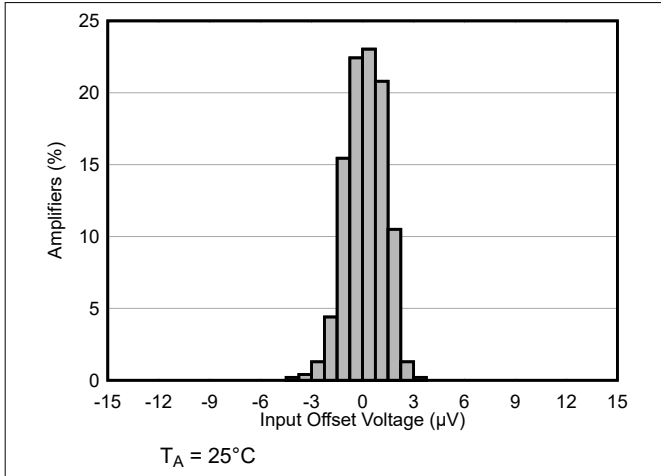

Figure 6-1. Offset Voltage Production Distribution at 25°C

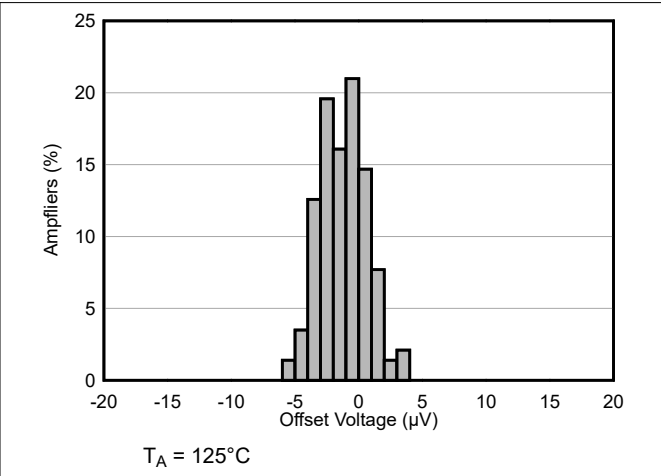

Figure 6-2. Offset Voltage Distribution at 125°C

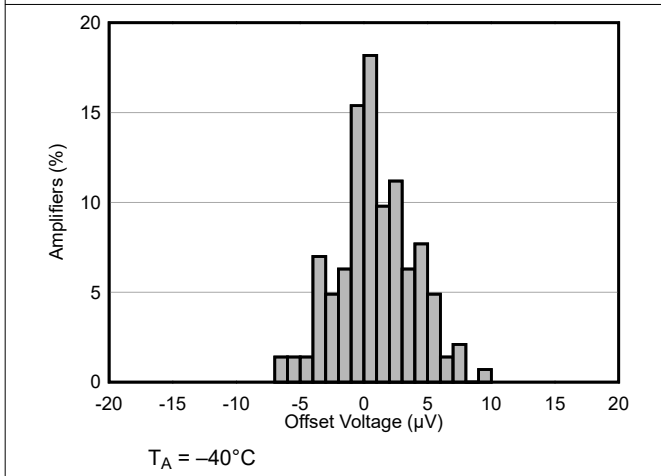

Figure 6-3. Offset Voltage Distribution at -40°C

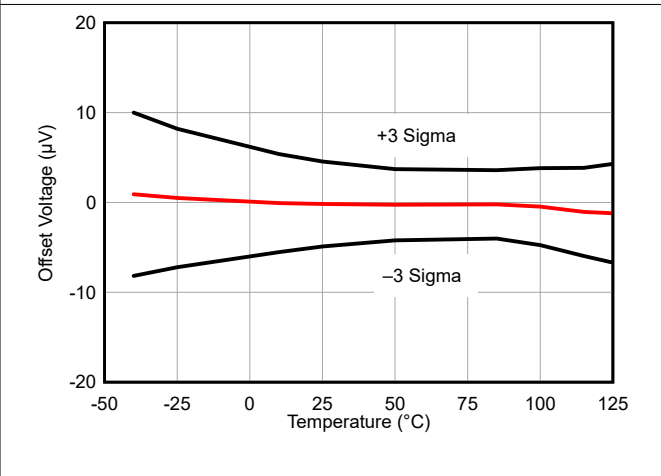

Figure 6-4. Offset Voltage vs Temperature

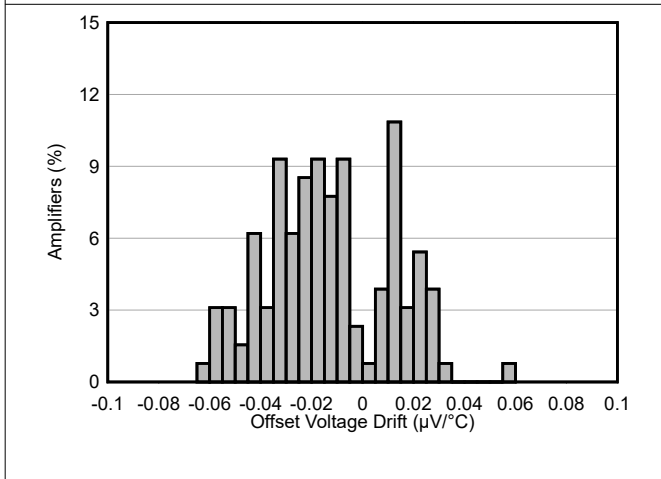

Figure 6-5. Offset Voltage Drift Distribution

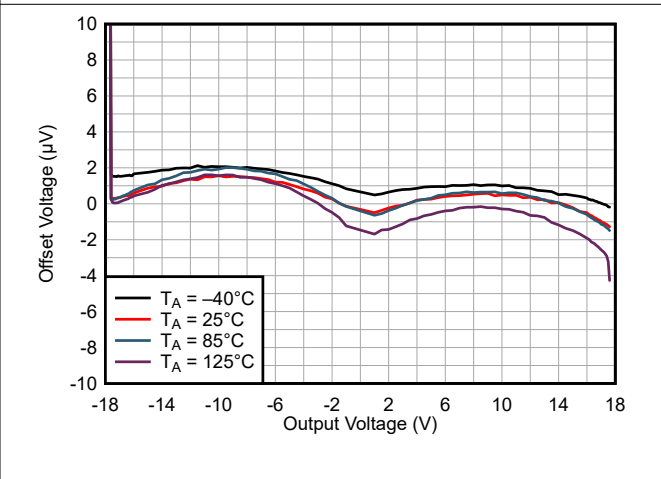

Figure 6-6. Offset Voltage vs Output Voltage

6.9 Typical Characteristics (continued)

at $T_A = 25^\circ\text{C}$, $V_S = \pm 15\text{V}$, $V_{CM} = V_{OUT} = \text{mid supply}$, and $R_L = 10\text{ k}\Omega$ (unless otherwise noted)

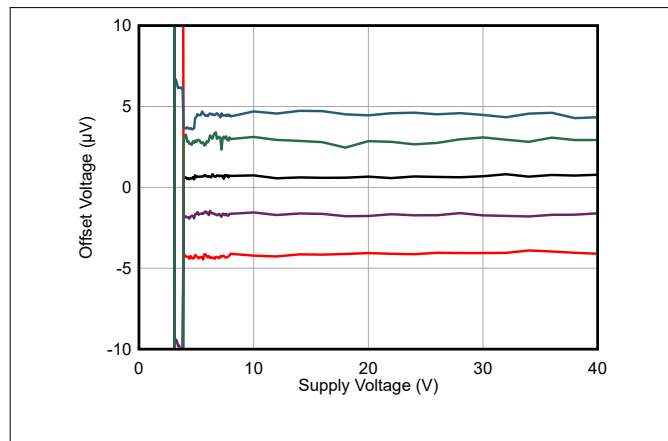

Figure 6-7. Offset Voltage vs Power Supply Voltage

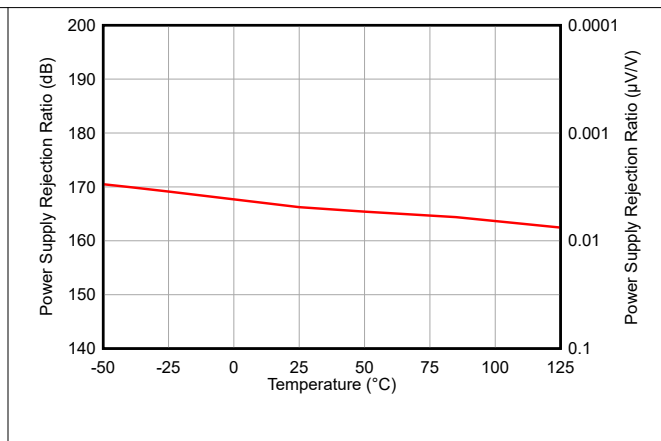

Figure 6-8. Power-Supply Rejection Ratio vs Temperature

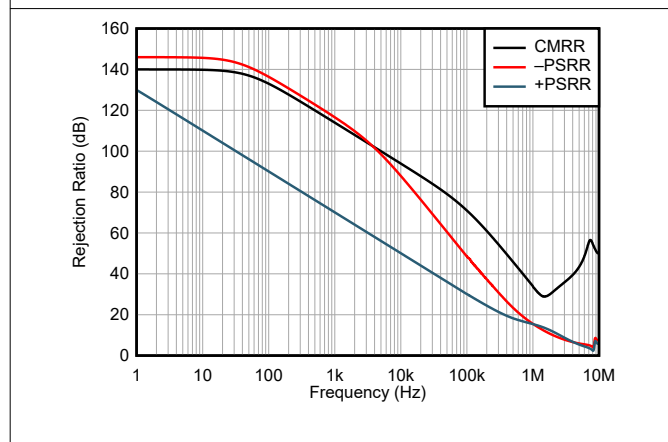

Figure 6-9. Power-Supply and Common-Mode Rejection Ratio vs Frequency

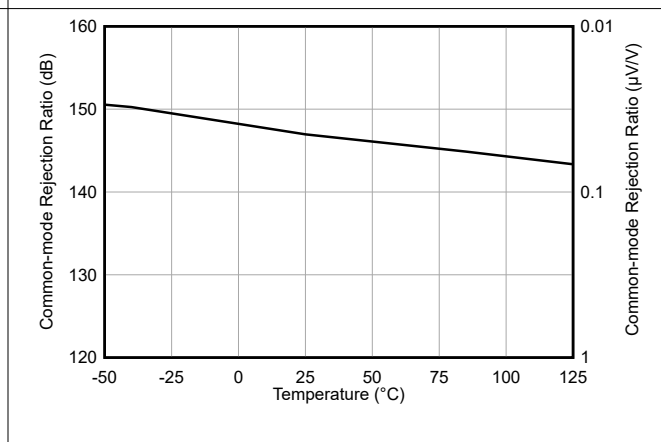

Figure 6-10. Common-Mode Rejection Ratio vs Temperature

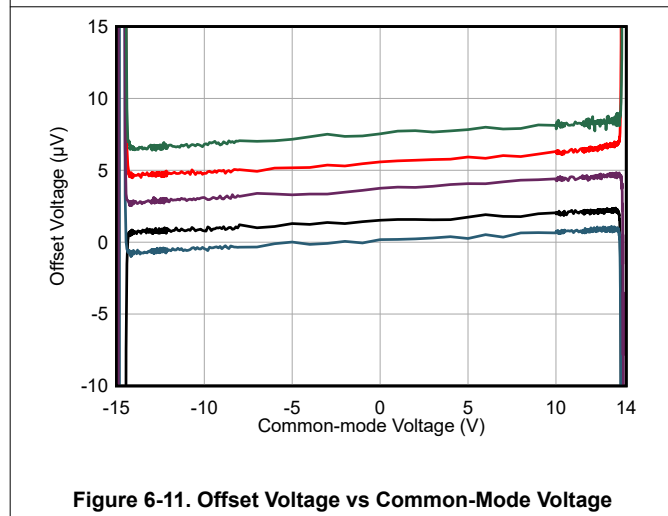

Figure 6-11. Offset Voltage vs Common-Mode Voltage

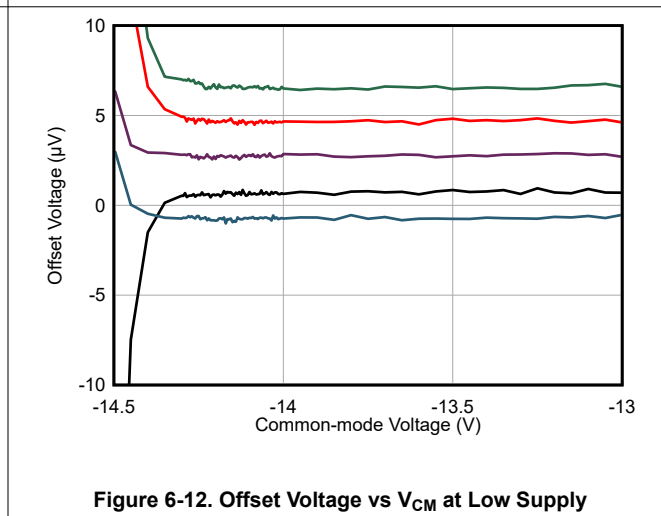

Figure 6-12. Offset Voltage vs V_{CM} at Low Supply

6.9 Typical Characteristics (continued)

at $T_A = 25^\circ\text{C}$, $V_S = \pm 15\text{V}$, $V_{CM} = V_{OUT} = \text{mid supply}$, and $R_L = 10\text{ k}\Omega$ (unless otherwise noted)

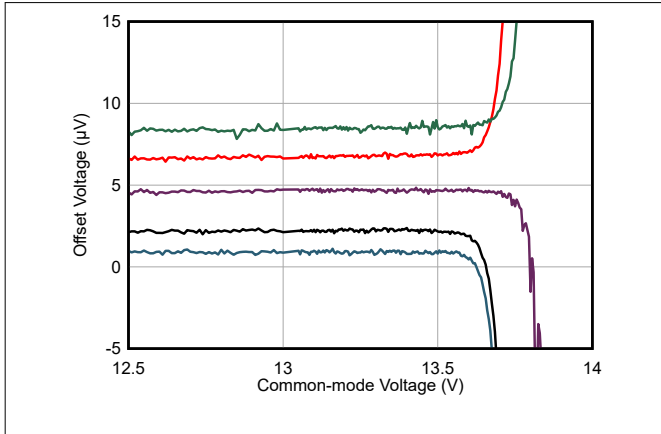

Figure 6-13. Offset Voltage vs V_{CM} at High Supply

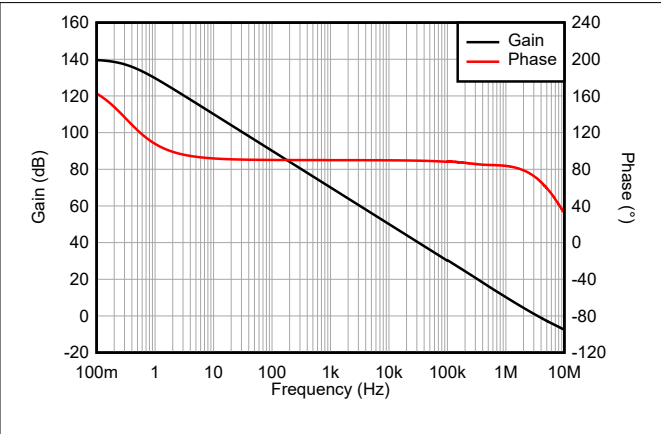

Figure 6-14. Open-Loop Gain and Phase vs Frequency

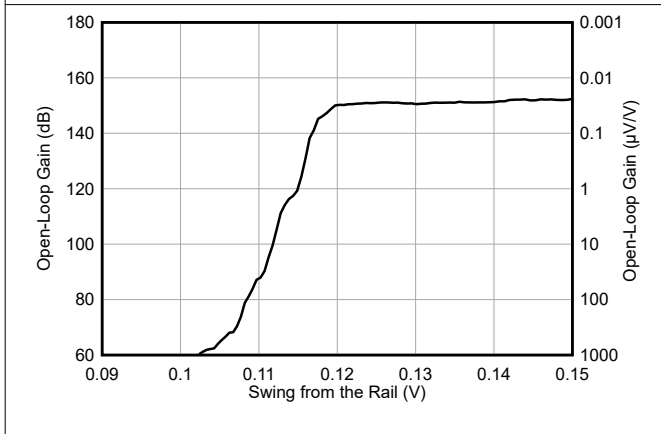

Figure 6-15. Open-Loop Gain vs Swing From the Rail

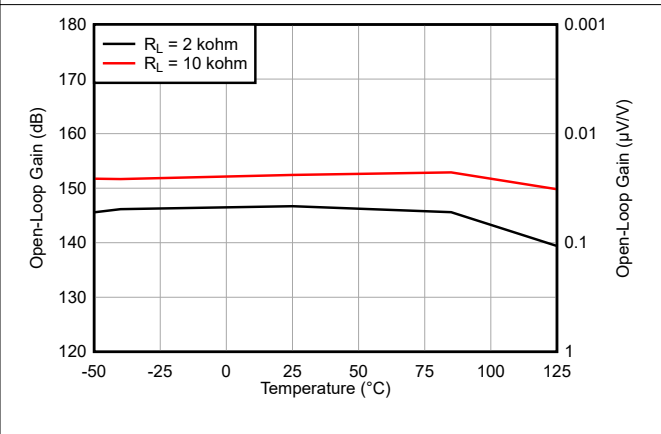

Figure 6-16. Open-Loop Gain vs Temperature

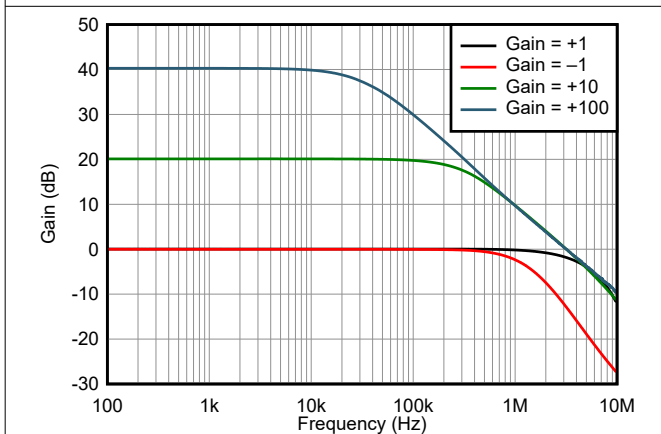

Figure 6-17. Closed-Loop Gain vs Frequency

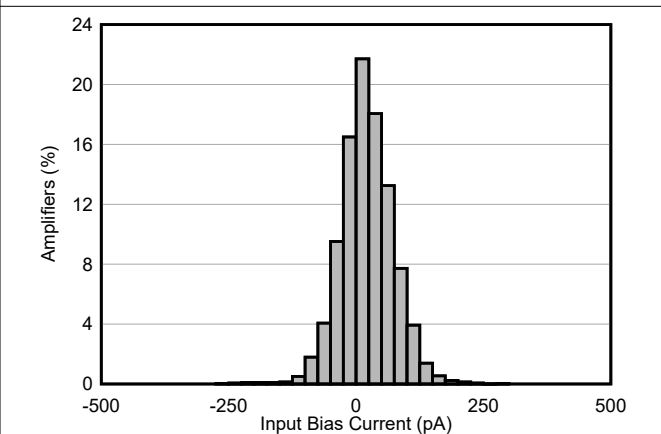

Figure 6-18. Input Bias Production Distribution

6.9 Typical Characteristics (continued)

at $T_A = 25^\circ\text{C}$, $V_S = \pm 15\text{V}$, $V_{CM} = V_{OUT} = \text{midsupply}$, and $R_L = 10\text{ k}\Omega$ (unless otherwise noted)

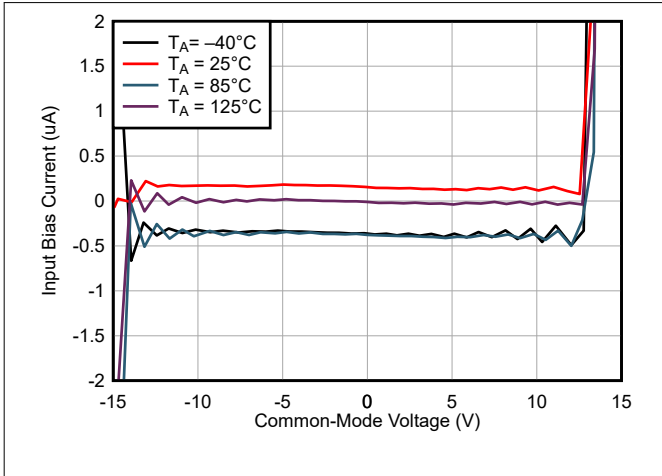

Figure 6-19. Input Bias vs Common-Mode Voltage

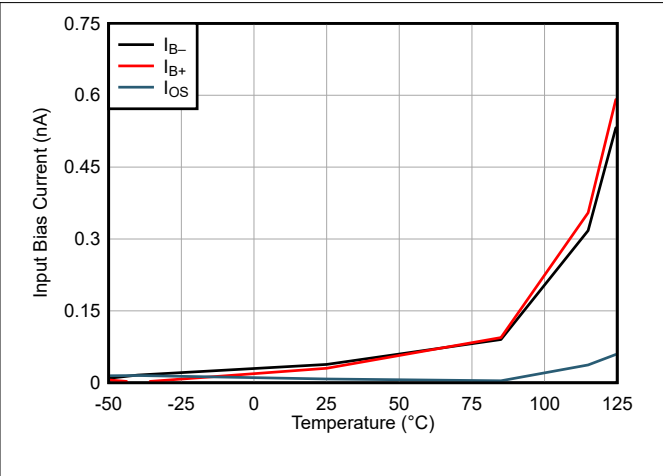

Figure 6-20. Input Bias and Input Offset Current vs Temperature

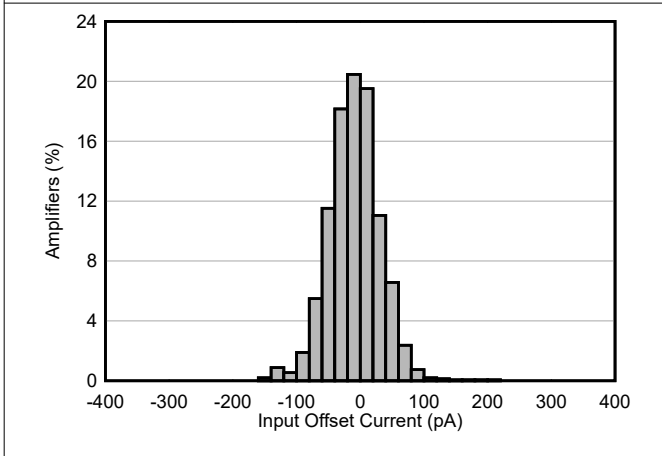

Figure 6-21. Input Offset Current Production Distribution

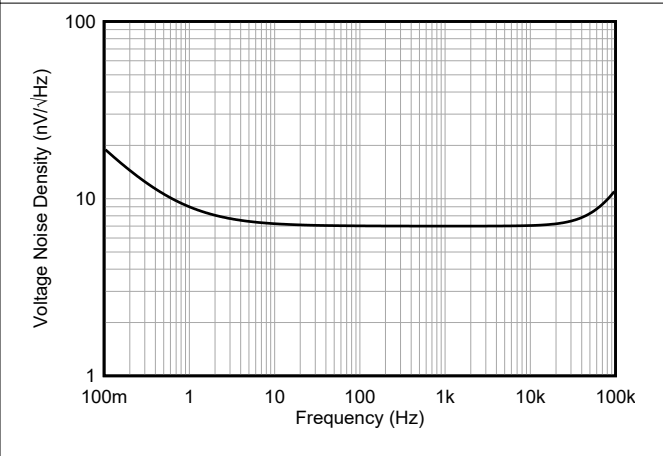

Figure 6-22. Voltage Noise Density vs Frequency

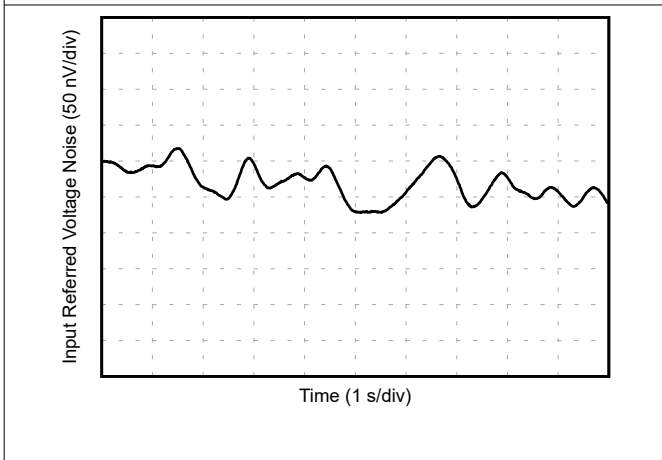

Figure 6-23. 0.1-Hz to 10-Hz Noise

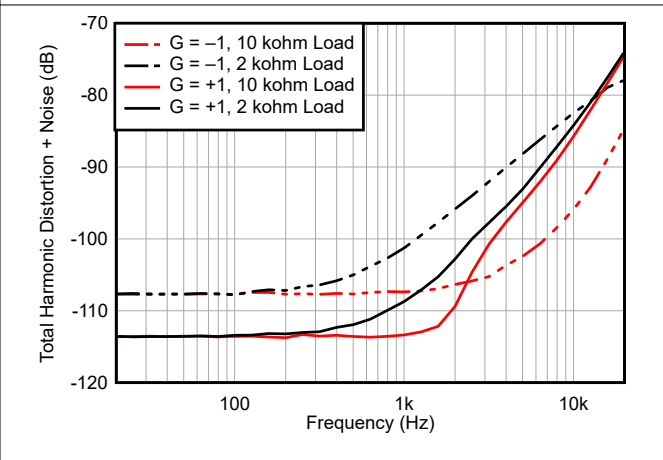

Figure 6-24. Total Harmonic Distortion + Noise Ratio vs Frequency

6.9 Typical Characteristics (continued)

at $T_A = 25^\circ\text{C}$, $V_S = \pm 15\text{V}$, $V_{CM} = V_{OUT} = \text{mid supply}$, and $R_L = 10\text{ k}\Omega$ (unless otherwise noted)

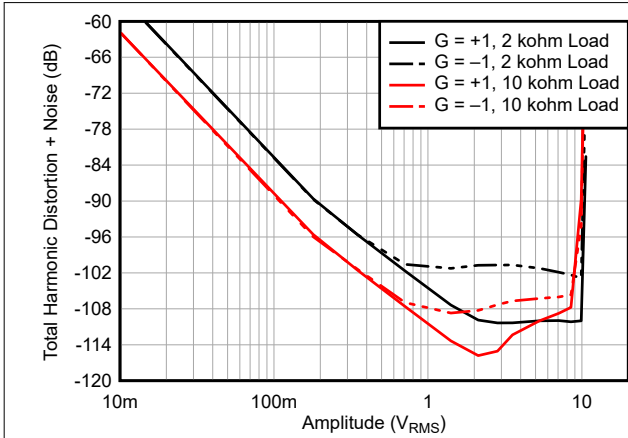

Figure 6-25. Total Harmonic Distortion + Noise Ratio vs Output Amplitude

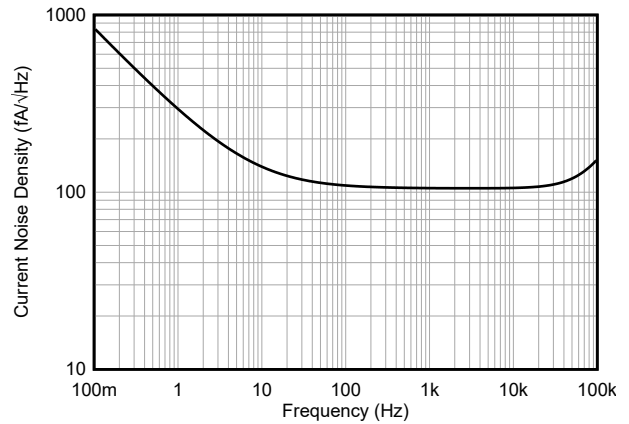

Figure 6-26. Current Noise vs Frequency

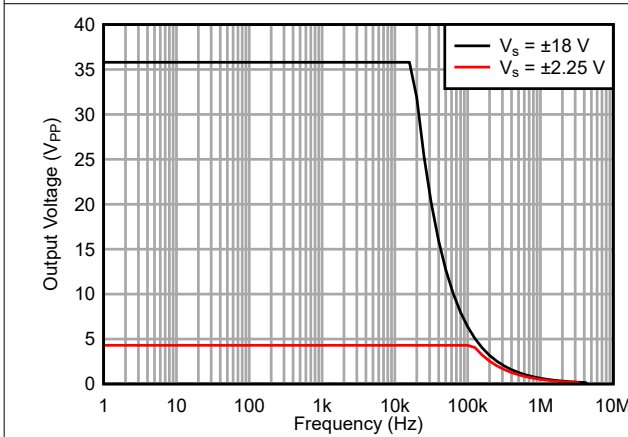

Figure 6-27. Maximum Output Voltage vs Frequency

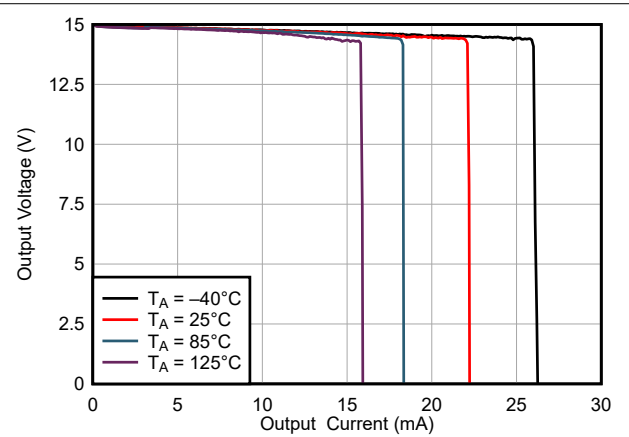

Figure 6-28. Output Voltage Swing vs Output Sourcing Current

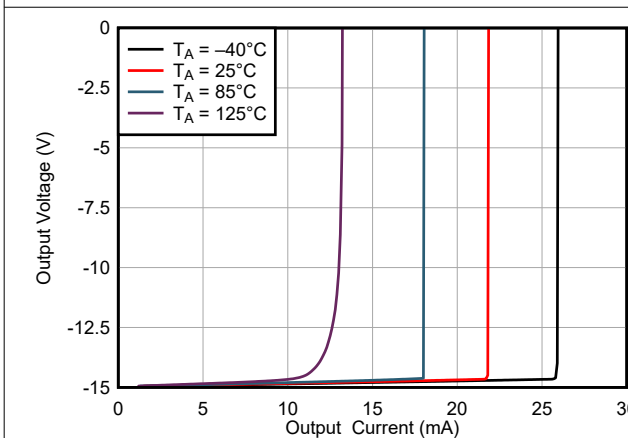

Figure 6-29. Output Voltage Swing vs Output Sinking Current

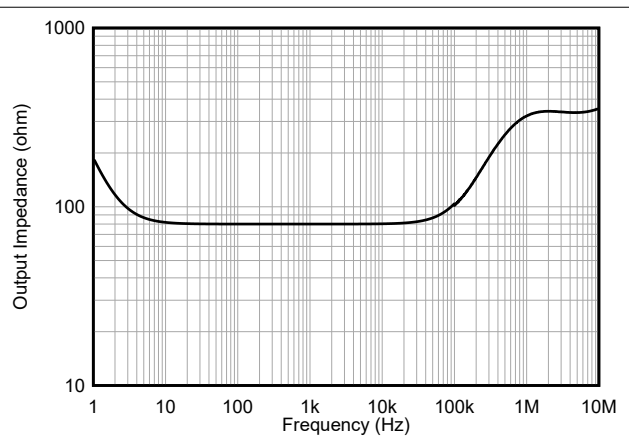

Figure 6-30. Open-Loop Output Impedance vs Frequency

6.9 Typical Characteristics (continued)

at $T_A = 25^\circ\text{C}$, $V_S = \pm 15\text{V}$, $V_{CM} = V_{OUT} = \text{midsupply}$, and $R_L = 10\text{ k}\Omega$ (unless otherwise noted)

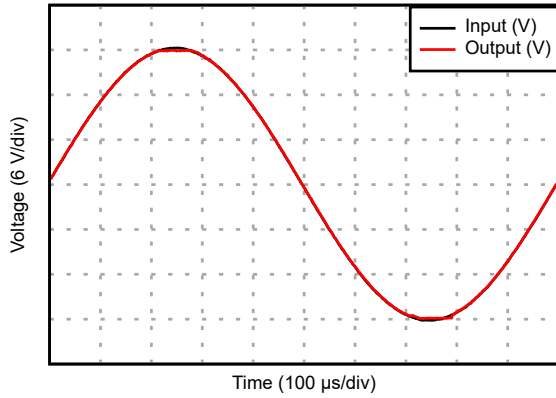

Figure 6-31. No Phase Reversal

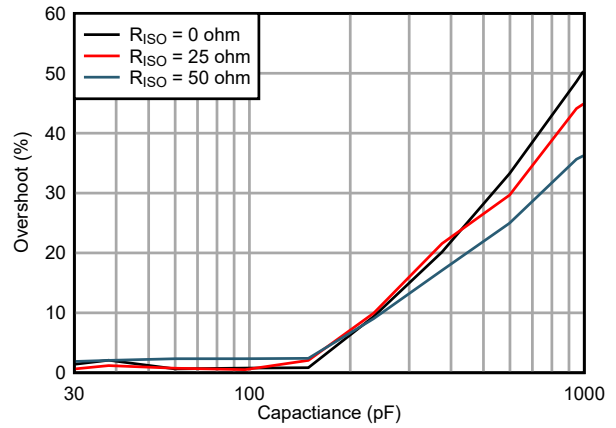

Figure 6-32. Small-Signal Overshoot vs Capacitive Load, Gain = +1

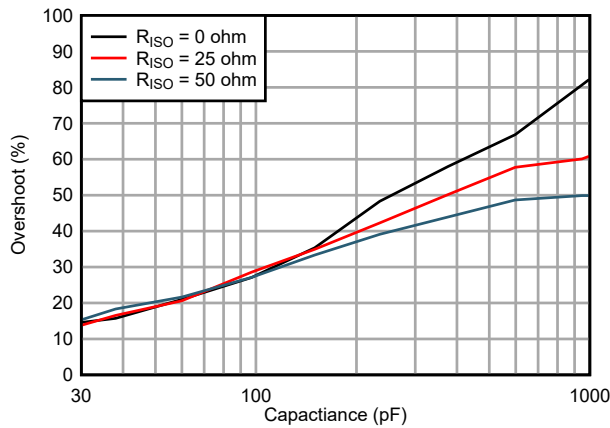

Figure 6-33. Small-Signal Overshoot vs Capacitive Load, Gain = -1



Figure 6-34. Phase Margin vs Capacitive Load

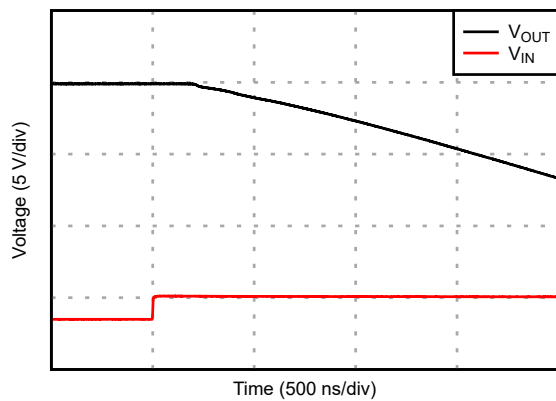

Figure 6-35. Positive Overload Recovery, Gain = -1

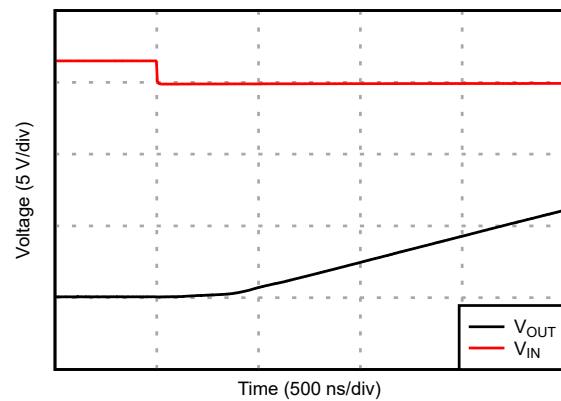
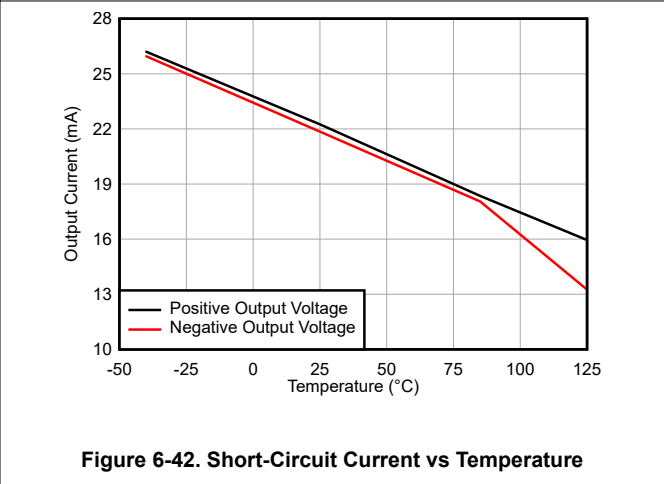
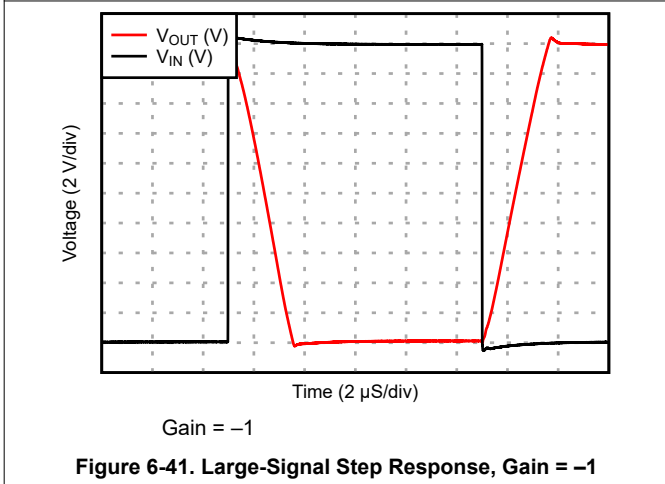
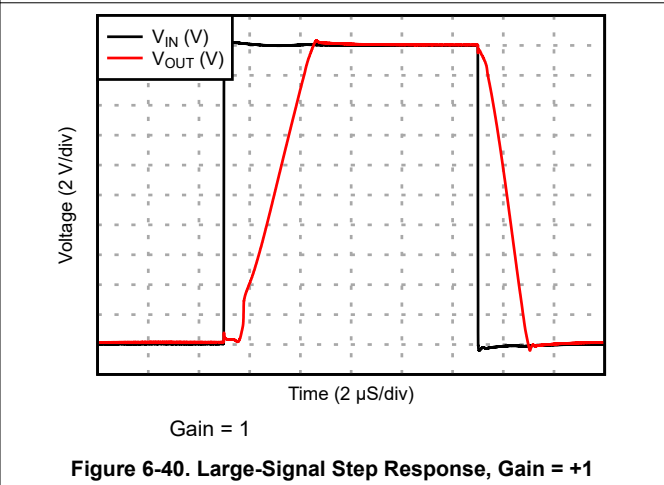
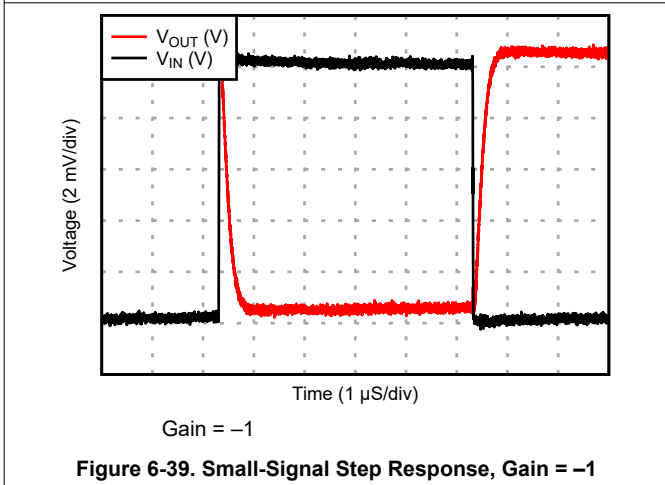
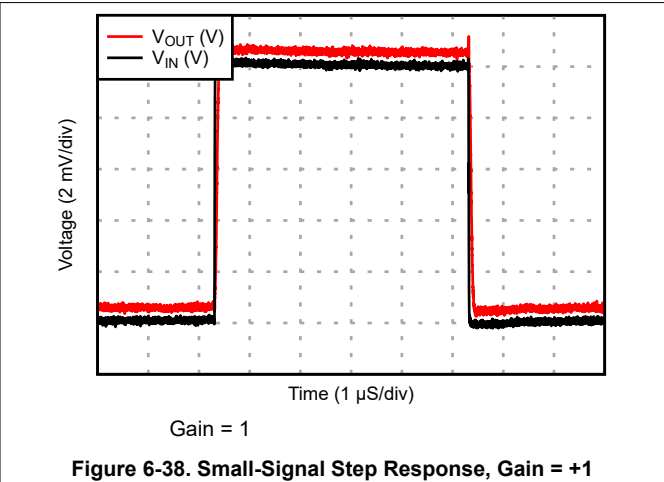
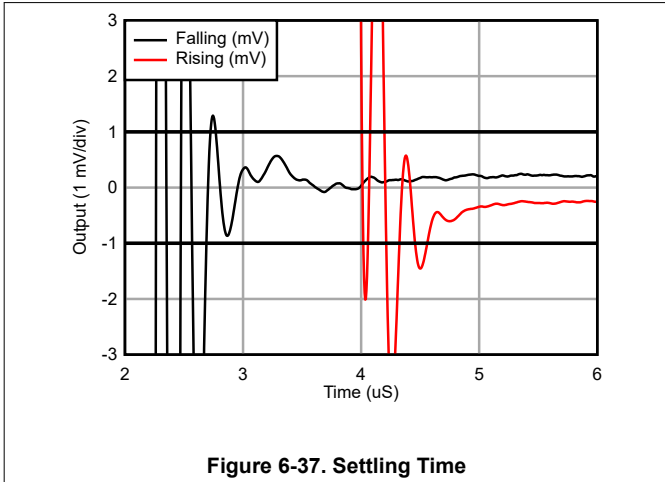

Figure 6-36. Negative Overload Recovery, Gain = -1

6.9 Typical Characteristics (continued)

at $T_A = 25^\circ\text{C}$, $V_S = \pm 15\text{V}$, $V_{CM} = V_{OUT} = \text{mid supply}$, and $R_L = 10\text{ k}\Omega$ (unless otherwise noted)



6.9 Typical Characteristics (continued)

at $T_A = 25^\circ\text{C}$, $V_S = \pm 15\text{V}$, $V_{CM} = V_{OUT} = \text{midsupply}$, and $R_L = 10\text{ k}\Omega$ (unless otherwise noted)

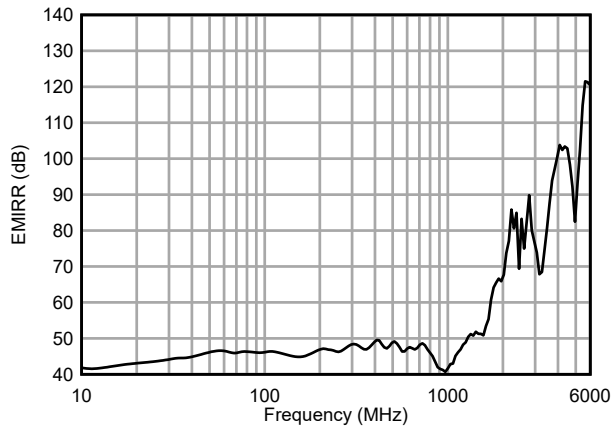

Figure 6-43. Electromagnetic Interference Rejection

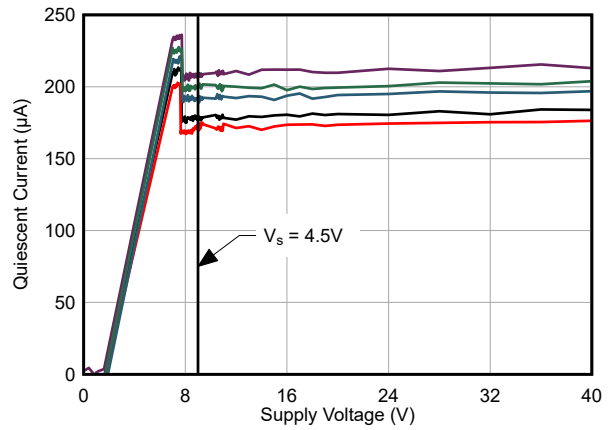

Figure 6-44. Quiescent Current vs Supply Voltage

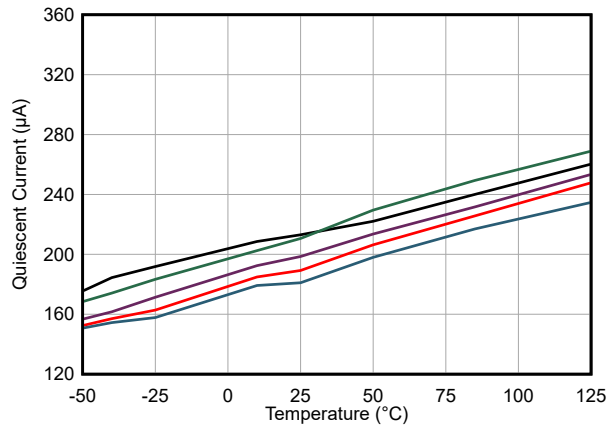

Figure 6-45. Quiescent Current vs Temperature

7 Parameter Measurement Information

7.1 Typical Specifications and Distributions

To design a more robust circuit, designers often have questions about a typical specification of an amplifier. As a result of natural variations in process technology and manufacturing procedures, every specification of an amplifier exhibits some amount of deviation from the ideal value, such as the input bias current of an amplifier. These deviations often follow *Gaussian* (bell curve), or *normal* distributions. Circuit designers can leverage this information to guard-band their system, even when there is no minimum or maximum specification in the [Electrical Characteristics](#).

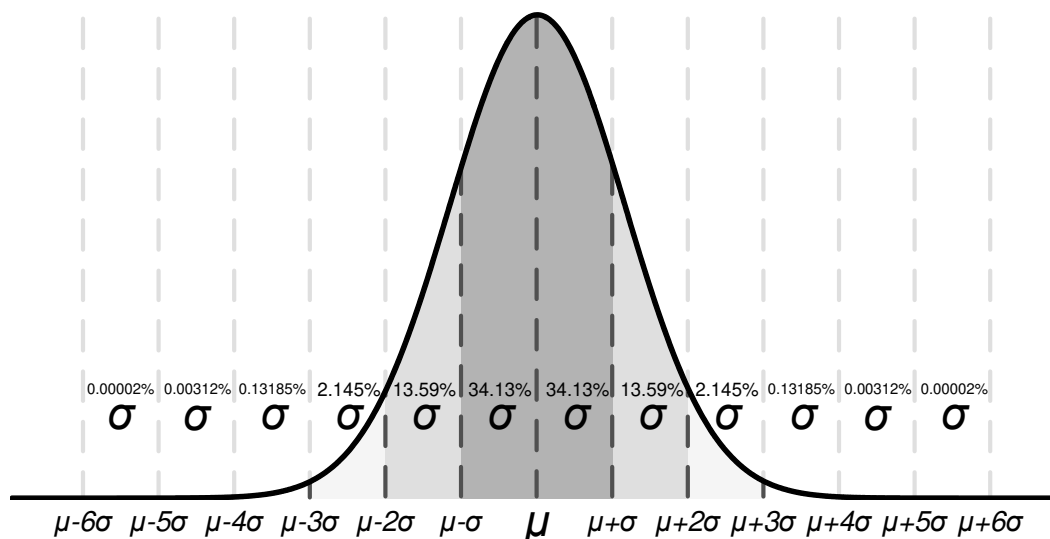

Figure 7-1. Ideal Gaussian Distribution

Figure 7-1 shows an example distribution, where μ , is the mean of the distribution, and where σ , or *sigma*, is the standard deviation of a system. For a specification that exhibits this kind of distribution, approximately two-thirds (68.26%) of all units can be expected to have a value within one standard deviation, or one sigma, of the mean (from $\mu - \sigma$ to $\mu + \sigma$).

Depending on the specification, values listed in the *typical* column of [Electrical Characteristics](#) are represented in different ways. As a general guideline, if a specification naturally has a nonzero mean (for example, gain bandwidth), then the typical value is equal to the mean (μ). However, if a specification naturally has a mean near zero (for example, input bias current), then the typical value is equal to the mean plus one standard deviation ($\mu + \sigma$) to most accurately represent the typical value.

Use this chart to calculate the approximate probability of a specification in a unit. For example, the OPAx205 typical input bias current is ± 0.1 nA; therefore, 68.2% of all devices are expected to have an input bias from ± 0.1 nA. At 4σ , 99.9937% of the distribution has an input bias less than ± 0.28 nA, which means that 0.0063% of the population is outside of these limits, and corresponds to approximately 1 in 15,873 units.

Units that are found to exceed any tested minimum or maximum specifications are removed from production material. For example, the OPAx205 have a maximum input bias of ± 0.5 nA at 25°C. Although this value corresponds to approximately 6σ (approximately 1 in 500 million units), TI removes any unit with a larger input bias from production material.

For specifications with no value in the minimum or maximum column, consider selecting a sigma value of sufficient guard band for your application, and design worst-case conditions using this value. Use this information to only estimate the performance of a device.

8 Detailed Description

8.1 Overview

The OPAx205 are the first 36-V bipolar, e-trim operational amplifiers that uses a package-level offset trim to minimize the offset voltage and offset voltage drift introduced during the manufacturing process. This trim is performed after the device has been assembled to remove any offset errors introduced throughout the manufacturing process, and trim communication is disabled afterward. These devices also feature super-beta inputs that decrease the input bias current and input current noise.

The following section shows the simplified diagram of the OPAx205.

8.2 Functional Block Diagram

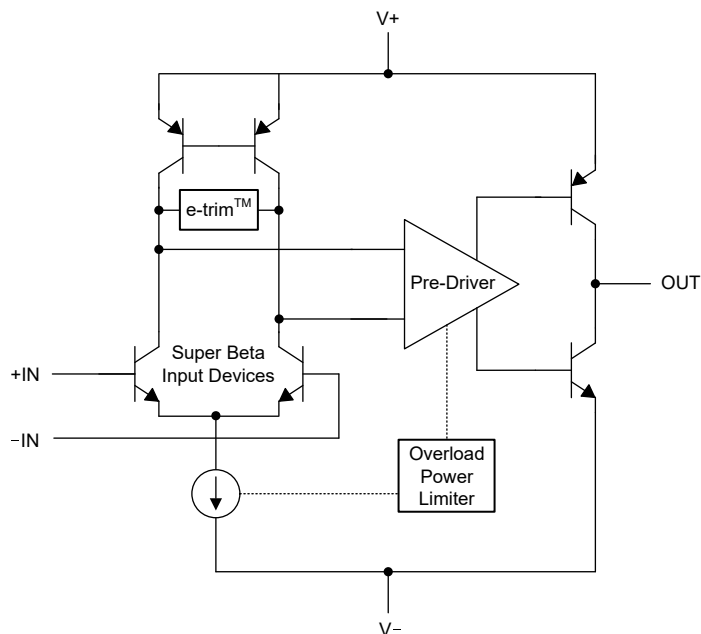

8.3 Feature Description

8.3.1 Input Offset Trimming

The OPAx205 are the industry's first e-trim operational amplifiers built on a bipolar process. The input offset voltage of an amplifier is determined by the inherent mismatch between the input transistors. The offset can be minimized using laser-trimming performed during the manufacturing process while the devices are still in the bare silicon form. However, when the silicon is packaged, the packaging process introduces additional offset due to mechanic stresses. TI's new trimming processes are used to trim the offset after the packaging process is complete to minimize both inherent and package-induced offsets. After trimming, communication is disabled to make sure the amplifiers operate properly in the final system.

A comparison between production offset values for the industry-popular, laser-trimmed OPA2277 and the OPAx205 proprietary trim can be seen in [Figure 8-1](#) and [Figure 8-2](#).

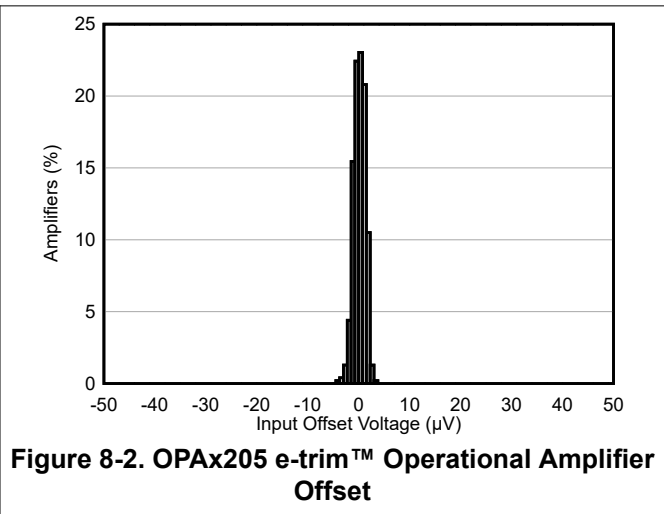
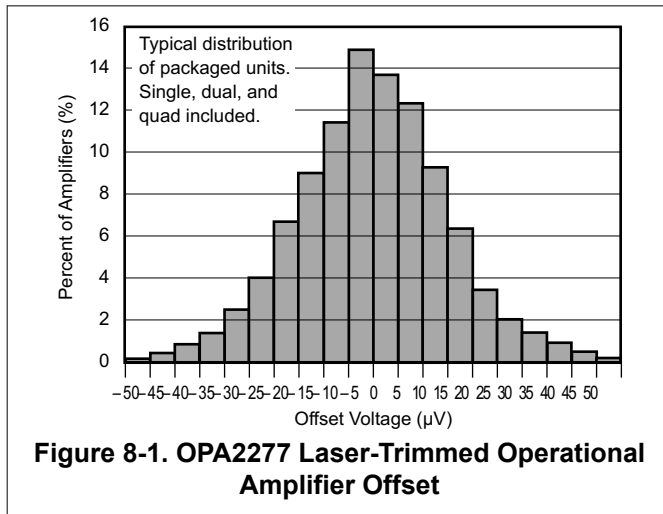

The OPAx205 are also trimmed at two temperatures to minimize the input offset voltage drift over temperature. The final performance of the offset drift can be seen in [Figure 8-3](#).

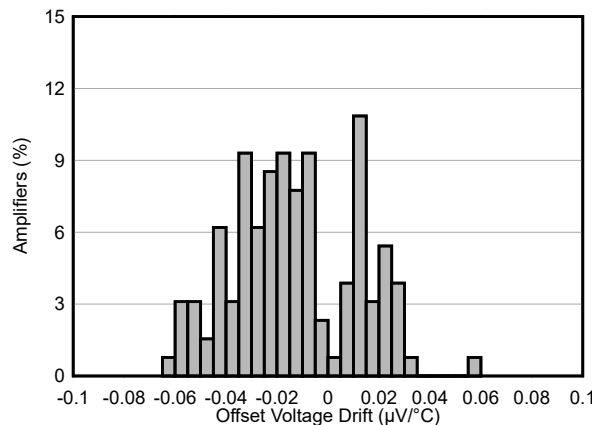
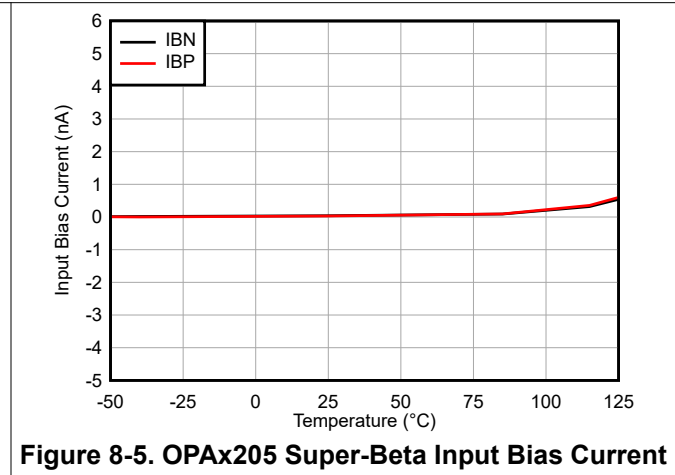
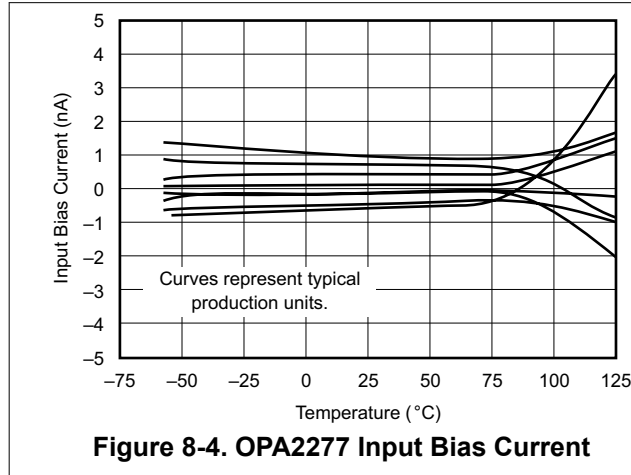

Figure 8-3. OPAx205 e-trim™ Operational Amplifier Drift

8.3.2 Lower Input Bias With Super-Beta Inputs

The OPAx205 have a super-beta input transistor architecture. In a transistor, the beta value is the ratio between the current flowing into the base and the current flowing from the collector to the emitter. A super-beta transistor is one where the beta value has been increased from several hundred to thousands. In a bipolar amplifier, the input bias current is the current flowing into the base of the input transistor pair, as well as a small leakage current that flows through the ESD diodes. A super-beta input reduces the input bias current of the amplifier. In addition, the super-beta inputs lower the input current noise that is directly related to the input bias current of the device. A comparison between the input bias current of the OPA2277 and the OPAx205 super-beta input bias currents can be seen in [Figure 8-4](#) and [Figure 8-5](#).



8.3.3 Overload Power Limiter

In many bipolar-based amplifiers, the output stage of the amplifier can draw significant (several milliamperes) of quiescent current if the output voltage becomes clipped (that is, the output voltage becomes limited by the negative or positive supply voltage). This condition can cause the system to enter a high-power consumption state, and potentially cause oscillations between the power supply and signal chain. The OPAx205 have an advanced output stage design that eliminates this problem. When the output voltage reaches either supply ($V+$ or $V-$), there is virtually no additional current consumption from the nominal quiescent current. This feature helps eliminate any potential system problems when the signal chain is disrupted by large external transient voltage.

8.3.4 EMI Rejection

The OPAx205 use integrated electromagnetic interference (EMI) filtering to reduce the effects of EMI from sources, such as wireless communications and densely populated boards with a mix of analog signal chain and digital components. EMI immunity can be improved through circuit design techniques that improve the system performance. Additional information can be found in the [EMI Rejection Ratio of Operation Amplifiers application report](#).

8.4 Device Functional Modes

The OPAx205 have a single functional mode and are operational with any supply between 4.5 V (± 2.25 V) and 36 V (± 18 V).

9 Application and Implementation

Note

Information in the following applications sections is not part of the TI component specification, and TI does not warrant its accuracy or completeness. TI's customers are responsible for determining suitability of components for their purposes, as well as validating and testing their design implementation to confirm system functionality.

9.1 Application Information

The OPAx205 are unity-gain stable operational amplifiers with very low offset voltage, offset voltage drift, voltage noise, current noise and power consumption. These features make this device family a great choice for a variety of space-constrained and power-constrained systems.

9.2 Typical Applications

9.2.1 High-Precision Signal-Chain Input Buffer

A common application for the OPAx205 is an input buffer for the signal chain of a data acquisition (DAQ) or field instrumentation system. This amplifier family is selected because of the low offset and drift that maintain system accuracy across a variety of operating conditions. The low power consumption of the OPAx205 enables the device to be used in battery-operated or high-density applications, where thermal dissipation is difficult. The low 1/f (flicker) noise and broadband noise allow for higher-accuracy signal chains, such as those using a 24-bit delta-sigma analog-to-digital converter (ADC). If a higher sampling rate is needed, the OPAx205 can be paired with a fully differential amplifier, such as the THP210, to drive the ADC inputs. Figure 9-1 shows the OPA2205 configured as an input buffer to a differential ADC driver.

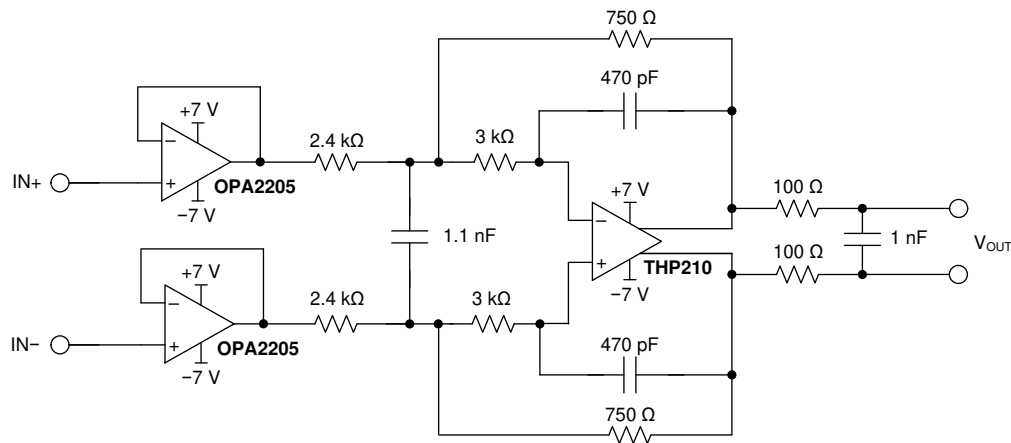

Figure 9-1. OPA2205 Configured as a DAQ Input Buffer

9.2.1.1 Design Requirements

The design requirements for this application are:

- Input range: ± 10 V
- Input frequency: 10 kHz
- Output voltage: ± 3.3 V
- Quiescent current: < 1.5 mA

9.2.1.2 Detailed Design Procedure

In this application, the input signal ranges from -10 V to $+10$ V with a frequency of up to 10 kHz. Because of possible portable-use cases for this data acquisition system (DAQ), low power consumption is required to minimize battery drain and thermal dissipation requirements.

To maintain high system accuracy the OPA2205 is selected as input buffers. This device is selected because of the high dc precision ($4 \mu\text{V}$ offset and $0.08 \mu\text{V}/^\circ\text{C}$ offset drift), low flicker noise ($0.2 \mu\text{Vpp}$), and low quiescent current ($220 \mu\text{A}$). The buffers are followed by a high-precision, fully differential amplifier such as the THP210, which is capable of accurately driving a 24-bit, fully differential ADC such as the [ADS127L01](#).

9.2.1.3 Application Curves

The gain plot for this system can be seen in [Figure 9-2](#). This plot shows proper attenuation of the ± 10 -V signal to the target ± 3.3 -V output, and adequate bandwidth to support the input frequency range.

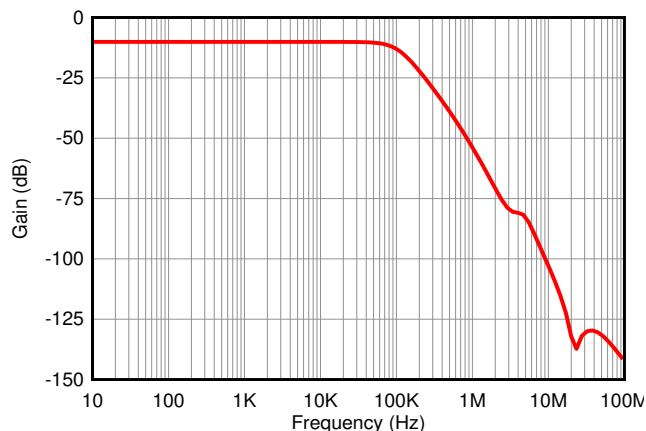

Figure 9-2. Gain Plot of DAQ Front End

9.2.2 Discrete, Two-Op-Amp Instrumentation Amplifier

Figure 9-3 shows the OPA2205 configured as a two-op-amp, discrete instrumentation amplifier. This configuration allows for a differential signal measurement, such as the signal from a load cell, with higher input impedance to the signal chain than most monolithic instrumentation amplifiers. The strong ac and dc performance of the OPA2205 enables high accuracy measurements.

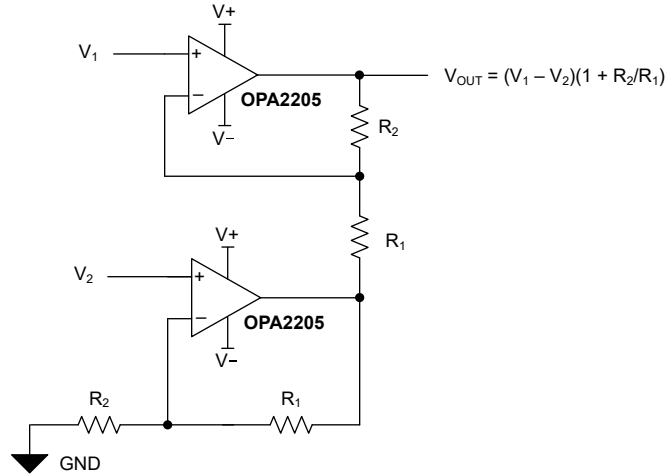

Figure 9-3. OPA2205 Configured as a Two-Op-Amp, Discrete Instrumentation Amplifier

9.2.3 Second-Order Low-Pass Filter

The OPAx205 has a very-low broadband voltage noise of only $7.2 \text{ nV}/\sqrt{\text{Hz}}$ and flicker noise of $0.2 \text{ } \mu\text{V}_{\text{PP}}$ given the low power consumption of only $220 \text{ } \mu\text{A}$, making this device an excellent choice for low-power filter applications. Figure 9-4 is an example of one channel of the OPAx205 configured as a second-order low-pass filter with a cutoff frequency of 50 kHz.

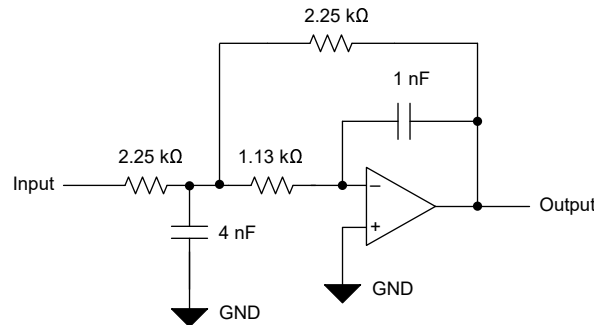

Figure 9-4. Second-Order Low-Pass Filter

9.3 Power Supply Recommendations

The OPAX205 operate with a power supply between 4.5 V to 36 V (± 2.25 V to ± 18 V). Parameters that can exhibit significant variance with regard to operating voltage are presented in [Section 6.9](#).

Place 0.1- μ F bypass capacitors close to the power-supply pins to reduce errors coupling in from noisy or high-impedance power supplies. For more detailed information on bypass capacitor placement, see [Section 9.4.1](#).

9.4 Layout

9.4.1 Layout Guidelines

For best operational performance of the device, use good PCB layout practices, including:

- Connect low-ESR, 0.1- μ F ceramic bypass capacitors between each supply pin and ground, placed as close to the device as possible. A single bypass capacitor from V+ to ground is applicable for single-supply applications. Noise can propagate into analog circuitry through the power pins of the circuit as a whole, as well as through the individual op amp. Bypass capacitors are used to reduce the coupled noise by providing low-impedance power sources local to the analog circuitry.
- Make sure to physically separate digital and analog grounds paying attention to the flow of the ground current. Separate grounding for analog and digital portions of circuitry is one of the simplest and most effective methods of noise suppression. One or more layers on multilayer PCBs are usually devoted to ground planes. A ground plane helps distribute heat and reduces EMI noise pickup.
- To reduce parasitic coupling, run the input traces as far away from the supply or output traces as possible. If these traces cannot be kept separate, crossing the sensitive trace perpendicular is much better as opposed to in parallel with the noisy trace.
- Place the external components as close to the device as possible. As shown in [Figure 9-5](#), keep RF and RG close to the inverting input to minimize parasitic capacitance.
- Keep the length of input traces as short as possible. Always remember that the input traces are the most sensitive part of the circuit.
- Consider a driven, low-impedance guard ring around the critical traces. A guard ring can significantly reduce leakage currents from nearby traces that are at different potentials.
- Clean the PCB following board assembly for best performance.
- Any precision integrated circuit can experience performance shifts due to moisture ingress into the plastic package. After any aqueous PCB cleaning process, bake the PCB assembly to remove moisture introduced into the device packaging during the cleaning process. A low-temperature, post-cleaning bake at 85°C for 30 minutes is sufficient for most circumstances.

9.4.2 Layout Example

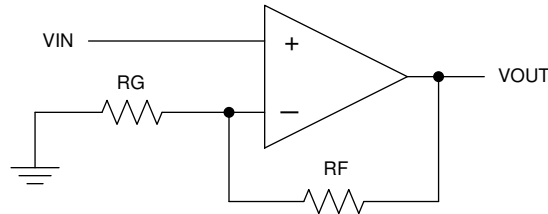

Figure 9-5. Schematic Representation

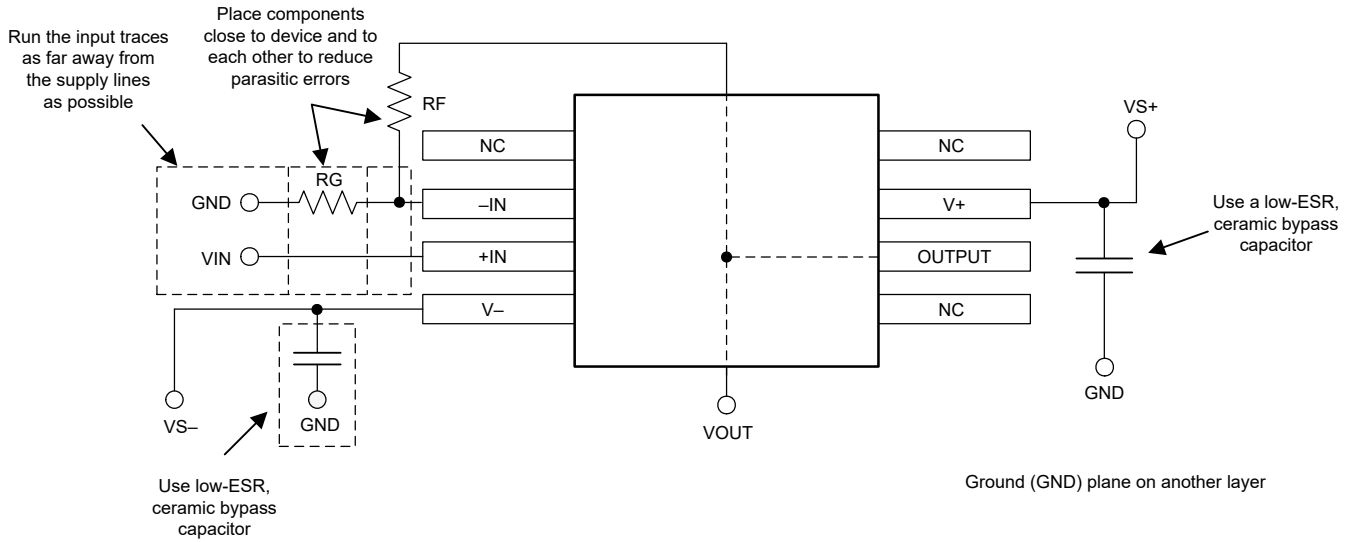

Figure 9-6. Operational Amplifier Board Layout for Noninverting Configuration

10 Device and Documentation Support

10.1 Device Support

10.1.1 Development Support

The following evaluation modules are available:

- [DIP-ADAPTER-EVM](#)
- [DIYAMP-EVM](#)

10.1.1.1 PSpice® for TI

PSpice® for TI is a design and simulation environment that helps evaluate performance of analog circuits. Create subsystem designs and prototype solutions before committing to layout and fabrication, reducing development cost and time to market.

10.2 Documentation Support

10.2.1 Related Documentation

For related documentation see the following:

- Texas Instruments, [DIP-ADAPTER-EVM user's guide](#)
- Texas Instruments, [DIYAMP-SOIC-EVM user's guide](#)

10.3 Receiving Notification of Documentation Updates

To receive notification of documentation updates, navigate to the device product folder on ti.com. Click on *Subscribe to updates* to register and receive a weekly digest of any product information that has changed. For change details, review the revision history included in any revised document.

10.4 Support Resources

[TI E2E™ support forums](#) are an engineer's go-to source for fast, verified answers and design help — straight from the experts. Search existing answers or ask your own question to get the quick design help you need.

Linked content is provided "AS IS" by the respective contributors. They do not constitute TI specifications and do not necessarily reflect TI's views; see TI's [Terms of Use](#).

10.5 Trademarks

e-trim™ and TI E2E™ are trademarks of Texas Instruments.
PSpice® is a registered trademark of Cadence Design Systems, Inc.
All trademarks are the property of their respective owners.

10.6 Electrostatic Discharge Caution



This integrated circuit can be damaged by ESD. Texas Instruments recommends that all integrated circuits be handled with appropriate precautions. Failure to observe proper handling and installation procedures can cause damage.

ESD damage can range from subtle performance degradation to complete device failure. Precision integrated circuits may be more susceptible to damage because very small parametric changes could cause the device not to meet its published specifications.

10.7 Glossary

[TI Glossary](#) This glossary lists and explains terms, acronyms, and definitions.

11 Mechanical, Packaging, and Orderable Information

The following pages include mechanical, packaging, and orderable information. This information is the most current data available for the designated devices. This data is subject to change without notice and revision of this document. For browser-based versions of this data sheet, refer to the left-hand navigation.

PACKAGING INFORMATION

Orderable Device	Status (1)	Package Type	Package Drawing	Pins	Package Qty	Eco Plan (2)	Lead finish/ Ball material (6)	MSL Peak Temp (3)	Op Temp (°C)	Device Marking (4/5)	Samples
OPA205ADR	ACTIVE	SOIC	D	8	3000	RoHS & Green	NIPDAU	Level-2-260C-1 YEAR	-40 to 125	OP205A	Samples
OPA205ADT	ACTIVE	SOIC	D	8	250	RoHS & Green	NIPDAU	Level-2-260C-1 YEAR	-40 to 125	OP205A	Samples
OPA2205ADGKR	ACTIVE	VSSOP	DGK	8	2500	RoHS & Green	NIPDAU	Level-2-260C-1 YEAR	-40 to 125	22A5	Samples
OPA2205ADGKT	ACTIVE	VSSOP	DGK	8	250	RoHS & Green	NIPDAU	Level-2-260C-1 YEAR	-40 to 125	22A5	Samples
OPA2205ADR	ACTIVE	SOIC	D	8	3000	RoHS & Green	NIPDAU	Level-2-260C-1 YEAR	-40 to 125	2205A	Samples
OPA2205ADT	ACTIVE	SOIC	D	8	250	RoHS & Green	NIPDAU	Level-2-260C-1 YEAR	-40 to 125	2205A	Samples
OPA4205ADR	ACTIVE	SOIC	D	14	3000	RoHS & Green	NIPDAU	Level-2-260C-1 YEAR	-40 to 125	OPA4205A	Samples
OPA4205ADT	ACTIVE	SOIC	D	14	250	RoHS & Green	NIPDAU	Level-2-260C-1 YEAR	-40 to 125	OPA4205A	Samples
OPA4205APWR	ACTIVE	TSSOP	PW	14	3000	RoHS & Green	NIPDAU	Level-2-260C-1 YEAR	-40 to 125	OP4205A	Samples
OPA4205APWT	ACTIVE	TSSOP	PW	14	250	RoHS & Green	NIPDAU	Level-2-260C-1 YEAR	-40 to 125	OP4205A	Samples

(1) The marketing status values are defined as follows:

ACTIVE: Product device recommended for new designs.

LIFEBUY: TI has announced that the device will be discontinued, and a lifetime-buy period is in effect.

NRND: Not recommended for new designs. Device is in production to support existing customers, but TI does not recommend using this part in a new design.

PREVIEW: Device has been announced but is not in production. Samples may or may not be available.

OBSELETE: TI has discontinued the production of the device.

(2) **RoHS:** TI defines "RoHS" to mean semiconductor products that are compliant with the current EU RoHS requirements for all 10 RoHS substances, including the requirement that RoHS substance do not exceed 0.1% by weight in homogeneous materials. Where designed to be soldered at high temperatures, "RoHS" products are suitable for use in specified lead-free processes. TI may reference these types of products as "Pb-Free".

RoHS Exempt: TI defines "RoHS Exempt" to mean products that contain lead but are compliant with EU RoHS pursuant to a specific EU RoHS exemption.

Green: TI defines "Green" to mean the content of Chlorine (Cl) and Bromine (Br) based flame retardants meet JS709B low halogen requirements of <=1000ppm threshold. Antimony trioxide based flame retardants must also meet the <=1000ppm threshold requirement.

(3) MSL, Peak Temp. - The Moisture Sensitivity Level rating according to the JEDEC industry standard classifications, and peak solder temperature.

(4) There may be additional marking, which relates to the logo, the lot trace code information, or the environmental category on the device.

⁽⁵⁾ Multiple Device Markings will be inside parentheses. Only one Device Marking contained in parentheses and separated by a "~" will appear on a device. If a line is indented then it is a continuation of the previous line and the two combined represent the entire Device Marking for that device.

⁽⁶⁾ Lead finish/Ball material - Orderable Devices may have multiple material finish options. Finish options are separated by a vertical ruled line. Lead finish/Ball material values may wrap to two lines if the finish value exceeds the maximum column width.

Important Information and Disclaimer:The information provided on this page represents TI's knowledge and belief as of the date that it is provided. TI bases its knowledge and belief on information provided by third parties, and makes no representation or warranty as to the accuracy of such information. Efforts are underway to better integrate information from third parties. TI has taken and continues to take reasonable steps to provide representative and accurate information but may not have conducted destructive testing or chemical analysis on incoming materials and chemicals. TI and TI suppliers consider certain information to be proprietary, and thus CAS numbers and other limited information may not be available for release.

In no event shall TI's liability arising out of such information exceed the total purchase price of the TI part(s) at issue in this document sold by TI to Customer on an annual basis.

TAPE AND REEL INFORMATION

QUADRANT ASSIGNMENTS FOR PIN 1 ORIENTATION IN TAPE

*All dimensions are nominal

Device	Package Type	Package Drawing	Pins	SPQ	Reel Diameter (mm)	Reel Width W1 (mm)	A0 (mm)	B0 (mm)	K0 (mm)	P1 (mm)	W (mm)	Pin1 Quadrant
OPA205ADR	SOIC	D	8	3000	330.0	12.4	6.4	5.2	2.1	8.0	12.0	Q1
OPA205ADT	SOIC	D	8	250	180.0	12.4	6.4	5.2	2.1	8.0	12.0	Q1
OPA2205ADGKR	VSSOP	DGK	8	2500	330.0	12.4	5.3	3.4	1.4	8.0	12.0	Q1
OPA2205ADGKT	VSSOP	DGK	8	250	180.0	12.4	5.3	3.4	1.4	8.0	12.0	Q1
OPA2205ADR	SOIC	D	8	3000	330.0	12.4	6.4	5.2	2.1	8.0	12.0	Q1
OPA2205ADT	SOIC	D	8	250	180.0	12.4	6.4	5.2	2.1	8.0	12.0	Q1
OPA4205ADR	SOIC	D	14	3000	330.0	16.4	6.5	9.0	2.1	8.0	16.0	Q1
OPA4205ADT	SOIC	D	14	250	180.0	16.4	6.5	9.0	2.1	8.0	16.0	Q1
OPA4205APWR	TSSOP	PW	14	3000	330.0	12.4	6.9	5.6	1.6	8.0	12.0	Q1
OPA4205APWT	TSSOP	PW	14	250	180.0	12.4	6.9	5.6	1.6	8.0	12.0	Q1

TAPE AND REEL BOX DIMENSIONS

*All dimensions are nominal

Device	Package Type	Package Drawing	Pins	SPQ	Length (mm)	Width (mm)	Height (mm)
OPA205ADR	SOIC	D	8	3000	356.0	356.0	35.0
OPA205ADT	SOIC	D	8	250	210.0	185.0	35.0
OPA2205ADGKR	VSSOP	DGK	8	2500	356.0	356.0	35.0
OPA2205ADGKT	VSSOP	DGK	8	250	210.0	185.0	35.0
OPA2205ADR	SOIC	D	8	3000	356.0	356.0	35.0
OPA2205ADT	SOIC	D	8	250	210.0	185.0	35.0
OPA4205ADR	SOIC	D	14	3000	356.0	356.0	35.0
OPA4205ADT	SOIC	D	14	250	210.0	185.0	35.0
OPA4205APWR	TSSOP	PW	14	3000	356.0	356.0	35.0
OPA4205APWT	TSSOP	PW	14	250	210.0	185.0	35.0

DGK0008A



PACKAGE OUTLINE

VSSOP - 1.1 mm max height

SMALL OUTLINE PACKAGE



PowerPAD is a trademark of Texas Instruments.

NOTES:

1. All linear dimensions are in millimeters. Any dimensions in parenthesis are for reference only. Dimensioning and tolerancing per ASME Y14.5M.
2. This drawing is subject to change without notice.
3. This dimension does not include mold flash, protrusions, or gate burrs. Mold flash, protrusions, or gate burrs shall not exceed 0.15 mm per side.
4. This dimension does not include interlead flash. Interlead flash shall not exceed 0.25 mm per side.
5. Reference JEDEC registration MO-187.

EXAMPLE BOARD LAYOUT

DGK0008A

™ VSSOP - 1.1 mm max height

SMALL OUTLINE PACKAGE



LAND PATTERN EXAMPLE
EXPOSED METAL SHOWN
SCALE: 15X



SOLDER MASK DETAILS

4214862/A 04/2023

NOTES: (continued)

6. Publication IPC-7351 may have alternate designs.
7. Solder mask tolerances between and around signal pads can vary based on board fabrication site.
8. Vias are optional depending on application, refer to device data sheet. If any vias are implemented, refer to their locations shown on this view. It is recommended that vias under paste be filled, plugged or tented.
9. Size of metal pad may vary due to creepage requirement.

EXAMPLE STENCIL DESIGN

DGK0008A

™ VSSOP - 1.1 mm max height

SMALL OUTLINE PACKAGE



SOLDER PASTE EXAMPLE
SCALE: 15X

4214862/A 04/2023

NOTES: (continued)

11. Laser cutting apertures with trapezoidal walls and rounded corners may offer better paste release. IPC-7525 may have alternate design recommendations.
12. Board assembly site may have different recommendations for stencil design.

D (R-PDSO-G14)

PLASTIC SMALL OUTLINE



- NOTES:
- A. All linear dimensions are in inches (millimeters).
 - B. This drawing is subject to change without notice.
 - \triangle Body length does not include mold flash, protrusions, or gate burrs. Mold flash, protrusions, or gate burrs shall not exceed 0.006 (0,15) each side.
 - \diamond Body width does not include interlead flash. Interlead flash shall not exceed 0.017 (0,43) each side.
 - E. Reference JEDEC MS-012 variation AB.

PW (R-PDSO-G14)

PLASTIC SMALL OUTLINE



- NOTES:
- A. All linear dimensions are in millimeters. Dimensioning and tolerancing per ASME Y14.5M-1994.
 - B. This drawing is subject to change without notice.
 - C. Body length does not include mold flash, protrusions, or gate burrs. Mold flash, protrusions, or gate burrs shall not exceed 0,15 each side.
 - D. Body width does not include interlead flash. Interlead flash shall not exceed 0,25 each side.
 - E. Falls within JEDEC MO-153

PW (R-PDSO-G14)

PLASTIC SMALL OUTLINE



- NOTES:
- All linear dimensions are in millimeters.
 - This drawing is subject to change without notice.
 - Publication IPC-7351 is recommended for alternate designs.
 - Laser cutting apertures with trapezoidal walls and also rounding corners will offer better paste release. Customers should contact their board assembly site for stencil design recommendations. Refer to IPC-7525 for other stencil recommendations.
 - Customers should contact their board fabrication site for solder mask tolerances between and around signal pads.



D0008A

PACKAGE OUTLINE

SOIC - 1.75 mm max height

SMALL OUTLINE INTEGRATED CIRCUIT



4214825/C 02/2019

NOTES:

- Linear dimensions are in inches [millimeters]. Dimensions in parenthesis are for reference only. Controlling dimensions are in inches. Dimensioning and tolerancing per ASME Y14.5M.
- This drawing is subject to change without notice.
- This dimension does not include mold flash, protrusions, or gate burrs. Mold flash, protrusions, or gate burrs shall not exceed $.006$ [0.15] per side.
- This dimension does not include interlead flash.
- Reference JEDEC registration MS-012, variation AA.

EXAMPLE BOARD LAYOUT

D0008A

SOIC - 1.75 mm max height

SMALL OUTLINE INTEGRATED CIRCUIT



LAND PATTERN EXAMPLE
 EXPOSED METAL SHOWN
 SCALE:8X



SOLDER MASK DETAILS

4214825/C 02/2019

NOTES: (continued)

- 6. Publication IPC-7351 may have alternate designs.
- 7. Solder mask tolerances between and around signal pads can vary based on board fabrication site.

EXAMPLE STENCIL DESIGN

D0008A

SOIC - 1.75 mm max height

SMALL OUTLINE INTEGRATED CIRCUIT



SOLDER PASTE EXAMPLE
BASED ON .005 INCH [0.125 MM] THICK STENCIL
SCALE:8X

4214825/C 02/2019

NOTES: (continued)

8. Laser cutting apertures with trapezoidal walls and rounded corners may offer better paste release. IPC-7525 may have alternate design recommendations.
9. Board assembly site may have different recommendations for stencil design.

IMPORTANT NOTICE AND DISCLAIMER

TI PROVIDES TECHNICAL AND RELIABILITY DATA (INCLUDING DATA SHEETS), DESIGN RESOURCES (INCLUDING REFERENCE DESIGNS), APPLICATION OR OTHER DESIGN ADVICE, WEB TOOLS, SAFETY INFORMATION, AND OTHER RESOURCES "AS IS" AND WITH ALL FAULTS, AND DISCLAIMS ALL WARRANTIES, EXPRESS AND IMPLIED, INCLUDING WITHOUT LIMITATION ANY IMPLIED WARRANTIES OF MERCHANTABILITY, FITNESS FOR A PARTICULAR PURPOSE OR NON-INFRINGEMENT OF THIRD PARTY INTELLECTUAL PROPERTY RIGHTS.

These resources are intended for skilled developers designing with TI products. You are solely responsible for (1) selecting the appropriate TI products for your application, (2) designing, validating and testing your application, and (3) ensuring your application meets applicable standards, and any other safety, security, regulatory or other requirements.

These resources are subject to change without notice. TI grants you permission to use these resources only for development of an application that uses the TI products described in the resource. Other reproduction and display of these resources is prohibited. No license is granted to any other TI intellectual property right or to any third party intellectual property right. TI disclaims responsibility for, and you will fully indemnify TI and its representatives against, any claims, damages, costs, losses, and liabilities arising out of your use of these resources.

TI's products are provided subject to [TI's Terms of Sale](#) or other applicable terms available either on [ti.com](https://www.ti.com) or provided in conjunction with such TI products. TI's provision of these resources does not expand or otherwise alter TI's applicable warranties or warranty disclaimers for TI products.

TI objects to and rejects any additional or different terms you may have proposed.

Mailing Address: Texas Instruments, Post Office Box 655303, Dallas, Texas 75265
Copyright © 2024, Texas Instruments Incorporated