

SN65LVPE502x Dual-Channel USB 3.0 Redriver and Equalizer

1 Features

- Single-Lane USB 3.0 Redriver and Equalizer
- Selectable Equalization, De-Emphasis and Output Swing Control
- Integrated Termination
- Hot-Plug Capable
- Low Active Power (U0 state):
 - 315 mW (Typical), $V_{CC} = 3.3\text{ V}$
- USB 3.0 Low Power Support:
 - 7 mW (Typical) When No Connection Detected
 - 70 mW (Typical) When Link in U2/U3 Mode
- Excellent Jitter and Loss Compensation Capability:
 - >40 in of Total 4 mil Stripline on FR4
- Small Footprint, 3 mm × 3 mm and 4 mm × 4 mm, 24-Pin VQFN Packages
- High Protection Against ESD Transient:
 - HBM: 5,000 V
 - CDM: 1,500 V
 - MM: 200 V

2 Applications

- Notebooks
- Desktops
- Docking Stations
- Backplanes
- Active Cables

3 Description

The SN65LVPE502x devices are dual-channel, single-lane USB 3.0 redriver and signal conditioners supporting data rates of 5 Gbps. The devices comply with USB 3.0 specification revision 1.0 supporting electrical idle condition and low frequency periodic signals (LFPS) for USB 3.0 power management modes.

Device Information⁽¹⁾

PART NUMBER	PACKAGE	BODY SIZE (NOM)
SN65LVPE502A	RLL (24)	3.00 mm × 3.00 mm
SN65LVPE502A, SN65LVPE502B	RGE (24)	4.00 mm × 4.00 mm

(1) For all available packages, see the orderable addendum at the end of the data sheet.

Typical Application

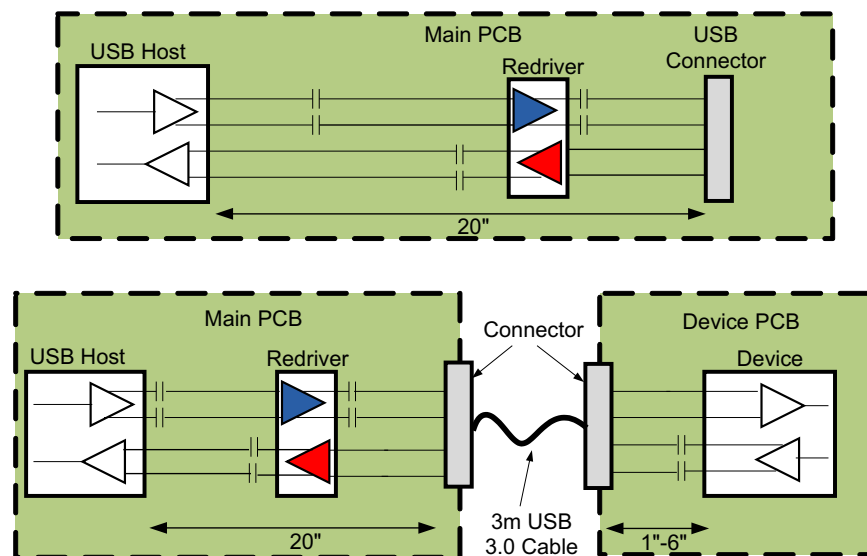

Copyright © 2016, Texas Instruments Incorporated



Table of Contents

1	Features	1	8.3	Feature Description.....	19
2	Applications	1	8.4	Device Functional Modes.....	21
3	Description	1	9	Application and Implementation	22
4	Revision History	2	9.1	Application Information.....	22
5	Pin Configuration and Functions	3	9.2	Typical Application	22
6	Specifications	6	10	Power Supply Recommendations	24
6.1	Absolute Maximum Ratings	6	11	Layout	24
6.2	ESD Ratings.....	6	11.1	Layout Guidelines	24
6.3	Recommended Operating Conditions.....	6	11.2	Layout Example	25
6.4	Thermal Information	7	12	Device and Documentation Support	26
6.5	Electrical Characteristics.....	7	12.1	Documentation Support	26
6.6	Dissipation Ratings	8	12.2	Receiving Notification of Documentation Updates	26
6.7	Typical Characteristics	11	12.3	Community Resources.....	26
7	Parameter Measurement Information	16	12.4	Trademarks	26
7.1	Typical Eye Diagram and Performance Curves.....	16	12.5	Electrostatic Discharge Caution.....	26
8	Detailed Description	19	12.6	Glossary	26
8.1	Overview	19	13	Mechanical, Packaging, and Orderable Information	26
8.2	Functional Block Diagram	19			

4 Revision History

NOTE: Page numbers for previous revisions may differ from page numbers in the current version.

Changes from Revision B (April 2012) to Revision C	Page
• Added <i>ESD Ratings</i> table, <i>Feature Description</i> section, <i>Device Functional Modes</i> , <i>Application and Implementation</i> section, <i>Power Supply Recommendations</i> section, <i>Layout</i> section, <i>Device and Documentation Support</i> section, and <i>Mechanical, Packaging, and Orderable Information</i> section	1
• Added Storage temperature (–65 to 150°C) to the <i>Absolute Maximum Ratings</i> table.....	6

Changes from Revision A (March 2012) to Revision B	Page
• Added SN65LVPE502B device	1
• Changed Feature From: Small Foot Print – 24 Pin (4mm x 4mm) QFN Package To: Small Foot Print – 3x3mm and 4x4mm 24-pin QFN Packages	1
• Deleted bottom view pinout image	3
• Added RLL package pinout image	4
• Added RLL to <i>Pin Functions</i> table.....	5
• Added Host- and Device-Side Pins section.....	19

Changes from Original (March 2012) to Revision A	Page
• Deleted <i>Ordering Information</i> table; see POA at the end of the data sheet.....	1

5 Pin Configuration and Functions

SN65LVPE502A RGE Package
24-Pin VQFN With Exposed Thermal Pad
Top View

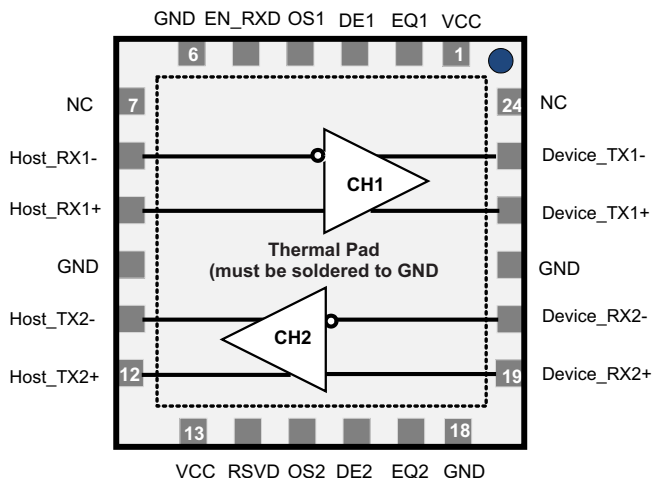

SN65LVPE502B RGE Package
24-Pin VQFN With Exposed Thermal Pad
Top View

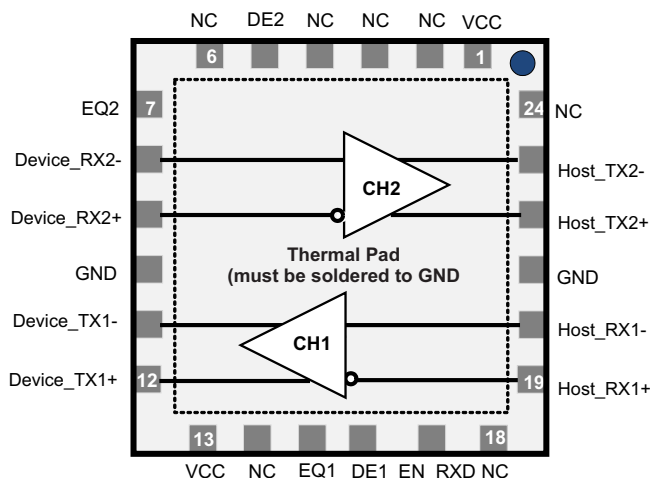

Pin Functions – RGE Packages

NAME	PIN		TYPE ⁽¹⁾	DESCRIPTION
	SN65LVPE502A	SN65LVPE502B		
HIGH SPEED DIFFERENTIAL I/O PINS				
Host_RX1-	8	20	I	CML, inverting differential input for CH1. This pin is tied to an internal voltage bias by dual termination resistor circuit. Must connect to the USB 3.0 host side.
Host_RX1+	9	19	I	CML, noninverting differential input for CH1. This pin is tied to an internal voltage bias by dual termination resistor circuit. Must connect to the USB 3.0 host side.
Device_RX2-	20	8	I	CML, inverting differential input for CH2. This pin is tied to an internal voltage bias by dual termination resistor circuit. Must connect to the USB 3.0 Device side.
Device_RX2+	19	9	I	CML, noninverting differential input for CH2. This pin is tied to an internal voltage bias by dual termination resistor circuit. Must connect to the USB 3.0 Device side.
Device_TX1-	23	11	O	CML, inverting differential output for CH1. This pin is tied to an internal voltage bias by termination resistors. Must connect to the USB 3.0 Device side.
Device_TX1+	22	12	O	CML, noninverting differential output for CH1. This pin is tied to an internal voltage bias by termination resistors. Must connect to the USB 3.0 Device side.
Host_TX2-	11	23	O	CML, inverting differential output for CH2. This pin is tied to an internal voltage bias by termination resistors. Must connect to the USB 3.0 Host side.
Host_TX2+	12	22	O	CML, noninverting differential output for CH2. This pin is tied to an internal voltage bias by termination resistors. Must connect to the USB 3.0 Host side.
DEVICE CONTROL PINS				
EN_RXD	5	17	I	LVC MOS, sets device operation modes per Table 4 ; internally pulled to V _{CC} .
RSVD	14	—	I	LVC MOS; RSVD. Can be left as <i>No-Connect</i> .
NC	7, 24	2, 3, 4, 6, 14, 18, 24	—	Pads are not internally connected.

(1) I = Input, O = Output, P = Power

SN65LVPE502A, SN65LVPE502B

SLLSEB3C –MARCH 2012–REVISED NOVEMBER 2016

www.ti.com

Pin Functions – RGE Packages (continued)

PIN			TYPE ⁽¹⁾	DESCRIPTION
NAME	SN65LVPE502A	SN65LVPE502B		
EQ CONTROL PINS⁽²⁾				
DE1, DE2	3, 16	16, 5	I	LVC MOS, selects de-emphasis settings for CH1 and CH2 per Table 4; internally tied to $V_{CC}/2$.
EQ1, EQ2	2, 17	15, 7	I	LVC MOS, selects equalization settings for CH1 and CH2 per Table 4, internally tied to $V_{CC}/2$.
OS1, OS2	4, 15	—	I	LVC MOS, selects output amplitude for CH1 and CH2 per Table 4, internally tied to $V_{CC}/2$.
POWER PINS⁽³⁾				
GND	6, 10, 18, 21, Thermal Pad	10, 21, Thermal Pad	P	Supply ground
VCC	1, 13	1, 13	P	Positive supply; must be 3.3 V \pm 10%

- (2) Internally biased to $V_{CC}/2$ with $>200\text{ k}\Omega$ pullup or pulldown. When pins are left as NC, board leakage at this pin pad must be $<1\ \mu\text{A}$ otherwise drive to $V_{CC}/2$ to assert mid-level state.
- (3) For SN65LVPE502B, pins 10 and 21 must be connected to GND, while 6 and 18 may be NC. For SN65LVPE502A, TI recommends at least two of the four pins (6, 10, 18, 21) be connected to ground.

SN65LVPE502A RLL Package
24-Pin VQFN With Exposed Thermal Pad
Top View

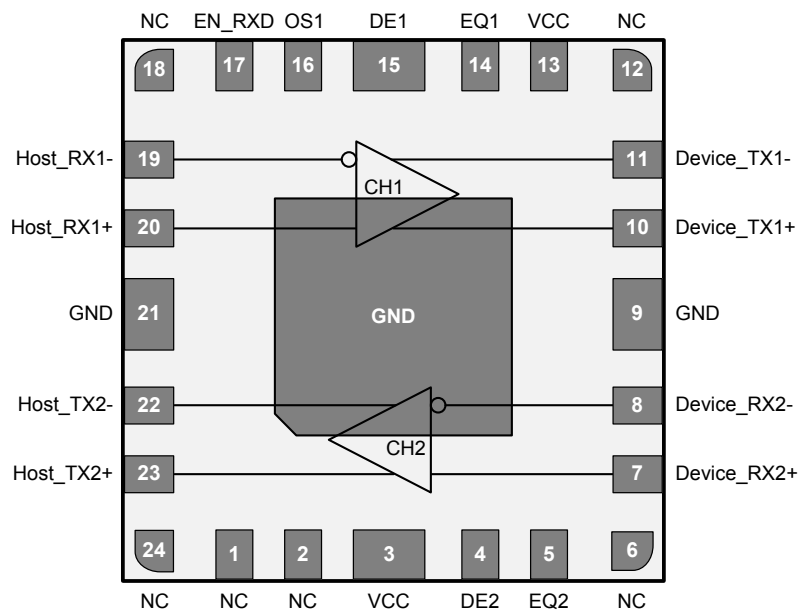

Pin Functions – RLL Package

PIN		TYPE ⁽¹⁾	DESCRIPTION
NAME	NO.		
HIGH SPEED DIFFERENTIAL I/O PINS			
Host_RX1–	19	I	CML, inverting differential input for CH1. This pin is tied to an internal voltage bias by dual termination resistor circuit. Must connect to the USB 3.0 host side.
Host_RX1+	20	I	CML, noninverting differential input for CH1. This pin is tied to an internal voltage bias by dual termination resistor circuit. Must connect to the USB 3.0 host side.
Device_RX2–	8	I	CML, inverting differential input for CH2. This pin is tied to an internal voltage bias by dual termination resistor circuit. Must connect to the USB 3.0 Device side.
Device_RX2+	7	I	CML, noninverting differential input for CH2. This pin is tied to an internal voltage bias by dual termination resistor circuit. Must connect to the USB 3.0 Device side.
Device_TX1–	11	O	CML, inverting differential output for CH1. This pin is tied to an internal voltage bias by termination resistors. Must connect to the USB 3.0 Device side.
Device_TX1+	10	O	CML, noninverting differential output for CH1. This pin is tied to an internal voltage bias by termination resistors. Must connect to the USB 3.0 Device side.
Host_TX2–	22	O	CML, inverting differential output for CH2. This pin is tied to an internal voltage bias by termination resistors. Must connect to the USB 3.0 Host side.
Host_TX2+	23	O	CML, noninverting differential output for CH2. This pin is tied to an internal voltage bias by termination resistors. Must connect to the USB 3.0 Host side.
DEVICE CONTROL PINS			
EN_RXD	17	I	LVC MOS, sets device operation modes per Table 4 ; internally pulled to V_{CC} .
NC	1, 2, 6, 12, 18, 24	—	Pads are not internally connected.
EQ CONTROL PINS⁽²⁾			
DE1, DE2	15, 4	I	LVC MOS, selects de-emphasis settings for CH1 and CH2 per Table 4 ; internally tied to $V_{CC}/2$.
EQ1, EQ2	14, 5	I	LVC MOS, selects equalization settings for CH1 and CH2 per Table 4 ; internally tied to $V_{CC}/2$.
OS1, OS2	16, NC ⁽³⁾	I	LVC MOS, selects output amplitude for CH1 and CH2 per Table 4 ; internally tied to $V_{CC}/2$.
POWER PINS			
GND	9, Thermal Pad	P	Supply ground
VCC	3	P	Positive supply; must be 3.3 V \pm 10%

(1) I = Input, O = Output, P = Power

(2) Internally biased to $V_{CC}/2$ with >200 k Ω pullup or pulldown. When pins are left as NC, board leakage at this pin pad must be <1 μ A otherwise drive to $V_{CC}/2$ to assert mid-level state.

(3) The SN65LVPE502A RLL package has OS2 internal no-connect to select the 1042-mV_{pp} level on TX2.

6 Specifications

6.1 Absolute Maximum Ratings

over operating free-air temperature range (unless otherwise noted)⁽¹⁾

		MIN	MAX	UNIT
Supply voltage, V_{CC} ⁽²⁾		-0.5	4	V
Voltage	Differential I/O	-0.5	4	V
	Control I/O	-0.5	$V_{CC} + 0.5$	V
Continuous power dissipation		See Dissipation Ratings		
Storage temperature, T_{stg}		-65	150	°C

- (1) Stresses beyond those listed under *Absolute Maximum Ratings* may cause permanent damage to the device. These are stress ratings only, which do not imply functional operation of the device at these or any other conditions beyond those indicated under *Recommended Operating Conditions*. Exposure to absolute-maximum-rated conditions for extended periods may affect device reliability.
- (2) All voltage values, except differential voltages, are with respect to network ground terminal.

6.2 ESD Ratings

		VALUE	UNIT
$V_{(ESD)}$ Electrostatic discharge	Human-body model (HBM), per ANSI/ESDA/JEDEC JS-001 ⁽¹⁾	±5000	V
	Charged-device model (CDM), per JEDEC specification JESD22-C101 ⁽²⁾	±1500	
	Machine model ⁽³⁾	±200	

- (1) Tested in accordance with JEDEC Standard 22, Test Method A114-B
- (2) Tested in accordance with JEDEC Standard 22, Test Method C101-A
- (3) Tested in accordance with JEDEC Standard 22, Test Method A115-A

6.3 Recommended Operating Conditions

		MIN	TYP	MAX	UNIT	
V_{CC}	Supply voltage	3	3.3	3.6	V	
$C_{COUPLING}$	AC-coupling capacitor	75		200	nF	
T_A	Operating free-air temperature	-40		85	°C	
DEVICE PARAMETERS						
I_{CC}^{CCCC}	Supply current	EN_RXD, RSVD, EQ cntrl = NC, K28.5 pattern at 5 Gbps, VID = 1000 mV _{pp}		100	120	mA
$I_{CC}^{RX, Detect}$	Supply current	In RX.Detect mode		2	5	mA
I_{CC}^{sleep}	Supply current	EN_RXD = GND		0.01	0.1	mA
I_{CC}^{U2-U3}	Supply current	Link in USB low power state		21		mA
	Maximum data rate				5	Gbps
t_{ENB}	Device enable time	Sleep mode exit time EN_RXD L → H with RX termination present			100	µs
t_{DIS}	Device disable time	Sleep mode entry time EN_RXD H → L			2	µs
$T_{RX, DETECT}$	RX.Detect start event	Power-up time			100	µs
CONTROL LOGIC						
V_{IH}	High-level input voltage	2.8		V_{CC}		V
V_{IL}	Low-level input voltage	-0.3		0.5		V
V_{HYS}	Input hysteresis		150			mV
I_{IH}	High level input current	OSx, EQx, DEx = V_{CC}			30	µA
		EN_RXD = V_{CC}			1	
		RSVD = V_{CC}			30	
I_{IL}	Low level input current	OSx, EQx, DEx = GND		-30		µA
		EN_RXD = GND		-30		
		RSVD = GND		-1		

6.4 Thermal Information

THERMAL METRIC ⁽¹⁾		SN65LVPE502A, SN65LVPE502B		UNIT
		RGE (VQFN)	RLL (VQFN)	
		24 PINS	24 PINS	
R _{θJA}	Junction-to-ambient thermal resistance	46	41.6	°C/W
R _{θJC(top)}	Junction-to-case (top) thermal resistance	42	43.2	°C/W
R _{θJB}	Junction-to-board thermal resistance	13	11.5	°C/W
ψ _{JT}	Junction-to-top characterization parameter	4	6.3	°C/W
ψ _{JB}	Junction-to-board characterization parameter	—	1.1	°C/W
R _{θJC(bot)}	Junction-to-case (bottom) thermal resistance	—	11.5	°C/W

(1) For more information about traditional and new thermal metrics, see the [Semiconductor and IC Package Thermal Metrics](#) application report.

6.5 Electrical Characteristics

over recommended operating conditions (unless otherwise noted)

PARAMETER		TEST CONDITIONS	MIN	TYP	MAX	UNIT	
RECEIVER AC/DC							
V _{in,diff_pp}	RX1, RX2 input voltage swing	AC-coupled differential RX peak-to-peak signal	100		1200	mV _{pp}	
V _{CM_RX}	RX1, RX2 common mode voltage			3.3		V	
V _{in,COM_P}	RX1, RX2 AC peak common mode voltage	Measured at RX pins with termination enabled			150	mV _{pp}	
Z _{CM_RX}	DC common mode impedance		18	26	30	Ω	
Z _{diff_RX}	DC differential input impedance		72	80	120	Ω	
Z _{RX_High_IMP+}	DC Input high impedance	Device in sleep mode RX termination not powered measured with respect to GND over 500 mV maximum	50	85		kΩ	
V _{RX-LFPS-DET-PP}	Low frequency periodic signaling (LFPS) detect threshold	Measured at receiver pin, below minimum output is squelched, above maximum input signal is passed to output	100		300	mV _{pp}	
RL _{RX-DIFF}	Differential return loss	50 MHz to 1.25 GHz 1.25 GHz to 2.5 GHz	10 6	11 7		dB	
RL _{RX-CM}	Common mode return loss	50 MHz to 2.5 GHz	11	13			
TRANSMITTER AC/DC							
V _{TXDIFF_TB-PP}	Differential peak-to-peak output voltage, transition bit (VID = 800, 1200 mV _{pp} , 5 Gbps)	R _L = 100 Ω ±1%, DEX, OSx = NC R _L = 100 Ω ±1%, DEX = NC, OSx = GND R _L = 100 Ω ±1%, DEX = NC, OSx = VCC	800	1042	1200	mV	
V _{TXDIFF_NTb-PP}	Differential peak-to-peak output voltage, non-transition bit (VID = 800, 1200 mV _{pp} , 5 Gbps)	R _L = 100 Ω ±1%, DEX = NC, OSx = 0, 1, NC R _L = 100 Ω ±1%, DEX = 0, OSx = 0, 1, NC R _L = 100 Ω ±1%, DEX = 1, OSx = 0, 1, NC		1042			mV
DE	De-emphasis level OS1, 2 = NC (for OS1, 2 = 1 and 0, see Table 4)	DE1/DE2 = NC DE1/DE2 = 0 (SN65LVPE502A, RLL package) DE1/DE2 = 0 (SN65LVPE502x, RGE packages) DE1/DE2 = 1		0 -3.5 -3			
T _{DE}	De-emphasis width			0.85		UI	
Z _{diff_TX}	DC differential impedance		72	90	120	Ω	
Z _{CM_TX}	DC common mode impedance	Measured w.r.t to AC ground over 0 V to 500 mV	18	23	30	Ω	
RL _{diff_TX}	Differential return loss	f = 50 MHz to 1.25 GHz f = 1.25 GHz to 2.5 GHz	9 6	10 7		dB	
RL _{CM_TX}	Common mode return loss	f = 50 MHz to 2.5 GHz	11	12			
I _{TX_SC}	TX short circuit current	TX± shorted to GND			60	mA	
V _{TX_CM_DC}	Transmitter DC common mode voltage	OSx = NC	2	2.6	3	V	
V _{TX_CM_AC_Active}	TX AC common mode voltage active			30	100	mV _{pp}	
V _{TX_idle_diff-AC_pp}	Electrical idle differential peak to peak output voltage	HPF to remove DC	0		10	mV _{pp}	

Electrical Characteristics (continued)

over recommended operating conditions (unless otherwise noted)

PARAMETER		TEST CONDITIONS	MIN	TYP	MAX	UNIT
$V_{TX_CM_DeltaU1-U0}$	Absolute delta of DC CM voltage during active and idle states			35	200	mV
$V_{TX_idle_diff-DC}$	DC Electrical idle differential output voltage	Voltage must be low pass filtered to remove any AC component	0		10	mV
V_{detect}	Voltage change to allow receiver detect	Positive voltage to sense receiver termination			600	mV
t_R, t_F	Output rise and fall time	20% to 80% of differential voltage measured 1 in. from the output pin	30	65		ps
t_{RF_MM}	Output rise and fall time mismatch	20% to 80% of differential voltage measured 1 in. from the output pin		1.5	20	ps
T_{diff_LH}, T_{diff_HL}	Differential propagation delay	De-emphasis = -3.5 dB (CH 0 and CH 1), propagation delay between 50% level at input and output		305	370	ps
$t_{idleEntry}, t_{idleExit}$	Idle entry and exit times	See Figure 2		4	6	ns
C_{TX}	TX input capacitance to GND	At 2.5 GHz		1.25		pF
JITTER						
$T_{TX-EYE}^{(1)(2)}$	Total jitter (Tj) at point A	Device setting: OS1 = L, DE1 = -6 dB, EQ1 = 7 dB		0.23	0.5	$UI_{pp}^{(3)}$
$DJ_{TX}^{(2)}$	Deterministic jitter (Dj)	Device setting: OS1 = L, DE1 = -6 dB, EQ1 = 7 dB		0.14	0.3	$UI_{pp}^{(3)}$
$RJ_{TX}^{(2)(4)}$	Random jitter (Rj)	Device setting: OS1 = L, DE1 = -6 dB, EQ1 = 7 dB		0.08	0.2	$UI_{pp}^{(3)}$
$T_{TX-EYE}^{(1)(2)}$	Total jitter (Tj) at point B	Device setting: OS2 = H, DE2 = -6 dB, EQ2 = 7 dB		0.15	0.5	$UI_{pp}^{(3)}$
$DJ_{TX}^{(2)}$	Deterministic jitter (Dj)	Device setting: OS2 = H, DE2 = -6 dB, EQ2 = 7 dB		0.07	0.3	$UI_{pp}^{(3)}$
$RJ_{TX}^{(2)(4)}$	Random jitter (Rj)	Device setting: OS2 = H, DE2 = -6 dB, EQ2 = 7 dB		0.08	0.2	$UI_{pp}^{(3)}$

 (1) Includes RJ at 10^{-12} BER.

 (2) Deterministic jitter measured with K28.5 pattern and Random jitter measured with K28.5 pattern at the ends of reference channel in [Figure 5](#), VID = 1000 mV_{pp}, 5 Gbps, and -3.5 dB DE from source.

(3) UI = 200 ps

 (4) Rj calculated as 14.069 times the RMS random jitter for 10^{-12} BER.

6.6 Dissipation Ratings

over recommended operating free-air temperature range (unless otherwise noted)

PARAMETER		TEST CONDITIONS	MIN	TYP	MAX ⁽¹⁾	UNIT
P_D	Device power dissipation	RSVD, EN_RXD, EQ cntrl pins = NC, K28.5 pattern at 5 Gbps, $V_{ID} = 1000$ mV _{pp}		330	450	mW
P_{Slp}	Device power dissipation in sleep mode	EN_RXD = GND		0.03	0.4	mW

(1) The maximum rating is simulated under 3.6 V VCC. Device power: the SN65LVPE502x is designed to operate from a single, 3.3-V supply.

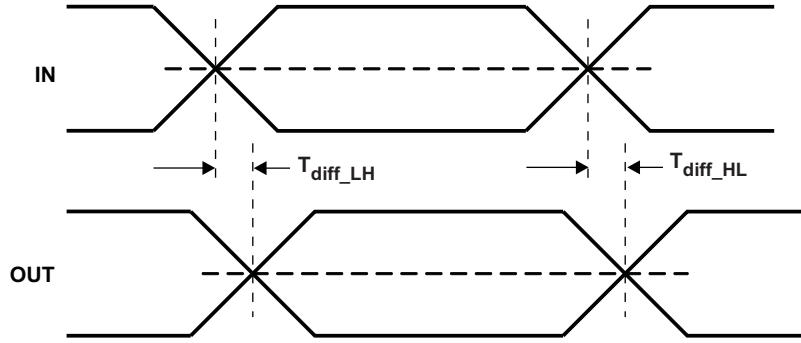

Figure 1. Propagation Delay

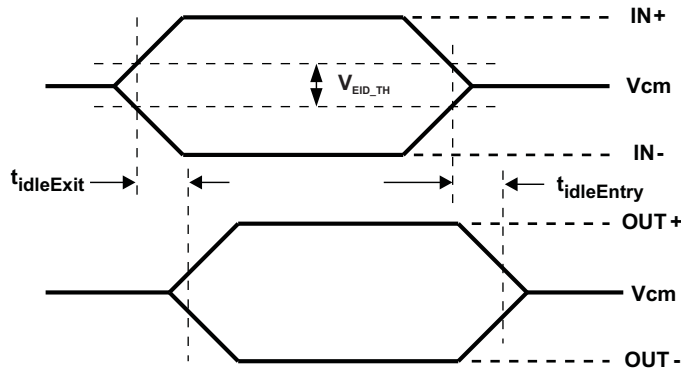

Figure 2. Electrical Idle Mode Exit and Entry Delay

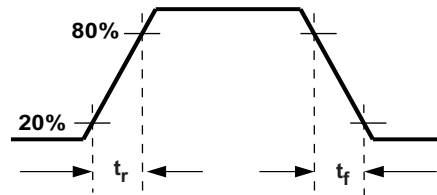

Figure 3. Output Rise and Fall Times

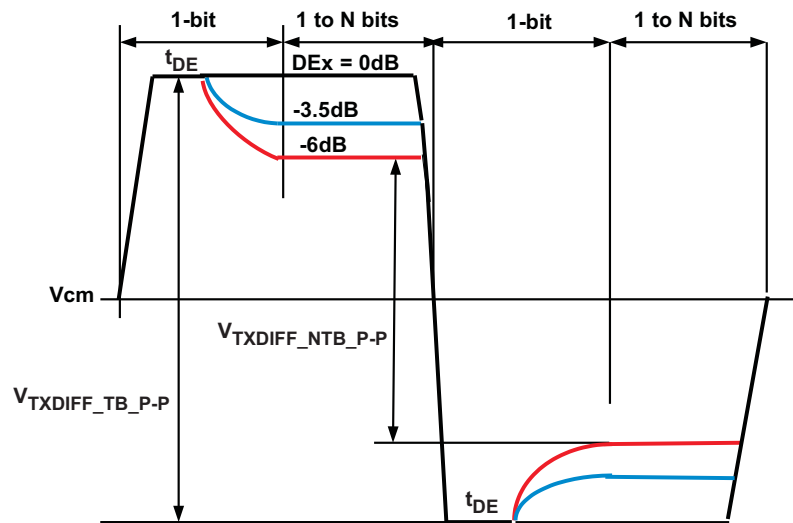
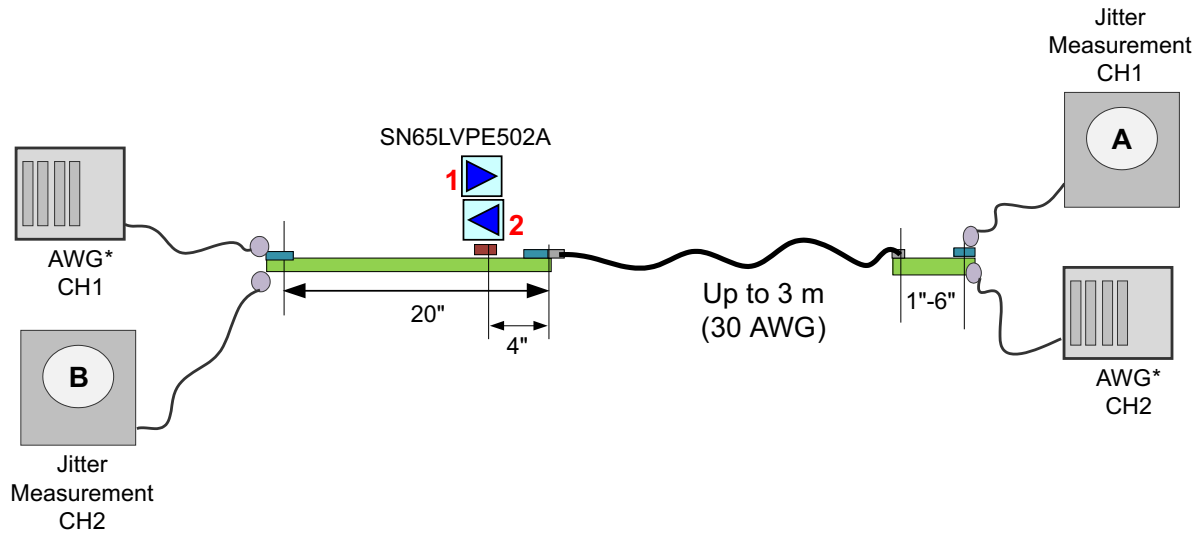
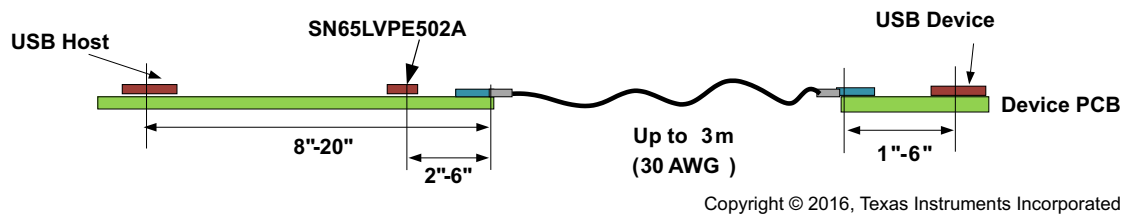

Figure 4. Output De-Emphasis Levels OSx = NC



Copyright © 2016, Texas Instruments Incorporated

Figure 5. Jitter Measurement Setup



Copyright © 2016, Texas Instruments Incorporated

For more detailed placement example of redriver, see [Typical Characteristics](#).

Figure 6. Redriver Placement Example

6.7 Typical Characteristics

Table 1. Case I Fixed Output and Variable Input Trace (3-m Cable)

GRAPH TITLE	FIGURE
DE = 0 dB, EQ = 0 dB, Input = 4 in., Output = 4 in., and 3-m Cable	Figure 7
DE = 0 dB, EQ = 0 dB, Input = 8 in., Output = 4 in., and 3-m Cable	Figure 8
DE = 0 dB, EQ = 0 dB, Input = 12 in., Output = 4 in., and 3-m Cable	Figure 9
DE = 0 dB, EQ = 0 dB, Input = 16 in., Output = 4 in., and 3-m Cable	Figure 10
DE = 0 dB, EQ = 0 dB, Input = 20 in., Output = 4 in., and 3-m Cable	Figure 11
DE = 0 dB, EQ = 7 dB, Input = 24 in., Output = 4 in., and 3-m Cable	Figure 12
DE = 0 dB, EQ = 7 dB, Input = 32 in., Output = 4 in., and 3-m Cable	Figure 13
DE = 0 dB, EQ = 7 dB, Input = 36 in., Output = 4 in., and 3-m Cable	Figure 14
DE = 0 dB, EQ = 15 dB, Input = 36 in., Output = 4 in., and 3-m Cable	Figure 15
DE = 0 dB, EQ = 15 dB, Input = 48 in., Output = 4 in., and 3-m Cable	Figure 16

Table 2. Case II Fixed Input and Variable Output Trace (3-m Cable)

GRAPH TITLE	FIGURE
DE = 0 dB, EQ = 7 dB, Input = 12 in., Output = 4 in., and 3-m Cable	Figure 17
DE = 0 dB, EQ = 7 dB, Input = 12 in., Output = 8 in., and 3-m Cable	Figure 18
DE = 0 dB, EQ = 7 dB, Input = 12 in., Output = 12 in., and 3-m Cable	Figure 19
DE = 0 dB, EQ = 7 dB, Input = 12 in., Output = 16 in., and 3-m Cable	Figure 20
DE = 0 dB, EQ = 7 dB, Input = 12 in., Output = 20 in., and 3-m Cable	Figure 21

Table 3. Case III Fixed Input and Variable Output Trace (No Cable)

GRAPH TITLE	FIGURE
DE = 0 dB, EQ = 7 dB, Input = 12 in., and Output = 8 in.	Figure 22
DE = 0 dB, EQ = 7 dB, Input = 12 in., and Output = 32 in.	Figure 23
DE = 0 dB, EQ = 7 dB, Input = 12 in., and Output = 36 in.	Figure 24
DE = -3.5 dB, EQ = 7 dB, Input = 12 in., and Output = 36 in.	Figure 25
DE = -6 dB, EQ = 7 dB, Input = 12 in., and Output = 40 in.	Figure 26
DE = -6 dB, EQ = 7 dB, Input = 12 in., and Output = 44 in.	Figure 27

6.7.1 Case I – Fixed Output, Variable Input Trace, and 3-m Cable

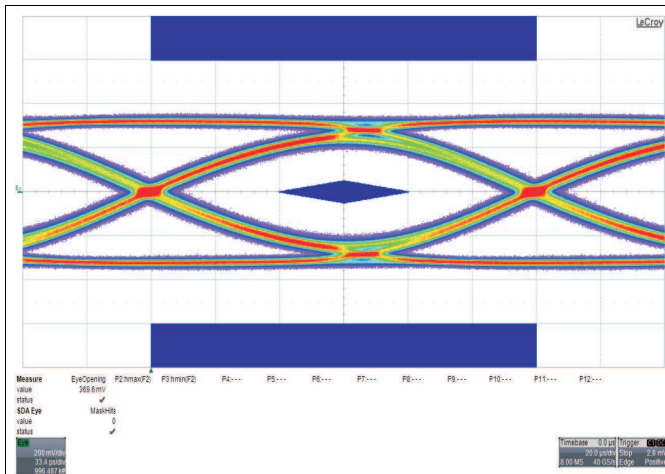

Figure 7. DE = 0 dB, EQ = 0 dB, Input = 4 in., Output = 4 in., and 3-m Cable

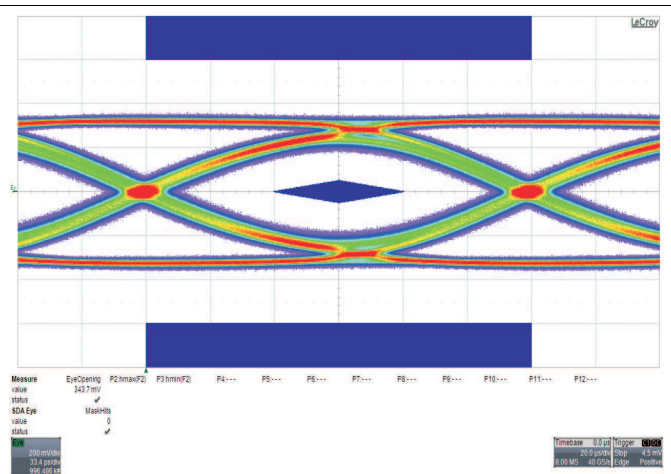

Figure 8. DE = 0 dB, EQ = 0 dB, Input = 8 in., Output = 4 in., and 3-m Cable

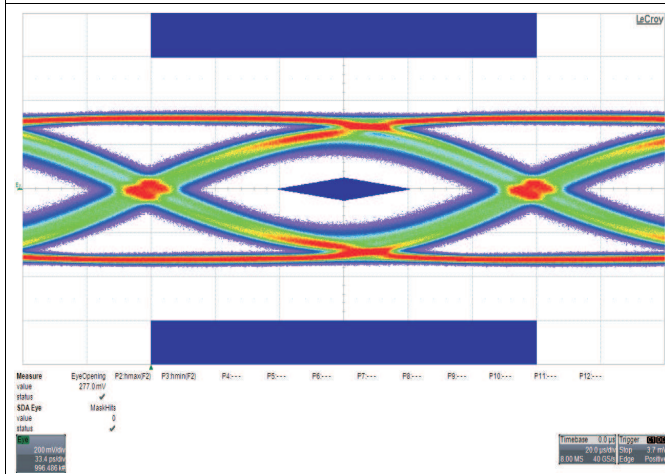

Figure 9. DE = 0 dB, EQ = 0 dB, Input = 12 in., Output = 4 in., and 3-m Cable

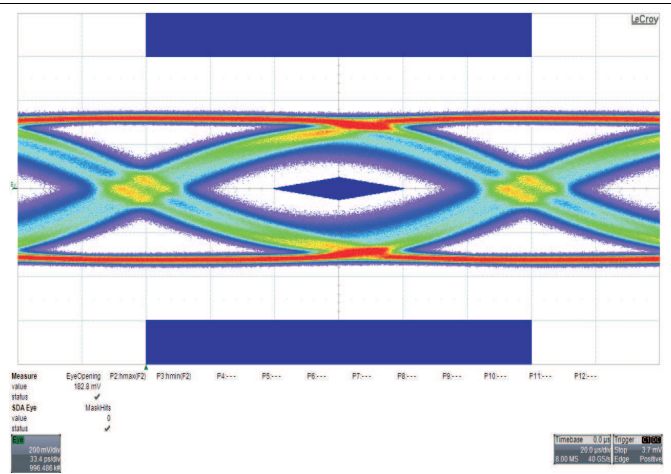

Figure 10. DE = 0 dB, EQ = 0 dB, Input = 16 in., Output = 4 in., and 3-m Cable

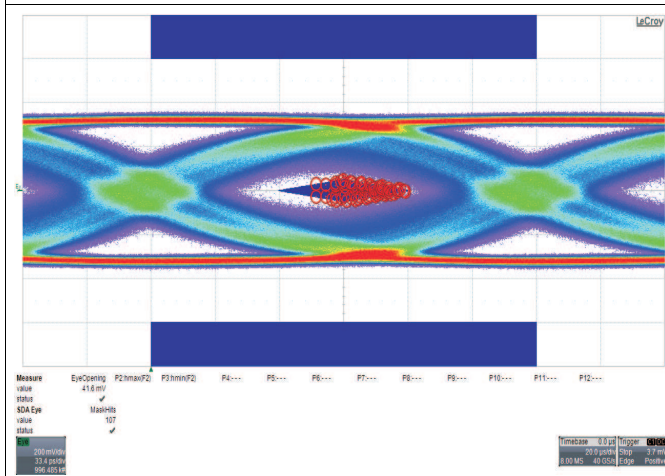

Figure 11. DE = 0 dB, EQ = 0 dB, Input = 20 in., Output = 4 in., and 3-m Cable

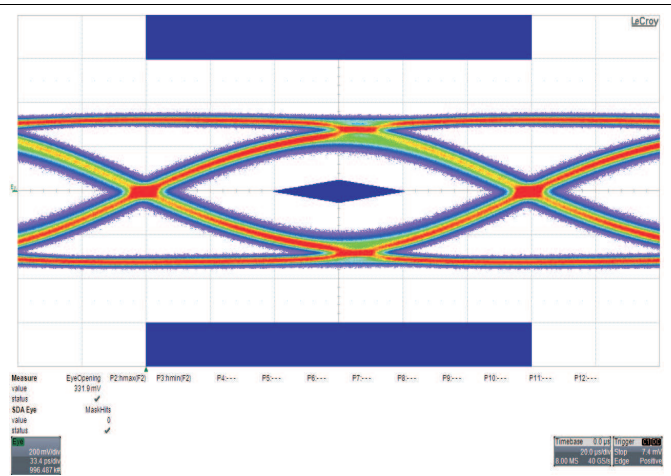

Figure 12. DE = 0 dB, EQ = 7 dB, Input = 24 in., Output = 4 in., and 3-m Cable

Case I – Fixed Output, Variable Input Trace, and 3-m Cable (continued)

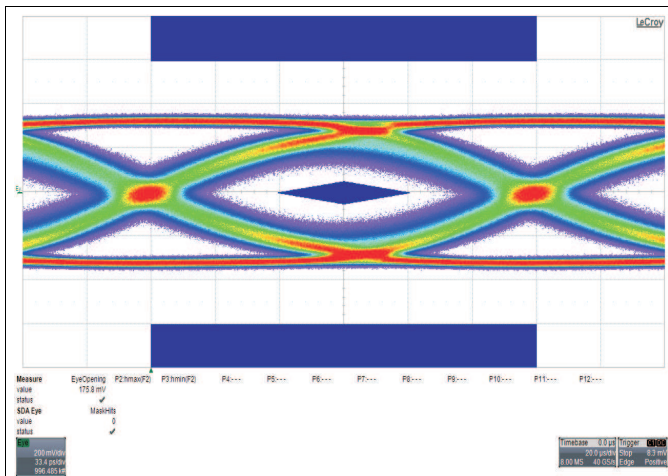

Figure 13. DE = 0 dB, EQ = 7 dB, Input = 32 in., Output = 4 in., and 3-m Cable

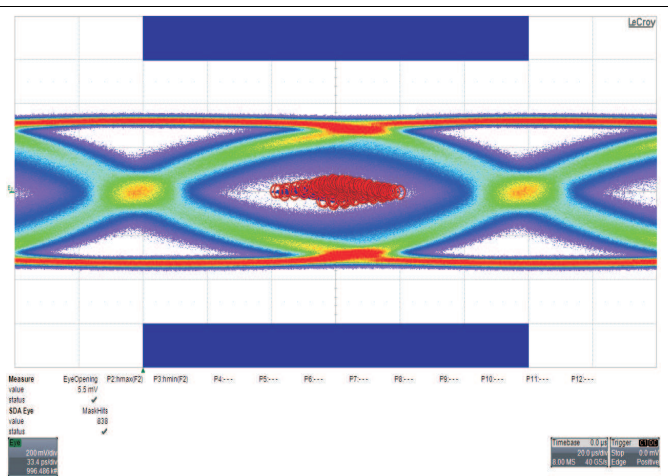

Figure 14. DE = 0 dB, EQ = 7 dB, Input = 36 in., Output = 4 in., and 3-m Cable

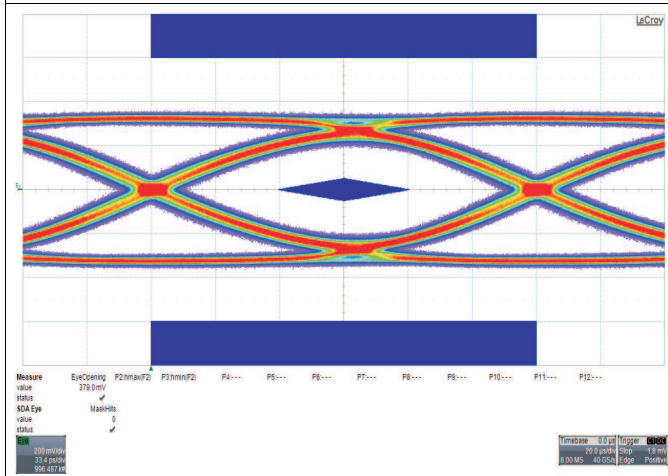

Figure 15. DE = 0 dB, EQ = 15 dB, Input = 36 in., Output = 4 in., and 3-m Cable

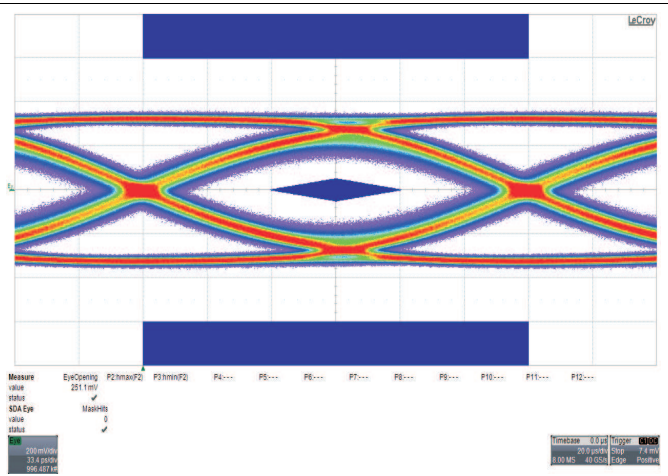

Figure 16. DE = 0 dB, EQ = 15 dB, Input = 48 in., Output = 4 in., and 3-m Cable

6.7.2 Case II – Fixed Input, Variable Output Trace, and 3-m Cable

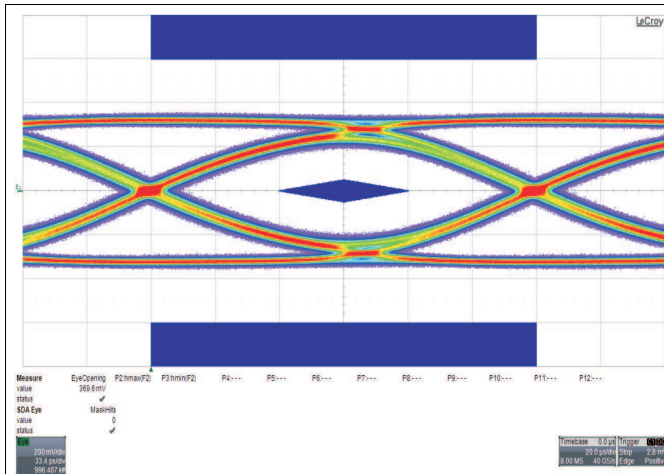

Figure 17. DE = 0 dB, EQ = 7 dB, Input = 12 in., Output = 4 in., and 3-m Cable

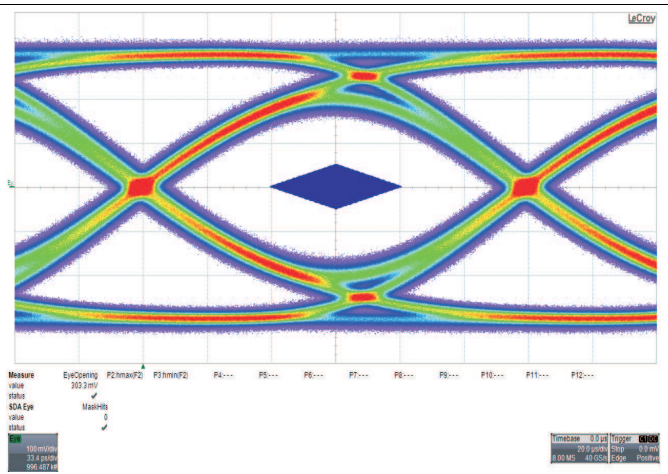

Figure 18. DE = 0 dB, EQ = 7 dB, Input = 12 in., Output = 8 in., and 3-m Cable

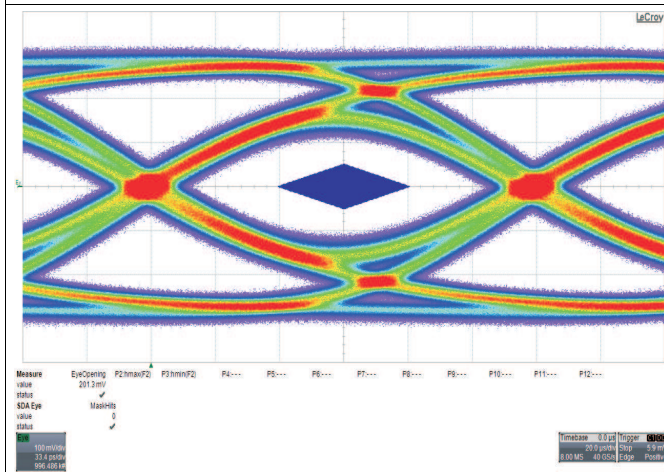

Figure 19. DE = 0 dB, EQ = 7 dB, Input = 12 in., Output = 12 in., and 3-m Cable

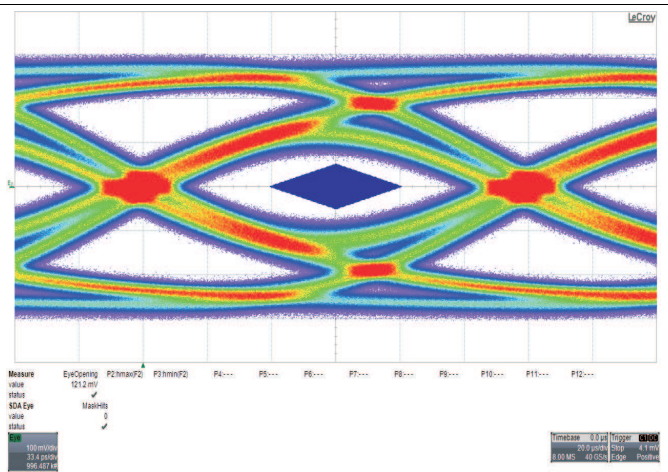

Figure 20. DE = 0 dB, EQ = 7 dB, Input = 12 in., Output = 16 in., and 3-m Cable

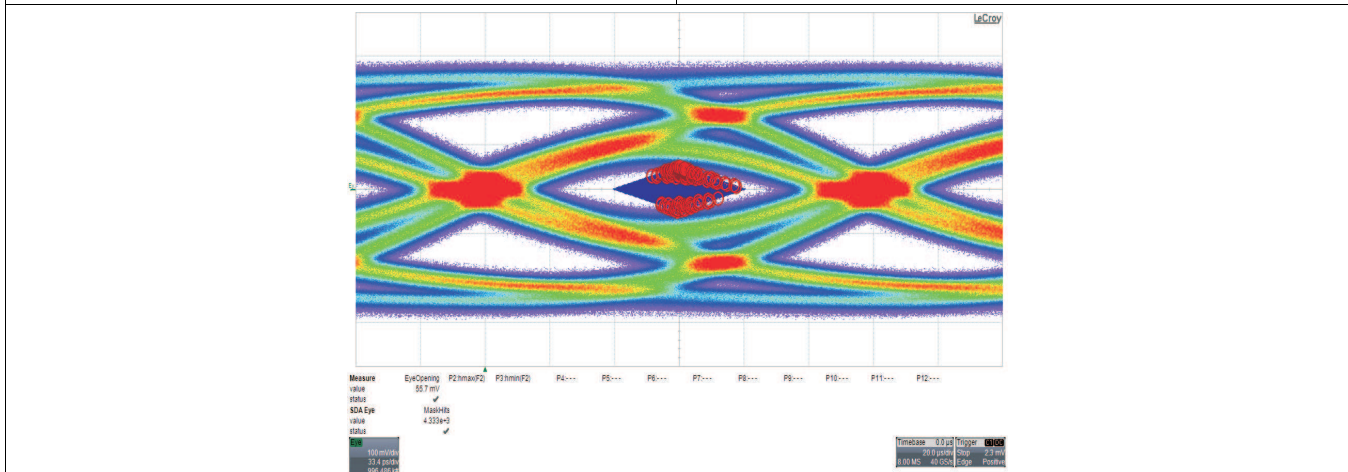

Figure 21. DE = 0 dB, EQ = 7 dB, Input = 12 in., Output = 20 in., and 3-m Cable

6.7.3 Case III – Fixed Input and Variable Output Trace (No Cable)

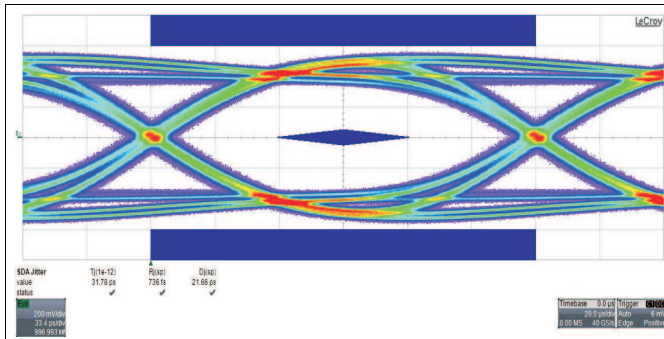

Figure 22. DE = 0 dB, EQ = 7 dB, Input = 12 in., and Output = 8 in.

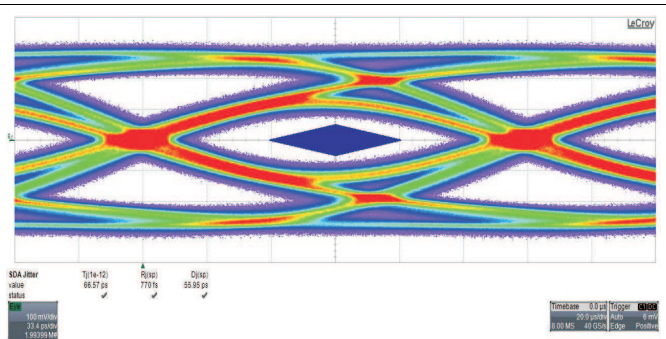

Figure 23. DE = 0 dB, EQ = 7 dB, Input = 12 in., and Output = 32 in.

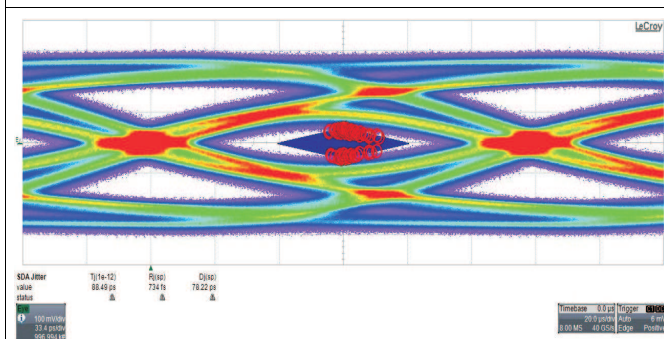

Figure 24. DE = 0 dB, EQ = 7 dB, Input = 12 in., and Output = 36 in.

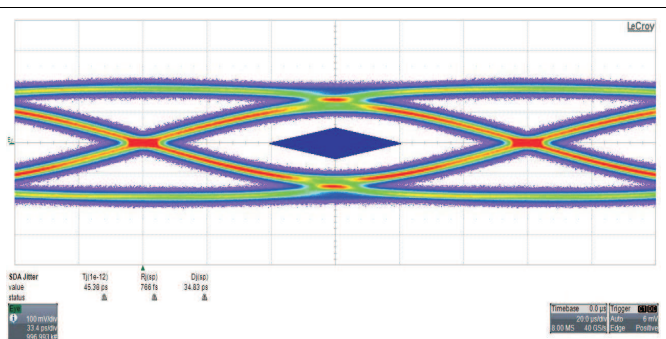

Figure 25. DE = -3.5 dB, EQ = 7 dB, Input = 12 in., and Output = 36 in.

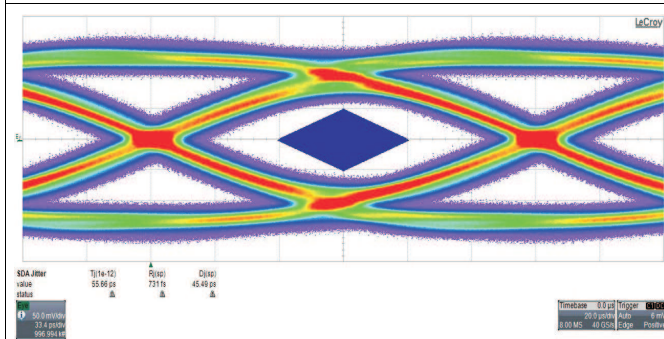

Figure 26. DE = -6 dB, EQ = 7 dB, Input = 12 in., and Output = 40 in.

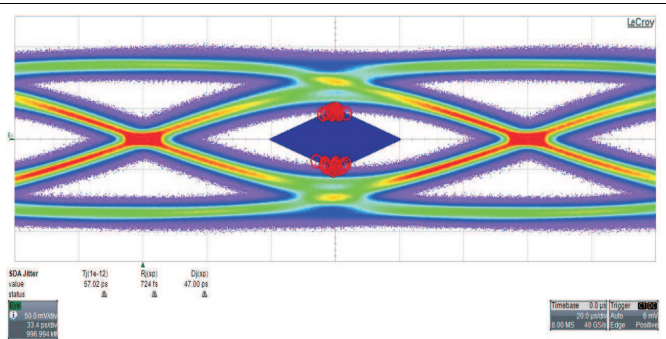

Figure 27. DE = -6 dB, EQ = 7 dB, Input = 12 in., and Output = 44 in.

7 Parameter Measurement Information

7.1 Typical Eye Diagram and Performance Curves

Device operating conditions: VCC = 3.3 V, temperature = 25°C, EQx, DEx, and OSx set to their default values (when not mentioned). Measurement equipment details:

- Generator (source) LeCroy PERT3
- Signal: 5 Gbps, 1000 mV_{pp}, 3.5 dB de-emphasis
- Tj and Dj measurements based on CP0 (USB 3.0 compliance pattern) which is D0.0 or logical idle with SKP sequences removed
- Rj measurements based on CP1 or D10.2 symbol containing alternating 0s and 1s at Nyquist frequency
- Oscilloscope (sink) LeCroy 25-GHz real-time oscilloscope
- LeCroy QualiPHY software used to measure jitter and collect compliance eye diagrams

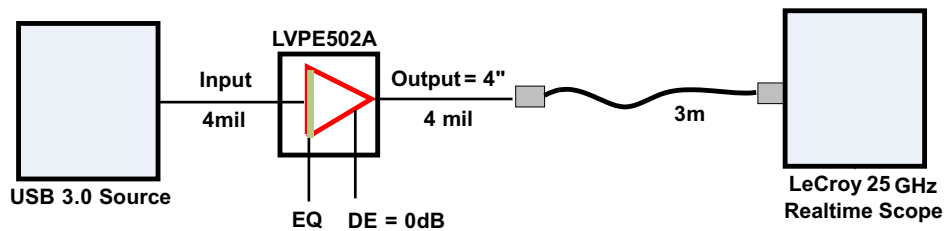

Copyright © 2016, Texas Instruments Incorporated

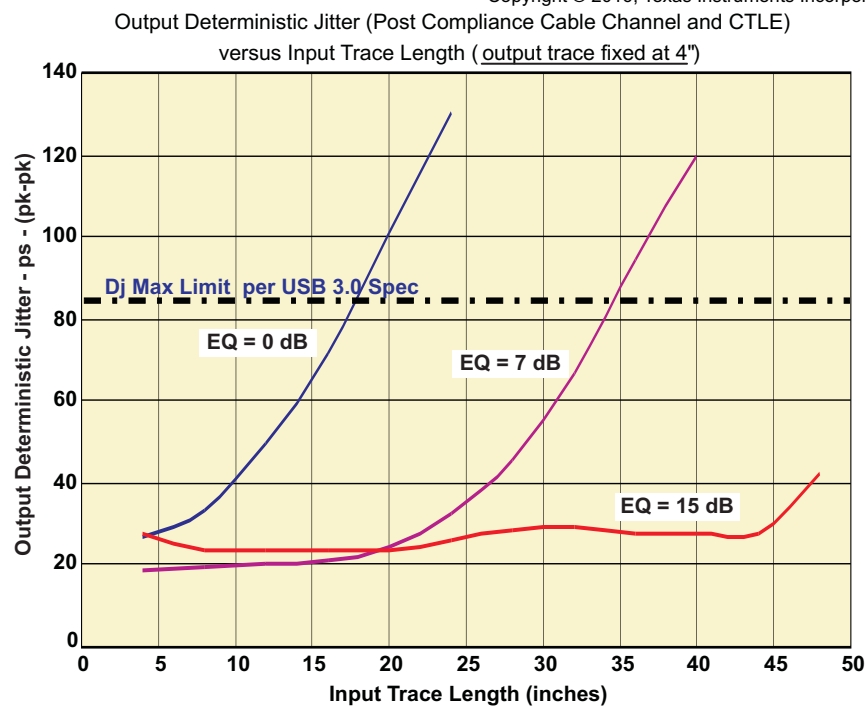
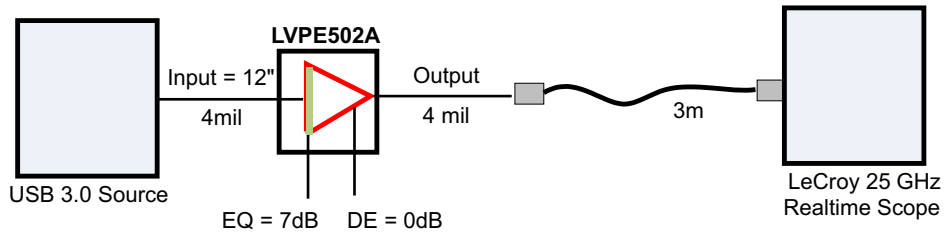

Figure 28. Plot 1 – Fixed Output Trace With Variable Input Trace and 3-m USB 3.0 Cable

Typical Eye Diagram and Performance Curves (continued)



Copyright © 2016, Texas Instruments Incorporated

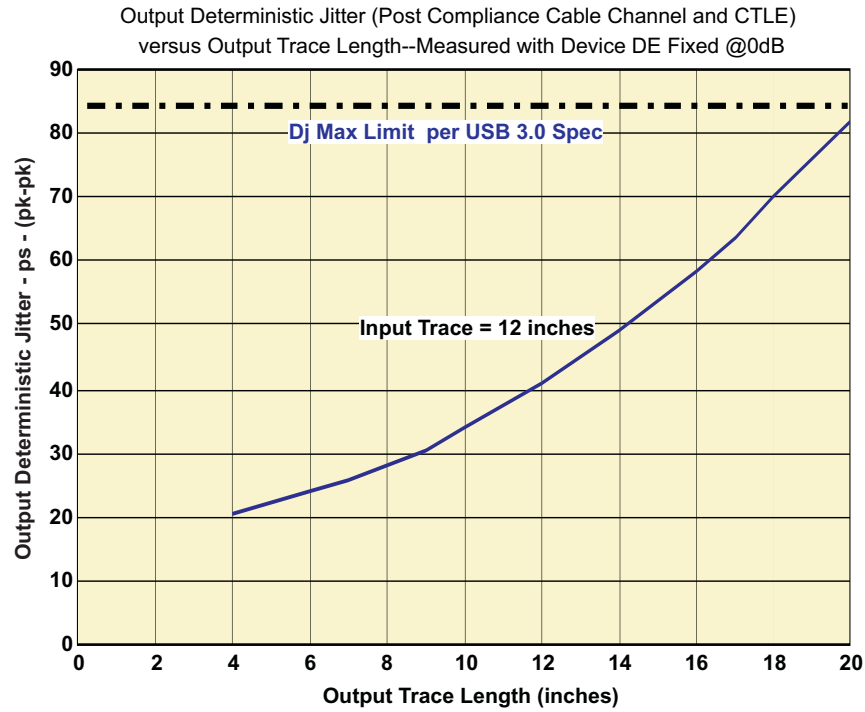
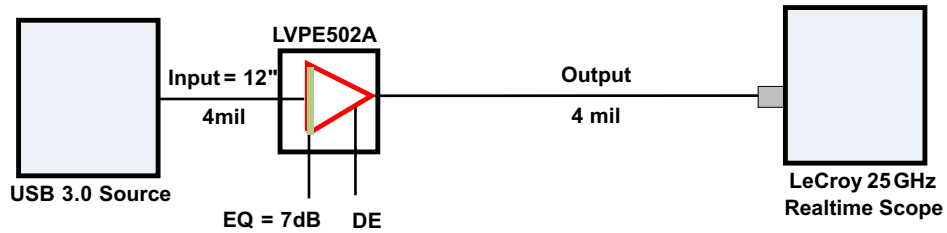

Figure 29. Plot 2 – Fixed Input Trace With Variable Output Trace and 3-m USB 3.0 Cable

Typical Eye Diagram and Performance Curves (continued)



Copyright © 2016, Texas Instruments Incorporated

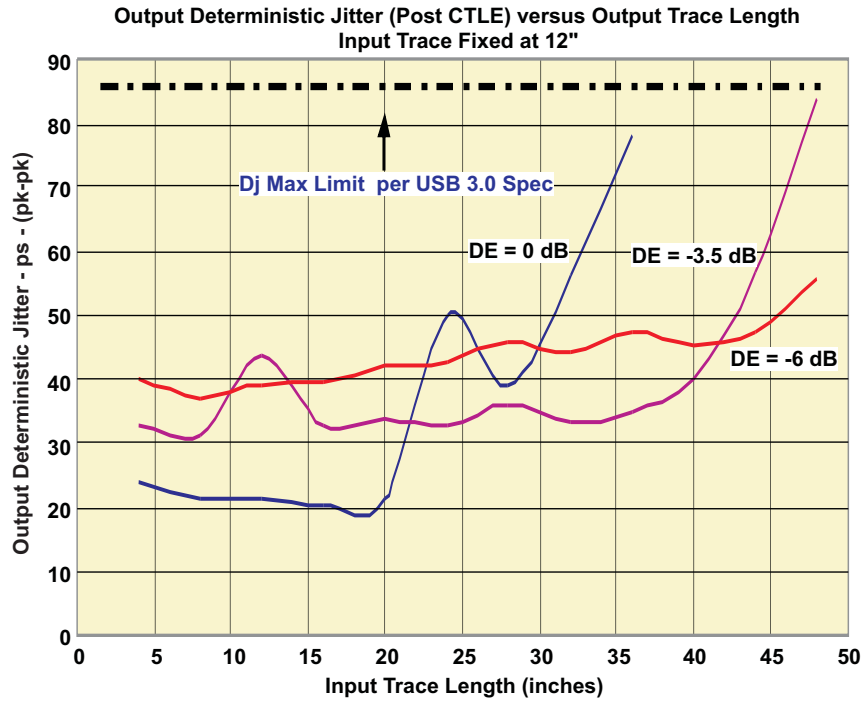

Figure 30. Plot 3 – Fixed Input Trace With Variable Output Trace (No Cable)

8 Detailed Description

8.1 Overview

When 5-Gbps SuperSpeed USB signals travel across a PCB or cable, signal integrity degrades due to loss and inter-symbol interference (ISI). The SN65LVPE502x devices recover incoming data by applying equalization that compensates for channel loss, and drives out signals with a high differential voltage. This extends the possible channel length, and enables systems to pass USB 3.0 compliance. The SN65LVPE502x is located at the *Host* side. After power up, the SN65LVPE502x periodically performs receiver detection on the TX pair. If it detects a SuperSpeed USB receiver, the RX termination is enabled, and the SN65LVPE502x is ready to redrive. The receiver equalizer has three gain settings that are controlled by terminal EQ: 0 dB, 7 dB, and 15 dB. The equalization must be set based on amount of insertion loss in the channel before the SN65LVPE502x. Likewise, the output driver supports configuration of de-emphasis and output swing (terminals DE and OS).

8.2 Functional Block Diagram

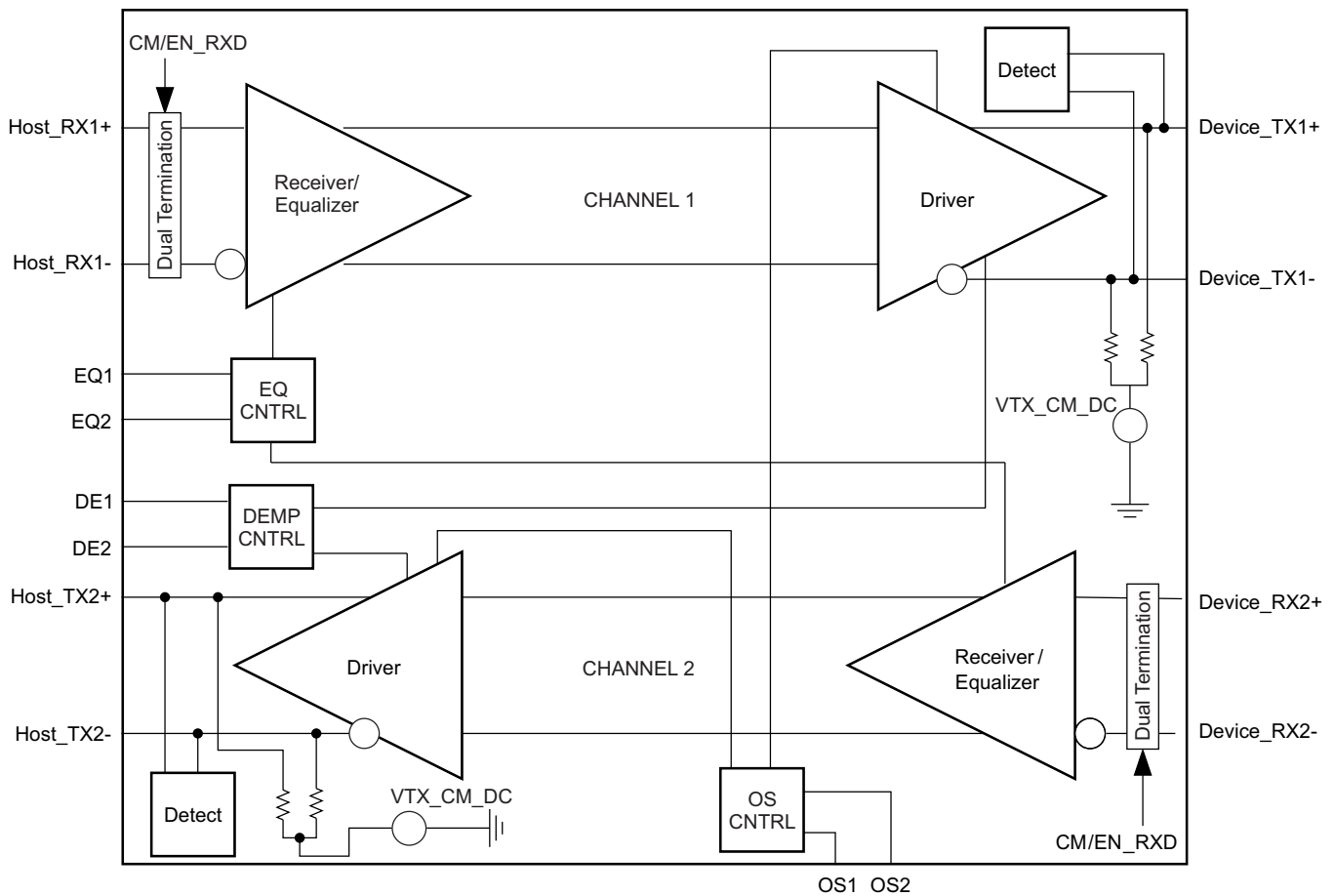

Copyright © 2016, Texas Instruments Incorporated

8.3 Feature Description

8.3.1 Host- and Device-Side Pins

The SN65LVPE502x features a link state machine that makes the device transparent on the USB 3.0 bus while minimizing power. The state machine relies on the system host to be connected to the pins named *Host*. USB 3.0 devices must be connected to the pins named *Device*. Multiple SN65LVPE502x devices may be used in series.

Feature Description (continued)

8.3.2 Programmable EQ, De-Emphasis and Amplitude Swing

The SN65LVPE502x is designed to minimize signal degradation effects such as crosstalk and inter-symbol interference (ISI) that limits the interconnect distance between two devices. The input stage of each channel offers selectable equalization settings that can be programmed to match loss in the channel. The differential outputs provide selectable de-emphasis to compensate for any anticipated USB 3.0 signal distortion experienced. The level of de-emphasis depends on the length of interconnect and its characteristics. The SN65LVPE502x provides a unique way to tailor output de-emphasis on a per channel basis with use of DE and OS pins. All RX and TX equalization settings supported by the device are programmed by six 3-state pins as shown in [Table 4](#).

Table 4. Signal Control Pin Setting

OUTPUT SWING AND EQ CONTROL (AT 2.5 GHz)			
OS _x ⁽¹⁾	TRANSITION BIT AMPLITUDE, TYPICAL (mV _{pp})	EQ _x ⁽¹⁾	EQUALIZATION (dB)
NC (default)	1042	NC (default)	0
0	908	0	7
1	1127	1	15
OUTPUT DE CONTROL (AT 2.5 GHz)			
DE _x ⁽¹⁾	OS _x ⁽¹⁾ = NC	OS _x ⁽¹⁾ = 0	OS _x ⁽¹⁾ = 1
NC (default)	0 dB	0 dB	0 dB
0	-3.5 dB	-2.2 dB	-4.4 dB
1	-6 dB	-5.2 dB	-6 dB

(1) Where x = Channel 1 or Channel 2

8.3.3 Receiver Detection

8.3.3.1 At Power Up or Reset

After power-up or anytime EN_RXD is toggled, RX.Detect cycle is performed by first setting RX termination for each channel to Hi-Z, device then starts sensing for receiver termination that may be attached at the other end of each TX.

If the receiver is detected on both channel, the TX and RX terminations are switched to Z_{DIFF_TX}, Z_{DIFF_RX} respectively.

If no receiver is detected on one or both channels, the transmitter is pulled to Hi-Z; the channel is put in low-power mode; and the device attempts to detect RX termination in 12 ms (typical) interval until termination is found or device is put in sleep mode.

8.3.3.2 During U2/U3 Link State

RX detection is also performed periodically when link is in U2/U3 states. However in these states during RX detection, input termination is not automatically disabled before performing RX.Detect. If termination is found device goes back to its low power state if termination is not found then device disables its input termination and then jumps to power-up RX.Detect state.

8.3.4 Electrical Idle Support

Electrical idle support is required for low frequency periodic signaling (LFPS) used in USB 3.0 side band communication. A link is in an electrical idle state when the TX± voltage is held at a steady constant value like the common mode voltage. SN65LVPE502x detects an electrical idle state when RX± voltage at the device pin falls below VRX_LFPS_DIFF_{pp} minimum. After detection of an idle state in a given channel the device asserts electrical idle state in its corresponding TX. When RX± voltage exceeds VRX_LFPS_DIFF_{pp} maximum normal operation is restored and output start passing input signal. Electrical idle exit and entry time is specified at <6 ns.

8.4 Device Functional Modes

8.4.1 Active Mode

This operating mode is enabled when EN_RXD is driven to VCC and the device has successfully detected the connection with *Host* and *Device*, the redriver applies the desired equalization to the inputs, and drives the output with the selected output swing and de-emphasis.

8.4.2 Low-Power Modes

Device supports three low-power modes as described in [Sleep Mode](#), [RX Detect Mode](#), and [U2/U3 Mode](#).

8.4.2.1 Sleep Mode

Initiated anytime EN_RXD undergoes a high to low transition and stays low or when device powers up with EN_RXD set low. In sleep mode both input and output terminations are held at HiZ and device ceases operation to conserve power. Sleep mode maximum current consumption is 0.1 mA. Entry time is 2 μ s, the device exits sleep mode to Rx.Detect mode after EN_RXD is driven to VCC, and exit time is 100 μ s maximum. [Table 5](#) lists the control pin settings for sleep mode.

Table 5. Control Pin Settings

EN_RXD	DEVICE FUNCTION
1 (default)	Normal operation
0	Sleep mode

8.4.2.2 RX Detect Mode

This mode is only achievable when no remote device is connected.

Anytime SN65LVPE502x detects a break in link (that is, when upstream device is disconnected) or after power up fails to find a remote device, SN65LVPE502x goes to Rx Detect mode and conserves power by shutting down majority of its internal circuitry. In this mode, the input termination for both channels is driven to Hi-Z. In Rx Detect mode the maximum device current consumption is 5mA, which is about the 5% of its normal operating power. This feature is useful in saving system power in mobile applications, such as notebook PCs, where battery life is critical. Anytime an upstream device gets reconnected, the redriver automatically senses the connection and goes to normal operating mode. This operation requires no setting to the device.

8.4.2.3 U2/U3 Mode

With the help of internal timers, the device tracks when link enters USB 3.0 low power modes U2 and U3; in these modes, link is in electrical idle state. SN65LVPE502x selectively turns off internal circuitry to save on power. Typical power saving is about 75% lower than normal operating mode. The device automatically reverts to active mode when signal activity (LFPS) is detected.

9 Application and Implementation

NOTE

Information in the following applications sections is not part of the TI component specification, and TI does not warrant its accuracy or completeness. TI's customers are responsible for determining suitability of components for their purposes. Customers should validate and test their design implementation to confirm system functionality.

9.1 Application Information

One example of the SN65LVPE502x used in a *Host* application on transmit and receive channels is shown in [Typical Application](#). The redriver is required on the PCB path to pass transmitter compliance due to loss between the *Host* and connector. The redriver uses its equalization to recover the insertion loss and re-drive the signal with boosted swing down the remaining channel, through the USB 3.0 cable, and into the device PCB. Additionally on the receiver path, the SN65LVPE502x compensated for the *Host* to pass receiver jitter tolerance. The redriver recovers the loss from the device PCB, connector, and USB 3.0 cable and re-drives the signal going into the *Host* receiver. The equalization, output swing, and de-emphasis settings are dependent upon the type of USB 3.0 signal path and end application.

9.2 Typical Application

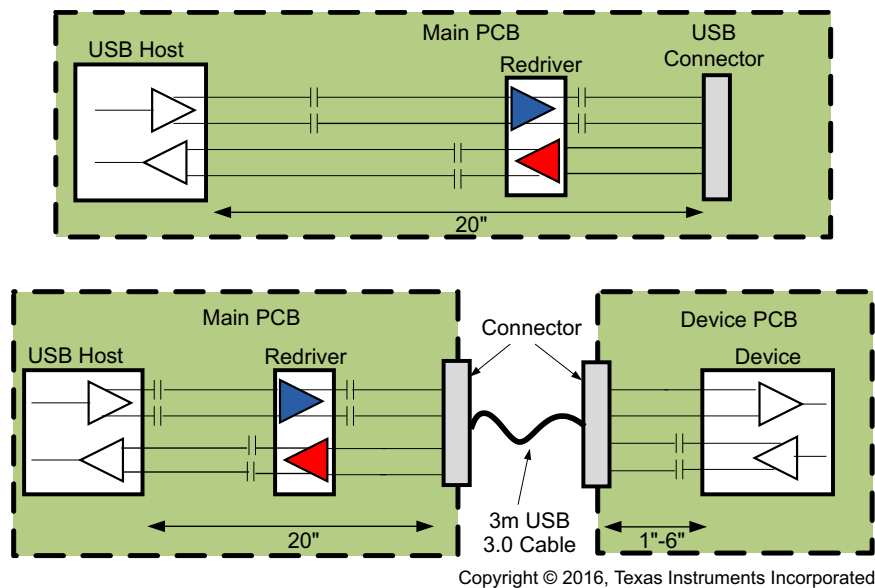

Figure 31. Typical Application Schematic

9.2.1 Design Requirements

Table 6 lists the parameters for this example.

Table 6. Application Parameters

PARAMETER	VALUE
Input voltage range	100 mV to 1200 mV
Output voltage range	1050 mV to 1200 mV
Equalization	0, 7, 15 bD (2.5 Gbps)
De-emphasis	0, -3, -5 dB (OS floating)
VCC	3.3-V nominal supply

9.2.2 Detailed Design Procedure

The SN65LVPE502x is placed in the *Host* side and connected to a USB3 Type-A connector. The EQ and DE terminals must be pulled up, pulled down, or left floating depending on the amount of equalization or de-emphasis that is desired. The OS terminal must be pulled down or left floating depending on the required output swing. This device has terminals to be exclusively connected to the *Host* and to the device accordingly. In this *Host* side (even though the RX and TX pairs must be AC-coupled), this is an embedded implementation and [Figure 31](#) only shows the AC-coupling capacitors on the TX pair to follow the convention.

To begin the design process, determine the following:

- Equalization (EQ) setting
- De-emphasis (DE) setting
- Output swing amplitude (OS) setting

The equalization must be set based on the insertion loss in the pre-channel (channel before the SN65LVPE502x device). The input voltage to the device is able to have a large range because of the receiver sensitivity and the available EQ settings. The EQ terminal can be pulled high through a resistor to VCC, low through a resistor to ground, or left floating. The de-emphasis setting must be set based on the length and characteristics of the post channel (channel after the SN65LVPE502x device). Output de-emphasis can be tailored using the DE terminal. This terminal must be pulled high through a resistor to VCC, low through a resistor to ground, or left floating. The output swing setting can also be configured based on the amplitude requirement to pass the compliance test. This setting is also based on the length of interconnect or cable the SN65LVPE502x is driving. This terminal must be pulled low through a resistor to ground or left floating.

9.2.3 Application Curves

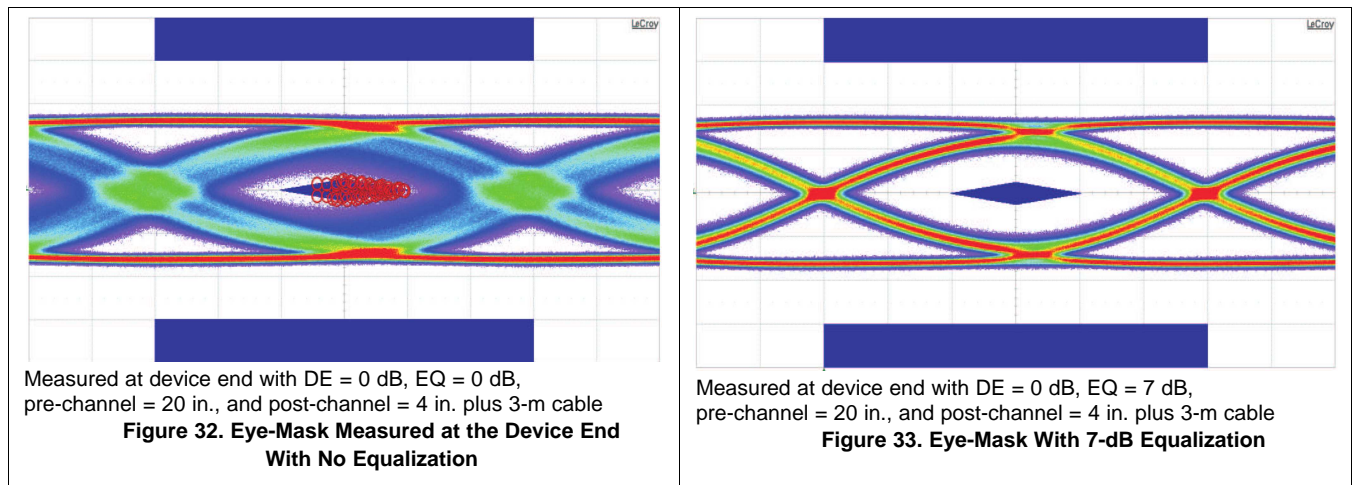

10 Power Supply Recommendations

The SN65LVPE502x is designed to operate with a single, 3.3-V supply.

11 Layout

11.1 Layout Guidelines

1. The 100-nF capacitors on the TXP and SSTXN nets must be placed close to the USB connector (Type A, Type B, and so forth).
2. The ESD and EMI protection devices (if used) must also be placed as close as possible to the USB connector.
3. Place voltage regulators as far away as possible from the differential pairs.
4. In general, the large bulk capacitors associated with each power rail must be placed as close as possible to the voltage regulators.
5. TI recommends that small decoupling capacitors for the 1.8-V power rail be placed close to the SN65LVPE502x as shown below.
6. The SuperSpeed differential pair traces for RXP/N and TXP/N must be designed with a characteristic impedance of $90\ \Omega \pm 10\%$. The PCB stack-up and materials determine the width and spacing required for a characteristic impedance of $90\ \Omega$.
7. The SuperSpeed differential pair traces must be routed parallel to each other as much as possible. TI recommends the traces be symmetrical.
8. To minimize crosstalk, TI recommends keeping high-speed signals away from each other. Each pair must be separated by at least 5 times the signal trace width. Separating with ground also helps minimize crosstalk.
9. Route all differential pairs on the same layer adjacent to a solid ground plane.
10. Do not route differential pairs over any plane split.
11. Adding test points causes impedance discontinuity and therefore negatively impacts signal performance. If test points are used, they must be placed in series and symmetrically. They must not be placed in a manner that causes stub on the differential pair.
12. Match the etch lengths of the differential pair traces. There must be less than 5-mils difference between a SS differential pair signal and its complement. The USB 2.0 differential pairs must not exceed 50-mils relative trace length difference.
13. The etch lengths of the differential pair groups do not need to match (that is, the length of the RXP/N pair to that of the TXP/N pair), but all trace lengths must be minimized.
14. Minimize the use of vias in the differential pair paths as much as possible. If this is not practical, make sure that the same via type and placement are used for both signals in a pair. Any vias used must be placed as close as possible to the SN65LVPE502x device.
15. To ease routing, the polarity of the SS differential pairs can be swapped. This means that TXP can be routed to TXN or RXN can be routed to RXP.
16. Do not place power fuses across the differential pair traces.

11.2 Layout Example

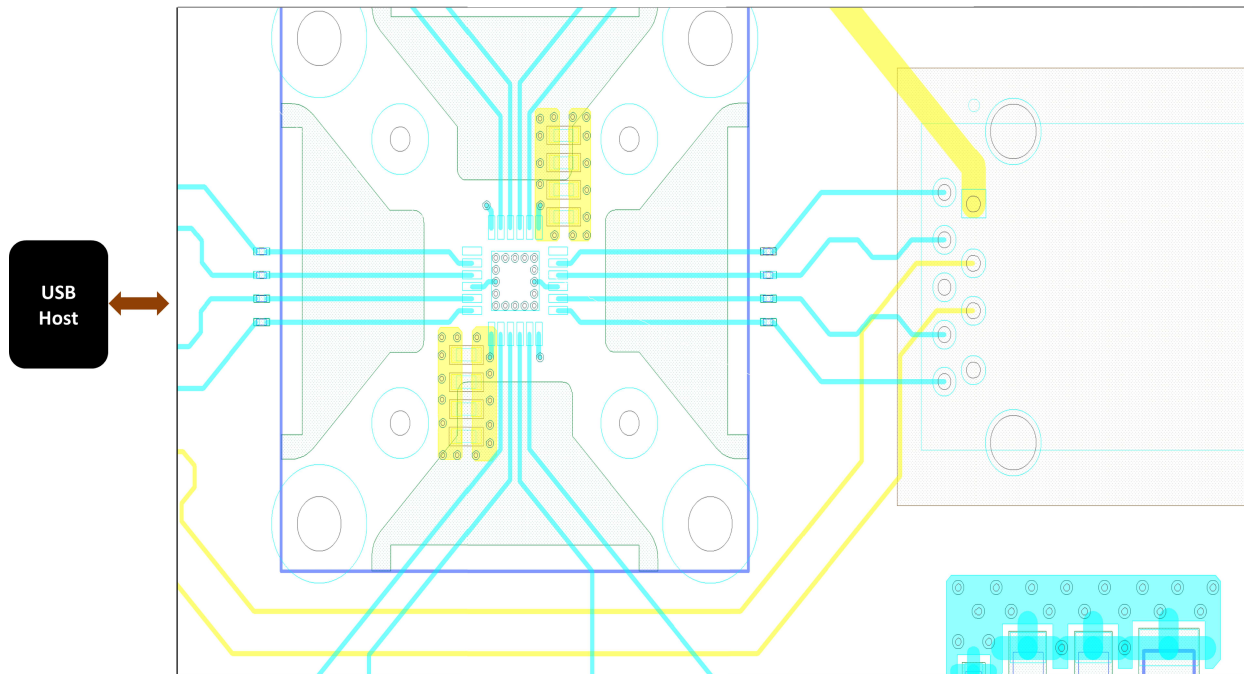

Figure 34. SN65LVPE502A USB 3.0 Signals Routing With Embedded Host and Std. Type A Connector

12 Device and Documentation Support

12.1 Documentation Support

12.1.1 Related Documentation

For related documentation see the following:

[SN65LVPE502A to USB522P Change Document](#) (SLLA363)

12.2 Receiving Notification of Documentation Updates

To receive notification of documentation updates, navigate to the device product folder on ti.com. In the upper right corner, click on *Alert me* to register and receive a weekly digest of any product information that has changed. For change details, review the revision history included in any revised document.

12.3 Community Resources

The following links connect to TI community resources. Linked contents are provided "AS IS" by the respective contributors. They do not constitute TI specifications and do not necessarily reflect TI's views; see TI's [Terms of Use](#).

TI E2E™ Online Community *TI's Engineer-to-Engineer (E2E) Community*. Created to foster collaboration among engineers. At e2e.ti.com, you can ask questions, share knowledge, explore ideas and help solve problems with fellow engineers.

Design Support *TI's Design Support* Quickly find helpful E2E forums along with design support tools and contact information for technical support.

12.4 Trademarks

E2E is a trademark of Texas Instruments.
All other trademarks are the property of their respective owners.

12.5 Electrostatic Discharge Caution



These devices have limited built-in ESD protection. The leads should be shorted together or the device placed in conductive foam during storage or handling to prevent electrostatic damage to the MOS gates.

12.6 Glossary

[SLYZ022](#) — *TI Glossary*.

This glossary lists and explains terms, acronyms, and definitions.

13 Mechanical, Packaging, and Orderable Information

The following pages include mechanical, packaging, and orderable information. This information is the most current data available for the designated devices. This data is subject to change without notice and revision of this document. For browser-based versions of this data sheet, refer to the left-hand navigation.

PACKAGING INFORMATION

Orderable Device	Status (1)	Package Type	Package Drawing	Pins	Package Qty	Eco Plan (2)	Lead finish/ Ball material (6)	MSL Peak Temp (3)	Op Temp (°C)	Device Marking (4/5)	Samples
SN65LVPE502ARGER	NRND	VQFN	RGE	24	3000	RoHS & Green	NIPDAU	Level-2-260C-1 YEAR	-40 to 85	502A	
SN65LVPE502ARLLR	NRND	VQFN	RLL	24	3000	RoHS & Green	NIPDAU	Level-1-260C-UNLIM	-40 to 85	SN502A	
SN65LVPE502ARLLT	NRND	VQFN	RLL	24		TBD	Call TI	Call TI	-40 to 85		
SN65LVPE502BRGER	NRND	VQFN	RGE	24	3000	RoHS & Green	NIPDAU	Level-2-260C-1 YEAR	-40 to 85	502B	

(1) The marketing status values are defined as follows:

ACTIVE: Product device recommended for new designs.

LIFEBUY: TI has announced that the device will be discontinued, and a lifetime-buy period is in effect.

NRND: Not recommended for new designs. Device is in production to support existing customers, but TI does not recommend using this part in a new design.

PREVIEW: Device has been announced but is not in production. Samples may or may not be available.

OBSELETE: TI has discontinued the production of the device.

(2) **RoHS:** TI defines "RoHS" to mean semiconductor products that are compliant with the current EU RoHS requirements for all 10 RoHS substances, including the requirement that RoHS substance do not exceed 0.1% by weight in homogeneous materials. Where designed to be soldered at high temperatures, "RoHS" products are suitable for use in specified lead-free processes. TI may reference these types of products as "Pb-Free".

RoHS Exempt: TI defines "RoHS Exempt" to mean products that contain lead but are compliant with EU RoHS pursuant to a specific EU RoHS exemption.

Green: TI defines "Green" to mean the content of Chlorine (Cl) and Bromine (Br) based flame retardants meet JS709B low halogen requirements of <=1000ppm threshold. Antimony trioxide based flame retardants must also meet the <=1000ppm threshold requirement.

(3) **MSL, Peak Temp.** - The Moisture Sensitivity Level rating according to the JEDEC industry standard classifications, and peak solder temperature.

(4) There may be additional marking, which relates to the logo, the lot trace code information, or the environmental category on the device.

(5) Multiple Device Markings will be inside parentheses. Only one Device Marking contained in parentheses and separated by a "~" will appear on a device. If a line is indented then it is a continuation of the previous line and the two combined represent the entire Device Marking for that device.

(6) **Lead finish/Ball material** - Orderable Devices may have multiple material finish options. Finish options are separated by a vertical ruled line. Lead finish/Ball material values may wrap to two lines if the finish value exceeds the maximum column width.

Important Information and Disclaimer:The information provided on this page represents TI's knowledge and belief as of the date that it is provided. TI bases its knowledge and belief on information provided by third parties, and makes no representation or warranty as to the accuracy of such information. Efforts are underway to better integrate information from third parties. TI has taken and continues to take reasonable steps to provide representative and accurate information but may not have conducted destructive testing or chemical analysis on incoming materials and chemicals. TI and TI suppliers consider certain information to be proprietary, and thus CAS numbers and other limited information may not be available for release.

In no event shall TI's liability arising out of such information exceed the total purchase price of the TI part(s) at issue in this document sold by TI to Customer on an annual basis.

TAPE AND REEL INFORMATION

QUADRANT ASSIGNMENTS FOR PIN 1 ORIENTATION IN TAPE

*All dimensions are nominal

Device	Package Type	Package Drawing	Pins	SPQ	Reel Diameter (mm)	Reel Width W1 (mm)	A0 (mm)	B0 (mm)	K0 (mm)	P1 (mm)	W (mm)	Pin1 Quadrant
SN65LVPE502ARGER	VQFN	RGE	24	3000	330.0	12.4	4.25	4.25	1.15	8.0	12.0	Q2
SN65LVPE502ARLLR	VQFN	RLL	24	3000	330.0	12.4	3.3	3.3	1.1	8.0	12.0	Q2
SN65LVPE502BRGER	VQFN	RGE	24	3000	330.0	12.4	4.25	4.25	1.15	8.0	12.0	Q2

TAPE AND REEL BOX DIMENSIONS

*All dimensions are nominal

Device	Package Type	Package Drawing	Pins	SPQ	Length (mm)	Width (mm)	Height (mm)
SN65LVPE502ARGER	VQFN	RGE	24	3000	356.0	356.0	35.0
SN65LVPE502ARLLR	VQFN	RLL	24	3000	346.0	346.0	33.0
SN65LVPE502BRGER	VQFN	RGE	24	3000	356.0	356.0	35.0

RGE 24

GENERIC PACKAGE VIEW

VQFN - 1 mm max height

PLASTIC QUAD FLATPACK - NO LEAD



Images above are just a representation of the package family, actual package may vary.
Refer to the product data sheet for package details.

4204104/H

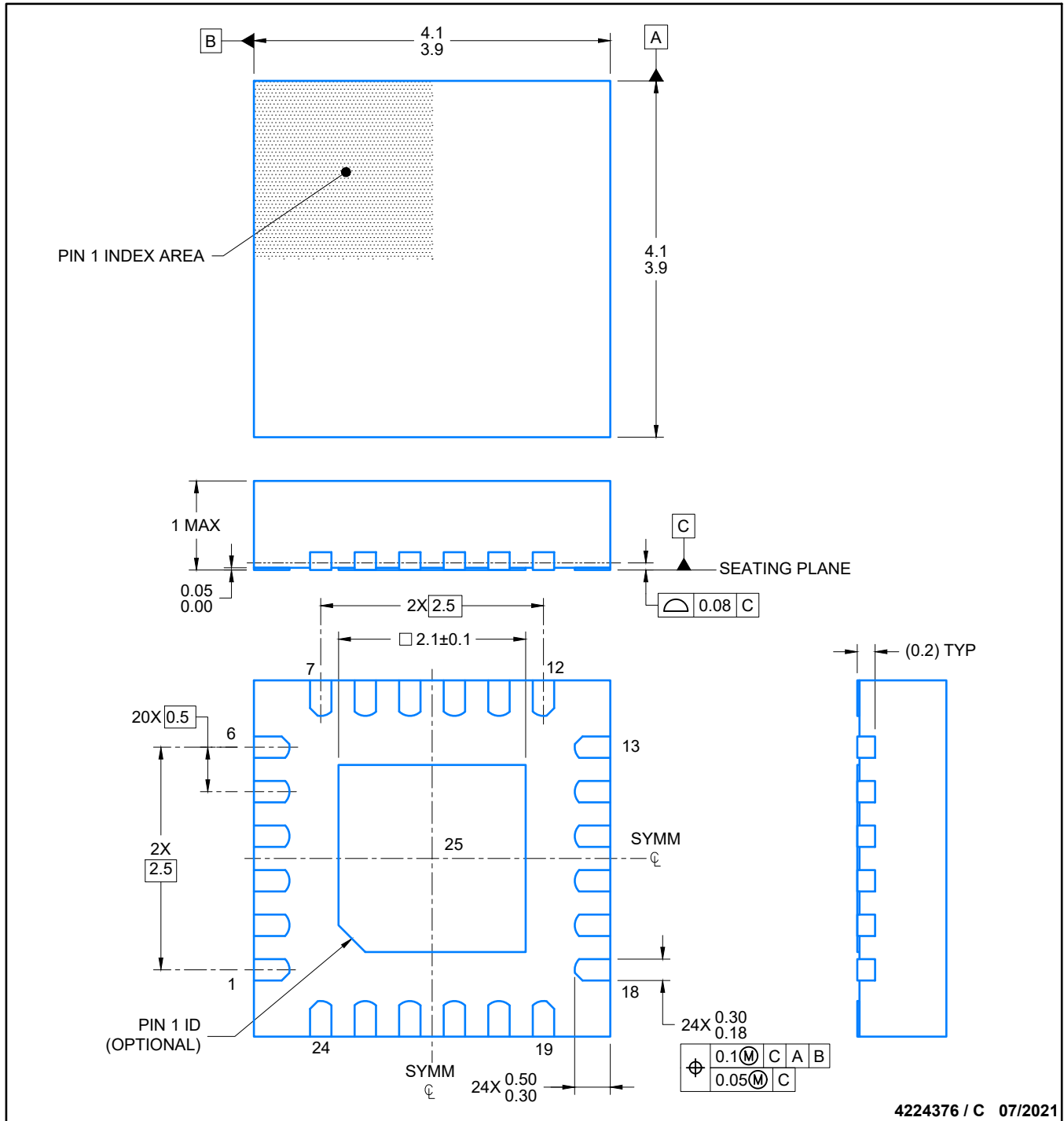

4224376 / C 07/2021

NOTES:

1. All linear dimensions are in millimeters. Any dimensions in parenthesis are for reference only. Dimensioning and tolerancing per ASME Y14.5M.
2. This drawing is subject to change without notice.
3. The package thermal pad must be soldered to the printed circuit board for thermal and mechanical performance.

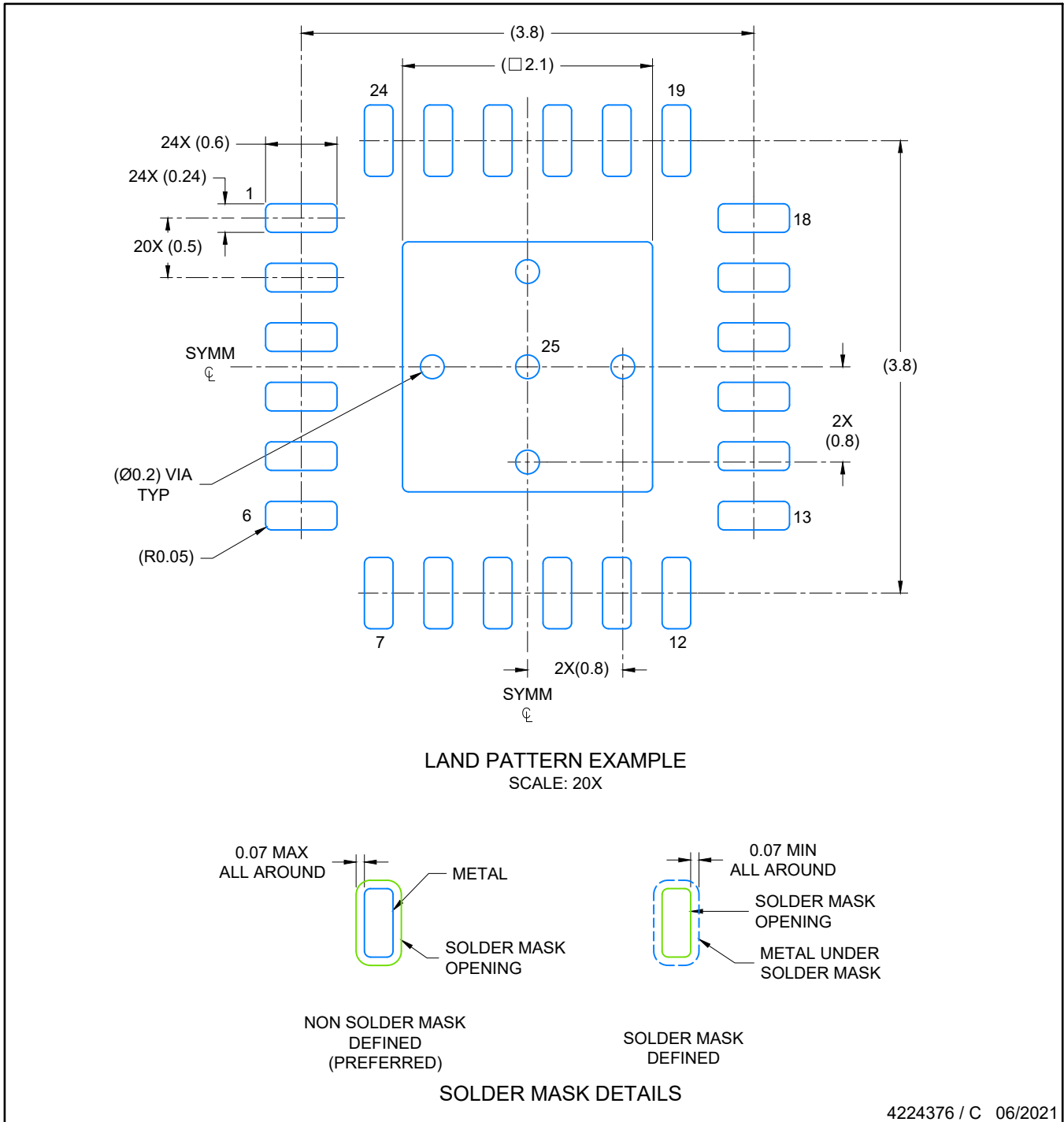

NOTES: (continued)

4. This package is designed to be soldered to a thermal pad on the board. For more information, see Texas Instruments literature number SLUA271 (www.ti.com/lit/slua271).
5. Solder mask tolerances between and around signal pads can vary based on board fabrication site.

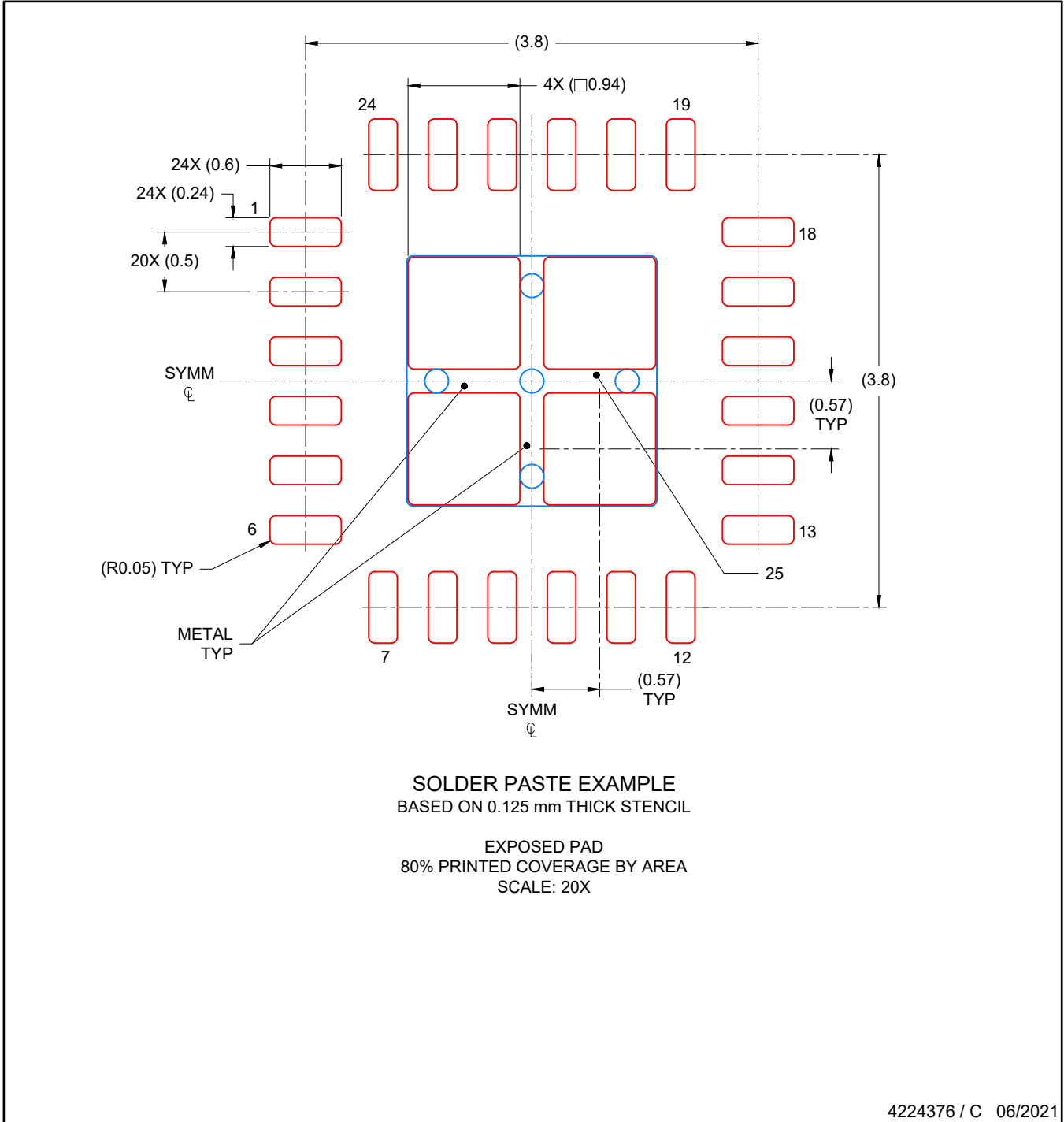

NOTES: (continued)

- 6. Laser cutting apertures with trapezoidal walls and rounded corners may offer better paste release. IPC-7525 may have alternate design recommendations..

RLL (S-PVQFN-N24)

PLASTIC QUAD FLATPACK NO-LEAD

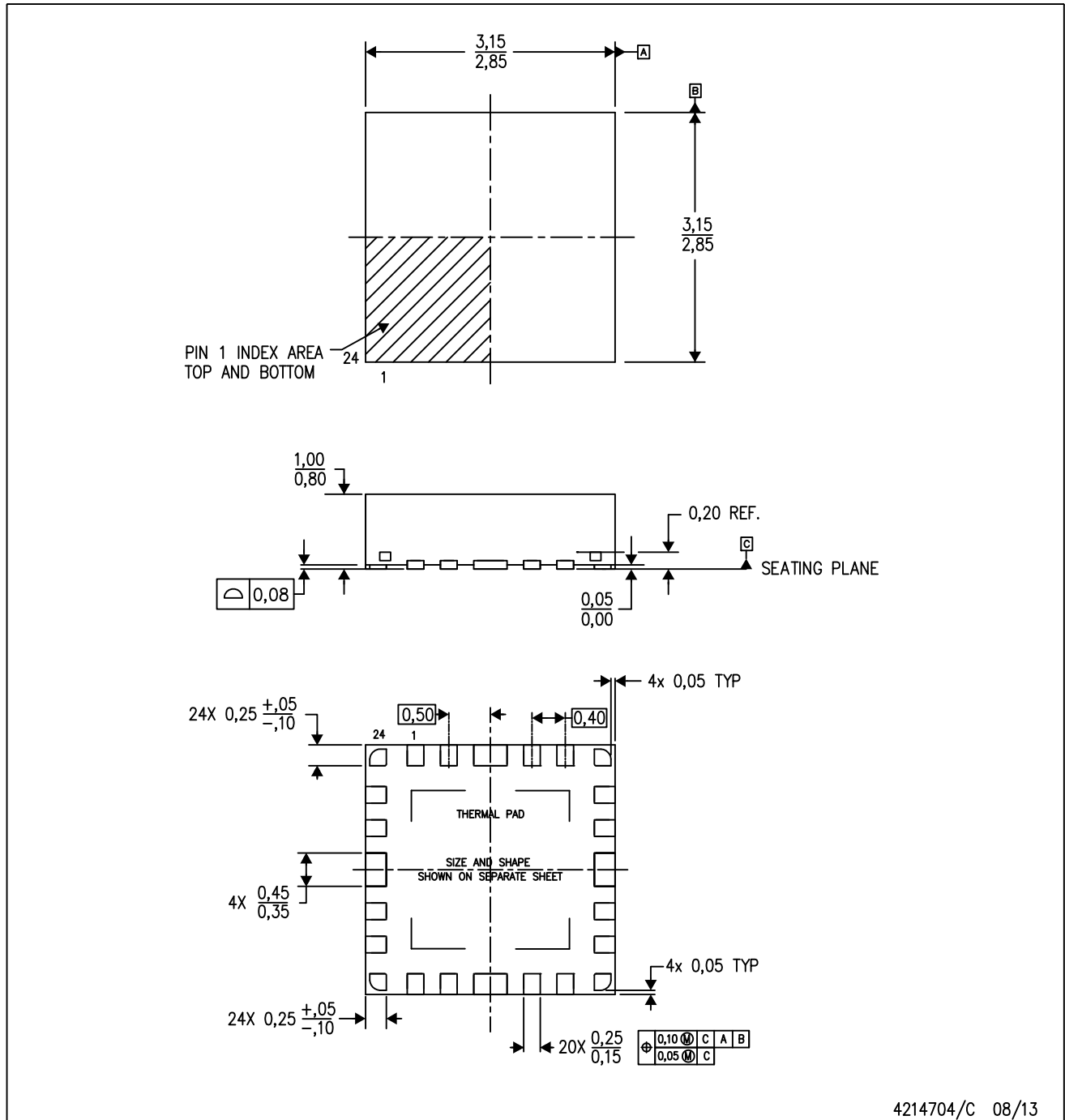

4214704/C 08/13

- NOTES:
- A. All linear dimensions are in millimeters. Dimensioning and tolerancing per ASME Y14.5M-1994.
 - B. This drawing is subject to change without notice.
 - C. Quad Flatpack, No-leads (QFN) package configuration.
 - D. The package thermal pad must be soldered to the board for thermal and mechanical performance.
 - E. See the additional figure in the Product Data Sheet for details regarding the exposed thermal pad features and dimensions.

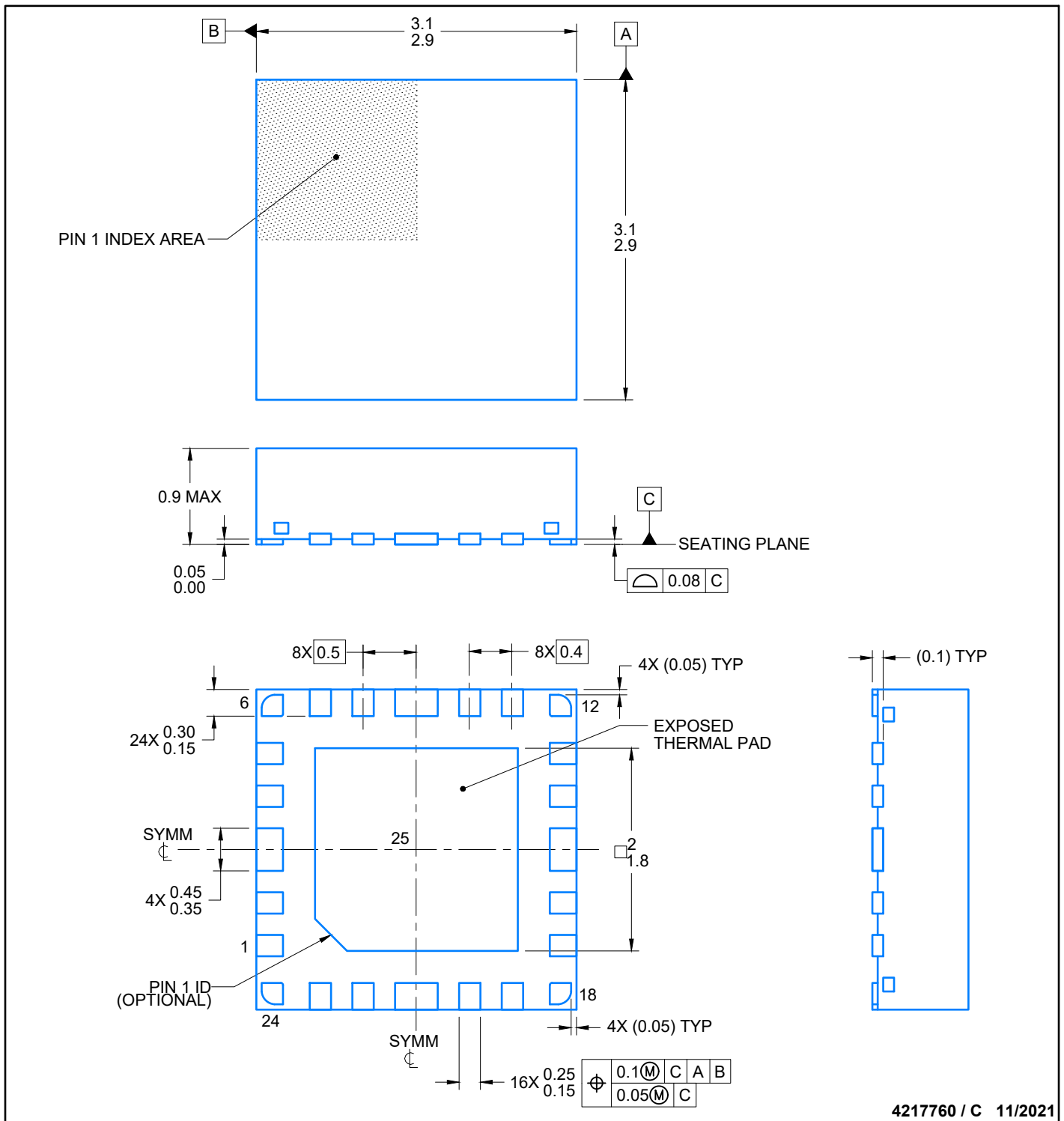

4217760 / C 11/2021

NOTES:

1. All linear dimensions are in millimeters. Any dimensions in parenthesis are for reference only. Dimensioning and tolerancing per ASME Y14.5M.
2. This drawing is subject to change without notice.
3. The package thermal pad must be soldered to the printed circuit board for thermal and mechanical performance.

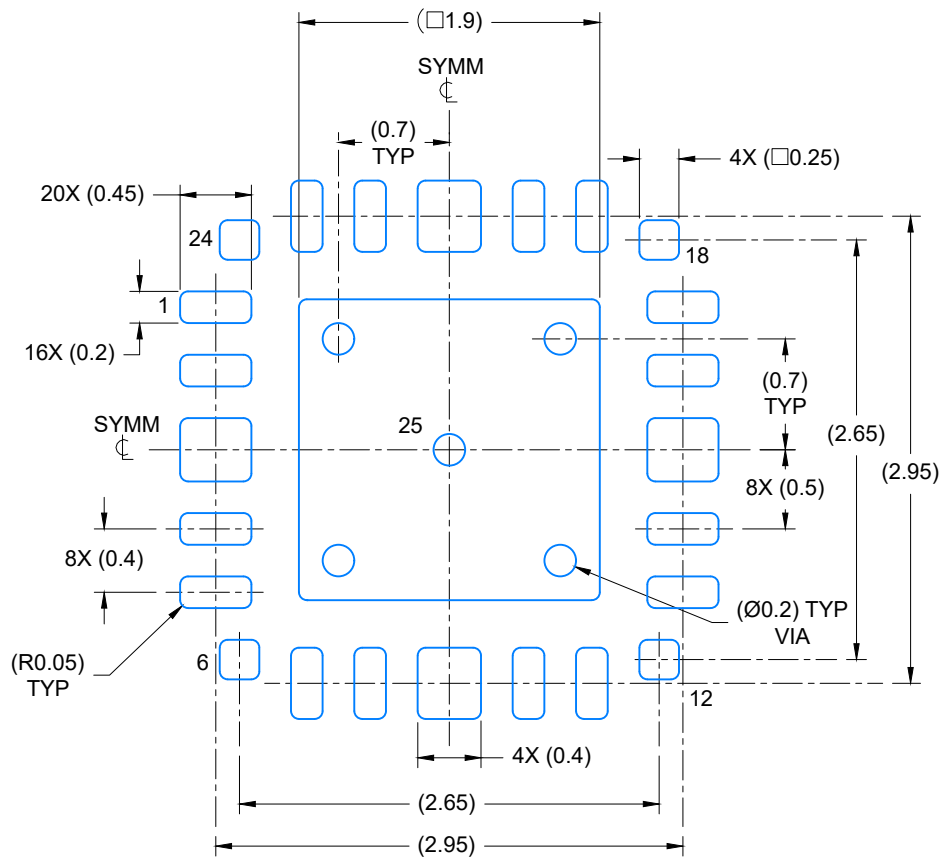

LAND PATTERN EXAMPLE
SCALE: 20X

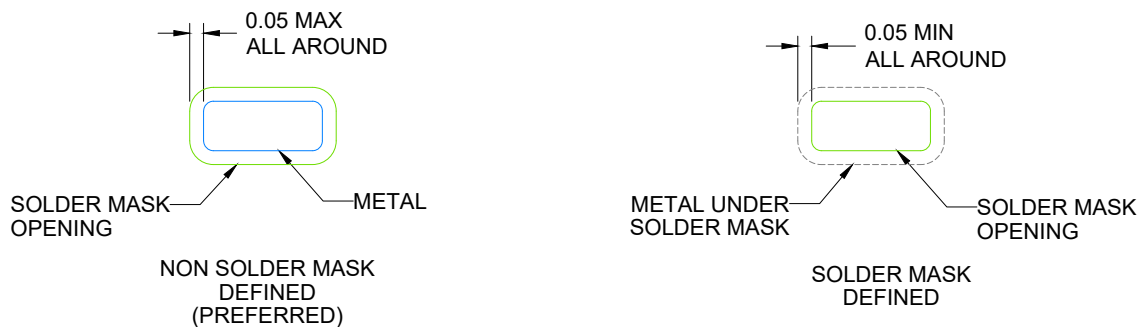

SOLDER MASK DETAILS

4217760 / C 10/2021

NOTES: (continued)

4. This package is designed to be soldered to a thermal pad on the board. For more information, see Texas Instruments literature number SLUA271 (www.ti.com/lit/slua271).
5. Vias are optional depending on application, refer to device data sheet. If any vias are implemented, refer to their locations shown on this view. It is recommended that vias under paste be filled, plugged or tented.

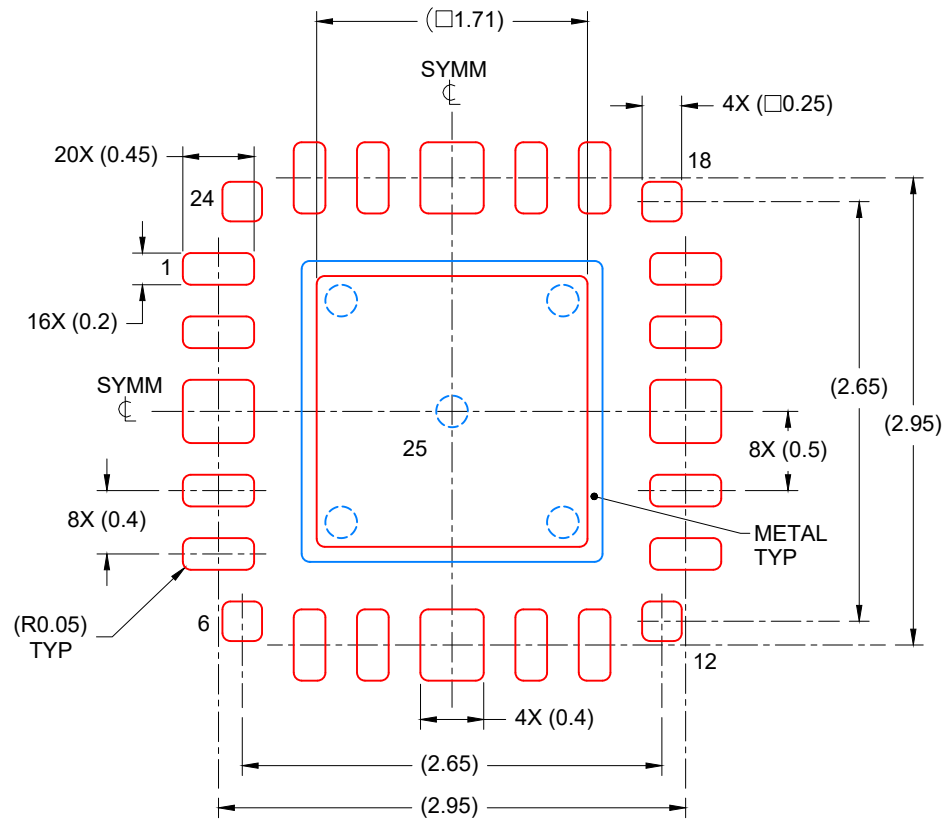

SOLDER PASTE EXAMPLE
 BASED ON 0.1 mm THICK STENCIL

EXPOSED PAD
 81% PRINTED COVERAGE BY AREA
 SCALE: 20X

4217760 / C 10/2021

NOTES: (continued)

6. Laser cutting apertures with trapezoidal walls and rounded corners may offer better paste release. IPC-7525 may have alternate design recommendations..

IMPORTANT NOTICE AND DISCLAIMER

TI PROVIDES TECHNICAL AND RELIABILITY DATA (INCLUDING DATA SHEETS), DESIGN RESOURCES (INCLUDING REFERENCE DESIGNS), APPLICATION OR OTHER DESIGN ADVICE, WEB TOOLS, SAFETY INFORMATION, AND OTHER RESOURCES "AS IS" AND WITH ALL FAULTS, AND DISCLAIMS ALL WARRANTIES, EXPRESS AND IMPLIED, INCLUDING WITHOUT LIMITATION ANY IMPLIED WARRANTIES OF MERCHANTABILITY, FITNESS FOR A PARTICULAR PURPOSE OR NON-INFRINGEMENT OF THIRD PARTY INTELLECTUAL PROPERTY RIGHTS.

These resources are intended for skilled developers designing with TI products. You are solely responsible for (1) selecting the appropriate TI products for your application, (2) designing, validating and testing your application, and (3) ensuring your application meets applicable standards, and any other safety, security, regulatory or other requirements.

These resources are subject to change without notice. TI grants you permission to use these resources only for development of an application that uses the TI products described in the resource. Other reproduction and display of these resources is prohibited. No license is granted to any other TI intellectual property right or to any third party intellectual property right. TI disclaims responsibility for, and you will fully indemnify TI and its representatives against, any claims, damages, costs, losses, and liabilities arising out of your use of these resources.

TI's products are provided subject to [TI's Terms of Sale](#) or other applicable terms available either on [ti.com](https://www.ti.com) or provided in conjunction with such TI products. TI's provision of these resources does not expand or otherwise alter TI's applicable warranties or warranty disclaimers for TI products.

TI objects to and rejects any additional or different terms you may have proposed.

Mailing Address: Texas Instruments, Post Office Box 655303, Dallas, Texas 75265
Copyright © 2023, Texas Instruments Incorporated