

SN74AHCT16245 16-Bit Bus Transceivers With 3-State Outputs

1 Features

- Members of Texas Instruments' Widebus™ Family
- Inputs are TTL-Voltage Compatible
- Distributed V_{CC} and GND Pins Minimize High-Speed Switching Noise
- Flow-Through Architecture Optimizes PCB Layout
- Latch-Up Performance Exceeds 250 mA Per JESD 17

2 Applications

- Telecom and Wireless Infrastructures
- Electronic Points of Sale
- Printers and Other Peripherals
- Motor Drives
- Health and Fitness

4 Simplified Schematic

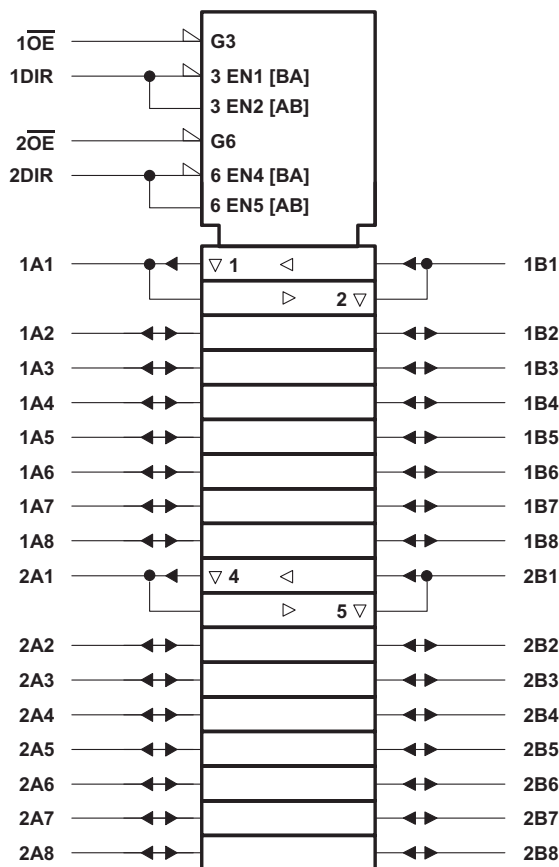

† This symbol is in accordance with ANSI/IEEE Std 91-1984 and IEC Publication 617-12.

3 Description

The SN74AHCT16245 device is a 16-bit (dual-octal) noninverting 3-state transceiver designed for synchronous two-way communication between data buses.

Device Information⁽¹⁾

PART NUMBER	PACKAGE	BODY SIZE (NOM)
SN74AHCT16245	TVSOP (48)	9.70 mm x 4.40 mm
	SSOP (48)	15.80 mm x 7.50 mm
	TSSOP (48)	12.50 mm x 6.10 mm

(1) For all available packages, see the orderable addendum at the end of the data sheet.



Table of Contents

1	Features	1	9	Detailed Description	9
2	Applications	1	9.1	Overview	9
3	Description	1	9.2	Functional Block Diagrams	9
4	Simplified Schematic	1	9.3	Feature Description	10
5	Revision History	2	9.4	Device Functional Modes	10
6	Pin Configuration and Functions	3	10	Application and Implementation	11
7	Specifications	5	10.1	Application Information	11
7.1	Absolute Maximum Ratings	5	10.2	Typical Application	11
7.2	Handling Ratings	5	11	Power Supply Recommendations	12
7.3	Recommended Operating Conditions	5	12	Layout	12
7.4	Thermal Information	6	12.1	Layout Guidelines	12
7.5	Electrical Characteristics	6	12.2	Layout Example	12
7.6	Switching Characteristics	7	13	Device and Documentation Support	13
7.7	Noise Characteristics	7	13.1	Trademarks	13
7.8	Operating Characteristics	7	13.2	Electrostatic Discharge Caution	13
7.9	Typical Characteristics	7	13.3	Glossary	13
8	Parameter Measurement Information	8	14	Mechanical, Packaging, and Orderable Information	13

5 Revision History

Changes from Revision J (October 2000) to Revision K

Page

• Updated document to new TI data sheet format	1
• Deleted Ordering Information table	1
• Deleted SN54AHCT16245 device from data sheet	1
• Added Applications	1
• Added Pin Functions table	3
• Added Handling Ratings table	5
• Changed MAX operating temperature to 125°C in Recommended Operating Conditions table	5
• Added Thermal Information table	6
• Added –40°C to 125°C range for SN74AHCT16245 in Electrical Characteristics table	6
• Added $T_A = -40^\circ\text{C}$ to 125°C for SN74AHCT16245 in the Switching Characteristics table	7
• Added Typical Characteristics	7
• Added Detailed Description section	9
• Added Application and Implementation section	11
• Added Power Supply Recommendations and Layout sections	12

6 Pin Configuration and Functions

SN74AHCT16245 . . . DGG, DGV, OR DL PACKAGE
(TOP VIEW)

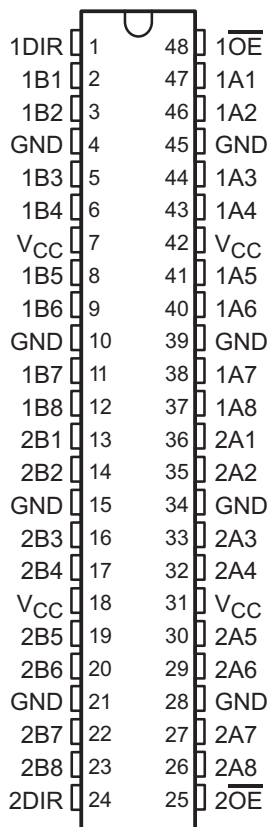

Pin Functions

PIN		I/O	DESCRIPTION
NO.	NAME		
1	1DIR	I	Direction pin 1
2	1B1	I/O	1B1 input or output
3	1B2	I/O	1B2 input or output
4	GND	—	Ground pin
5	1B3	I/O	1B3 input or output
6	1B4	I/O	1B4 input or output
7	V _{CC}	—	Power pin
8	1B5	I/O	1B5 input or output
9	1B6	I/O	1B6 input or output
10	GND	—	Ground pin
11	1B7	I/O	1B7 input or output
12	1B8	I/O	1B8 input or output
13	2B1	I/O	2B1 input or output
14	2B2	I/O	2B2 input or output
15	GND	—	Ground pin
16	2B3	I/O	2B3 input or output
17	2B4	I/O	2B4 input or output
18	V _{CC}	—	Power pin

Pin Functions (continued)

PIN		I/O	DESCRIPTION
NO.	NAME		
19	2B5	I/O	2B5 input or output
20	2B6	I/O	2B6 input or output
21	GND	—	Ground pin
22	2B7	I/O	2B7 input or output
23	2B8	I/O	2B8 input or output
24	2DIR	—	Direction pin 2
25	$\overline{2OE}$	I	Output Enable 2
26	2A8	I/O	2A8 input or output
27	2A7	I/O	2A7 input or output
28	GND	—	Ground pin
29	2A6	I/O	2A6 input or output
30	2A5	I/O	2A5 input or output
31	V _{CC}	—	Power pin
32	2A4	I/O	2A4 input or output
33	2A3	I/O	2A3 input or output
34	GND	—	Ground pin
35	2A2	I/O	2A2 input or output
36	2A1	I/O	2A1 input or output
37	1A8	I/O	1A8 input or output
38	1A7	I/O	1A7 input or output
39	GND	—	Ground pin
40	1A6	I/O	1A6 input or output
41	1A5	I/O	1A5 input or output
42	V _{CC}	—	Power pin
43	1A4	I/O	1A4 input or output
44	1A3	I/O	1A3 input or output
45	GND	—	Ground pin
46	1A2	I/O	1A2 input or output
47	1A1	I/O	1A1 input or output
48	$\overline{1OE}$	I	Output Enable 1

7 Specifications

7.1 Absolute Maximum Ratings

over operating free-air temperature range (unless otherwise noted)⁽¹⁾

				MIN	MAX	UNIT
V_{CC}	Supply voltage range			-0.5	7	V
V_I	Control Inputs	Input voltage range ⁽²⁾		-0.5	7	V
V_O	I/O	Output voltage range ⁽²⁾		-0.5	$V_{CC} + 0.5$	V
I_{IK}	Control Inputs	Input clamp current	$V_I < 0$		-20	mA
I_{OK}	I/O	Output clamp current	$V_O < 0$ or $V_O > V_{CC}$		±20	mA
I_O	Continuous output current		$V_O = 0$ to V_{CC}		±25	mA
Continuous current through V_{CC} or GND					±75	mA

- (1) Stresses beyond those listed under *Absolute Maximum Ratings* may cause permanent damage to the device. These are stress ratings only, which do not imply functional operation of the device at these or any other conditions beyond those indicated under *Recommended Operating Conditions*. Exposure to absolute-maximum-rated conditions for extended periods may affect device reliability.
- (2) The input and output voltage ratings may be exceeded if the input and output current ratings are observed.

7.2 Handling Ratings

				MIN	MAX	UNIT
T_{stg}	Storage temperature range			-65	150	°C
$V_{(ESD)}$	Electrostatic discharge	Human body model (HBM), per ANSI/ESDA/JEDEC JS-001, all pins ⁽¹⁾		0	1500	V
		Charged device model (CDM), per JEDEC specification JESD22-C101, all pins ⁽²⁾		0	2000	

- (1) JEDEC document JEP155 states that 500-V HBM allows safe manufacturing with a standard ESD control process.
- (2) JEDEC document JEP157 states that 250-V CDM allows safe manufacturing with a standard ESD control process.

7.3 Recommended Operating Conditions

over operating free-air temperature range (unless otherwise noted)⁽¹⁾

				SN74AHCT16245		UNIT
				MIN	MAX	
V_{CC}	Supply voltage			4.5	5.5	V
V_{IH}	High-level input voltage			2		V
V_{IL}	Low-level input voltage				0.8	V
V_I	Input voltage			0	5.5	V
V_{IO}	Input/Output voltage, A or B pins			0	V_{CC}	V
I_{OH}	High-level output current				-8	mA
I_{OL}	Low-level output current				8	mA
$\Delta t/\Delta v$	Input transition rise or fall rate				20	ns/V
T_A	Operating free-air temperature			-40	125	°C

- (1) All unused inputs of the device must be held at V_{CC} or GND to ensure proper device operation. Refer to the TI Application Report, *Implications of Slow or Floating CMOS Inputs (SCBA004)*.

7.4 Thermal Information

THERMAL METRIC ⁽¹⁾		SN74AHCT16245			UNIT
		DGG	DGV	DL	
		48 PINS			
R _{θJA}	Junction-to-ambient thermal resistance	68.1	79.3	61.0	°C/W
R _{θJC(top)}	Junction-to-case (top) thermal resistance	22.6	31.3	30.8	
R _{θJB}	Junction-to-board thermal resistance	35.0	42.3	32.8	
ψ _{JT}	Junction-to-top characterization parameter	1.3	2.4	8.4	
ψ _{JB}	Junction-to-board characterization parameter	34.7	41.8	32.5	
R _{θJC(bot)}	Junction-to-case (bottom) thermal resistance	n/a	n/a	n/a	

(1) For more information about traditional and new thermal metrics, see the *IC Package Thermal Metrics* application report ([SPRA953](#)).

7.5 Electrical Characteristics

over recommended operating free-air temperature range (unless otherwise noted)

PARAMETER	TEST CONDITIONS	V _{CC}	T _A = 25°C			SN74AHCT16245		–40°C to 125°C SN74AHCT16245		UNIT
			MIN	TYP	MAX	MIN	MAX	MIN	MAX	
V _{OH}	I _{OH} = –50 μA	4.5 V	4.4	4.5		4.4		4.4	V	
	I _{OH} = –8 mA		3.94			3.8		3.8		
V _{OL}	I _{OL} = 50 μA	4.5 V			0.1			0.1	V	
	I _{OL} = 8 mA				0.36			0.44		
I _I	$\overline{\text{OE}}$ or DIR	V _I = V _{CC} or GND			±0.1			±1	μA	
I _{OZ} ⁽¹⁾	A or B Inputs	V _O = V _{CC} or GND			±0.25			±2.5	μA	
I _{CC}		V _I = V _{CC} or GND, I _O = 0			4			40	μA	
ΔI _{CC} ⁽²⁾		One input at 3.4 V, Other inputs at V _{CC} or GND			1.35			1.5	mA	
C _i	$\overline{\text{OE}}$ or DIR	V _I = V _{CC} or GND		2.5	10			10	pF	
C _{io}	A or B Inputs			4					pF	

(1) For I/O ports, the parameter I_{OZ} includes the input leakage current.

(2) This is the increase in supply current for each input at one of the specified TTL voltage levels, rather than 0 V or V_{CC}.

7.6 Switching Characteristics

over recommended operating free-air temperature range, $V_{CC} = 5 V \pm 0.5 V$ (unless otherwise noted) (see Figure 2)

PARAMETER	FROM (INPUT)	TO (OUTPUT)	LOAD CAPACITANCE	$T_A = 25^\circ C$		SN74AHCT16245		$T_A = -40^\circ C$ to $125^\circ C$ SN74AHCT16245		UNIT
				TYP	MAX	MIN	MAX	MIN	MAX	
t_{PLH}	A or B	B or A	$C_L = 15\text{ pF}$	4.5 ⁽¹⁾	8.5 ⁽¹⁾	1	9.5	1	11	ns
t_{PHL}				4.5 ⁽¹⁾	8.5 ⁽¹⁾	1	9.5	1	11	
t_{PZH}	\overline{OE}	A or B	$C_L = 15\text{ pF}$	8.9 ⁽¹⁾	13 ⁽¹⁾	1	14	1	15	ns
t_{PZL}				8.9 ⁽¹⁾	13 ⁽¹⁾	1	14	1	15	
t_{PHZ}	\overline{OE}	A or B	$C_L = 15\text{ pF}$	9.2 ⁽¹⁾	14 ⁽¹⁾	1	15	1	15.7	ns
t_{PLZ}				9.2 ⁽¹⁾	14 ⁽¹⁾	1	15	1	15.7	
t_{PLH}	A or B	B or A	$C_L = 50\text{ pF}$	7	9.5	1	10.5	1	12	ns
t_{PHL}				5.3	9.5	1	10.5	1	12	
t_{PZH}	\overline{OE}	A or B	$C_L = 50\text{ pF}$	8.3	14	1	15	1	16	ns
t_{PZL}				8.3	14	1	15	1	16	
t_{PHZ}	\overline{OE}	A or B	$C_L = 50\text{ pF}$	8	14	1	15	1	15.7	ns
t_{PLZ}				8	14	1	15	1	15.7	
$t_{sk(o)}$			$C_L = 50\text{ pF}$		1 ⁽²⁾		1		1	ns

- (1) On products compliant to MIL-PRF-38535, this parameter is not production tested.
- (2) On products compliant to MIL-PRF-38535, this parameter does not apply.

7.7 Noise Characteristics

$V_{CC} = 5 V$, $C_L = 50\text{ pF}$, $T_A = 25^\circ C$ ⁽¹⁾

PARAMETER	DESCRIPTION	SN74AHCT16245			UNIT
		MIN	TYP	MAX	
$V_{OL(P)}$	Quiet output, maximum dynamic V_{OL}		0.6	0.8	V
$V_{OL(V)}$	Quiet output, minimum dynamic V_{OL}		-0.6	-0.8	V
$V_{OH(V)}$	Quiet output, minimum dynamic V_{OH}		4.8		V
$V_{IH(D)}$	High-level dynamic input voltage	2			V
$V_{IL(D)}$	Low-level dynamic input voltage			0.8	V

- (1) Characteristics are for surface-mount packages only.

7.8 Operating Characteristics

$V_{CC} = 5 V$, $T_A = 25^\circ C$

PARAMETER	TEST CONDITIONS	TYP	UNIT
C_{pd}	No load, $f = 1\text{ MHz}$	17	pF

7.9 Typical Characteristics

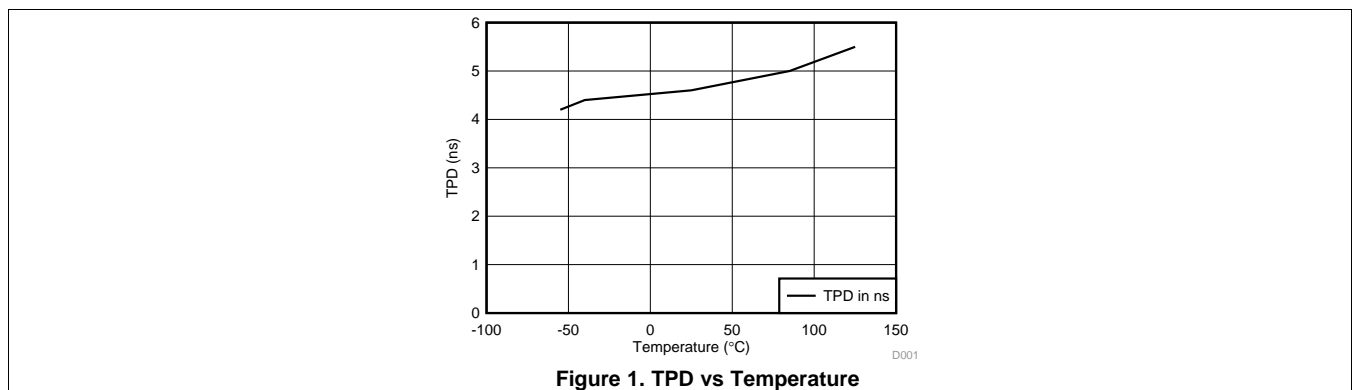
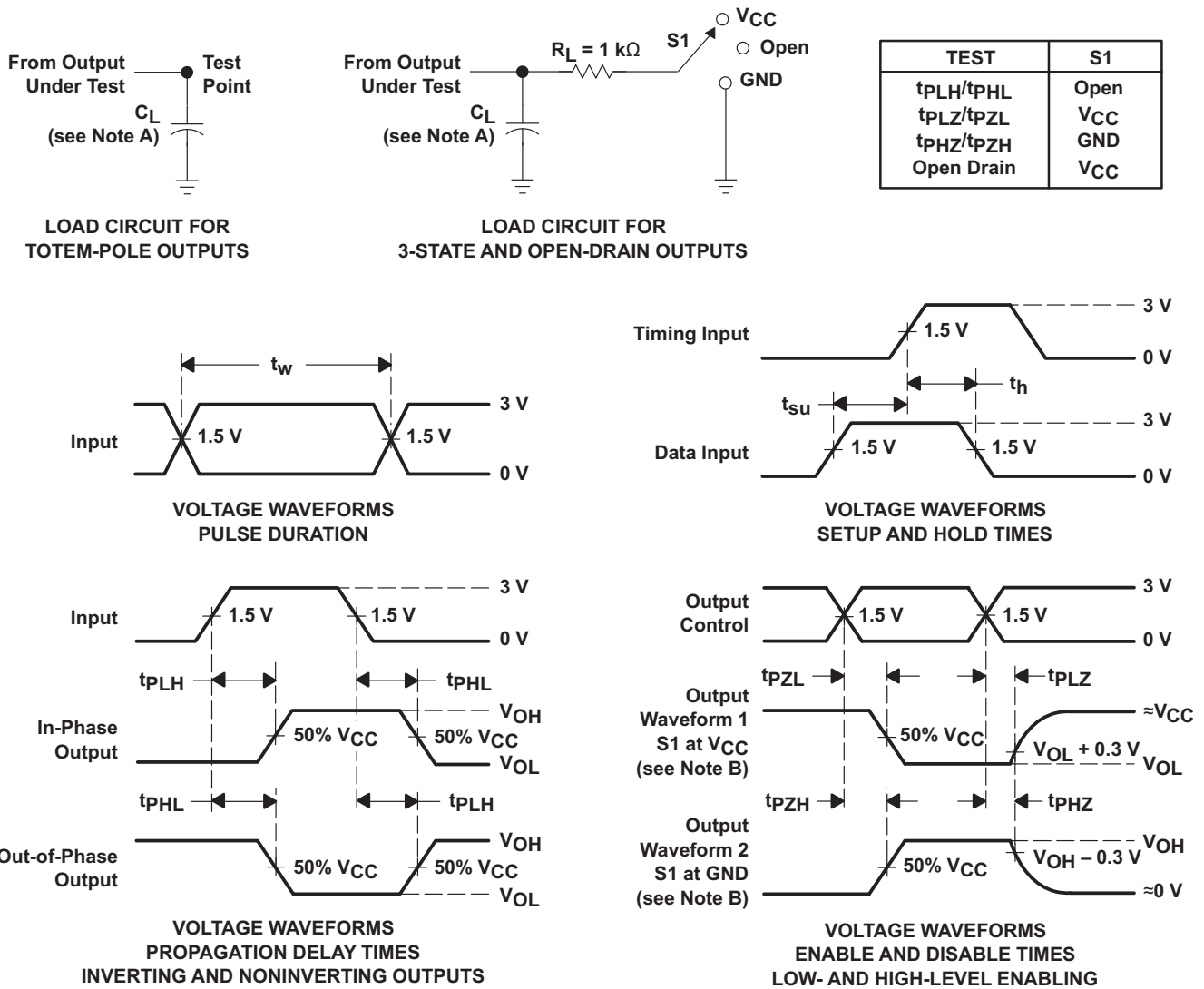

Figure 1. TPD vs Temperature

8 Parameter Measurement Information



- NOTES: A. C_L includes probe and jig capacitance.
 B. Waveform 1 is for an output with internal conditions such that the output is low except when disabled by the output control. Waveform 2 is for an output with internal conditions such that the output is high except when disabled by the output control.
 C. All input pulses are supplied by generators having the following characteristics: PRR $\leq 1\text{ MHz}$, $Z_O = 50\ \Omega$, $t_r \leq 3\text{ ns}$, $t_f \leq 3\text{ ns}$.
 D. The outputs are measured one at a time with one input transition per measurement.

Figure 2. Load Circuit and Voltage Waveforms

9 Detailed Description

9.1 Overview

The SN74AHCT16245 device is a 16-bit (dual-octal) noninverting 3-state transceiver designed for synchronous two-way communication between data buses. The control-function implementation minimizes external timing requirements.

This device can be used as two 8-bit transceivers or one 16-bit transceiver. It allows data transmission from the A bus to the B bus or from the B bus to the A bus, depending on the logic level at the direction-control (DIR) input. The output-enable (\overline{OE}) input can be used to disable the device so that the buses are effectively isolated.

To ensure the high-impedance state during power up or power down, \overline{OE} should be tied to V_{CC} through a pullup resistor; the minimum value of the resistor is determined by the current-sinking capability of the driver.

9.2 Functional Block Diagrams

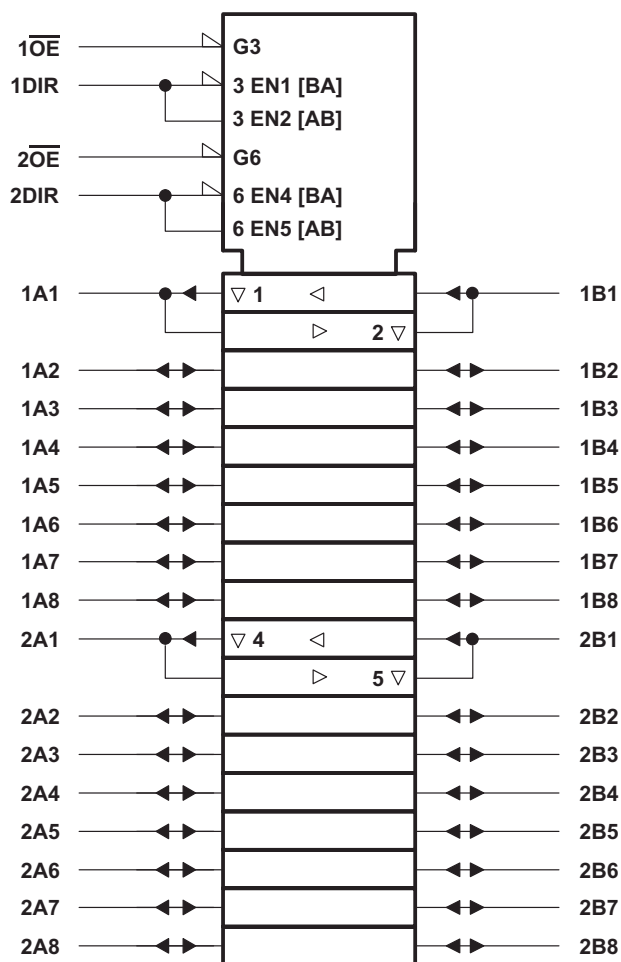

A. † This symbol is in accordance with ANSI/IEEE Std 91-1984 and IEC Publication 617-12.

Figure 3. Logic Symbol

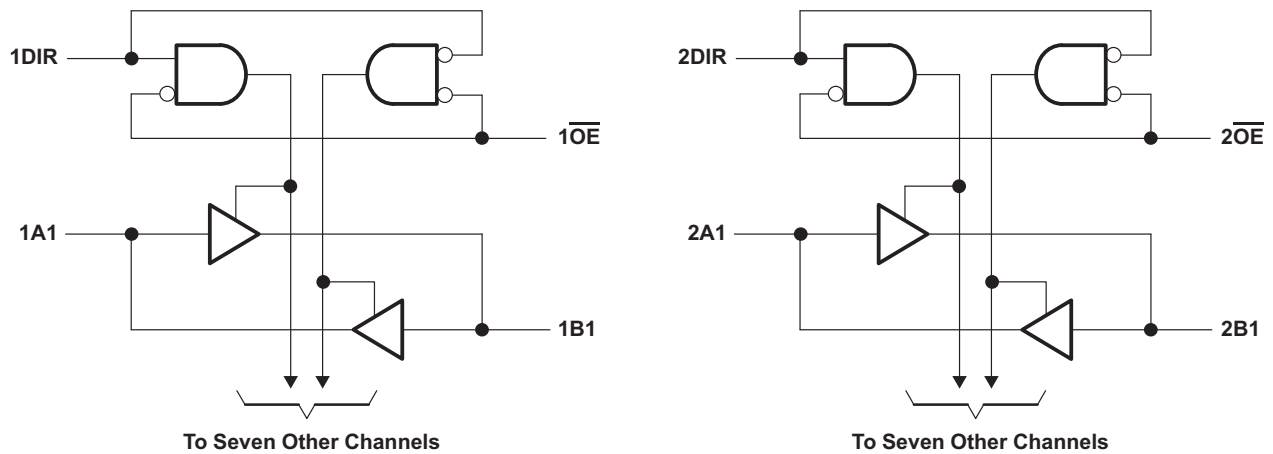
Functional Block Diagrams (continued)

Figure 4. Logic Diagram (Positive Logic)
9.3 Feature Description

- TTL inputs
 - Lowered switching threshold allows up translation 3.3 V to 5 V
- Slow edges reduce output ringing

9.4 Device Functional Modes
**Table 1. Function Table
(Each 8-bit Transceiver)**

INPUTS		OPERATION
\overline{OE}	DIR	
L	L	B data to A bus
L	H	A data to B bus
H	X	Isolation

10 Application and Implementation

10.1 Application Information

The SN74AHCT16245 is a low-drive CMOS device that can be used for a multitude of bus interface type applications where output ringing is a concern. The low drive and slow edge rates will minimize overshoot and undershoot on the outputs. The input switching levels have been lowered to accommodate TTL inputs of 0.8-V V_{IL} and 2-V V_{IH} . This feature makes the device ideal for translating up from 3.3 V to 5 V. Figure 6 shows this type of translation.

10.2 Typical Application

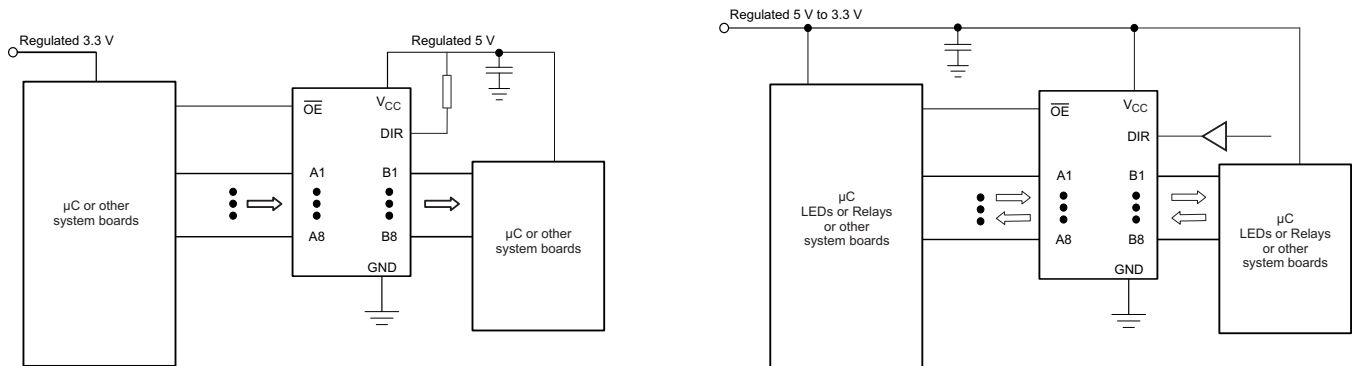

Figure 5. Typical Application Diagram

10.2.1 Design Requirements

This device uses CMOS technology and has balanced output drive. Care should be taken to avoid bus contention because it can drive currents that would exceed maximum limits. The high drive will also create fast edges into light loads; therefore, routing and load conditions should be considered to prevent ringing.

10.2.2 Detailed Design Procedure

1. Recommended Input Conditions:
 - For rise time and fall time specifications, see $\Delta t/\Delta V$ in the [Recommended Operating Conditions](#) table.
 - For specified high and low levels, see V_{IH} and V_{IL} in the [Recommended Operating Conditions](#) table.
 - Inputs are overvoltage tolerant allowing them to go as high as 5.5 V at any valid V_{CC} .
2. Recommend Output Conditions:
 - Load currents should not exceed 25 mA per output and 75 mA total for the part.
 - Outputs should not be pulled above V_{CC} .

Typical Application (continued)

10.2.3 Application Curves

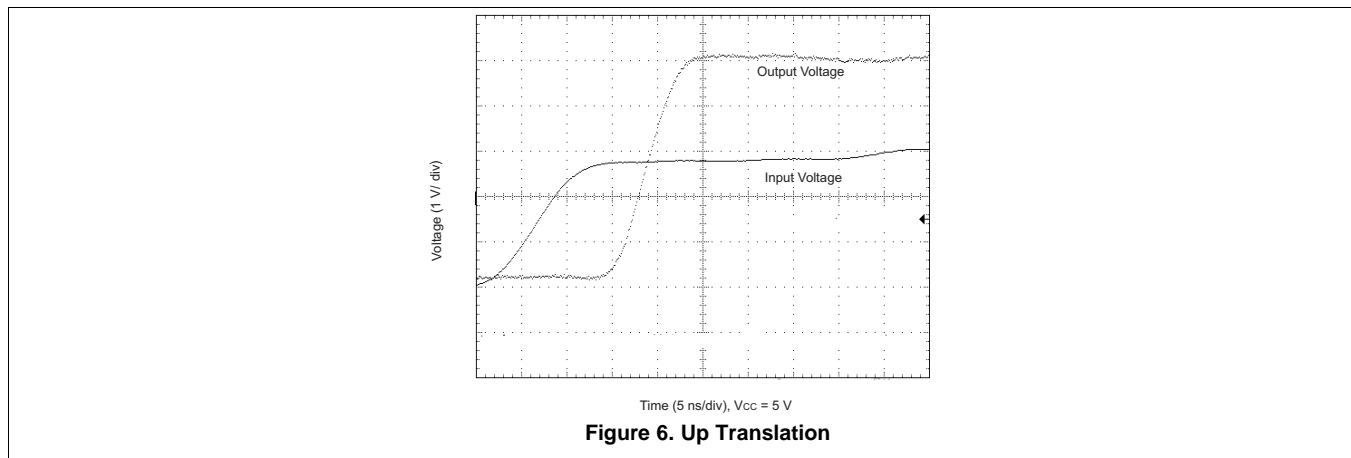

11 Power Supply Recommendations

The power supply can be any voltage between the MIN and MAX supply voltage rating located in the [Recommended Operating Conditions](#) table.

Each V_{CC} pin should have a good bypass capacitor to prevent power disturbance. For devices with a single supply, 0.1 μF is recommended and if there are multiple V_{CC} pins than 0.01 μF or 0.022 μF is recommended for each power pin. It is acceptable to parallel multiple bypass caps to reject different frequencies of noise. A 0.1 μF and 1 μF are commonly used in parallel. The bypass capacitor should be installed as close to the power pin as possible for best results.

12 Layout

12.1 Layout Guidelines

When using multiple bit logic devices, inputs should not float. In many cases, functions or parts of functions of digital logic devices are unused. Some examples are when only two inputs of a triple-input AND gate are used, or when only 3 of the 4-buffer gates are used. Such input pins should not be left unconnected because the undefined voltages at the outside connections result in undefined operational states.

Specified in [Figure 7](#) are rules that must be observed under all circumstances. All unused inputs of digital logic devices must be connected to a high or low bias to prevent them from floating. The logic level that should be applied to any particular unused input depends on the function of the device. Generally they will be tied to GND or V_{CC} , whichever makes more sense or is more convenient. It is acceptable to float outputs unless the part is a transceiver.

12.2 Layout Example

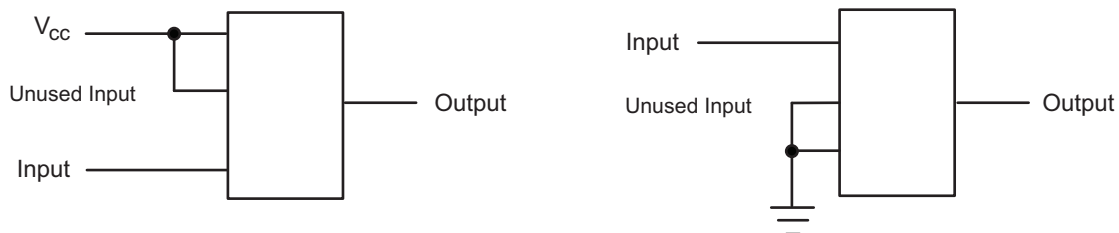

Figure 7. Layout Diagram

13 Device and Documentation Support

13.1 Trademarks

Widebus is a trademark of Texas Instruments.
All other trademarks are the property of their respective owners.

13.2 Electrostatic Discharge Caution



These devices have limited built-in ESD protection. The leads should be shorted together or the device placed in conductive foam during storage or handling to prevent electrostatic damage to the MOS gates.

13.3 Glossary

[SLYZ022](#) — *TI Glossary*.

This glossary lists and explains terms, acronyms, and definitions.

14 Mechanical, Packaging, and Orderable Information

The following pages include mechanical, packaging, and orderable information. This information is the most current data available for the designated devices. This data is subject to change without notice and revision of this document. For browser-based versions of this data sheet, refer to the left-hand navigation.

PACKAGING INFORMATION

Orderable Device	Status (1)	Package Type	Package Drawing	Pins	Package Qty	Eco Plan (2)	Lead finish/ Ball material (6)	MSL Peak Temp (3)	Op Temp (°C)	Device Marking (4/5)	Samples
74AHCT16245DGGRG4	ACTIVE	TSSOP	DGG	48	2000	RoHS & Green	NIPDAU	Level-1-260C-UNLIM	-40 to 125	AHCT16245	Samples
74AHCT16245DLRG4	ACTIVE	SSOP	DL	48	1000	RoHS & Green	NIPDAU	Level-1-260C-UNLIM	-40 to 125	AHCT16245	Samples
SN74AHCT16245DGGR	ACTIVE	TSSOP	DGG	48	2000	RoHS & Green	NIPDAU	Level-1-260C-UNLIM	-40 to 125	AHCT16245	Samples
SN74AHCT16245DGVR	ACTIVE	TVSOP	DGV	48	2000	RoHS & Green	NIPDAU	Level-1-260C-UNLIM	-40 to 125	HF245	Samples
SN74AHCT16245DLR	ACTIVE	SSOP	DL	48	1000	RoHS & Green	NIPDAU	Level-1-260C-UNLIM	-40 to 125	AHCT16245	Samples

(1) The marketing status values are defined as follows:

ACTIVE: Product device recommended for new designs.

LIFEBUY: TI has announced that the device will be discontinued, and a lifetime-buy period is in effect.

NRND: Not recommended for new designs. Device is in production to support existing customers, but TI does not recommend using this part in a new design.

PREVIEW: Device has been announced but is not in production. Samples may or may not be available.

OBSELETE: TI has discontinued the production of the device.

(2) **RoHS:** TI defines "RoHS" to mean semiconductor products that are compliant with the current EU RoHS requirements for all 10 RoHS substances, including the requirement that RoHS substance do not exceed 0.1% by weight in homogeneous materials. Where designed to be soldered at high temperatures, "RoHS" products are suitable for use in specified lead-free processes. TI may reference these types of products as "Pb-Free".

RoHS Exempt: TI defines "RoHS Exempt" to mean products that contain lead but are compliant with EU RoHS pursuant to a specific EU RoHS exemption.

Green: TI defines "Green" to mean the content of Chlorine (Cl) and Bromine (Br) based flame retardants meet JS709B low halogen requirements of <=1000ppm threshold. Antimony trioxide based flame retardants must also meet the <=1000ppm threshold requirement.

(3) MSL, Peak Temp. - The Moisture Sensitivity Level rating according to the JEDEC industry standard classifications, and peak solder temperature.

(4) There may be additional marking, which relates to the logo, the lot trace code information, or the environmental category on the device.

(5) Multiple Device Markings will be inside parentheses. Only one Device Marking contained in parentheses and separated by a "~" will appear on a device. If a line is indented then it is a continuation of the previous line and the two combined represent the entire Device Marking for that device.

(6) Lead finish/Ball material - Orderable Devices may have multiple material finish options. Finish options are separated by a vertical ruled line. Lead finish/Ball material values may wrap to two lines if the finish value exceeds the maximum column width.

Important Information and Disclaimer: The information provided on this page represents TI's knowledge and belief as of the date that it is provided. TI bases its knowledge and belief on information provided by third parties, and makes no representation or warranty as to the accuracy of such information. Efforts are underway to better integrate information from third parties. TI has taken and continues to take reasonable steps to provide representative and accurate information but may not have conducted destructive testing or chemical analysis on incoming materials and chemicals. TI and TI suppliers consider certain information to be proprietary, and thus CAS numbers and other limited information may not be available for release.

In no event shall TI's liability arising out of such information exceed the total purchase price of the TI part(s) at issue in this document sold by TI to Customer on an annual basis.

TAPE AND REEL INFORMATION

QUADRANT ASSIGNMENTS FOR PIN 1 ORIENTATION IN TAPE

*All dimensions are nominal

Device	Package Type	Package Drawing	Pins	SPQ	Reel Diameter (mm)	Reel Width W1 (mm)	A0 (mm)	B0 (mm)	K0 (mm)	P1 (mm)	W (mm)	Pin1 Quadrant
SN74AHCT16245DGGR	TSSOP	DGG	48	2000	330.0	24.4	8.6	13.0	1.8	12.0	24.0	Q1
SN74AHCT16245DGVR	TVSOP	DGV	48	2000	330.0	16.4	7.1	10.2	1.6	12.0	16.0	Q1
SN74AHCT16245DLR	SSOP	DL	48	1000	330.0	32.4	11.35	16.2	3.1	16.0	32.0	Q1

TAPE AND REEL BOX DIMENSIONS



*All dimensions are nominal

Device	Package Type	Package Drawing	Pins	SPQ	Length (mm)	Width (mm)	Height (mm)
SN74AHCT16245DGGR	TSSOP	DGG	48	2000	367.0	367.0	45.0
SN74AHCT16245DGVR	TVSOP	DGV	48	2000	356.0	356.0	35.0
SN74AHCT16245DLR	SSOP	DL	48	1000	367.0	367.0	55.0

DGV (R-PDSO-G**)

PLASTIC SMALL-OUTLINE

24 PINS SHOWN



4073251/E 08/00

- NOTES: A. All linear dimensions are in millimeters.
 B. This drawing is subject to change without notice.
 C. Body dimensions do not include mold flash or protrusion, not to exceed 0,15 per side.
 D. Falls within JEDEC: 24/48 Pins – MO-153
 14/16/20/56 Pins – MO-194

EXAMPLE BOARD LAYOUT

DGG0048A

TSSOP - 1.2 mm max height

SMALL OUTLINE PACKAGE

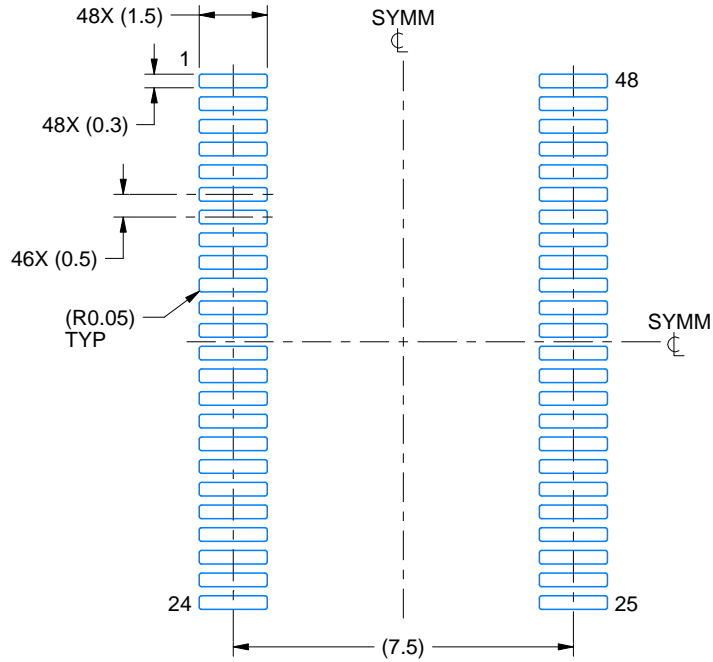

LAND PATTERN EXAMPLE
SCALE:6X



SOLDER MASK DETAILS

4214859/B 11/2020

NOTES: (continued)

5. Publication IPC-7351 may have alternate designs.
6. Solder mask tolerances between and around signal pads can vary based on board fabrication site.

EXAMPLE STENCIL DESIGN

DGG0048A

TSSOP - 1.2 mm max height

SMALL OUTLINE PACKAGE

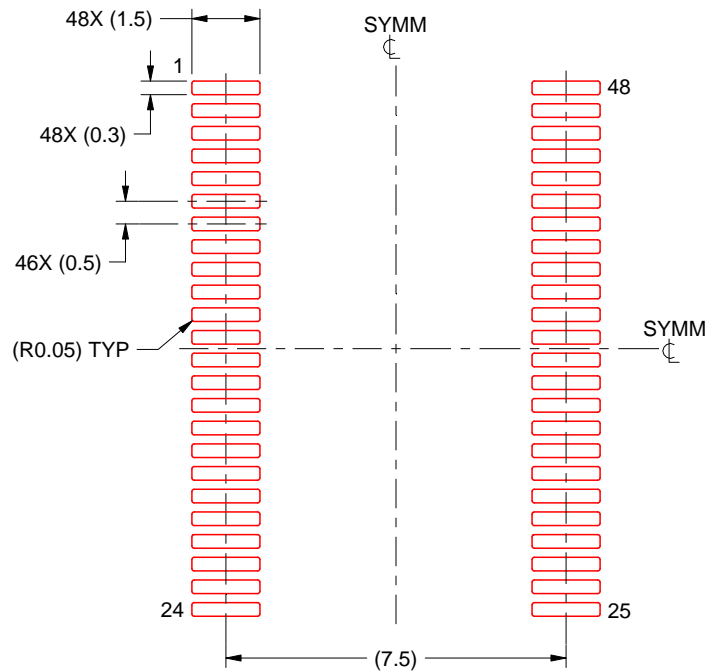

SOLDER PASTE EXAMPLE
BASED ON 0.125 mm THICK STENCIL
SCALE:6X

4214859/B 11/2020

NOTES: (continued)

7. Laser cutting apertures with trapezoidal walls and rounded corners may offer better paste release. IPC-7525 may have alternate design recommendations.
8. Board assembly site may have different recommendations for stencil design.

DGG (R-PDSO-G**)

PLASTIC SMALL-OUTLINE PACKAGE

48 PINS SHOWN



- NOTES: A. All linear dimensions are in millimeters.
 B. This drawing is subject to change without notice.
 C. Body dimensions do not include mold protrusion not to exceed 0,15.
 D. Falls within JEDEC MO-153

IMPORTANT NOTICE AND DISCLAIMER

TI PROVIDES TECHNICAL AND RELIABILITY DATA (INCLUDING DATA SHEETS), DESIGN RESOURCES (INCLUDING REFERENCE DESIGNS), APPLICATION OR OTHER DESIGN ADVICE, WEB TOOLS, SAFETY INFORMATION, AND OTHER RESOURCES "AS IS" AND WITH ALL FAULTS, AND DISCLAIMS ALL WARRANTIES, EXPRESS AND IMPLIED, INCLUDING WITHOUT LIMITATION ANY IMPLIED WARRANTIES OF MERCHANTABILITY, FITNESS FOR A PARTICULAR PURPOSE OR NON-INFRINGEMENT OF THIRD PARTY INTELLECTUAL PROPERTY RIGHTS.

These resources are intended for skilled developers designing with TI products. You are solely responsible for (1) selecting the appropriate TI products for your application, (2) designing, validating and testing your application, and (3) ensuring your application meets applicable standards, and any other safety, security, regulatory or other requirements.

These resources are subject to change without notice. TI grants you permission to use these resources only for development of an application that uses the TI products described in the resource. Other reproduction and display of these resources is prohibited. No license is granted to any other TI intellectual property right or to any third party intellectual property right. TI disclaims responsibility for, and you will fully indemnify TI and its representatives against, any claims, damages, costs, losses, and liabilities arising out of your use of these resources.

TI's products are provided subject to [TI's Terms of Sale](#) or other applicable terms available either on [ti.com](https://www.ti.com) or provided in conjunction with such TI products. TI's provision of these resources does not expand or otherwise alter TI's applicable warranties or warranty disclaimers for TI products.

TI objects to and rejects any additional or different terms you may have proposed.

Mailing Address: Texas Instruments, Post Office Box 655303, Dallas, Texas 75265
Copyright © 2024, Texas Instruments Incorporated