

# TMAG5231 Low-Power, Hall Effect Switch

## 1 Features

- Low power consumption:
  - 10-Hz versions: 1.3  $\mu\text{A}$  at 3 V
  - 20-Hz versions: 2  $\mu\text{A}$  at 3 V
  - 216-Hz versions: 16  $\mu\text{A}$  at 3 V
- 1.65-V to 5.5-V operating  $V_{\text{CC}}$  range
- Magnetic threshold option (typical  $B_{\text{OP}}$ ):
  - 1.8 mT with 0.6-mT hysteresis
  - 2.85 mT with 1.35-mT hysteresis
  - 3 mT with 0.8-mT hysteresis
  - 40 mT with 6.5-mT hysteresis
- Omnipolar response
- Push-pull output
- Industry-standard package and pinout
  - SOT-23 package
  - X2SON package
- Operating temperature range:  $-40^{\circ}\text{C}$  to  $+125^{\circ}\text{C}$

## 2 Applications

- [Cell phones, laptops, or tablet case sensing](#)
- [Electricity meter tamper detection](#)
- [E-locks](#)
- [Smoke detectors](#)
- [Home appliance open/close detection](#)
- [Medical devices](#)
- [IoT systems](#)
- Valve and solenoid position detection
- Contactless diagnostics or activation

## 3 Description

The TMAG5231 is a 2nd-generation, low-power Hall-effect switch sensor, specifically designed to optimize the total system cost for compact, battery-operated consumer and industrial applications.

When the applied magnetic flux density exceeds the operating point ( $B_{\text{OP}}$ ) threshold, the device outputs a low voltage. The output stays low until the flux density decreases to less than the release point ( $B_{\text{RP}}$ ), and then the device outputs a high voltage. Omnipolar magnetic response allows the output to be sensitive to both north and south magnetic fields.

The TMAG5231 is able to operate at very low current consumption. To achieve 2  $\mu\text{A}$  of current consumption the device is internally power cycled at a 20-Hz rate.

The TMAG5231 is available in the industry-standard package and pinout SOT-23 as well as X2SON.

The device operates at a  $V_{\text{CC}}$  range of 1.65 V to 5.5 V as well as an extended temperature range of  $-40^{\circ}\text{C}$  to  $125^{\circ}\text{C}$ .

### Package Information<sup>(1)</sup>

PART NUMBER	PACKAGE	BODY SIZE (NOM)
TMAG5231	SOT-23 (3)	2.92 mm × 1.30 mm
	X2SON (4)	1.10 mm × 1.40 mm

- (1) For all available packages, see the orderable addendum at the end of the data sheet.

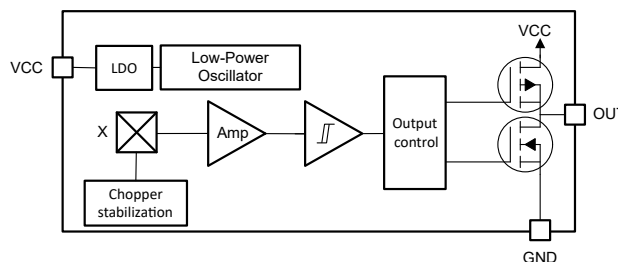

**Block Diagram**



## Table of Contents

<b>1 Features</b> .....	1	8.1 Overview.....	8
<b>2 Applications</b> .....	1	8.2 Functional Block Diagram.....	8
<b>3 Description</b> .....	1	8.3 Feature Description.....	8
<b>4 Revision History</b> .....	2	8.4 Device Functional Modes.....	11
<b>5 Device Comparison</b> .....	3	<b>9 Application and Implementation</b> .....	12
<b>6 Pin Configuration and Functions</b> .....	3	9.1 Application Information.....	12
<b>7 Specifications</b> .....	4	9.2 Typical Applications.....	14
7.1 Absolute Maximum Ratings.....	4	9.3 Power Supply Recommendations.....	19
7.2 ESD Ratings.....	4	9.4 Layout.....	19
7.3 Recommended Operating Conditions.....	4	<b>10 Device and Documentation Support</b> .....	21
7.4 Thermal Information.....	4	10.1 Support Resources.....	21
7.5 Electrical Characteristics.....	5	10.2 Trademarks.....	21
7.6 Magnetic Characteristics.....	5	10.3 Electrostatic Discharge Caution.....	21
7.7 Typical Characteristics.....	6	10.4 Glossary.....	21
<b>8 Detailed Description</b> .....	8	<b>11 Mechanical and Packaging Information</b> .....	21

## 4 Revision History

NOTE: Page numbers for previous revisions may differ from page numbers in the current version.

Changes from Revision C (June 2022) to Revision D (September 2022)	Page
• Changed <i>Device Information</i> table to <i>Package Information</i> .....	1
• Changed the package information in <i>Device Comparison</i> table.....	3
• Moved the <i>Power Supply Recommendations</i> and <i>Layout</i> sections to the <i>Application and Implementation</i> section.....	19

Changes from Revision B (March 2022) to Revision C (June 2022)	Page
• Changed data sheet status from Production Mixed to Production Data.....	1
• Added Additional Magnetic Threshold option to <i>Features</i> section.....	1
• Added TMAG5231A1C TMAG5231A2D, and TMAG5231C1D to <i>Device Comparison</i> table.....	3
• Added TMAG5231xxC to <i>Electrical Characteristics</i> table.....	5
• Added TMAG5231Axx to the <i>Magnetic Characteristics</i> table.....	5

Changes from Revision A (November 2021) to Revision B (March 2022)	Page
• Changed data sheet status from Production Data to Production Mixed.....	1
• Added Advanced Information DMR (X2SON) package to the data sheet.....	1
• Changed the <i>Device Comparison</i> table.....	3

Changes from Revision * (August 2021) to Revision A (November 2021)	Page
• Changed data sheet status from Advanced Information to Production Data.....	1
• Added the FA and FD device versions.....	1

## 5 Device Comparison

**Table 5-1. Device Comparison**

VERSION	TYPICAL THRESHOLD	TYPICAL HYSTERESIS	MAGNETIC RESPONSE	OUTPUT TYPE	SENSOR ORIENTATION	SAMPLING RATE	PACKAGES AVAILABLE
TMAG5231A1C	1.8 mT	0.6 mT	Omnipolar active Low	Push-pull	Z	10 Hz	SOT-23 X2SON
TMAG5231A2D	1.8 mT	0.6 mT	Omnipolar active High	Push-pull	Z	20 Hz	SOT-23 X2SON
TMAG5231B1D	2.85 mT	1.35 mT	Omnipolar active Low	Push-pull	Z	20 Hz	SOT-23 X2SON
TMAG5231C1D	3 mT	0.8 mT	Omnipolar active Low	Push-pull	Z	20 Hz	SOT-23 X2SON
TMAG5231C1G	3 mT	0.8 mT	Omnipolar active Low	Push-pull	Z	216 Hz	SOT-23 X2SON
TMAG5231H1D	40 mT	6.5 mT	Omnipolar active Low	Push-pull	Z	20 Hz	SOT-23 X2SON

## 6 Pin Configuration and Functions

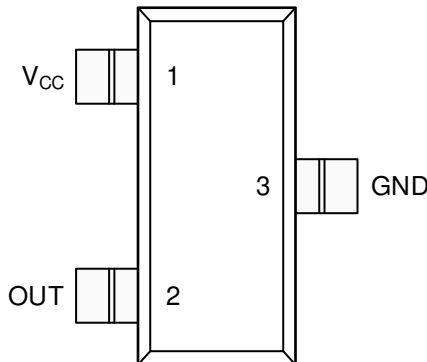

**Figure 6-1. DBZ Package 3-Pin SOT-23 Top View**

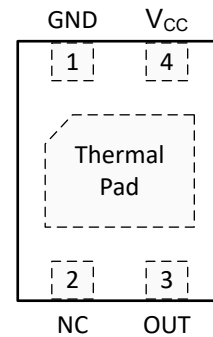

**Figure 6-2. DMR Package 4-Pin X2SON Top View**

**Table 6-1. Pin Functions**

NAME	PIN		I/O	DESCRIPTION
	SOT-23 (3)	X2SON (4)		
GND	3	1	—	Ground reference
OUT	2	3	O	Omnipolar output that responds to north and south magnetic poles
V <sub>CC</sub>	1	4	—	1.65-V to 5.5-V power supply. TI recommends connecting this pin to a ceramic capacitor to ground with a value of at least 0.1 μF.
NC	—	2	—	No connect. This pin is not connected to the silicon. It should be left floating or tied to ground. It should be soldered to the board for mechanical support.
Thermal Pad	—	PAD	—	No connect. This pin should be left floating or tied to ground. It should be soldered to the board for mechanical support.

## 7 Specifications

### 7.1 Absolute Maximum Ratings

over operating free-air temperature range (unless otherwise noted)<sup>(1)</sup>

		MIN	MAX	UNIT
Power Supply Voltage	$V_{CC}$	-0.3	5.5	V
Output Pin Voltage	OUT	GND - 0.3	$V_{CC} + 0.3$	
Output Pin current	OUT	-5	5	mA
Magnetic Flux Density, BMAX		Unlimited		T
Junction temperature, $T_J$	Junction temperature, $T_J$		150	°C
Storage temperature, $T_{stg}$		-65	150	°C

- (1) Operation outside the Absolute Maximum Ratings may cause permanent device damage. Absolute Maximum Ratings do not imply functional operation of the device at these or any other conditions beyond those listed under Recommended Operating Conditions. If used outside the Recommended Operating Conditions but within the Absolute Maximum Ratings, the device may not be fully functional, and this may affect device reliability, functionality, performance, and shorten the device lifetime.

### 7.2 ESD Ratings

			VALUE	UNIT
$V_{(ESD)}$	Electrostatic discharge	Human body model (HBM), per ANSI/ESDA/ JEDEC JS-001, all pins <sup>(1)</sup>	±5500	V
		Charged device model (CDM), per ANSI/ESDA/ JEDEC JS-002, all pins <sup>(2)</sup>	± 500	

- (1) JEDEC document JEP155 states that 500-V HBM allows safe manufacturing with a standard ESD control process.  
 (2) JEDEC document JEP157 states that 250-V CDM allows safe manufacturing with a standard ESD control process.

### 7.3 Recommended Operating Conditions

over operating free-air temperature range (unless otherwise noted)

		MIN	MAX	UNIT
$V_{CC}$	Power supply voltage	1.65	5.5	V
$V_o$	Output voltage	0	5.5	V
$I_o$	Output current	-5	5	mA
$T_A$	Ambient temperature	-40	125	°C

### 7.4 Thermal Information

THERMAL METRIC <sup>(1)</sup>		TMAG5231	TMAG5231	UNIT
		SOT-23 (DBZ)	X2SON (DMR)	
		3 PINS	4 PINS	
$R_{\theta JA}$	Junction-to-ambient thermal resistance	227.4	218.4	°C/W
$R_{\theta JC(top)}$	Junction-to-case (top) thermal resistance	122.7	174.1	
$R_{\theta JB}$	Junction-to-board thermal resistance	61.2	172.4	
$\Psi_{JT}$	Junction-to-top characterization parameter	21.3	11.9	
$\Psi_{JB}$	Junction-to-board characterization parameter	60.8	167.2	
$R_{\theta JC(bot)}$	Junction-to-case (bottom) thermal resistance	N/A	144.9	

- (1) For more information about traditional and new thermal metrics, see the [Semiconductor and IC Package Thermal Metrics](#) application report.

## 7.5 Electrical Characteristics

for VCC = 1.65 V to 5.5 V, over operating free-air temperature range (unless otherwise noted)

PARAMETER		TEST CONDITIONS	MIN	TYP	MAX	UNIT
<b>PUSH-PULL OUTPUT DRIVER</b>						
V <sub>OH</sub>	High-level output voltage	I <sub>OUT</sub> = -0.5 mA	V <sub>CC</sub> -0.35	V <sub>CC</sub> -0.1		V
V <sub>OL</sub>	Low-level output voltage	I <sub>OUT</sub> = 0.5 mA		0.1	0.3	V
<b>TMAG5231xxG</b>						
f <sub>s</sub>	Frequency of magnetic sampling		136	216	374	Hz
t <sub>s</sub>	Period of magnetic sampling		2.67	4.63	7.35	ms
I <sub>CC(AVG)</sub>	Average current consumption	V <sub>CC</sub> = 3 V over temperature		16		μA
<b>TMAG5231xxD</b>						
f <sub>s</sub>	Frequency of magnetic sampling		13	20	29	Hz
t <sub>s</sub>	Period of magnetic sampling			50		ms
I <sub>CC(AVG)</sub>	Average current consumption	V <sub>CC</sub> = 3 V over temperature		2	3	μA
<b>TMAG5231xxC</b>						
f <sub>s</sub>	Frequency of magnetic sampling		7	10	14.5	Hz
t <sub>s</sub>	Period of magnetic sampling		77	100	143	ms
I <sub>CC(AVG)</sub>	Average current consumption	V <sub>CC</sub> = 3 V over temperature		1.3		μA
<b>ALL VERSIONS</b>						
I <sub>CC(PK)</sub>	Peak current consumption		0.8	1.25	2	mA
I <sub>CC(SLP)</sub>	Sleep current consumption			0.8	1.4	μA
t <sub>ON</sub>	Power-on time		65	140	425	μs
t <sub>ACTIVE</sub>	Active time period		45	60	75	

## 7.6 Magnetic Characteristics

for VCC = 1.65 V to 5.5 V

PARAMETER		TEST CONDITIONS	MIN	TYP	MAX	UNIT
<b>TMAG5231Axx</b>						
B <sub>OP</sub>	Magnetic threshold operate point	Temperature = 25 °C	±0.9	±1.8	±2.7	mT
B <sub>RP</sub>	Magnetic release operate point		±0.3	±1.2	±2.2	
B <sub>HYS</sub>	Magnetic hysteresis		±0.1	±0.6	±1.4	
<b>TMAG5231B1D</b>						
B <sub>OP</sub>	Magnetic threshold operate point	Temperature = 25 °C	±1.9	±2.85	±3.8	mT
B <sub>RP</sub>	Magnetic release operate point		±0.5	±1.5	±2.5	
B <sub>HYS</sub>	Magnetic hysteresis		±0.5	±1.35	±2.2	
<b>TMAG5231Cxx</b>						
B <sub>OP</sub>	Magnetic threshold operate point	Temperature = 25 °C	±2	±3	±4	mT
B <sub>RP</sub>	Magnetic release operate point		±1.2	±2.2	±3.2	
B <sub>HYS</sub>	Magnetic hysteresis		±0.3	±0.8	±1.5	
<b>TMAG5231H1D</b>						
B <sub>OP</sub>	Magnetic threshold operate point	Temperature = 25 °C	±30	±40	±50	mT
B <sub>RP</sub>	Magnetic release operate point		±23.5	±33.5	±43.5	
B <sub>HYS</sub>	Magnetic hysteresis		±4.5	±6.5	±8.5	

## 7.7 Typical Characteristics

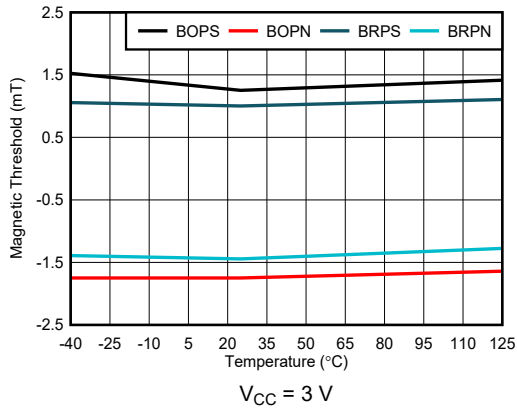

Figure 7-1. 1.8 mT Threshold vs. Temperature

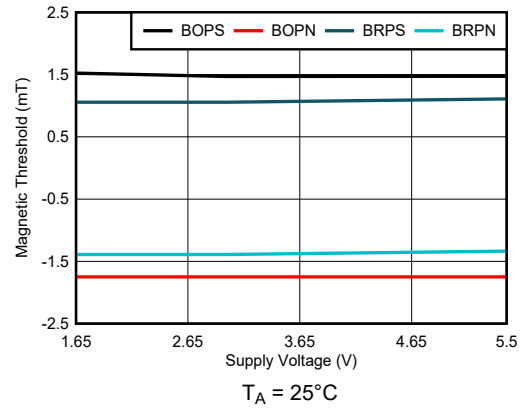

Figure 7-2. 1.8 mT Threshold vs. Supply Voltage

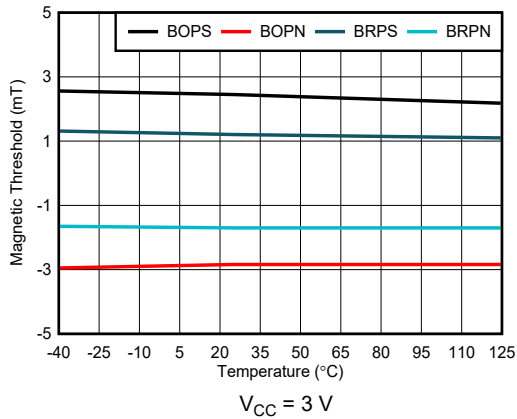

Figure 7-3. 2.85 mT Threshold vs. Temperature

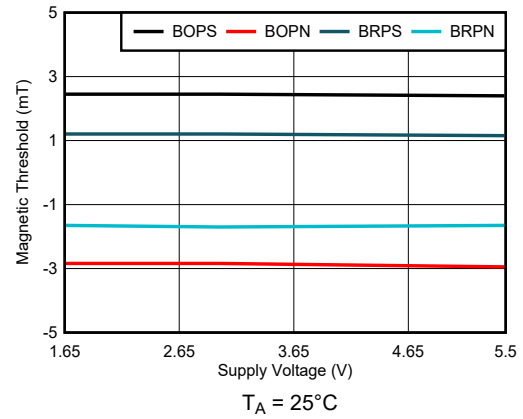

Figure 7-4. 2.85 mT Threshold vs. Supply Voltage

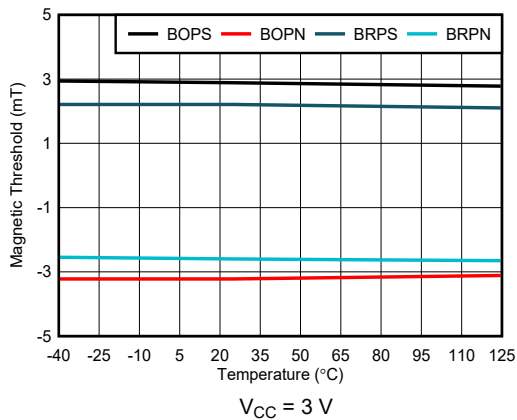

Figure 7-5. 3.0 mT Threshold vs. Temperature

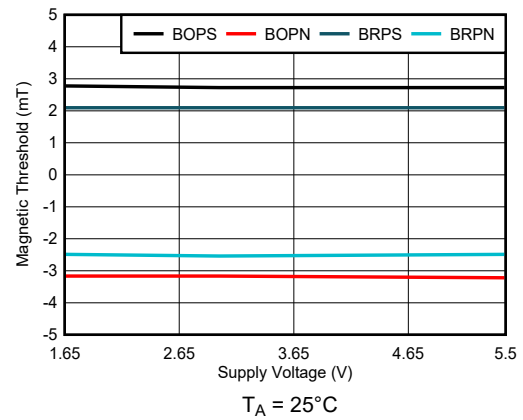
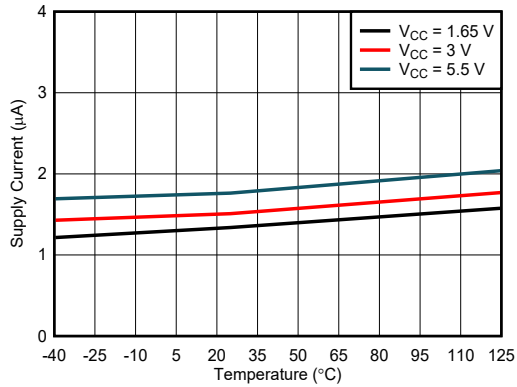
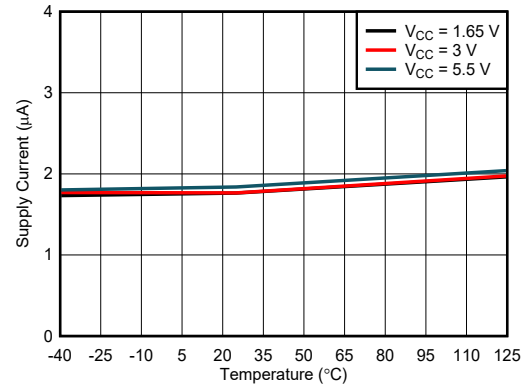

Figure 7-6. 3.0 mT Threshold vs. Supply Voltage



Magnetic Threshold = 1.8 mT  
Sampling Rate = 10 Hz

**Figure 7-7.  $I_{CC}$  vs. Temperature**



Magnetic Threshold = 1.8 mT  
Sampling Rate = 20 Hz

**Figure 7-8.  $I_{CC}$  vs. Temperature**

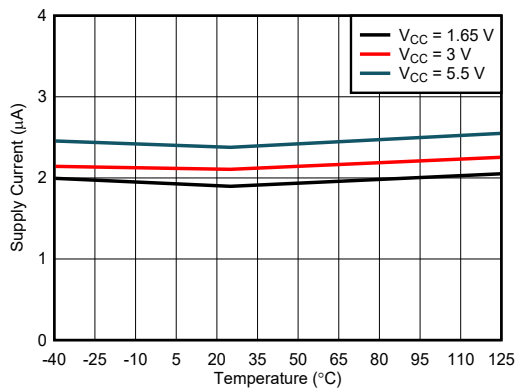

Magnetic Threshold = 2.85 mT  
Sampling Rate = 20 Hz

**Figure 7-9.  $I_{CC}$  vs. Temperature**

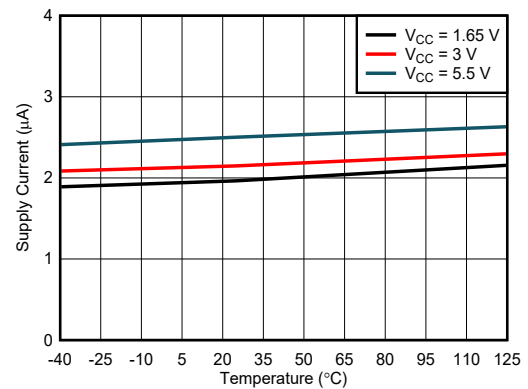

Magnetic Threshold = 3.0 mT  
Sampling Rate = 20 Hz

**Figure 7-10.  $I_{CC}$  vs. Temperature**

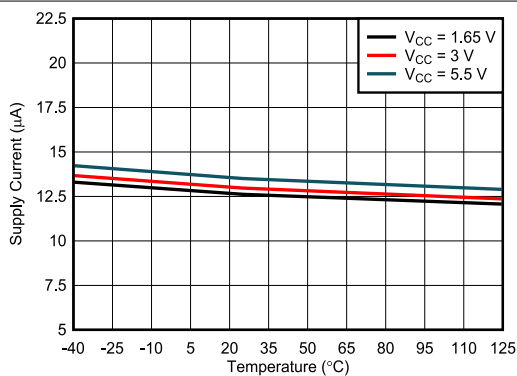

Magnetic Threshold = 3.0 mT  
Sampling Rate = 216 Hz

**Figure 7-11.  $I_{CC}$  vs. Temperature**

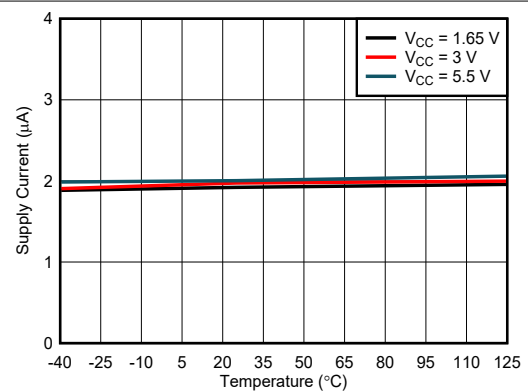

Magnetic Threshold = 40 mT  
Sampling Rate = 20 Hz

**Figure 7-12.  $I_{CC}$  vs. Temperature**

## 8 Detailed Description

### 8.1 Overview

The TMAG5231 device is a magnetic sensor with a digital output that indicates when the magnetic flux density threshold has been crossed. The output consists of a push-pull turning low when a field is present or turning high when no field is present. As an omnipolar switch the output is sensitive to both the South and the North Pole. The device integrates a Hall Effect element, analog signal conditioning, and a low-frequency oscillator that enables ultra-low average power consumption. To achieve low-power consumption the device periodically measures magnetic flux density, updates the output, and enters into a low-power sleep state. With a supply range of 1.65 V to 5.5 V, this device is designed for battery-operated applications.

### 8.2 Functional Block Diagram

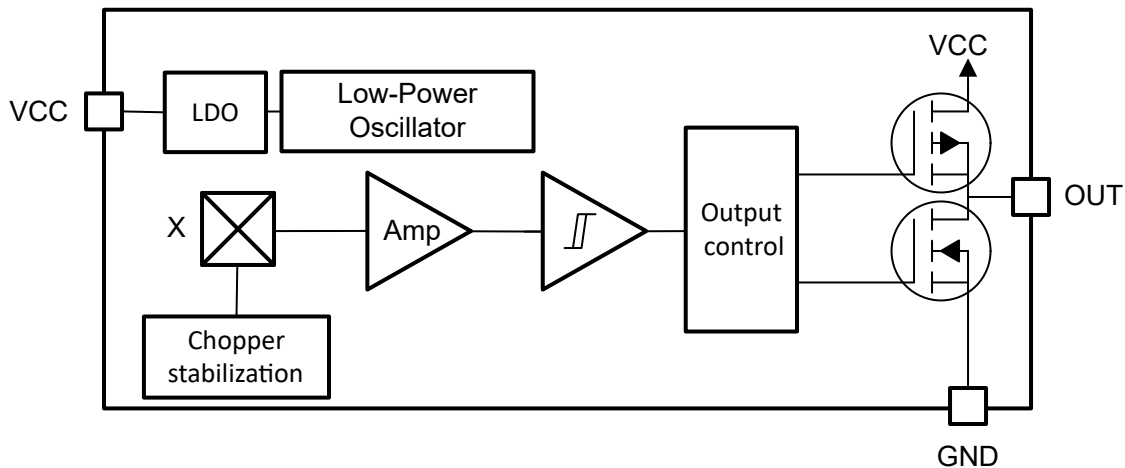

### 8.3 Feature Description

#### 8.3.1 Magnetic Flux Direction

Figure 8-1 shows that the TMAG5231 device is sensitive to the magnetic field component that is perpendicular to the top of the package.

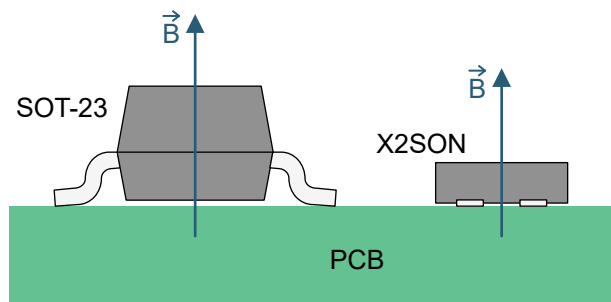

**Figure 8-1. Direction of Sensitivity**

Magnetic flux that travels from the bottom to the top of the package is considered positive in this data sheet. This condition exists when a south magnetic pole is near the top of the package. Magnetic flux that travels from the top to the bottom of the package results in negative millitesla values.



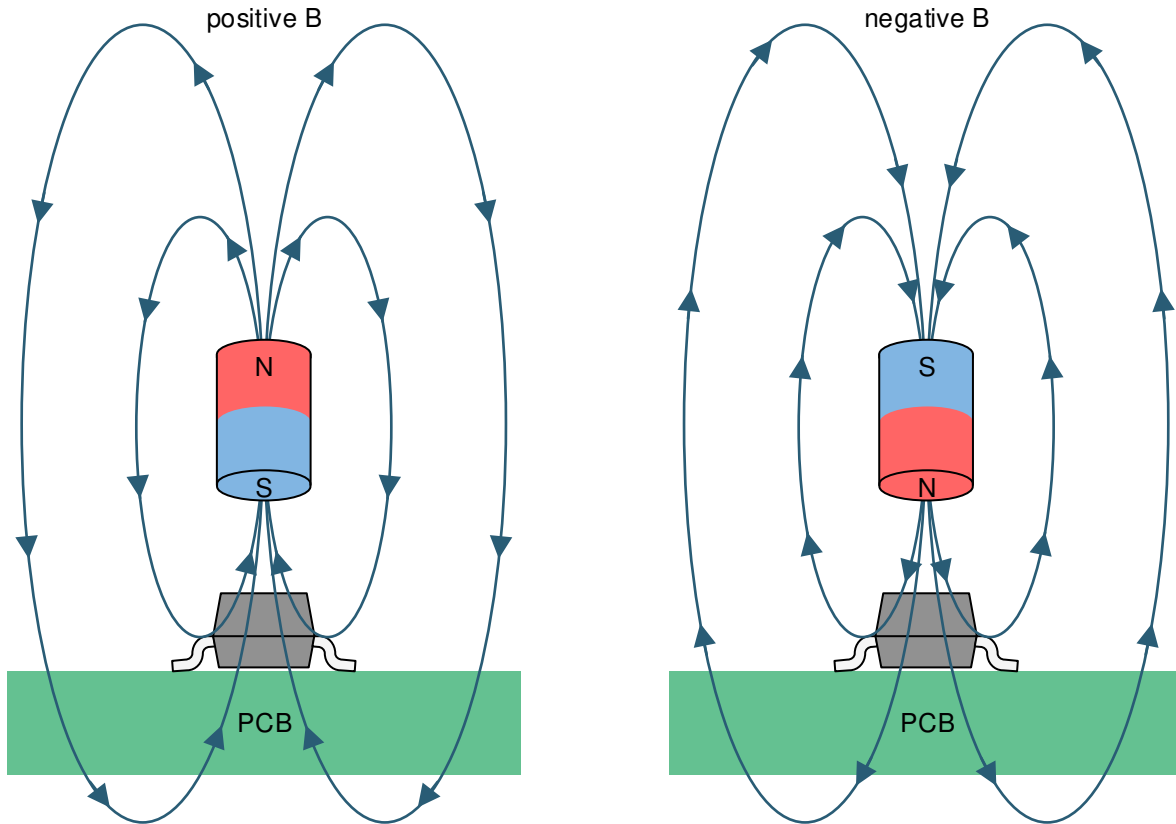

Figure 8-2. Flux Direction Polarity

### 8.3.2 Magnetic Response

The TMAG5231 is an omnipolar switch. Figure 8-3 shows the output responds to both north and south poles.

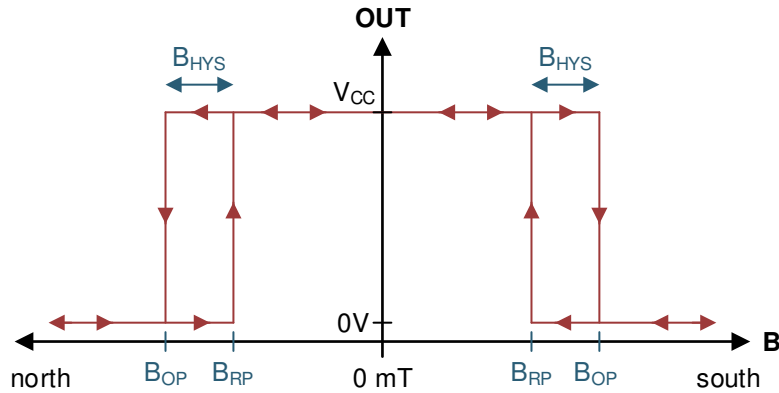
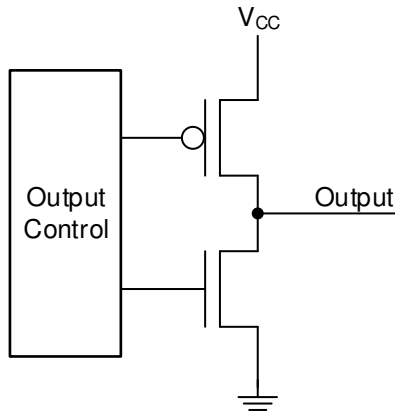

Figure 8-3. Omnipolar Functionality

### 8.3.3 Output Type

The TMAG5231 has a push-pull CMOS output that can drive the output voltage near  $V_{CC}$  or ground level.



**Figure 8-4. Push-Pull Output (Simplified)**

### 8.3.4 Sampling Rate

When the TMAG5231 powers up, the device measures the first magnetic sample and sets the output within the  $t_{ON}$  time. The output is latched, and the device enters an ultra low power sleep state. After each  $t_s$  time has passed, the device measures a new sample and updates the output if necessary. If the magnetic field does not change between periods, the output also does not change.

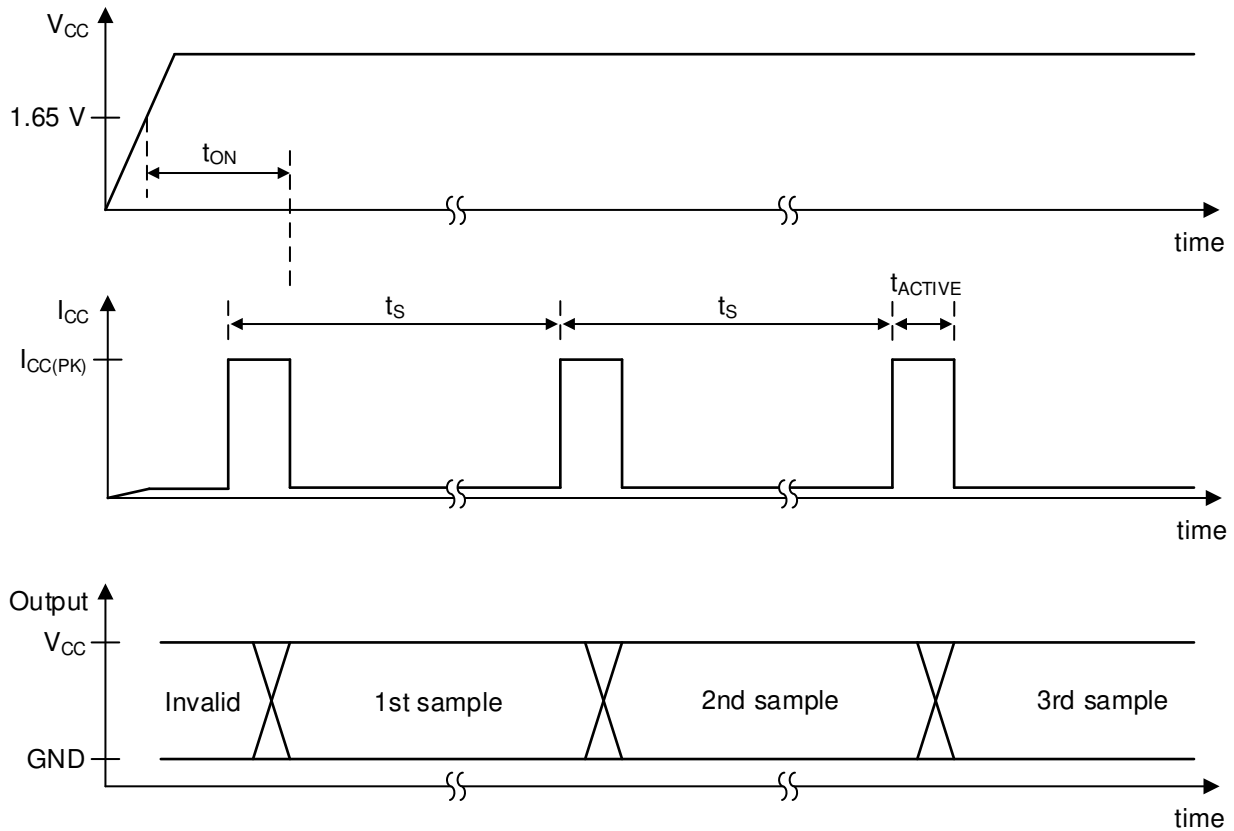

**Figure 8-5. Timing Diagram**

### 8.3.5 Hall Element Location

The sensing element inside the device is in the center of both packages when viewed from the top. Figure 8-6 shows the tolerances and side-view dimensions.

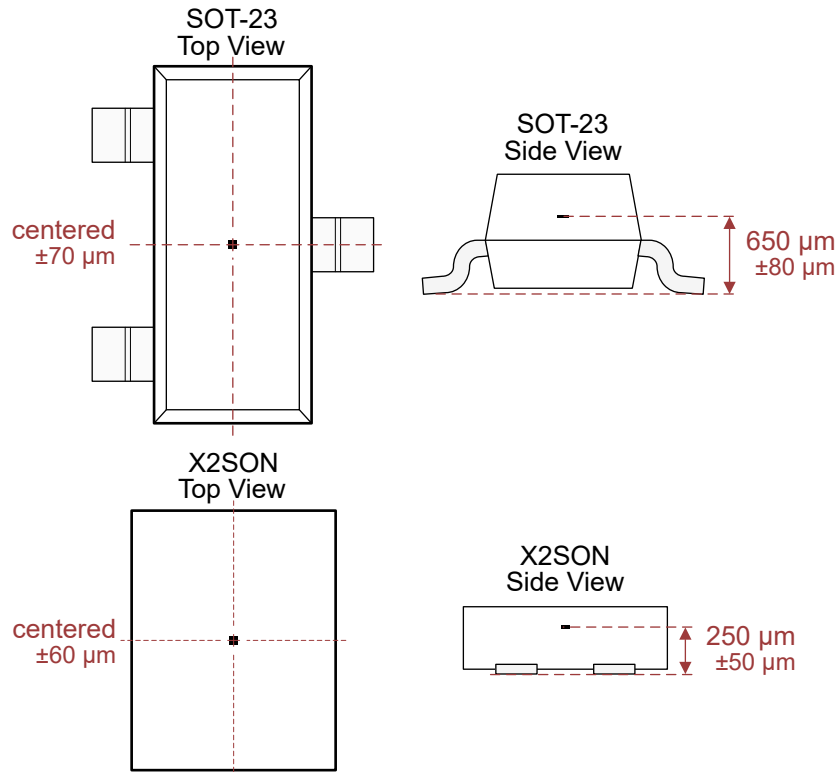

**Figure 8-6. Hall Element Location**

### 8.4 Device Functional Modes

The TMAG5231 device has one mode of operation that applies when the *Recommended Operating Conditions* are met.

## 9 Application and Implementation

### Note

Information in the following applications sections is not part of the TI component specification, and TI does not warrant its accuracy or completeness. TI's customers are responsible for determining suitability of components for their purposes, as well as validating and testing their design implementation to confirm system functionality.

### 9.1 Application Information

The TMAG5231 device is typically used to detect the proximity of a magnet. The magnet is often attached to a movable component in the system.

#### 9.1.1 Defining the Design Implementation

The first step of design is identifying your general design implementation, which means you will define whether you are detecting a magnet sliding past the sensor, moving head-on toward the sensor, or swinging toward the sensor on a hinge. [Figure 9-1](#) shows examples for each of the aforementioned design implementations.

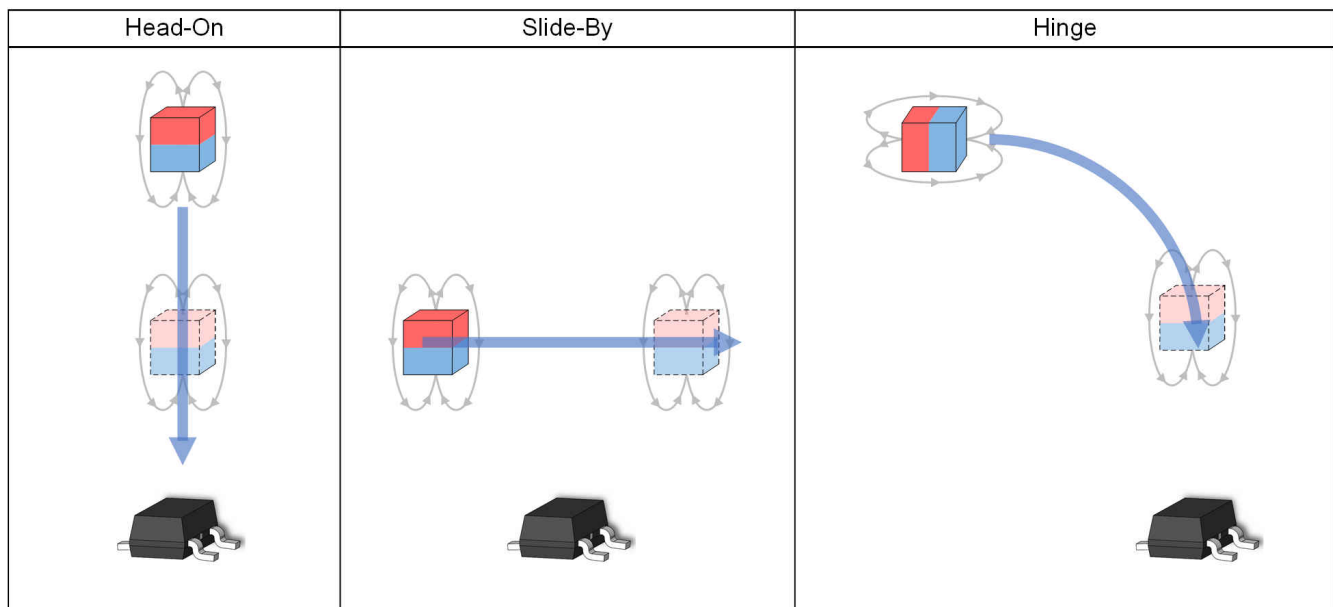

**Figure 9-1. Design Implementations**

With each implementation, the objective is to design the system such that the spatial coordinates of the transition region fall within the spatial coordinates associated with the  $B_{OP}$  maximum and  $B_{RP}$  minimum specifications. [Figure 9-2](#) shows a head-on example that shows how the location corresponding to the device  $B_{OPMAX}$  and  $B_{RPMIN}$  fall within the desired transition region. To facilitate rapid design iteration, TI's [Magnetic Sensing Proximity Tool](#) is leveraged in the following design examples.

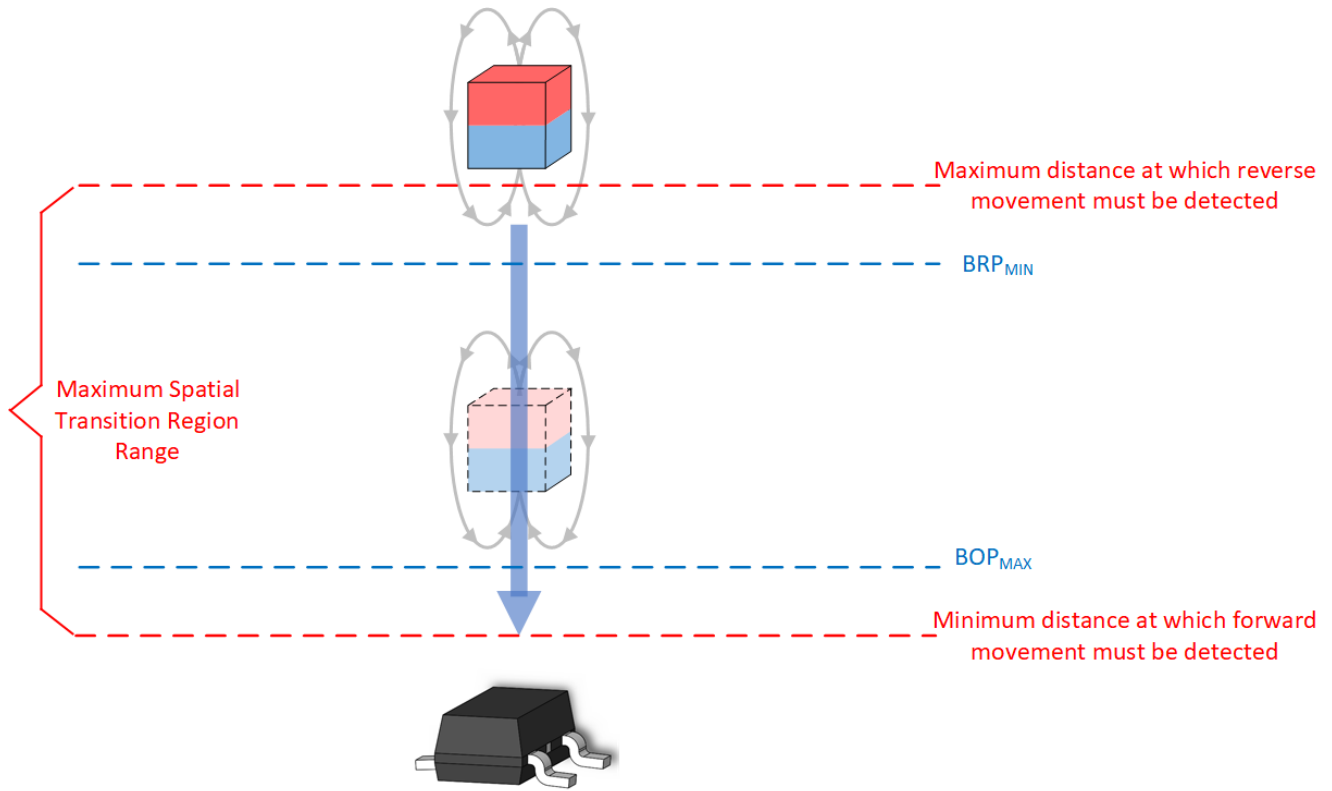
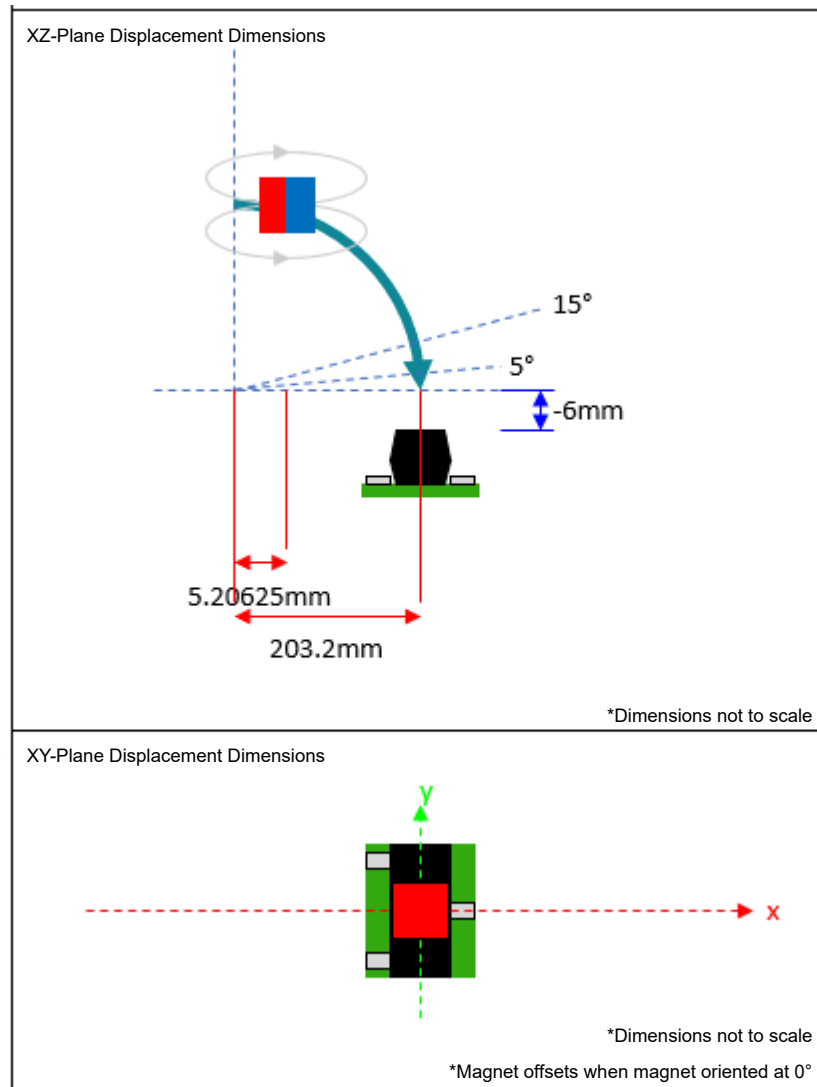

Figure 9-2. Head-On Example

## 9.2 Typical Applications

### 9.2.1 Hinge



**Figure 9-3. Typical Application Diagram**

#### 9.2.1.1 Design Requirements

Table 9-1 lists the design parameters for this example.

**Table 9-1. Design Parameters**

DESIGN PARAMETER	EXAMPLE VALUE
$V_{CC}$	3.3 V
Switch Region	5° to 15°
Max Magnet	1/4" ( 6.35 mm)
Max Magnet Width or Length	1" (25.4 mm)
Fixture Width	12" (304.8 mm)
Fixture Length	9" (228.6 mm)
Sensor Distance From Hinge Origin	0.23622" (6 mm)
Center Of Magnet Offset From Hinge Origin	$\geq(6 \text{ mm} - \text{Magnet Height}/2)$

### 9.2.1.2 Detailed Design Procedure

Due to the complex non-linear behavior magnets and the number of variables that can influence it, some experimentation is required to solve for a design that will work. This application uses a simple axial, dipole, block magnet. Other shapes might be considered for different field strengths or prices. A neodymium type of magnet (N52) is used. At the time of this writing, N52 can be commonly found with heights of 1/16", 1/8", 3/16", and 1/4". As price often increases with size, the first design attempt will be with a 1/16" thick magnet, which has a width and length equal to 0.25". Based on the sensor distance from hinge origin and fixture dimension constraints, there is a lot of flexibility on where the sensor can be placed. Due to other hardware within the fixture, the TMAG5231B1DQDBZ sensor is placed 8" (203.2 mm) from the origin. From there, the user can assess a design with the following displacement dimensions.

Figure 9-4 shows that the b-field magnitude for the TMAG5231B1DQDBZ is not adequate for the spatial constraints of 5° and 15°, as the  $B_z$  magnitude only surpasses the  $B_{RP}$  minimum. There are a few options on how to proceed. As the  $B_{OP(Max)}$  does not fall within our range, the user must increase field strength. This can be accomplished with a thicker magnet or by adjusting sensor and magnet z-offsets. The magnet cannot get any closer due to enclosure constraints, therefore the only option allowed is to increase the magnet thickness. After a few more iterations with the tool, a 0.25" × 0.25" × 0.25" magnet can work (see Figure 9-5 and Figure 9-6).

### 9.2.1.3 Application Curves

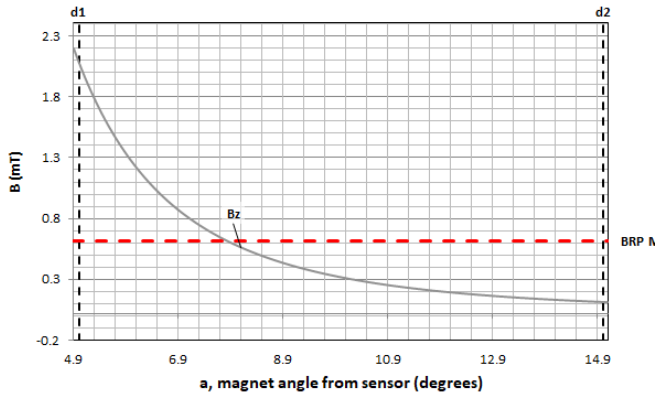

Figure 9-4. B-Field Hypothesis One

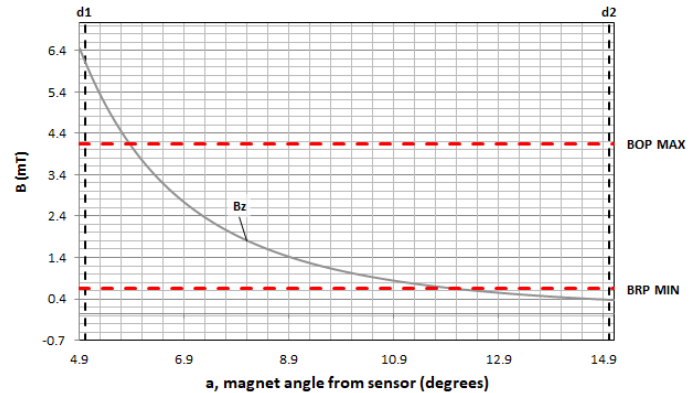

Figure 9-5. B-Field Hypothesis Two

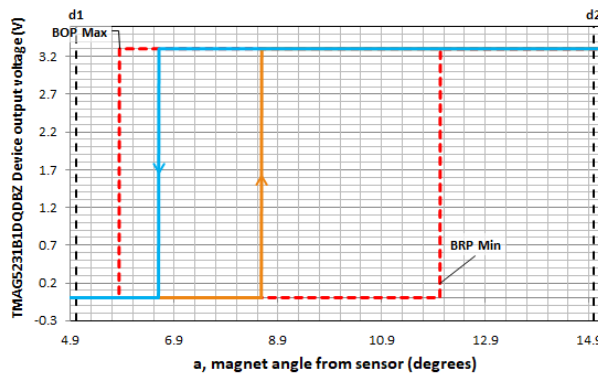
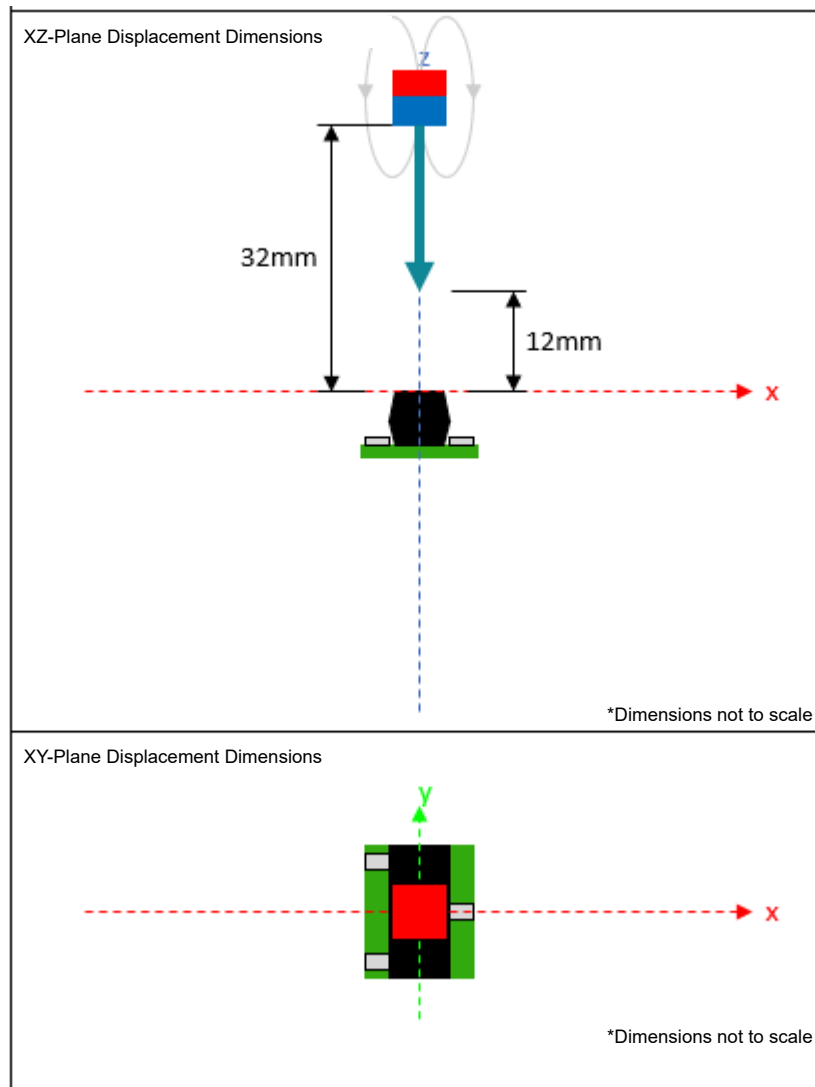

Figure 9-6. Thresholds

### 9.2.2 Head-On



**Figure 9-7. Typical Application Diagram**

#### 9.2.2.1 Design Requirements

Table 9-1 lists the design parameters for this example.

**Table 9-2. Design Parameters**

DESIGN PARAMETER	EXAMPLE VALUE
$V_{CC}$	3.3 V
Switch Region	Between 10 mm and 30 mm from sensor fixture Surface
Sensor Distance From Equipment Outer Surface	0.0787" (2 mm)
Magnet Length	<1" (25.4 mm)
Magnet Width	<1" (25.4 mm)
Magnet Height	<1/4" (6.35 mm)
Magnet Type	N42



### 9.2.2.2 Detailed Design Procedure

In this particular case, there are several N42 magnets available from other prior projects. As the desired transition region is where the magnet surface is at least 12 mm (10 mm + 2 mm) away from the sensor, we try an initial design with one of our larger magnets (3/8" × 3/16" × 3/16"). Figure 9-8 shows the respective curve for this magnet along the movement along with the magnetic thresholds of the TMAG5231B1DQDBZ.

While the  $B_z$  magnitude adequately exceeds the  $B_{OPMAX}$ , it does not quite reach the  $B_{RPMIN}$ . Therefore, the user must make some adjustments so that  $B_z$  falls below  $B_{RPMIN}$  within the desired operating range. To reduce  $B_z$ , there are a few options. The user can offset the magnet or choose a smaller magnet. After iterating through increasing x-offsets and y-offsets as well as decreasing magnet thicknesses, the user can eventually find a solution that works. In this case, a 3/8" × 3/16" × 1/16" N42 magnet with no x or y offset from the sensor center is used. Figure 9-9 and Figure 9-10 shows the curves corresponding to the final magnet parameters.

### 9.2.2.3 Application Curve

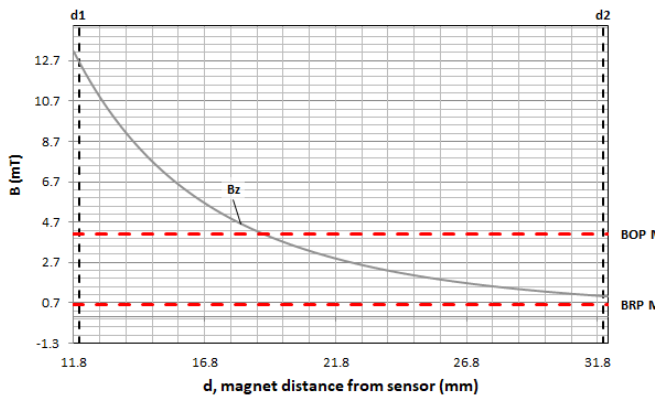

Figure 9-8. B-Field Hypothesis One

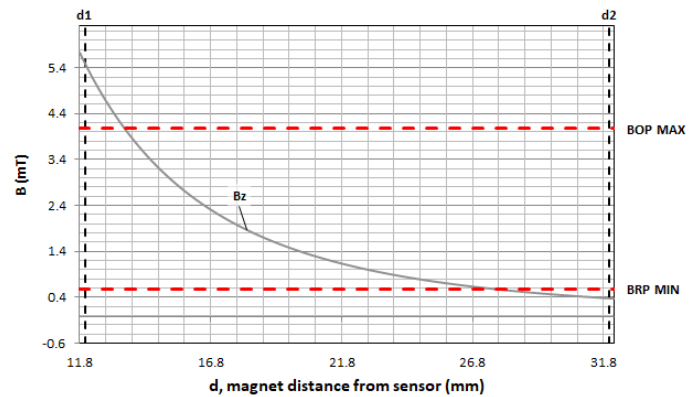

Figure 9-9. B-Field Hypothesis Two

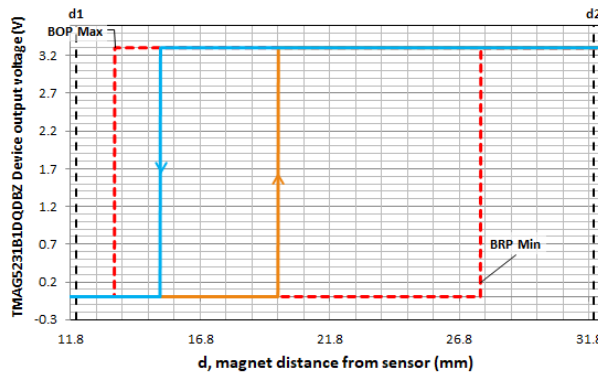

Figure 9-10. Thresholds

9.2.3 Slide-By

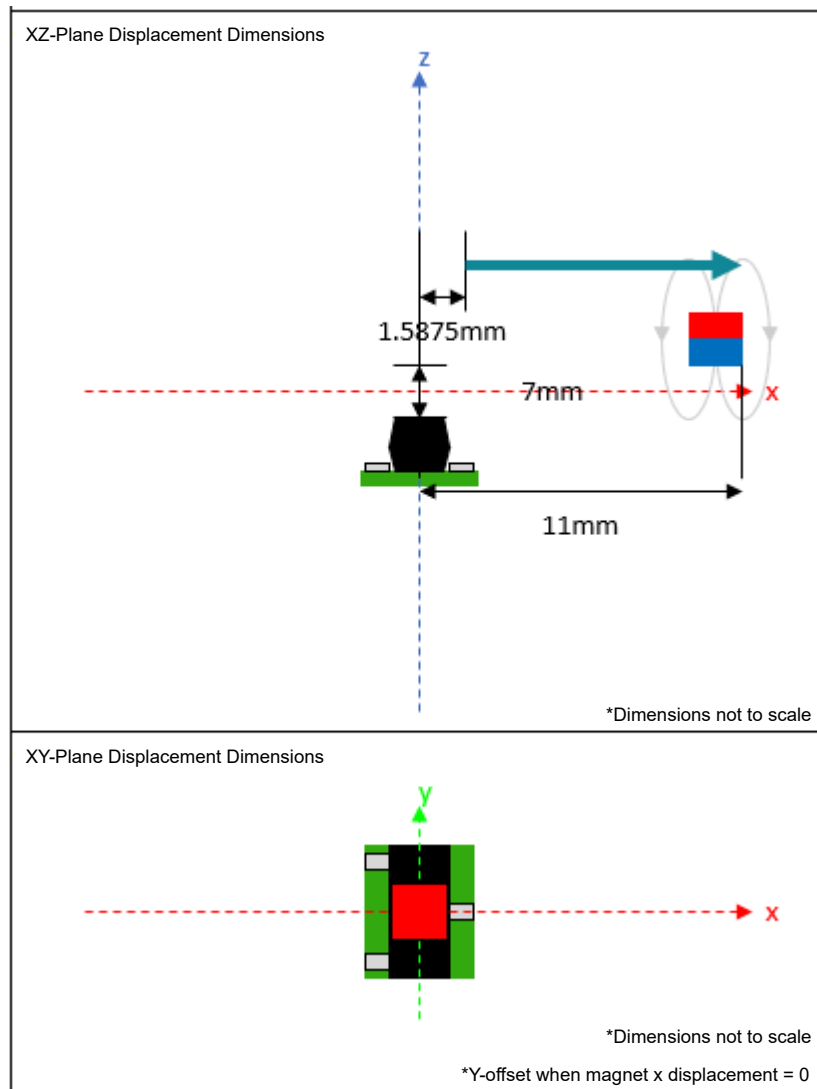

Figure 9-11. Typical Application Diagram

9.2.3.1 Design Requirements

Table 9-1 lists the design parameters for this example.

Table 9-3. Design Parameters

DESIGN PARAMETER	EXAMPLE VALUE
V <sub>CC</sub>	3.3 V
Magnet Range Of Motion	<0.433" (11 mm)
Sensor Distance From Equipment Outer Surface	>0.236" (6 mm)
Magnet Length	<1/2" (12.7 mm)
Magnet Width	<1/2" (12.7 mm)
Magnet Height	<1/8" (3.175 mm)
Magnet Type	N42

### 9.2.3.2 Detailed Design Procedure

For this particular case involving the TMAG5231B1DQDBZ, the user can arbitrarily start with a 1/8" × 1/8" × 1/16" magnet, a z-offset of 7 mm (>6 mm), and an initial displacement of one half of the magnet length (1/8"/2 = 1/16") and serendipitously get something that works (see Figure 9-12 and Figure 9-13). Had the B-field not exceeded  $B_{OPMAX}$ , the user could try moving the magnet closer on the z-axis, made the magnet larger, or changed the magnet to one with higher permeability. Alternatively, if the b-field was too large, the magnet can be moved further away in each axis or a smaller magnet can be used.

### 9.2.3.3 Application Curve

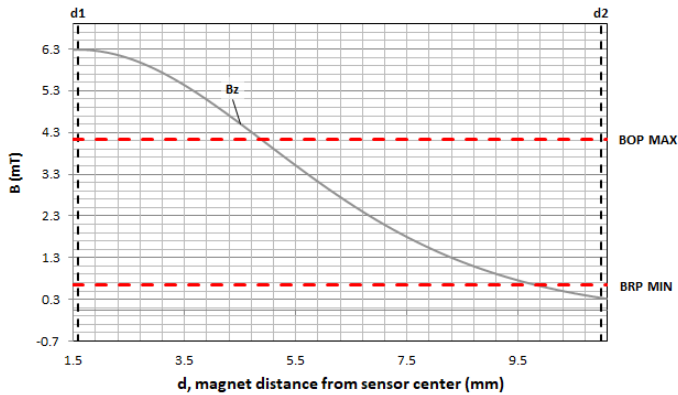

Figure 9-12. B-Field Hypothesis

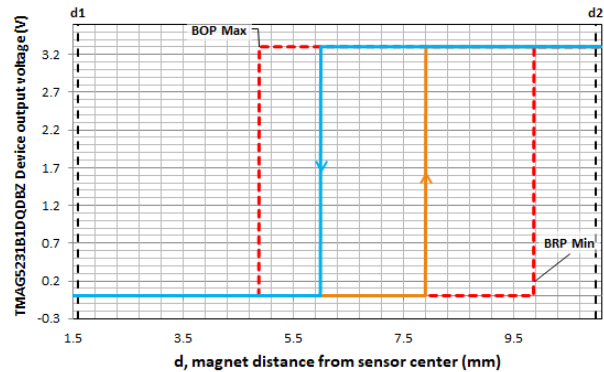

Figure 9-13. Thresholds

## 9.3 Power Supply Recommendations

The TMAG5231 device is powered from 1.65-V to 5.5-V DC power supplies. A decoupling capacitor close to the device must be used to provide local energy with minimal inductance. TI recommends using a ceramic capacitor with a value of at least 0.1  $\mu$ F.

## 9.4 Layout

### 9.4.1 Layout Guidelines

Magnetic fields pass through most non-ferromagnetic materials with no significant disturbance. Embedding Hall effect sensors within plastic or aluminum enclosures and sensing magnets on the outside is common practice. Magnetic fields also easily pass through most printed circuit boards (PCBs), which makes the placement of the magnet on the opposite side possible.

### 9.4.2 Layout Examples

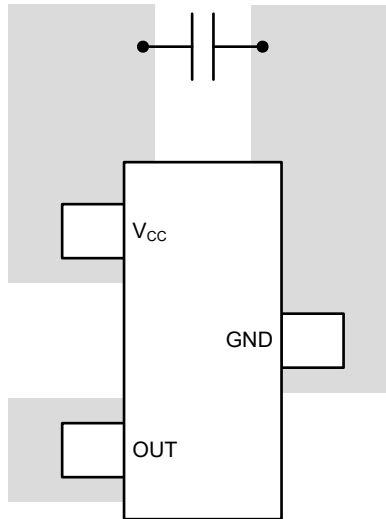

Figure 9-14. SOT-23 Layout Example

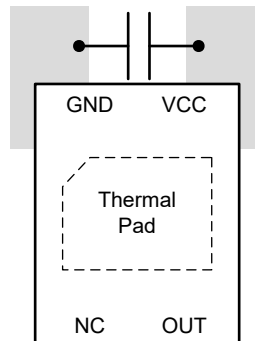

Figure 9-15. X2SON Layout Example

## 10 Device and Documentation Support

### 10.1 Support Resources

[TI E2E™ support forums](#) are an engineer's go-to source for fast, verified answers and design help — straight from the experts. Search existing answers or ask your own question to get the quick design help you need.

Linked content is provided "AS IS" by the respective contributors. They do not constitute TI specifications and do not necessarily reflect TI's views; see TI's [Terms of Use](#).

### 10.2 Trademarks

TI E2E™ is a trademark of Texas Instruments.  
All trademarks are the property of their respective owners.

### 10.3 Electrostatic Discharge Caution



This integrated circuit can be damaged by ESD. Texas Instruments recommends that all integrated circuits be handled with appropriate precautions. Failure to observe proper handling and installation procedures can cause damage.

ESD damage can range from subtle performance degradation to complete device failure. Precision integrated circuits may be more susceptible to damage because very small parametric changes could cause the device not to meet its published specifications.

### 10.4 Glossary

[TI Glossary](#) This glossary lists and explains terms, acronyms, and definitions.

## 11 Mechanical and Packaging Information

The following pages include mechanical, packaging, and orderable information. This information is the most current data available for the designated devices. This data is subject to change without notice and revision of this document. For browser-based versions of this data sheet, refer to the left-hand navigation.

**PACKAGING INFORMATION**

Orderable Device	Status (1)	Package Type	Package Drawing	Pins	Package Qty	Eco Plan (2)	Lead finish/ Ball material (6)	MSL Peak Temp (3)	Op Temp (°C)	Device Marking (4/5)	Samples
TMAG5231A1CQDBZR	ACTIVE	SOT-23	DBZ	3	3000	RoHS & Green	SN	Level-1-260C-UNLIM	-40 to 125	1A1C	<a href="#">Samples</a>
TMAG5231A1CQDMRR	ACTIVE	X2SON	DMR	4	3000	RoHS & Green	SN	Level-1-260C-UNLIM	-40 to 125	A1C	<a href="#">Samples</a>
TMAG5231A2DQDBZR	ACTIVE	SOT-23	DBZ	3	3000	RoHS & Green	SN	Level-1-260C-UNLIM	-40 to 125	1A2D	<a href="#">Samples</a>
TMAG5231A2DQDMRR	ACTIVE	X2SON	DMR	4	3000	RoHS & Green	SN	Level-1-260C-UNLIM	-40 to 125	A2D	<a href="#">Samples</a>
TMAG5231B1DQDBZR	ACTIVE	SOT-23	DBZ	3	3000	RoHS & Green	SN	Level-1-260C-UNLIM	-40 to 125	1B1D	<a href="#">Samples</a>
TMAG5231B1DQDMRR	ACTIVE	X2SON	DMR	4	3000	RoHS & Green	SN	Level-1-260C-UNLIM	-40 to 125	B1D	<a href="#">Samples</a>
TMAG5231C1DQDBZR	ACTIVE	SOT-23	DBZ	3	3000	RoHS & Green	SN	Level-1-260C-UNLIM	-40 to 125	1C1D	<a href="#">Samples</a>
TMAG5231C1DQDMRR	ACTIVE	X2SON	DMR	4	3000	RoHS & Green	SN	Level-1-260C-UNLIM	-40 to 125	C1D	<a href="#">Samples</a>
TMAG5231C1GQDBZR	ACTIVE	SOT-23	DBZ	3	3000	RoHS & Green	SN	Level-1-260C-UNLIM	-40 to 125	1C1G	<a href="#">Samples</a>
TMAG5231C1GQDMRR	ACTIVE	X2SON	DMR	4	3000	RoHS & Green	SN	Level-1-260C-UNLIM	-40 to 125	C1G	<a href="#">Samples</a>
TMAG5231H1DQDBZR	ACTIVE	SOT-23	DBZ	3	3000	RoHS & Green	SN	Level-1-260C-UNLIM	-40 to 125	1H1D	<a href="#">Samples</a>
TMAG5231H1DQDMRR	ACTIVE	X2SON	DMR	4	3000	RoHS & Green	SN	Level-1-260C-UNLIM	-40 to 125	H1D	<a href="#">Samples</a>

(1) The marketing status values are defined as follows:

**ACTIVE:** Product device recommended for new designs.

**LIFEBUY:** TI has announced that the device will be discontinued, and a lifetime-buy period is in effect.

**NRND:** Not recommended for new designs. Device is in production to support existing customers, but TI does not recommend using this part in a new design.

**PREVIEW:** Device has been announced but is not in production. Samples may or may not be available.

**OBSELETE:** TI has discontinued the production of the device.

(2) **RoHS:** TI defines "RoHS" to mean semiconductor products that are compliant with the current EU RoHS requirements for all 10 RoHS substances, including the requirement that RoHS substance do not exceed 0.1% by weight in homogeneous materials. Where designed to be soldered at high temperatures, "RoHS" products are suitable for use in specified lead-free processes. TI may reference these types of products as "Pb-Free".

**RoHS Exempt:** TI defines "RoHS Exempt" to mean products that contain lead but are compliant with EU RoHS pursuant to a specific EU RoHS exemption.

**Green:** TI defines "Green" to mean the content of Chlorine (Cl) and Bromine (Br) based flame retardants meet JS709B low halogen requirements of <=1000ppm threshold. Antimony trioxide based flame retardants must also meet the <=1000ppm threshold requirement.

- (3) MSL, Peak Temp. - The Moisture Sensitivity Level rating according to the JEDEC industry standard classifications, and peak solder temperature.
- (4) There may be additional marking, which relates to the logo, the lot trace code information, or the environmental category on the device.
- (5) Multiple Device Markings will be inside parentheses. Only one Device Marking contained in parentheses and separated by a "~" will appear on a device. If a line is indented then it is a continuation of the previous line and the two combined represent the entire Device Marking for that device.
- (6) Lead finish/Ball material - Orderable Devices may have multiple material finish options. Finish options are separated by a vertical ruled line. Lead finish/Ball material values may wrap to two lines if the finish value exceeds the maximum column width.

**Important Information and Disclaimer:**The information provided on this page represents TI's knowledge and belief as of the date that it is provided. TI bases its knowledge and belief on information provided by third parties, and makes no representation or warranty as to the accuracy of such information. Efforts are underway to better integrate information from third parties. TI has taken and continues to take reasonable steps to provide representative and accurate information but may not have conducted destructive testing or chemical analysis on incoming materials and chemicals. TI and TI suppliers consider certain information to be proprietary, and thus CAS numbers and other limited information may not be available for release.

In no event shall TI's liability arising out of such information exceed the total purchase price of the TI part(s) at issue in this document sold by TI to Customer on an annual basis.

## TAPE AND REEL INFORMATION



### QUADRANT ASSIGNMENTS FOR PIN 1 ORIENTATION IN TAPE



\*All dimensions are nominal

Device	Package Type	Package Drawing	Pins	SPQ	Reel Diameter (mm)	Reel Width W1 (mm)	A0 (mm)	B0 (mm)	K0 (mm)	P1 (mm)	W (mm)	Pin1 Quadrant
TMAG5231A1CQDBZR	SOT-23	DBZ	3	3000	178.0	9.0	3.15	2.77	1.22	4.0	8.0	Q3
TMAG5231A1CQDMRR	X2SON	DMR	4	3000	179.0	8.4	1.27	1.57	0.5	4.0	8.0	Q1
TMAG5231A2DQDBZR	SOT-23	DBZ	3	3000	178.0	9.0	3.15	2.77	1.22	4.0	8.0	Q3
TMAG5231A2DQDMRR	X2SON	DMR	4	3000	179.0	8.4	1.27	1.57	0.5	4.0	8.0	Q1
TMAG5231B1DQDBZR	SOT-23	DBZ	3	3000	180.0	8.4	3.2	2.85	1.3	4.0	8.0	Q3
TMAG5231B1DQDMRR	X2SON	DMR	4	3000	179.0	8.4	1.27	1.57	0.5	4.0	8.0	Q1
TMAG5231C1DQDBZR	SOT-23	DBZ	3	3000	178.0	9.0	3.15	2.77	1.22	4.0	8.0	Q3
TMAG5231C1DQDMRR	X2SON	DMR	4	3000	179.0	8.4	1.27	1.57	0.5	4.0	8.0	Q1
TMAG5231C1GQDBZR	SOT-23	DBZ	3	3000	178.0	9.0	3.15	2.77	1.22	4.0	8.0	Q3
TMAG5231C1GQDMRR	X2SON	DMR	4	3000	179.0	8.4	1.27	1.57	0.5	4.0	8.0	Q1
TMAG5231H1DQDBZR	SOT-23	DBZ	3	3000	178.0	9.0	3.15	2.77	1.22	4.0	8.0	Q3
TMAG5231H1DQDMRR	X2SON	DMR	4	3000	179.0	8.4	1.27	1.57	0.5	4.0	8.0	Q1



**TAPE AND REEL BOX DIMENSIONS**

\*All dimensions are nominal

Device	Package Type	Package Drawing	Pins	SPQ	Length (mm)	Width (mm)	Height (mm)
TMAG5231A1CQDBZR	SOT-23	DBZ	3	3000	180.0	180.0	18.0
TMAG5231A1CQDMRR	X2SON	DMR	4	3000	200.0	183.0	25.0
TMAG5231A2DQDBZR	SOT-23	DBZ	3	3000	180.0	180.0	18.0
TMAG5231A2DQDMRR	X2SON	DMR	4	3000	200.0	183.0	25.0
TMAG5231B1DQDBZR	SOT-23	DBZ	3	3000	210.0	185.0	35.0
TMAG5231B1DQDMRR	X2SON	DMR	4	3000	200.0	183.0	25.0
TMAG5231C1DQDBZR	SOT-23	DBZ	3	3000	180.0	180.0	18.0
TMAG5231C1DQDMRR	X2SON	DMR	4	3000	200.0	183.0	25.0
TMAG5231C1GQDBZR	SOT-23	DBZ	3	3000	180.0	180.0	18.0
TMAG5231C1GQDMRR	X2SON	DMR	4	3000	200.0	183.0	25.0
TMAG5231H1DQDBZR	SOT-23	DBZ	3	3000	180.0	180.0	18.0
TMAG5231H1DQDMRR	X2SON	DMR	4	3000	200.0	183.0	25.0

# DBZ0003A

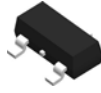

# PACKAGE OUTLINE

SOT-23 - 1.12 mm max height

SMALL OUTLINE TRANSISTOR

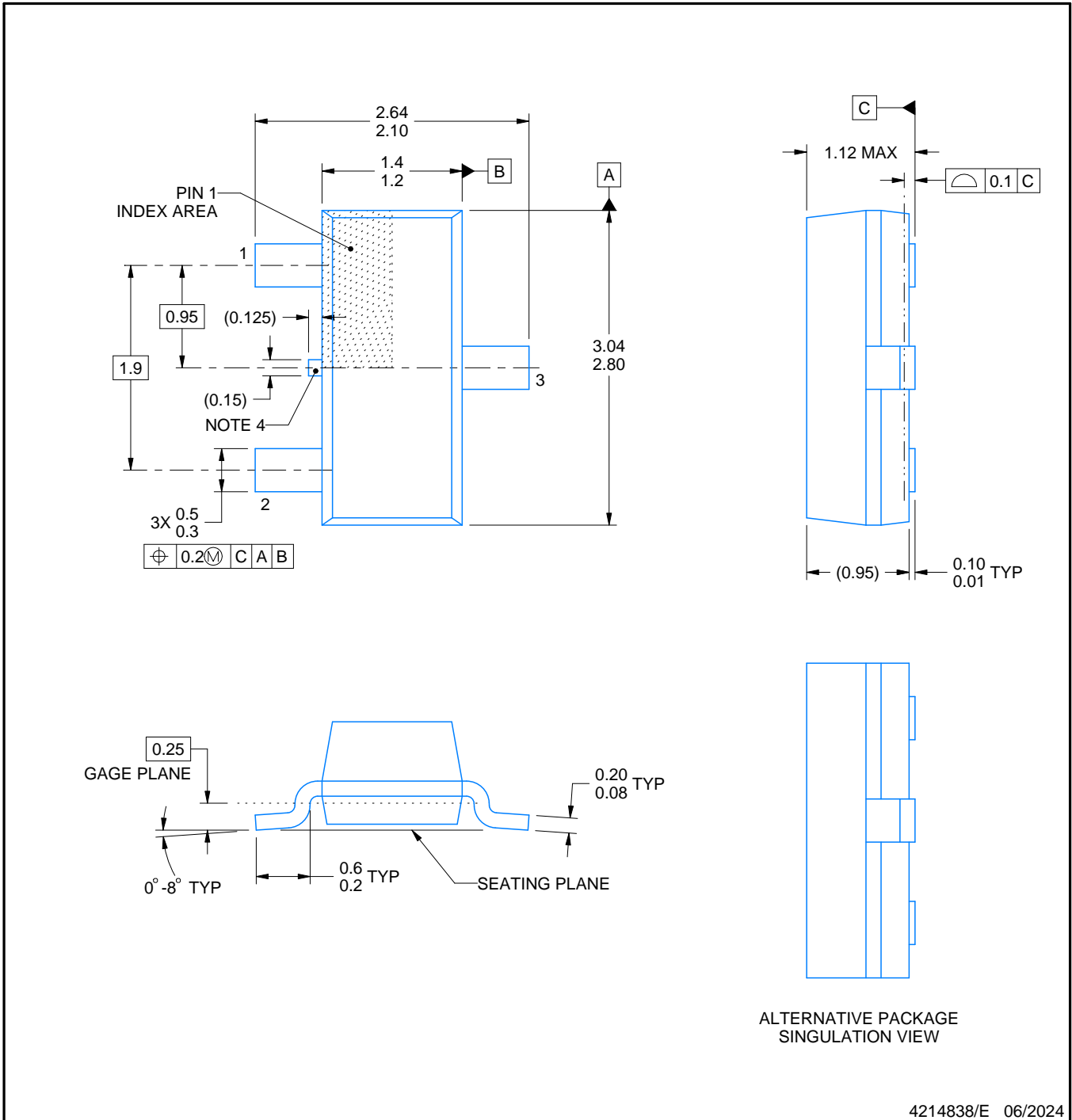

4214838/E 06/2024

NOTES:

1. All linear dimensions are in millimeters. Any dimensions in parenthesis are for reference only. Dimensioning and tolerancing per ASME Y14.5M.
2. This drawing is subject to change without notice.
3. Reference JEDEC registration TO-236, except minimum foot length.
4. Support pin may differ or may not be present.
5. Body dimensions do not include mold flash, protrusions, or gate burrs. Mold flash, protrusions, or gate burrs shall not exceed 0.25mm per side

# EXAMPLE BOARD LAYOUT

DBZ0003A

SOT-23 - 1.12 mm max height

SMALL OUTLINE TRANSISTOR

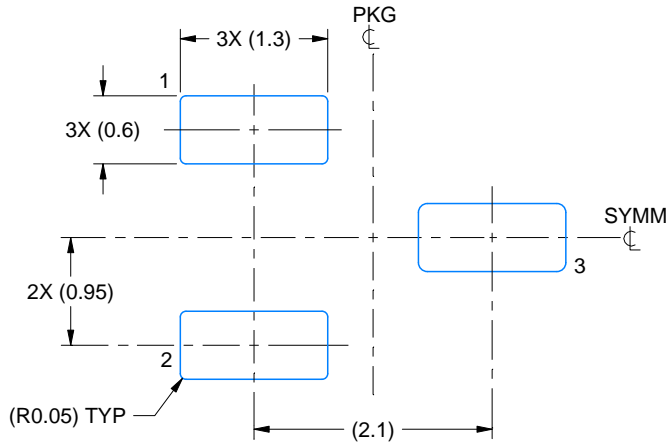

LAND PATTERN EXAMPLE  
SCALE:15X

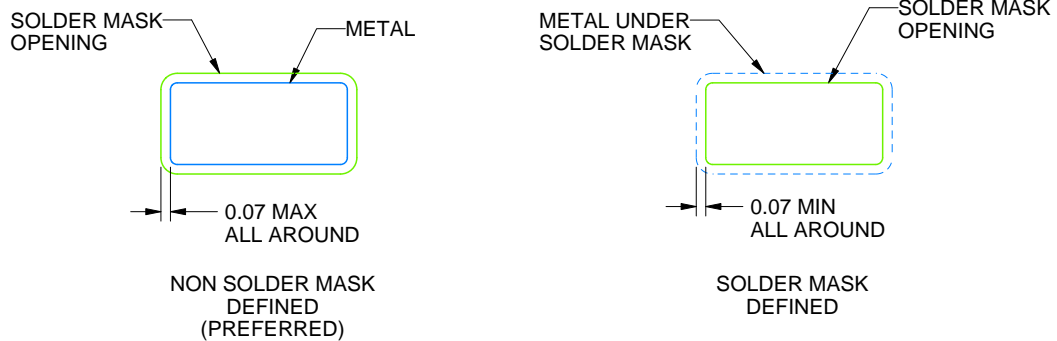

SOLDER MASK DETAILS

4214838/E 06/2024

NOTES: (continued)

5. Publication IPC-7351 may have alternate designs.
6. Solder mask tolerances between and around signal pads can vary based on board fabrication site.

# EXAMPLE STENCIL DESIGN

DBZ0003A

SOT-23 - 1.12 mm max height

SMALL OUTLINE TRANSISTOR

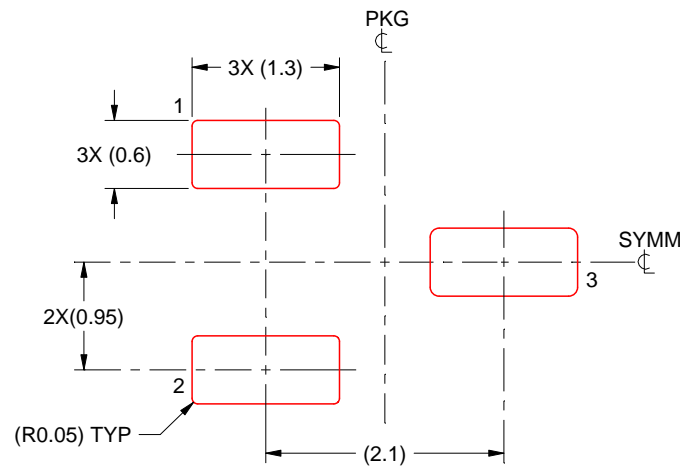

SOLDER PASTE EXAMPLE  
BASED ON 0.125 THICK STENCIL  
SCALE:15X

4214838/E 06/2024

NOTES: (continued)

7. Laser cutting apertures with trapezoidal walls and rounded corners may offer better paste release. IPC-7525 may have alternate design recommendations.
8. Board assembly site may have different recommendations for stencil design.

## GENERIC PACKAGE VIEW

**DMR 4**

**X2SON - 0.4 mm max height**

1.1 x 1.4, 0.5 mm pitch

PLASTIC SMALL OUTLINE - NO LEAD

This image is a representation of the package family, actual package may vary.  
Refer to the product data sheet for package details.



4229480/A

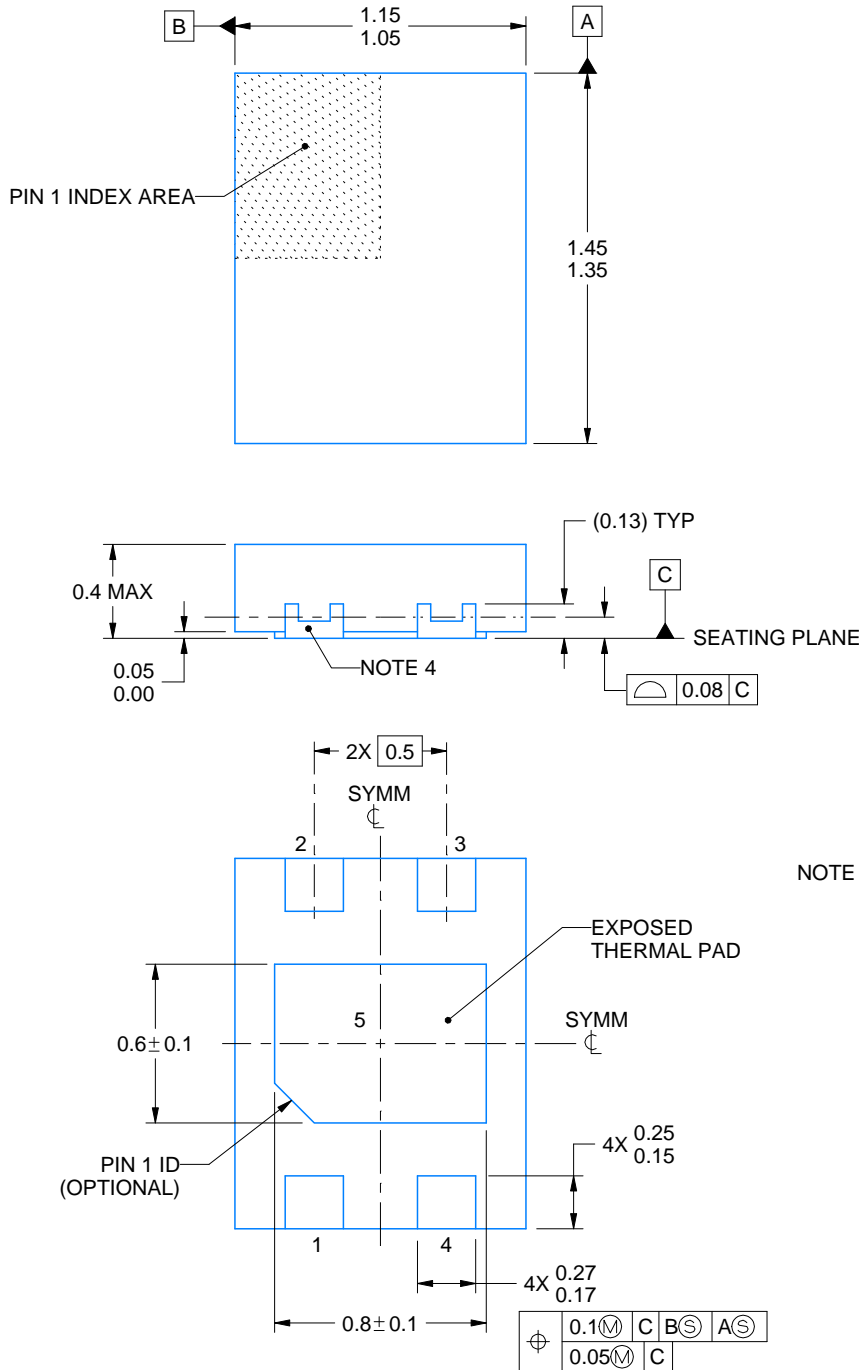
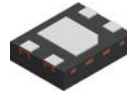

4222825/B 05/2022

NOTES:

1. All linear dimensions are in millimeters. Any dimensions in parenthesis are for reference only. Dimensioning and tolerancing per ASME Y14.5M.
2. This drawing is subject to change without notice.
3. The package thermal pad must be soldered to the printed circuit board for thermal and mechanical performance.
4. Quantity and shape of side wall metal may vary.

# EXAMPLE BOARD LAYOUT

DMR0004A

X2SON - 0.4 mm max height

PLASTIC SMALL OUTLINE - NO LEAD

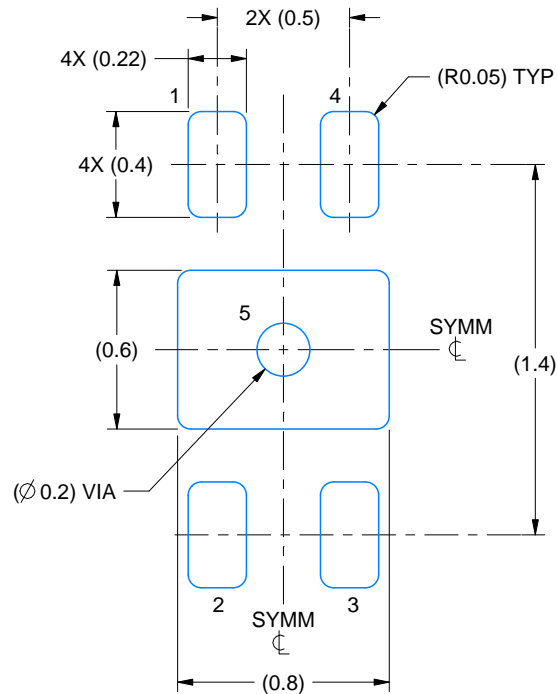

LAND PATTERN EXAMPLE  
SCALE:35X

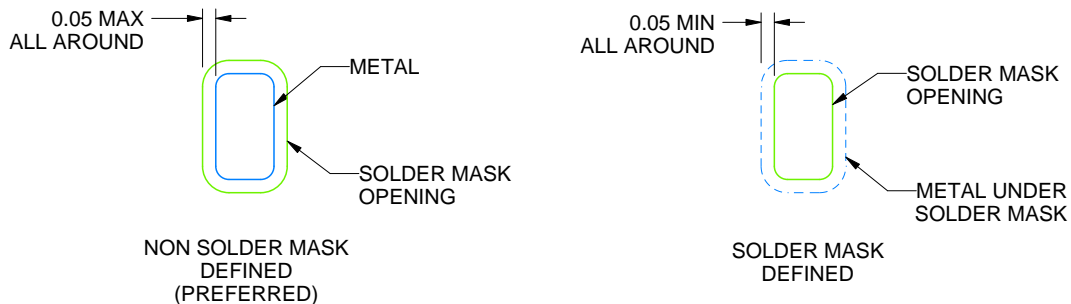

SOLDER MASK DETAILS

4222825/B 05/2022

NOTES: (continued)

5. This package is designed to be soldered to a thermal pad on the board. For more information, see Texas Instruments literature number SLUA271 ([www.ti.com/lit/slua271](http://www.ti.com/lit/slua271)).
6. Vias are optional depending on application, refer to device data sheet. If all or some are implemented, recommended via locations are shown. It is recommended that vias under paste be filled, plugged or tented.

# EXAMPLE STENCIL DESIGN

DMR0004A

X2SON - 0.4 mm max height

PLASTIC SMALL OUTLINE - NO LEAD



SOLDER PASTE EXAMPLE  
BASED ON 0.1 mm THICK STENCIL

EXPOSED PAD 5:  
90% PRINTED SOLDER COVERAGE BY AREA  
SCALE:50X

4222825/B 05/2022

NOTES: (continued)

7. Laser cutting apertures with trapezoidal walls and rounded corners may offer better paste release. IPC-7525 may have alternate design recommendations.



## IMPORTANT NOTICE AND DISCLAIMER

TI PROVIDES TECHNICAL AND RELIABILITY DATA (INCLUDING DATA SHEETS), DESIGN RESOURCES (INCLUDING REFERENCE DESIGNS), APPLICATION OR OTHER DESIGN ADVICE, WEB TOOLS, SAFETY INFORMATION, AND OTHER RESOURCES "AS IS" AND WITH ALL FAULTS, AND DISCLAIMS ALL WARRANTIES, EXPRESS AND IMPLIED, INCLUDING WITHOUT LIMITATION ANY IMPLIED WARRANTIES OF MERCHANTABILITY, FITNESS FOR A PARTICULAR PURPOSE OR NON-INFRINGEMENT OF THIRD PARTY INTELLECTUAL PROPERTY RIGHTS.

These resources are intended for skilled developers designing with TI products. You are solely responsible for (1) selecting the appropriate TI products for your application, (2) designing, validating and testing your application, and (3) ensuring your application meets applicable standards, and any other safety, security, regulatory or other requirements.

These resources are subject to change without notice. TI grants you permission to use these resources only for development of an application that uses the TI products described in the resource. Other reproduction and display of these resources is prohibited. No license is granted to any other TI intellectual property right or to any third party intellectual property right. TI disclaims responsibility for, and you will fully indemnify TI and its representatives against, any claims, damages, costs, losses, and liabilities arising out of your use of these resources.

TI's products are provided subject to [TI's Terms of Sale](#) or other applicable terms available either on [ti.com](https://www.ti.com) or provided in conjunction with such TI products. TI's provision of these resources does not expand or otherwise alter TI's applicable warranties or warranty disclaimers for TI products.

TI objects to and rejects any additional or different terms you may have proposed.

Mailing Address: Texas Instruments, Post Office Box 655303, Dallas, Texas 75265  
Copyright © 2024, Texas Instruments Incorporated