

TPS1641x 40-V, 1.8-A Power and Current Limiting eFuse with IN to OUT Short Detection

1 Features

- Operating voltage range (IN):
 - 4.5 V to 40 V (power limit devices)
 - 2.7 V to 40 V (current limit devices)
- Withstands negative voltages up to -1 V at output
- Ultra-low ON-resistance: $R_{ON} = 152$ m Ω (typ.)
- 2-W to 64-W power limiting
- 0.03-A to 1.8-A current limiting
- IN to OUT short detection and indication on \overline{FLT} pin
- \overline{FLT} output for diagnostics and driving external PFET
- $\pm 5\%$ accurate power limit at 15 W (power limit devices)
- $\pm 6\%$ accurate current limit at 1 A (current limit devices)
- Configurable overvoltage protection
- Configurable overcurrent protection (I_{OCP})
- Configurable blanking time for transient currents
- Overvoltage protection up to 60 V with external FET
- Adjustable output slew rate control (dVdt) for inrush current protection
- Enable and shutdown control
- Output load current monitoring on IOCP pin
- Overtemperature protection (OTP) with thermal shutdown
- Small footprint: QFN 3 × 3 mm, 0.5-mm pitch

2 Applications

- Refrigerator and freezer
- Oven
- Dishwasher
- HVAC valve and actuator control
- Ventilators
- Anesthesia delivery systems

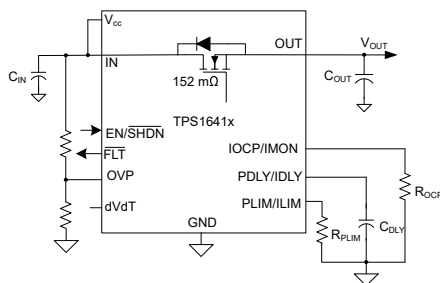

Simplified Schematic

3 Description

The TPS1641x family are integrated eFuse devices with accurate power limit or current limit. The device family provides robust protection with integrated overcurrent protection, overvoltage protection, IN to OUT short detection, and overtemperature protection.

TPS16410, TPS16411, TPS16414, and TPS16415 devices provide $\pm 5\%$ power limiting at 15 W for loads and it also provide configurable blanking time for transient overload or overcurrent events. TPS16410, TPS16411, TPS16414, and TPS16415 can be used in low power circuits (LPCs) for 15-W power limiting as per IEC60335 and UL60730 standards. TPS1641x devices provide protection from adjacent pin short and pin short to GND faults.

Applications such as backplane power protection in PLC and DCS modules configure the current limit with a resistor on the ILIM pin. TPS16412, TPS16413, TPS16416, and TPS16417 devices provide $\pm 6\%$ current limiting at 1 A for loads and also provide output slew rate control with dVdt pin to charge large capacitive loads at power up.

TPS1641x features IN to OUT short detection and indicate IN to OUT short on the \overline{FLT} pin. The \overline{FLT} pin either provides to MCU as digital input or to drive an external PFET.

The devices are characterized for operation over a junction temperature range of -40°C to $+125^{\circ}\text{C}$.

Package Information

PART NUMBER	PACKAGE ⁽¹⁾	BODY SIZE (NOM)
TPS1641x	VSON (10)	3.00 mm × 3.00 mm

- (1) For all available packages, see the orderable addendum at the end of the data sheet.

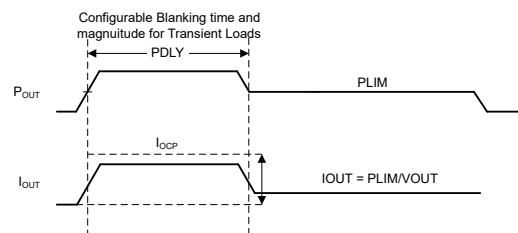

PDLY = Duration of Transient Load
 I_{OCP} = Maximum magnitude of Transient Load

Configurable Blanking Time for Transient Loads



Table of Contents

1 Features	1	8.4 Device Functional Modes.....	21
2 Applications	1	9 Application and Implementation	22
3 Description	1	9.1 Application Information.....	22
4 Revision History	2	9.2 Typical Application: 15-W Power Limiting for Low Power Circuits (LPCs).....	22
5 Device Comparison Table	3	9.3 System Examples.....	25
6 Pin Configuration and Functions	4	9.4 Best Design Practices.....	26
7 Specifications	5	9.5 Power Supply Recommendations.....	26
7.1 Absolute Maximum Ratings.....	5	9.6 Layout.....	27
7.2 ESD Ratings.....	5	10 Device and Documentation Support	29
7.3 Recommended Operating Conditions.....	5	10.1 Receiving Notification of Documentation Updates.....	29
7.4 Thermal Information.....	6	10.2 Support Resources.....	29
7.5 Electrical Characteristics.....	6	10.3 Trademarks.....	29
7.6 Timing Requirements.....	7	10.4 Electrostatic Discharge Caution.....	29
7.7 Typical Characteristics.....	9	10.5 Glossary.....	29
8 Detailed Description	12	11 Mechanical, Packaging, and Orderable Information	29
8.1 Overview.....	12		
8.2 Functional Block Diagram.....	12		
8.3 Feature Description.....	13		

4 Revision History

NOTE: Page numbers for previous revisions may differ from page numbers in the current version.

Changes from Revision A (December 2022) to Revision B (April 2023)	Page
• Added information for new device variants throughout the document.....	1
• Added recommendations for new device variants.....	19

Changes from Revision * (June 2022) to Revision A (December 2022)	Page
• Changed device status from <i>Advance Information</i> to <i>Production Data</i>	1

5 Device Comparison Table

Part Number	Power or Current Limit	Fault Behavior	IN-OUT Short Detection
TPS16410	Power limit	Auto-retry	Y
TPS16411	Power limit	Latch-off	Y
TPS16412	Current limit	Auto-retry	Y
TPS16413	Current limit	Latch-off	Y
TPS16414	Power limit	Auto-retry	N
TPS16415	Power limit	Latch-off	N
TPS16416	Current limit	Auto-retry	N
TPS16417	Current limit	Latch-off	N

See [IN to OUT Short Detection \(TPS16410, TPS16411, TPS16412, and TPS16413\)](#) section for recommended device variants.

6 Pin Configuration and Functions

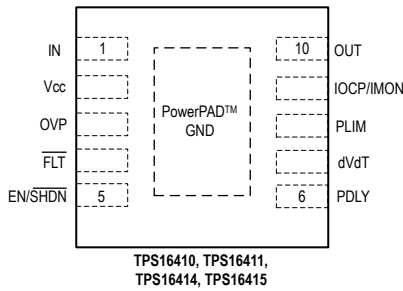

Figure 6-1. TPS16410, TPS16411, TPS16414 and TPS16415 10-Pin DRC VSON Package (Top View)

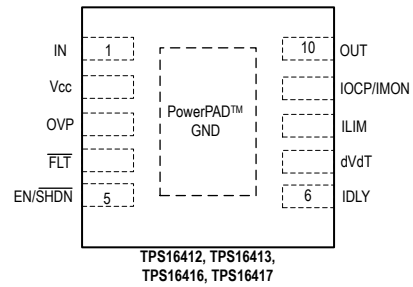

Figure 6-2. TPS16412, TPS16413, TPS16416 and TPS16417 10-Pin DRC VSON Package (Top View)

Table 6-1. Pin Functions

PIN		I/O ⁽¹⁾	DESCRIPTION
NAME	NO.		
IN	1	P	Power input for internal FET.
V _{cc}	2	P	Supply input for internal circuits of the device.
OVP	3	I	Overvoltage protection input. This pin can be connected to GND for disabling OVP.
FLT	4	O	Active low fault output. See the FLT Pin Indication for Different Events section for different FLT pin indications.
EN/SHDN	5	I	Enable or shutdown input.
PDLY	6	I/O	TPS16410, TPS16411: Input for blanking time for power limiting. Connect a capacitor to set PDLY blanking time.
IDLY			TPS16412, TPS16413: Input for blanking time for current limiting. Connect a capacitor to set IDLY blanking time.
dVdT	7	I/O	Output slew control input. Connect a capacitor to set the output slew rate. If not used, this pin can be left open.
PLIM	8	I/O	TPS16410, TPS16411: Power limit input. Connect a resistor to set PLIM setpoint.
ILIM			TPS16412, TPS16413: Current limit input. Connect a resistor to set ILIM setpoint.
IOCP/IMON	9	I/O	Overcurrent protection input and current monitoring output for output current. Output current can be sensed by reading voltage on this pin. Connect a resistor to set IOCP set-point and for reading output current.
OUT	10	P	Power output from internal FET.
PowerPAD/GND	—	G	GND connection for the device. PowerPAD™ must be connected to GND of input power supply. Connect PowerPAD to GND plane on PCB using multiple vias for enhanced thermal performance.

(1) I = Input, O = Output, I/O = Input or Output, G = Ground, P = Power

7 Specifications

7.1 Absolute Maximum Ratings

over operating free-air temperature range (unless otherwise noted)⁽¹⁾

		MIN	MAX	UNIT
V _{oc, FLT}	Input Voltage	-0.3	67	V
OVP	Input Voltage	-0.3	62	V
IN, IN-OUT, IOCP	Input Voltage	-0.3	42	V
OUT	Input Voltage	-1	42	V
EN/SHDN, PDLY/IDLY	Input Voltage	-0.3	5.5	V
dVdT, PLIM/ILIM	Input Voltage	-0.3	5.5	V
I _{IOCP} , I _{PDLY} , I _{PLIM} , I _{dVdT} , I _{ILIM}	Source Current	Internally Limited		
T _J	Junction temperature	-40	150	°C
	Transient Junction Temperature	-40	T _{TSD}	°C
T _{stg}	Storage temperature	-65	150	°C

- (1) Operation outside the Absolute Maximum Ratings may cause permanent device damage. Absolute Maximum Ratings do not imply functional operation of the device at these or any other conditions beyond those listed under Recommended Operating Conditions. If used outside the Recommended Operating Conditions but within the Absolute Maximum Ratings, the device may not be fully functional, and this may affect device reliability, functionality, performance, and shorten the device lifetime.

7.2 ESD Ratings

		VALUE	UNIT
V _(ESD)	Electrostatic discharge	Human body model (HBM), per ANSI/ESDA/ JEDEC JS-001, all pins ⁽¹⁾	±1500
		Charged device model (CDM), per JEDEC specification JS-002, all pins ⁽²⁾	±500

- (1) JEDEC document JEP155 states that 500-V HBM allows safe manufacturing with a standard ESD control process.
(2) JEDEC document JEP157 states that 250-V CDM allows safe manufacturing with a standard ESD control process.

7.3 Recommended Operating Conditions

over operating free-air temperature range (unless otherwise noted)

		MIN	NOM	MAX	UNIT
V _{cc}	Supply voltage	V _{IN}		60	V
FLT	Input Voltage	0		60	V
IN	Input Voltage (TPS16410, TPS16411, TPS16414, TPS16415)	4.5		40	V
IN	Input Voltage (TPS16412, TPS16413, TPS16416, TPS16417)	2.7		40	V
OUT	Input Voltage	0		40	V
EN/SHDN, OVP	Input Voltage	0		5.5	V
PDLY/IDLY	External capacitor	0.012		10	μF
dVdT	External capacitor	0.01		5	μF
IOCP	External resistor	6.34		80.6	kΩ
PLIM	External resistor	12.4		412	kΩ
ILIM	External resistor	5.1		348	kΩ
T _J	Junction temperature	-40		125	°C

7.4 Thermal Information

THERMAL METRIC ⁽¹⁾		TPS1641	UNIT
		DRC (VSON)	
		10 PINS	
R _{θJA}	Junction-to-ambient thermal resistance	43.7	°C/W
R _{θJC(top)}	Junction-to-case (top) thermal resistance	50.0	°C/W
R _{θJB}	Junction-to-board thermal resistance	15.8	°C/W
Ψ _{JT}	Junction-to-top characterization parameter	1.1	°C/W
Ψ _{JB}	Junction-to-board characterization parameter	15.8	°C/W
R _{θJC(bot)}	Junction-to-case (bottom) thermal resistance	2.1	°C/W

(1) For more information about traditional and new thermal metrics, see the [Semiconductor and IC Package Thermal Metrics](#) application report.

7.5 Electrical Characteristics

–40°C ≤ T_A = T_J ≤ +125°C, V_{IN} = 3 V to 40 V (TPS16412, TPS16413, TPS16416, TPS16417), V_{IN} = 4.5 V to 40 V (TPS16410, TPS16411, TPS16414, TPS16415), V_{CC} = V_{IN}, R_{ILIM} = 5.49 kΩ R_{PLIM} = 255 kΩ R_{IOCP} = 7.32 kΩ, $\overline{\text{FLT}}$ = Open, C_{OUT} = 100 nF, C_{IN} = 10 nF C_{dVdT} = Open, PDLY/IDLY = Open., EN/SHDN = Open
(All voltages referenced to GND, (unless otherwise noted))

PARAMETER		TEST CONDITIONS	MIN	TYP	MAX	UNIT
OPERATING INPUT AND SUPPLY VOLTAGE						
V _{CC}	Operating Supply voltage		V _{IN}		60	V
V _{IN}	Operating Input voltage	TPS16410, TPS16411, TPS16414, TPS16415	4.5		40	V
V _{IN}	Operating Input voltage	TPS16412, TPS16413, TPS16416, TPS16417	2.7		40	V
I _Q	Operating Supply current (V _{CC})	EN/SHDN = 2 V, V _{CC} = 40 V, V _{IN} = Open, R _{ILIM} or R _{PLIM} = Open		1.2	2.1	mA
I _{QSD}	Shutdown Supply current (V _{CC})	EN/SHDN = GND, V _{CC} = 40 V, V _{IN} = Open, R _{ILIM} or R _{PLIM} = Open, R _{IOCP} = Open		14	36	μA
I _{INLKG}	IN Leakage Current in ON State	EN/SHDN = 2 V, V _{IN} = V _{CC} = 40 V, Open, R _{ILIM} or R _{PLIM} = Open		0.025	0.52	mA
I _{INLKG-SD}	IN Leakage Current in Shutdown	EN/SHDN = GND, V _{IN} = V _{CC} = 40 V, R _{ILIM} or R _{PLIM} = Open, R _{IOCP} = Open		0.7	2.8	μA
OVER-VOLTAGE PROTECTION (OVP) INPUT						
V _{OVP}	OVP rising threshold		1.48	1.53	1.58	V
V _{OVPF}	OVP falling threshold		1.34	1.40	1.46	V
I _{OVP}	OVP leakage current	0 V ≤ V _{OVP} ≤ 4 V	–350	–265	–200	nA
EN/SHDN INPUT						
V _{ENR}	Enable rising threshold				1.2	V
V _{ENF}	Enable falling threshold		0.59			V
I _{EN}	Enable leakage current	0 V ≤ V _{EN} ≤ 4 V	–10			μA
V _{EN-Open}	Open circuit Enable Voltage	I _{EN} = 0.1 μA, V _{CC} ≥ 5 V		4.9		V
OUTPUT POWER LIMITING (PLIM)						
P _{OUT}	Output Power Limit	R _{PLIM} = 26.7 kΩ	3	3.66	4.5	W
P _{OUT}	Output Power Limit	R _{PLIM} = 95.3 kΩ, –40°C ≤ T _A ≤ +85°C	12.94	13.69	14.44	W
P _{OUT}	Output Power Limit	R _{PLIM} = 255 kΩ, –40°C ≤ T _A ≤ +85°C	34	37	39.8	W
OUTPUT CURRENT LIMITING (ILIM)						
I _{OUT}	Output Current Limit	R _{ILIM} = 332 kΩ	0.024	0.032	0.039	A

7.5 Electrical Characteristics (continued)

$-40^{\circ}\text{C} \leq T_A = T_J \leq +125^{\circ}\text{C}$, $V_{IN} = 3\text{ V to } 40\text{ V}$ (TPS16412, TPS16413, TPS16416, TPS16417), $V_{IN} = 4.5\text{ V to } 40\text{ V}$ (TPS16410, TPS16411, TPS16414, TPS16415), $V_{CC} = V_{IN}$, $R_{ILIM} = 5.49\text{ k}\Omega$, $R_{PLIM} = 255\text{ k}\Omega$, $R_{IOCP} = 7.32\text{ k}\Omega$, $\overline{\text{FLT}} = \text{Open}$, $C_{OUT} = 100\text{ nF}$, $C_{IN} = 10\text{ nF}$, $C_{dVdT} = \text{Open}$, $\text{PDLY}/\text{IDLY} = \text{Open}$, $\text{EN}/\overline{\text{SHDN}} = \text{Open}$
(All voltages referenced to GND, (unless otherwise noted))

PARAMETER		TEST CONDITIONS	MIN	TYP	MAX	UNIT
I_{OUT}	Output Current Limit	$R_{ILIM} = 10\text{ k}\Omega$, $-40^{\circ}\text{C} \leq T_A \leq +85^{\circ}\text{C}$	0.918	0.987	1.035	A
I_{OUT}	Output Current Limit	$R_{ILIM} = 5.49\text{ k}\Omega$, $-40^{\circ}\text{C} \leq T_A \leq +85^{\circ}\text{C}$	1.671	1.77	1.881	A
POWER OUTPUT (OUT)						
R_{ON}	IN to OUT On resistance	$-40^{\circ}\text{C} \leq T_J \leq 125^{\circ}\text{C}$	96	153	260	m Ω
R_{ON}	IN to OUT On resistance	$0^{\circ}\text{C} \leq T_J \leq 85^{\circ}\text{C}$		153	215	m Ω
R_{ON}	IN to OUT On resistance	$T_J = 25^{\circ}\text{C}$		153	160	m Ω
$I_{LKG-OUT}$	Output Leakage current in OFF state	$V_{IN} = 40\text{ V}$, $V_{OUT} = 0\text{ V}$, $\text{EN} = \text{Low}$	-15	-1.2		μA
CURRENT MONITORING OUTPUT (IMON)						
G_{IMON}	Gain : I_{MON}/I_{OUT}	$I_{OUT} = 0.05\text{ to } 1.8\text{ A}$	45	50	55	$\mu\text{A/A}$
OS_{IMON}	I_{MON} Offset current	$I_{OUT} = 0.3\text{ to } 0.8\text{ A}$	-0.8	0.05	0.8	μA
OVER CURRENT PROTECTION (IOCP) AND SHORT CIRCUIT PROTECTION (ISCP)						
I_{OCP}	Over curret protection set-point	$R_{IOCP} = 7.32\text{ k}\Omega$	2.11	2.23	2.35	A
I_{OCP}	Over curret protection set-point	$R_{IOCP} = 16.2\text{ k}\Omega$	0.95	1.01	1.07	A
$I_{Fastrip}$	Fast Trip protection threshold			$1.9 \times I_{OCP}$		A
I_{SCP}	Short circuit protection threshold			6.7		A
$I_{LIM-Internal}$	Internal Current Limit	TPS16410, TPS16411, TPS16414, TPS16415		$0.81 \times I_{OCP}$		A
THERMAL PROTECTION and SHUTDOWN (TTSD)						
T_{TSD}	Thermal shutdown temperature			155		$^{\circ}\text{C}$
$T_{TSD-hyst}$	Thermal shutdown temperature hysteresis			12		$^{\circ}\text{C}$
Output slew rate control (dVdT)						
I_{dVdT}	dVdT charging current		1.78	2	2.23	μA
G_{dVdT}	dVdT Gain			50		V/V
FLT Output (FLTb) (Open Drain Output)						
R_{FLTb}	Fault pin pull down resistance			73		Ω
$I_{FLTb-LKG}$	Fault pin leakage current	$\overline{\text{FLT}}$ is High, $V_{FLT} \leq 25\text{ V}$	-1	0.005	1	μA
IN to OUT Short Detection (TPS16410, TPS16411, TPS16412, TPS16413)						
R_{short}	Resistance for IN to OUT short detection				30	m Ω

7.6 Timing Requirements

$-40^{\circ}\text{C} \leq T_A = T_J \leq +125^{\circ}\text{C}$, $V_{IN} = 3\text{ V to } 40\text{ V}$ (TPS16412, TPS16413), $V_{IN} = 4.5\text{ V to } 40\text{ V}$ (TPS16410, TPS16411), $V_{CC} = V_{IN}$, $V_{EN} = 2\text{ V}$, $R_{ILIM} = 5.49\text{ k}\Omega$, $R_{PLIM} = 255\text{ k}\Omega$, $R_{IOCP} = 7.32\text{ k}\Omega$, $\text{FLT} = \text{Open}$, $C_{OUT} = 100\text{ nF}$, $C_{IN} = 10\text{ nF}$, $C_{dVdT} = \text{Open}$, $\text{PDLY} = \text{Open}$.

(All voltages referenced to GND, (unless otherwise noted))

PARAMETER		TEST CONDITIONS	MIN	TYP	MAX	UNIT
Enable/SHDN and Vcc Input						
t_{ON_DLY}	Turn on delay with V_{CC}	$V_{EN} = V_{ENR} + 0.1\text{ V}$, $R_{LOAD} = \text{Open}$		500		μs
$t_{EN_ON_DLY}$	Enable on delay	Fast turn-on with Enable when device is not in shutdown, $V_{EN} = V_{ENR} + 0.1\text{ V}$, $R_{LOAD} = \text{Open}$		270		μs
$t_{EN_OFF_DLY}$	Enable off delay	$V_{EN} < V_{ENF}$ to $V_{OUT} = 0.9 \times V_{IN}$, $R_{LOAD} = 100$		1.2		μs

7.6 Timing Requirements (continued)

$-40^{\circ}\text{C} \leq T_A = T_J \leq +125^{\circ}\text{C}$, $V_{IN} = 3\text{ V to } 40\text{ V}$ (TPS16412, TPS16413), $V_{IN} = 4.5\text{ V to } 40\text{ V}$ (TPS16410, TPS16411), $V_{CC} = V_{IN}$, $V_{EN} = 2\text{ V}$, $R_{ILIM} = 5.49\text{ k}\Omega$, $R_{PLIM} = 255\text{ k}\Omega$, $R_{IOCP} = 7.32\text{ k}\Omega$, $\text{FLT} = \text{Open}$, $C_{OUT} = 100\text{ nF}$, $C_{IN} = 10\text{ nF}$, $C_{dVdT} = \text{Open}$, $\text{PDLY} = \text{Open}$.

(All voltages referenced to GND, (unless otherwise noted))

PARAMETER		TEST CONDITIONS	MIN	TYP	MAX	UNIT
$t_{\text{LOW_SHDN}}$	Min low pulse for entering shutdown	$R_{\text{LOAD}} = 100$	24			ms
OVP Input						
$t_{\text{OVP_ENTRY_DLY}}$	OVP entry delay	$V_{\text{OVP}} = V_{\text{OVPR}} + 25\text{ mV to } \overline{\text{FLT}} \text{ Low}$		0.75		μs
$t_{\text{OVP_EXIT_DLY}}$	OVP exit delay	$V_{\text{OVP}} = V_{\text{OVPF}} - 25\text{ mV to } \overline{\text{FLT}} \text{ High}$		0.6		μs
Over Current Protection and Short-circuit protection						
$t_{\text{FASTTRIP_DLY}}$	Fast Trip protection delay	$I_{\text{FASTTRIP}} < I_{\text{OUT}} < I_{\text{SCP}} \text{ to FET OFF}$		5.65		μs
$t_{\text{SCP_DLY}}$	Short-Circuit protection delay	$I_{\text{OUT}} = I_{\text{SCP}} + 500\text{ mA to FET OFF}$		280		ns
Power Limiting						
t_{PDLY}	Blanking time before power limiting	$I_{\text{OUT}} < I_{\text{OCP}}$, $P_{\text{OUT}} = 1.2 \times \text{PLIM}$, $\text{CDLY} = 12\text{ nF}$		6.5		ms
$t_{\text{PLIM-RES}}$	Power Limit response time	$I_{\text{OUT}} < I_{\text{OCP}}$, $I_{\text{OUT}} = 1.2 \times \text{ILIM}$, $\text{CDLY} = \text{OPEN}$		215		μs
$t_{\text{PLIM-DUR}}$	PowerLimit Duration			2 x t_{PDLY}		s
Current Limiting						
t_{IDLY}	Blanking time before current limiting	$I_{\text{OUT}} < I_{\text{OCP}}$, $I_{\text{OUT}} = 1.2 \times \text{ILIM}$, $\text{CDLY} = 12\text{ nF}$		6.5		ms
$t_{\text{ILIM-RES}}$	Current Limit response time	$I_{\text{OUT}} < I_{\text{OCP}}$, $I_{\text{OUT}} = 1.2 \times \text{ILIM}$, $\text{CDLY} = \text{OPEN}$		280		μs
$t_{\text{ILIM-DUR}}$	Current Limit Duration			2 x t_{PDLY}		s
Auto-Retry and Thermal Shutdown						
t_{RETRY}	Retry Delay			8 x t_{PDLY}		s
Output Ramp Control (dVdT)						
t_{dVdT}	Output Ramp Time	$C_{\text{dVdT}} = \text{Open}$, $V_{\text{IN}} = V_{\text{CC}} = 24\text{ V}$		105		μs
IN to OUT Short (TPS16410, TPS16411, TPS16412, TPS16413) and FLT Output						
$t_{\text{IN_OUT_Short_Detect}}$	IN to OUT short detection time when FET is ON	IN-OUT Short to FLT Low		135		ms
$t_{\text{IN_OUT_Short_Detect}}$	IN to OUT short detection time when FET is OFF	IN-OUT Short to FLT Low		20		ms

7.7 Typical Characteristics

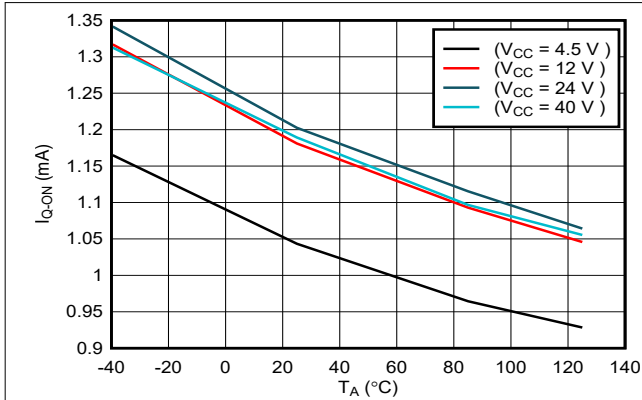

Figure 7-1. I_{Q-ON} vs Temperature

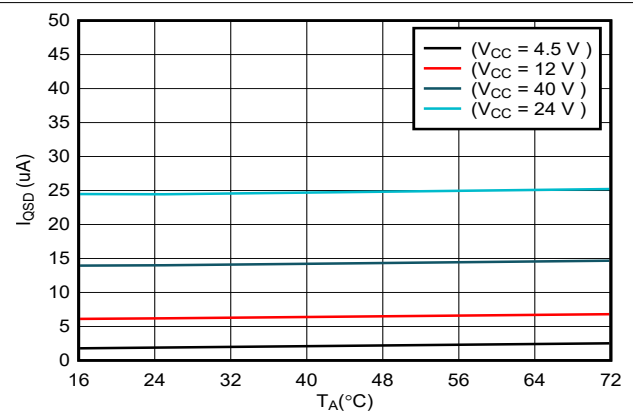

Figure 7-2. I_{QSD} vs Temperature

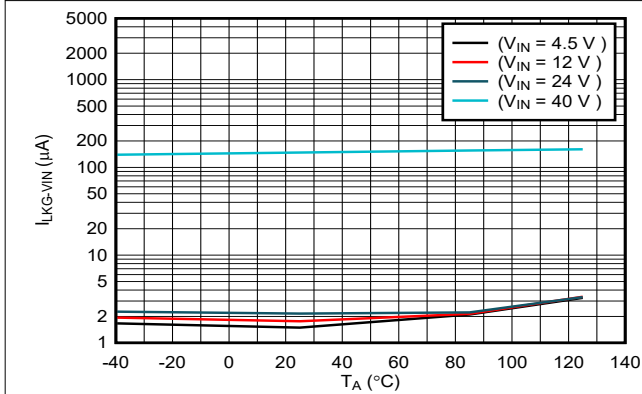

Figure 7-3. $I_{LKG-VIN}$ vs Temperature

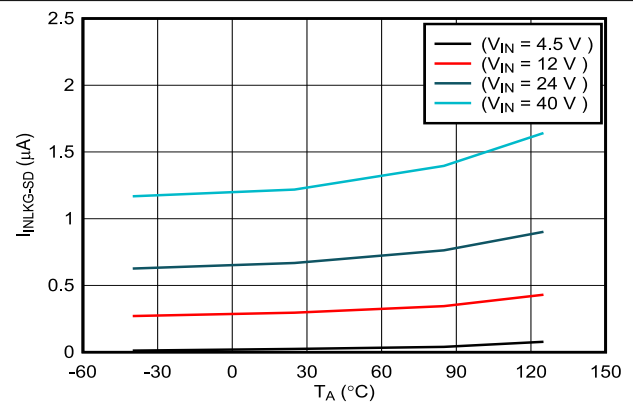

Figure 7-4. $I_{LKG-VIN-SD}$ vs Temperature

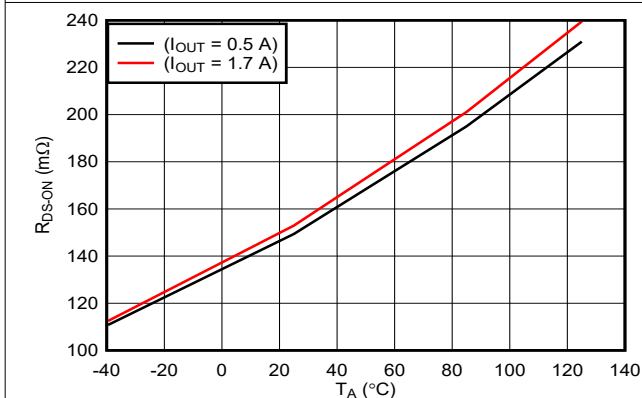

Figure 7-5. R_{DS-ON} vs Temperature

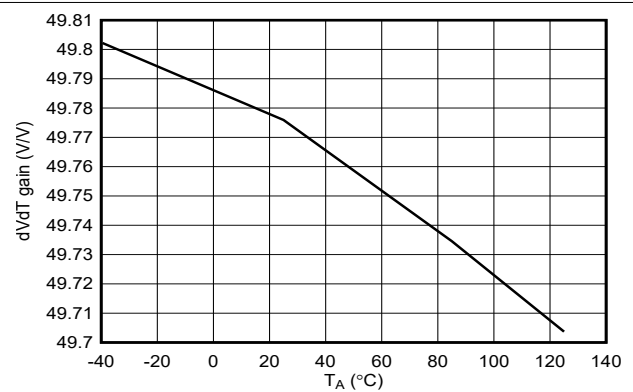

Figure 7-6. G_{dVdT} vs Temperature

7.7 Typical Characteristics (continued)

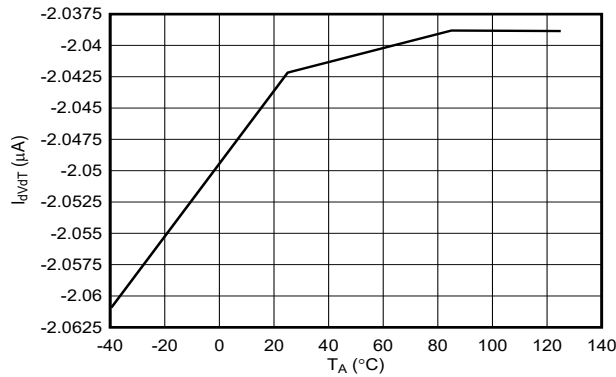

Figure 7-7. I_{qvdt} vs Temperature

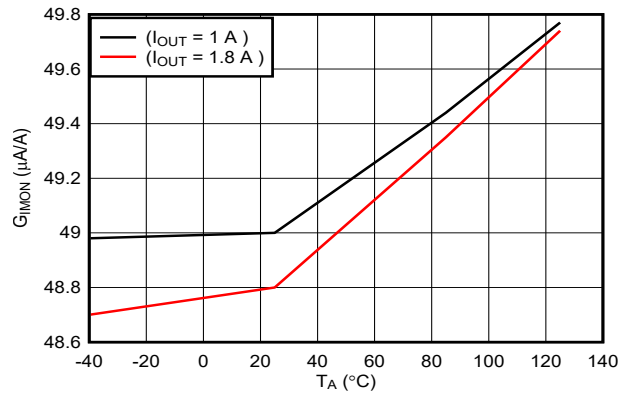

Figure 7-8. G_{IMON} vs Temperature

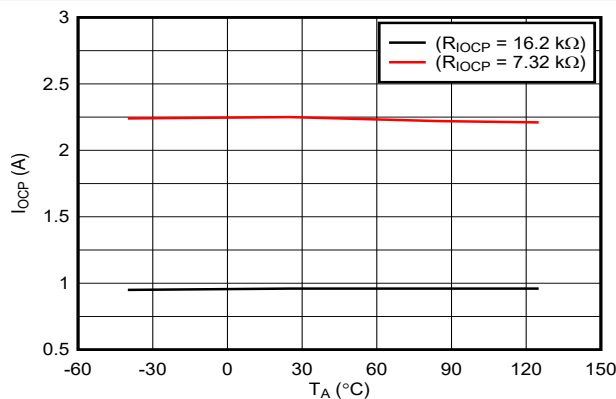

Figure 7-9. I_{OCP} vs Temperature

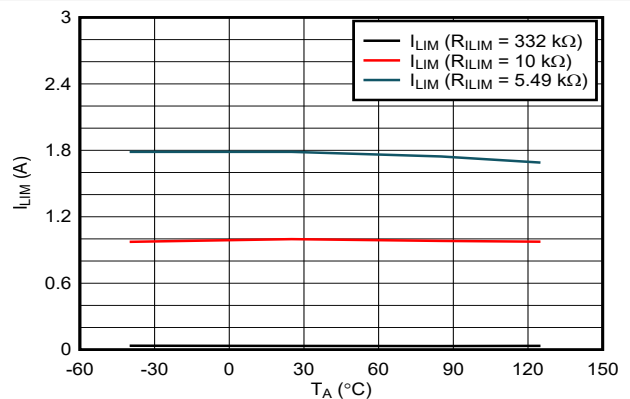

Figure 7-10. Output Current Limit vs Temperature for TPS16412 and TPS16413

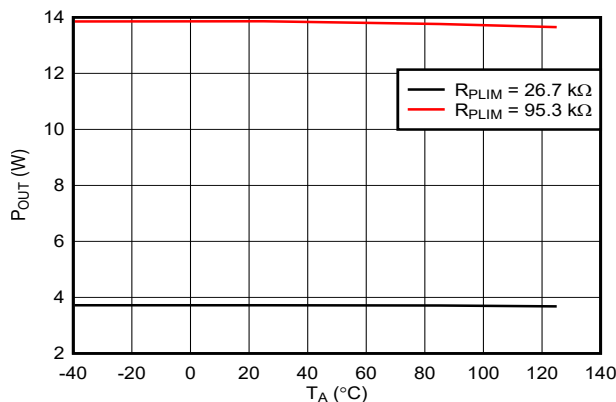

Figure 7-11. Output Power Limit vs Temperature for TPS16410 and TPS16411 with $V_{IN} = 12\text{ V}$

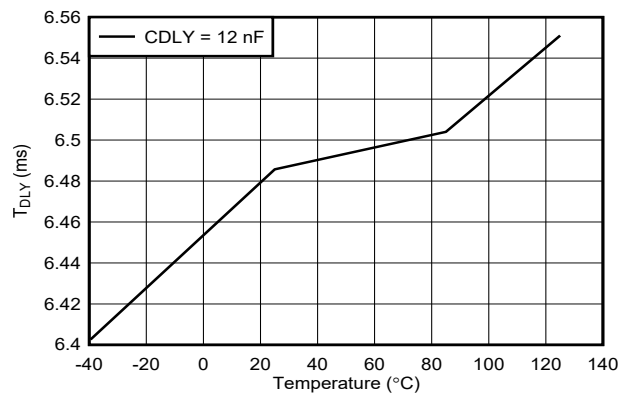

Figure 7-12. T_{DLY} vs Temperature

7.7 Typical Characteristics (continued)

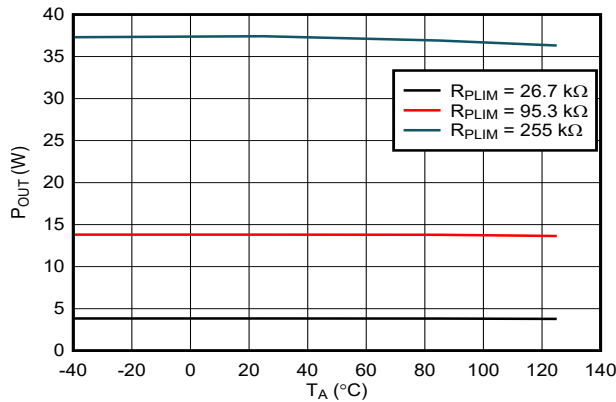

Figure 7-13. Output Power Limit vs Temperature for TPS16410 and TPS16411 with $V_{IN} = 24\text{ V}$

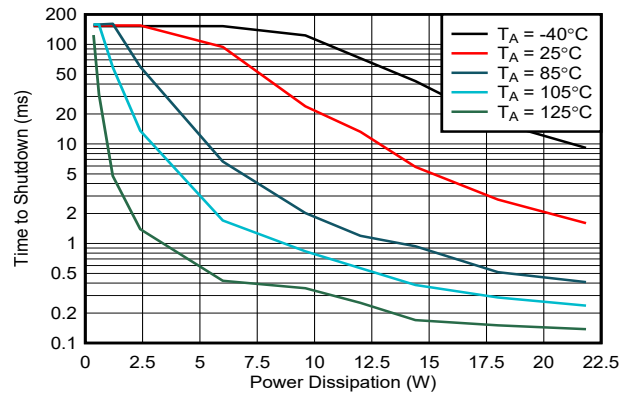

Figure 7-14. Thermal Shutdown Time vs Power Dissipation with $V_{IN} = 12\text{ V}$

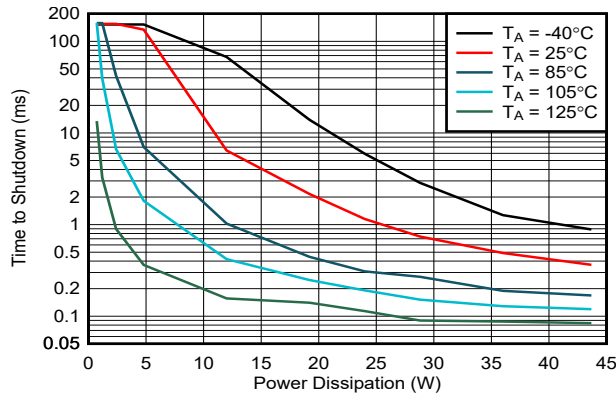

Figure 7-15. Thermal Shutdown Time vs Power Dissipation with $V_{IN} = 24\text{ V}$

8 Detailed Description

8.1 Overview

The TPS1641x is an integrated eFuse with accurate power limit or current limit. The device integrates an NFET with R_{ON} of 152 m Ω . TPS16410, TPS16411, TPS16414 and TPS16415 provide power limiting whereas the TPS16412, TPS16413, TPS16416 and TPS16417 provide current limiting. The TPS16410, TPS16411, TPS16414 and TPS16415 can provide 15-W accurate power limiting for low power circuit (LPCs) as per IEC60335 and UL60730 standards. TPS16410, TPS16411, TPS16412 and TPS16413 also provide IN to OUT short detection and its indication on \overline{FLT} output. IN to OUT short detection eliminates the need of additional eFuse or power limiting circuit in case of IN to OUT short test for IEC60335, UL60730, and similar standards. \overline{FLT} can be used as input for MCU or it can be used to drive an external PFET. TPS1641x devices also provide protection from adjacent pin short and pin short to GND faults.

The TPS1641x device also provide configurable blanking time (IDLY or PDLY) and overcurrent protection (IOCP) for transient loads. Load such as motors need higher current for start-up. Blanking time is useful for providing higher current for start-up of loads such as motors.

TPS1641x devices have overvoltage protection (OVP), overtemperature protection, and adjustable output slew rate control (dvd). V_{CC} and \overline{FLT} are rated up to 60 V and can provide protection up to 60 V with an external PFET.

8.2 Functional Block Diagram

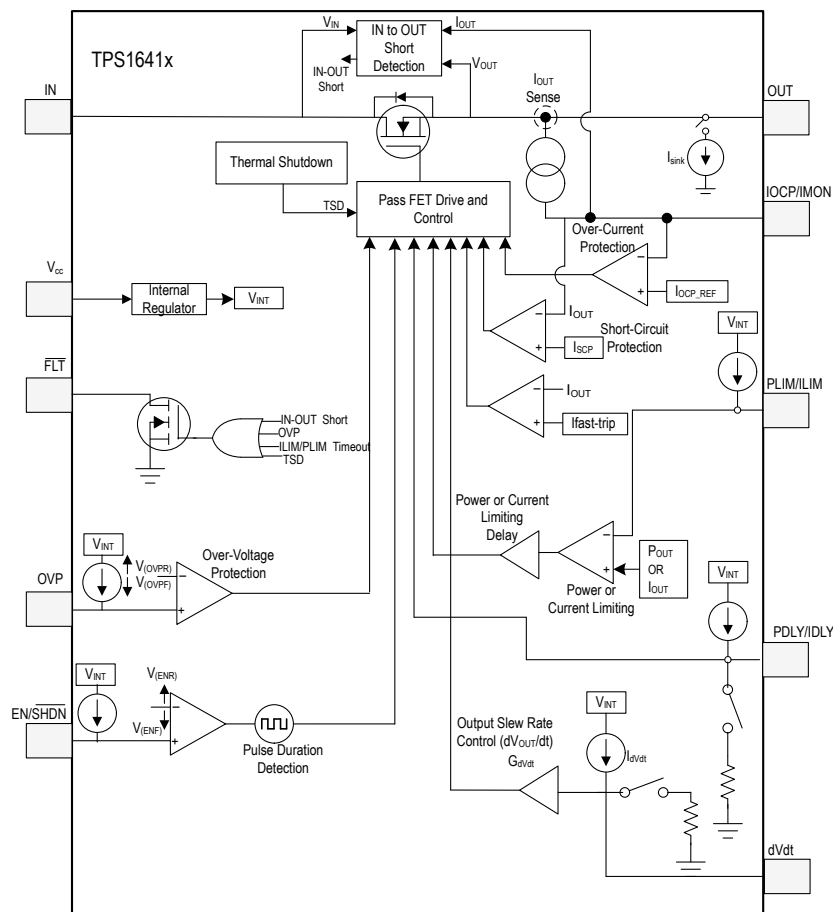

8.3 Feature Description

8.3.1 Enable and Shutdown Input (EN/ $\overline{\text{SHDN}}$)

The TPS1641x devices include a enable and shutdown input. Keeping EN/ $\overline{\text{SHDN}}$ low for a duration more than $t_{\text{Low_SHDN}}$ brings the device into low power shutdown mode, internal blocks of device are turned off, and the quiescent current of the device is reduced to I_{QSD} from V_{CC} supply.

While keeping EN/ $\overline{\text{SHDN}}$ low for a duration less than $t_{\text{Low_SHDN}}$, the device turns off the internal FET only and FET can be turned back on quickly. The device turns off the internal FET with a delay of $t_{\text{EN_OFF_dly}}$ as the enable pin is brought low. The internal FET can be enabled quickly with a delay of $t_{\text{EN_ON_dly}}$ when the device is not in shutdown. See the [Section 7.5](#) for V_{ENR} and V_{ENF} thresholds and the [Section 7.6](#) for $t_{\text{Low_SHDN}}$, $t_{\text{EN_OFF_dly}}$, and $t_{\text{EN_ON_dly}}$ timings. A PWM signal with low period less than $t_{\text{Low_SHDN}}$ can be provided on EN/ $\overline{\text{SHDN}}$ pin of the device for fast turn-on and turn-off of internal FET. [Figure 8-1](#) illustrates the EN/ $\overline{\text{SHDN}}$ input in the TPS1641x devices. [Figure 8-2](#) shows the start-up of the device with enable input.

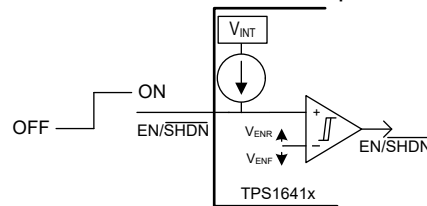
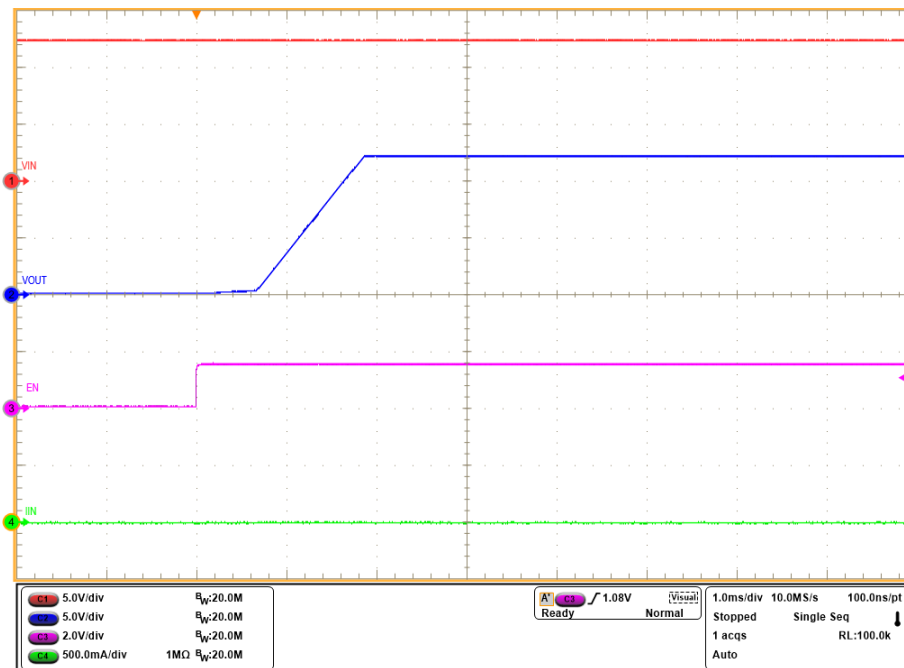

Figure 8-1. EN/ $\overline{\text{SHDN}}$ in TPS1641x Devices



$V_{\text{IN}} = 12 \text{ V}$

Figure 8-2. Turn-On with Enable

8.3.2 Overvoltage Protection (OVP)

The TPS1641x implements overvoltage protection to protect the load from input overvoltage conditions. A resistor divider can be connected from the IN pin of device to configure the overvoltage protection setpoint. The device turns off the internal FET and asserts the $\overline{\text{FLT}}$ pin as the voltage at OVP pin goes above V_{OVPR} , and as the OVP pin voltage falls below V_{OVPF} , the internal FET is turned ON and $\overline{\text{FLT}}$ pin is de-asserted. See the [Section 7.5](#) table for V_{OVPF} and V_{OVPR} and [Section 7.6](#) for $t_{\text{OVP_entry_dly}}$ and $t_{\text{OVP_exit_dly}}$ timings for overvoltage

protection input. Figure 8-3 illustrates the OVP input in TPS1641x devices. Figure 8-4 shows the overvoltage response.

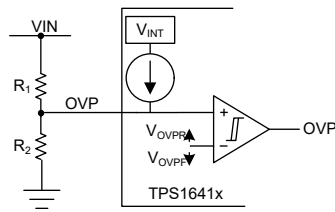

Figure 8-3. OVP Input in TPS1641x

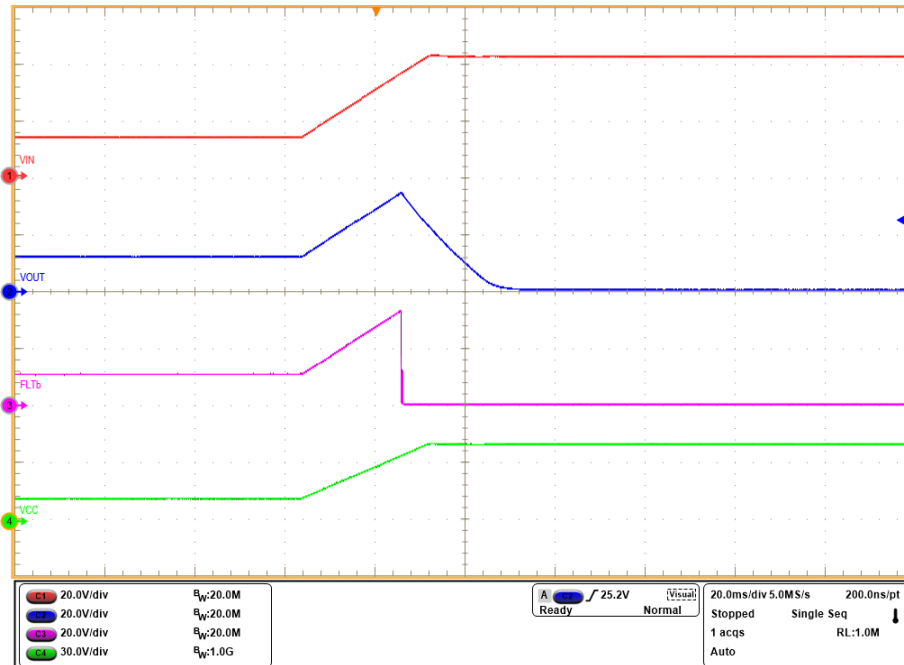

Figure 8-4. Overvoltage Protection Response for IN Voltage 12 V to 40 V

V_{CC} and \overline{FLT} pins of the device are rated up to 60 V, and the \overline{FLT} pin can be used to drive an external PFET transistor and provide protection from 60-V overvoltage at input as shown in Figure 8-5.

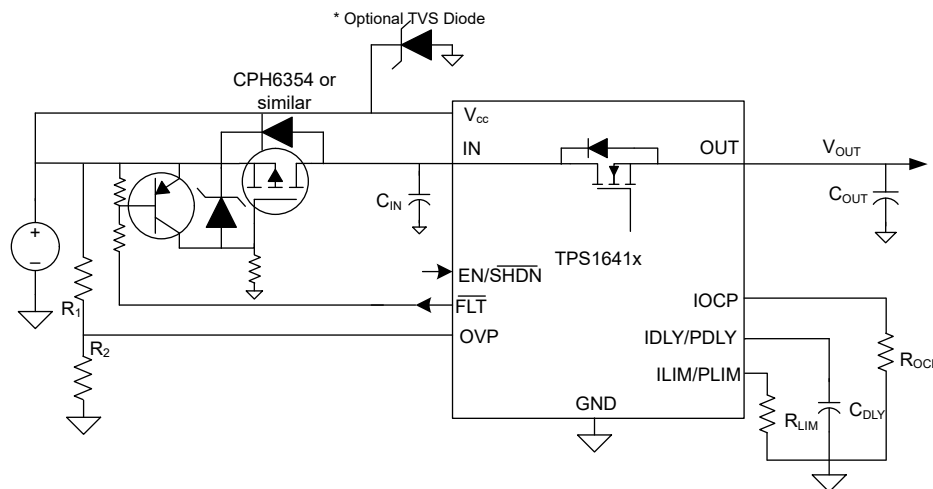

Figure 8-5. Overvoltage (up to 60 V) Protection with External PFET

To disable the overvoltage input, connect OVP to GND. If the OVP pin is left open, the device turns off the internal FET.

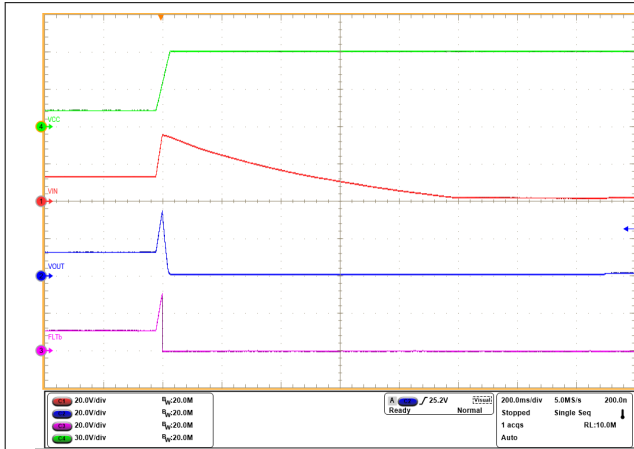

Figure 8-6. Overvoltage Response with External PFET for IN Voltage from 12 V to 60 V

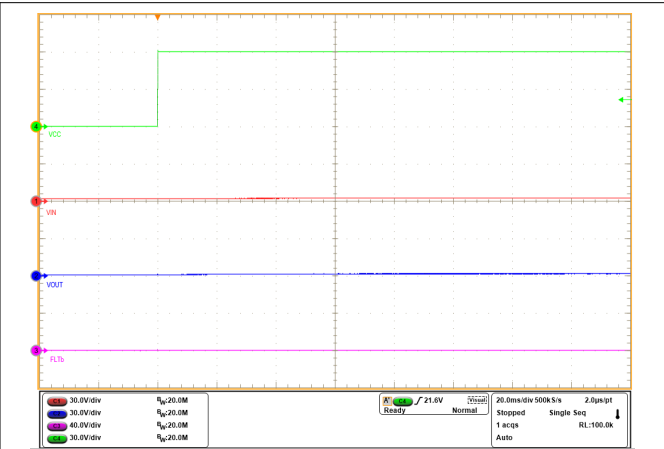

Figure 8-7. Hot Plugin with External PFET for 60-V Input

8.3.3 Output Slew Rate and Inrush Current Control (dVdt)

During hot plug events or while trying to charge a large output capacitance, there can be a large inrush current. If the inrush current is not managed properly, it can damage the input connectors and cause the system power supply to droop leading to unexpected restarts elsewhere in the system. The inrush current during turn-on is directly proportional to the load capacitance and rising slew rate. Equation 1 can be used to find the output slew rate (SR) required to limit the inrush current (I_{INRUSH}) for a given output capacitance (C_{OUT}).

$$SR = \frac{I_{INRUSH}}{C_{OUT}} \quad (1)$$

A capacitance can be added to the dVdt pin to control the rising slew rate and lower the inrush current during turn-on. The required C_{dVdt} capacitance to produce a given slew rate can be calculated using Equation 2.

$$C_{dVdt} = \frac{I_{dVdt} \times G_{dVdt}}{SR} \quad (2)$$

The fastest output slew rate is achieved by leaving the dVdt pin open. If dVdt pin is connected to GND, the device will not power up the output. Figure 8-8 illustrates the output slew rate control in the TPS1641x devices. Figure 8-9 shows the output slew rate control response of the device.

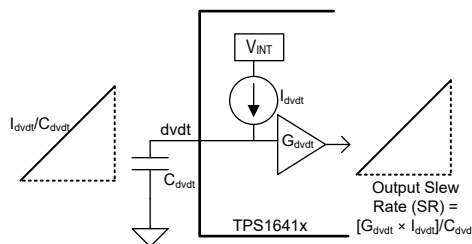

Figure 8-8. Output Slew Rate Control in the TPS1641x

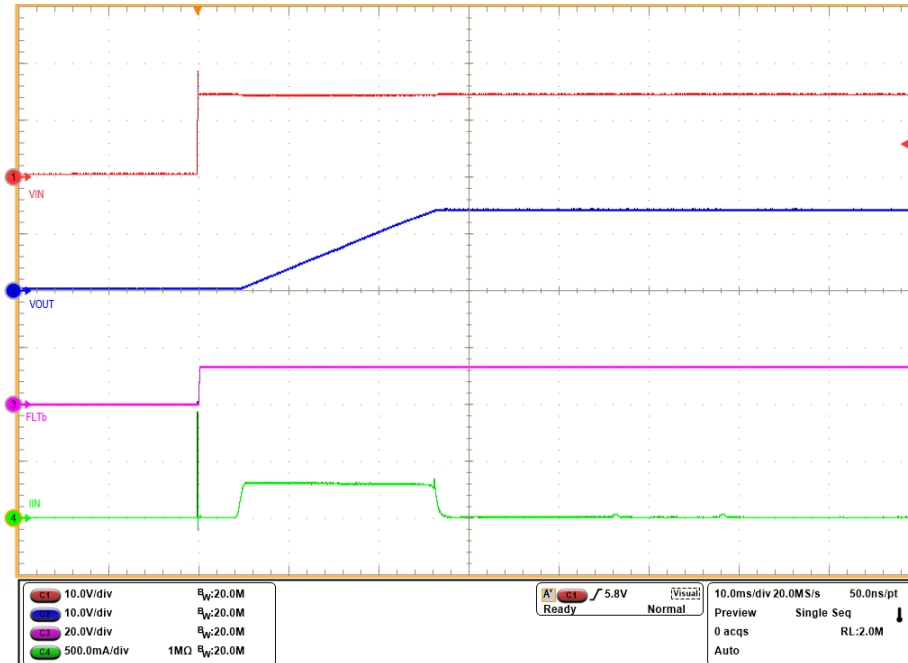

Figure 8-9. Output Slew Rate Control with $V_{IN} = 12\text{ V}$, $C_{dVdt} = 150\text{ nF}$, and $C_{OUT} = 470\text{ }\mu\text{F}$

8.3.4 Active Current Limiting (ILIM) With the TPS16412, TPS16413, TPS16416, and TPS16417

The TPS16412, TPS16413, TPS16416, and TPS16417 devices respond to output overcurrent or overload conditions by actively limiting the current. The devices first provide a blanking time configured by capacitance on the IDLY pin. During this blanking time, the device can provide a current up to I_{OCP} value. After the end of this blanking time, the devices limit current to I_{LIM} value. I_{LIM} can be set by connecting resistor on ILIM pin. R_{LIM} can be calculated by Equation 3.

$$I_{LIM} = \frac{0.984\text{ A}}{R_{LIM}} \times 10\text{ k}\Omega \quad (3)$$

If the output current exceeds I_{OCP} , the device goes into current limiting. During current limiting, if the output current goes below I_{LIM} ($I_{OUT} < I_{LIM}$), the device resets the IDLY timer and restarts IDLY timer when $I_{OUT} > I_{LIM}$. Figure 8-10 illustrates the current limiting behavior for $I_{OUT} < I_{OCP}$ and for $I_{OCP} \leq I_{OUT} < I_{fast-trip}$. During current limiting, if the output current goes below I_{LIM} ($I_{OUT} < I_{LIM}$), the device resets the IDLY timer and restarts the IDLY timer when $I_{OUT} > I_{LIM}$.

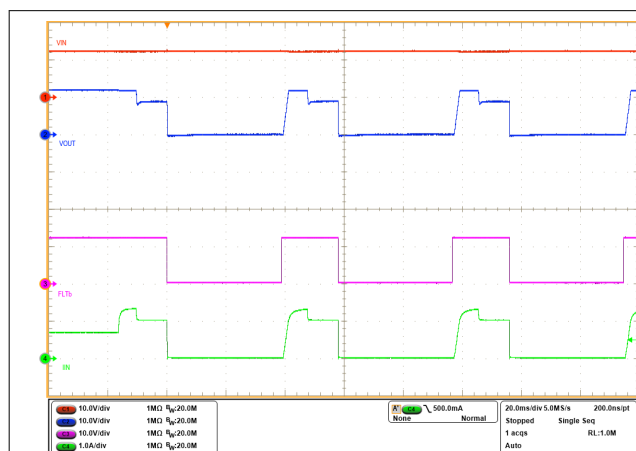

Figure 8-10. Current Limiting for $I_{OUT} < I_{OCP}$

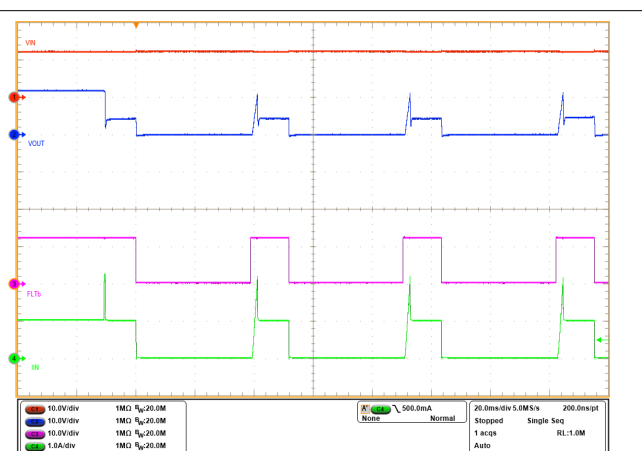

Figure 8-11. $I_{OCP} \leq I_{OUT} < I_{fast-trip}$

During the current limiting, the device dissipates a power of $(V_{IN} - V_{OUT}) \times I_{OUT}$ and the device gets heated up. If the junction temperature of device reaches thermal shutdown temperature (T_{TSD}), the device turns off the internal FET. If the device does not go into thermal shutdown, the internal FET is turned off after a duration of $t_{LIM-DUR}$. After the internal FET is turned off, the TPS16412 and TPS16416 auto-retry while the TPS16413 and TPS16417 latch off. If ILIM pin is connected to GND or left open, the device turns-off the internal FET. If the IDLY pin is left open or connected to GND, device provides $t_{LIM-DUR} = 155$ ms unless the device enters thermal shutdown. Table 8-1 summarizes the device behavior for different output currents.

Table 8-1. Current Limiting and Overload Protection With TPS16412, TPS16413, TPS16416, and TPS16417

Output Current (I_{OUT})	Device Response
$I_{OUT} < I_{LIM}$	The device provides current up to I_{LIM} .
$I_{LIM} \leq I_{OUT} < I_{OCP}$	The device provides current up to I_{OCP} for a duration of IDLY and then limits current to ILIM for a maximum duration of $t_{LIM-DUR}$.
$I_{OCP} \leq I_{OUT} < I_{fast-trip}$	The device limits current to ILIM for a maximum duration of $t_{LIM-DUR}$.
$I_{fast-trip} \leq I_{OUT} < I_{SCP}$	The device turns off the internal FET after a delay of $t_{fast-trip}$.
$I_{SCP} \leq I_{OUT}$	The device turns off the internal FET after a delay of t_{SCP_dly} .

8.3.5 Active Power Limiting (PLIM) With the TPS16410, TPS16411, TPS16414, and TPS16415

The TPS16410, TPS16411, TPS16414, and TPS16415 devices respond to output overcurrent or overload conditions by actively limiting the output power. The devices first provide a blanking time configured by capacitance on PDLY pin. During this blanking time, the device can provide a current up to I_{OCP} value. After the end of this blanking time, the devices limit power to PLIM value. Power limit can be set by connecting a resistor on the PLIM pin. During power limiting, if the output power goes below PLIM ($P_{OUT} < PLIM$), the device resets the PDLY timer and restarts the PDLY timer when $P_{OUT} > PLIM$. Use Equation 4 to calculate the value of resistor for power limiting. The device is rated for 1.8-A continuous current, TI recommends to set $PLIM < V_{IN} \times 1.8$ A and $PLIM < 0.9 \times V_{OUT} \times I_{OCP}$

$$P_{LIM} = \frac{13.82 \text{ W}}{95.3 \text{ k}\Omega} \times R_{PLIM} \quad (4)$$

Figure 8-12 illustrates the power limiting in the TPS16410 and TPS16411 devices for $I_{OUT} < I_{OCP}$ and $I_{OCP} \leq I_{OUT} < I_{fast-trip}$.

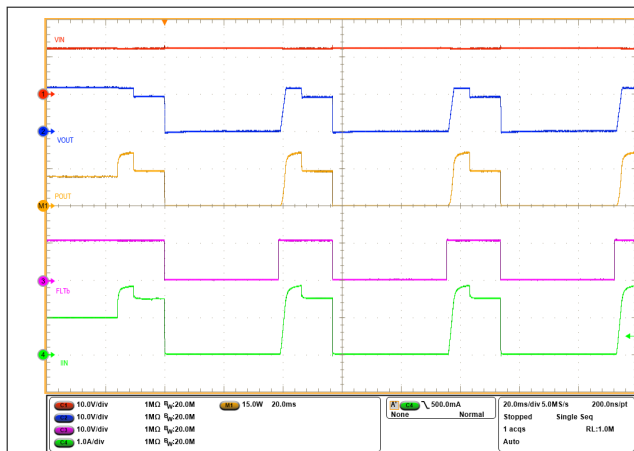

Figure 8-12. Power Limiting ($I_{OUT} < I_{OCP}$)

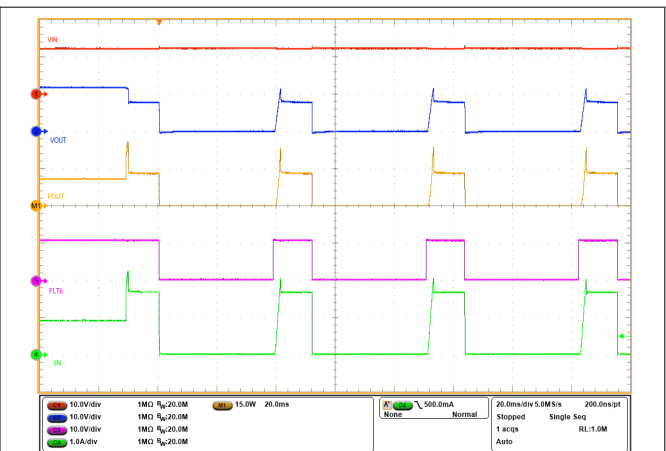

Figure 8-13. Power Limiting ($I_{OCP} \leq I_{OUT} < I_{fast-trip}$)

During power limiting, the device dissipates a power of $(V_{IN} - V_{OUT}) \times I_{OUT}$ and the device gets heated up. If the junction temperature of device reaches thermal shutdown temperature (T_{TSD}), the device turns off the internal FET. If the device does not go into thermal shutdown, the internal FET is turned off after a duration of $t_{PLIM-DUR}$. After the internal FET is turned off, the TPS16410 and TPS16414 devices auto-retry while the TPS16411 and TPS16415 device latch off. If PLIM is connected to GND or left open, the device turns-off the internal FET. If the

PDLY pin is left open or connected to GND, device provides $t_{\text{PLIM-DUR}} = 155 \text{ ms}$ unless the device enters thermal shutdown. [Table 8-2](#) summarizes the device behavior for different output power and current.

Table 8-2. Power Limiting and Overload Response in TPS16410, TPS16411, TPS16414, and TPS16415 Devices

Output Power (P_{OUT}) or Output Current (I_{OUT})	Device Response
$P_{\text{OUT}} < \text{PLIM}$	The device provides power up to PLIM.
$\text{PLIM} \leq P_{\text{OUT}}$ and $I_{\text{OUT}} < I_{\text{OCP}}$	The device provides current up to IOCP for a duration of PDLY and then limits power to PLIM for a maximum duration of $t_{\text{PLIM-DUR}}$.
$I_{\text{OCP}} \leq I_{\text{OUT}} < I_{\text{fast-trip}}$	The device limits current to PLIM for a maximum duration of $t_{\text{PLIM-DUR}}$.
$I_{\text{fast-trip}} \leq I_{\text{OUT}} < I_{\text{SCP}}$	The device turns off the internal FET after a delay of $t_{\text{fast-trip}}$.
$I_{\text{SCP}} \leq I_{\text{OUT}}$	The device turns off the internal FET after a delay of $t_{\text{SCP_dly}}$.

8.3.5.1 Internal Current Limit for the TPS16410 and TPS16411

In power limiting devices, there is an internal current limit. If during power up, the output current exceeds overcurrent protection setpoint (I_{OCP}), these devices limit current to $0.81 \times I_{\text{OCP}}$.

TPS16410, TPS16411, TPS16414, and TPS16415 devices also limit the output current if PLIM is set to more than $(V_{\text{OUT}} \times I_{\text{OCP}})$ and I_{OUT} exceeds I_{OCP} .

8.3.6 Overcurrent Protection (I_{OCP}) and Blanking Time (IDLY or PDLY) for Transient Loads

In TPS1641x devices, the overcurrent protection set-point can be configured by connecting a resistor on I_{OCP} pin. The resistor value for overcurrent can be calculated by [Equation 5](#).

$$I_{\text{OCP}} = \frac{2.25 \text{ A}}{R_{\text{IOCP}}} \times 7.32 \text{ k}\Omega \quad (5)$$

If the IOCP pin is left open or connected to GND, the device turns off the internal FET.

The devices also provide blanking time for overload or overcurrent events. This blanking time can be configured by connecting a capacitor on IDLY or PDLY, and the blanking time can be calculated by [Equation 6](#).

If IDLY/PDLY pin is left open or connected to GND, device disables the blanking time and directly goes into power or current limiting.

$$\text{Blanking Time (IDLY or PDLY)} = \frac{6.5 \text{ ms}}{12 \text{ nF}} \times \text{CDLY} \quad (6)$$

8.3.7 Fast-Trip and Short-Circuit Protection

During an output short-circuit event, the current through the device increases very rapidly. When an output short-circuit is detected and output current reaches I_{SCP} level, the device turns off the internal FET after a delay of $t_{\text{SCP_dly}}$.

In case of fast input transients, the current through internal FET rises rapidly, but these transients can lead to false turn-off of internal FET due to excessive flow of current through internal FET. To prevent false tripping during these input transients, the device includes fast-trip comparator, which turns off the internal FET if the output current exceeds $I_{\text{fast-trip}}$ for a duration of $t_{\text{fast-trip}}$. [Figure 8-14](#) shows the short-circuit response of the device.

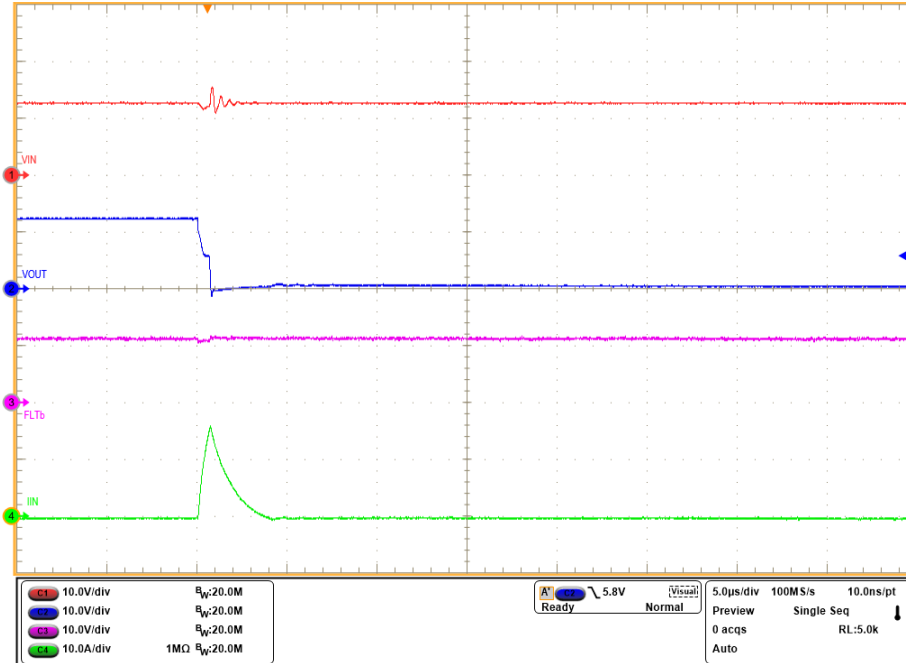

Figure 8-14. Short-Circuit Response with $V_{IN} = 12\text{ V}$

8.3.8 Analog Load Current Monitor (IMON) on the IOCP Pin

The device allows the system to monitor the output load current accurately by providing an analog current on the IOCP/IMON pin, which is proportional to the current through the FET. The resistor on IOCP/IMON pin converts this current into voltage and this voltage can be used for monitoring the output current. Output current can be calculated from voltage at IOCP/IMON pin by using Equation 7.

$$I_{OUT} = \frac{V_{IOCP} - (OS_{IMON} \times R_{IOCP})}{G_{IMON} \times R_{IOCP}} \quad (7)$$

8.3.9 IN to OUT Short Detection (TPS16410, TPS16411, TPS16412, and TPS16413)

TPS16410, TPS16411, TPS16412, and TPS16413 devices include short detection across IN and OUT pins. If the device detects a resistance less than R_{short} across IN and OUT pins, the device asserts the \overline{FLT} pin low. See the Section 7.5 for R_{short} and Section 7.6 for $t_{IN_OUT_Short_Detect}$.

At start-up, the device keeps \overline{FLT} low and the internal FET off. The device detects for short across IN to OUT before turning on the internal FET. If device does not detect any short across IN to OUT, the device de-asserts the \overline{FLT} and enables the internal FET. After start-up, the device detects for short across IN to OUT at regular intervals and asserts the \overline{FLT} pin after a delay of $t_{IN_OUT_Short_Detect}$. After the device detects IN to OUT short, it latches off. To reset the latch, toggle EN/SHDN or recycle the V_{cc} supply. To reset the latch, keep EN/SHDN pin low for duration more than t_{Low_SHDN} . Figure 8-15 illustrates the response of device for IN to OUT short. In case of switching loads on output of device, see Table 8-3 for recommended device variants based on switching load frequency f_{SW} (in kHz) and ripple load current I_{Ripple} (in mA_{p-p}).

Table 8-3. Recommended Device Variants

Switching Load Frequency	$(I_{Ripple} / f_{SW}) \geq 2$	$(I_{Ripple} / f_{SW}) < 2$
0 to 5 Hz	TPS16410, TPS16411, TPS16412, TPS16413, TPS16414, TPS16415, TPS16416, or TPS16417	
> 5 Hz	TPS16414, TPS16415, TPS16416, or TPS16417	TPS16410, TPS16411, TPS16412, TPS16413, TPS16414, TPS16415, TPS16416, or TPS16417

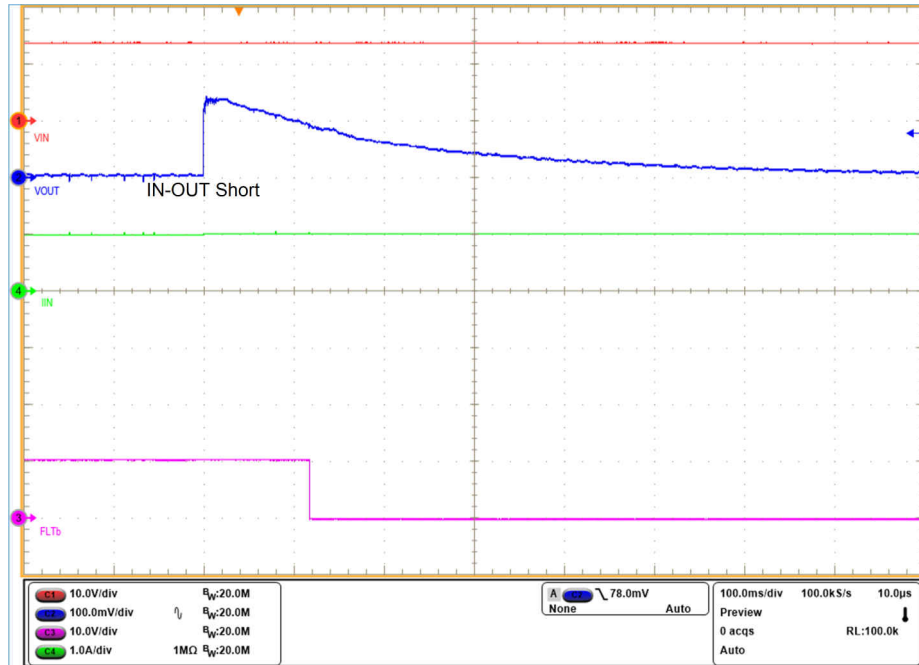

Figure 8-15. IN to OUT Short Detection for $V_{IN} = 12\text{ V}$

8.3.10 Thermal Shutdown and Overtemperature Protection

During power or current limiting, there is a power dissipation $[(V_{IN} - V_{OUT}) \times I_{OUT}]$ in the internal FET of the device. Due to this power dissipation, the temperature (T_J) of device increases. When the device temperature increases above T_{TSD} , it shuts down. After the thermal shutdown, the TPS16411, TPS16413, TPS16415, and TPS16417 remain latched. To reset the latch, toggle EN/ $\overline{\text{SHDN}}$ or recycle the V_{CC} supply. To reset the latch, keep EN/ $\overline{\text{SHDN}}$ pin low for duration more than $t_{\text{Low_SHDN}}$.

After thermal shutdown, the TPS16410, TPS16412, TPS16414, and TPS16416 devices wait for temperature to go below $[T_{TSD} - T_{TSD\text{-hyst}}]$ and then the device restarts after a delay of t_{retry} .

8.3.11 Fault Response and Indication ($\overline{\text{FLT}}$)

$\overline{\text{FLT}}$ is an open-drain output to indicate the overvoltage, IN to OUT short, overtemperature, current limit, and power limit events. Table 8-4 summarizes the state of $\overline{\text{FLT}}$ pin under different events. To prevent excessive dissipation in device during adjacent pin short test ($\overline{\text{FLT}}$ to EN/ $\overline{\text{SHDN}}$), pull up the $\overline{\text{FLT}}$ pin with a resistor (R_{FLT}) such that sink current into $\overline{\text{FLT}}$ pin is less than 3 mA. Figure 8-16 shows the connection diagram for $\overline{\text{FLT}}$ pin with a pullup resistor.

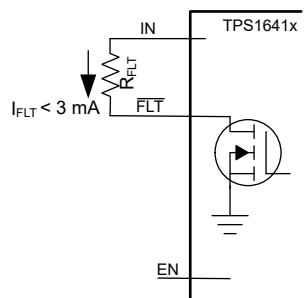

Figure 8-16. $\overline{\text{FLT}}$ Output in the TPS1641x

Table 8-4. $\overline{\text{FLT}}$ Pin Indication for Different Events

Event, Condition	$\overline{\text{FLT}}$ Pin	Retry Delay With IDLY/ PDLY = Open or GND for TPS16410, TPS16412, TPS16414, and TPS16416	Retry Delay With Capacitor on IDLY/PDLY pin for TPS16410, TPS16412, TPS16414, and TPS16416
Overvoltage protection ($V_{\text{OVP}} > V_{\text{OVPR}}$) ⁽¹⁾	Low	NA	NA
IN to short detection (TPS16410, TPS16411, TPS16412, and TPS16413)	Low	No retry, latch off	No retry, latch off
Thermal shutdown ($T_{\text{J}} > T_{\text{TSD}}$)	Low	620 ms	$8 \times t_{\text{PDLY/IDLY}}$
After current or power limiting timeout	Low	620 ms	$8 \times t_{\text{PDLY/IDLY}}$

(1) For overvoltage protection, device turns on the FET as V_{OVP} falls below V_{OVPR}

8.4 Device Functional Modes

The device can be brought into low power shutdown mode by bringing the $\text{EN}/\overline{\text{SHDN}}$ pin low. In low power shutdown mode, the internal blocks of devices are shut down and it takes I_{QSD} from V_{CC} supply. See the [Enable and Shutdown Input \(\$\text{EN}/\overline{\text{SHDN}}\$ \)](#) section for details.

9 Application and Implementation

Note

Information in the following applications sections is not part of the TI component specification, and TI does not warrant its accuracy or completeness. TI's customers are responsible for determining suitability of components for their purposes, as well as validating and testing their design implementation to confirm system functionality.

9.1 Application Information

TPS1641x devices include power limiting or current limiting for a low power circuit (as per IEC60335 and UL60730 standards) in appliances, HVAC actuators, and medical equipment. TPS1641x devices also have IN to OUT short detection for internal FET for IN-OUT short testing during IEC60335 or UL60730 certifications. The TPS16410 and TPS16411 have an accurate power limiting feature while the TPS16412 and TPS16413 have an accurate current limiting feature. For transient current required for start-up of motors or actuators, TPS1641x devices have a configurable overcurrent protection threshold (IOCP) and configurable blanking time (IDL/IDLY). For start-up with big capacitance (< 1 mF) on output, the TPS1641x include dVdT feature to control the output slew rate and limiting the inrush current during power up. The output current can be monitored from IOCP or IMON pin, by sensing the voltage on this pin.

9.2 Typical Application: 15-W Power Limiting for Low Power Circuits (LPCs)

The TPS16410 and TPS16411 can be used for 15-W power limiting for low-power circuits in IEC60335 and UL60730 standards. The output power limit can be configured by a resistor on the PLIM pin. [Figure 9-1](#) provides a typical application circuit for 15-W power limiting.

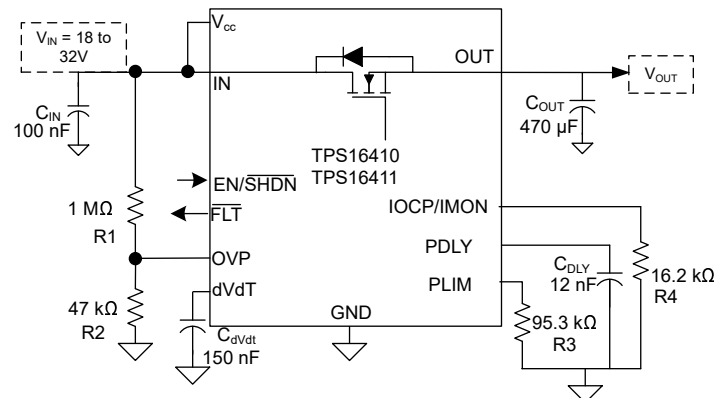

Figure 9-1. 15-W Power Limiting for Low-Power Circuits

9.2.1 Design Requirements

Table 9-1. Design Parameters

Parameter	Value
V_{IN}	18 V to 32 V
P_{OUT}	≤ 15 W
Overcurrent protection	1 A
Output capacitance (C_{OUT})	470 μF
I_{INRUSH}	≤ 350 mA
Blanking time for transients (PDLY)	6.5 ms

9.2.2 Detailed Design Procedure

9.2.2.1 Setting Overvoltage Setpoints

Input overvoltage protection setpoints can be set by connecting resistors (R_1 , R_2) from the IN pin to OVP pin. The value of resistors can be calculated using [Equation 8](#) and [Equation 9](#). To set the OVP rising setpoint to 32 V, $R_1 = 1\text{ M}\Omega$ and $R_2 = 47\text{ k}\Omega$ are selected.

$$\text{OVP Rising Setpoint} = \frac{V_{OVPR} \times (R_1 + R_2)}{R_2} \quad (8)$$

$$\text{OVP Falling Setpoint} = \frac{V_{OVPF} \times (R_1 + R_2)}{R_2} \quad (9)$$

9.2.2.2 Setting the Output Overcurrent Setpoint (IOCP)

To set the output overcurrent setpoint, a resistor (R_4) is required on the IOCP pin. To calculate the value of this resistor (R_4), use [Equation 5](#). For $I_{OCP} = 1\text{ A}$, R_4 is selected as 16.2 kΩ.

9.2.2.3 Setting the Output Power Limit

For setting the output power limit, a resistor (R_3) is required on the PLIM pin. To calculate the value of power limit, use [Equation 4](#). To keep output power limit ≤ 15 W, R_3 was selected as 95.3 kΩ.

9.2.2.4 Monitoring the Output Current

The output current can be monitored on IOCP or IMON by reading the voltage on this pin. The output current can be calculated using [Equation 7](#).

9.2.2.5 Limiting the Inrush Current and Setting the Output Slew Rate

For charging the large capacitors on output, the output slew rate can be controlled by using a capacitor on dVdt pin. The value of inrush current can be estimated by [Equation 10](#). To keep the inrush current below 350 mA, C_{dVdt} is selected as 150 nF.

$$I_{INRUSH} = \frac{I_{dVdt} \times C_{dVdt} \times C_{OUT}}{C_{dVdt}} \quad (10)$$

9.2.3 Application Curves

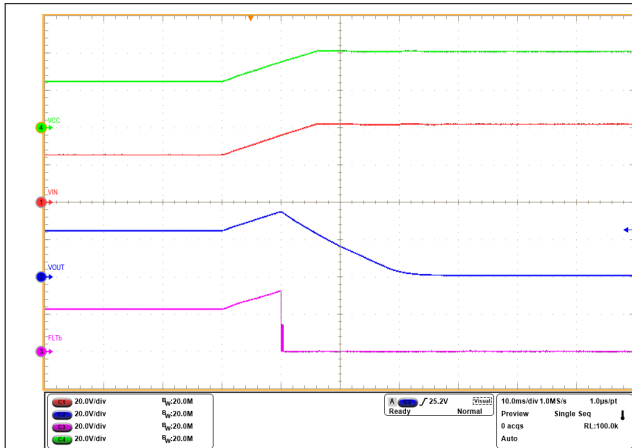

Figure 9-2. Overvoltage Protection up to 40 V

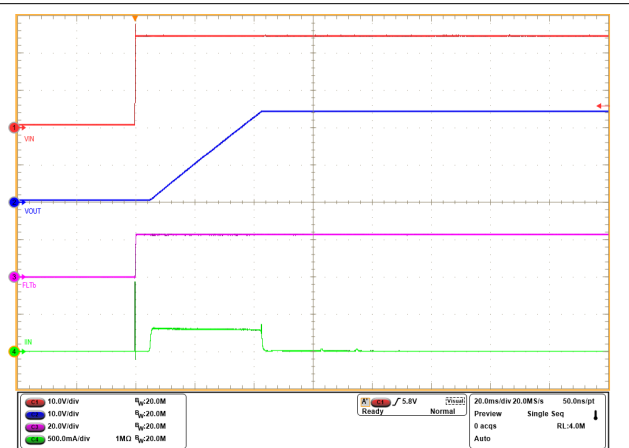

Figure 9-3. Inrush Current Control for Hot Plugging at Input

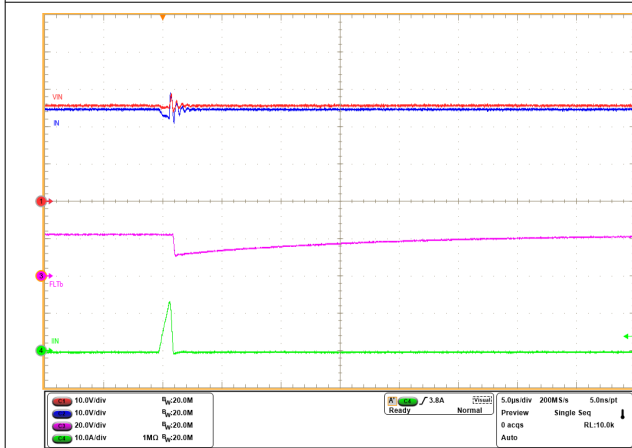

Figure 9-4. Output Short-Circuit Protection

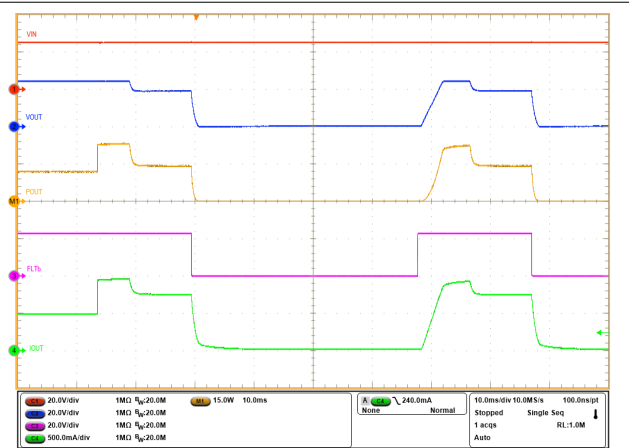

Figure 9-5. 15-W Power Limiting with TPS16410 ($I_{OUT} < I_{OCP}$)

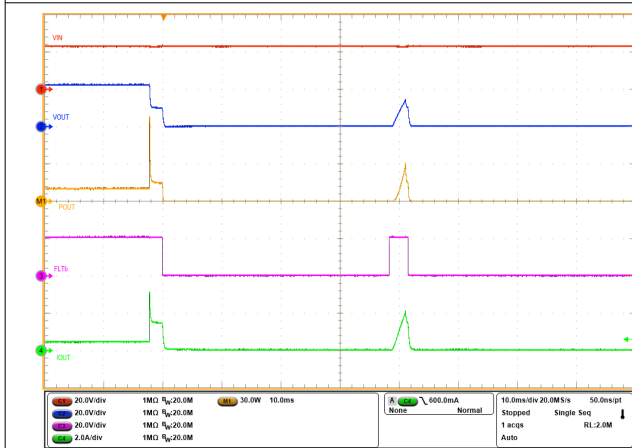

Figure 9-6. 15-W Power Limiting with TPS16410 ($I_{OCP} \leq I_{OUT} < I_{fast-trip}$)

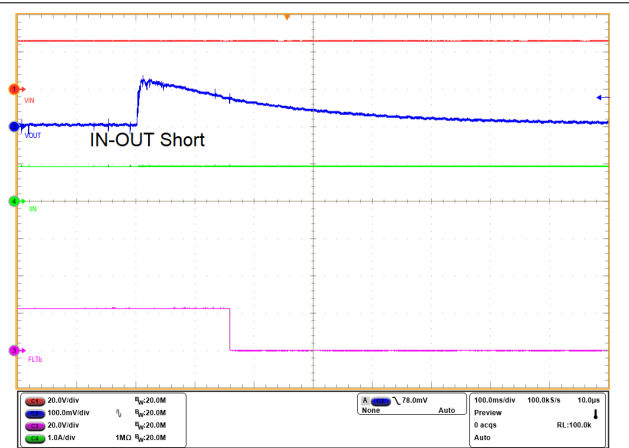

Figure 9-7. IN to OUT Short Detection with $V_{IN} = 24$ V

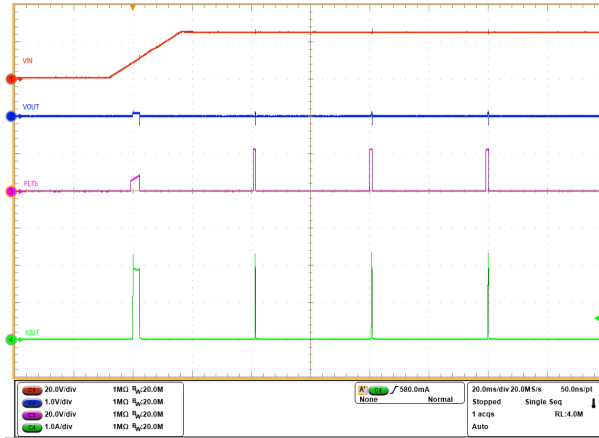

Figure 9-8. Power-Up Into Short

9.3 System Examples

9.3.1 Accurate Power or Current Limiting at the Output of DC/DC or Flyback Converter

For systems using a DC/DC converter or a flyback converter, the device can be used for accurate power or current limiting ($\pm 5\%$) at the output. For additional protection, the device has a fault pin and it is asserted in case of overvoltage, overcurrent or overpower, IN-short detection and thermal shutdown events. The fault can be used to turn-off the DC/DC converter or flyback converter providing the power to input of TPS1641 for the load. The device has separate Vcc pin for powering itself and it can remain on with Vcc supply. Figure 9-9 illustrates the application at the output of DC/DC or flyback converter.

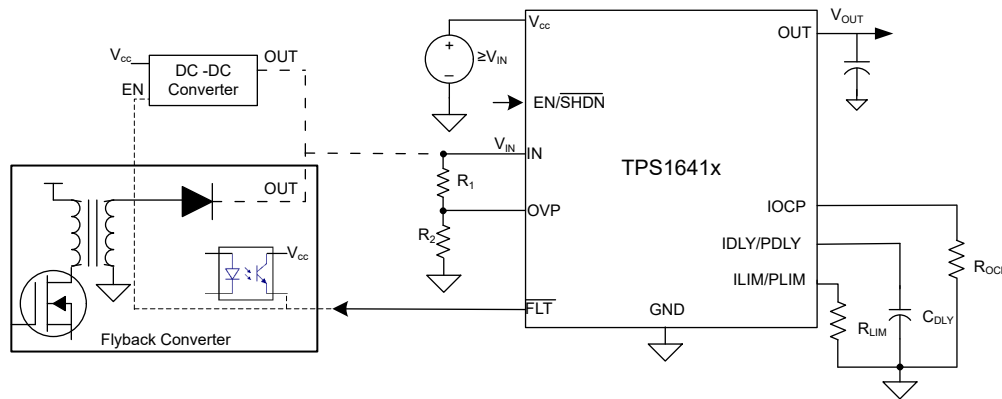

Figure 9-9. Accurate Power or Current Limiting at the Output of DC/DC or Flyback Converter

9.4 Best Design Practices

- Use $C_{IN} \geq 10$ nF for decoupling V_{CC} and IN pins.
- Do not leave the OVP, PLIM/ILIM, and IOCP/IMON pins open or floating.
- Connect the PowerPAD of the device to GND on the PCB.
- Do not connect the EN/SHDN pin to voltage more than 5 V.

9.5 Power Supply Recommendations

- Use $4.5\text{ V} \leq V_{IN} \leq 40\text{ V}$ for the TPS16410 and TPS16411.
- Use $2.7\text{ V} \leq V_{IN} \leq 40\text{ V}$ for the TPS16412 and TPS16413.
- Use $V_{IN} \leq V_{CC} \leq 60\text{ V}$.
- Pull up $\overline{\text{FLT}}$ with voltage $\leq 60\text{ V}$. Use a pullup resistor to keep current into the $\overline{\text{FLT}}$ pin $< 3\text{ mA}$.

9.5.1 Transient Protection

In the case of a short-circuit and overload current limit when the device interrupts current flow, the input inductance generates a positive voltage spike on the input, and the output inductance generates a negative voltage spike on the output. The peak amplitude of voltage spikes (transients) is dependent on the value of inductance in series to the input or output of the device. Such transients can exceed the absolute maximum ratings of the device if steps are not taken to address the issue. Figure 9-10 illustrates the transient protection circuit. Typical methods for addressing transients include:

- Minimize lead length and inductance into and out of the device.
- Use a large PCB GND plane.
- Connect a Schottky diode (D2) from the OUT pin ground to absorb negative spikes. The OUT pin has an absolute maximum rating of -1 V for negative transient spikes on output.
- Connect a low-ESR capacitor larger than $1\text{ }\mu\text{F}$ at the OUT pin very close to the device.
- Use a low-value ceramic capacitor $C_{IN} = 0.1\text{ }\mu\text{F}$ to absorb the energy and dampen the transients. The approximate value of input capacitance can be estimated with Equation 11.

$$V_{IN - SPIKE} = V_{IN} + I_{LOAD} \times \sqrt{\frac{L_{IN}}{C_{IN}}} \quad (11)$$

- Some applications require additional Transient Voltage Suppressor (TVS) to keep transients below the absolute maximum rating of the device. A TVS can help to absorb the excessive energy dump and prevent it from creating very fast transient voltages on the input of the device. Use a suitable TVS to clamp the transient voltage below the absolute maximum rating of the device.

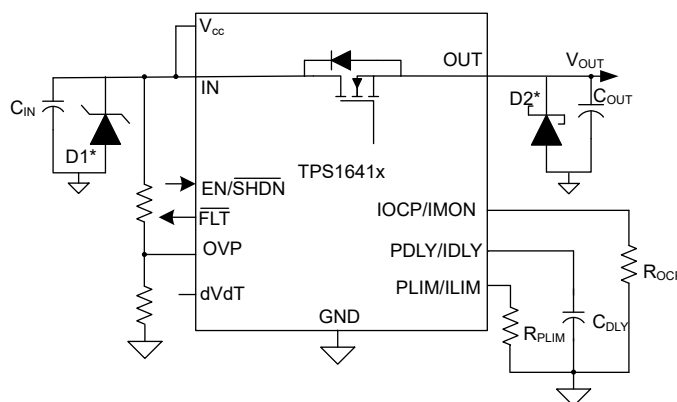

TVS D1* and Schottky D2* are optional diodes for transient protection on the input and output.

Figure 9-10. Transient Protection with TPS1641x

9.6 Layout

9.6.1 Layout Guidelines

- High current-carrying power-path connections must be as short as possible and must be sized to carry at least twice the full-load current.
- The GND (PowerPAD) pin must be tied to the PCB ground plane at the terminal of the IC with the shortest possible trace. The PCB ground must be a copper plane or island on the board. TI recommends to have a separate ground plane island for the eFuse. This plane does not carry any high currents and serves as a quiet ground reference for all the critical analog signals of the eFuse. The device ground plane must be connected to the system power ground plane using a star connection.
- The optimal placement of the decoupling capacitor (C_{IN}) is closest to the IN and GND pins of the device. Care must be taken to minimize the loop area formed by the bypass-capacitor connection, the IN pin, and the GND pin of the IC.
- Locate the following support components close to their connection pins:
 - R_{ILM} or R_{PLM}
 - R_{IOCP}
 - C_{DLY}
 - C_{dVdT}
 - Resistors for OVP
- Connect the other end of the component to the GND pin of the device with shortest trace length. The trace routing for these components to the device must be as short as possible to reduce parasitic effects on the current limit, overcurrent blanking interval, and soft-start timing.
- Because the bias current on ILM pin directly controls the overcurrent protection behavior of the device, the PCB routing of this node must be kept away from any noisy (switching) signals.
- Protection devices such as TVS, snubbers, capacitors, or diodes must be placed physically close to the device they are intended to protect. These protection devices must be routed with short traces to reduce inductance. For example, TI recommends a protection Schottky diode to address negative transients due to switching of inductive loads. TI recommends to add a ceramic decoupling capacitor (C_{OUT}) of 1 μ F or greater between OUT and GND. These components must be physically close to the OUT pins. Care must be taken to minimize the loop area formed by the Schottky diode and bypass-capacitor connection, the OUT pin, and the GND pin of the IC.

9.6.2 Layout Example

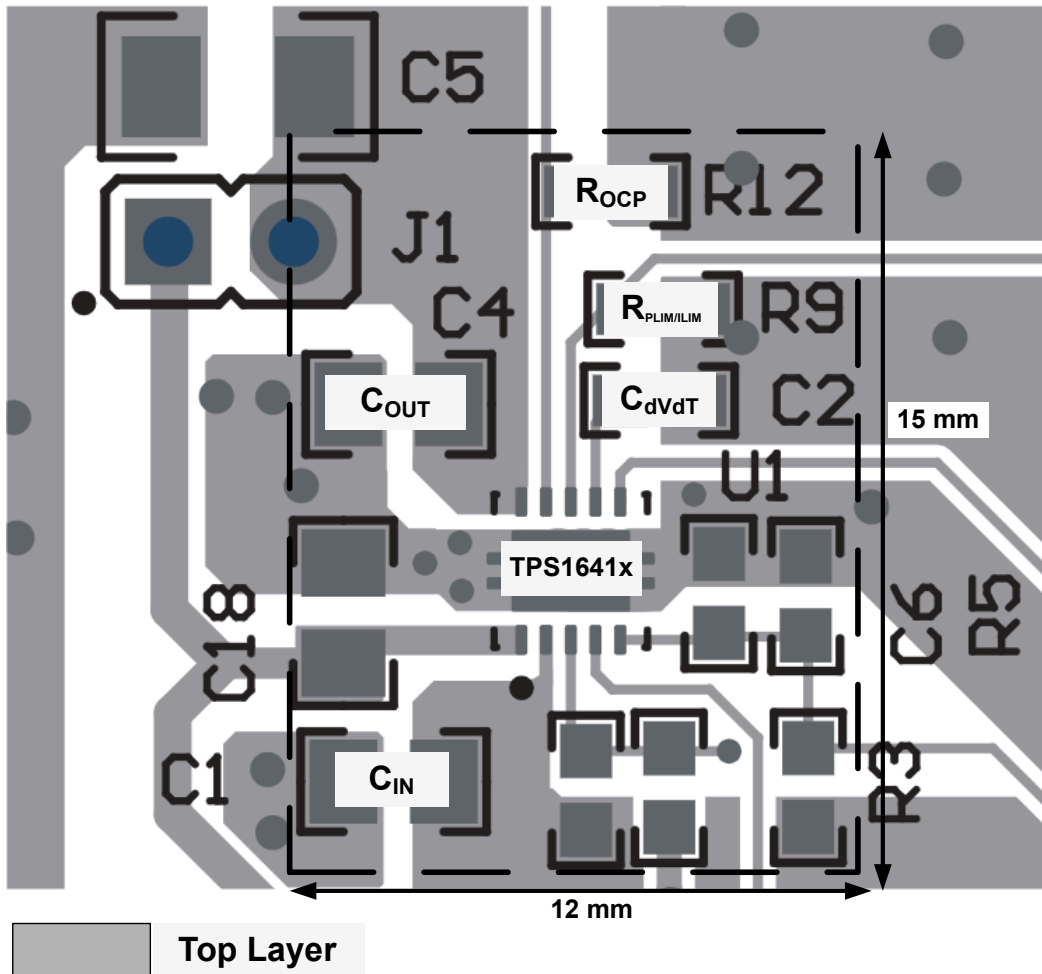

Figure 9-11. Layout Example

10 Device and Documentation Support

TI offers an extensive line of development tools. Tools and software to evaluate the performance of the device, generate code, and develop solutions are listed below.

10.1 Receiving Notification of Documentation Updates

To receive notification of documentation updates, navigate to the device product folder on [ti.com](https://www.ti.com). Click on *Subscribe to updates* to register and receive a weekly digest of any product information that has changed. For change details, review the revision history included in any revised document.

10.2 Support Resources

[TI E2E™ support forums](#) are an engineer's go-to source for fast, verified answers and design help — straight from the experts. Search existing answers or ask your own question to get the quick design help you need.

Linked content is provided "AS IS" by the respective contributors. They do not constitute TI specifications and do not necessarily reflect TI's views; see TI's [Terms of Use](#).

10.3 Trademarks

PowerPAD™ and TI E2E™ are trademarks of Texas Instruments. All trademarks are the property of their respective owners.

10.4 Electrostatic Discharge Caution



This integrated circuit can be damaged by ESD. Texas Instruments recommends that all integrated circuits be handled with appropriate precautions. Failure to observe proper handling and installation procedures can cause damage.

ESD damage can range from subtle performance degradation to complete device failure. Precision integrated circuits may be more susceptible to damage because very small parametric changes could cause the device not to meet its published specifications.

10.5 Glossary

[TI Glossary](#) This glossary lists and explains terms, acronyms, and definitions.

11 Mechanical, Packaging, and Orderable Information

The following pages include mechanical, packaging, and orderable information. This information is the most current data available for the designated devices. This data is subject to change without notice and revision of this document. For browser-based versions of this data sheet, refer to the left-hand navigation.

PACKAGING INFORMATION

Orderable Device	Status (1)	Package Type	Package Drawing	Pins	Package Qty	Eco Plan (2)	Lead finish/ Ball material (6)	MSL Peak Temp (3)	Op Temp (°C)	Device Marking (4/5)	Samples
TPS16410DRCR	ACTIVE	VSON	DRC	10	3000	RoHS & Green	NIPDAU	Level-2-260C-1 YEAR	-40 to 125	T16410	Samples
TPS16411DRCR	ACTIVE	VSON	DRC	10	3000	RoHS & Green	NIPDAU	Level-2-260C-1 YEAR	-40 to 125	T16411	Samples
TPS16412DRCR	ACTIVE	VSON	DRC	10	3000	RoHS & Green	NIPDAU	Level-2-260C-1 YEAR	-40 to 125	T16412	Samples
TPS16413DRCR	ACTIVE	VSON	DRC	10	3000	RoHS & Green	NIPDAU	Level-2-260C-1 YEAR	-40 to 125	T16413	Samples
TPS16414DRCR	ACTIVE	VSON	DRC	10	3000	RoHS & Green	NIPDAU	Level-2-260C-1 YEAR	-40 to 125	T16414	Samples
TPS16415DRCR	ACTIVE	VSON	DRC	10	3000	RoHS & Green	NIPDAU	Level-2-260C-1 YEAR	-40 to 125	T16415	Samples
TPS16416DRCR	ACTIVE	VSON	DRC	10	3000	RoHS & Green	NIPDAU	Level-2-260C-1 YEAR	-40 to 125	T16416	Samples
TPS16417DRCR	ACTIVE	VSON	DRC	10	3000	RoHS & Green	NIPDAU	Level-2-260C-1 YEAR	-40 to 125	T16417	Samples

(1) The marketing status values are defined as follows:

ACTIVE: Product device recommended for new designs.

LIFEBUY: TI has announced that the device will be discontinued, and a lifetime-buy period is in effect.

NRND: Not recommended for new designs. Device is in production to support existing customers, but TI does not recommend using this part in a new design.

PREVIEW: Device has been announced but is not in production. Samples may or may not be available.

OBSOLETE: TI has discontinued the production of the device.

(2) **RoHS:** TI defines "RoHS" to mean semiconductor products that are compliant with the current EU RoHS requirements for all 10 RoHS substances, including the requirement that RoHS substance do not exceed 0.1% by weight in homogeneous materials. Where designed to be soldered at high temperatures, "RoHS" products are suitable for use in specified lead-free processes. TI may reference these types of products as "Pb-Free".

RoHS Exempt: TI defines "RoHS Exempt" to mean products that contain lead but are compliant with EU RoHS pursuant to a specific EU RoHS exemption.

Green: TI defines "Green" to mean the content of Chlorine (Cl) and Bromine (Br) based flame retardants meet JS709B low halogen requirements of <=1000ppm threshold. Antimony trioxide based flame retardants must also meet the <=1000ppm threshold requirement.

(3) MSL, Peak Temp. - The Moisture Sensitivity Level rating according to the JEDEC industry standard classifications, and peak solder temperature.

(4) There may be additional marking, which relates to the logo, the lot trace code information, or the environmental category on the device.

(5) Multiple Device Markings will be inside parentheses. Only one Device Marking contained in parentheses and separated by a "~" will appear on a device. If a line is indented then it is a continuation of the previous line and the two combined represent the entire Device Marking for that device.

⁽⁶⁾ Lead finish/Ball material - Orderable Devices may have multiple material finish options. Finish options are separated by a vertical ruled line. Lead finish/Ball material values may wrap to two lines if the finish value exceeds the maximum column width.

Important Information and Disclaimer:The information provided on this page represents TI's knowledge and belief as of the date that it is provided. TI bases its knowledge and belief on information provided by third parties, and makes no representation or warranty as to the accuracy of such information. Efforts are underway to better integrate information from third parties. TI has taken and continues to take reasonable steps to provide representative and accurate information but may not have conducted destructive testing or chemical analysis on incoming materials and chemicals. TI and TI suppliers consider certain information to be proprietary, and thus CAS numbers and other limited information may not be available for release.

In no event shall TI's liability arising out of such information exceed the total purchase price of the TI part(s) at issue in this document sold by TI to Customer on an annual basis.

TAPE AND REEL INFORMATION

QUADRANT ASSIGNMENTS FOR PIN 1 ORIENTATION IN TAPE

*All dimensions are nominal

Device	Package Type	Package Drawing	Pins	SPQ	Reel Diameter (mm)	Reel Width W1 (mm)	A0 (mm)	B0 (mm)	K0 (mm)	P1 (mm)	W (mm)	Pin1 Quadrant
TPS16410DRCR	VSON	DRC	10	3000	330.0	12.4	3.3	3.3	1.1	8.0	12.0	Q2
TPS16411DRCR	VSON	DRC	10	3000	330.0	12.4	3.3	3.3	1.1	8.0	12.0	Q2
TPS16412DRCR	VSON	DRC	10	3000	330.0	12.4	3.3	3.3	1.1	8.0	12.0	Q2
TPS16413DRCR	VSON	DRC	10	3000	330.0	12.4	3.3	3.3	1.1	8.0	12.0	Q2
TPS16414DRCR	VSON	DRC	10	3000	330.0	12.4	3.3	3.3	1.1	8.0	12.0	Q2
TPS16415DRCR	VSON	DRC	10	3000	330.0	12.4	3.3	3.3	1.1	8.0	12.0	Q2
TPS16416DRCR	VSON	DRC	10	3000	330.0	12.4	3.3	3.3	1.1	8.0	12.0	Q2
TPS16417DRCR	VSON	DRC	10	3000	330.0	12.4	3.3	3.3	1.1	8.0	12.0	Q2

TAPE AND REEL BOX DIMENSIONS

*All dimensions are nominal

Device	Package Type	Package Drawing	Pins	SPQ	Length (mm)	Width (mm)	Height (mm)
TPS16410DRCR	VSON	DRC	10	3000	367.0	367.0	35.0
TPS16411DRCR	VSON	DRC	10	3000	367.0	367.0	35.0
TPS16412DRCR	VSON	DRC	10	3000	367.0	367.0	35.0
TPS16413DRCR	VSON	DRC	10	3000	367.0	367.0	35.0
TPS16414DRCR	VSON	DRC	10	3000	367.0	367.0	35.0
TPS16415DRCR	VSON	DRC	10	3000	367.0	367.0	35.0
TPS16416DRCR	VSON	DRC	10	3000	367.0	367.0	35.0
TPS16417DRCR	VSON	DRC	10	3000	367.0	367.0	35.0

GENERIC PACKAGE VIEW

DRC 10

VSON - 1 mm max height

3 x 3, 0.5 mm pitch

PLASTIC SMALL OUTLINE - NO LEAD

This image is a representation of the package family, actual package may vary.
Refer to the product data sheet for package details.

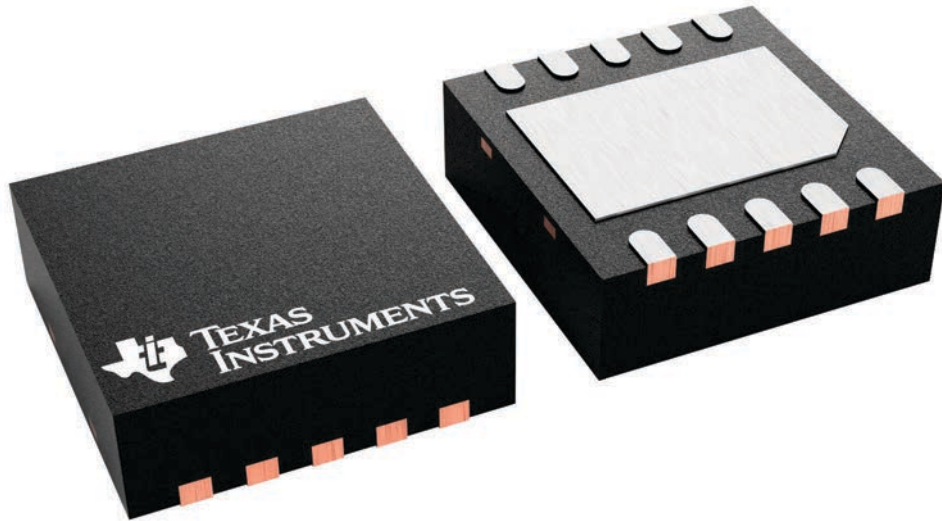

4226193/A

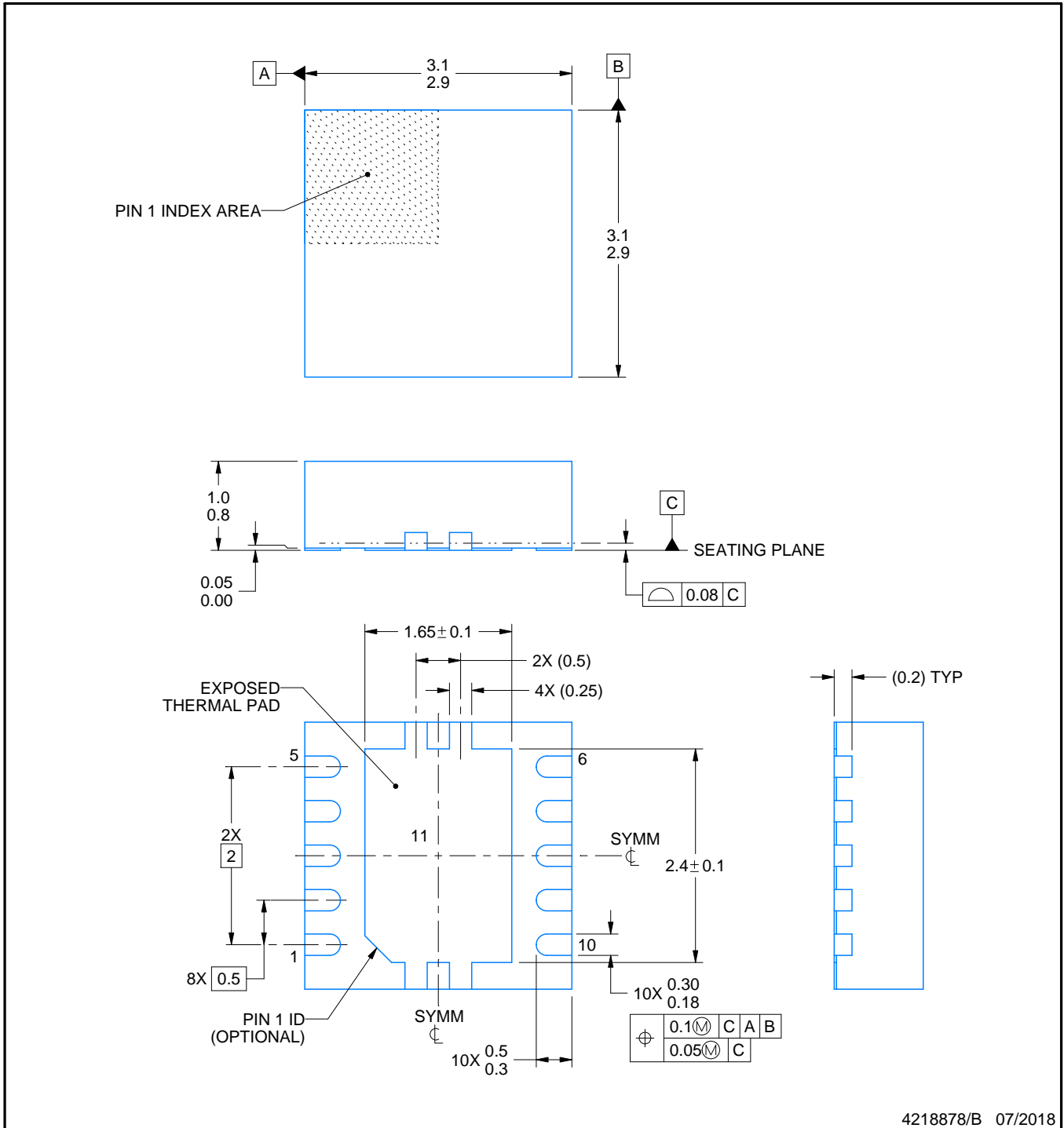

4218878/B 07/2018

NOTES:

1. All linear dimensions are in millimeters. Any dimensions in parenthesis are for reference only. Dimensioning and tolerancing per ASME Y14.5M.
2. This drawing is subject to change without notice.
3. The package thermal pad must be soldered to the printed circuit board for optimal thermal and mechanical performance.

EXAMPLE BOARD LAYOUT

DRC0010J

VSON - 1 mm max height

PLASTIC SMALL OUTLINE - NO LEAD



LAND PATTERN EXAMPLE
EXPOSED METAL SHOWN
SCALE:20X



SOLDER MASK DETAILS

4218878/B 07/2018

NOTES: (continued)

4. This package is designed to be soldered to a thermal pad on the board. For more information, see Texas Instruments literature number SLUA271 (www.ti.com/lit/sluea271).
5. Vias are optional depending on application, refer to device data sheet. If any vias are implemented, refer to their locations shown on this view. It is recommended that vias under paste be filled, plugged or tented.

EXAMPLE STENCIL DESIGN

DRC0010J

VSON - 1 mm max height

PLASTIC SMALL OUTLINE - NO LEAD



SOLDER PASTE EXAMPLE
BASED ON 0.125 mm THICK STENCIL

EXPOSED PAD 11:
80% PRINTED SOLDER COVERAGE BY AREA
SCALE:25X

4218878/B 07/2018

NOTES: (continued)

6. Laser cutting apertures with trapezoidal walls and rounded corners may offer better paste release. IPC-7525 may have alternate design recommendations.

IMPORTANT NOTICE AND DISCLAIMER

TI PROVIDES TECHNICAL AND RELIABILITY DATA (INCLUDING DATA SHEETS), DESIGN RESOURCES (INCLUDING REFERENCE DESIGNS), APPLICATION OR OTHER DESIGN ADVICE, WEB TOOLS, SAFETY INFORMATION, AND OTHER RESOURCES "AS IS" AND WITH ALL FAULTS, AND DISCLAIMS ALL WARRANTIES, EXPRESS AND IMPLIED, INCLUDING WITHOUT LIMITATION ANY IMPLIED WARRANTIES OF MERCHANTABILITY, FITNESS FOR A PARTICULAR PURPOSE OR NON-INFRINGEMENT OF THIRD PARTY INTELLECTUAL PROPERTY RIGHTS.

These resources are intended for skilled developers designing with TI products. You are solely responsible for (1) selecting the appropriate TI products for your application, (2) designing, validating and testing your application, and (3) ensuring your application meets applicable standards, and any other safety, security, regulatory or other requirements.

These resources are subject to change without notice. TI grants you permission to use these resources only for development of an application that uses the TI products described in the resource. Other reproduction and display of these resources is prohibited. No license is granted to any other TI intellectual property right or to any third party intellectual property right. TI disclaims responsibility for, and you will fully indemnify TI and its representatives against, any claims, damages, costs, losses, and liabilities arising out of your use of these resources.

TI's products are provided subject to [TI's Terms of Sale](#) or other applicable terms available either on [ti.com](https://www.ti.com) or provided in conjunction with such TI products. TI's provision of these resources does not expand or otherwise alter TI's applicable warranties or warranty disclaimers for TI products.

TI objects to and rejects any additional or different terms you may have proposed.

Mailing Address: Texas Instruments, Post Office Box 655303, Dallas, Texas 75265
Copyright © 2023, Texas Instruments Incorporated