

## TPS763xx-Q1 Low-Power, 150-mA, Low-Dropout Linear Regulators

### 1 Features

- Qualified for Automotive Applications
- AEC-Q100 Qualified With the Following Results:
  - Device Temperature Grade 1: –40°C to +125°C Ambient Operating Temperature
  - Device HBM ESD Classification Level 1C
  - Device CDM ESD Classification Level C3
- 150-mA Low-Dropout Regulator
- Output Voltage: 5 V, 3.3 V, 3 V, 2.5 V, 1.8 V, 1.6 V, and Variable
- Dropout Voltage, Typically 300 mV at 150 mA
- Thermal Protection
- Overcurrent Limitation
- Less Than 2- $\mu$ A Quiescent Current in Shutdown Mode
- –40°C to 125°C Operating Junction Temperature Range
- 5-Pin SOT-23 (DBV) Package

### 2 Applications

- RF: VCOs, Receivers, ADCs
- Cellular phones
- Bluetooth®
- Battery-Powered Systems

### 3 Description

The TPS763xx-Q1 family of low-dropout (LDO) voltage regulators offers the benefits of low-dropout voltage, low-power operation, and miniaturized packaging. These regulators feature low dropout voltages and quiescent currents compared to conventional LDO regulators. Offered in a 5-pin, small outline integrated-circuit SOT-23 package, the TPS763xx-Q1 series devices are ideal for cost-sensitive designs and for applications where board space is at a premium.

A combination of new circuit design and process innovation has enabled the usual pnp pass transistor to be replaced by a PMOS pass element. Because the PMOS pass element behaves as a low-value resistor, the dropout voltage is low—typically 300 mV at 150 mA of load current (TPS76333-Q1)—and is directly proportional to the load current. Since the PMOS pass element is a voltage-driven device, the quiescent current is low (140  $\mu$ A maximum) and is stable over the entire range of output load current (0 mA to 150 mA). Intended for use in portable systems such as laptops and cellular phones, the low-dropout voltage feature and low-power operation result in a significant increase in system battery operating life.

The TPS763xx-Q1 also features a logic-enabled sleep mode to shut down the regulator, reducing quiescent current to 1  $\mu$ A maximum at  $T_J = 25^\circ\text{C}$ . The TPS763xx-Q1 is offered in 1.6-V, 1.8-V, 2.5-V, 3-V, 3.3-V, and 5-V fixed-voltage versions and in a variable version (programmable over the range of 1.5 V to 6.5 V).

#### Device Information<sup>(1)</sup>

PART NUMBER	PACKAGE	BODY SIZE (NOM)
TPS763xx-Q1	SOT-23 (5)	2.90 mm x 1.60 mm

(1) For all available packages, see the orderable addendum at the end of the data sheet.

#### Typical Application Circuit

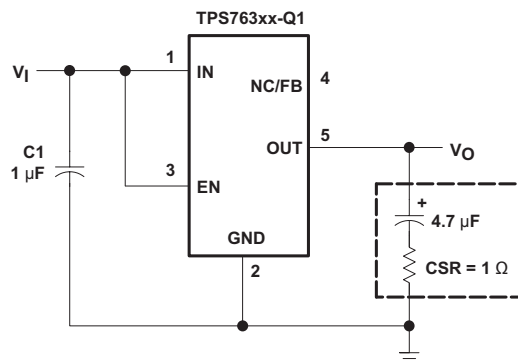

Note: TPS76316-Q1, TPS76318-Q1, TPS76325-Q1, TPS76301-Q1, TPS76333-Q1, TPS76350-Q1 (fixed-voltage options)



## Table of Contents

<b>1 Features</b> .....	<b>1</b>	<b>9 Application and Implementation</b> .....	<b>12</b>
<b>2 Applications</b> .....	<b>1</b>	9.1 Application Information.....	12
<b>3 Description</b> .....	<b>1</b>	9.2 Typical Application .....	12
<b>4 Revision History</b> .....	<b>2</b>	<b>10 Power Supply Recommendations</b> .....	<b>15</b>
<b>5 Voltage Options</b> .....	<b>3</b>	<b>11 Layout</b> .....	<b>15</b>
<b>6 Pin Configuration and Functions</b> .....	<b>3</b>	11.1 Layout Guidelines .....	15
<b>7 Specifications</b> .....	<b>4</b>	11.2 Layout Example .....	15
7.1 Absolute Maximum Ratings .....	4	11.3 Power Dissipation and Junction Temperature .....	15
7.2 ESD Ratings.....	4	<b>12 Device and Documentation Support</b> .....	<b>16</b>
7.3 Recommended Operating Conditions .....	4	12.1 Device Support .....	16
7.4 Thermal Information .....	4	12.2 Documentation Support .....	16
7.5 Electrical Characteristics.....	5	12.3 Related Links .....	16
7.6 Typical Characteristics .....	6	12.4 Community Resource.....	16
<b>8 Detailed Description</b> .....	<b>10</b>	12.5 Trademarks .....	16
8.1 Overview .....	10	12.6 Electrostatic Discharge Caution.....	17
8.2 Functional Block Diagram .....	10	12.7 Glossary .....	17
8.3 Feature Description.....	10	<b>13 Mechanical, Packaging, and Orderable</b>	
8.4 Device Functional Modes.....	11	<b>Information</b> .....	<b>17</b>

## 4 Revision History

NOTE: Page numbers for previous revisions may differ from page numbers in the current version.

Changes from Original (September 2011) to Revision B	Page
• Removed 3.8 V, 2.8 V, and 2.7 V output voltage versions from the data sheet .....	1
• Removed the TPS76327-Q1, TPS76328-Q1, and TPS76338-Q1 parts from the data sheet.....	1
• Added <i>ESD Ratings</i> table, <i>Feature Description</i> section, <i>Device Functional Modes</i> , <i>Application and Implementation</i> section, <i>Power Supply Recommendations</i> section, <i>Layout</i> section, <i>Device and Documentation Support</i> section, and <i>Mechanical, Packaging, and Orderable Information</i> section .....	1
• Deleted <i>Dissipation Ratings</i> .....	6

## 5 Voltage Options

VOLTAGE	PART NUMBER	SYMBOL
Variable	TPS76301QDBVRQ1	BAN
1.6 V	TPS76316QDBVRQ1	BAD
1.8 V	TPS76318QDBVRQ1	BAP
2.5 V	TPS76325QDBVRQ1	BAQ
3 V	TPS76330QDBVRQ1	BAT
3.3 V	TPS76333QDBVRQ1	BAU
5 V	TPS76350QDBVRQ1	BAW

## 6 Pin Configuration and Functions

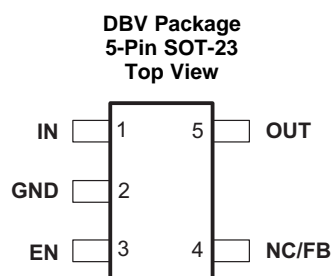

### Pin Functions

PIN		I/O	DESCRIPTION
NAME	NO.		
EN	3	—	Enable input
FB	4	I	Feedback voltage (TPS76301-Q1 only)
GND	2	—	Ground
IN	1	I	Input supply voltage
NC	4	—	No connection (fixed-voltage option only)
OUT	5	O	Regulated output voltage.

## 7 Specifications

### 7.1 Absolute Maximum Ratings

over operating free-air temperature range (unless otherwise noted)<sup>(1)</sup>

	MIN	MAX	UNIT
Input voltage	-0.3	10	V
Voltage at EN			V
Voltage on OUT, FB			V
Peak output current	Internally limited		
Operating junction temperature, T <sub>J</sub>	-40	150	°C
Storage temperature, T <sub>stg</sub>	-65	150	°C

(1) Stresses beyond those listed under *Absolute Maximum Ratings* may cause permanent damage to the device. These are stress ratings only, which do not imply functional operation of the device at these or any other conditions beyond those indicated under *Recommended Operating Conditions*. Exposure to absolute-maximum-rated conditions for extended periods may affect device reliability.

### 7.2 ESD Ratings

		VALUE	UNIT
V <sub>(ESD)</sub>	Electrostatic discharge	Human-body model (HBM), per AEC Q100-002 <sup>(1)</sup>	±2000
		Charged-device model (CDM), per AEC Q100-011	±500

(1) AEC Q100-002 indicates that HBM stressing shall be in accordance with the ANSI/ESDA/JEDEC JS-001 specification.

### 7.3 Recommended Operating Conditions

over operating free-air temperature range (unless otherwise noted)

	MIN	NOM	MAX	UNIT
Input voltage, V <sub>I</sub>	2.7		10	V
Continuous output current, I <sub>O</sub>	0		150	mA
Operating junction temperature, T <sub>J</sub>	-40		125	°C

### 7.4 Thermal Information

THERMAL METRIC <sup>(1)</sup>		TPS763xx-Q1	UNIT
		DBV (SOT-23)	
		5 PINS	
R <sub>θJA</sub>	Junction-to-ambient thermal resistance	205.2	°C/W
R <sub>θJC(top)</sub>	Junction-to-case (top) thermal resistance	11.83	°C/W
R <sub>θJB</sub>	Junction-to-board thermal resistance	34.8	°C/W
Ψ <sub>JT</sub>	Junction-to-top characterization parameter	12.2	°C/W
Ψ <sub>JB</sub>	Junction-to-board characterization parameter	33.9	°C/W
R <sub>θJC(bot)</sub>	Junction-to-case (bottom) thermal resistance	N/A	°C/W

(1) For more information about traditional and new thermal metrics, see the *Semiconductor and IC Package Thermal Metrics* application report, [SPRA953](#).

## 7.5 Electrical Characteristics

 over operating free-air temperature range,  $V_I = V_{O(\text{typ})} + 1 \text{ V}$ ,  $I_O = 1 \text{ mA}$ ,  $EN = IN$ ,  $C_O = 4.7 \mu\text{F}$  (unless otherwise noted)

PARAMETER		TEST CONDITIONS	MIN	TYP	MAX	UNIT
$V_O$	Output voltage	3.25 V > $V_I \geq 2.7 \text{ V}$ , $2.5 \text{ V} \geq V_O \geq 1.5 \text{ V}$ , $I_O = 1 \text{ mA}$ to 75 mA, $T_J = 25^\circ\text{C}$	0.98 $V_O$	$V_O$	1.02 $V_O$	V
		3.25 V > $V_I \geq 2.7 \text{ V}$ , $2.5 \text{ V} \geq V_O \geq 1.5 \text{ V}$ , $I_O = 1 \text{ mA}$ to 75 mA,	0.97 $V_O$	$V_O$	1.03 $V_O$	
		$V_I \geq 3.25 \text{ V}$ , $5 \text{ V} \geq V_O \geq 1.5 \text{ V}$ , $I_O = 1 \text{ mA}$ to 100 mA, $T_J = 25^\circ\text{C}$	0.98 $V_O$	$V_O$	1.02 $V_O$	
		$V_I \geq 3.25 \text{ V}$ , $5 \text{ V} \geq V_O \geq 1.5 \text{ V}$ , $I_O = 1 \text{ mA}$ to 100 mA,	0.97 $V_O$	$V_O$	1.03 $V_O$	
		$V_I \geq 3.25 \text{ V}$ , $5 \text{ V} \geq V_O \geq 1.5 \text{ V}$ , $I_O = 1 \text{ mA}$ to 150 mA, $T_J = 25^\circ\text{C}$	0.975 $V_O$	$V_O$	1.025 $V_O$	
		$V_I \geq 3.25 \text{ V}$ , $5 \text{ V} \geq V_O \geq 1.5 \text{ V}$ , $I_O = 1 \text{ mA}$ to 150 mA,	0.9625 $V_O$	$V_O$	1.0375 $V_O$	
	TPS76316-Q1	$V_I = 2.7 \text{ V}$ , $1 \text{ mA} < I_O < 75 \text{ mA}$ , $T_J = 25^\circ\text{C}$	1.568	1.6	1.632	V
		$V_I = 2.7 \text{ V}$ , $1 \text{ mA} < I_O < 75 \text{ mA}$ , $T_J = 25^\circ\text{C}$	1.552	1.6	1.648	
		$V_I = 3.25 \text{ V}$ , $1 \text{ mA} < I_O < 100 \text{ mA}$ , $T_J = 25^\circ\text{C}$	1.568	1.6	1.632	
		$V_I = 3.25 \text{ V}$ , $1 \text{ mA} < I_O < 100 \text{ mA}$ , $T_J = 25^\circ\text{C}$	1.552	1.6	1.648	
		$V_I = 3.25 \text{ V}$ , $1 \text{ mA} < I_O < 150 \text{ mA}$ , $T_J = 25^\circ\text{C}$	1.56	1.6	1.64	
		$V_I = 3.25 \text{ V}$ , $1 \text{ mA} < I_O < 150 \text{ mA}$ , $T_J = 25^\circ\text{C}$	1.536	1.6	1.664	
	TPS76318-Q1	$V_I = 2.7 \text{ V}$ , $1 \text{ mA} < I_O < 75 \text{ mA}$ , $T_J = 25^\circ\text{C}$	1.764	1.8	1.836	V
		$V_I = 2.7 \text{ V}$ , $1 \text{ mA} < I_O < 75 \text{ mA}$	1.746	1.8	1.854	
		$V_I = 3.25 \text{ V}$ , $1 \text{ mA} < I_O < 100 \text{ mA}$ , $T_J = 25^\circ\text{C}$	1.764	1.8	1.836	
		$V_I = 3.25 \text{ V}$ , $1 \text{ mA} < I_O < 100 \text{ mA}$	1.746	1.8	1.854	
		$V_I = 3.25 \text{ V}$ , $1 \text{ mA} < I_O < 150 \text{ mA}$ , $T_J = 25^\circ\text{C}$	1.755	1.8	1.845	
		$V_I = 3.25 \text{ V}$ , $1 \text{ mA} < I_O < 150 \text{ mA}$	1.733	1.8	1.867	
	TPS76325-Q1	$I_O = 1 \text{ mA}$ to 100 mA, $T_J = 25^\circ\text{C}$	2.45	2.5	2.55	V
		$I_O = 1 \text{ mA}$ to 100 mA	2.425	2.5	2.575	
		$I_O = 1 \text{ mA}$ to 150 mA, $T_J = 25^\circ\text{C}$	2.438	2.5	2.562	
		$I_O = 1 \text{ mA}$ to 150 mA	2.407	2.5	2.593	
	TPS76330-Q1	$I_O = 1 \text{ mA}$ to 100 mA, $T_J = 25^\circ\text{C}$	2.94	3	3.06	V
		$I_O = 1 \text{ mA}$ to 100 mA	2.91	3	3.09	
		$I_O = 1 \text{ mA}$ to 150 mA, $T_J = 25^\circ\text{C}$	2.925	3	3.075	
		$I_O = 1 \text{ mA}$ to 150 mA	2.888	3	3.112	
	TPS76333-Q1	$I_O = 1 \text{ mA}$ to 100 mA, $T_J = 25^\circ\text{C}$	3.234	3.3	3.366	V
$I_O = 1 \text{ mA}$ to 100 mA		3.201	3.3	3.399		
$I_O = 1 \text{ mA}$ to 150 mA, $T_J = 25^\circ\text{C}$		3.218	3.3	3.382		
$I_O = 1 \text{ mA}$ to 150 mA		3.177	3.3	3.423		
TPS76350-Q1	$I_O = 1 \text{ mA}$ to 100 mA, $T_J = 25^\circ\text{C}$	4.875	5	5.125	V	
	$I_O = 1 \text{ mA}$ to 100 mA	4.825	5	5.175		
	$I_O = 1 \text{ mA}$ to 150 mA, $T_J = 25^\circ\text{C}$	4.750	5	5.15		
	$I_O = 1 \text{ mA}$ to 150 mA	4.80	5	5.2		
$I_{(Q)}$	Quiescent current (GND) terminal current	$I_O = 0 \text{ mA}$ to 150 mA, $T_J = 25^\circ\text{C}^{(1)}$		85	100	$\mu\text{A}$
		$I_O = 0 \text{ mA}$ to 150 mA, see			140	
Standby current		$EN < 0.5 \text{ V}$ , $T_J = 25^\circ\text{C}$		0.5	1	$\mu\text{A}$
		$EN < 0.5 \text{ V}$			2	
$V_n$	Output noise voltage	$BW = 300 \text{ Hz}$ to 50 kHz, $C_O = 10 \mu\text{F}$ , $T_J = 25^\circ\text{C}^{(2)}$		140		$\mu\text{V}$
PSRR	Ripple rejection	$f = 1 \text{ kHz}$ , $C_O = 10 \mu\text{F}$ , $T_J = 25^\circ\text{C}^{(2)}$		60		dB
Current limit		$T_J = 25^\circ\text{C}$ , see <sup>(3)</sup>	0.5	0.8	1.5	A
Output voltage line regulation ( $\Delta V_O/V_O$ ), (see <sup>(3)</sup> )		$V_O + 1 \text{ V} < V_I \leq 10 \text{ V}$ , $V_I \geq 3.5 \text{ V}$ , $T_J = 25^\circ\text{C}$		0.04	0.07	%V
		$V_O + 1 \text{ V} < V_I \leq 10 \text{ V}$ , $V_I \geq 3.5 \text{ V}$			0.1	
$V_{IH}$	EN high level input	See <sup>(2)</sup>		1.4	2	V
$V_{IL}$	EN low level input	See <sup>(2)</sup>	0.5	1.2		
$I_i$	EN input current	$EN = 0 \text{ V}$		-0.01	-0.5	$\mu\text{a}$
		$EN = IN$		-0.01	-0.5	

 (1) Minimum IN operating voltage is 2.7 V or  $V_{O(\text{typ})} + 1 \text{ V}$ , whichever is greater.

 (2) Test condition includes: output voltage  $V_O = 0 \text{ V}$  (for variable device FB is shorted to  $V_O$ ) and pulse duration = 10 ms.

 (3) If  $V_O < 2.5 \text{ V}$  and  $V_{I\text{max}} = 10 \text{ V}$ ,  $V_{I\text{min}} = 3.5 \text{ V}$ :

## Electrical Characteristics (continued)

over operating free-air temperature range,  $V_I = V_{O(typ)} + 1\text{ V}$ ,  $I_O = 1\text{ mA}$ ,  $EN = IN$ ,  $C_O = 4.7\text{ }\mu\text{F}$  (unless otherwise noted)

PARAMETER		TEST CONDITIONS	MIN	TYP	MAX	UNIT
$V_{DO}$	Dropout voltage	TPS76325-Q1	$I_O = 0\text{ mA}$ , $T_J = 25^\circ\text{C}$		0.2	
			$I_O = 1\text{ mA}$ , $T_J = 25^\circ\text{C}$		3	
			$I_O = 50\text{ mA}$ , $T_J = 25^\circ\text{C}$		120	150
			$I_O = 50\text{ mA}$			200
			$I_O = 75\text{ mA}$ , $T_J = 25^\circ\text{C}$		180	225
			$I_O = 75\text{ mA}$			300
			$I_O = 100\text{ mA}$ , $T_J = 25^\circ\text{C}$		240	300
			$I_O = 100\text{ mA}$			400
			$I_O = 150\text{ mA}$ , $T_J = 25^\circ\text{C}$		360	450
	$I_O = 150\text{ mA}$			600		
	Dropout voltage	TPS76333-Q1	$I_O = 0\text{ mA}$ , $T_J = 25^\circ\text{C}$		0.2	
			$I_O = 1\text{ mA}$ , $T_J = 25^\circ\text{C}$		3	
			$I_O = 50\text{ mA}$ , $T_J = 25^\circ\text{C}$		100	125
			$I_O = 50\text{ mA}$			166
			$I_O = 75\text{ mA}$ , $T_J = 25^\circ\text{C}$		150	188
			$I_O = 75\text{ mA}$			250
			$I_O = 100\text{ mA}$ , $T_J = 25^\circ\text{C}$		200	250
			$I_O = 100\text{ mA}$			333
			$I_O = 150\text{ mA}$ , $T_J = 25^\circ\text{C}$		300	375
	$I_O = 150\text{ mA}$			500		
	Dropout voltage	TPS76350-Q1	$I_O = 0\text{ mA}$ , $T_J = 25^\circ\text{C}$		0.2	
			$I_O = 1\text{ mA}$ , $T_J = 25^\circ\text{C}$		2	
			$I_O = 50\text{ mA}$ , $T_J = 25^\circ\text{C}$		60	75
			$I_O = 50\text{ mA}$			100
			$I_O = 75\text{ mA}$ , $T_J = 25^\circ\text{C}$		90	113
			$I_O = 75\text{ mA}$			150
			$I_O = 100\text{ mA}$ , $T_J = 25^\circ\text{C}$		120	150
$I_O = 100\text{ mA}$					200	
$I_O = 150\text{ mA}$ , $T_J = 25^\circ\text{C}$				180	225	
$I_O = 150\text{ mA}$			300			

## 7.6 Typical Characteristics

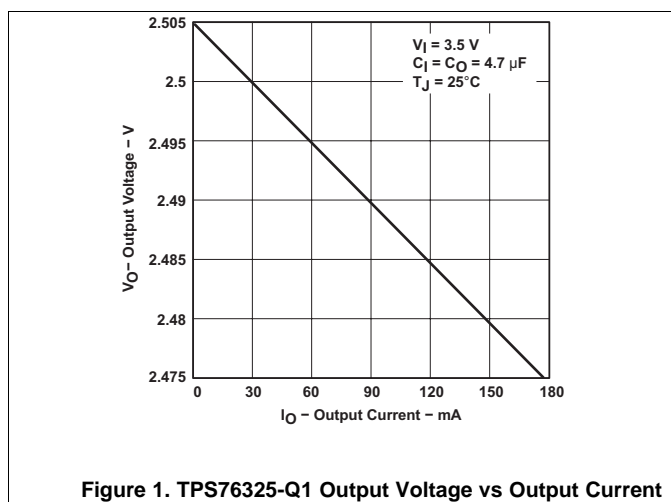

Figure 1. TPS76325-Q1 Output Voltage vs Output Current

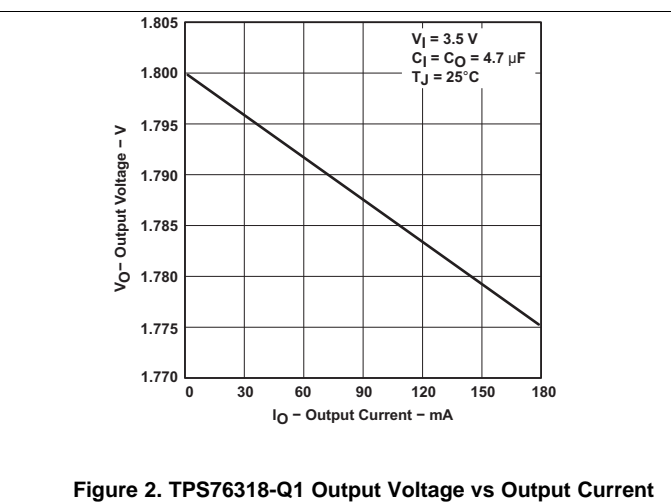

Figure 2. TPS76318-Q1 Output Voltage vs Output Current

Typical Characteristics (continued)

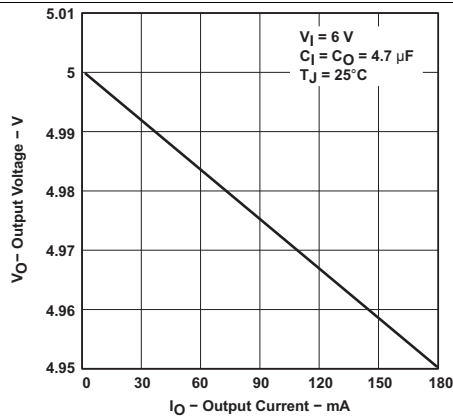

Figure 3. TPS76350-Q1 Output Voltage vs Output Current

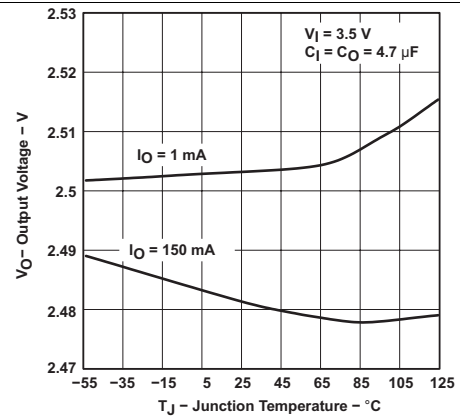

Figure 4. TPS76325-Q1 Output Voltage vs Free-Air Temperature

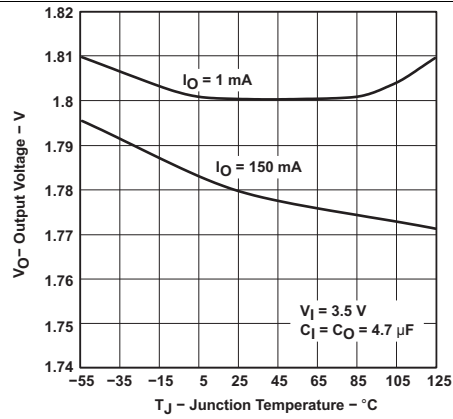

Figure 5. TPS76318-Q1 Output Voltage vs Free-Air Temperature

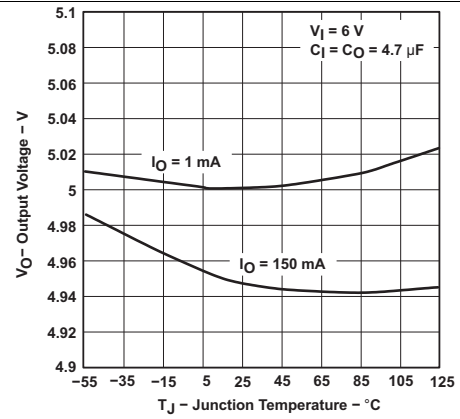

Figure 6. TPS76350-Q1 Output Voltage vs Free-Air Temperature

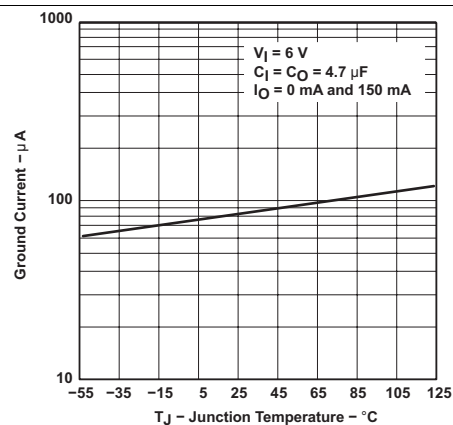

Figure 7. TPS76350-Q1 Ground Current vs Free-Air Temperature

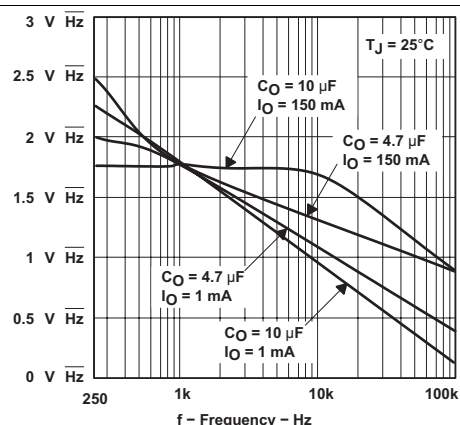
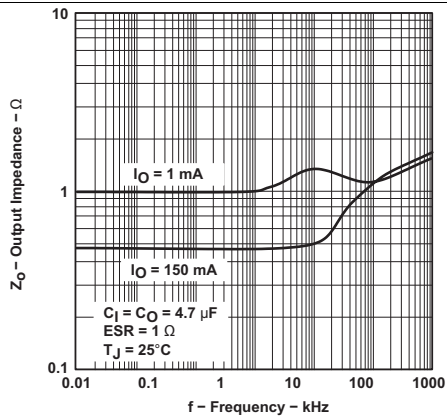
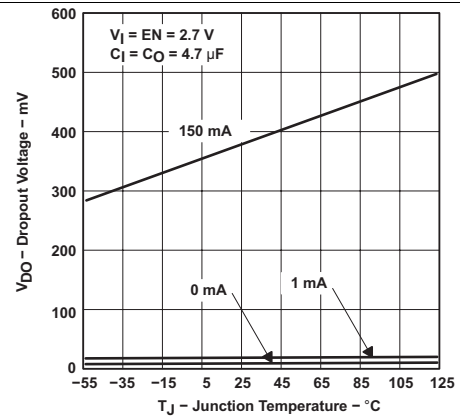

Figure 8. Output Noise vs Frequency

**Typical Characteristics (continued)**



**Figure 9. Output Impedance vs Frequency**



**Figure 10. TPS76325-Q1 Dropout Voltage vs Free-Air Temperature**

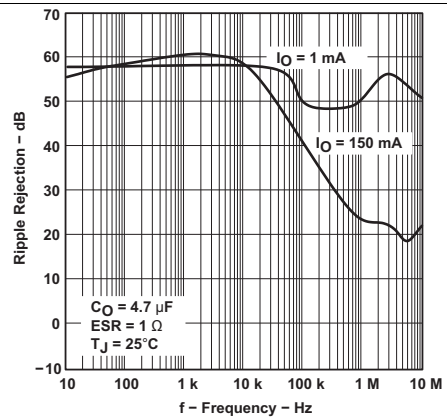

**Figure 11. TPS76325-Q1 Ripple Rejection vs Frequency**

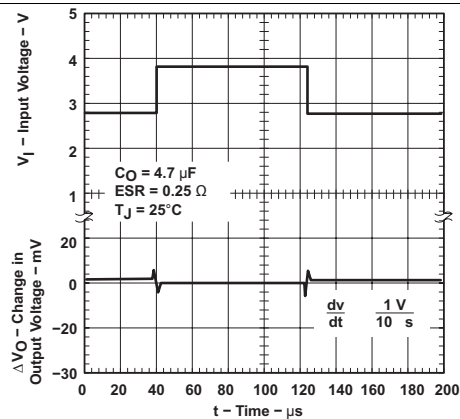

**Figure 12. TPS76318-Q1 Line Transient Response**

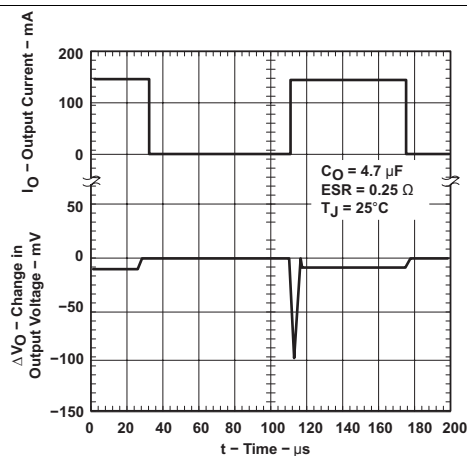

**Figure 13. TPS76318-Q1 Load Transient Response**

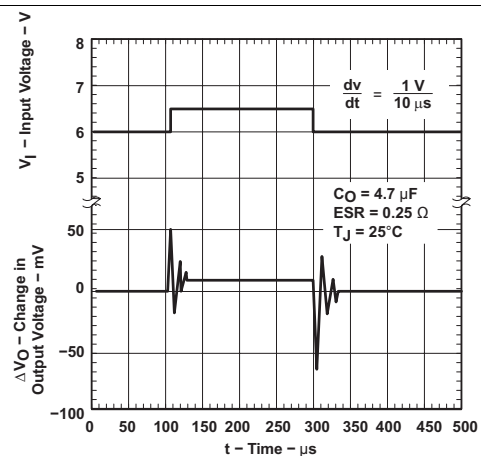

**Figure 14. TPS76350-Q1 Line Transient Response**



Typical Characteristics (continued)

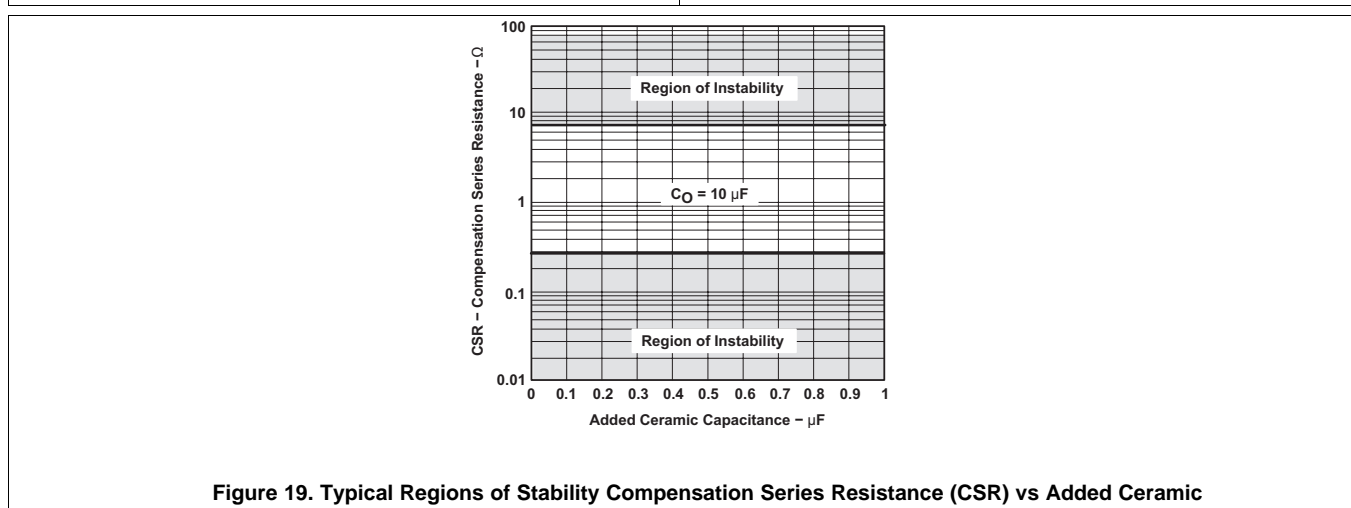
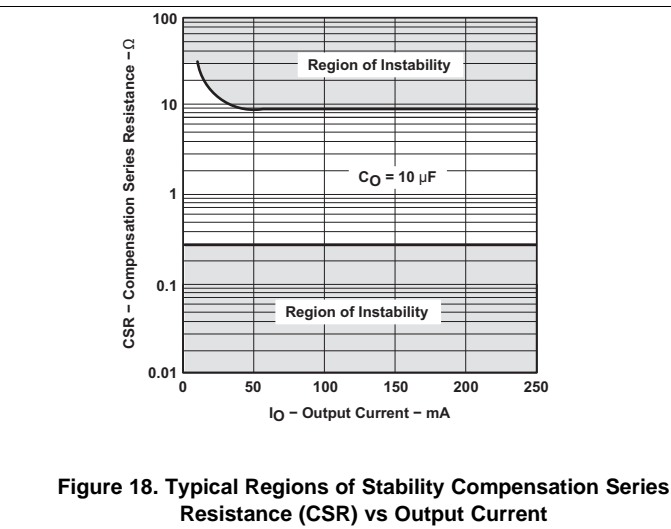
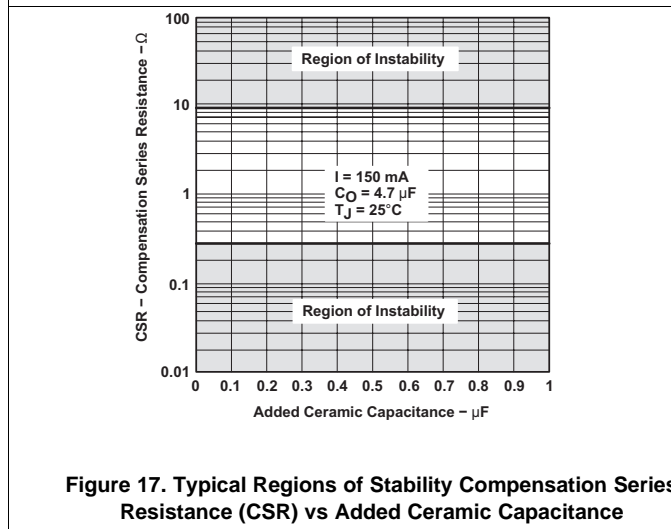
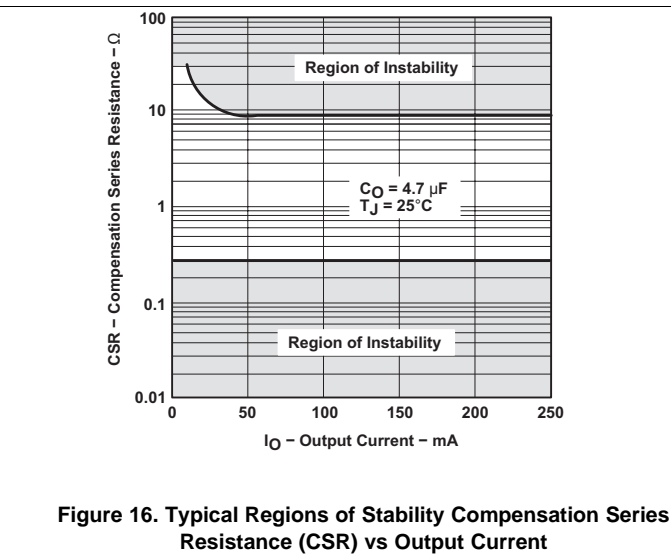
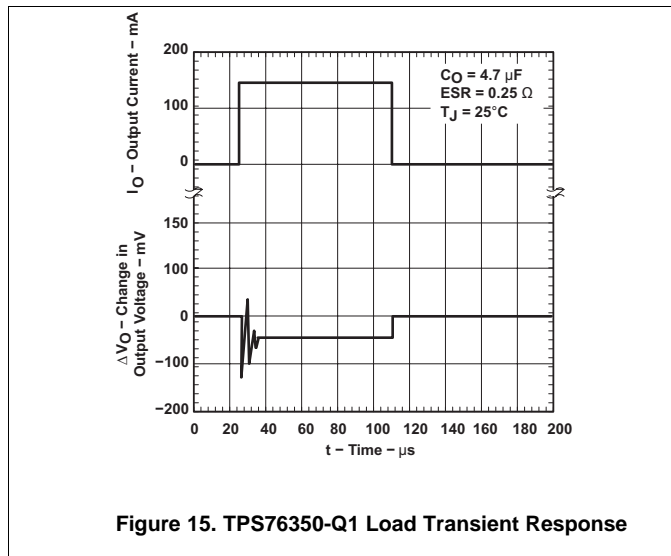

## 8 Detailed Description

### 8.1 Overview

The TPS763xx-Q1 low-dropout (LDO) regulators are new families of regulators which have been optimized for use in battery-operated equipment and feature low dropout voltages, low quiescent current (140  $\mu$ A), and an enable input to reduce supply currents to less than 2  $\mu$ A when the regulator is turned off.

### 8.2 Functional Block Diagram

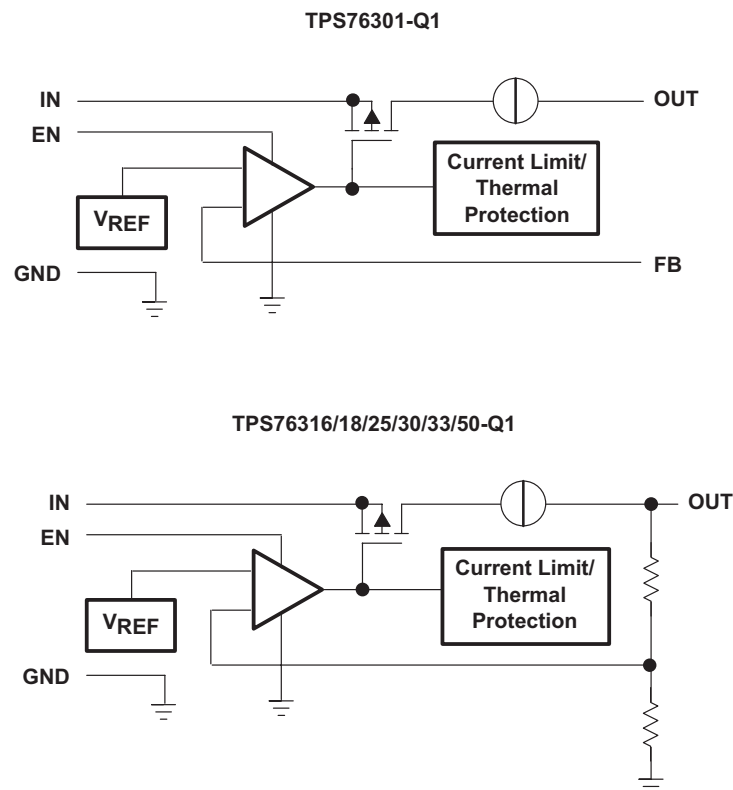

### 8.3 Feature Description

#### 8.3.1 Regulator Protection

The TPS763xx-Q1 pass element has a built-in back diode that safely conducts reverse currents when the input voltage drops below the output voltage (for example, during power down). Current is conducted from the output to the input and is not internally limited. If extended reverse voltage is anticipated, external limiting might be appropriate.

The TPS763xx-Q1 also features internal current limiting and thermal protection. During normal operation, the TPS763xx-Q1 limits output current to approximately 800 mA. When current limiting engages, the output voltage scales back linearly until the overcurrent condition ends. While current limiting is designed to prevent gross device failure, care should be taken not to exceed the power dissipation ratings of the package. If the temperature of the device exceeds 165°C, thermal-protection circuitry shuts it down. Once the device has cooled down to below 140°C, the regulator operation resumes.

## 8.4 Device Functional Modes

### 8.4.1 Normal Operation

The device regulates to the nominal output voltage under the following conditions:

- The input voltage is at least as high as  $V_{IN(min)}$ .
- The input voltage is greater than the nominal output voltage added to the dropout voltage.
- The enable voltage is greater than  $V_{EN(min)}$ .
- The output current is less than the current limit.
- The device junction temperature is less than the maximum specified junction temperature.

### 8.4.2 Dropout Operation

If the input voltage is lower than the nominal output voltage plus the specified dropout voltage, but all other conditions are met for normal operation, the device operates in dropout mode. In this mode of operation, the output voltage is the same as the input voltage minus the dropout voltage. The transient performance of the device is significantly degraded because the pass device is in the linear region and no longer controls the current through the LDO. Line or load transients in dropout can result in large output voltage deviations.

### 8.4.3 Disabled

The device is disabled under the following conditions:

- The enable voltage is less than the enable falling threshold voltage or has not yet exceeded the enable rising threshold.
- The device junction temperature is greater than the thermal shutdown temperature.
- The input voltage is less than  $UVLO_{falling}$ .

[Table 1](#) shows the conditions that lead to the different modes of operation.

**Table 1. Device Functional Mode Comparison**

OPERATING MODE	PARAMETER			
	$V_{IN}$	$V_{EN}$	$I_{OUT}$	$T_J$
Normal mode	$V_{IN} > V_{OUT(nom)} + V_{DO}$ and $V_{IN} > V_{IN(min)}$	$V_{EN} > V_{EN(high)}$	$I_{OUT} < I_{LIM}$	$T_J < 125^{\circ}C$
Dropout mode	$V_{IN(min)} < V_{IN} < V_{OUT(nom)} + V_{DO}$	$V_{EN} > V_{EN(high)}$	—	$T_J < 125^{\circ}C$
Disabled mode (any true condition disables the device)	$V_{IN} < UVLO_{falling}$	$V_{EN} < V_{EN(low)}$	—	$T_J > 165^{\circ}C^{(1)}$

(1) Approximate value for thermal shutdown

## 9 Application and Implementation

### NOTE

Information in the following applications sections is not part of the TI component specification, and TI does not warrant its accuracy or completeness. TI's customers are responsible for determining suitability of components for their purposes. Customers should validate and test their design implementation to confirm system functionality.

### 9.1 Application Information

The TPS763xx-Q1 low-dropout (LDO) regulators are new families of regulators which have been optimized for use in battery-operated equipment and feature low dropout voltages, low quiescent current (140  $\mu$ A), and an enable input to reduce supply currents to less than 2  $\mu$ A when the regulator is turned off.

The TPS763xx-Q1 uses a PMOS pass element to dramatically reduce both dropout voltage and supply current over more conventional PNP pass element LDO designs. The PMOS pass element is a voltage-controlled device that, unlike a PNP transistor, does not require increased drive current as output current increases. Supply current in the TPS763xx-Q1 is essentially constant from no-load to maximum load.

Current limiting and thermal protection prevent damage by excessive output current and/or power dissipation. The device switches into a constant-current mode at approximately 1 A; further load reduces the output voltage instead of increasing the output current. The thermal protection shuts the regulator off if the junction temperature rises above 165°C. Recovery is automatic when the junction temperature drops approximately 25°C below the high temperature trip point. The PMOS pass element includes a back diode that safely conducts reverse current when the input voltage level drops below the output voltage level.

A logic low on the enable input, EN shuts off the output and reduces the supply current to less than 2  $\mu$ A. EN should be tied high in applications where the shutdown feature is not used.

### 9.2 Typical Application

A typical application circuit is shown in [Figure 20](#).

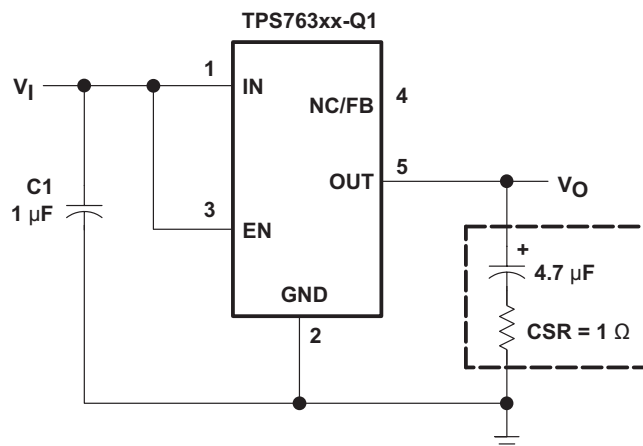

Note: TPS76316-Q1, TPS76318-Q1, TPS76325-Q1, TPS76301-Q1, TPS76333-Q1, TPS76350-Q1 (fixed-voltage options)

**Figure 20. Typical Application Circuit**

## Typical Application (continued)

### 9.2.1 Design Requirements

Table 2 lists the design requirements.

**Table 2. Design Parameters**

PARAMETER	DESIGN REQUIREMENTS
Input voltage	2.7 to 10 V
Output voltage	2.5 to 6.45 V
Output current	0 to 150 mA

### 9.2.2 Detailed Design Procedure

#### 9.2.2.1 External Capacitor Requirements

Although not required, a 0.047  $\mu\text{F}$  or larger ceramic bypass input capacitor, connected between IN and GND and located close to the TPS763xx-Q1, is recommended to improve transient response and noise rejection. A higher-value electrolytic input capacitor may be necessary if large, fast-rise-time load transients are anticipated and the device is located several inches from the power source.

Like all low dropout regulators, the TPS763xx-Q1 requires an output capacitor connected between OUT and GND to stabilize the internal loop control. The minimum recommended capacitance value is 4.7  $\mu\text{F}$  and the ESR (equivalent series resistance) must be between 0.3  $\Omega$  and 10  $\Omega$ . Capacitor values of 4.7  $\mu\text{F}$  or larger are acceptable, provided the ESR is less than 10  $\Omega$ . Solid tantalum electrolytic, aluminum electrolytic, and multilayer ceramic capacitors are all suitable, provided they meet the requirements described above. Most of the commercially available 4.7- $\mu\text{F}$  surface-mount solid tantalum capacitors, including devices from Sprague, Kemet, and Nichico, meet the ESR requirements stated above.

**Table 3. Capacitor Selection**

PART NO.	MFR.	VALUE	MAX ESR	SIZE (H x L x W)
T494B475K016AS	KEMET	4.7 $\mu\text{F}$	1.5 $\Omega$	1.9 x 3.5 x 2.8
195D106x0016x2T	SPRAGUE	10 $\mu\text{F}$	1.5 $\Omega$	1.3 x 7.0 x 2.7
695D106x003562T	SPRAGUE	10 $\mu\text{F}$	1.3 $\Omega$	2.5 x 7.6 x 2.5
TPSC475K035R0600	AVX	4.7 $\mu\text{F}$	0.6 $\Omega$	2.6 x 6.0 x 3.2

#### 9.2.2.2 Output Voltage Programming

The output voltage of the TPS76301-Q1 adjustable regulator is programmed using an external resistor divided as shown in figure 21. The output voltage is calculated using Equation 1.

$$V_O = 0.995 \times V_{REF} \times (1 + R1/R2)$$

where

- $V_{REF} = 1.192$  V typical (the internal reference voltage)
  - 0.995 is a constant used to center the load regulator (1%)
- (1)

Resistors R1 and R2 should be chosen for approximately 7- $\mu\text{A}$  divider current. Lower value resistors can be used, but offer no inherent advantage and waste more power. Higher values should be avoided as leakage currents at FB increase the output voltage error. The recommended design procedure is to choose R2 = 169 k $\Omega$  to set the divider current at 7  $\mu\text{A}$  and then calculate R1 using Equation 2.

$$\text{Line Reg. (mV)} = (\% / \text{V}) \times \frac{V_O(V_{I\text{max}} - (V_O + 1))}{100} \times 1000$$
(2)

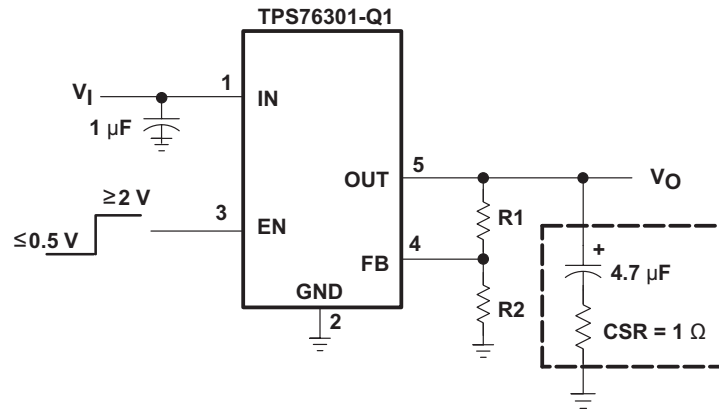

Figure 21. TPS76301-Q1 Adjustable LDO Regulator Programming

Table 4. Output Voltage Programming Guide

OUTPUT VOLTAGE (V)	DIVIDER RESISTANCE (kΩ) <sup>(1)</sup>	
	R1	R2
2.5	187	169
3.3	301	169
3.6	348	169
4	402	169
5	549	169
6.45	750	169

(1) 1% values shown.

### 9.2.3 Application Curves

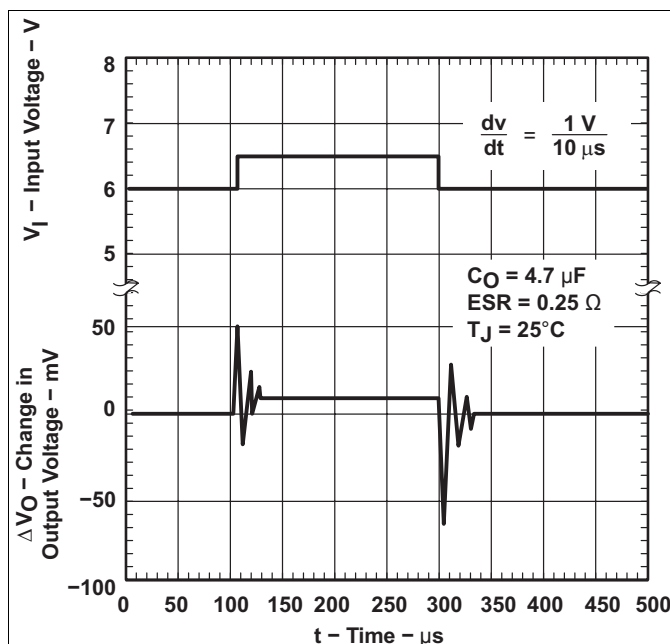

Figure 22. TPS76350-Q1 Line Transient Response

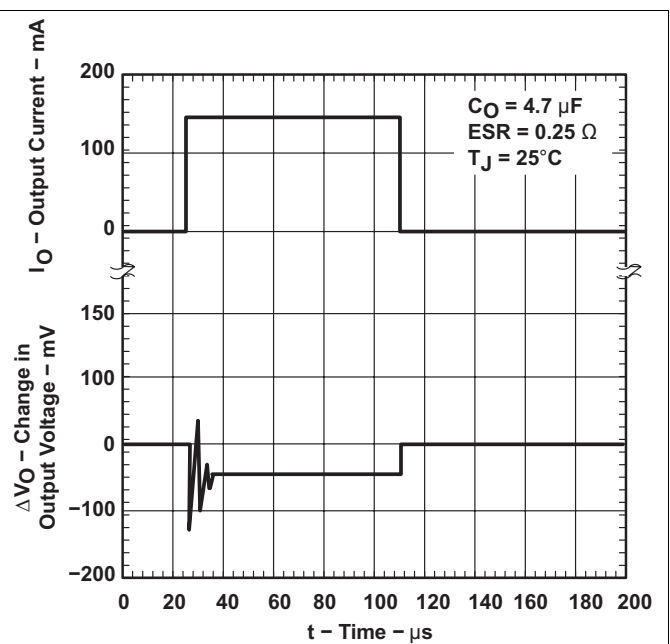

Figure 23. TPS76350-Q1 Load Transient Response

## 10 Power Supply Recommendations

These devices are designed to operate from an input voltage supply range from 2.7 V to 10 V. The input voltage range must provide adequate headroom in order for the device to have a regulated output. This input supply must be well-regulated and stable. Although not required, a 0.047- $\mu$ F or larger ceramic bypass input capacitor, connected between IN and GND and located close to the TPS763xx-Q1, is recommended to improve transient response and noise rejection. A higher-value electrolytic input capacitor may be necessary if large, fast-rise-time load transients are anticipated and the device is located several inches from the power source.

## 11 Layout

### 11.1 Layout Guidelines

Layout is a critical part of good power-supply design. There are several signal paths that conduct fast-changing currents or voltages that can interact with stray inductance or parasitic capacitance to generate noise or degrade the power-supply performance. To help eliminate these problems, the IN pin should be bypassed to ground with a low ESR ceramic bypass capacitor with an X5R or X7R dielectric.

Equivalent series inductance (ESL) and equivalent series resistance (ESR) must be minimized to maximize performance and ensure stability. Every capacitor ( $C_{IN}$ ,  $C_{OUT}$ ) must be placed as close as possible to the device and on the same side of the PCB as the regulator itself.

Do not place any of the capacitors on the opposite side of the PCB from where the regulator is installed. The use of vias and long traces is strongly discouraged because these circuits may impact system performance negatively, and even cause instability.

### 11.2 Layout Example

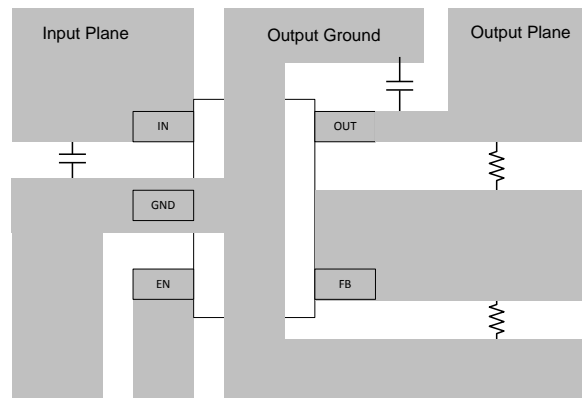

**Figure 24. Recommended Layout**

### 11.3 Power Dissipation and Junction Temperature

Specified regulator operation is assured to a junction temperature of 125°C; the maximum junction temperature allowable to avoid damaging the device is 150°C. This restriction limits the power dissipation the regulator can handle in any given application. To ensure the junction temperature is within acceptable limits, calculate the maximum allowable dissipation,  $P_{D(max)}$  and the actual dissipation,  $P_D$ , which must be less than or equal to  $P_{D(max)}$ .

The maximum-power-dissipation limit is determined using [Equation 3](#).

$$P_{D(max)} = T_{J(max)} - T_A / R_{\theta JA}$$

where

- $T_{J(max)}$  is the maximum allowable junction temperature
- $R_{\theta JA}$  is the thermal resistance junction-to-ambient for the package, see [Thermal Information](#)
- $T_A$  is the ambient temperature

(3)

## Power Dissipation and Junction Temperature (continued)

Use Equation 4 to calculate the regulator dissipation.

$$P_D = (V_I - V_O) \times I_O \quad (4)$$

Power dissipation resulting from quiescent current is negligible.

## 12 Device and Documentation Support

### 12.1 Device Support

#### 12.1.1 Third-Party Products Disclaimer

TI'S PUBLICATION OF INFORMATION REGARDING THIRD-PARTY PRODUCTS OR SERVICES DOES NOT CONSTITUTE AN ENDORSEMENT REGARDING THE SUITABILITY OF SUCH PRODUCTS OR SERVICES OR A WARRANTY, REPRESENTATION OR ENDORSEMENT OF SUCH PRODUCTS OR SERVICES, EITHER ALONE OR IN COMBINATION WITH ANY TI PRODUCT OR SERVICE.

### 12.2 Documentation Support

#### 12.2.1 Related Documentation

*TPS793xx-Q1 Ultralow-Noise, High-PSRR, Fast RF 200-mA Low-Dropout Linear Regulators*, [SGLS162](#)

### 12.3 Related Links

The table below lists quick access links. Categories include technical documents, support and community resources, tools and software, and quick access to sample or buy.

**Table 5. Related Links**

PARTS	PRODUCT FOLDER	SAMPLE & BUY	TECHNICAL DOCUMENTS	TOOLS & SOFTWARE	SUPPORT & COMMUNITY
TPS763-Q1	<a href="#">Click here</a>	<a href="#">Click here</a>	<a href="#">Click here</a>	<a href="#">Click here</a>	<a href="#">Click here</a>
TPS76301-Q1	<a href="#">Click here</a>	<a href="#">Click here</a>	<a href="#">Click here</a>	<a href="#">Click here</a>	<a href="#">Click here</a>
TPS76316-Q1	<a href="#">Click here</a>	<a href="#">Click here</a>	<a href="#">Click here</a>	<a href="#">Click here</a>	<a href="#">Click here</a>
TPS76318-Q1	<a href="#">Click here</a>	<a href="#">Click here</a>	<a href="#">Click here</a>	<a href="#">Click here</a>	<a href="#">Click here</a>
TPS76325-Q1	<a href="#">Click here</a>	<a href="#">Click here</a>	<a href="#">Click here</a>	<a href="#">Click here</a>	<a href="#">Click here</a>
TPS76330-Q1	<a href="#">Click here</a>	<a href="#">Click here</a>	<a href="#">Click here</a>	<a href="#">Click here</a>	<a href="#">Click here</a>
TPS76333-Q1	<a href="#">Click here</a>	<a href="#">Click here</a>	<a href="#">Click here</a>	<a href="#">Click here</a>	<a href="#">Click here</a>
TPS76350-Q1	<a href="#">Click here</a>	<a href="#">Click here</a>	<a href="#">Click here</a>	<a href="#">Click here</a>	<a href="#">Click here</a>

### 12.4 Community Resource

The following links connect to TI community resources. Linked contents are provided "AS IS" by the respective contributors. They do not constitute TI specifications and do not necessarily reflect TI's views; see TI's [Terms of Use](#).

**TI E2E™ Online Community** *TI's Engineer-to-Engineer (E2E) Community*. Created to foster collaboration among engineers. At e2e.ti.com, you can ask questions, share knowledge, explore ideas and help solve problems with fellow engineers.

**Design Support** *TI's Design Support* Quickly find helpful E2E forums along with design support tools and contact information for technical support.

### 12.5 Trademarks

E2E is a trademark of Texas Instruments.

All other trademarks are the property of their respective owners.



## 12.6 Electrostatic Discharge Caution



These devices have limited built-in ESD protection. The leads should be shorted together or the device placed in conductive foam during storage or handling to prevent electrostatic damage to the MOS gates.

## 12.7 Glossary

[SLYZ022](#) — *TI Glossary*.

This glossary lists and explains terms, acronyms, and definitions.

## 13 Mechanical, Packaging, and Orderable Information

The following pages include mechanical, packaging, and orderable information. This information is the most current data available for the designated devices. This data is subject to change without notice and revision of this document. For browser-based versions of this data sheet, refer to the left-hand navigation.

**PACKAGING INFORMATION**

Orderable Device	Status (1)	Package Type	Package Drawing	Pins	Package Qty	Eco Plan (2)	Lead finish/ Ball material (6)	MSL Peak Temp (3)	Op Temp (°C)	Device Marking (4/5)	Samples
TPS76301QDBVRG4Q1	ACTIVE	SOT-23	DBV	5	3000	RoHS & Green	NIPDAU	Level-1-260C-UNLIM	-40 to 125	BAN	<a href="#">Samples</a>
TPS76301QDBVRQ1	ACTIVE	SOT-23	DBV	5	3000	RoHS & Green	NIPDAU	Level-1-260C-UNLIM	-40 to 125	BAN	<a href="#">Samples</a>
TPS76316QDBVRG4Q1	ACTIVE	SOT-23	DBV	5	3000	RoHS & Green	NIPDAU	Level-1-260C-UNLIM	-40 to 125	BAO	<a href="#">Samples</a>
TPS76318QDBVRG4Q1	ACTIVE	SOT-23	DBV	5	3000	RoHS & Green	NIPDAU	Level-1-260C-UNLIM	-40 to 125	BAP	<a href="#">Samples</a>
TPS76318QDBVRQ1	ACTIVE	SOT-23	DBV	5	3000	RoHS & Green	NIPDAU	Level-1-260C-UNLIM	-40 to 125	BAP	<a href="#">Samples</a>
TPS76325QDBVRG4Q1	ACTIVE	SOT-23	DBV	5	3000	RoHS & Green	NIPDAU	Level-1-260C-UNLIM	-40 to 125	BAQ	<a href="#">Samples</a>
TPS76330QDBVRG4Q1	ACTIVE	SOT-23	DBV	5	3000	RoHS & Green	NIPDAU	Level-1-260C-UNLIM	-40 to 125	BAT	<a href="#">Samples</a>
TPS76333QDBVRG4Q1	ACTIVE	SOT-23	DBV	5	3000	RoHS & Green	NIPDAU	Level-1-260C-UNLIM	-40 to 125	BAU	<a href="#">Samples</a>
TPS76333QDBVRQ1	ACTIVE	SOT-23	DBV	5	3000	RoHS & Green	NIPDAU	Level-1-260C-UNLIM	-40 to 125	BAU	<a href="#">Samples</a>
TPS76350QDBVRG4Q1	ACTIVE	SOT-23	DBV	5	3000	RoHS & Green	NIPDAU	Level-1-260C-UNLIM	-40 to 125	BAW	<a href="#">Samples</a>
TPS76350QDBVRQ1	ACTIVE	SOT-23	DBV	5	3000	RoHS & Green	NIPDAU	Level-1-260C-UNLIM	-40 to 125	BAW	<a href="#">Samples</a>

(1) The marketing status values are defined as follows:

**ACTIVE:** Product device recommended for new designs.

**LIFEBUY:** TI has announced that the device will be discontinued, and a lifetime-buy period is in effect.

**NRND:** Not recommended for new designs. Device is in production to support existing customers, but TI does not recommend using this part in a new design.

**PREVIEW:** Device has been announced but is not in production. Samples may or may not be available.

**OBSELETE:** TI has discontinued the production of the device.

(2) **RoHS:** TI defines "RoHS" to mean semiconductor products that are compliant with the current EU RoHS requirements for all 10 RoHS substances, including the requirement that RoHS substance do not exceed 0.1% by weight in homogeneous materials. Where designed to be soldered at high temperatures, "RoHS" products are suitable for use in specified lead-free processes. TI may reference these types of products as "Pb-Free".

**RoHS Exempt:** TI defines "RoHS Exempt" to mean products that contain lead but are compliant with EU RoHS pursuant to a specific EU RoHS exemption.

**Green:** TI defines "Green" to mean the content of Chlorine (Cl) and Bromine (Br) based flame retardants meet JS709B low halogen requirements of <=1000ppm threshold. Antimony trioxide based flame retardants must also meet the <=1000ppm threshold requirement.

(3) MSL, Peak Temp. - The Moisture Sensitivity Level rating according to the JEDEC industry standard classifications, and peak solder temperature.

(4) There may be additional marking, which relates to the logo, the lot trace code information, or the environmental category on the device.

(5) Multiple Device Markings will be inside parentheses. Only one Device Marking contained in parentheses and separated by a "~" will appear on a device. If a line is indented then it is a continuation of the previous line and the two combined represent the entire Device Marking for that device.

(6) Lead finish/Ball material - Orderable Devices may have multiple material finish options. Finish options are separated by a vertical ruled line. Lead finish/Ball material values may wrap to two lines if the finish value exceeds the maximum column width.

**Important Information and Disclaimer:**The information provided on this page represents TI's knowledge and belief as of the date that it is provided. TI bases its knowledge and belief on information provided by third parties, and makes no representation or warranty as to the accuracy of such information. Efforts are underway to better integrate information from third parties. TI has taken and continues to take reasonable steps to provide representative and accurate information but may not have conducted destructive testing or chemical analysis on incoming materials and chemicals. TI and TI suppliers consider certain information to be proprietary, and thus CAS numbers and other limited information may not be available for release.

In no event shall TI's liability arising out of such information exceed the total purchase price of the TI part(s) at issue in this document sold by TI to Customer on an annual basis.

**OTHER QUALIFIED VERSIONS OF TPS763-Q1 :**

- Catalog : [TPS763](#)

NOTE: Qualified Version Definitions:

- Catalog - TI's standard catalog product

## TAPE AND REEL INFORMATION



### QUADRANT ASSIGNMENTS FOR PIN 1 ORIENTATION IN TAPE



\*All dimensions are nominal

Device	Package Type	Package Drawing	Pins	SPQ	Reel Diameter (mm)	Reel Width W1 (mm)	A0 (mm)	B0 (mm)	K0 (mm)	P1 (mm)	W (mm)	Pin1 Quadrant
TPS76301QDBVRG4Q1	SOT-23	DBV	5	3000	180.0	9.0	3.15	3.2	1.4	4.0	8.0	Q3
TPS76301QDBVRQ1	SOT-23	DBV	5	3000	180.0	9.0	3.15	3.2	1.4	4.0	8.0	Q3
TPS76316QDBVRG4Q1	SOT-23	DBV	5	3000	180.0	9.0	3.15	3.2	1.4	4.0	8.0	Q3
TPS76318QDBVRG4Q1	SOT-23	DBV	5	3000	180.0	9.0	3.15	3.2	1.4	4.0	8.0	Q3
TPS76318QDBVRQ1	SOT-23	DBV	5	3000	180.0	9.0	3.15	3.2	1.4	4.0	8.0	Q3
TPS76325QDBVRG4Q1	SOT-23	DBV	5	3000	180.0	9.0	3.15	3.2	1.4	4.0	8.0	Q3
TPS76330QDBVRG4Q1	SOT-23	DBV	5	3000	180.0	9.0	3.15	3.2	1.4	4.0	8.0	Q3
TPS76333QDBVRG4Q1	SOT-23	DBV	5	3000	180.0	9.0	3.15	3.2	1.4	4.0	8.0	Q3
TPS76333QDBVRQ1	SOT-23	DBV	5	3000	180.0	9.0	3.15	3.2	1.4	4.0	8.0	Q3
TPS76350QDBVRG4Q1	SOT-23	DBV	5	3000	180.0	9.0	3.15	3.2	1.4	4.0	8.0	Q3
TPS76350QDBVRQ1	SOT-23	DBV	5	3000	180.0	9.0	3.15	3.2	1.4	4.0	8.0	Q3

**TAPE AND REEL BOX DIMENSIONS**

\*All dimensions are nominal

Device	Package Type	Package Drawing	Pins	SPQ	Length (mm)	Width (mm)	Height (mm)
TPS76301QDBVRG4Q1	SOT-23	DBV	5	3000	182.0	182.0	20.0
TPS76301QDBVRQ1	SOT-23	DBV	5	3000	182.0	182.0	20.0
TPS76316QDBVRG4Q1	SOT-23	DBV	5	3000	182.0	182.0	20.0
TPS76318QDBVRG4Q1	SOT-23	DBV	5	3000	182.0	182.0	20.0
TPS76318QDBVRQ1	SOT-23	DBV	5	3000	182.0	182.0	20.0
TPS76325QDBVRG4Q1	SOT-23	DBV	5	3000	182.0	182.0	20.0
TPS76330QDBVRG4Q1	SOT-23	DBV	5	3000	182.0	182.0	20.0
TPS76333QDBVRG4Q1	SOT-23	DBV	5	3000	182.0	182.0	20.0
TPS76333QDBVRQ1	SOT-23	DBV	5	3000	182.0	182.0	20.0
TPS76350QDBVRG4Q1	SOT-23	DBV	5	3000	182.0	182.0	20.0
TPS76350QDBVRQ1	SOT-23	DBV	5	3000	182.0	182.0	20.0



# EXAMPLE BOARD LAYOUT

DBV0005A

SOT-23 - 1.45 mm max height

SMALL OUTLINE TRANSISTOR

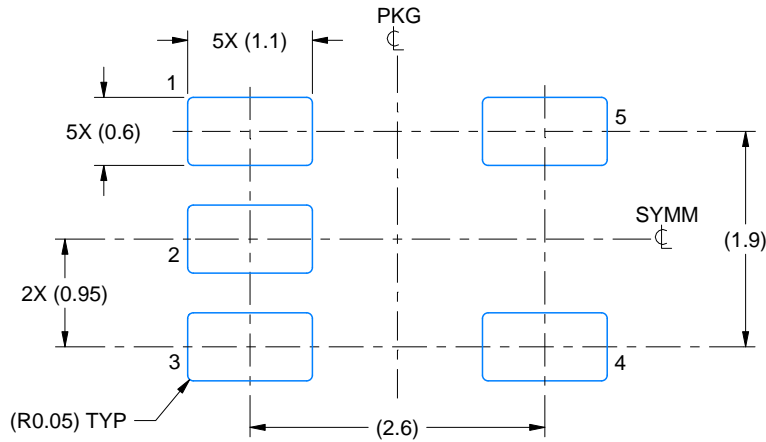

LAND PATTERN EXAMPLE  
EXPOSED METAL SHOWN  
SCALE:15X



SOLDER MASK DETAILS

4214839/J 02/2024

NOTES: (continued)

6. Publication IPC-7351 may have alternate designs.
7. Solder mask tolerances between and around signal pads can vary based on board fabrication site.

# EXAMPLE STENCIL DESIGN

DBV0005A

SOT-23 - 1.45 mm max height

SMALL OUTLINE TRANSISTOR



SOLDER PASTE EXAMPLE  
BASED ON 0.125 mm THICK STENCIL  
SCALE:15X

4214839/J 02/2024

NOTES: (continued)

8. Laser cutting apertures with trapezoidal walls and rounded corners may offer better paste release. IPC-7525 may have alternate design recommendations.
9. Board assembly site may have different recommendations for stencil design.



## IMPORTANT NOTICE AND DISCLAIMER

TI PROVIDES TECHNICAL AND RELIABILITY DATA (INCLUDING DATA SHEETS), DESIGN RESOURCES (INCLUDING REFERENCE DESIGNS), APPLICATION OR OTHER DESIGN ADVICE, WEB TOOLS, SAFETY INFORMATION, AND OTHER RESOURCES "AS IS" AND WITH ALL FAULTS, AND DISCLAIMS ALL WARRANTIES, EXPRESS AND IMPLIED, INCLUDING WITHOUT LIMITATION ANY IMPLIED WARRANTIES OF MERCHANTABILITY, FITNESS FOR A PARTICULAR PURPOSE OR NON-INFRINGEMENT OF THIRD PARTY INTELLECTUAL PROPERTY RIGHTS.

These resources are intended for skilled developers designing with TI products. You are solely responsible for (1) selecting the appropriate TI products for your application, (2) designing, validating and testing your application, and (3) ensuring your application meets applicable standards, and any other safety, security, regulatory or other requirements.

These resources are subject to change without notice. TI grants you permission to use these resources only for development of an application that uses the TI products described in the resource. Other reproduction and display of these resources is prohibited. No license is granted to any other TI intellectual property right or to any third party intellectual property right. TI disclaims responsibility for, and you will fully indemnify TI and its representatives against, any claims, damages, costs, losses, and liabilities arising out of your use of these resources.

TI's products are provided subject to [TI's Terms of Sale](#) or other applicable terms available either on [ti.com](https://www.ti.com) or provided in conjunction with such TI products. TI's provision of these resources does not expand or otherwise alter TI's applicable warranties or warranty disclaimers for TI products.

TI objects to and rejects any additional or different terms you may have proposed.

Mailing Address: Texas Instruments, Post Office Box 655303, Dallas, Texas 75265  
Copyright © 2024, Texas Instruments Incorporated