

## CDx4HC126 クワッド・バッファ、3 ステート出力

### 1 特長

- バッファ付き入力
- 広い動作電圧範囲: 2V~6V
- 広い動作温度範囲: -55°C~+125°C
- 最大 10 個の LSTTL 負荷ファンアウトに対応
- LSTTL ロジック IC に比べて消費電力を大幅削減

### 2 アプリケーション

- デジタル信号のイネーブル

### 3 概要

このデバイスには、3 ステート出力を備えた 4 つの独立したバッファが内蔵されています。各ゲートはブール関数  $Y = A$  を正論理で実行します。

#### 製品情報 (1)

部品番号	パッケージ	本体サイズ (公称)
CD74HC126M	SOIC (14)	8.70mm × 3.90mm
CD74HC126E	PDIP (14)	19.30mm × 6.40mm
CD54HC126F	CDIP (14)	21.30mm × 7.60mm

(1) 利用可能なパッケージについては、このデータシートの末尾にある注文情報を参照してください。

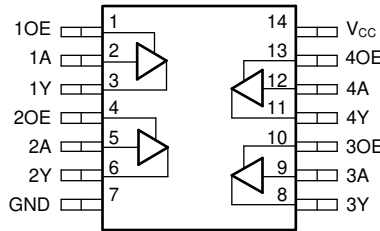

機能とピン配置

## Table of Contents

<b>1 特長</b> .....	1	8.2 Functional Block Diagram.....	8
<b>2 アプリケーション</b> .....	1	8.3 Feature Description.....	8
<b>3 概要</b> .....	1	8.4 Device Functional Modes.....	9
<b>4 Revision History</b> .....	2	<b>9 Application and Implementation</b> .....	10
<b>5 Pin Configuration and Functions</b> .....	3	9.1 Application Information.....	10
Pin Functions.....	3	9.2 Typical Application.....	10
<b>6 Specifications</b> .....	4	<b>10 Power Supply Recommendations</b> .....	12
6.1 Absolute Maximum Ratings.....	4	<b>11 Layout</b> .....	13
6.2 ESD Ratings.....	4	11.1 Layout Guidelines.....	13
6.3 Recommended Operating Conditions.....	4	11.2 Layout Example.....	13
6.4 Thermal Information.....	5	<b>12 Device and Documentation Support</b> .....	14
6.5 Electrical Characteristics.....	5	12.1 Documentation Support.....	14
6.6 Switching Characteristics.....	6	12.2 サポート・リソース.....	14
6.7 Operating Characteristics.....	6	12.3 Trademarks.....	14
6.8 Typical Characteristics.....	6	12.4 静電気放電に関する注意事項.....	14
<b>7 Parameter Measurement Information</b> .....	7	12.5 用語集.....	14
<b>8 Detailed Description</b> .....	8	<b>13 Mechanical, Packaging, and Orderable Information</b> .....	14
8.1 Overview.....	8		

## 4 Revision History

資料番号末尾の英字は改訂を表しています。その改訂履歴は英語版に準じています。

<b>Changes from Revision C (September 2003) to Revision D (June 2021)</b>	<b>Page</b>
• 新しいデータシート標準に更新.....	1
• HCT デバイスをスタンドアロンのデータシート (SCHS416) へ移動.....	1
• $R_{\theta JA}$ increased for the D package from 86 to 133.6°C/W and decreased for the N package from 80 to 62.2°C/W.....	5

## 5 Pin Configuration and Functions

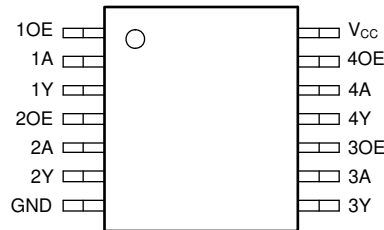

**5-1. D, N, or J Package 14-Pin SOIC, PDIP, or CDIP Top View**

### Pin Functions

PIN		I/O	DESCRIPTION
NAME	NO.		
1OE	1	Input	Channel 1, Output Enable
1A	2	Input	Channel 1, Input A
1Y	3	Output	Channel 1, Output Y
2OE	4	Input	Channel 2, Output Enable
2A	5	Input	Channel 2, Input A
2Y	6	Output	Channel 2, Output Y
GND	7	—	Ground
3Y	8	Output	Channel 3, Output Y
3A	9	Input	Channel 3, Input A
3OE	10	Input	Channel 3, Output Enable
4Y	11	Output	Channel 4, Output Y
4A	12	Input	Channel 4, Input A
4OE	13	Input	Channel 4, Output Enable
V <sub>CC</sub>	14	—	Positive Supply

## 6 Specifications

### 6.1 Absolute Maximum Ratings

over operating free-air temperature range (unless otherwise noted)<sup>(1)</sup>

		MIN	MAX	UNIT
V <sub>CC</sub>	Supply voltage	-0.5	7	V
I <sub>IK</sub>	Input clamp current <sup>(2)</sup>	V <sub>I</sub> < -0.5 V or V <sub>I</sub> > V <sub>CC</sub> + 0.5 V		±20 mA
I <sub>OK</sub>	Output clamp current <sup>(2)</sup>	V <sub>O</sub> < -0.5 V or V <sub>O</sub> > V <sub>CC</sub> + 0.5 V		±20 mA
I <sub>O</sub>	Continuous output current	V <sub>O</sub> > -0.5 V or V <sub>O</sub> < V <sub>CC</sub> + 0.5 V		±35 mA
Continuous current through V <sub>CC</sub> or GND				±70 mA
T <sub>J</sub>	Junction temperature <sup>(3)</sup>			150 °C
Lead temperature (Soldering 10s)		SOIC - Lead tips only		300 °C
T <sub>stg</sub>	Storage temperature	-65	150	°C

- (1) Stresses beyond those listed under *Absolute Maximum Rating* may cause permanent damage to the device. These are stress ratings only, which do not imply functional operation of the device at these or any other conditions beyond those indicated under *Recommended Operating Condition*. Exposure to absolute-maximum-rated conditions for extended periods may affect device reliability.
- (2) The input and output voltage ratings may be exceeded if the input and output current ratings are observed.
- (3) Guaranteed by design.

### 6.2 ESD Ratings

		VALUE	UNIT
V <sub>(ESD)</sub>	Electrostatic discharge	Human-body model (HBM), per ANSI/ESDA/ JEDEC JS-001 <sup>(1)</sup>	±2000
		Charged-device model (CDM), per JEDEC specification JESD22-C101 <sup>(2)</sup>	-

- (1) JEDEC document JEP155 states that 500-V HBM allows safe manufacturing with a standard ESD control process.
- (2) JEDEC document JEP157 states that 250-V CDM allows safe manufacturing with a standard ESD control process.

### 6.3 Recommended Operating Conditions

over operating free-air temperature range (unless otherwise noted)

		MIN	NOM	MAX	UNIT
V <sub>CC</sub>	Supply voltage	2		6	V
V <sub>IH</sub>	High-level input voltage	V <sub>CC</sub> = 2 V	1.5		V
		V <sub>CC</sub> = 4.5 V	3.15		
		V <sub>CC</sub> = 6 V	4.2		
V <sub>IL</sub>	Low-level input voltage	V <sub>CC</sub> = 2 V		0.5	V
		V <sub>CC</sub> = 4.5 V		1.35	
		V <sub>CC</sub> = 6 V		1.8	
V <sub>I</sub>	Input voltage	0		V <sub>CC</sub>	V
V <sub>O</sub>	Output voltage	0		V <sub>CC</sub>	V
t <sub>t</sub>	Input transition time	V <sub>CC</sub> = 2 V		1000	ns
		V <sub>CC</sub> = 4.5 V		500	
		V <sub>CC</sub> = 6 V		400	
T <sub>A</sub>	Operating free-air temperature	-55		125	°C

## 6.4 Thermal Information

THERMAL METRIC <sup>(1)</sup>		CD74HC126		UNIT
		N (PDIP)	D (SOIC)	
		14 PINS	14 PINS	
R <sub>θJA</sub>	Junction-to-ambient thermal resistance	62.2	133.6	°C/W
R <sub>θJC(top)</sub>	Junction-to-case (top) thermal resistance	50.0	89.0	°C/W
R <sub>θJB</sub>	Junction-to-board thermal resistance	42.0	89.5	°C/W
Ψ <sub>JT</sub>	Junction-to-top characterization parameter	29.6	45.5	°C/W
Ψ <sub>JB</sub>	Junction-to-board characterization parameter	41.7	89.1	°C/W
R <sub>θJC(bot)</sub>	Junction-to-case (bottom) thermal resistance	N/A	N/A	°C/W

(1) For more information about traditional and new thermal metrics, see the [Semiconductor and IC Package Thermal Metrics](#) application report.

## 6.5 Electrical Characteristics

over operating free-air temperature range; typical values measured at T<sub>A</sub> = 25°C (unless otherwise noted).

PARAMETER	TEST CONDITIONS	V <sub>CC</sub>	Operating free-air temperature (T <sub>A</sub> )									UNIT			
			25°C			-40°C to 85°C			-55°C to 125°C						
			MIN	TYP	MAX	MIN	TYP	MAX	MIN	TYP	MAX				
V <sub>OH</sub>	High-level output voltage	V <sub>I</sub> = V <sub>IH</sub> or V <sub>IL</sub>	I <sub>OH</sub> = -20 μA	2 V			1.9			1.9			V		
				4.5 V			4.4			4.4					
				6 V			5.9			5.9					
			I <sub>OH</sub> = -6 mA	4.5 V			3.98			3.84				3.7	
			I <sub>OH</sub> = -7.8 mA	6 V			5.48			5.34			5.2		
V <sub>OL</sub>	Low-level output voltage	V <sub>I</sub> = V <sub>IH</sub> or V <sub>IL</sub>	I <sub>OL</sub> = 20 μA	2 V						0.1			0.1	V	
				4.5 V						0.1			0.1		
				6 V						0.1			0.1		
			I <sub>OL</sub> = 6 mA	4.5 V					0.26			0.33			0.4
			I <sub>OL</sub> = 7.8 mA	6 V					0.26			0.33			0.4
I <sub>I</sub>	Input leakage current	V <sub>I</sub> = V <sub>CC</sub> or 0	6 V						±0.1			±1	μA		
I <sub>CC</sub>	Supply current	V <sub>I</sub> = V <sub>CC</sub> or 0	I <sub>O</sub> = 0	6 V					8			80	160	μA	
I <sub>OZ</sub>	Three-state leakage current	V <sub>I</sub> = V <sub>IH</sub> or V <sub>IL</sub>	6 V						±0.5			±5	±10	μA	
C <sub>i</sub>	Input capacitance		5 V						10			10	10	pF	
C <sub>o</sub>	Three-state output capacitance								20			20	20	pF	

## 6.6 Switching Characteristics

over operating free-air temperature range; typical values measured at  $T_A = 25^\circ\text{C}$  (unless otherwise noted).

PARAMETER	FROM	TO	TEST CONDITIONS	$V_{CC}$	Operating free-air temperature ( $T_A$ )									UNIT
					25°C			-40°C to 85°C			-55°C to 125°C			
					MIN	TYP	MAX	MIN	TYP	MAX	MIN	TYP	MAX	
$t_{pd}$	Propagation delay	A	Y	$C_L = 50\text{ pF}$	2 V		100		125		150	ns		
					4.5 V		20		25		30			
					6 V		17		21		36			
		A	Y	$C_L = 15\text{ pF}$	5 V		8							
$t_{en}$	Enable delay	OE	Y	$C_L = 50\text{ pF}$	2 V		125		155		190	ns		
					4.5 V		25		31		38			
					6 V		21		26		32			
		OE	Y	$C_L = 15\text{ pF}$	5 V		10							
$t_{dis}$	Disable delay	OE	Y	$C_L = 50\text{ pF}$	2 V		125		155		190	ns		
					4.5 V		25		31		38			
					6 V		21		26		32			
		OE	Y	$C_L = 15\text{ pF}$	5 V		10							
$t_t$	Transition-time		Y	$C_L = 50\text{ pF}$	2 V		60		75		90	ns		
					4.5 V		12		15		18			
					6 V		10		13		15			

## 6.7 Operating Characteristics

over operating free-air temperature range; typical values measured at  $T_A = 25^\circ\text{C}$  (unless otherwise noted).

PARAMETER	TEST CONDITIONS	$V_{CC}$	MIN	TYP	MAX	UNIT
$C_{pd}$	Power dissipation capacitance per gate No load	5 V		30		pF

## 6.8 Typical Characteristics

$T_A = 25^\circ\text{C}$

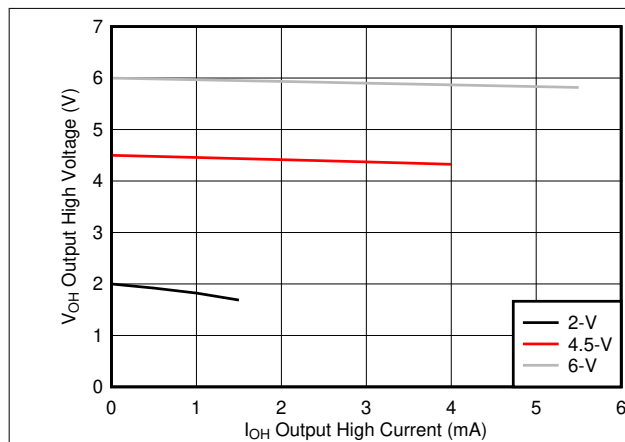

6-1. Typical output voltage in the high state ( $V_{OH}$ )

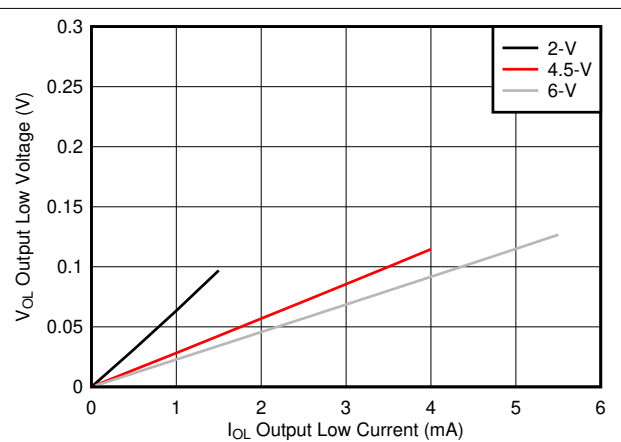

6-2. Typical output voltage in the low state ( $V_{OL}$ )

## 7 Parameter Measurement Information

- Phase relationships between waveforms were chosen arbitrarily. All input pulses are supplied by generators having the following characteristics:  $PRR \leq 1 \text{ MHz}$ ,  $Z_O = 50 \Omega$ ,  $t_t < 6 \text{ ns}$ .
- The outputs are measured one at a time, with one input transition per measurement.

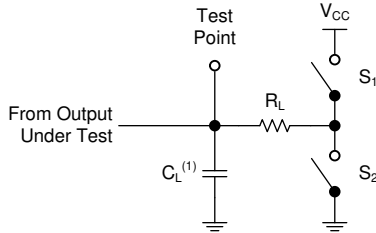

A.  $C_L = 50 \text{ pF}$  and includes probe and jig capacitance.

**7-1. Load Circuit**

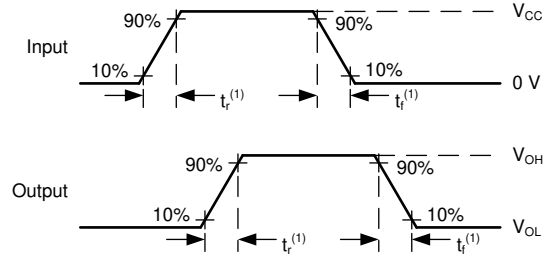

A.  $t_t$  is the greater of  $t_r$  and  $t_f$ .

**7-2. Voltage Waveforms Transition Times**

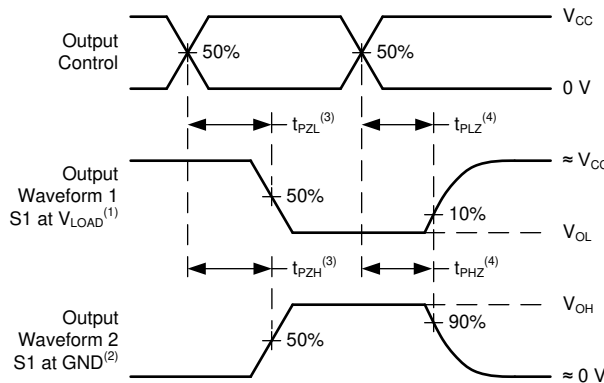

A. The maximum between  $t_{pLH}$  and  $t_{pHL}$  is used for  $t_{pd}$ .

**7-3. Voltage Waveforms Propagation Delays**

## 8 Detailed Description

### 8.1 Overview

This device contains four independent buffers with 3-state outputs. Each gate performs the Boolean function  $Y = A$  in positive logic.

### 8.2 Functional Block Diagram

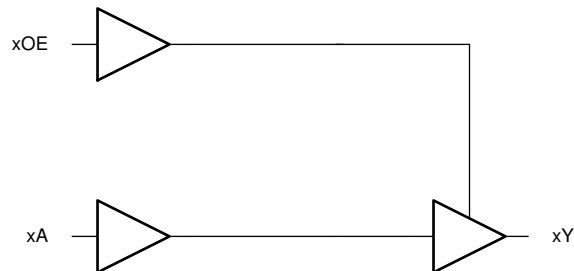

### 8.3 Feature Description

#### 8.3.1 Balanced CMOS 3-State Outputs

A balanced output allows the device to sink and source similar currents. The drive capability of this device may create fast edges into light loads so routing and load conditions should be considered to prevent ringing. Additionally, the outputs of this device are capable of driving larger currents than the device can sustain without being damaged. It is important for the output power of the device to be limited to avoid damage due to over-current. The electrical and thermal limits defined in the [セクション 6.1](#) must be followed at all times.

The CD74HC126 can drive a load with a total capacitance less than or equal to the maximum load listed in the [セクション 6.6](#) connected to a high-impedance CMOS input while still meeting all of the datasheet specifications. Larger capacitive loads can be applied, however it is not recommended to exceed the provided load value. If larger capacitive loads are required, it is recommended to add a series resistor between the output and the capacitor to limit output current to the values given in the [セクション 6.1](#).

3-State outputs can be placed into a high-impedance state. In this state, the output will neither source nor sink current, and leakage current is defined by the  $I_{OZ}$  specification in the [セクション 6.5](#). A pull-up or pull-down resistor can be used to ensure that the output remains HIGH or LOW, respectively, during the high-impedance state.

#### 8.3.2 Standard CMOS Inputs

Standard CMOS inputs are high impedance and are typically modeled as a resistor from the input to ground in parallel with the input capacitance given in the [セクション 6.5](#). The worst case resistance is calculated with the maximum input voltage, given in the [セクション 6.1](#), and the maximum input leakage current, given in the [セクション 6.5](#), using ohm's law ( $R = V \div I$ ).

Signals applied to the inputs need to have fast edge rates, as defined by the input transition time in the [セクション 6.3](#) to avoid excessive current consumption and oscillations. If a slow or noisy input signal is required, a device with a Schmitt-trigger input should be used to condition the input signal prior to the standard CMOS input.



### 8.3.3 Clamp Diode Structure

The inputs and outputs to this device have both positive and negative clamping diodes as depicted in 図 8-1.

注意

Voltages beyond the values specified in the セクション 6.1 table can cause damage to the device. The recommended input and output voltage ratings may be exceeded if the input and output clamp-current ratings are observed.



図 8-1. Electrical Placement of Clamping Diodes for Each Input and Output

### 8.4 Device Functional Modes

表 8-1. Function Table

INPUTS		OUTPUT
OE	A	Y
L	X	Z
H	L	L
H	H	H

## 9 Application and Implementation

### 注

以下のアプリケーション情報は、TI の製品仕様に含まれるものではなく、TI ではその正確性または完全性を保証いたしません。個々の目的に対する製品の適合性については、お客様の責任で判断していただくこととなります。また、お客様は自身の設計実装を検証しテストすることで、システムの機能を確認する必要があります。

### 9.1 Application Information

In this application, a 3-state buffer is used to enable or disable a data connection as shown in [図 9-1](#). It is common to see all four channels of a device used together for controlling a 4-bit data bus, however each channel of the device can be used independently. Unused channels should have the inputs terminated at ground or  $V_{CC}$  and the output left unconnected.

When the output of the device is active, the data signal will be replicated at the output. When the output of the device is disabled, the output will be in a high-impedance state, and the output voltage will be determined by the circuit connected to the output pin. This circuit is most commonly used when a bus must be completely disabled. One example of this situation is when the circuitry connected to the output is to be powered off for an extended period of time to save system power, and the inputs to that circuitry cannot have a voltage present due to protective clamp diodes.

### 9.2 Typical Application

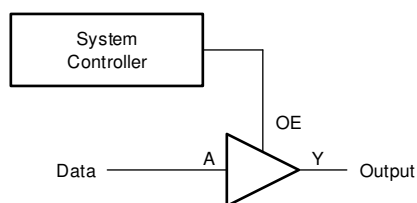

**図 9-1. Typical application schematic**

#### 9.2.1 Design Requirements

##### 9.2.1.1 Power Considerations

Ensure the desired supply voltage is within the range specified in the [セクション 6.3](#). The supply voltage sets the device's electrical characteristics as described in the [セクション 6.5](#).

The supply must be capable of sourcing current equal to the total current to be sourced by all outputs of the CD74HC126 plus the maximum supply current,  $I_{CC}$ , listed in the [セクション 6.5](#). The logic device can only source or sink as much current as it is provided at the supply and ground pins, respectively. Be sure not to exceed the maximum total current through GND or  $V_{CC}$  listed in the [セクション 6.1](#).

Total power consumption can be calculated using the information provided in [CMOS Power Consumption and  \$C\_{pd}\$  Calculation](#).

Thermal increase can be calculated using the information provided in [Thermal Characteristics of Standard Linear and Logic \(SLL\) Packages and Devices](#).

### 注意

The maximum junction temperature,  $T_J(\text{max})$  listed in the [セクション 6.1](#), is an *additional limitation* to prevent damage to the device. Do not violate any values listed in the [セクション 6.1](#). These limits are provided to prevent damage to the device.

### 9.2.1.2 Input Considerations

Unused inputs must be terminated to either  $V_{CC}$  or ground. These can be directly terminated if the input is completely unused, or they can be connected with a pull-up or pull-down resistor if the input is to be used sometimes, but not always. A pull-up resistor is used for a default state of HIGH, and a pull-down resistor is used for a default state of LOW. The resistor size is limited by drive current of the controller, leakage current into the CD74HC126, as specified in the [セクション 6.5](#), and the desired input transition rate. A 10-k $\Omega$  resistor value is often used due to these factors.

The CD74HC126 has standard CMOS inputs, so input signal edge rates cannot be slow. Slow input edge rates can cause oscillations and damaging shoot-through current. The recommended rates are defined in the [セクション 6.3](#).

Refer to the [セクション 8.3](#) for additional information regarding the inputs for this device.

### 9.2.1.3 Output Considerations

The positive supply voltage is used to produce the output HIGH voltage. Drawing current from the output will decrease the output voltage as specified by the  $V_{OH}$  specification in the [セクション 6.5](#). Similarly, the ground voltage is used to produce the output LOW voltage. Sinking current into the output will increase the output voltage as specified by the  $V_{OL}$  specification in the [セクション 6.5](#).

Unused outputs can be left floating. Do not connect outputs directly to  $V_{CC}$  or ground.

Refer to [セクション 8.3](#) for additional information regarding the outputs for this device.

## 9.2.2 Detailed Design Procedure

1. Add a decoupling capacitor from  $V_{CC}$  to GND. The capacitor needs to be placed physically close to the device and electrically close to both the  $V_{CC}$  and GND pins. An example layout is shown in the [セクション 11](#).
2. Ensure the capacitive load at the output is  $\leq 70$  pF. This is not a hard limit, however it will ensure optimal performance. This can be accomplished by providing short, appropriately sized traces from the CD74HC126 to the receiving device.
3. Ensure the resistive load at the output is larger than  $(V_{CC} / I_{O(max)}) \Omega$ . This will ensure that the maximum output current from the [セクション 6.1](#) is not violated. Most CMOS inputs have a resistive load measured in megaohms; much larger than the minimum calculated above.
4. Thermal issues are rarely a concern for logic gates, however the power consumption and thermal increase can be calculated using the steps provided in the application report, [CMOS Power Consumption and Cpd Calculation](#)

### 9.2.3 Application Curves



図 9-2. Typical application timing diagram

## 10 Power Supply Recommendations

The power supply can be any voltage between the minimum and maximum supply voltage rating located in the [セクション 6.3](#). Each  $V_{CC}$  terminal should have a bypass capacitor to prevent power disturbance. A 0.1- $\mu$ F capacitor is recommended for this device. It is acceptable to parallel multiple bypass caps to reject different frequencies of noise. The 0.1- $\mu$ F and 1- $\mu$ F capacitors are commonly used in parallel. The bypass capacitor should be installed as close to the power terminal as possible for best results, as shown in [図 11-1](#).

## 11 Layout

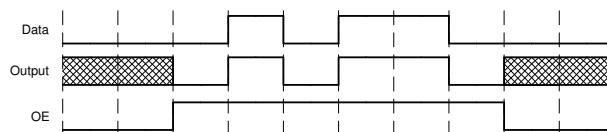
### 11.1 Layout Guidelines

When using multiple-input and multiple-channel logic devices inputs must not ever be left floating. In many cases, functions or parts of functions of digital logic devices are unused; for example, when only two inputs of a triple-input AND gate are used. Such unused input pins must not be left unconnected because the undefined voltages at the outside connections result in undefined operational states. All unused inputs of digital logic devices must be connected to a logic high or logic low voltage, as defined by the input voltage specifications, to prevent them from floating. The logic level that must be applied to any particular unused input depends on the function of the device. Generally, the inputs are tied to GND or  $V_{CC}$ , whichever makes more sense for the logic function or is more convenient.

### 11.2 Layout Example

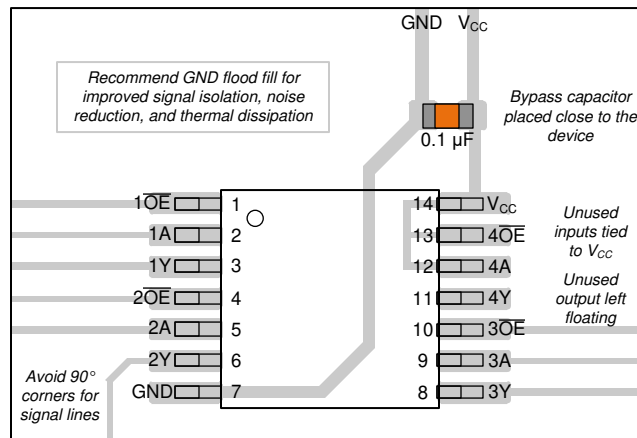

**11-1. Example layout for the CD74HC126**

## 12 Device and Documentation Support

### 12.1 Documentation Support

#### 12.1.1 Related Documentation

For related documentation see the following:

- [HCMOS Design Considerations](#)
- [CMOS Power Consumption and CPD Calculation](#)
- [Designing with Logic](#)

### 12.2 サポート・リソース

TI E2E™ サポート・フォーラムは、エンジニアが検証済みの回答と設計に関するヒントをエキスパートから迅速かつ直接得ることができる場所です。既存の回答を検索したり、独自の質問をしたりすることで、設計に必要な支援を迅速に得ることができます。

リンクされているコンテンツは、該当する貢献者により、現状のまま提供されるものです。これらは TI の仕様を構成するものではなく、必ずしも TI の見解を反映したものではありません。TI の[使用条件](#)を参照してください。

### 12.3 Trademarks

TI E2E™ is a trademark of Texas Instruments.

すべての商標は、それぞれの所有者に帰属します。

### 12.4 静電気放電に関する注意事項



この IC は、ESD によって破損する可能性があります。テキサス・インスツルメンツは、IC を取り扱う際には常に適切な注意を払うことを推奨します。正しい ESD 対策をとらないと、デバイスを破損するおそれがあります。

ESD による破損は、わずかな性能低下からデバイスの完全な故障まで多岐にわたります。精密な IC の場合、パラメータがわずかに変化するだけで公表されている仕様から外れる可能性があるため、破損が発生しやすくなっています。

### 12.5 用語集

**TI 用語集** この用語集には、用語や略語の一覧および定義が記載されています。

## 13 Mechanical, Packaging, and Orderable Information

The following pages include mechanical, packaging, and orderable information. This information is the most current data available for the designated devices. This data is subject to change without notice and revision of this document. For browser-based versions of this data sheet, refer to the left-hand navigation.

**PACKAGING INFORMATION**

Orderable Device	Status (1)	Package Type	Package Drawing	Pins	Package Qty	Eco Plan (2)	Lead finish/ Ball material (6)	MSL Peak Temp (3)	Op Temp (°C)	Device Marking (4/5)	Samples
CD54HC126F3A	ACTIVE	CDIP	J	14	25	Non-RoHS & Green	SNPB	N / A for Pkg Type	-55 to 125	5962-8684801CA CD54HC126F3A	<a href="#">Samples</a>
CD74HC126E	ACTIVE	PDIP	N	14	25	RoHS & Green	NIPDAU	N / A for Pkg Type	-55 to 125	CD74HC126E	<a href="#">Samples</a>
CD74HC126M	OBSOLETE	SOIC	D	14		TBD	Call TI	Call TI	-55 to 125	HC126M	
CD74HC126M96	ACTIVE	SOIC	D	14	2500	RoHS & Green	NIPDAU   SN	Level-1-260C-UNLIM	-55 to 125	HC126M	<a href="#">Samples</a>

(1) The marketing status values are defined as follows:

**ACTIVE:** Product device recommended for new designs.

**LIFEBUY:** TI has announced that the device will be discontinued, and a lifetime-buy period is in effect.

**NRND:** Not recommended for new designs. Device is in production to support existing customers, but TI does not recommend using this part in a new design.

**PREVIEW:** Device has been announced but is not in production. Samples may or may not be available.

**OBSOLETE:** TI has discontinued the production of the device.

(2) **RoHS:** TI defines "RoHS" to mean semiconductor products that are compliant with the current EU RoHS requirements for all 10 RoHS substances, including the requirement that RoHS substance do not exceed 0.1% by weight in homogeneous materials. Where designed to be soldered at high temperatures, "RoHS" products are suitable for use in specified lead-free processes. TI may reference these types of products as "Pb-Free".

**RoHS Exempt:** TI defines "RoHS Exempt" to mean products that contain lead but are compliant with EU RoHS pursuant to a specific EU RoHS exemption.

**Green:** TI defines "Green" to mean the content of Chlorine (Cl) and Bromine (Br) based flame retardants meet JS709B low halogen requirements of <=1000ppm threshold. Antimony trioxide based flame retardants must also meet the <=1000ppm threshold requirement.

(3) MSL, Peak Temp. - The Moisture Sensitivity Level rating according to the JEDEC industry standard classifications, and peak solder temperature.

(4) There may be additional marking, which relates to the logo, the lot trace code information, or the environmental category on the device.

(5) Multiple Device Markings will be inside parentheses. Only one Device Marking contained in parentheses and separated by a "~" will appear on a device. If a line is indented then it is a continuation of the previous line and the two combined represent the entire Device Marking for that device.

(6) Lead finish/Ball material - Orderable Devices may have multiple material finish options. Finish options are separated by a vertical ruled line. Lead finish/Ball material values may wrap to two lines if the finish value exceeds the maximum column width.

**Important Information and Disclaimer:**The information provided on this page represents TI's knowledge and belief as of the date that it is provided. TI bases its knowledge and belief on information provided by third parties, and makes no representation or warranty as to the accuracy of such information. Efforts are underway to better integrate information from third parties. TI has taken and

continues to take reasonable steps to provide representative and accurate information but may not have conducted destructive testing or chemical analysis on incoming materials and chemicals. TI and TI suppliers consider certain information to be proprietary, and thus CAS numbers and other limited information may not be available for release.

In no event shall TI's liability arising out of such information exceed the total purchase price of the TI part(s) at issue in this document sold by TI to Customer on an annual basis.

**OTHER QUALIFIED VERSIONS OF CD54HC126, CD74HC126 :**

- Catalog : [CD74HC126](#)
- Military : [CD54HC126](#)

NOTE: Qualified Version Definitions:

- Catalog - TI's standard catalog product
- Military - QML certified for Military and Defense Applications



**TAPE AND REEL INFORMATION**

**QUADRANT ASSIGNMENTS FOR PIN 1 ORIENTATION IN TAPE**

\*All dimensions are nominal

Device	Package Type	Package Drawing	Pins	SPQ	Reel Diameter (mm)	Reel Width W1 (mm)	A0 (mm)	B0 (mm)	K0 (mm)	P1 (mm)	W (mm)	Pin1 Quadrant
CD74HC126M96	SOIC	D	14	2500	330.0	16.4	6.5	9.0	2.1	8.0	16.0	Q1
CD74HC126M96	SOIC	D	14	2500	330.0	16.4	6.6	9.3	2.1	8.0	16.0	Q1

## TAPE AND REEL BOX DIMENSIONS



\*All dimensions are nominal

Device	Package Type	Package Drawing	Pins	SPQ	Length (mm)	Width (mm)	Height (mm)
CD74HC126M96	SOIC	D	14	2500	356.0	356.0	35.0
CD74HC126M96	SOIC	D	14	2500	366.0	364.0	50.0

**TUBE**

\*All dimensions are nominal

Device	Package Name	Package Type	Pins	SPQ	L (mm)	W (mm)	T (μm)	B (mm)
CD74HC126E	N	PDIP	14	25	506	13.97	11230	4.32
CD74HC126E	N	PDIP	14	25	506	13.97	11230	4.32

J 14

**GENERIC PACKAGE VIEW**  
**CDIP - 5.08 mm max height**  
CERAMIC DUAL IN LINE PACKAGE



Images above are just a representation of the package family, actual package may vary.  
Refer to the product data sheet for package details.

4040083-5/G

J0014A



# PACKAGE OUTLINE

CDIP - 5.08 mm max height

CERAMIC DUAL IN LINE PACKAGE



4214771/A 05/2017

NOTES:

1. All controlling linear dimensions are in inches. Dimensions in brackets are in millimeters. Any dimension in brackets or parenthesis are for reference only. Dimensioning and tolerancing per ASME Y14.5M.
2. This drawing is subject to change without notice.
3. This package is hermetically sealed with a ceramic lid using glass frit.
4. Index point is provided on cap for terminal identification only and on press ceramic glass frit seal only.
5. Falls within MIL-STD-1835 and GDIP1-T14.

# EXAMPLE BOARD LAYOUT

J0014A

CDIP - 5.08 mm max height

CERAMIC DUAL IN LINE PACKAGE



LAND PATTERN EXAMPLE  
NON-SOLDER MASK DEFINED  
SCALE: 5X





4214771/A 05/2017

D (R-PDSO-G14)

PLASTIC SMALL OUTLINE



4040047-5/M 06/11

- NOTES:
- A. All linear dimensions are in inches (millimeters).
  - B. This drawing is subject to change without notice.
  -  Body length does not include mold flash, protrusions, or gate burrs. Mold flash, protrusions, or gate burrs shall not exceed 0.006 (0,15) each side.
  -  Body width does not include interlead flash. Interlead flash shall not exceed 0.017 (0,43) each side.
  - E. Reference JEDEC MS-012 variation AB.

N (R-PDIP-T\*\*)

PLASTIC DUAL-IN-LINE PACKAGE

16 PINS SHOWN



- NOTES:
- A. All linear dimensions are in inches (millimeters).
  - B. This drawing is subject to change without notice.
  - Falls within JEDEC MS-001, except 18 and 20 pin minimum body length (Dim A).
  - The 20 pin end lead shoulder width is a vendor option, either half or full width.



## 重要なお知らせと免責事項

TI は、技術データと信頼性データ(データシートを含みます)、設計リソース(リファレンス・デザインを含みます)、アプリケーションや設計に関する各種アドバイス、Web ツール、安全性情報、その他のリソースを、欠陥が存在する可能性のある「現状のまま」提供しており、商品性および特定目的に対する適合性の黙示保証、第三者の知的財産権の非侵害保証を含むいかなる保証も、明示的または黙示的にかかわらず拒否します。

これらのリソースは、TI 製品を使用する設計の経験を積んだ開発者への提供を意図したものです。(1) お客様のアプリケーションに適した TI 製品の選定、(2) お客様のアプリケーションの設計、検証、試験、(3) お客様のアプリケーションに該当する各種規格や、その他のあらゆる安全性、セキュリティ、規制、または他の要件への確実な適合に関する責任を、お客様のみが単独で負うものとし、

上記の各種リソースは、予告なく変更される可能性があります。これらのリソースは、リソースで説明されている TI 製品を使用するアプリケーションの開発の目的でのみ、TI はその使用をお客様に許諾します。これらのリソースに関して、他の目的で複製することや掲載することは禁止されています。TI や第三者の知的財産権のライセンスが付与されている訳ではありません。お客様は、これらのリソースを自身で使用した結果発生するあらゆる申し立て、損害、費用、損失、責任について、TI およびその代理人を完全に補償するものとし、TI は一切の責任を拒否します。

TI の製品は、[TI の販売条件](#)、または [ti.com](#) やかかる TI 製品の関連資料などのいずれかを通じて提供する適用可能な条項の下で提供されています。TI がこれらのリソースを提供することは、適用される TI の保証または他の保証の放棄の拡大や変更を意味するものではありません。

お客様がいかなる追加条項または代替条項を提案した場合でも、TI はそれらに異議を唱え、拒否します。

郵送先住所 : Texas Instruments, Post Office Box 655303, Dallas, Texas 75265  
Copyright © 2024, Texas Instruments Incorporated