

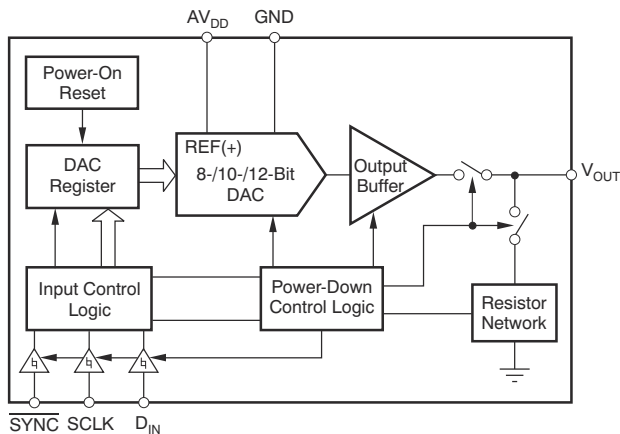
DACx311 2V~5.5V、80 μ A、8ビット、10ビット、12ビット、低消費電力、シングルチャネル、D/A コンバータ、SC70 パッケージ封止

1 特長

- 相対精度:
 - 0.25LSB INL (DAC5311: 8ビット)
 - 0.5LSB INL (DAC6311: 10ビット)
 - 1LSB INL (DAC7311: 12ビット)
- マイクロパワー動作: 80 μ A (2.0V 時)
- パワーダウン: 5V で 0.5 μ A、2.0V で 0.1 μ A
- 広い電源電圧範囲: 2.0V~5.5V
- ゼロ・スケールへのパワーオン・リセット
- ストレート・バイナリ・データ・フォーマット
- シュミット・トリガ入力を持つ低消費電力シリアル・インターフェイス: 最高 50MHz
- レール・ツー・レール動作のオンチップ出力バッファ・アンプ
- SYNC** 割り込み機能
- 拡張温度範囲: -40°C~+125°C
- 小型の 6 ピン SC70 パッケージで供給されるピン互換のファミリ

2 アプリケーション

- 携帯型のバッテリー駆動計測機器
- 4mA~20mA のループ電源アプリケーション
- プロセス制御および産業用オートメーション
- プログラム可能な電圧源および電流源



概略回路図

3 概要

8ビット DAC5311、10ビット DAC6311、12ビット DAC7311 (DACx311) は、低消費電力、シングル・チャネルの電圧出力 D/A コンバータ (DAC) です。通常動作時の消費電力が低いため (5V で 0.55mW、パワーダウン・モードでは 2.5 μ W に低下)、DACx311 は携帯型のバッテリー駆動アプリケーションに最適です。

これらのデバイスは設計上単調で、優れた直線性を備えており、不要なコード間過渡電圧が最小限に抑えられているうちに、ピン互換のファミリ内で簡単にアップグレードできます。すべてのデバイスは、最高 50MHz のクロック・レートで動作する汎用 3 ワイヤ・シリアル・インターフェイスにより、SPI、QSPI、Microwire の規格、およびデジタル・シグナル・プロセッサ (DSP) との接続に対応しています。

すべてのデバイスは、出力範囲を設定するための基準電圧として外部電源を使用しています。このデバイスにはパワーオン・リセット (POR) 回路が組み込まれており、DAC 出力が 0V で起動され、デバイスへの有効な書き込みが発生するまで 0V に維持されます。DACx311 には、シリアル・インターフェイスでアクセス可能なパワーダウン機能が含まれており、パワーダウン・モードではデバイスの消費電流を 2.0V で 0.1 μ A にまで低減できます。

これらのデバイスは DAC8311 および DAC8411 とピン互換であり、8ビット、10ビット、12ビットの分解能から 14ビット、16ビットの分解能に簡単にアップグレードできます。すべてのデバイスは小型の 6 ピン SC70 (SOT) パッケージで供給されます。このパッケージは、ファミリ内でピン互換および機能互換の柔軟なドロップイン DAC を提供し、拡張温度範囲 -40°C~+125°C で動作します

製品情報⁽¹⁾

部品番号 ⁽²⁾	分解能	パッケージ・サイズ ⁽³⁾
DAC7311	12ビット	DCK (SC70, 6) 2mm × 1.5mm
DAC6311	10ビット	
DAC5311	8ビット	

- 利用可能なすべてのパッケージについては、データシートの末尾にあるパッケージ・オプションについての付録を参照してください。
- 製品比較表を参照してください。
- パッケージ・サイズ (長さ×幅) は公称値であり、該当する場合はピンも含まれます。



Table of Contents

1 特長.....	1	8.1 Overview.....	22
2 アプリケーション.....	1	8.2 Functional Block Diagram.....	22
3 概要.....	1	8.3 Feature Description.....	22
4 Revision History.....	2	8.4 Device Functional Modes.....	24
5 Device Comparison.....	3	8.5 Programming.....	25
6 Pin Configuration and Functions.....	3	9 Application and Implementation.....	27
7 Specifications.....	4	9.1 Application Information.....	27
7.1 Absolute Maximum Ratings.....	4	9.2 Typical Applications	28
7.2 ESD Ratings.....	4	9.3 Power Supply Recommendations.....	31
7.3 Recommended Operating Conditions.....	4	9.4 Layout.....	32
7.4 Thermal Information.....	4	10 Device and Documentation Support.....	33
7.5 Electrical Characteristics.....	5	10.1 ドキュメントの更新通知を受け取る方法.....	33
7.6 Timing Requirements.....	7	10.2 サポート・リソース.....	33
7.7 Timing Diagrams	7	10.3 Trademarks.....	33
7.8 Typical Characteristics: AV _{DD} = 5 V.....	8	10.4 静電気放電に関する注意事項.....	33
7.9 Typical Characteristics: AV _{DD} = 3.6 V.....	15	10.5 用語集.....	33
7.10 Typical Characteristics: AV _{DD} = 2.7 V.....	16	11 Mechanical, Packaging, and Orderable Information.....	33
8 Detailed Description.....	22		

4 Revision History

資料番号末尾の英字は改訂を表しています。その改訂履歴は英語版に準じています。

Changes from Revision C (July 2015) to Revision D (August 2023)	Page
• ドキュメント全体にわたって表、図、相互参照の採番方法を更新.....	1
• 本体サイズではなくパッケージ・サイズを示すように「製品情報」表を変更し、デバイス間の違いを示す項目を追加....	1
• Changed power dissipation max value for normal mode at AV _{DD} = 3.6 V to 5.5 V from 0.88 mW to 0.99 mW in <i>Electrical Characteristics</i>	5
• Changed I _{DD} max value for normal mode at AV _{DD} = 3.6 V to 5.5 V from 160 μA to 180 μA in <i>Electrical Characteristics</i>	5

Changes from Revision B (May 2013) to Revision C (July 2015)	Page
• 「ESD 定格」表、および「機能説明」、「デバイスの機能モード」、「アプリケーションと実装」、「電源に関する推奨事項」、「レイアウト」、「デバイスおよびドキュメントのサポート」、「メカニカル、パッケージ、および注文情報」の各セクションを追加.....	1
• Added <i>Device Comparison</i> section and moved existing tables to this new section.....	3
• Moved <i>Operating Temperature</i> parameter from <i>Electrical Characteristics</i> table to <i>Recommended Operating Conditions</i> table	4
• Deleted <i>Parameter Definitions</i> section; definitions moved to new <i>Glossary</i> section.....	33

Changes from Revision A (August 2011) to Revision B (May 2013)	Page
• データシート全体にわたってすべての 1.8V を 2.0V に変更.....	1
• Deleted the 1.8-V Typical Characteristics section.....	8
• Changed X-axis for Figure 7-36, Power-Supply Current vs Power-Supply Voltage.....	8
• Changed X-axis for Figure 7-37, Power-Down Current vs Power-Supply Voltage.....	8

Changes from Revision * (August, 2008) to Revision A (August, 2011)	Page
• Changed specifications and test conditions for input low voltage parameter.....	5
• Changed specifications and test conditions for input high voltage parameter.....	5

5 Device Comparison

表 5-1. Related Devices

RELATED DEVICES	16-BIT	14-BIT	12-BIT	10-BIT	8-BIT
Pin and Function Compatible	DAC8411	DAC8311	DAC7311	DAC6311	DAC5311

表 5-2. Relative Accuracy and Differential Nonlinearity

DEVICE	MAXIMUM RELATIVE ACCURACY (LSB)	MAXIMUM DIFFERENTIAL NONLINEARITY (LSB)
DAC5311	±0.25	±0.25
DAC6311	±0.5	±0.5
DAC7311	±1	±1

6 Pin Configuration and Functions

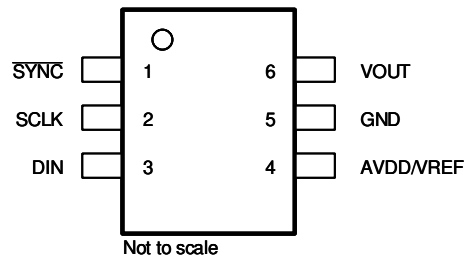


図 6-1. DCK Package, 6-Pin SC70 (Top View)

表 6-1. Pin Functions

PIN		TYPE	DESCRIPTION
NAME	NO.		
AV _{DD} /V _{REF}	4	Input	Power supply input, 2.0 V to 5.5 V.
D _{IN}	3	Input	Serial Data Input. Data are clocked into the 16-bit input shift register on the falling edge of the serial clock input.
GND	5	—	Ground reference point for all circuitry on the part.
SCLK	2	Input	Serial clock input. Data are transferred at rates up to 50 MHz.
SYNC	1	Input	Level-triggered control input (active low). This pin is the frame synchronization signal for the input data. When SYNC goes low, the input shift register is enabled and data are transferred in on the falling edges of the following clocks. The DAC is updated following 16th clock cycle, unless SYNC is taken high before this edge, in which case the rising edge of SYNC acts as an interrupt and the write sequence is ignored by the DACx311. See the SYNC Interrupt section for more details.
V _{OUT}	6	Output	Analog output voltage from DAC. The output amplifier has rail-to-rail operation.

7 Specifications

7.1 Absolute Maximum Ratings

over operating free-air temperature range (unless otherwise noted) ⁽¹⁾

			MIN	MAX	UNIT
	Voltage	AV _{DD} to GND	-0.3	+6	V
		Digital input voltage to GND	-0.3	+AV _{DD} + 0.3	V
		V _{OUT} to GND	-0.3	+AV _{DD} + 0.3	V
T _J	Junction temperature		150	°C	
T _{stg}	Storage temperature		-65	150	°C

- (1) Stresses beyond those listed under *Absolute Maximum Ratings* may cause permanent damage to the device. These are stress ratings only, which do not imply functional operation of the device at these or any other conditions beyond those indicated under *Recommended Operating Conditions*. Exposure to absolute-maximum-rated conditions for extended periods may affect device reliability.

7.2 ESD Ratings

			VALUE	UNIT
V _(ESD)	Electrostatic discharge	Human-body model (HBM), per ANSI/ESDA/JEDEC JS-001 ⁽¹⁾	±1000	V
		Charged-device model (CDM), per JEDEC specification JESD22-C101 ⁽²⁾	±500	

- (1) JEDEC document JEP155 states that 500-V HBM allows safe manufacturing with a standard ESD control process.
 (2) JEDEC document JEP157 states that 250-V CDM allows safe manufacturing with a standard ESD control process.

7.3 Recommended Operating Conditions

over operating free-air temperature range (unless otherwise noted)

		MIN	NOM	MAX	UNIT
T _A	Operating temperature	-40		125	°C
AV _{DD}	Supply voltage	2		5.5	V

7.4 Thermal Information

THERMAL METRIC ⁽¹⁾		DACx311	UNIT
		DCK (SC70)	
		6 PINS	
R _{θJA}	Junction-to-ambient thermal resistance	216.4	°C/W
R _{θJC(top)}	Junction-to-case (top) thermal resistance	52.1	°C/W
R _{θJB}	Junction-to-board thermal resistance	65.9	°C/W
ψ _{JT}	Junction-to-top characterization parameter	1.3	°C/W
ψ _{JB}	Junction-to-board characterization parameter	65.2	°C/W
R _{θJC(bot)}	Junction-to-case (bottom) thermal resistance	N/A	°C/W

- (1) For more information about traditional and new thermal metrics, see the application report, [Semiconductor and IC Package Thermal Metrics application note](#).

7.5 Electrical Characteristics

at $AV_{DD} = 2.0\text{ V}$ to 5.5 V , $R_L = 2\text{ k}\Omega$ to GND, $C_L = 200\text{ pF}$ to GND, and $T_A = -40^\circ\text{C}$ to $+125^\circ\text{C}$ (unless otherwise noted)

PARAMETER		TEST CONDITIONS	MIN	TYP	MAX	UNIT
STATIC PERFORMANCE⁽¹⁾						
DAC5311	Resolution		8			Bits
DAC6311			10			Bits
DAC7311			12			Bits
DAC5311	Relative accuracy	Measured by the line passing through codes 3 and 252		± 0.01	± 0.25	LSB
DAC6311		Measured by the line passing through codes 12 and 1012		± 0.06	± 0.5	LSB
DAC7311		Measured by the line passing through codes 30 and 4050		± 0.3	± 1	LSB
DAC5311	Differential nonlinearity			± 0.01	± 0.25	LSB
DAC6311				± 0.03	± 0.5	LSB
DAC7311					± 0.2	± 1
Offset error		Measured by the line passing through two codes ⁽²⁾		± 0.05	± 4	mV
Offset error drift				3		$\mu\text{V}/^\circ\text{C}$
Zero code error		All zeros loaded to the DAC register		0.2		mV
Full-scale error		All ones loaded to DAC register		0.04	0.2	% of FSR
Gain error				0.05	± 0.15	% of FSR
Gain temperature coefficient		$AV_{DD} = 5\text{ V}$		± 0.5		ppm of FSR/ $^\circ\text{C}$
		$AV_{DD} = 2.0\text{ V}$		± 1.5		
OUTPUT CHARACTERISTICS						
Output voltage range			0		AV_{DD}	V
Output voltage settling time ⁽³⁾		$R_L = 2\text{ k}\Omega$, $C_L = 200\text{ pF}$, $AV_{DD} = 5\text{ V}$, 1/4 scale to 3/4 scale		6	10	μs
		$R_L = 2\text{ M}\Omega$, $C_L = 470\text{ pF}$		12		μs
Slew rate				0.7		V/ μs
Capacitive load stability		$R_L = \infty$		470		pF
		$R_L = 2\text{ k}\Omega$		1000		pF
Code change glitch impulse		1 LSB change around major carry		0.5		nV-s
Digital feedthrough				0.5		nV-s
Power-on glitch impulse		$R_L = 2\text{ k}\Omega$, $C_L = 200\text{ pF}$, $AV_{DD} = 5\text{ V}$		17		mV
DC output impedance				0.5		Ω
Short circuit current		$AV_{DD} = 5\text{ V}$		50		mA
		$AV_{DD} = 3\text{ V}$		20		mA
Power-up time		Coming out of power-down mode		50		μs
AC PERFORMANCE						
SNR		$T_A = 25^\circ\text{C}$, BW = 20 kHz, 12-bit level, $AV_{DD} = 5\text{ V}$, $f_{\text{OUT}} = 1\text{ kHz}$, 1st 19 harmonics removed for SNR calculation		81		dB
THD				-65		dB
SFDR				65		dB
SINAD				65		dB

7.5 Electrical Characteristics (continued)

at $AV_{DD} = 2.0\text{ V to }5.5\text{ V}$, $R_L = 2\text{ k}\Omega$ to GND, $C_L = 200\text{ pF}$ to GND, and $T_A = -40^\circ\text{C to }+125^\circ\text{C}$ (unless otherwise noted)

PARAMETER		TEST CONDITIONS		MIN	TYP	MAX	UNIT
DAC output noise density ⁽⁴⁾	$T_A = 25^\circ\text{C}$, at zero-scale input, $f_{OUT} = 1\text{ kHz}$, $AV_{DD} = 5\text{ V}$				17		nV/ $\sqrt{\text{Hz}}$
	$T_A = 25^\circ\text{C}$, at mid-code input, $f_{OUT} = 1\text{ kHz}$, $AV_{DD} = 5\text{ V}$				110		nV/ $\sqrt{\text{Hz}}$
DAC output noise ⁽⁵⁾	$T_A = +25^\circ\text{C}$, at mid-code input, 0.1 Hz to 10 Hz, $AV_{DD} = 5\text{ V}$				3		μV_{PP}
LOGIC INPUTS⁽³⁾							
Input current						± 1	μA
V_{INL} , Input low voltage	$AV_{DD} = 2.7\text{ V to }5.5\text{ V}$				$0.3 \times AV_{DD}$		V
	$AV_{DD} = 2.0\text{ V to }2.7\text{ V}$				$0.1 \times AV_{DD}$		V
V_{INH} , Input high voltage	$AV_{DD} = 2.7\text{ V to }5.5\text{ V}$				$0.7 \times AV_{DD}$		V
	$AV_{DD} = 2.0\text{ V to }2.7\text{ V}$				$0.9 \times AV_{DD}$		V
Pin capacitance					1.5	3	pF
POWER REQUIREMENTS							
AV_{DD}				2.0		5.5	V
I_{DD}	Normal mode	$V_{INH} = AV_{DD}$ and $V_{INL} = \text{GND}$, at midscale code ⁽⁶⁾	$AV_{DD} = 3.6\text{ V to }5.5\text{ V}$		110	180	μA
			$AV_{DD} = 2.7\text{ V to }3.6\text{ V}$		95	150	μA
			$AV_{DD} = 2.0\text{ V to }2.7\text{ V}$		80	140	μA
	All power-down mode	$V_{INH} = AV_{DD}$ and $V_{INL} = \text{GND}$, at midscale code ⁽⁶⁾	$AV_{DD} = 3.6\text{ V to }5.5\text{ V}$		0.5	3.5	μA
			$AV_{DD} = 2.7\text{ V to }3.6\text{ V}$		0.4	3	μA
			$AV_{DD} = 2.0\text{ V to }2.7\text{ V}$		0.1	2	μA
Power dissipation	Normal mode	$V_{INH} = AV_{DD}$ and $V_{INL} = \text{GND}$, at midscale code ⁽⁶⁾	$AV_{DD} = 3.6\text{ V to }5.5\text{ V}$		0.55	0.99	mW
			$AV_{DD} = 2.7\text{ V to }3.6\text{ V}$		0.25	0.54	mW
			$AV_{DD} = 2.0\text{ V to }2.7\text{ V}$		0.14	0.38	mW
	All power-down mode	$V_{INH} = AV_{DD}$ and $V_{INL} = \text{GND}$, at midscale code ⁽⁶⁾	$AV_{DD} = 3.6\text{ V to }5.5\text{ V}$		2.50	19.2	μW
			$AV_{DD} = 2.7\text{ V to }3.6\text{ V}$		1.08	10.8	μW
			$AV_{DD} = 2.0\text{ V to }2.7\text{ V}$		0.72	8.1	μW

- (1) Linearity calculated using a reduced code range of 3 to 252 for 8-bit, 12 to 1012 for 10bit, and 30 to 4050 for 12-bit, output unloaded.
- (2) Straight line passing through codes 3 and 252 for 8-bit, 12 and 1012 for 10-bit, and 30 and 4050 for 12-bit, output unloaded.
- (3) Specified by design and characterization, not production tested.
- (4) For more details, see [7-23](#).
- (5) For more details, see [7-24](#).
- (6) For more details, see [7-16](#) and [7-58](#).

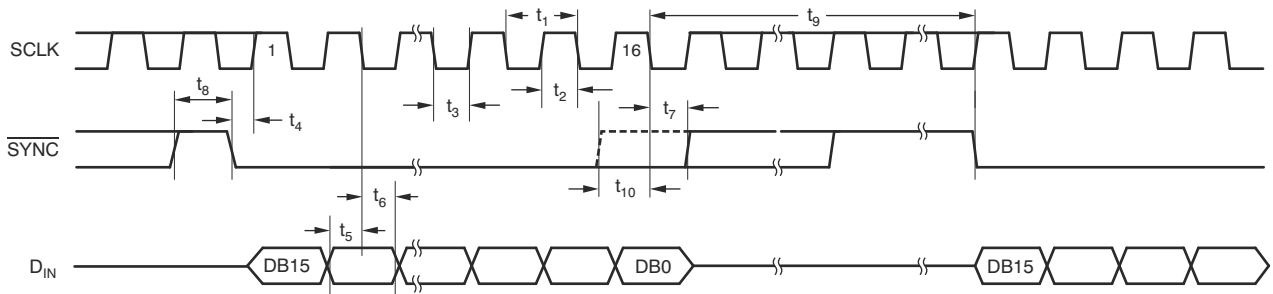
7.6 Timing Requirements

at -40°C to 125°C , and $\text{AV}_{\text{DD}} = 2\text{ V}$ to 5.5 V (unless otherwise noted)⁽¹⁾

		MIN	NOM	MAX	UNIT
$f_{(\text{SCLK})}$	Serial clock frequency	$\text{AV}_{\text{DD}} = 2.0\text{ V}$ to 3.6 V		20	MHz
		$\text{AV}_{\text{DD}} = 3.6\text{ V}$ to 5.5 V		50	
t_1	SCLK cycle time	$\text{AV}_{\text{DD}} = 2.0\text{ V}$ to 3.6 V		50	ns
		$\text{AV}_{\text{DD}} = 3.6\text{ V}$ to 5.5 V		20	
t_2	SCLK high time	$\text{AV}_{\text{DD}} = 2.0\text{ V}$ to 3.6 V		25	ns
		$\text{AV}_{\text{DD}} = 3.6\text{ V}$ to 5.5 V		10	
t_3	SCLK low time	$\text{AV}_{\text{DD}} = 2.0\text{ V}$ to 3.6 V		25	ns
		$\text{AV}_{\text{DD}} = 3.6\text{ V}$ to 5.5 V		10	
t_4	$\overline{\text{SYNC}}$ to SCLK rising edge setup time	$\text{AV}_{\text{DD}} = 2.0\text{ V}$ to 3.6 V		0	ns
		$\text{AV}_{\text{DD}} = 3.6\text{ V}$ to 5.5 V		0	
t_5	Data setup time	$\text{AV}_{\text{DD}} = 2.0\text{ V}$ to 3.6 V		5	ns
		$\text{AV}_{\text{DD}} = 3.6\text{ V}$ to 5.5 V		5	
t_6	Data hold time	$\text{AV}_{\text{DD}} = 2.0\text{ V}$ to 3.6 V		4.5	ns
		$\text{AV}_{\text{DD}} = 3.6\text{ V}$ to 5.5 V		4.5	
t_7	SCLK falling edge to $\overline{\text{SYNC}}$ rising edge	$\text{AV}_{\text{DD}} = 2.0\text{ V}$ to 3.6 V		0	ns
		$\text{AV}_{\text{DD}} = 3.6\text{ V}$ to 5.5 V		0	
t_8	Minimum $\overline{\text{SYNC}}$ high time	$\text{AV}_{\text{DD}} = 2.0\text{ V}$ to 3.6 V		50	ns
		$\text{AV}_{\text{DD}} = 3.6\text{ V}$ to 5.5 V		20	
t_9	16th SCLK falling edge to $\overline{\text{SYNC}}$ falling edge	$\text{AV}_{\text{DD}} = 2.0\text{ V}$ to 3.6 V		100	ns
		$\text{AV}_{\text{DD}} = 3.6\text{ V}$ to 5.5 V		100	
t_{10}	SYNC rising edge to 16th SCLK falling edge (for successful SYNC interrupt)	$\text{AV}_{\text{DD}} = 2.0\text{ V}$ to 3.6 V		15	ns
		$\text{AV}_{\text{DD}} = 3.6\text{ V}$ to 5.5 V		15	

(1) All input signals are specified with $t_R = t_F = 3\text{ ns}$ (10% to 90% of AV_{DD}) and timed from a voltage level of $(V_{\text{IL}} + V_{\text{IH}}) / 2$.

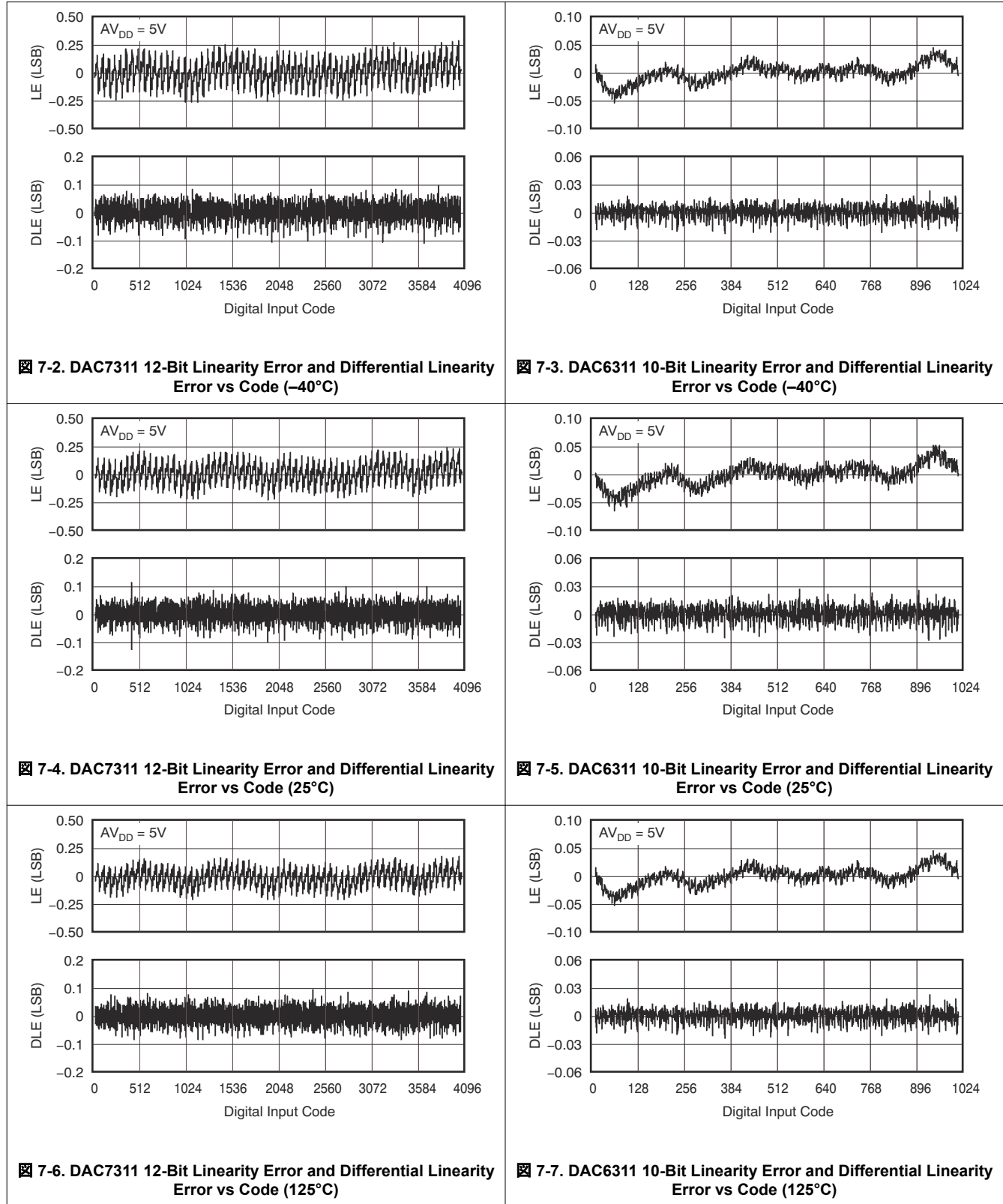
7.7 Timing Diagrams



7-1. Serial Write Operation

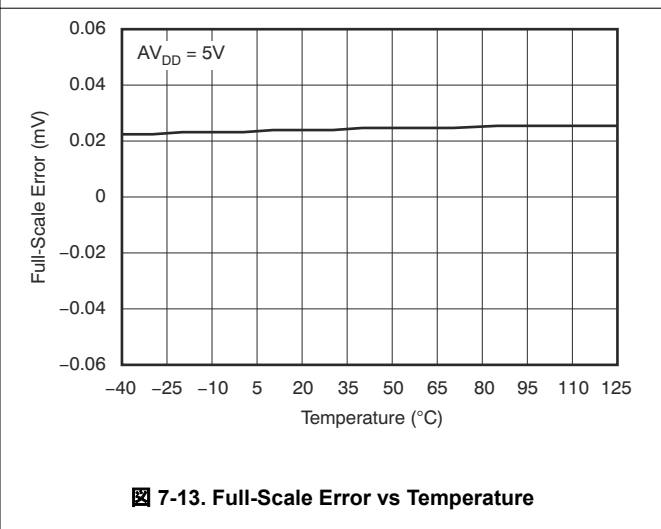
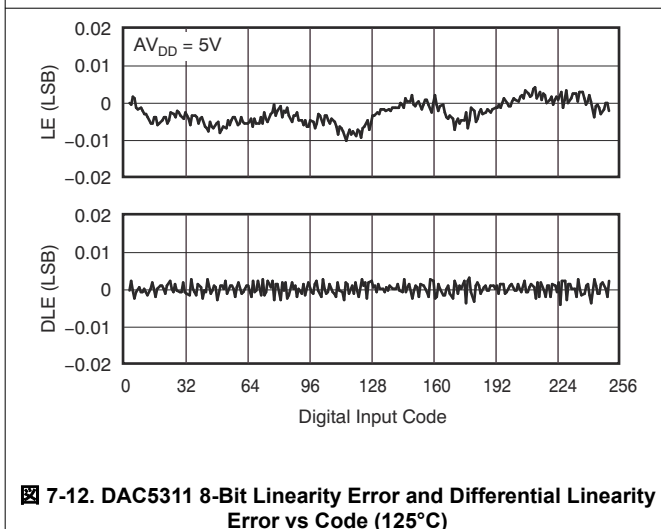
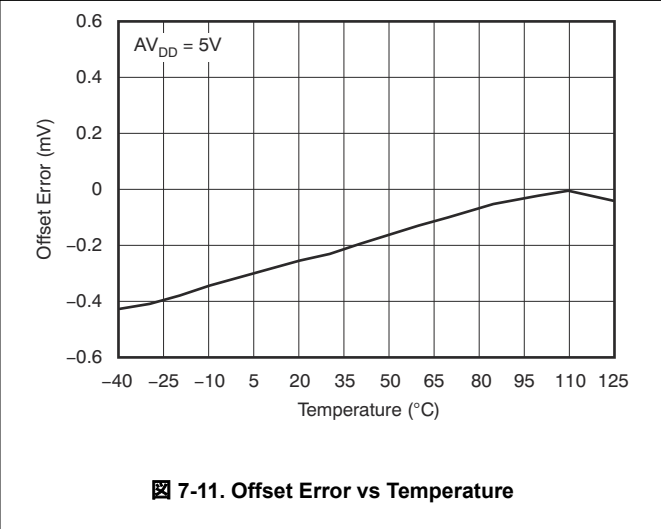
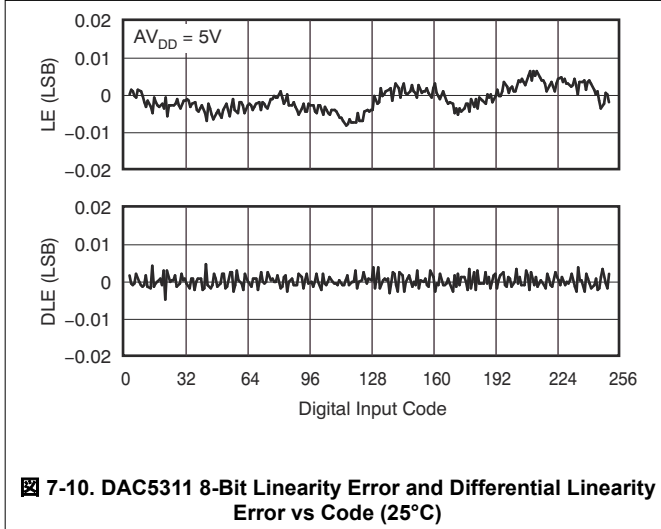
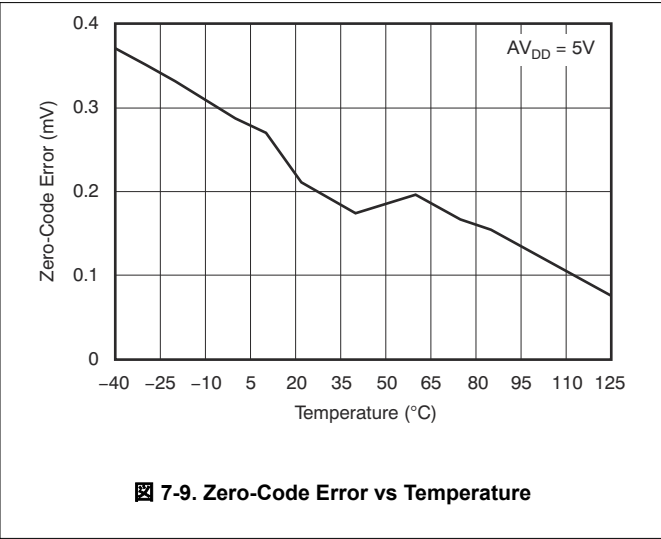
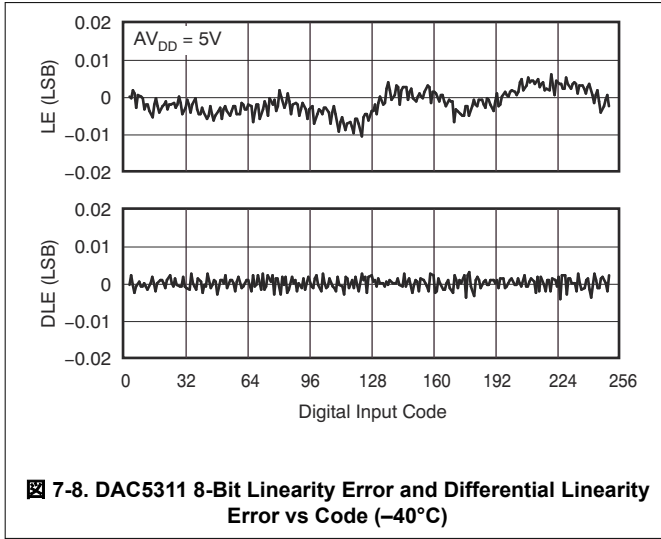
7.8 Typical Characteristics: $AV_{DD} = 5\text{ V}$

at $T_A = 25^\circ\text{C}$, $AV_{DD} = 5\text{ V}$, and DAC loaded with midscale code (unless otherwise noted)



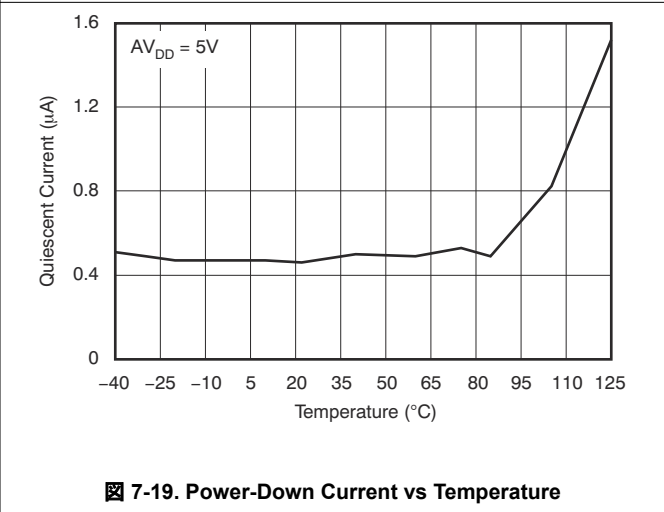
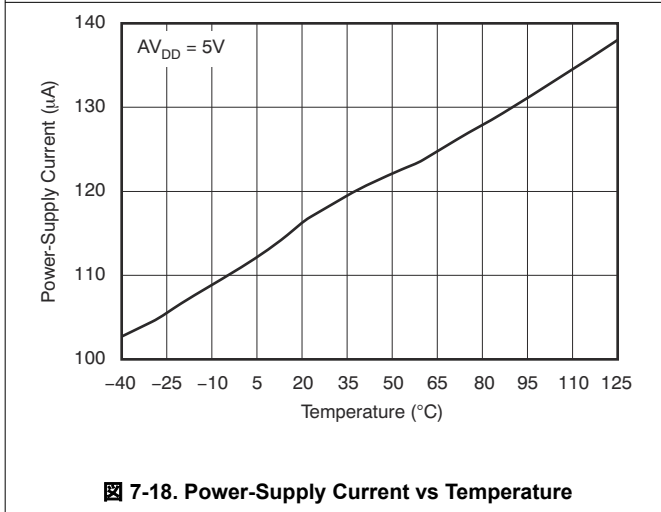
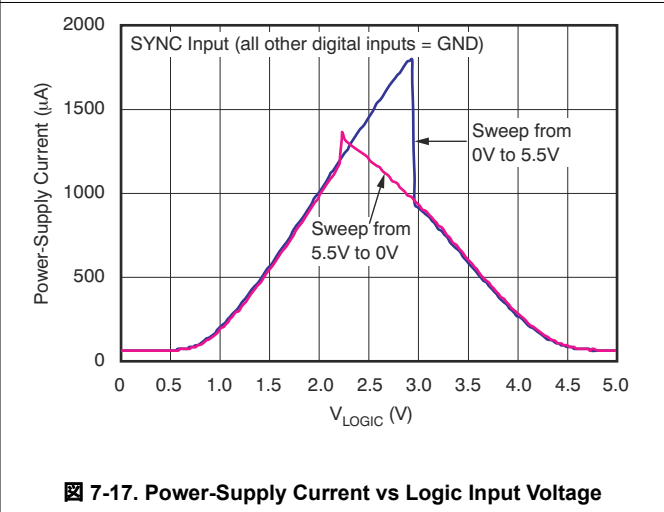
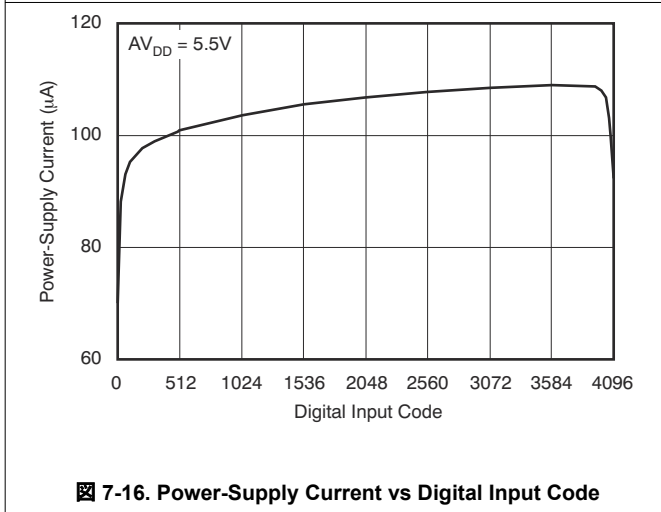
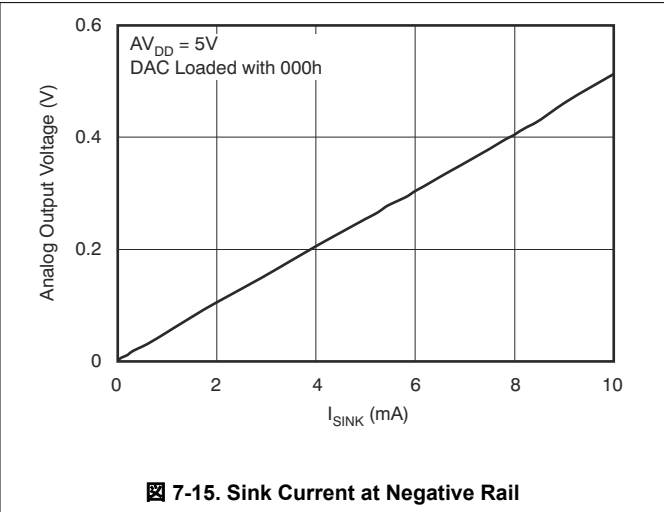
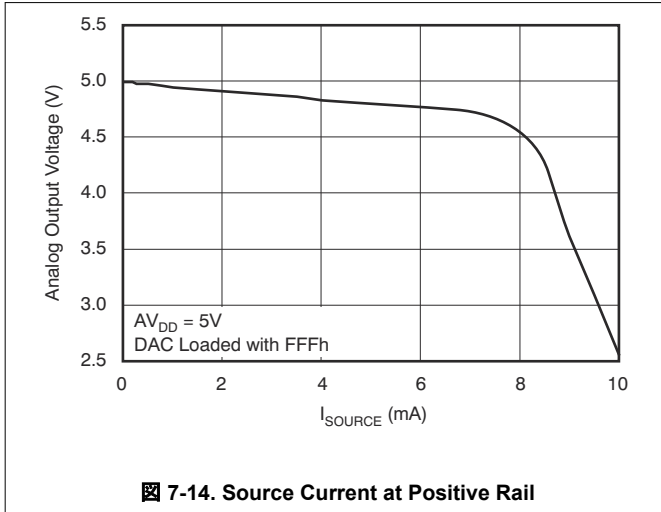
7.8 Typical Characteristics: $AV_{DD} = 5\text{ V}$ (continued)

at $T_A = 25^\circ\text{C}$, $AV_{DD} = 5\text{ V}$, and DAC loaded with midscale code (unless otherwise noted)



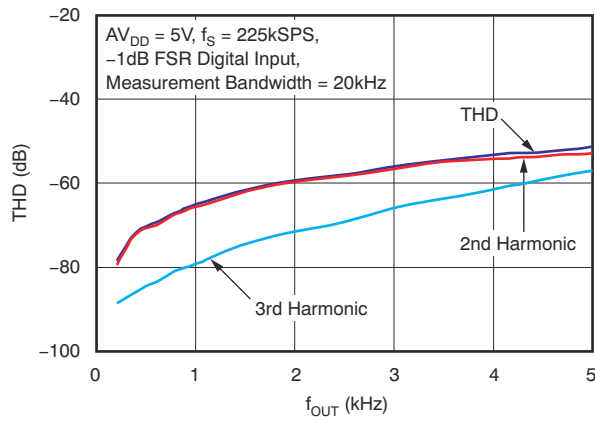
7.8 Typical Characteristics: $AV_{DD} = 5\text{ V}$ (continued)

at $T_A = 25^\circ\text{C}$, $AV_{DD} = 5\text{ V}$, and DAC loaded with midscale code (unless otherwise noted)

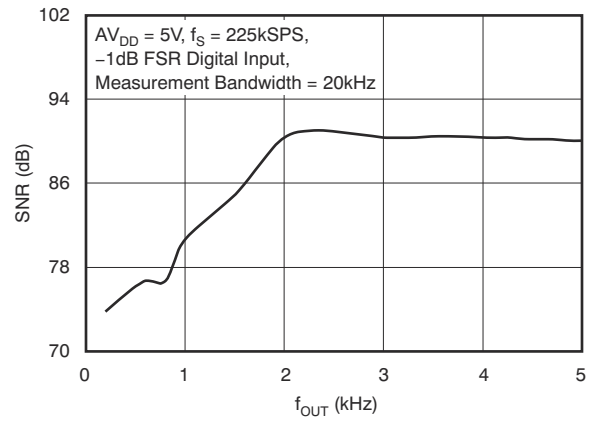


7.8 Typical Characteristics: AV_{DD} = 5 V (continued)

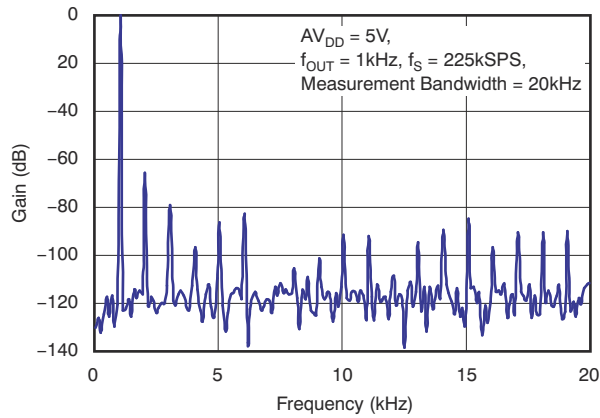
at T_A = 25°C, AV_{DD} = 5 V, and DAC loaded with midscale code (unless otherwise noted)



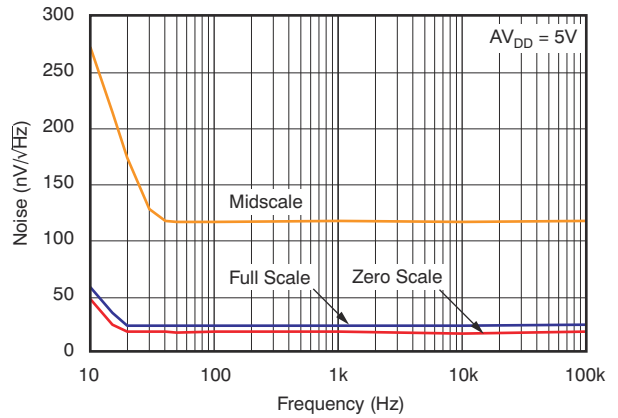
7-20. Total Harmonic Distortion vs Output Frequency



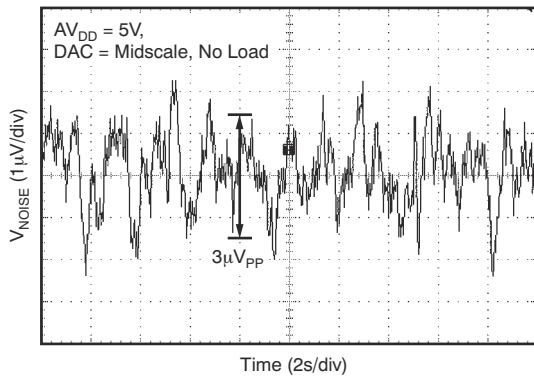
7-21. Signal-to-Noise Ratio vs Output Frequency



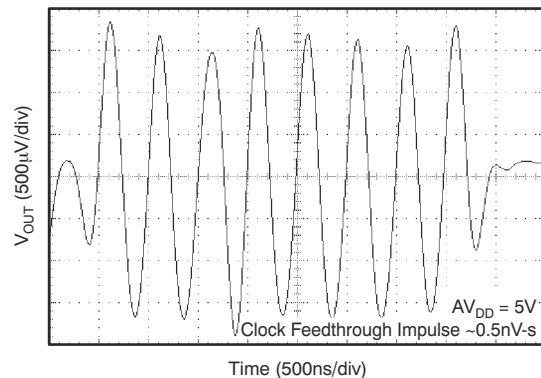
7-22. Power Spectral Density



7-23. DAC Output Noise Density vs Frequency



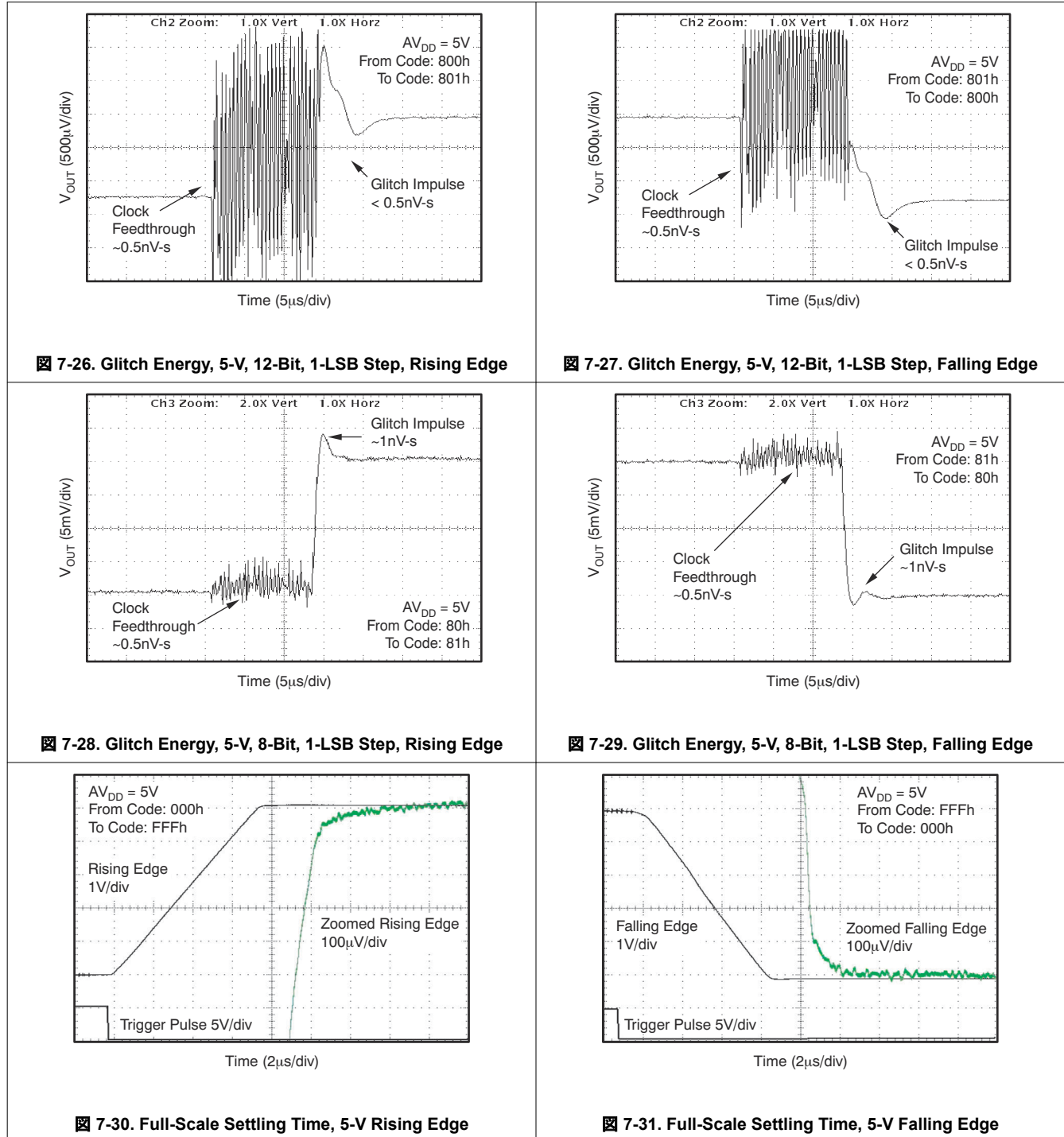
7-24. DAC Output Noise, 0.1-Hz to 10-Hz Bandwidth



7-25. Clock Feedthrough, 5-V, 2-MHz, Midscale

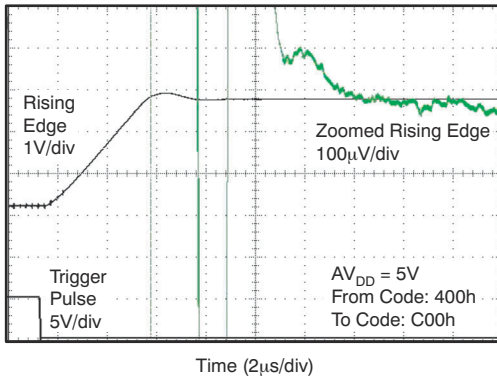
7.8 Typical Characteristics: $AV_{DD} = 5\text{ V}$ (continued)

at $T_A = 25^\circ\text{C}$, $AV_{DD} = 5\text{ V}$, and DAC loaded with midscale code (unless otherwise noted)

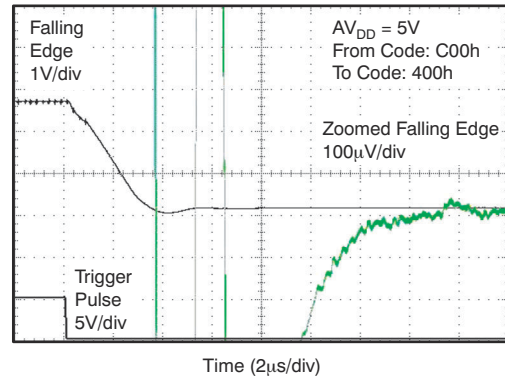


7.8 Typical Characteristics: $AV_{DD} = 5\text{ V}$ (continued)

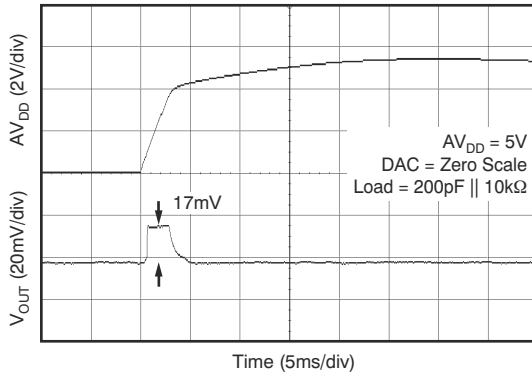
at $T_A = 25^\circ\text{C}$, $AV_{DD} = 5\text{ V}$, and DAC loaded with midscale code (unless otherwise noted)



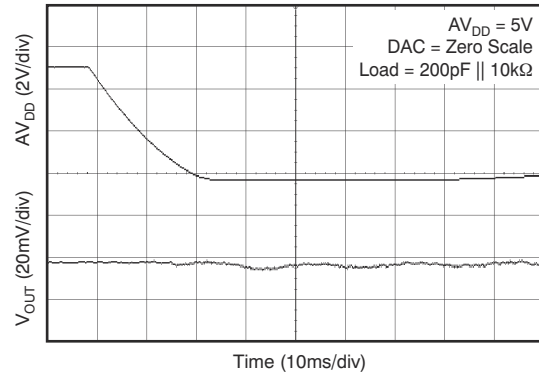
7-32. Half-Scale Settling Time, 5-V Rising Edge



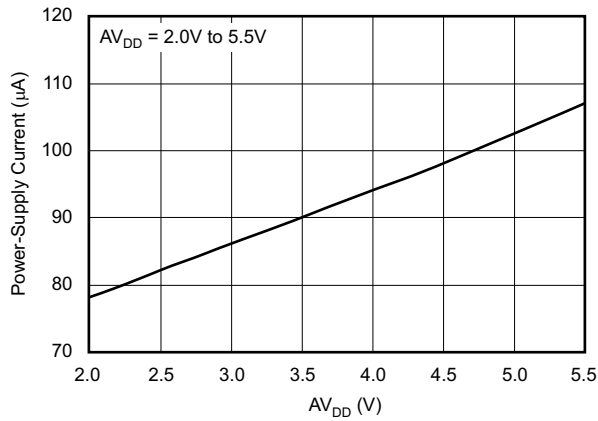
7-33. Half-Scale Settling Time 5-V Falling Edge



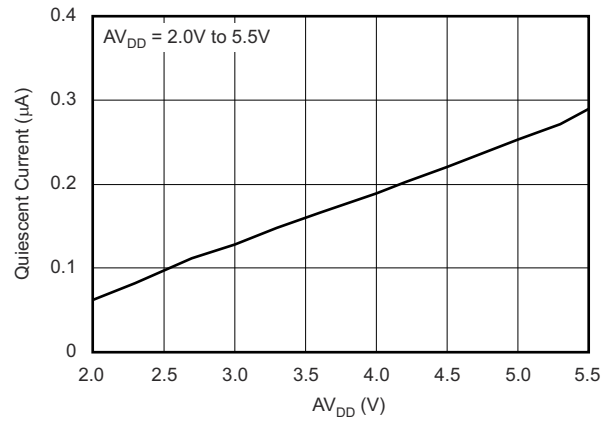
7-34. Power-On Reset to 0-V Power-On Glitch



7-35. Power-Off Glitch



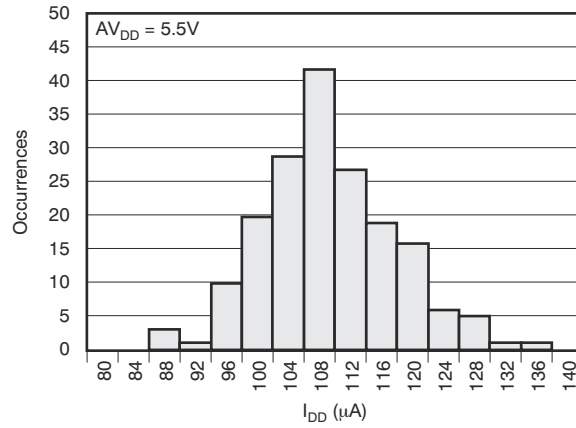
7-36. Power-Supply Current vs Power-Supply Voltage



7-37. Power-Down Current vs Power-Supply Voltage

7.8 Typical Characteristics: $AV_{DD} = 5\text{ V}$ (continued)

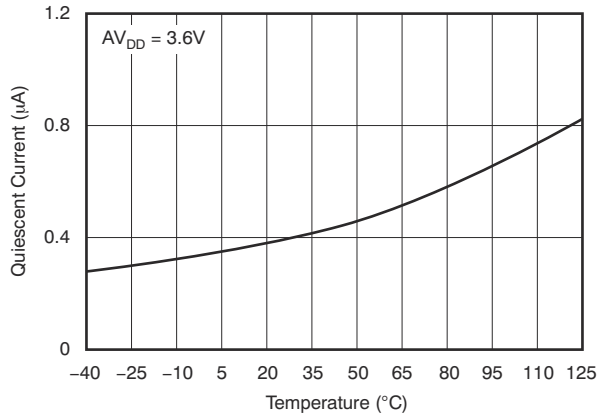
at $T_A = 25^\circ\text{C}$, $AV_{DD} = 5\text{ V}$, and DAC loaded with midscale code (unless otherwise noted)



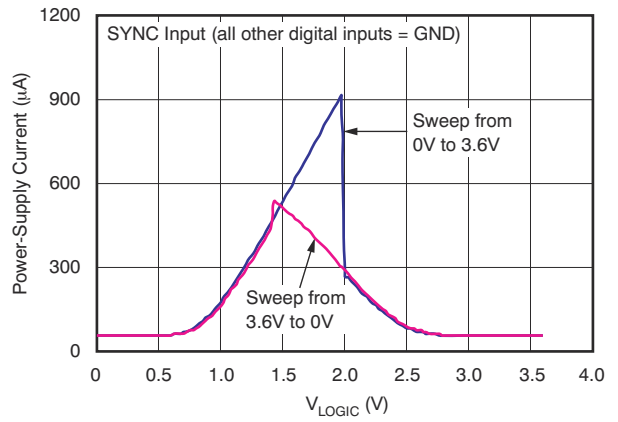
7-38. Power-Supply Current Histogram

7.9 Typical Characteristics: $AV_{DD} = 3.6\text{ V}$

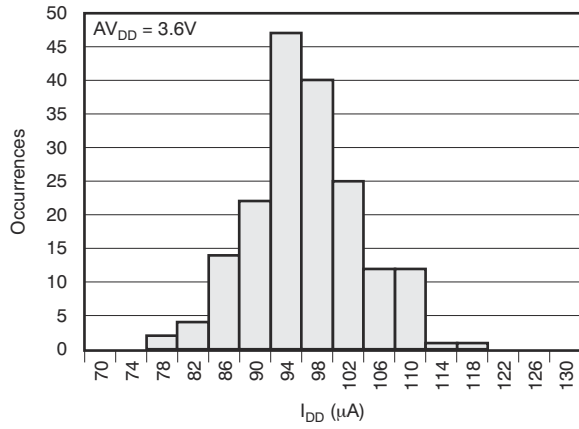
at $T_A = 25^\circ\text{C}$, $AV_{DD} = 3.6\text{ V}$, and DAC loaded with midscale code (unless otherwise noted)



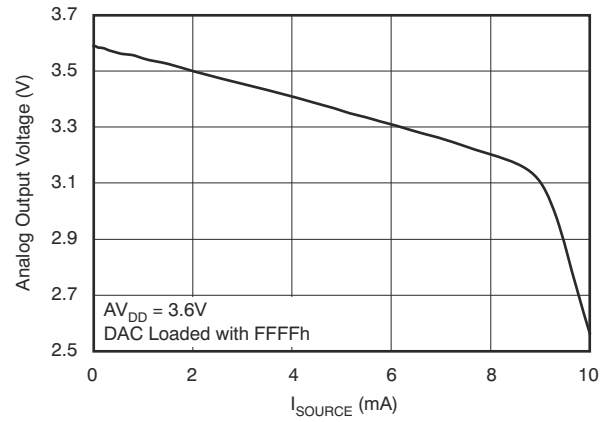
7-39. Power-Down Current vs Temperature



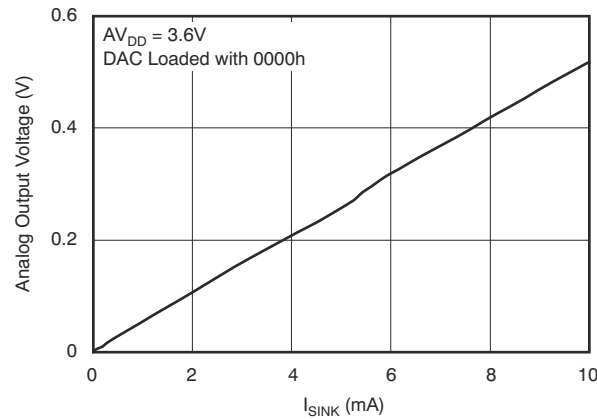
7-40. Power-Supply Current vs Logic Input Voltage



7-41. Power-Supply Current Histogram



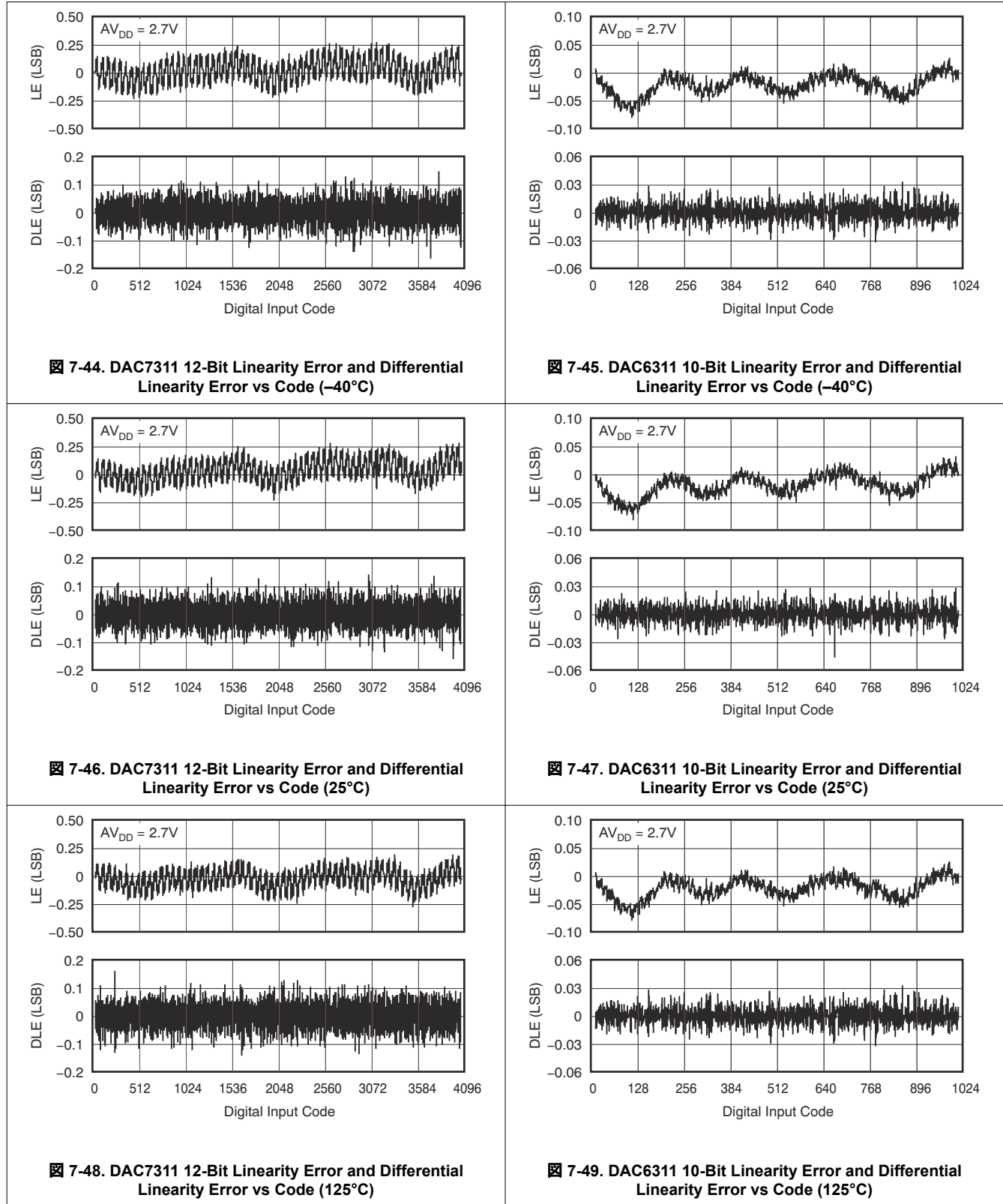
7-42. Source Current at Positive Rail



7-43. Sink Current at Negative Rail

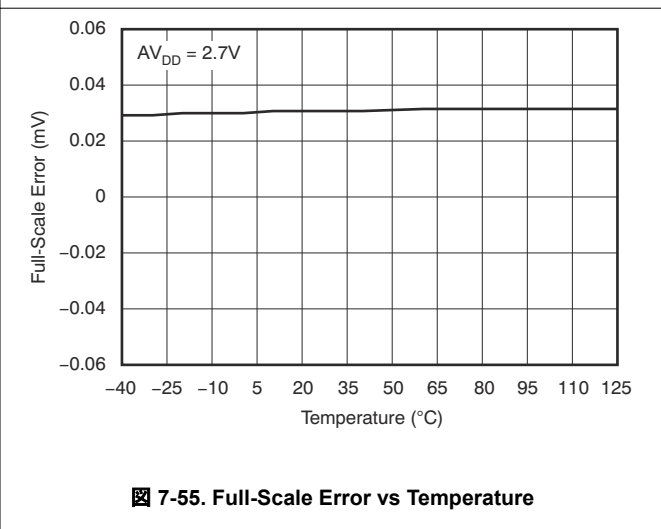
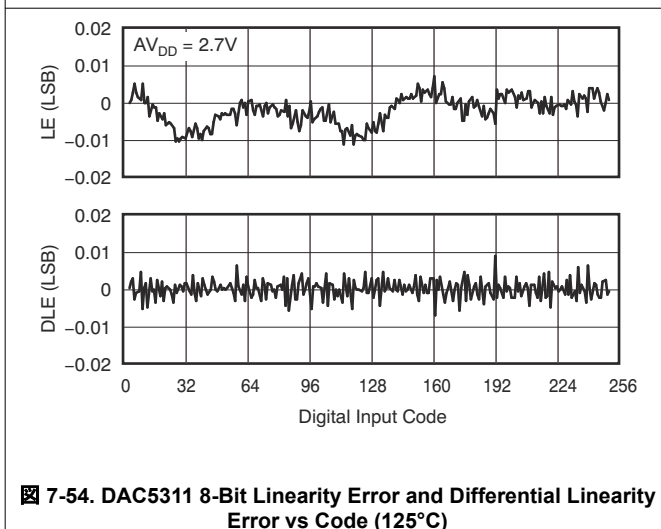
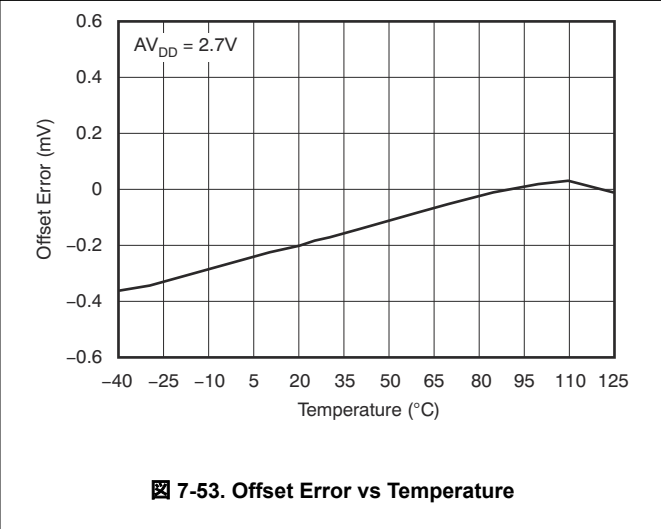
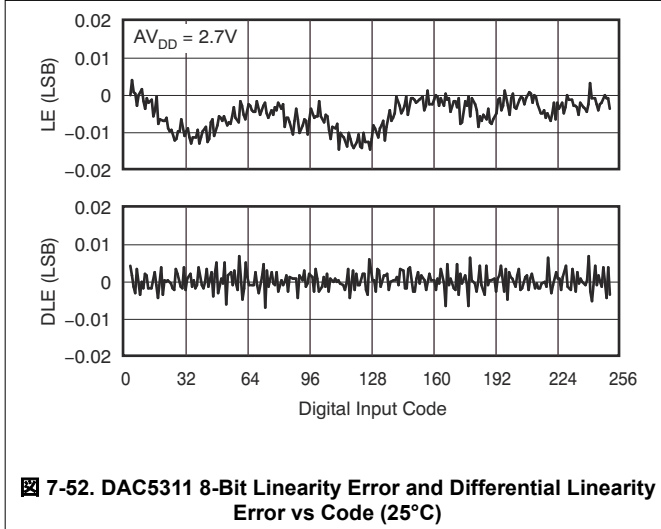
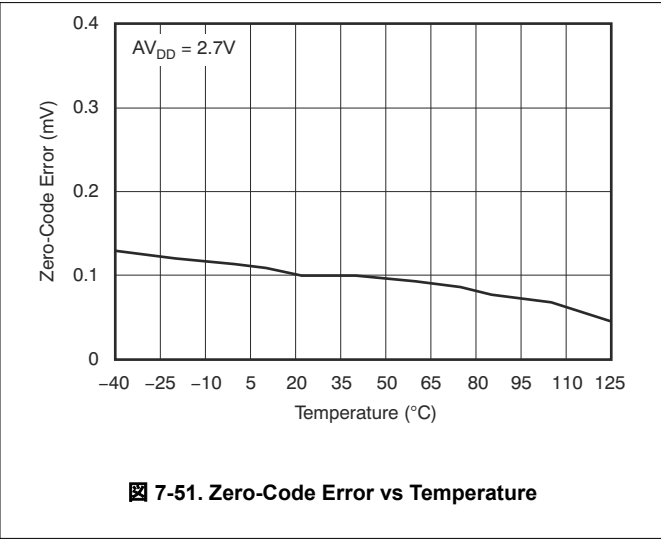
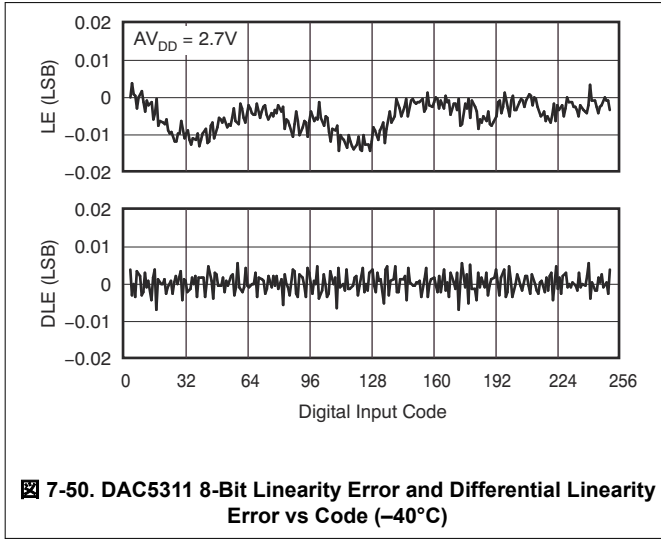
7.10 Typical Characteristics: $AV_{DD} = 2.7\text{ V}$

at $T_A = 25^\circ\text{C}$, $AV_{DD} = 2.7\text{ V}$, and DAC loaded with midscale code (unless otherwise noted)



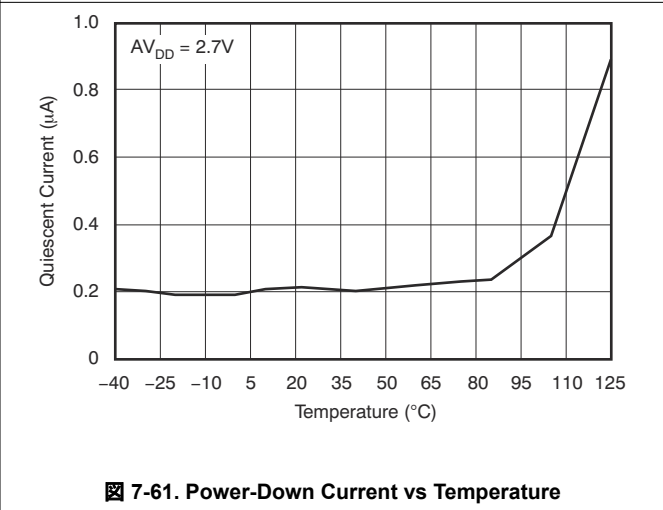
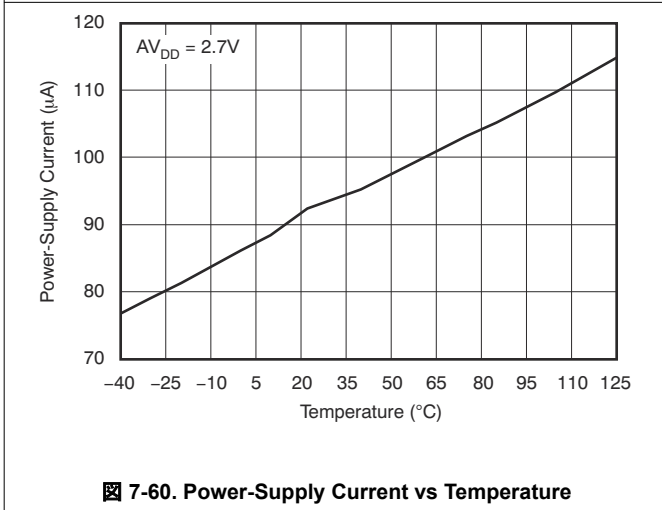
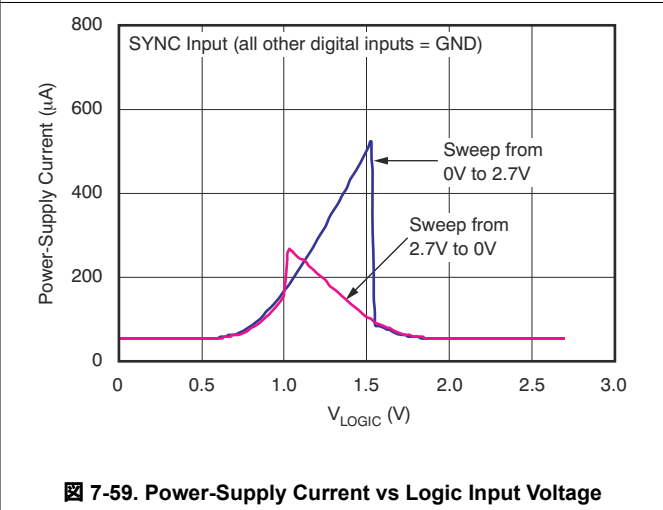
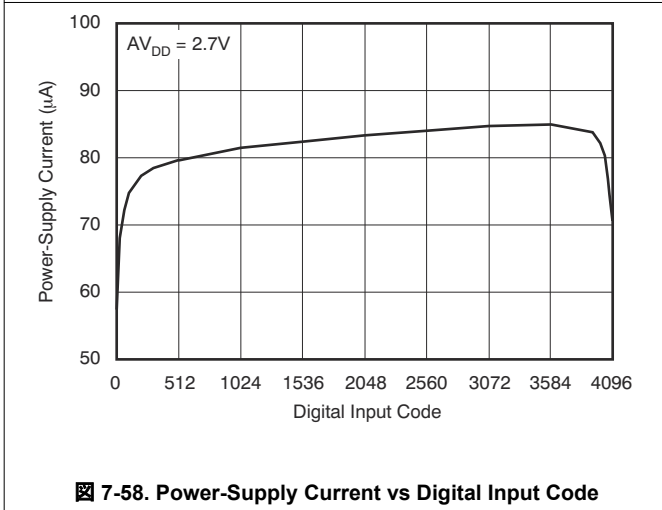
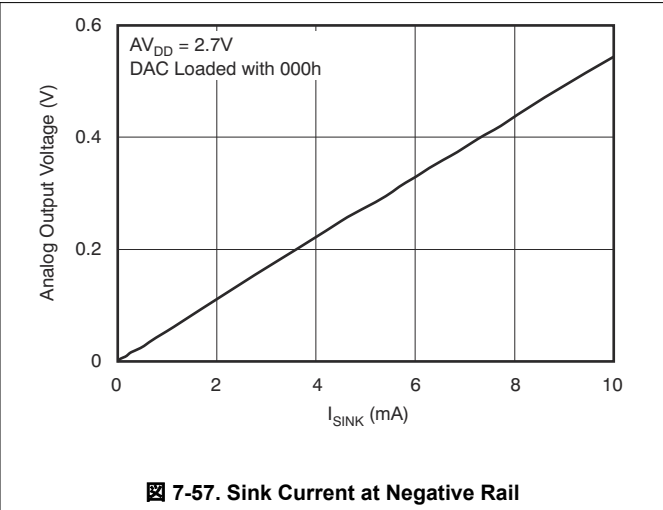
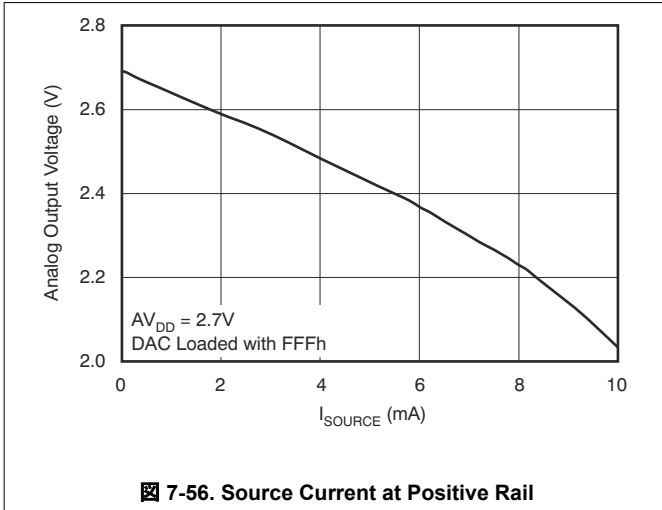
7.10 Typical Characteristics: $AV_{DD} = 2.7\text{ V}$ (continued)

at $T_A = 25^\circ\text{C}$, $AV_{DD} = 2.7\text{ V}$, and DAC loaded with midscale code (unless otherwise noted)



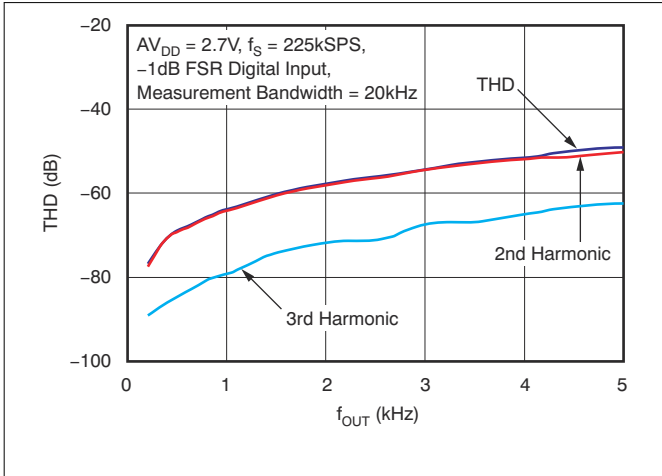
7.10 Typical Characteristics: AV_{DD} = 2.7 V (continued)

at T_A = 25°C, AV_{DD} = 2.7 V, and DAC loaded with midscale code (unless otherwise noted)

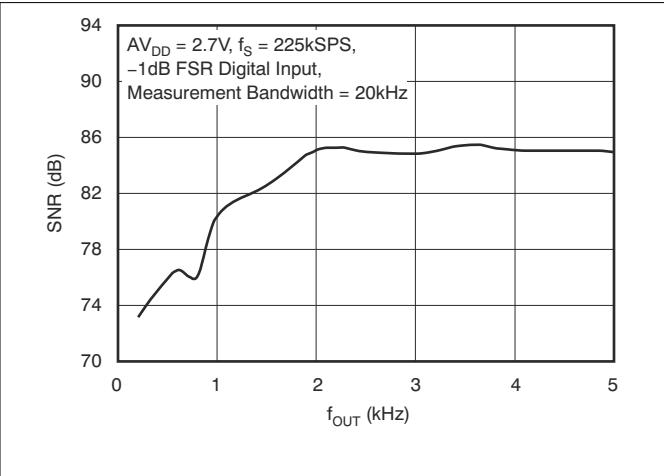


7.10 Typical Characteristics: AV_{DD} = 2.7 V (continued)

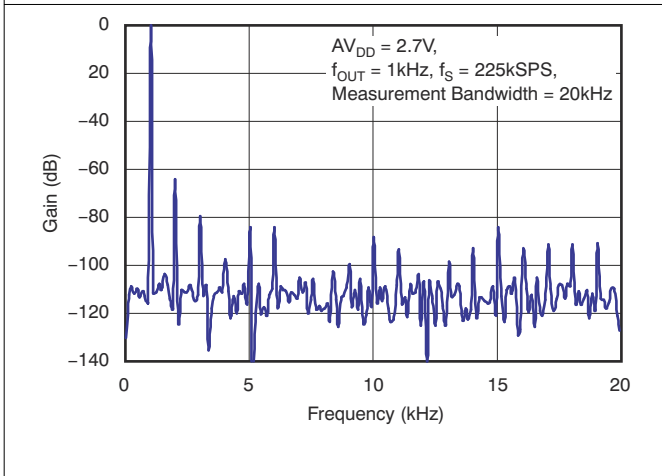
at T_A = 25°C, AV_{DD} = 2.7 V, and DAC loaded with midscale code (unless otherwise noted)



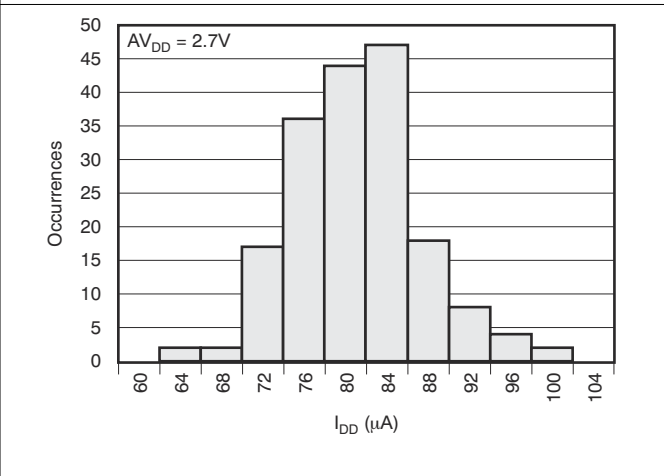
7-62. Total Harmonic Distortion vs Output Frequency



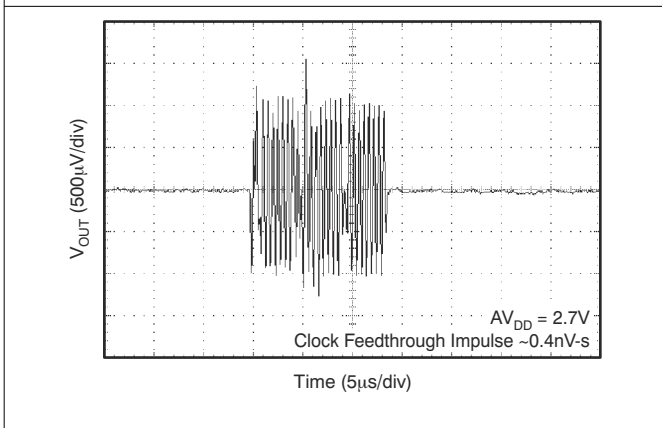
7-63. Signal-to-Noise Ratio vs Output Frequency



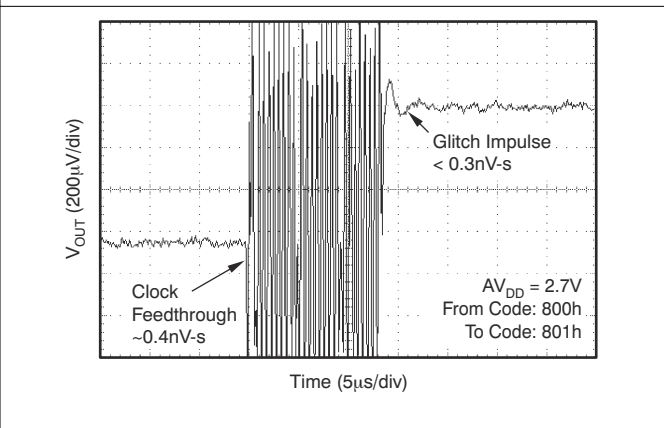
7-64. Power Spectral Density



7-65. Power-Supply Current Histogram



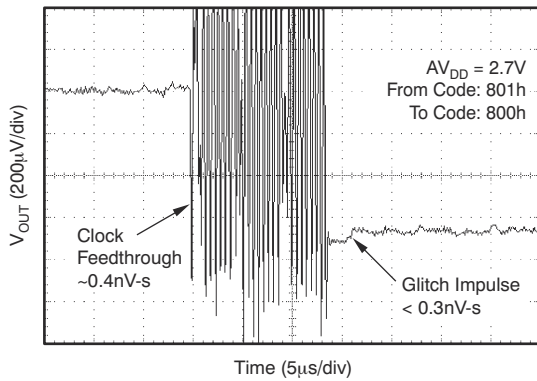
7-66. Clock Feedthrough 2.7-V, 20-MHz, Midscale



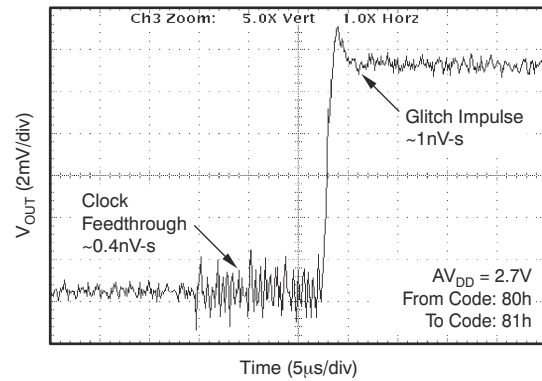
7-67. Glitch Energy, 2.7-V, 12-Bit, 1-LSB Step, Rising Edge

7.10 Typical Characteristics: $AV_{DD} = 2.7\text{ V}$ (continued)

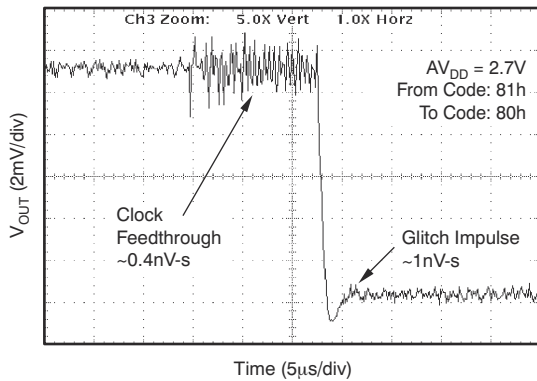
at $T_A = 25^\circ\text{C}$, $AV_{DD} = 2.7\text{ V}$, and DAC loaded with midscale code (unless otherwise noted)



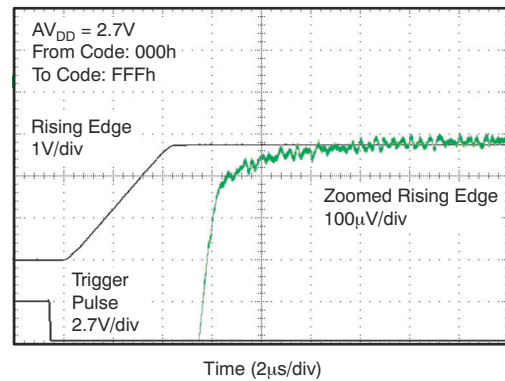
7-68. Glitch Energy, 2.7-V, 12-Bit, 1-LSB Step, Falling Edge



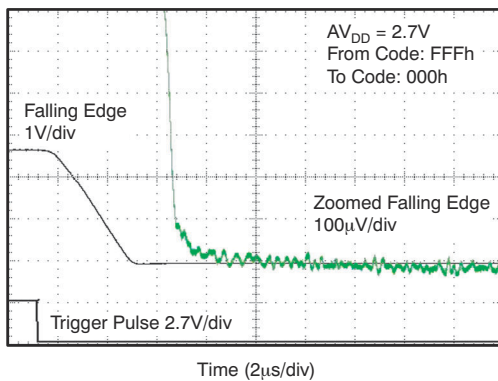
7-69. Glitch Energy, 2.7-V, 8-Bit, 1-LSB Step, Rising Edge



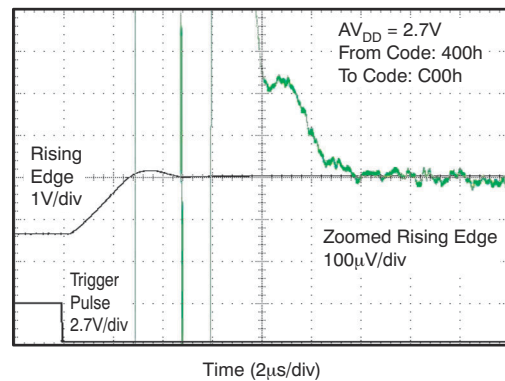
7-70. Glitch Energy, 2.7-V, 8-Bit, 1-LSB Step, Falling Edge



7-71. Full-Scale Settling Time, 2.7-V Rising Edge



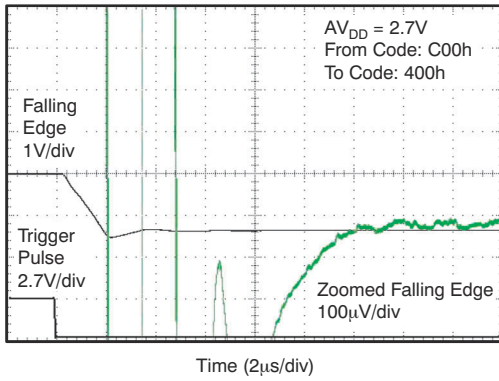
7-72. Full-Scale Settling Time, 2.7-V Falling Edge



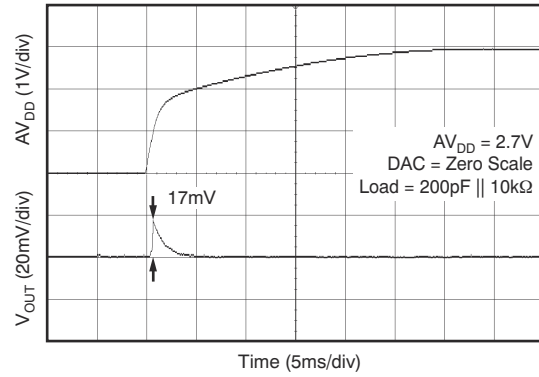
7-73. Half-Scale Settling Time, 2.7-V Rising Edge

7.10 Typical Characteristics: $AV_{DD} = 2.7\text{ V}$ (continued)

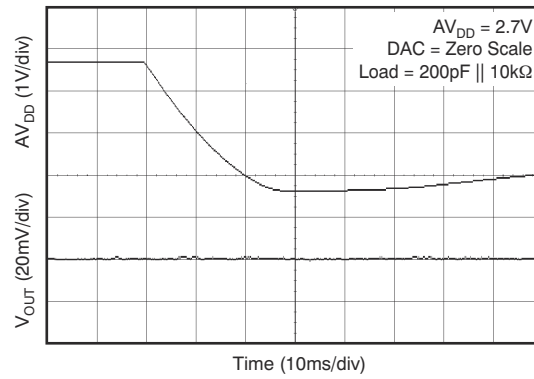
at $T_A = 25^\circ\text{C}$, $AV_{DD} = 2.7\text{ V}$, and DAC loaded with midscale code (unless otherwise noted)



7-74. Half-Scale Settling Time, 2.7-V Falling Edge



7-75. Power-On Reset to 0-V Power-On Glitch



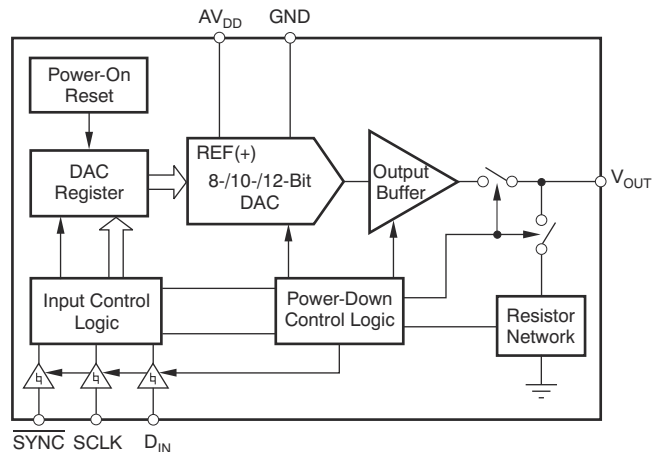
7-76. Power-Off Glitch

8 Detailed Description

8.1 Overview


The 8-bit DAC5311, 10-bit DAC6311, and 12-bit DAC7311 devices (DACx311) are low-power, single-channel, voltage output DACs. These devices are monotonic by design, provide excellent linearity, and minimize undesired code-to-code transient voltages while offering an easy upgrade path within a pin-compatible family. All devices use a versatile, three-wire serial interface that operates at clock rates of up to 50 MHz and is compatible with standard SPI, QSPI, Microwire, and digital signal processor (DSP) interfaces.

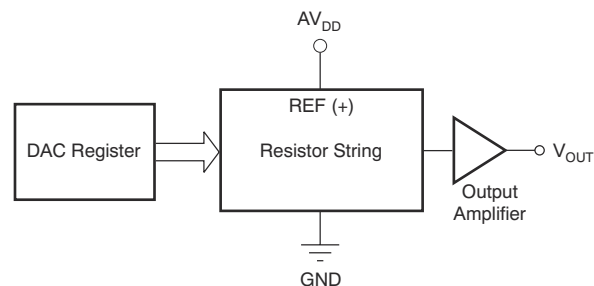
8.2 Functional Block Diagram




8.3 Feature Description

8.3.1 DAC Section

The DACx311 are fabricated using Texas Instruments' proprietary HPA07 process technology. The architecture consists of a string DAC followed by an output buffer amplifier. Because there is no reference input pin, the power supply (AV_{DD}) acts as the reference.  8-1 shows a block diagram of the DAC architecture.



 8-1. DACx311 Architecture


The input coding to the DACx311 is straight binary, so the ideal output voltage is given by:

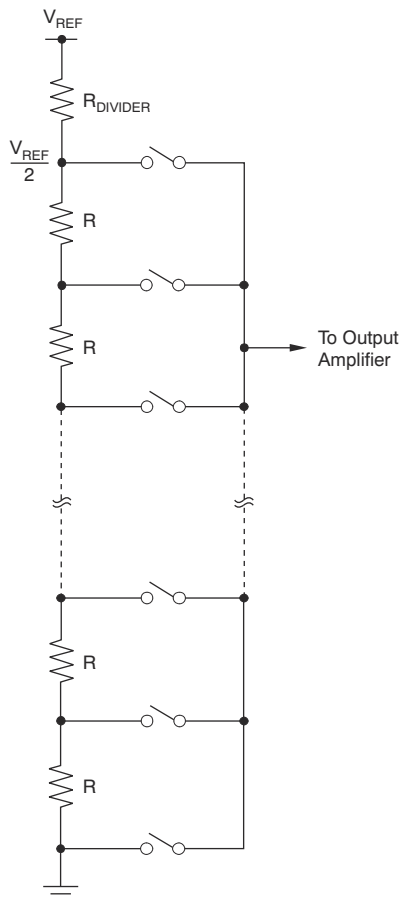
$$V_{OUT} = AV_{DD} \times \frac{D}{2^n} \quad (1)$$

where

- n = resolution in bits; either 8 (DAC5311), 10 (DAC6311), or 12 (DAC7311).
- D = decimal equivalent of the binary code that is loaded to the DAC register. D ranges from 0 to 255 for 8-bit DAC5311, 0 to 1023 for the 10-bit DAC6311, and 0 to 4095 for the 12-bit DAC7311.

8.3.2 Resistor String

 8-2 shows the resistor string section, which is a string of resistors, each of value R. The code loaded into the DAC register determines at which node on the string the voltage is tapped off to be fed into the output amplifier by closing one of the switches connecting the string to the amplifier. The resistor string architecture is inherently monotonic.




 8-2. Resistor String

8.3.3 Output Amplifier

The output buffer amplifier is capable of generating rail-to-rail voltages on the output, which gives an output range of 0 V to AV_{DD} . The output amplifier is capable of driving a load of 2 k Ω in parallel with 1000 pF to GND. The source and sink capabilities of the output amplifier can be seen in the [Typical Characteristics](#) section for the given voltage input. The slew rate is 0.7 V/ μ s with a half-scale settling time of typically 6 μ s with the output unloaded.

8.3.4 Power-On Reset

The DACx311 contain a power-on reset circuit that controls the output voltage during power up. On power up, the DAC register is filled with zeros and the output voltage is 0 V. The DAC register remains that way until a valid write sequence is made to the DAC. This design is useful in applications where knowing the state of the DAC output while powering up is important.

The occurring power-on glitch impulse is only a few millivolts (typically, 17 mV; see  7-34).

8.4 Device Functional Modes

8.4.1 Power-Down Modes

The DACx311 contain four separate modes of operation. These modes are programmable by setting two bits (PD1 and PD0) in the control register. 表 8-1 shows how the state of the bits corresponds to the mode of operation of the device.

表 8-1. Modes of Operation for the DACx311

PD1	PD0	OPERATING MODE
NORMAL MODE		
0	0	Normal Operation
POWER-DOWN MODES		
0	1	Output 1 kΩ to GND
1	0	Output 100 kΩ to GND
1	1	High-Z

When both bits are set to 0, the device works normally with a standard power consumption of typically 80 μA at 2 V. However, for the three power-down modes, the typical supply current falls to 0.5 μA at 5 V, 0.4 μA at 3 V, and 0.1 μA at 2 V. Not only does the supply current fall, but the output stage is also internally switched from the output of the amplifier to a resistor network of known values. The advantage of this architecture is that the output impedance of the part is known while the part is in power-down mode. There are three different options: the output is connected internally to GND either through a 1-k Ω resistor or a 100-k Ω resistor, or is left open-circuited (High-Z). 图 8-3 illustrates the output stage.

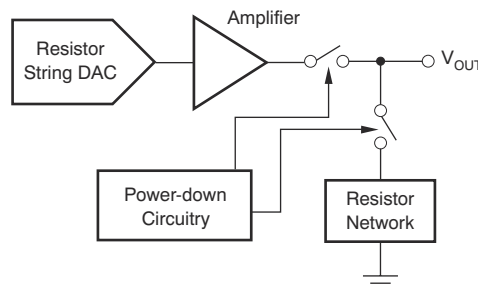


图 8-3. Output Stage During Power-Down

All linear circuitry is shut down when the power-down mode is activated. However, the contents of the DAC register are unaffected when in power-down. The time to exit power-down is typically 50 μs for $A_{V_{DD}} = 5\text{ V}$ and $A_{V_{DD}} = 3\text{ V}$.

8.5 Programming

8.5.1 Serial Interface

The DACx311 has a 3-wire serial interface ($\overline{\text{SYNC}}$, SCLK, and DIN) compatible with SPI, QSPI, and Microwire interface standards, as well as most DSPs. For an example of a typical write sequence, see [Figure 7-1](#).

8.5.1.1 Input Shift Register

The input shift register is 16 bits wide, as shown in [Table 8-2](#). The first two bits (PD0 and PD1) are reserved control bits that set the desired mode of operation (normal mode or any one of three power-down modes) as indicated in [Table 8-1](#).

The remaining data bits are either 12 (DAC7311), 10 (DAC6311), or 8 (DAC5311) data bits, followed by *don't care* bits, as shown in [Table 8-2](#), [Table 8-3](#), and [Table 8-4](#), respectively.

Table 8-2. DAC5311 8-Bit Data Input Register

DB15		DB14		DB6						DB5				DB0	
PD1	PD0	D7	D6	D5	D4	D3	D2	D1	D0	X	X	X	X	X	X

LEGEND: R/W = Read/Write; R = Read only; -n = value after reset

Table 8-3. DAC6311 10-Bit Data Input Register

DB15		DB14		DB4						DB3		DB0			
PD1	PD0	D9	D8	D7	D6	D5	D4	D3	D2	D1	D0	X	X	X	X

LEGEND: R/W = Read/Write; R = Read only; -n = value after reset

Table 8-4. DAC7311 12-Bit Data Input Register

DB15		DB14		DB2								DB1		DB0	
PD1	PD0	D11	D10	D9	D8	D7	D6	D5	D4	D3	D2	D1	D0	X	X

LEGEND: R/W = Read/Write; R = Read only; -n = value after reset

The write sequence begins by bringing the $\overline{\text{SYNC}}$ line low. Data from the DIN line are clocked into the 16-bit shift register on each falling edge of SCLK. The serial clock frequency can be as high as 50 MHz, making

the DACx311 compatible with high-speed DSPs. On the 16th falling edge of the serial clock, the last data bit is clocked in and the programmed function is executed.

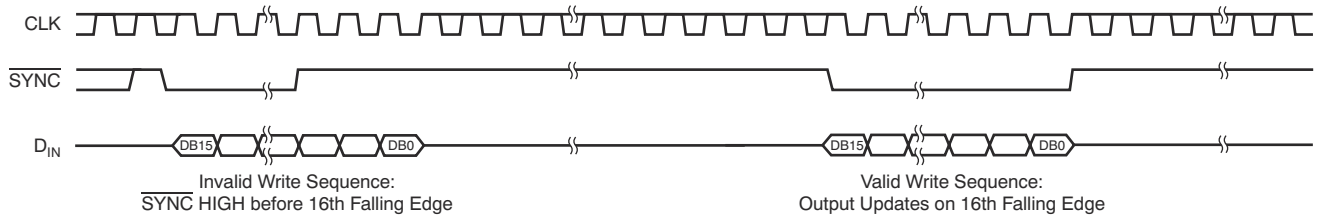
At this point, the $\overline{\text{SYNC}}$ line can be kept low or brought high. In either case, $\overline{\text{SYNC}}$ must be brought high for a minimum of 20 ns before the next write sequence so that a falling edge of $\overline{\text{SYNC}}$ can initiate the next write sequence.

8.5.1.2 $\overline{\text{SYNC}}$ Interrupt

In a normal write sequence, the $\overline{\text{SYNC}}$ line is kept low for at least 16 falling edges of SCLK and the DAC is updated on the 16th falling edge. However, bringing $\overline{\text{SYNC}}$ high before the 16th falling edge acts as an interrupt to the write sequence. The shift register is reset and the write sequence is seen as invalid. Neither an update of the DAC register contents nor a change in the operating mode occurs, as shown in [Figure 8-4](#).

DAC5311, DAC6311, DAC7311

JAJS498D – AUGUST 2008 – REVISED AUGUST 2023



8-4. DACx311 SYNC Interrupt Facility

9 Application and Implementation

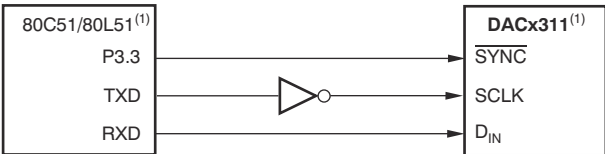
注

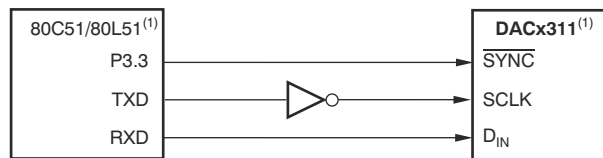
以下のアプリケーション情報は、TI の製品仕様に含まれるものではなく、TI ではその正確性または完全性を保証いたしません。個々の目的に対する製品の適合性については、お客様の責任で判断していただくこととなります。お客様は自身の設計実装を検証しテストすることで、システムの機能を確認する必要があります。

9.1 Application Information

9.1.1 Microprocessor Interfacing

9.1.1.1 DACx311 to 8051 Interface

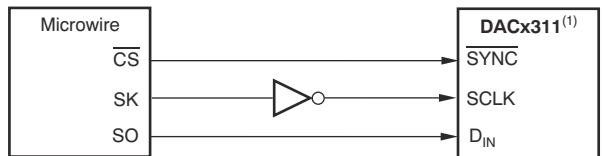

 Figure 9-1 shows a serial interface between the DACx311 and a typical 8051-type microcontroller. The setup for the interface is as follows: TXD of the 8051 drives SCLK of the DACx311, while RXD drives the serial data line of the device. The SYNC signal is derived from a bit programmable pin on the port. In this case, port line P3.3 is used. When data are to be transmitted to the DACx311, P3.3 is taken low. The 8051 transmits data only in 8-bit bytes; thus, only eight falling clock edges occur in the transmit cycle. To load data to the DAC, P3.3 remains low after the first eight bits are transmitted, and a second write cycle is initiated to transmit the second byte of data. P3.3 is taken high following the completion of this cycle. The 8051 outputs the serial data in a format that has the LSB first. The DACx311 requires data with the MSB as the first bit received. Therefore, the 8051 transmit routine must take this requirement into account, and *mirror* the data as needed.

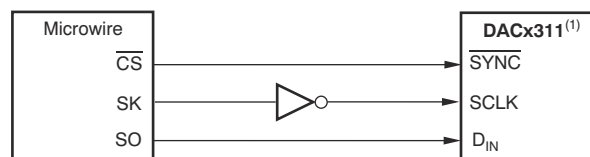


NOTE: (1) Additional pins omitted for clarity.

図 9-1. DACx311 to 80C51/80L51 Interfaces

9.1.1.2 DACx311 to Microwire Interface


 Figure 9-2 shows an interface between the DACx311 and any Microwire-compatible device. Serial data (SO) are shifted out on the falling edge of the serial clock (SK) and are clocked into the DACx311 on the rising edge of the SK signal.

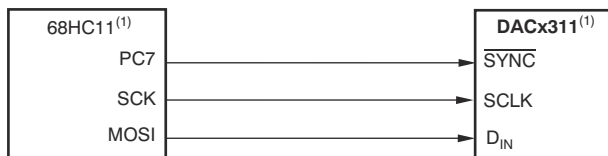


NOTE: (1) Additional pins omitted for clarity.

図 9-2. DACx311 to Microwire Interface

9.1.1.3 DACx311 to 68HC11 Interface

Figure 9-3 shows a serial interface between the DACx311 and the 68HC11 microcontroller. SCK of the 68HC11 drives the SCLK of the DACx311, while the MOSI output drives the serial data line of the DAC. The SYNC signal is derived from a port line (PC7), similar to what was done for the 8051.



NOTE: (1) Additional pins omitted for clarity.

Figure 9-3. DACx311 to 68HC11 Interface

Configure the 68HC11 so that the CPOL bit is 0 and the CPHA bit is 1. This configuration causes data appearing on the MOSI output to be valid on the falling edge of SCK. When data are being transmitted to the DAC, the SYNC line is taken low (PC7). Serial data from the 68HC11 are transmitted in 8-bit bytes with only eight falling clock edges occurring in the transmit cycle. Data are transmitted MSB first. To load data to the DACx311, PC7 is held low after the first eight bits are transferred, and a second serial write operation is performed to the DAC; PC7 is taken high at the end of this procedure.

9.2 Typical Applications

9.2.1 Loop Powered Transmitter

The described loop powered transmitter can accurately source currents from 4 mA to 20 mA.

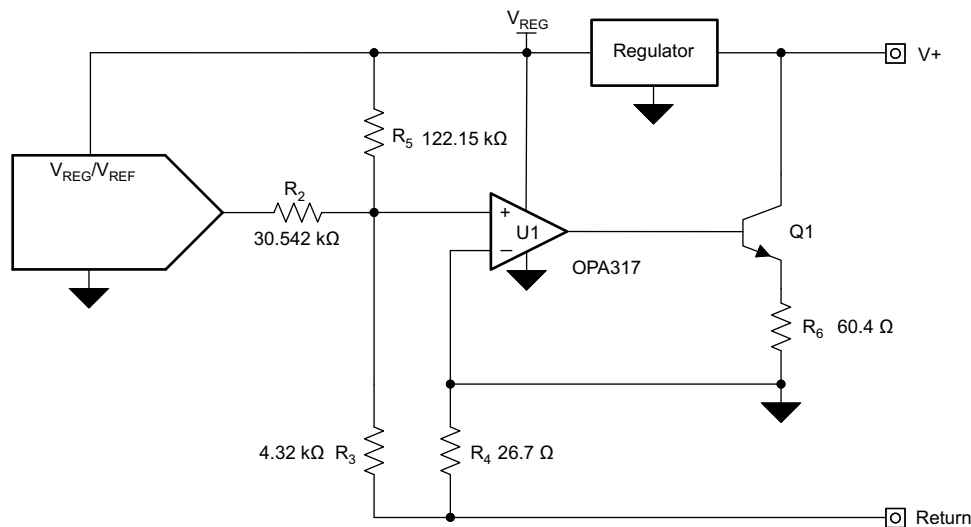


Figure 9-4. Loop Powered Transmitter Schematic

9.2.1.1 Design Requirements

The transmitter has only two external input pins; a supply connection and a ground (or return) connection. The transmitter communicates back to the host, typically a PLC analog input module, by precisely controlling the magnitude of the return current. To conform to the 4-mA to 20-mA communication standards, the complete transmitter must consume less than 4 mA of current.

The complete design of this circuit is outlined in [TIPD158, Low Cost Loop-Powered 4-20mA Transmitter EMC/EMI Tested Reference Design](#). The design is expected to be low-cost and deliver immunity to the IEC61000-4 suite of tests with minimum impact on the accuracy of the system. Reference design TIPD158 includes the design goals, simulated results, and measured performance.

9.2.1.2 Detailed Design Procedure

Amplifier U1 uses negative feedback to make sure that the potentials at the inverting (V_-) and noninverting (V_+) input terminals are equal. In this configuration, V_- is directly tied to the local GND; therefore, the potential at the noninverting input terminal is driven to local ground. Thus, the voltage difference across R_2 is the DAC output voltage (V_{OUT}), and the voltage difference across R_5 is the regulator voltage (V_{REG}). These voltage differences cause currents to flow through R_2 and R_5 , as illustrated in [Figure 9-5](#).

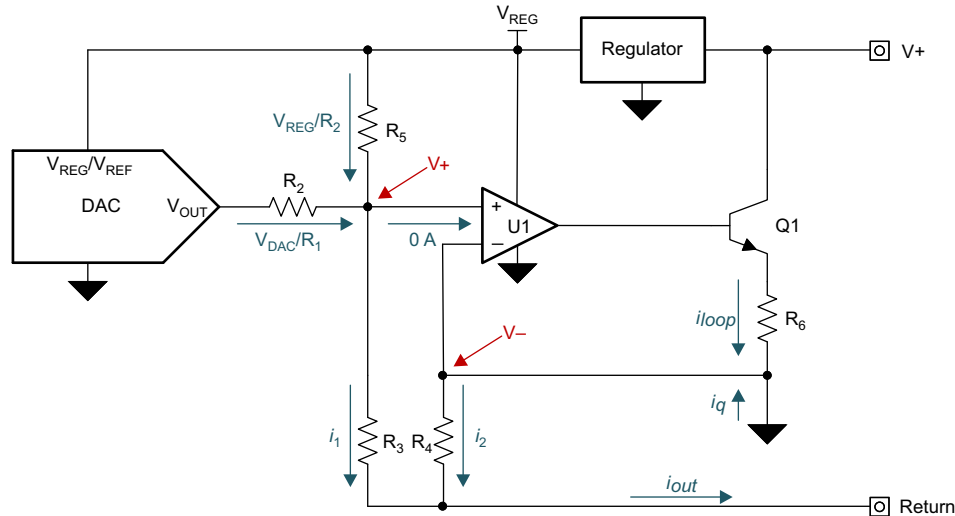


Figure 9-5. Voltage to Current Conversion

The currents from R_2 and R_5 sum into i_1 (defined in [Equation 2](#)), and i_1 flows through R_3 .

$$i_1 = \frac{V_{DAC}}{R_2} + \frac{V_{REG}}{R_5} \quad (2)$$

Amplifier U2 drives the base of Q1, the NPN bipolar junction transistor (BJT), to allow current to flow through R_4 so that the voltage drops across R_3 and R_4 remain equal. This design keeps the inverting and noninverting terminals at the same potential. A small part of the current through R_4 is sourced by the quiescent current of all of the components used in the transmitter design (regulator, amplifier, and DAC). The voltage drops across R_3 and R_4 are equal; therefore, different-sized resistors cause different current flow through each resistor. Use these different-sized resistors to apply gain to the current flow through R_4 by controlling the ratio of resistor R_3 to R_4 , as shown in [Equation 3](#):

$$\begin{aligned} V_+ &= i_1 \cdot R_3 \\ V_- &= i_2 \cdot R_4 \Rightarrow i_2 = \frac{i_1 \cdot R_3}{R_4} \\ V_+ &= V_- \end{aligned} \quad (3)$$

The current gain in the circuit helps allow a majority of the output current to come directly from the loop through Q1 instead of from the voltage-to-current converter. This current gain, in addition to the low-power components, keeps the current consumption of the voltage-to-current converter low. Currents i_1 and i_2 sum to form output current i_{out} , as shown in [Equation 4](#):

$$i_{out} = i_1 + i_2 = \frac{V_{DAC}}{R_2} + \frac{V_{REG}}{R_5} + \frac{R_3}{R_4} \cdot \left(\frac{V_{DAC}}{R_2} + \frac{V_{REG}}{R_5} \right) = \left(\frac{V_{DAC}}{R_2} + \frac{V_{REG}}{R_5} \right) \cdot \left(1 + \frac{R_3}{R_4} \right) \quad (4)$$

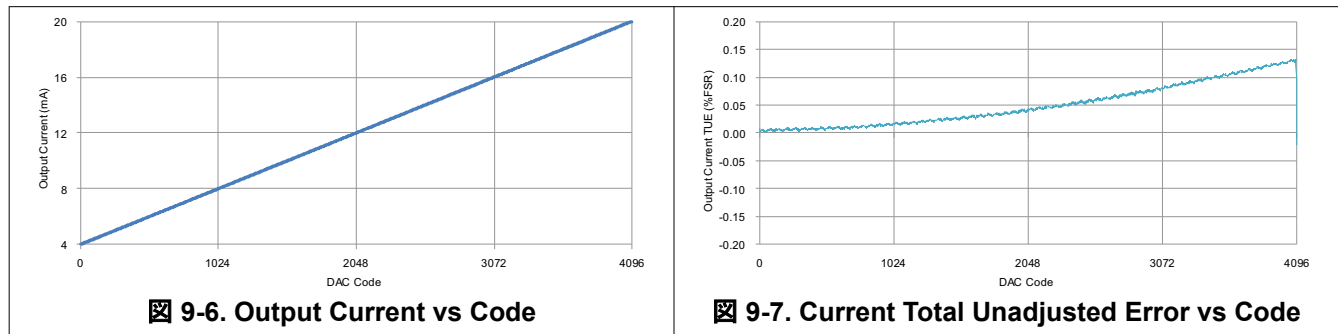
The complete transfer function, arranged as a function of input code, is shown in [Equation 5](#). The remaining sections divide this circuit into 3 blocks for simplified discussion.

$$i_{out}(\text{Code}) = \left(\frac{V_{REG} \cdot \text{Code}}{2^{\text{Resolution}} \cdot R_2} + \frac{V_{REG}}{R_5} \right) \cdot \left(1 + \frac{R_3}{R_4} \right) \quad (5)$$

Resistor R_6 is included to reduce the gain of transistor Q1, and therefore, reduce the closed-loop gain of the voltage-to-current converter for a stable design. Size resistors R_2 , R_3 , R_4 , and R_5 based on the full-scale range of the DAC, regulator voltage, and the desired current output range of the design.

9.2.1.3 Application Curves

Figure 9-6 shows the measured transfer function of the circuit. Figure 9-7 shows the total unadjusted error (TUE) of the circuit, staying below 0.15 %FSR.



9.2.2 Using the REF5050 as a Power Supply for the DACx311

As a result of the extremely low supply current required by the DACx311, an alternative option is to use a REF5050 5-V precision voltage reference to supply the required voltage to the part, as shown in Figure 9-8. This option is especially useful if the power supply is too noisy or if the system supply voltages are at some value other than 5 V. The REF5050 outputs a steady supply voltage for the DACx311. If the REF5050 is used, the current needed to supply DACx311 is typically 110 μ A at 5 V, with no load on the output of the DAC. When the DAC output is loaded, the REF5050 also needs to supply the current to the load. The total current required (with a 5 k Ω load on the DAC output) is:

$$110 \mu\text{A} + (5 \text{ V} / 5 \text{ k}\Omega) = 1.11 \text{ mA} \quad (6)$$

The load regulation of the REF5050 is typically 0.002%/mA, which results in an error of 90 μ V for the 1.1 mA current drawn from the device. This value corresponds to a 0.07 LSB error at 12 bits (DAC7311).

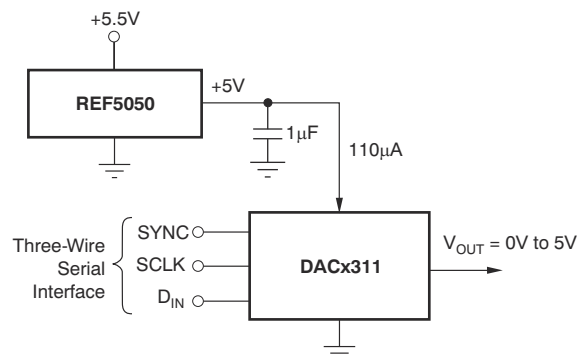


Figure 9-8. REF5050 as Power Supply to DACx311

For other power-supply voltages, alternative references such as the REF3030 (3 V), REF3033 (3.3 V), or REF3220 (2.048 V) are recommended. For a full list of available voltage references from TI, see the TI web site at www.ti.com.

9.2.3 Bipolar Operation Using the DACx311

The DACx311 has been designed for single-supply operation but a bipolar output range is also possible using the circuit in [Figure 9-9](#). The circuit shown gives an output voltage range of ± 5 V. Rail-to-rail operation at the amplifier output is achievable using an [OPA211](#), [OPA340](#), or [OPA703](#) as the output amplifier. For a full list of available operational amplifiers from TI, see the TI web site at www.ti.com

The output voltage for any input code can be calculated as follows:

$$V_O = \left[AV_{DD} \times \left(\frac{D}{2^n} \right) \times \left(\frac{R_1 + R_2}{R_1} \right) - AV_{DD} \times \left(\frac{R_2}{R_1} \right) \right] \quad (7)$$

where

- n = resolution in bits; either 8 (DAC5311), 10 (DAC6311), or 12 (DAC7311).
- D = decimal equivalent of the binary code that is loaded to the DAC register. D ranges from 0 to 255 for 8-bit DAC5311, 0 to 1023 for the 10-bit DAC6311 and 0 to 4095 for the 12-bit DAC7311.

With $AV_{DD} = 5$ V, $R_1 = R_2 = 10$ k Ω :

$$V_O = \left(\frac{10 \times D}{2^n} \right) - 5V \quad (8)$$

The resulting output voltage range is ± 5 V. Code 000h corresponds to a -5 -V output and FFFh (12-bit level) corresponding to a $+5$ -V output.

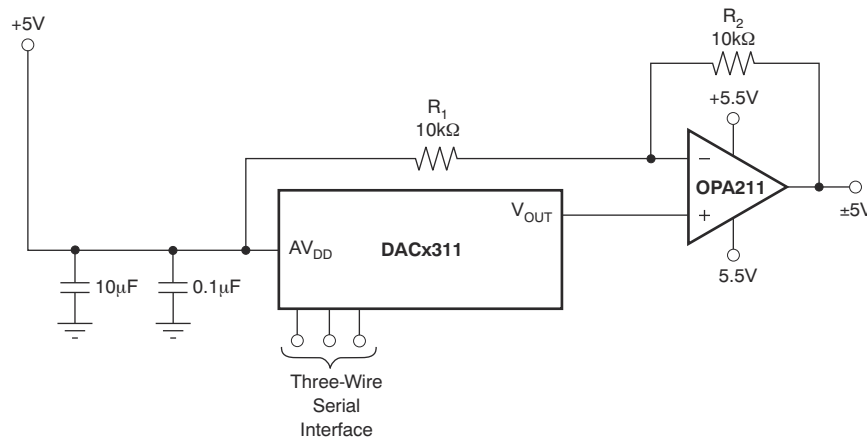


Figure 9-9. Bipolar Operation With the DACx311

9.3 Power Supply Recommendations

The DACx311 is designed to operate with a unipolar analog power supply ranging from 2.0 V to 5.5 V on the AV_{DD} pin. The AV_{DD} pin supplies power to the digital and analog circuits (including the resistor string) inside the DAC. The current consumption of this pin is specified in the [Electrical Characteristics](#) table. Use a 1 μ F to 10 μ F capacitor in parallel with a 0.1 μ F bypass capacitor on this pin to remove high-frequency noise.

9.4 Layout

9.4.1 Layout Guidelines

A precision analog component requires careful layout, adequate bypassing, and clean, well-regulated power supplies.

The DACx311 offers single-supply operation, and is often used in close proximity to digital logic, microcontrollers, microprocessors, and digital signal processors. The more digital logic present in the design and the higher the switching speed, the more difficult the task is to achieve good performance from the converter.

As a result of the single ground pin of the DACx311, all return currents, including digital and analog return currents, must flow through the GND pin. Ideally, GND is connected directly to an analog ground plane. Separate this plane from the ground connection for the digital components until connected at the power entry point of the system.

The power applied to AV_{DD} must be well-regulated and low-noise. Switching power supplies and dc/dc converters often have high-frequency glitches or spikes riding on the output voltage. In addition, digital components can create similar high-frequency spikes as the internal logic switches state. This noise can easily couple into the DAC output voltage through various paths between the power connections and analog output. This condition is particularly true for the DACx311, as the power supply is also the reference voltage for the DAC.

As with the GND connection, connect AV_{DD} to a 5-V power supply plane or trace that is separate from the connection for digital logic until connected at the power entry point. In addition, 1- μ F to 10- μ F and 0.1- μ F bypass capacitors are strongly recommended. In some situations, additional bypassing can be required, such as a 100 μ F electrolytic capacitor or even a Pi filter made up of inductors and capacitors—all designed to essentially low-pass filter the 5-V supply and remove high-frequency noise.

9.4.2 Layout Example

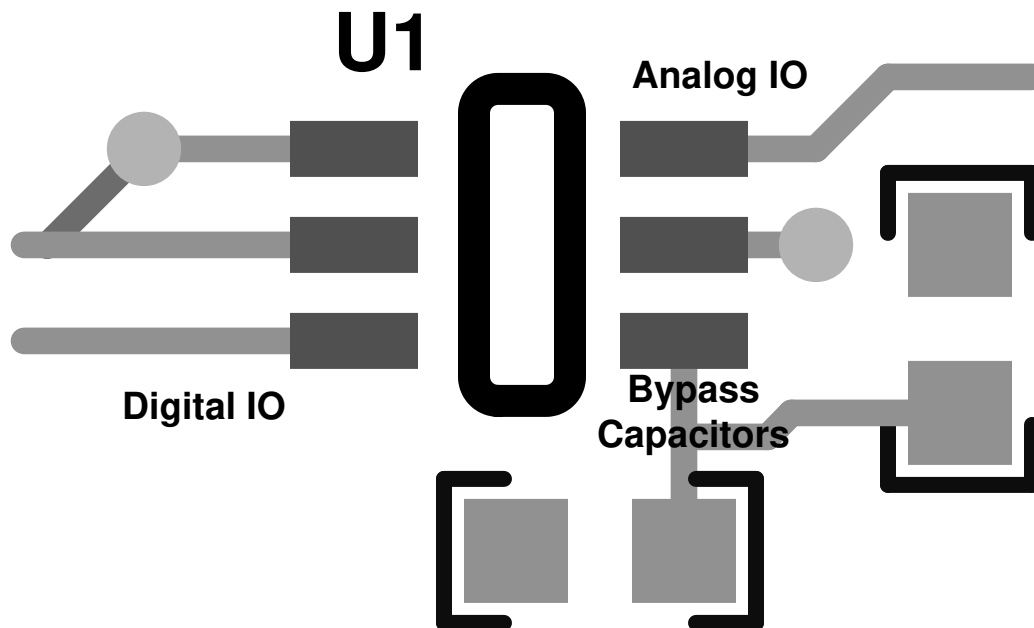


图 9-10. Recommended Layout

10 Device and Documentation Support

10.1 ドキュメントの更新通知を受け取る方法

ドキュメントの更新についての通知を受け取るには、ti.com のデバイス製品フォルダを開いてください。「更新の通知を受け取る」をクリックして登録すると、変更されたすべての製品情報に関するダイジェストを毎週受け取れます。変更の詳細については、修正されたドキュメントに含まれている改訂履歴をご覧ください。

10.2 サポート・リソース

TI E2E™ サポート・フォーラムは、エンジニアが検証済みの回答と設計に関するヒントをエキスパートから迅速かつ直接得ることができる場所です。既存の回答を検索したり、独自の質問をしたりすることで、設計に必要な支援を迅速に得ることができます。

リンクされているコンテンツは、該当する貢献者により、現状のまま提供されるものです。これらは TI の仕様を構成するものではなく、必ずしも TI の見解を反映したものではありません。TI の[使用条件](#)を参照してください。

10.3 Trademarks

TI E2E™ is a trademark of Texas Instruments.

すべての商標は、それぞれの所有者に帰属します。

10.4 静電気放電に関する注意事項



この IC は、ESD によって破損する可能性があります。テキサス・インスツルメンツは、IC を取り扱う際には常に適切な注意を払うことを推奨します。正しい取り扱いおよび設置手順に従わない場合、デバイスを破損するおそれがあります。

ESD による破損は、わずかな性能低下からデバイスの完全な故障まで多岐にわたります。精密な IC の場合、パラメータがわずかに変化するだけで公表されている仕様から外れる可能性があるため、破損が発生しやすくなっています。

10.5 用語集

[テキサス・インスツルメンツ用語集](#) この用語集には、用語や略語の一覧および定義が記載されています。

11 Mechanical, Packaging, and Orderable Information

The following pages include mechanical, packaging, and orderable information. This information is the most current data available for the designated devices. This data is subject to change without notice and revision of this document. For browser-based versions of this data sheet, refer to the left-hand navigation.

PACKAGING INFORMATION

Orderable Device	Status (1)	Package Type	Package Drawing	Pins	Package Qty	Eco Plan (2)	Lead finish/ Ball material (6)	MSL Peak Temp (3)	Op Temp (°C)	Device Marking (4/5)	Samples
DAC5311IDCKR	ACTIVE	SC70	DCK	6	3000	RoHS & Green	NIPDAU	Level-1-260C-UNLIM	-40 to 125	D53	Samples
DAC5311IDCKT	ACTIVE	SC70	DCK	6	250	RoHS & Green	NIPDAU	Level-1-260C-UNLIM	-40 to 125	D53	Samples
DAC6311IDCKR	ACTIVE	SC70	DCK	6	3000	RoHS & Green	NIPDAU	Level-1-260C-UNLIM	-40 to 125	D63	Samples
DAC6311IDCKT	ACTIVE	SC70	DCK	6	250	RoHS & Green	NIPDAU	Level-1-260C-UNLIM	-40 to 125	D63	Samples
DAC6311IDCKTG4	ACTIVE	SC70	DCK	6	250	RoHS & Green	NIPDAU	Level-1-260C-UNLIM	-40 to 125	D63	Samples
DAC7311IDCKR	ACTIVE	SC70	DCK	6	3000	RoHS & Green	NIPDAU	Level-1-260C-UNLIM	-40 to 125	D73	Samples
DAC7311IDCKT	ACTIVE	SC70	DCK	6	250	RoHS & Green	NIPDAU	Level-1-260C-UNLIM	-40 to 125	D73	Samples
DAC7311IDCKTG4	ACTIVE	SC70	DCK	6	250	RoHS & Green	NIPDAU	Level-1-260C-UNLIM	-40 to 125	D73	Samples

(1) The marketing status values are defined as follows:

ACTIVE: Product device recommended for new designs.

LIFEBUY: TI has announced that the device will be discontinued, and a lifetime-buy period is in effect.

NRND: Not recommended for new designs. Device is in production to support existing customers, but TI does not recommend using this part in a new design.

PREVIEW: Device has been announced but is not in production. Samples may or may not be available.

OBSOLETE: TI has discontinued the production of the device.

(2) **RoHS:** TI defines "RoHS" to mean semiconductor products that are compliant with the current EU RoHS requirements for all 10 RoHS substances, including the requirement that RoHS substance do not exceed 0.1% by weight in homogeneous materials. Where designed to be soldered at high temperatures, "RoHS" products are suitable for use in specified lead-free processes. TI may reference these types of products as "Pb-Free".

RoHS Exempt: TI defines "RoHS Exempt" to mean products that contain lead but are compliant with EU RoHS pursuant to a specific EU RoHS exemption.

Green: TI defines "Green" to mean the content of Chlorine (Cl) and Bromine (Br) based flame retardants meet JS709B low halogen requirements of <=1000ppm threshold. Antimony trioxide based flame retardants must also meet the <=1000ppm threshold requirement.

(3) MSL, Peak Temp. - The Moisture Sensitivity Level rating according to the JEDEC industry standard classifications, and peak solder temperature.

(4) There may be additional marking, which relates to the logo, the lot trace code information, or the environmental category on the device.

(5) Multiple Device Markings will be inside parentheses. Only one Device Marking contained in parentheses and separated by a "~" will appear on a device. If a line is indented then it is a continuation of the previous line and the two combined represent the entire Device Marking for that device.

⁽⁶⁾ Lead finish/Ball material - Orderable Devices may have multiple material finish options. Finish options are separated by a vertical ruled line. Lead finish/Ball material values may wrap to two lines if the finish value exceeds the maximum column width.

Important Information and Disclaimer:The information provided on this page represents TI's knowledge and belief as of the date that it is provided. TI bases its knowledge and belief on information provided by third parties, and makes no representation or warranty as to the accuracy of such information. Efforts are underway to better integrate information from third parties. TI has taken and continues to take reasonable steps to provide representative and accurate information but may not have conducted destructive testing or chemical analysis on incoming materials and chemicals. TI and TI suppliers consider certain information to be proprietary, and thus CAS numbers and other limited information may not be available for release.

In no event shall TI's liability arising out of such information exceed the total purchase price of the TI part(s) at issue in this document sold by TI to Customer on an annual basis.

OTHER QUALIFIED VERSIONS OF DAC5311 :

- Automotive : [DAC5311-Q1](#)

NOTE: Qualified Version Definitions:

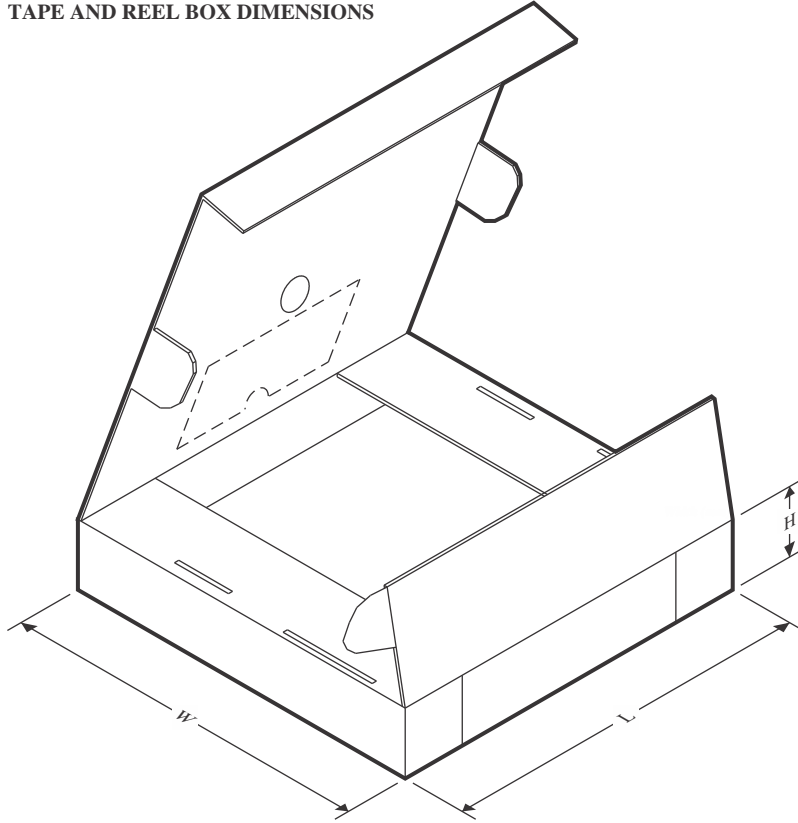
- Automotive - Q100 devices qualified for high-reliability automotive applications targeting zero defects

TAPE AND REEL INFORMATION

QUADRANT ASSIGNMENTS FOR PIN 1 ORIENTATION IN TAPE


*All dimensions are nominal

Device	Package Type	Package Drawing	Pins	SPQ	Reel Diameter (mm)	Reel Width W1 (mm)	A0 (mm)	B0 (mm)	K0 (mm)	P1 (mm)	W (mm)	Pin1 Quadrant
DAC5311IDCKR	SC70	DCK	6	3000	178.0	9.0	2.4	2.5	1.2	4.0	8.0	Q3
DAC5311IDCKT	SC70	DCK	6	250	178.0	9.0	2.4	2.5	1.2	4.0	8.0	Q3
DAC6311IDCKR	SC70	DCK	6	3000	178.0	9.0	2.4	2.5	1.2	4.0	8.0	Q3
DAC6311IDCKT	SC70	DCK	6	250	178.0	9.0	2.4	2.5	1.2	4.0	8.0	Q3
DAC7311IDCKR	SC70	DCK	6	3000	178.0	9.0	2.4	2.5	1.2	4.0	8.0	Q3
DAC7311IDCKT	SC70	DCK	6	250	178.0	9.0	2.4	2.5	1.2	4.0	8.0	Q3

TAPE AND REEL BOX DIMENSIONS


*All dimensions are nominal

Device	Package Type	Package Drawing	Pins	SPQ	Length (mm)	Width (mm)	Height (mm)
DAC5311IDCKR	SC70	DCK	6	3000	180.0	180.0	18.0
DAC5311IDCKT	SC70	DCK	6	250	180.0	180.0	18.0
DAC6311IDCKR	SC70	DCK	6	3000	180.0	180.0	18.0
DAC6311IDCKT	SC70	DCK	6	250	180.0	180.0	18.0
DAC7311IDCKR	SC70	DCK	6	3000	180.0	180.0	18.0
DAC7311IDCKT	SC70	DCK	6	250	180.0	180.0	18.0

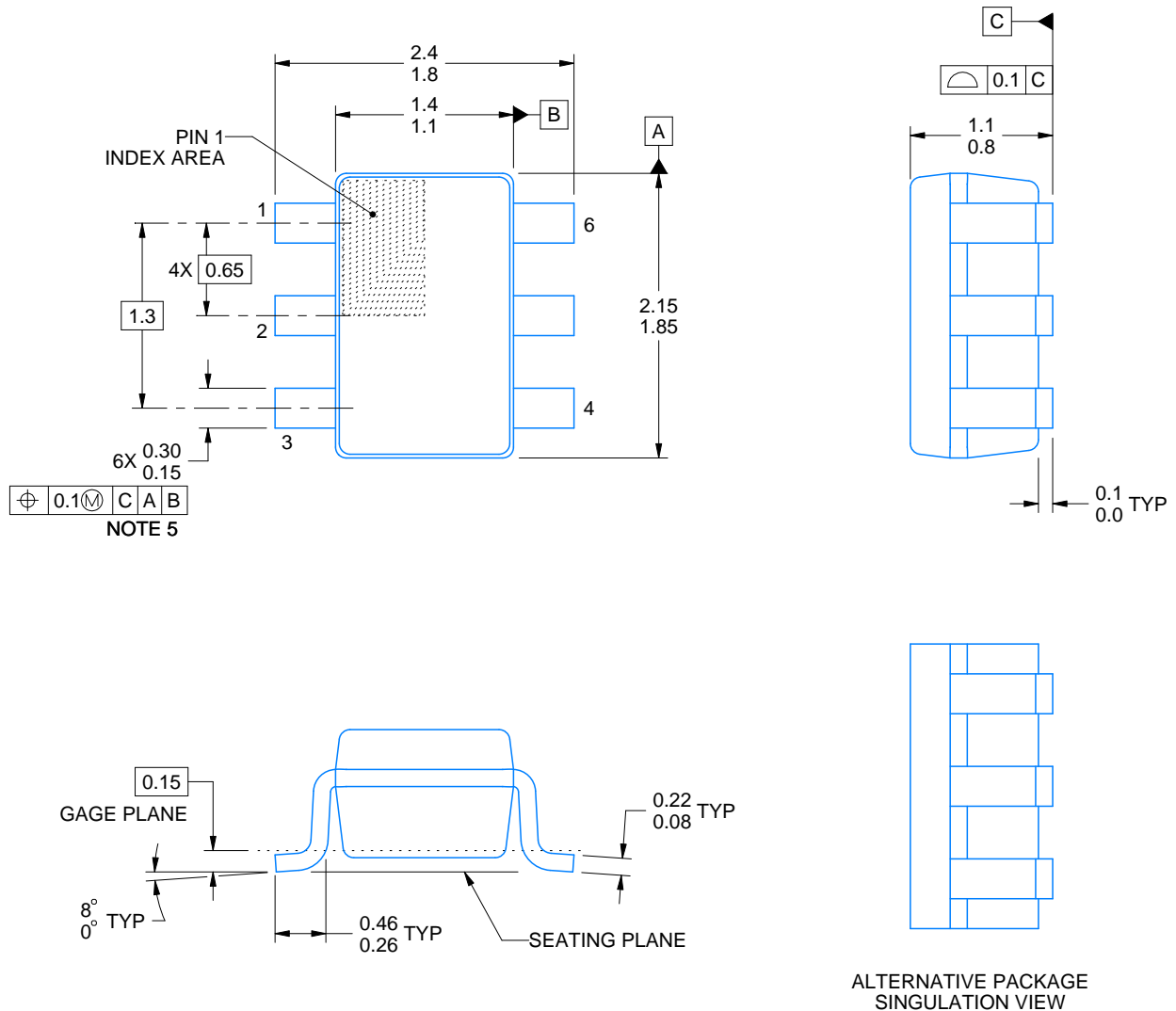
DCK0006A



PACKAGE OUTLINE

SOT - 1.1 max height

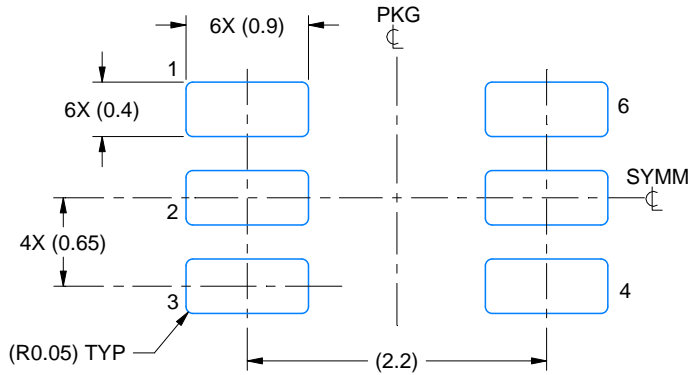
SMALL OUTLINE TRANSISTOR



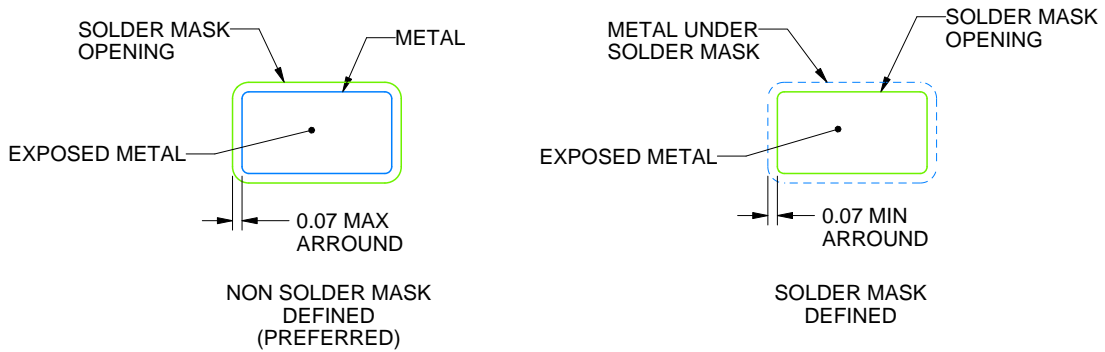
4214835/B 04/2024

NOTES:

1. All linear dimensions are in millimeters. Any dimensions in parenthesis are for reference only. Dimensioning and tolerancing per ASME Y14.5M.
2. This drawing is subject to change without notice.
3. Body dimensions do not include mold flash or protrusion. Mold flash and protrusion shall not exceed 0.15 per side.
4. Falls within JEDEC MO-203 variation AB.



LAND PATTERN EXAMPLE
EXPOSED METAL SHOWN
SCALE:18X



SOLDER MASK DETAILS

4214835/B 04/2024

NOTES: (continued)

- 5. Publication IPC-7351 may have alternate designs.
- 6. Solder mask tolerances between and around signal pads can vary based on board fabrication site.



SOLDER PASTE EXAMPLE
BASED ON 0.125 THICK STENCIL
SCALE:18X

4214835/B 04/2024

NOTES: (continued)

7. Laser cutting apertures with trapezoidal walls and rounded corners may offer better paste release. IPC-7525 may have alternate design recommendations.
8. Board assembly site may have different recommendations for stencil design.

重要なお知らせと免責事項

TI は、技術データと信頼性データ (データシートを含みます)、設計リソース (リファレンス・デザインを含みます)、アプリケーションや設計に関する各種アドバイス、Web ツール、安全性情報、その他のリソースを、欠陥が存在する可能性のある「現状のまま」提供しており、商品性および特定目的に対する適合性の黙示保証、第三者の知的財産権の非侵害保証を含むいかなる保証も、明示的または黙示的にかかわらず拒否します。

これらのリソースは、TI 製品を使用する設計の経験を積んだ開発者への提供を意図したものです。(1) お客様のアプリケーションに適した TI 製品の選定、(2) お客様のアプリケーションの設計、検証、試験、(3) お客様のアプリケーションに該当する各種規格や、その他のあらゆる安全性、セキュリティ、規制、または他の要件への確実な適合に関する責任を、お客様のみが単独で負うものとし、

上記の各種リソースは、予告なく変更される可能性があります。これらのリソースは、リソースで説明されている TI 製品を使用するアプリケーションの開発の目的でのみ、TI はその使用をお客様に許諾します。これらのリソースに関して、他の目的で複製することや掲載することは禁止されています。TI や第三者の知的財産権のライセンスが付与されている訳ではありません。お客様は、これらのリソースを自身で使用した結果発生するあらゆる申し立て、損害、費用、損失、責任について、TI およびその代理人を完全に補償するものとし、TI は一切の責任を拒否します。

TI の製品は、[TI の販売条件](#)、または [ti.com](#) やかかる TI 製品の関連資料などのいずれかを通じて提供する適用可能な条項の下で提供されています。TI がこれらのリソースを提供することは、適用される TI の保証または他の保証の放棄の拡大や変更を意味するものではありません。

お客様がいかなる追加条項または代替条項を提案した場合でも、TI はそれらに異議を唱え、拒否します。

郵送先住所 : Texas Instruments, Post Office Box 655303, Dallas, Texas 75265
Copyright © 2024, Texas Instruments Incorporated