

LMH6640 TFT-LCD Single, 16V Rail-to-Rail High Output Operational Amplifier

Check for Samples: [LMH6640](#)

FEATURES

- ($V_S = 16V$, $R_L = 2\text{ k}\Omega$ to $V^+/2$, 25°C , Typical Values Unless Specified)
- Supply current (no load) 4 mA
- Output resistance (closed loop 1 MHz) 0.35 Ω
- -3 dB BW ($A_V = 1$) 190 MHz
- Settling time ($\pm 0.1\%$, $2 V_{PP}$) 35 ns
- Input common mode voltage -0.3V to 15.1V
- Output voltage swing 100 mV from rails
- Linear output current ± 100 mA
- Total harmonic distortion ($2 V_{PP}$, 5 MHz) -64 dBc
- Fully characterized for: 5V & 16V
- No output phase reversal with CMVR exceeded
- Differential gain ($R_L = 150\Omega$) 0.12%
- Differential phase ($R_L = 150\Omega$) 0.12°

APPLICATIONS

- TFT panel V_{COM} buffer amplifier
- Active filters
- CD/DVD ROM
- ADC buffer amplifier
- Portable video
- Current sense buffer

DESCRIPTION

The LMH™6640 is a voltage feedback operational amplifier with a rail-to-rail output drive capability of 100 mA. Employing TI's patented VIP10 process, the LMH6640 delivers a bandwidth of 190 MHz at a current consumption of only 4mA. An input common mode voltage range extending to 0.3V below the V^- and to within 0.9V of V^+ , makes the LMH6640 a true single supply op-amp. The output voltage range extends to within 100 mV of either supply rail providing the user with a dynamic range that is especially desirable in low voltage applications.

The LMH6640 offers a slew rate of 170 V/ μ s resulting in a full power bandwidth of approximately 28 MHz with 5V single supply ($2 V_{PP}$, -1 dB). Careful attention has been paid to ensure device stability under all operating voltages and modes. The result is a very well behaved frequency response characteristic for any gain setting including +1, and excellent specifications for driving video cables including total harmonic distortion of -64 dBc @ 5 MHz, differential gain of 0.12% and differential phase of 0.12°.

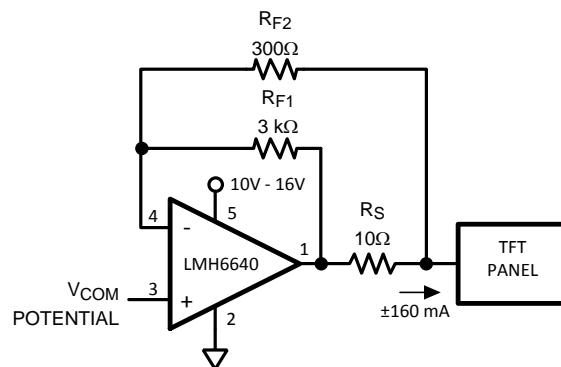

Figure 1. Typical Application as a TFT Panel V_{COM} Driver



Please be aware that an important notice concerning availability, standard warranty, and use in critical applications of Texas Instruments semiconductor products and disclaimers thereto appears at the end of this data sheet.

LMH is a trademark of Texas Instruments.

All other trademarks are the property of their respective owners.



These devices have limited built-in ESD protection. The leads should be shorted together or the device placed in conductive foam during storage or handling to prevent electrostatic damage to the MOS gates.

Absolute Maximum Ratings ⁽¹⁾

ESD Tolerance ⁽²⁾	
Human Body Model	2 KV
Machine Model	200V
V _{IN} Differential	±2.5V
Input Current	±10 mA
Supply Voltages (V ⁺ – V ⁻)	18V
Voltage at Input/Output Pins	V ⁺ +0.8V, V ⁻ -0.8V
Storage Temperature Range	-65°C to +150°C
Junction Temperature ⁽³⁾	+150°C
Soldering Information	
Infrared or Convection (20 sec.)	235°C
Wave Soldering (10 sec.)	260°C

- (1) Absolute maximum Ratings indicate limits beyond which damage to the device may occur. Operating Ratings indicate conditions for which the device is intended to be functional, but specific performance is not ensured. For specifications and the test conditions, see the Electrical Characteristics.
- (2) Human body model, 1.5 kΩ in series with 100 pF. Machine Model, 0Ω in series with 200 pF.
- (3) The maximum power dissipation is a function of T_{J(MAX)}, θ_{JA}, and T_A. The maximum allowable power dissipation at any ambient temperature is P_D = (T_{J(MAX)} - T_A) / θ_{JA}. All numbers apply for packages soldered directly onto a PC board.

Operating Ratings ⁽¹⁾

Supply Voltage (V ⁺ – V ⁻)	4.5V to 16V
Operating Temperature Range ⁽²⁾	-40°C to +85°C
Package Thermal Resistance ⁽²⁾	
5-Pin SOT-23	265°C/W

- (1) Applies to both single-supply and split-supply operation. Continuous short circuit operation at elevated ambient temperature can result in exceeding the maximum allowed junction temperature of 150 °C Short circuit test is a momentary test. Output short circuit duration is infinite for V_S < 6V at room temperature and below. For V_S > 6V, allowable short circuit duration is 1.5 ms.
- (2) The maximum power dissipation is a function of T_{J(MAX)}, θ_{JA}, and T_A. The maximum allowable power dissipation at any ambient temperature is P_D = (T_{J(MAX)} - T_A) / θ_{JA}. All numbers apply for packages soldered directly onto a PC board.

5V Electrical Characteristics

Unless otherwise specified, All limits specified for $T_J = 25^\circ\text{C}$, $V^+ = 5\text{V}$, $V^- = 0\text{V}$, $V_O = V_{\text{CM}} = V^+/2$ and $R_L = 2\text{ k}\Omega$ to $V^+/2$.

Boldface limits apply at temperature extremes. ⁽¹⁾

Symbol	Parameter	Conditions	Min ⁽²⁾	Typ ⁽³⁾	Max ⁽²⁾	Units
BW	-3 dB Bandwidth	$A_V = +1$ ($R_L = 100\Omega$)		150		MHz
		$A_V = -1$ ($R_L = 100\Omega$)		58		
$BW_{0.1\text{ dB}}$	0.1 dB Gain Flatness	$A_V = -3$		18		MHz
FPBW	Full Power Bandwidth	$A_V = +1$, $V_{\text{OUT}} = 2 V_{\text{PP}}$, -1 dB		28		MHz
LSBW	-3 dB Bandwidth	$A_V = +1$, $V_O = 2 V_{\text{PP}}$ ($R_L = 100\Omega$)		32		MHz
GBW	Gain Bandwidth Product	$A_V = +1$, ($R_L = 100\Omega$)		59		MHz
SR	Slew Rate ⁽⁴⁾	$A_V = -1$		170		V/ μs
e_n	Input Referred Voltage Noise		f = 10 kHz	23		nV/ $\sqrt{\text{Hz}}$
			f = 1 MHz	15		
i_n	Input Referred Current Noise		f = 10 kHz	1.1		pA/ $\sqrt{\text{Hz}}$
			f = 1 MHz	0.7		
THD	Total Harmonic Distortion	f = 5 MHz, $V_O = 2 V_{\text{PP}}$, $A_V = +2$ $R_L = 1\text{ k}\Omega$ to $V^+/2$		-65		dBc
t_s	Settling Time	$V_O = 2 V_{\text{PP}}$, $\pm 0.1\%$, $A_V = -1$		35		ns
V_{OS}	Input Offset Voltage			1	5 7	mV
I_B	Input Bias Current ⁽⁵⁾			-1.2	-2.6 -3.25	μA
I_{OS}	Input Offset Current			34	800 1400	nA
CMVR	Common Mode Input Voltage Range	CMRR $\geq 50\text{ dB}$		-0.3	-0.2 -0.1	V
			4.0 3.6	4.1		
CMRR	Common Mode Rejection Ratio	$V^- \leq V_{\text{CM}} \leq V^+ - 1.5\text{V}$	72	90		dB
A_{VOL}	Large Signal Voltage Gain	$V_O = 4 V_{\text{PP}}$, $R_L = 2\text{ k}\Omega$ to $V^+/2$	86 82	95		dB
		$V_O = 3.75 V_{\text{PP}}$, $R_L = 150\Omega$ to $V^+/2$	74 70	78		
V_O	Output Swing High	$R_L = 2\text{ k}\Omega$ to $V^+/2$	4.90	4.94		V
		$R_L = 150\Omega$ to $V^+/2$	4.75	4.80		
	Output Swing Low	$R_L = 2\text{ k}\Omega$ to $V^+/2$		0.06	0.10	
		$R_L = 150\Omega$ to $V^+/2$		0.20	0.25	
I_{SC}	Output Short Circuit Current ⁽⁶⁾	Sourcing to $V^+/2$	100 75	130		mA
		Sinking from $V^+/2$	100 70	130		
I_{OUT}	Output Current	$V_O = 0.5\text{V}$ from either Supply		+75/-90		mA
PSRR	Power Supply Rejection Ratio	$4\text{V} \leq V^+ \leq 6\text{V}$	72	80		dB
I_S	Supply Current	No Load		3.7	5.5 8.0	mA
R_{IN}	Common Mode Input Resistance	$A_V = +1$, f = 1 kHz, $R_S = 1\text{ M}\Omega$		15		$\text{M}\Omega$

(1) Electrical Table values apply only for factory testing conditions at the temperature indicated. Factory testing conditions result in very limited self-heating of the device such that $T_J = T_A$. Parametric performance is indicated in the electrical tables under conditions of internal self-heating where $T_J > T_A$.

(2) All limits are specified by testing or statistical analysis.

(3) Typical Values represent the most likely parametric norm.

(4) Slew rate is the average of the rising and falling slew rates

(5) Positive current corresponds to current flowing into the device.

(6) Applies to both single-supply and split-supply operation. Continuous short circuit operation at elevated ambient temperature can result in exceeding the maximum allowed junction temperature of 150°C . Short circuit test is a momentary test. Output short circuit duration is infinite for $V_S < 6\text{V}$ at room temperature and below. For $V_S > 6\text{V}$, allowable short circuit duration is 1.5 ms.

5V Electrical Characteristics (continued)

Unless otherwise specified, All limits specified for $T_J = 25^\circ\text{C}$, $V^+ = 5\text{V}$, $V^- = 0\text{V}$, $V_O = V_{\text{CM}} = V^+/2$ and $R_L = 2\text{ k}\Omega$ to $V^+/2$.

Boldface limits apply at temperature extremes. ⁽¹⁾

Symbol	Parameter	Conditions	Min ⁽²⁾	Typ ⁽³⁾	Max ⁽²⁾	Units
C_{IN}	Common Mode Input Capacitance	$A_V = +1$, $R_S = 100\text{ k}\Omega$		1.7		pF
R_{OUT}	Output Resistance Closed Loop	$R_F = 10\text{ k}\Omega$, $f = 1\text{ kHz}$, $A_V = -1$		0.1		Ω
		$R_F = 10\text{ k}\Omega$, $f = 1\text{ MHz}$, $A_V = -1$		0.4		
DG	Differential Gain	NTSC, $A_V = +2$ $R_L = 150\Omega$ to $V^+/2$		0.13		%
DP	Differential Phase	NTSC, $A_V = +2$ $R_L = 150\Omega$ to $V^+/2$		0.10		deg

16V Electrical Characteristics

Unless otherwise specified, All limits specified for $T_J = 25^\circ\text{C}$, $V^+ = 16\text{V}$, $V^- = 0\text{V}$, $V_O = V_{CM} = V^+/2$ and $R_L = 2\text{ k}\Omega$ to $V^+/2$.

Boldface limits apply at temperature extremes. ⁽¹⁾

Symbol	Parameter	Conditions	Min ⁽²⁾	Typ ⁽³⁾	Max ⁽²⁾	Units
BW	-3 dB Bandwidth	$A_V = +1$ ($R_L = 100\Omega$)		190		MHz
		$A_V = -1$ ($R_L = 100\Omega$)		60		
BW _{0.1 dB}	0.1 dB Gain Flatness	$A_V = -2.7$		20		MHz
LSBW	-3 dB Bandwidth	$A_V = +1$, $V_O = 2 V_{PP}$ ($R_L = 100\Omega$)		35		MHz
GBW	Gain Bandwidth Product	$A_V = +1$, ($R_L = 100\Omega$)		62		MHz
SR	Slew Rate ⁽⁴⁾	$A_V = -1$		170		V/ μs
e_n	Input Referred Voltage Noise		f = 10 kHz	23		nV/ $\sqrt{\text{Hz}}$
			f = 1 MHz	15		
i_n	Input Referred Current Noise		f = 10 kHz	1.1		pA/ $\sqrt{\text{Hz}}$
			f = 1 MHz	0.7		
THD	Total Harmonic Distortion	f = 5 MHz, $V_O = 2 V_{PP}$, $A_V = +2$ $R_L = 1\text{ k}\Omega$ to $V^+/2$		-64		dBc
t_s	Settling Time	$V_O = 2 V_{PP}$, $\pm 0.1\%$, $A_V = -1$		35		ns
V_{OS}	Input Offset Voltage			1	5 7	mV
I_B	Input Bias Current ⁽⁵⁾			-1	-2.6 -3.5	μA
I_{OS}	Input Offset Current			34	800 1800	nA
CMVR	Common Mode Input Voltage Range	CMRR ≥ 50 dB		-0.3	-0.2 -0.1	V
			15.0 14.6	15.1		
CMRR	Common Mode Rejection Ratio	$V^- \leq V_{CM} \leq V^+ - 1.5\text{V}$	72	90		dB
A_{VOL}	Large Signal Voltage Gain	$V_O = 15 V_{PP}$, $R_L = 2\text{ k}\Omega$ to $V^+/2$	86 82	95		dB
		$V_O = 14 V_{PP}$, $R_L = 150\Omega$ to $V^+/2$	74 70	78		
V_O	Output Swing High	$R_L = 2\text{ k}\Omega$ to $V^+/2$	15.85	15.90		V
		$R_L = 150\Omega$ to $V^+/2$	15.45	15.78		
	Output Swing Low	$R_L = 2\text{ k}\Omega$ to $V^+/2$		0.10	0.15	
		$R_L = 150\Omega$ to $V^+/2$		0.21	0.55	
I_{SC}	Output Short Circuit Current ⁽⁶⁾	Sourcing to $V^+/2$	60 30	95		mA
		Sinking from $V^+/2$	50 15	75		
I_{OUT}	Output Current	$V_O = 0.5\text{V}$ from either Supply		± 100		mA
PSRR	Power Supply Rejection Ratio	$15\text{V} \leq V^+ \leq 17\text{V}$	72	80		dB
I_S	Supply Current	No Load		4	6.5 7.8	mA
R_{IN}	Common Mode Input Resistance	$A_V = +1$, f = 1 kHz, $R_S = 1\text{ M}\Omega$		32		M Ω
C_{IN}	Common Mode Input Capacitance	$A_V = +1$, $R_S = 100\text{ k}\Omega$		1.7		pF

(1) Electrical Table values apply only for factory testing conditions at the temperature indicated. Factory testing conditions result in very limited self-heating of the device such that $T_J = T_A$. Parametric performance is indicated in the electrical tables under conditions of internal self-heating where $T_J > T_A$.

(2) All limits are specified by testing or statistical analysis.

(3) Typical Values represent the most likely parametric norm.

(4) Slew rate is the average of the rising and falling slew rates

(5) Positive current corresponds to current flowing into the device.

(6) Applies to both single-supply and split-supply operation. Continuous short circuit operation at elevated ambient temperature can result in exceeding the maximum allowed junction temperature of 150°C . Short circuit test is a momentary test. Output short circuit duration is infinite for $V_S < 6\text{V}$ at room temperature and below. For $V_S > 6\text{V}$, allowable short circuit duration is 1.5 ms.

16V Electrical Characteristics (continued)

Unless otherwise specified, All limits specified for $T_J = 25^\circ\text{C}$, $V^+ = 16\text{V}$, $V^- = 0\text{V}$, $V_O = V_{CM} = V^+/2$ and $R_L = 2\text{ k}\Omega$ to $V^+/2$.

Boldface limits apply at temperature extremes. ⁽¹⁾

Symbol	Parameter	Conditions	Min ⁽²⁾	Typ ⁽³⁾	Max ⁽²⁾	Units
R _{OUT}	Output Resistance Closed Loop	$R_F = 10\text{ k}\Omega$, $f = 1\text{ kHz}$, $A_V = -1$		0.1		Ω
		$R_F = 10\text{ k}\Omega$, $f = 1\text{ MHz}$, $A_V = -1$		0.3		
DG	Differential Gain	NTSC, $A_V = +2$ $R_L = 150\Omega$ to $V^+/2$		0.12		%
DP	Differential Phase	NTSC, $A_V = +2$ $R_L = 150\Omega$ to $V^+/2$		0.12		deg

CONNECTION DIAGRAM

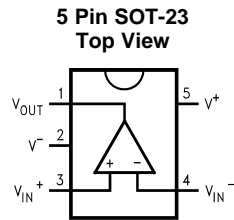

See Package Number DBV0005A

Typical Performance Characteristics

At $T_J = 25^\circ\text{C}$, $V^+ = 16\text{ V}$, $V^- = 0\text{ V}$, $R_F = 330\Omega$ for $A_V = +2$, $R_F = 1\text{ k}\Omega$ for $A_V = -1$. R_L tied to $V^+/2$. Unless otherwise specified.

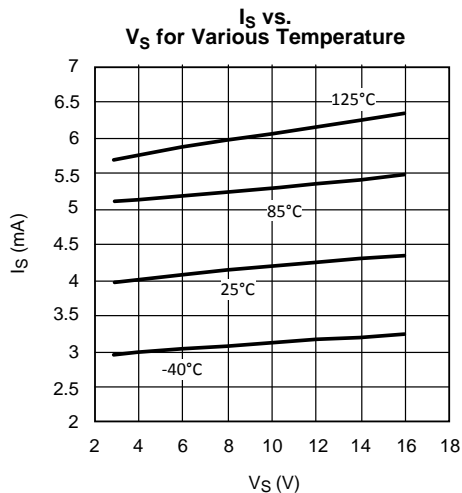

Figure 2.

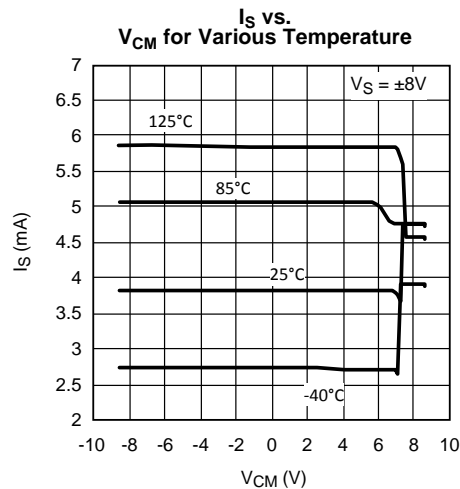

Figure 3.

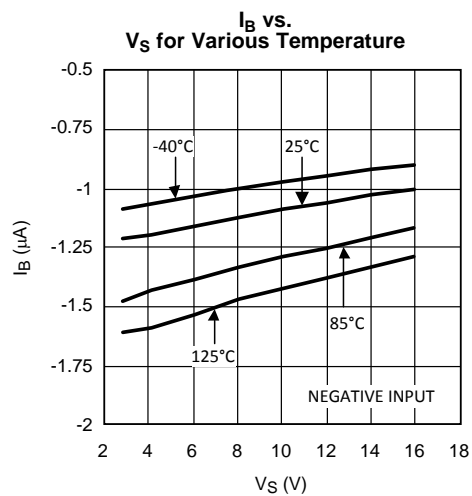

Figure 4.

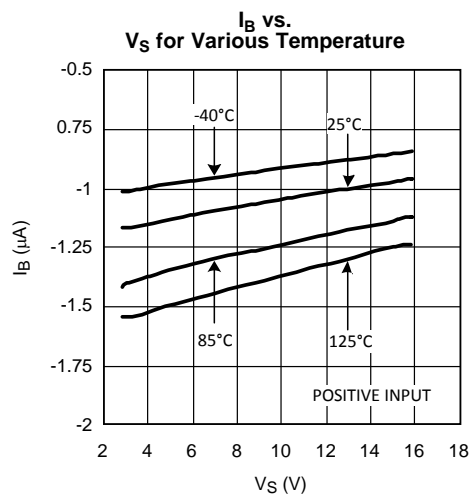

Figure 5.

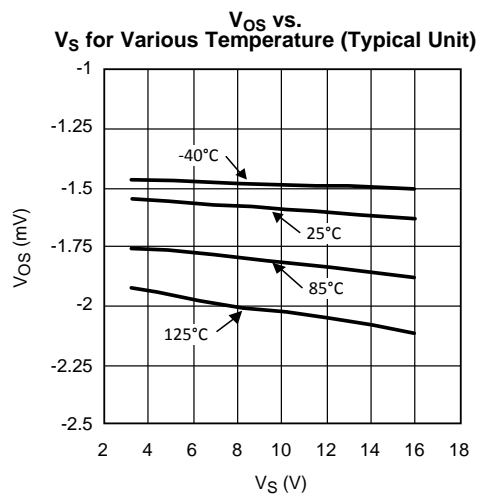

Figure 6.

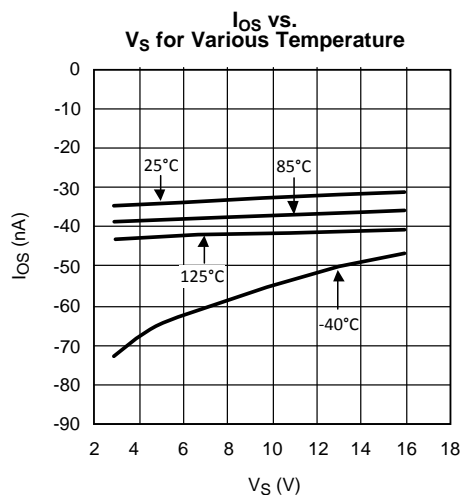

Figure 7.

Typical Performance Characteristics (continued)

At $T_J = 25^\circ\text{C}$, $V^+ = 16\text{ V}$, $V^- = 0\text{ V}$, $R_F = 330\Omega$ for $A_V = +2$, $R_F = 1\text{ k}\Omega$ for $A_V = -1$. R_L tied to $V^+/2$. Unless otherwise specified.

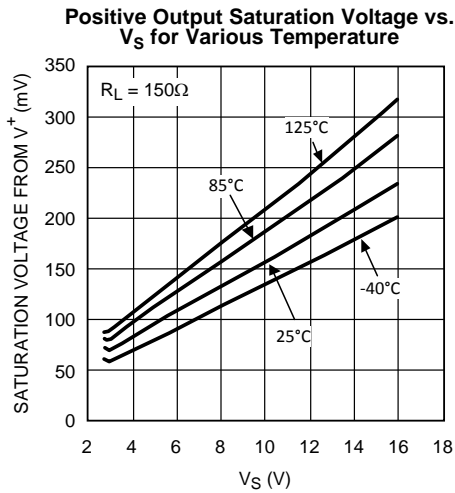

Figure 8.

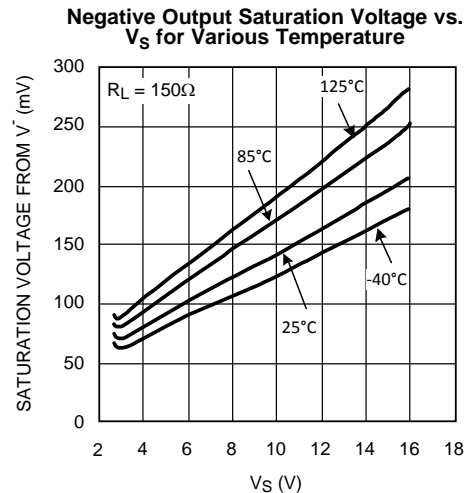

Figure 9.

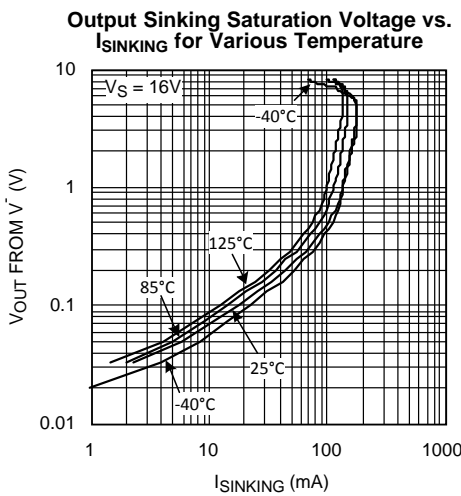

Figure 10.

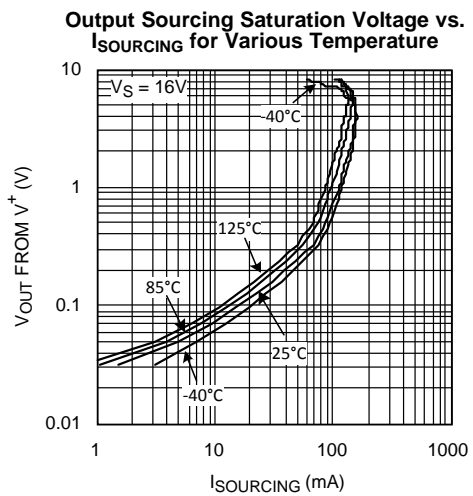

Figure 11.

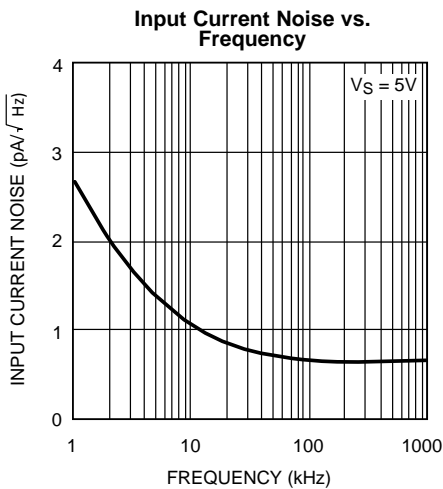

Figure 12.

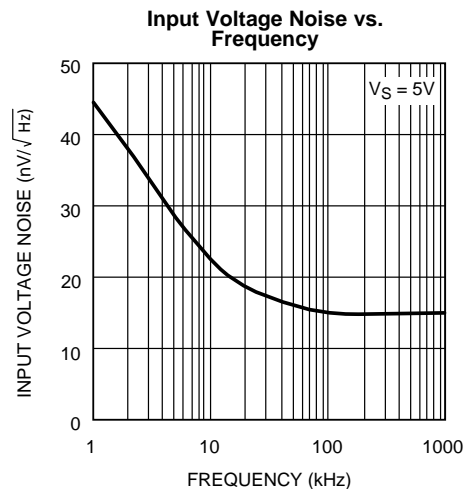

Figure 13.

Typical Performance Characteristics (continued)

At $T_J = 25^\circ\text{C}$, $V^+ = 16\text{ V}$, $V^- = 0\text{ V}$, $R_F = 330\Omega$ for $A_V = +2$, $R_F = 1\text{ k}\Omega$ for $A_V = -1$. R_L tied to $V^+/2$. Unless otherwise specified.

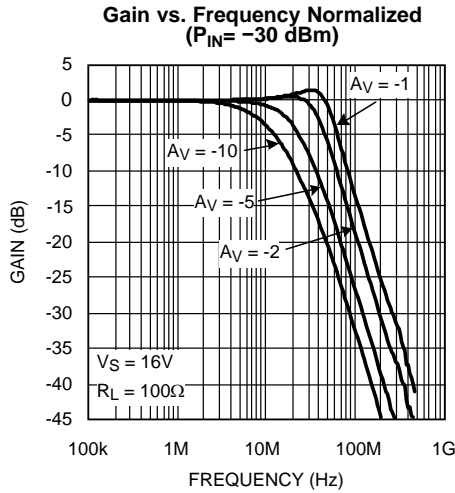

Figure 14.

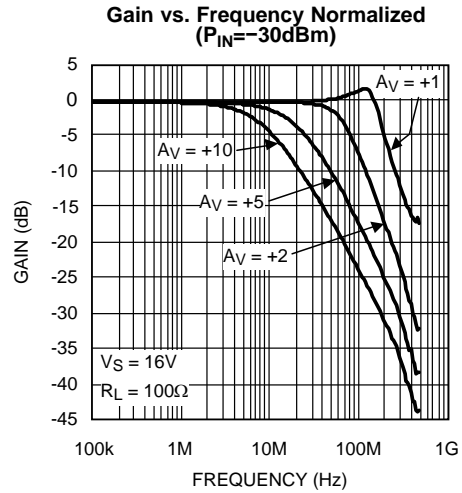

Figure 15.

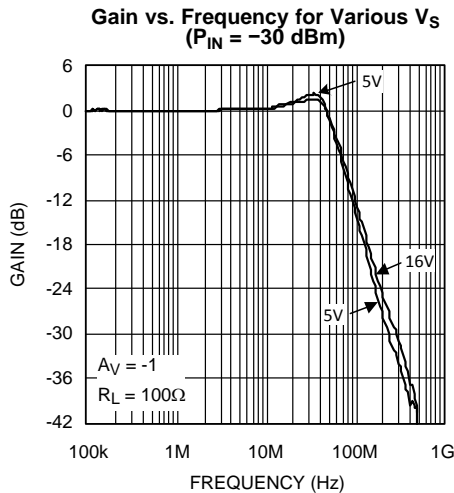

Figure 16.

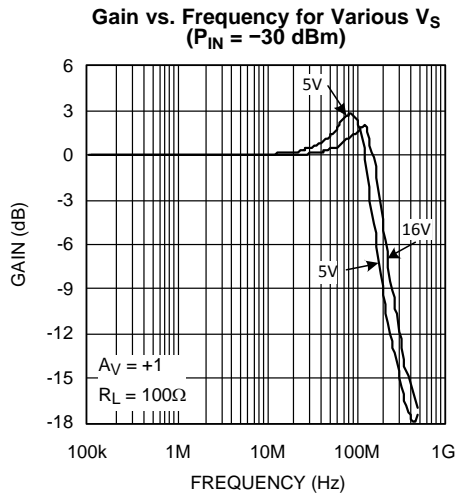

Figure 17.

Open Loop Gain & Phase vs. Frequency for Various Temperature

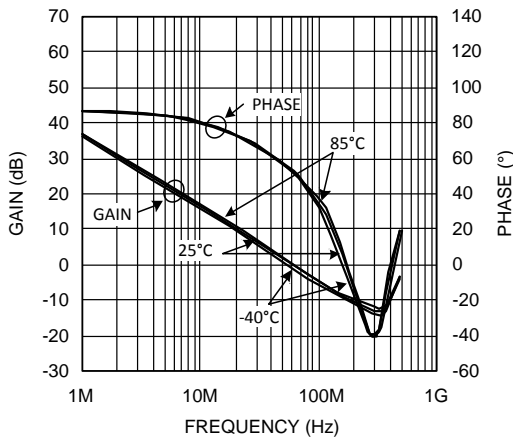

Figure 18.

Relative Gain vs. Frequency for Various Temperature

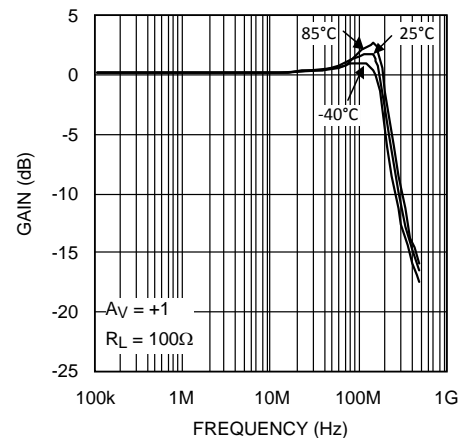

Figure 19.

Typical Performance Characteristics (continued)

At $T_J = 25^\circ\text{C}$, $V^+ = 16\text{ V}$, $V^- = 0\text{ V}$, $R_F = 330\Omega$ for $A_V = +2$, $R_F = 1\text{ k}\Omega$ for $A_V = -1$. R_L tied to $V^+/2$. Unless otherwise specified.

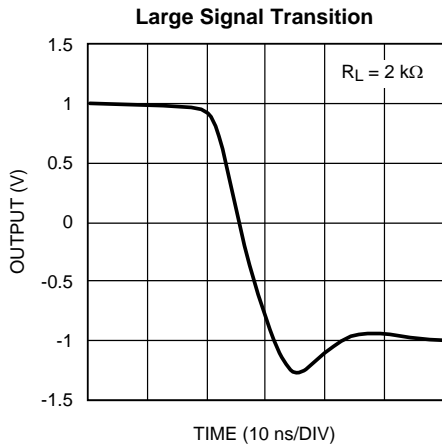

Figure 20.

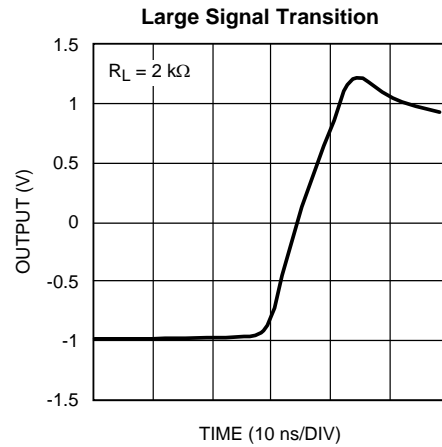

Figure 21.

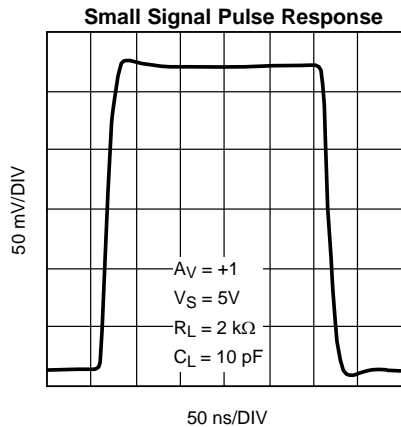

Figure 22.

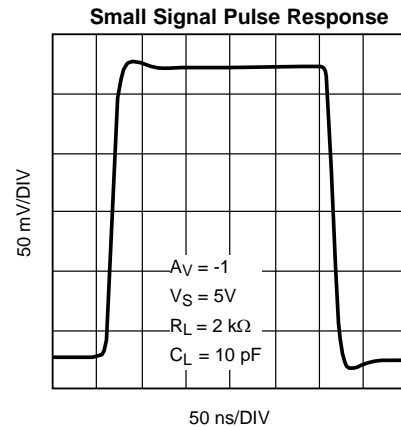

Figure 23.

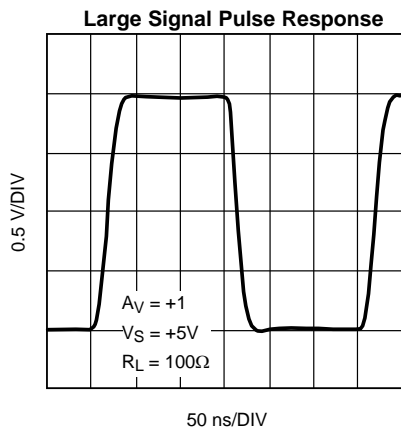

Figure 24.

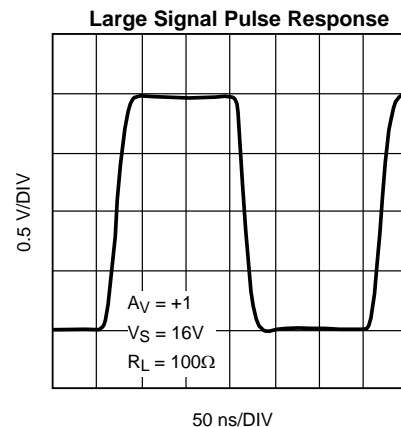

Figure 25.

Typical Performance Characteristics (continued)

At $T_J = 25^\circ\text{C}$, $V^+ = 16\text{ V}$, $V^- = 0\text{ V}$, $R_F = 330\Omega$ for $A_V = +2$, $R_F = 1\text{ k}\Omega$ for $A_V = -1$. R_L tied to $V^+/2$. Unless otherwise specified.

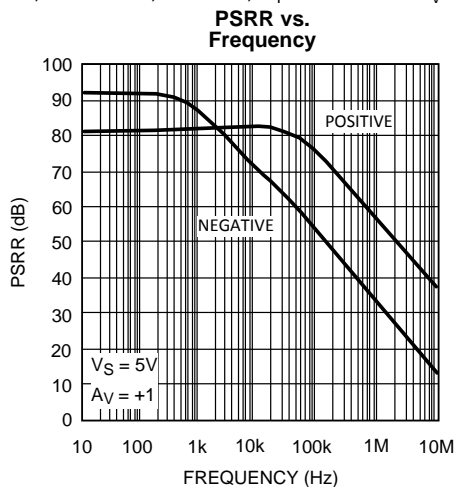

Figure 26.

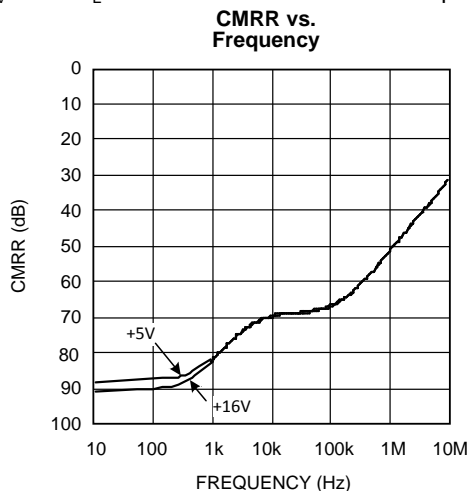

Figure 27.

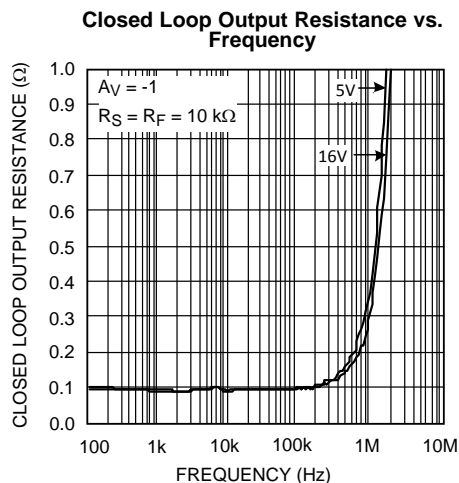

Figure 28.

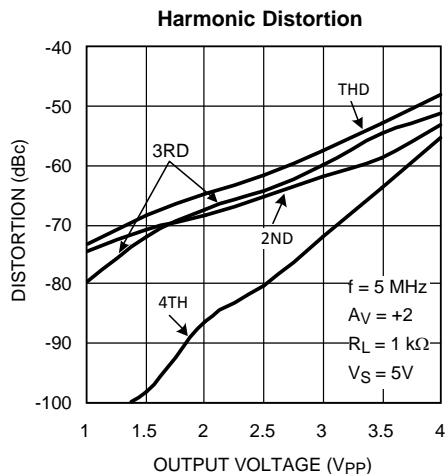

Figure 29.

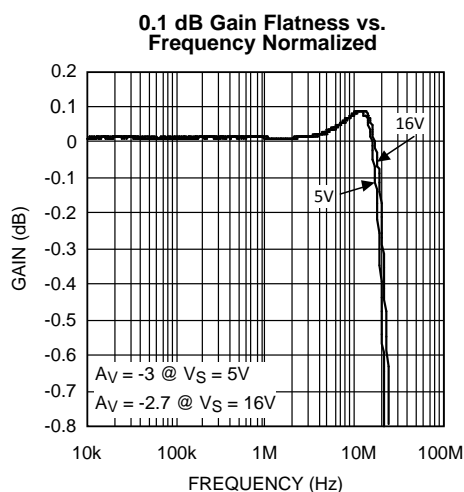

Figure 30.

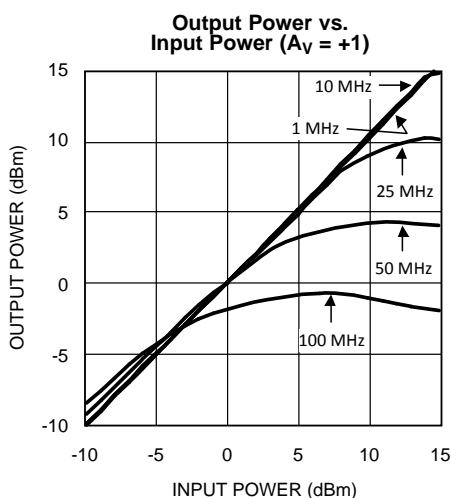

Figure 31.

Typical Performance Characteristics (continued)

At $T_J = 25^\circ\text{C}$, $V^+ = 16\text{ V}$, $V^- = 0\text{ V}$, $R_F = 330\Omega$ for $A_V = +2$, $R_F = 1\text{ k}\Omega$ for $A_V = -1$. R_L tied to $V^+/2$. Unless otherwise specified.

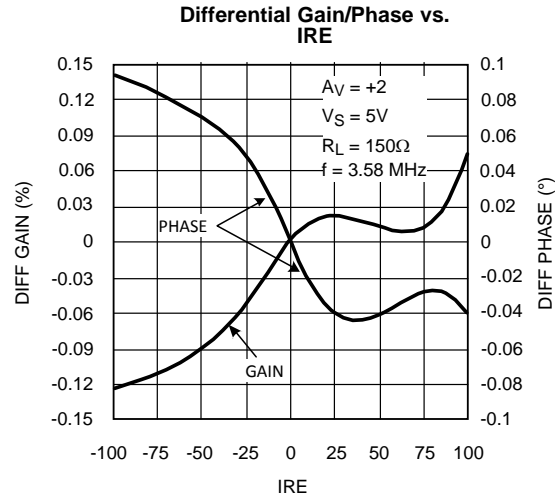

Figure 32.

APPLICATION INFORMATION

Application Notes

With its high output current and speed, one of the major applications for the LMH6640 is the V_{COM} driver in a TFT panel. This application is a specially taxing one because of the demands it places on the operational amplifier's output to drive a large amount of bi-directional current into a heavy capacitive load while operating under unity gain condition, which is a difficult challenge due to loop stability reasons. For a more detailed explanation of what a TFT panel is and what its amplifier requirements are, please see the Application Notes section of the LM6584 found on the web at: <http://www.ti.com/lit/pdf/sn0sb08>

Because of the complexity of the TFT V_{COM} waveform and the wide variation in characteristics between different TFT panels, it is difficult to decipher the results of circuit testing in an actual panel. The ability to make simplifying assumptions about the load in order to test the amplifier on the bench allows testing using standard equipment and provides familiar results which could be interpreted using standard loop analysis techniques. This is what has been done in this application note with regard to the LMH6640's performance when subjected to the conditions found in a TFT V_{COM} application.

Figure 33, shows a typical simplified V_{COM} application with the LMH6640 buffering the V_{COM} potential (which is usually around $\frac{1}{2}$ of panel supply voltage) and looking into the simplified model of the load. The load represents the cumulative effect of all stray capacitances between the V_{COM} node and both row and column lines. Associated with the capacitances shown, is the distributed resistance of the lines to each individual transistor switch. The other end of this R-C ladder is driven by the column driver in an actual panel and here is driven with a low impedance MOSFET driver (labeled "High Current Driver") for the purposes of this bench test to simulate the effect that the column driver exerts on the V_{COM} load.

The modeled TFT V_{COM} load, shown in Figure 33, is based on the following simplifying assumptions in order to allow for easy bench testing and yet allow good matching results obtained in the actual application:

- The sum of all the capacitors and resistors in the R-C ladder is the total V_{COM} capacitance and resistance respectively. This total varies from panel to panel; capacitance could range from 50 nF-200 nF and the resistance could be anywhere from 20 Ω -100 Ω .
- The number of ladder sections has been reduced to a number (4 sections in this case) which can easily be put together in the lab and which behaves reasonably close to the actual load.

In this example, the LMH6640 was tested under the simulated conditions of total 209 nF capacitance and 54 Ω as shown in Figure 33.

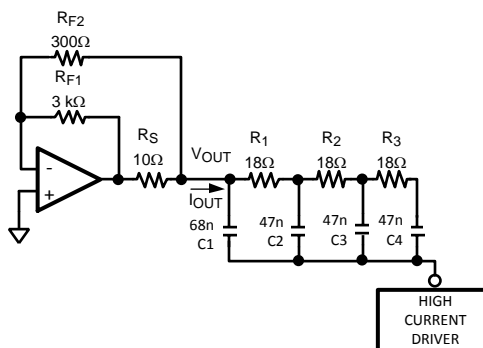

Figure 33. LMH6640 in a V_{COM} Buffer Application with Simulated TFT Load

R_S is sometimes used in the panel to provide additional isolation from the load while R_{F2} provides a more direct feedback from the V_{COM} . R_{F1} , R_{F2} , and R_S are trimmed in the actual circuit with settling time and stability trade-offs considered and evaluated. When tested under simulated load conditions of Figure 33, here are the resultant voltage and current waveforms at the LMH6640 output:

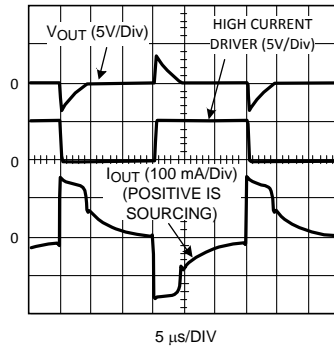

Figure 34. V_{COM} Output, High Current Drive Waveform, & LMH6640 Output Current Waveforms

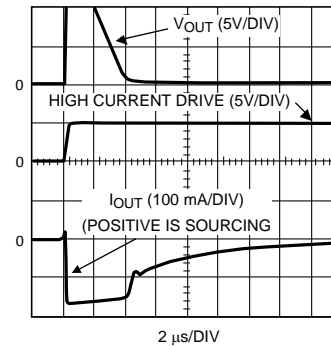

Figure 35. Expanded View of Figure 34 Waveforms showing LMH6640 Current Sinking $\frac{1}{2}$ Cycle

As can be seen, the LMH6640 is capable of supplying up to 160 mA of output current and can settle the output in 4.4 μ s.

The LMH6640 is a cost effective amplifier for use in the TFT V_{COM} application and is made even more attractive by its large supply voltage range and high output current. The combination of all these features is not readily available in the market, especially in the space saving SOT-23 5 pin package. All this performance is achieved at the low power consumption of 65 mW which is of utmost importance in today's battery driven TFT panels.

REVISION HISTORY

Changes from Revision A (March 2013) to Revision B	Page
<hr/> <ul style="list-style-type: none">• Changed layout of National Data Sheet to TI format <hr/>	<hr/> 14 <hr/>

PACKAGING INFORMATION

Orderable Device	Status (1)	Package Type	Package Drawing	Pins	Package Qty	Eco Plan (2)	Lead finish/ Ball material (6)	MSL Peak Temp (3)	Op Temp (°C)	Device Marking (4/5)	Samples
LMH6640MF/NOPB	OBSOLETE	SOT-23	DBV	5		TBD	Call TI	Call TI		AH1A	

(1) The marketing status values are defined as follows:

ACTIVE: Product device recommended for new designs.

LIFEBUY: TI has announced that the device will be discontinued, and a lifetime-buy period is in effect.

NRND: Not recommended for new designs. Device is in production to support existing customers, but TI does not recommend using this part in a new design.

PREVIEW: Device has been announced but is not in production. Samples may or may not be available.

OBSOLETE: TI has discontinued the production of the device.

(2) **RoHS:** TI defines "RoHS" to mean semiconductor products that are compliant with the current EU RoHS requirements for all 10 RoHS substances, including the requirement that RoHS substance do not exceed 0.1% by weight in homogeneous materials. Where designed to be soldered at high temperatures, "RoHS" products are suitable for use in specified lead-free processes. TI may reference these types of products as "Pb-Free".

RoHS Exempt: TI defines "RoHS Exempt" to mean products that contain lead but are compliant with EU RoHS pursuant to a specific EU RoHS exemption.

Green: TI defines "Green" to mean the content of Chlorine (Cl) and Bromine (Br) based flame retardants meet JS709B low halogen requirements of <=1000ppm threshold. Antimony trioxide based flame retardants must also meet the <=1000ppm threshold requirement.

(3) MSL, Peak Temp. - The Moisture Sensitivity Level rating according to the JEDEC industry standard classifications, and peak solder temperature.

(4) There may be additional marking, which relates to the logo, the lot trace code information, or the environmental category on the device.

(5) Multiple Device Markings will be inside parentheses. Only one Device Marking contained in parentheses and separated by a "-" will appear on a device. If a line is indented then it is a continuation of the previous line and the two combined represent the entire Device Marking for that device.

(6) Lead finish/Ball material - Orderable Devices may have multiple material finish options. Finish options are separated by a vertical ruled line. Lead finish/Ball material values may wrap to two lines if the finish value exceeds the maximum column width.

Important Information and Disclaimer:The information provided on this page represents TI's knowledge and belief as of the date that it is provided. TI bases its knowledge and belief on information provided by third parties, and makes no representation or warranty as to the accuracy of such information. Efforts are underway to better integrate information from third parties. TI has taken and continues to take reasonable steps to provide representative and accurate information but may not have conducted destructive testing or chemical analysis on incoming materials and chemicals. TI and TI suppliers consider certain information to be proprietary, and thus CAS numbers and other limited information may not be available for release.

In no event shall TI's liability arising out of such information exceed the total purchase price of the TI part(s) at issue in this document sold by TI to Customer on an annual basis.

EXAMPLE BOARD LAYOUT

DBV0005A

SOT-23 - 1.45 mm max height

SMALL OUTLINE TRANSISTOR

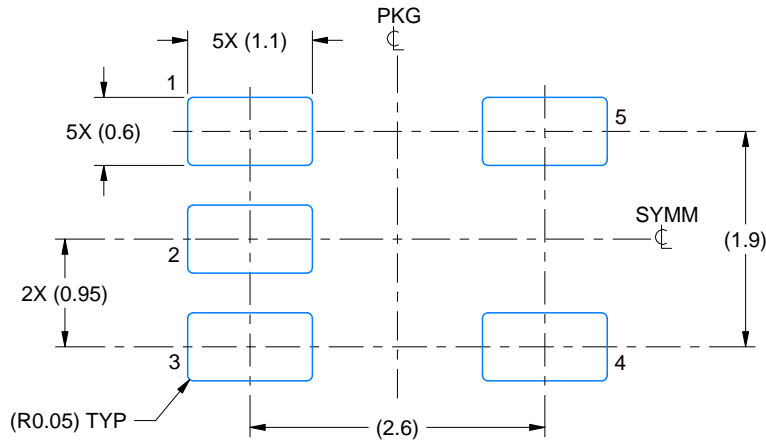

LAND PATTERN EXAMPLE
EXPOSED METAL SHOWN
SCALE:15X

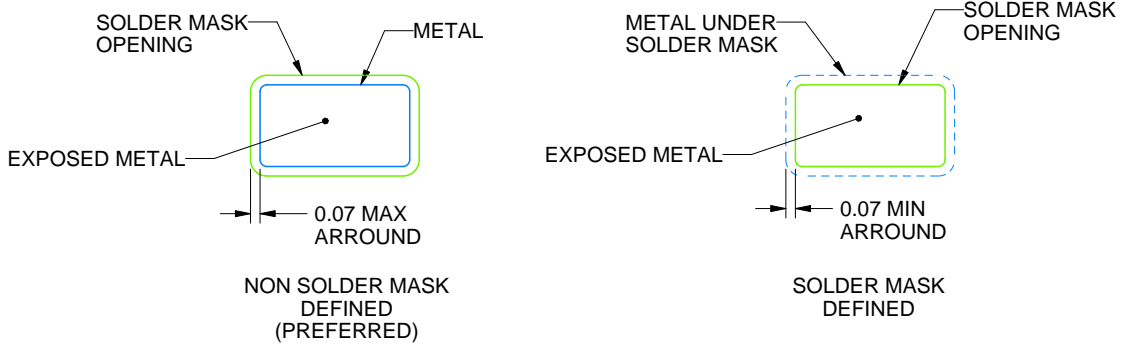

SOLDER MASK DETAILS

4214839/J 02/2024

NOTES: (continued)

- Publication IPC-7351 may have alternate designs.
- Solder mask tolerances between and around signal pads can vary based on board fabrication site.

EXAMPLE STENCIL DESIGN

DBV0005A

SOT-23 - 1.45 mm max height

SMALL OUTLINE TRANSISTOR



SOLDER PASTE EXAMPLE
BASED ON 0.125 mm THICK STENCIL
SCALE:15X

4214839/J 02/2024

NOTES: (continued)

8. Laser cutting apertures with trapezoidal walls and rounded corners may offer better paste release. IPC-7525 may have alternate design recommendations.
9. Board assembly site may have different recommendations for stencil design.

IMPORTANT NOTICE AND DISCLAIMER

TI PROVIDES TECHNICAL AND RELIABILITY DATA (INCLUDING DATA SHEETS), DESIGN RESOURCES (INCLUDING REFERENCE DESIGNS), APPLICATION OR OTHER DESIGN ADVICE, WEB TOOLS, SAFETY INFORMATION, AND OTHER RESOURCES "AS IS" AND WITH ALL FAULTS, AND DISCLAIMS ALL WARRANTIES, EXPRESS AND IMPLIED, INCLUDING WITHOUT LIMITATION ANY IMPLIED WARRANTIES OF MERCHANTABILITY, FITNESS FOR A PARTICULAR PURPOSE OR NON-INFRINGEMENT OF THIRD PARTY INTELLECTUAL PROPERTY RIGHTS.

These resources are intended for skilled developers designing with TI products. You are solely responsible for (1) selecting the appropriate TI products for your application, (2) designing, validating and testing your application, and (3) ensuring your application meets applicable standards, and any other safety, security, regulatory or other requirements.

These resources are subject to change without notice. TI grants you permission to use these resources only for development of an application that uses the TI products described in the resource. Other reproduction and display of these resources is prohibited. No license is granted to any other TI intellectual property right or to any third party intellectual property right. TI disclaims responsibility for, and you will fully indemnify TI and its representatives against, any claims, damages, costs, losses, and liabilities arising out of your use of these resources.

TI's products are provided subject to [TI's Terms of Sale](#) or other applicable terms available either on [ti.com](https://www.ti.com) or provided in conjunction with such TI products. TI's provision of these resources does not expand or otherwise alter TI's applicable warranties or warranty disclaimers for TI products.

TI objects to and rejects any additional or different terms you may have proposed.

Mailing Address: Texas Instruments, Post Office Box 655303, Dallas, Texas 75265
Copyright © 2024, Texas Instruments Incorporated