

LMR38010-Q1 4.2V~80V、1A、車載用、40 μ A I_Q の SIMPLE SWITCHER® 同期パワ ーコンバータ

1 特長

- 車載アプリケーション向けに AEC-Q100 認定済み
 - 温度グレード 1: -40°C ~ +125°C, T_A
- 機能安全対応
 - 機能安全システムの設計に役立つ資料を利用可能
- 堅牢な車載アプリケーション向けの構成
 - 入力電圧範囲: 4.2V ~ 80V
 - 連続出力電流: 1A
 - 非常に小さい動作時静止電流: 40 μ A
 - VIN ピンと GND ピンの間の距離: 1.5mm 超
 - 調整可能なスイッチング周波数: 200kHz ~ 2.2MHz
 - 外部クロックへの周波数同期
 - スペクトラム拡散による EMI 低減
 - 最大デューティ サイクル: 97%
 - あらかじめ出力にバイアスが印加された状態でのスタートアップをサポート
 - 室温で許容誤差 $\pm 1.0\%$ の基準電圧
 - 高精度のイネーブル
 - 補償ネットワークを内蔵した使いやすいデバイスで、BOM 数を削減
 - 同期整流器内蔵
 - PowerPAD™ 付き 8 ピン HSOIC 回路パッケージ
 - PFM および強制 PWM (FPWM) オプション
 - 2A、LMR38020-Q1 で供給
- WEBENCH® Power Designer により、LMR38010-Q1 を使用するカスタム設計を作成

2 アプリケーション

- 車載用インバータおよびモーター制御
- 車載用 DC/DC コンバータ
- 車載用バッテリー管理システム
- 車載用 48V マイルド ハイブリッド ECU バイアス電源

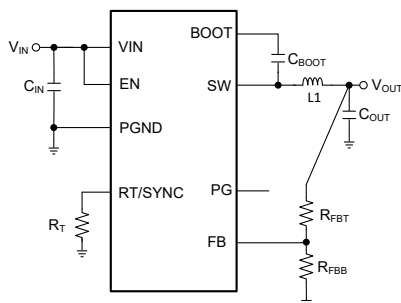

概略回路図

3 概要

LMR38010-Q1 同期整流降圧コンバータは、広い入力電圧範囲でレギュレーションを行えるよう設計されており、必要な外付けサージ抑制部品を最小限に押さえています。LMR38010-Q1 は最低 4.2V の入力電圧ディップ中も動作し、必要に応じて 100% に近いデューティ サイクルで動作するため、48V バッテリーの車載用アプリケーションおよび MHEV/EV システムに最適です。

LMR38010-Q1 は、高精度イネーブルを使って幅広い入力電圧と直接接続でき、またデバイスのスタートアップとシャットダウンを精密に制御できるため、設計の柔軟性を高めることができます。内蔵のフィルタと遅延を備えたパワーグッド フラグは、システムの実際の状態を示すため、外部のスーパーバイザは不要です。このデバイスは疑似ランダム拡散スペクトラムを内蔵し、EMI を最小限に抑えます。また、200kHz ~ 2.2MHz の広い範囲でスイッチング周波数を構成し、ノイズの影響を受けやすい周波数帯を避けることができます。また、効率向上のために低い動作周波数を選択することも、設計小型化のために高い動作周波数を選択することも可能です。

このデバイスには、サイクル単位の電流制限、ヒカップ モード短絡保護、過剰な電力消費時のサーマル シャットダウンなどの保護機能が組み込まれています。LMR38010-Q1 は車載用 AEC-Q100 グレード 1 認定済みであり、8 ピンの HSOIC PowerPAD 回路パッケージで供給されます。

パッケージ情報

部品番号	パッケージ (1)	パッケージ サイズ(2)
LMR38010-Q1	DDA (HSOIC, 8)	4.89mm × 3.90mm

- 詳細については、セクション 11 を参照してください。
- パッケージ サイズ (長さ×幅) は公称値であり、該当する場合はピンも含まれます。

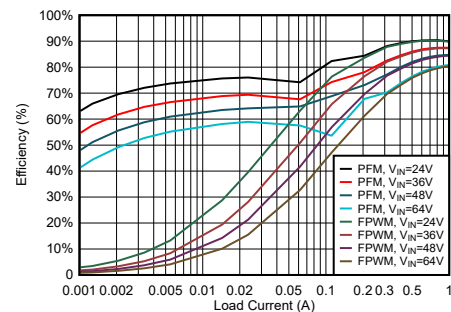

効率と出力電流との関係 V_{OUT} = 5V、400kHz



Table of Contents

1 特長	1	8 Application and Implementation	19
2 アプリケーション	1	8.1 Application Information.....	19
3 概要	1	8.2 Typical Application.....	20
4 Device Comparison Table	3	8.3 Best Design Practices.....	27
5 Pin Configuration and Functions	3	8.4 Power Supply Recommendations.....	27
6 Specifications	4	8.5 Layout.....	27
6.1 Absolute Maximum Ratings.....	4	9 Device and Documentation Support	31
6.2 ESD Ratings.....	4	9.1 Device Support.....	31
6.3 Recommended Operating Conditions.....	4	9.2 Documentation Support.....	31
6.4 Thermal Information.....	5	9.3 ドキュメントの更新通知を受け取る方法.....	31
6.5 Electrical Characteristics.....	5	9.4 サポート・リソース.....	31
6.6 System Characteristics.....	7	9.5 Trademarks.....	32
6.7 Typical Characteristics.....	8	9.6 静電気放電に関する注意事項.....	32
7 Detailed Description	9	9.7 用語集.....	32
7.1 Overview.....	9	10 Revision History	32
7.2 Functional Block Diagram.....	9	11 Mechanical, Packaging, and Orderable Information	32
7.3 Feature Description.....	9		
7.4 Device Functional Modes.....	17		

4 Device Comparison Table

ORDERABLE PART NUMBER	CURRENT	FPWM	SPREAD SPECTRUM
LMR38010SQDDARQ1	1 A	No	Yes
LMR38010FSQDDARQ1	1 A	Yes	Yes

5 Pin Configuration and Functions



図 5-1. DDA Package, 8-Pin HSOIC (Top View)

表 5-1. Pin Functions

PIN		TYPE	DESCRIPTION
NAME	NO.		
GND	1	G	Power and analog ground terminal. All electrical parameters are measured with respect to this pin. Connect a high-quality bypass capacitor directly to this pin and VIN with short and wide traces.
EN	2	A	Enable input to regulator. High = ON, low = OFF. Can be connected directly to VIN. <i>Do not float.</i>
VIN	3	P	Input supply to the regulator. Connect a high-quality bypass capacitor or capacitors directly to this pin and GND with short and wide traces.
RT/SYNC	4	A	Resistor timing or external clock input. An internal amplifier holds this pin at a fixed voltage when using an external resistor to ground to set the switching frequency. If the pin is pulled above the PLL upper threshold, a mode change occurs and the pin becomes a synchronization input. The internal amplifier is disabled and the pin is a high impedance clock input to the internal PLL. If clocking edges stop, the internal amplifier is re-enabled and the operating mode returns to frequency programming by resistor.
FB	5	A	Feedback input to the regulator. Connect to tap point of the feedback voltage divider. <i>Do not float. Do not ground.</i>
PG	6	A	Open-drain power-good flag output. Connect to a suitable voltage supply through a current limiting resistor. High = power OK, low = power bad. The flag pulls low when EN = low. Can be left open when not used.
BOOT	7	P	Bootstrap supply voltage for the internal high-side driver. Connect a high-quality 100-nF capacitor from this pin to the SW pin.
SW	8	P	Regulator switch node. Connect to a power inductor.
EP	THERMAL PAD	Thermal	Connect to system ground.

6 Specifications

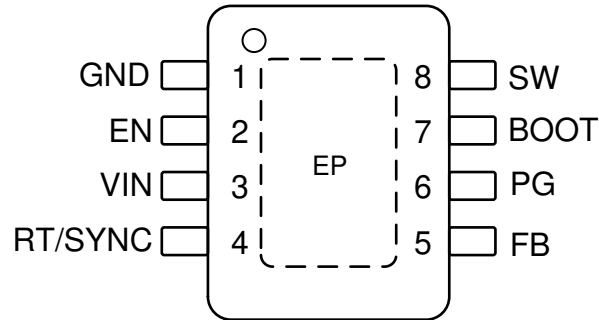
6.1 Absolute Maximum Ratings

Over junction temperature range of -40°C to 150°C (unless otherwise noted)⁽¹⁾

		MIN	MAX	UNIT
Input voltage	VIN to PGND	-0.3	85	V
	EN to PGND	-0.3	VIN+0.3	V
	FB to PGND	-0.3	5.5	V
	RT/SYNC to PGND	-0.3	5.5	V
Output voltage	BOOT to SW	-0.3	5.5	V
	SW to PGND	-0.3	85	V
	SW to PGND less than 10-ns transients	-5.0	85.3	V
	PGOOD to PGND	-0.3	20	V
Junction Temperature T_J		-40	150	$^{\circ}\text{C}$
Storage temperature, T_{stg}		-65	150	$^{\circ}\text{C}$

- (1) Operation outside the Absolute Maximum Ratings may cause permanent device damage. Absolute Maximum Ratings do not imply functional operation of the device at these or any other conditions beyond those listed under Recommended Operating Conditions. If used outside the Recommended Operating Conditions but within the Absolute Maximum Ratings, the device may not be fully functional, and this may affect device reliability, functionality, performance, and shorten the device lifetime.

6.2 ESD Ratings

			VALUE	UNIT
$V_{(ESD)}$	Electrostatic discharge	Human body model (HBM), per AEC Q100-002 ⁽¹⁾ Device HBM Classification Level 2	± 2000	V
		Charged device model (CDM), per AEC Q100-011 Device CDM Classification Level C5	± 750	

- (1) AEC Q100-002 indicates that HBM stressing shall be in accordance with the ANSI/ESDA/JEDEC JS-001 specification.

6.3 Recommended Operating Conditions

Over the recommended operating junction temperature range of -40°C to 150°C (unless otherwise noted)⁽¹⁾

		MIN	NOM	MAX	UNIT
Input voltage	Input voltage range after start-up	4.2		80	V
Input voltage	EN to PGND			VIN	V
Input voltage	RT to PGND			5	V
Input voltage	PGOOD to PGND			20	V
Output voltage	SW to PGND			80	V
Output voltage	Output voltage range for adjustable version ⁽²⁾	1		75	V
Frequency	Frequency adjustment range	200		2200	kHz
Sync frequency	Synchronization frequency range	300		2100	kHz
Load current	Output DC current range LMR38010-Q1 ⁽³⁾	0		1	A
Temperature	Operating junction temperature T_J range ⁽⁴⁾	-40		150	$^{\circ}\text{C}$

- (1) Recommended operating conditions indicate conditions for which the device is intended to be functional, but do not ensure specific performance limits. For compliant specifications, see Electrical Characteristics table.
(2) Under no conditions should the output voltage be allowed to fall below zero volts.
(3) Maximum continuous DC current may be derated when operating with high switching frequency and/or high ambient temperature. See Application section for details.
(4) High junction temperatures degrade operating lifetimes. Operating lifetime is de-rated for junction temperatures greater than 150°C .

6.4 Thermal Information

THERMAL METRIC ⁽¹⁾		LMR38010-Q1	UNIT
		DDA (HSOIC)	
		8 PINS	
R _{θJA}	Junction-to-ambient thermal resistance	42.9	°C/W
R _{θJA(Effective)}	Junction-to-ambient thermal resistance with TI EVM board	29	°C/W
R _{θJC(top)}	Junction-to-case (top) thermal resistance	54	°C/W
R _{θJB}	Junction-to-board thermal resistance	13.6	°C/W
ψ _{JT}	Junction-to-top characterization parameter	4.3	°C/W
ψ _{JB}	Junction-to-board characterization parameter	13.8	°C/W
R _{θJC(bot)}	Junction-to-case (bottom) thermal resistance	4.3	°C/W

(1) For more information about traditional and new thermal metrics, see the [Semiconductor and IC Package Thermal Metrics](#) application report.

6.5 Electrical Characteristics

Limits apply over operating junction temperature (T_J) range of –40°C to +150°C, unless otherwise stated. Minimum and Maximum limits⁽¹⁾ are specified through test, design or statistical correlation. Typical values represent the most likely parametric norm at T_J = 25°C, and are provided for reference purposes only. Unless otherwise stated, the following conditions apply: V_{IN} = 24 V.

PARAMETER		TEST CONDITIONS	MIN	TYP	MAX	UNIT
SUPPLY VOLTAGE AND CURRENT						
V _{IN_OPERATE}	Input operating voltage	Needed to start up			4.2	V
		Once operating			3.8	V
I _{Q(Non-SW)}	Non-switching quiescent current	V _{EN} = 3.3 V (PFM variant only)		40		μA
I _{SD}	Shutdown quiescent current; measured at VIN pin	V _{EN} = 0 V		3	10	μA
ENABLE						
V _{EN-H}	Enable input high level	V _{EN} rising	1.1	1.25	1.4	V
V _{EN-L}	Enable input low level	V _{EN} falling	0.95	1.10	1.22	V
I _{LKG-EN}	Enable input leakage current	V _{EN} = 3.3V		5.0		nA
VOLTAGE REFERENCE (FB PIN)						
V _{REF}	Feedback reference voltage	V _{in} =4.2V to 80V, T _J =25°C, FPWM	0.99	1	1.01	V
V _{REF}	Feedback reference voltage	FPWM	0.985	1	1.015	V
I _{LKG-FB}	Feedback leakage current	FB = 1.2 V		2.1		nA
CURRENT LIMITS AND HICCUP						
I _{HS-LIMIT}	High-side current limit ⁽²⁾	1A Version	1.3	1.6	1.9	A
I _{LS-LIMIT}	Low-side current limit ⁽²⁾	1A Version	0.9	1.2	1.5	A
I _{L-ZC}	Zero cross detector threshold	PFM variants only		0.01		A
I _{PEAK-MIN}	Minimum inductor peak current ⁽²⁾	1A Version, PFM variants only		0.25		A
I _{L-NEG}	Negative current limit ⁽²⁾	1A Version, FPWM variant only		–0.5		A
POWER STAGE						
R _{DS-ON-HS}	High-side MOSFET ON-resistance			303		mΩ
R _{DS-ON-LS}	Low-side MOSFET ON-resistance			133		mΩ
t _{ON-MIN}	Minimum switch on-time ⁽³⁾	V _{IN} =24 V, I _{out} = 1 A		80	131	ns
t _{OFF-MIN}	Minimum switch off-time			190	300	ns
t _{ON-MAX}	Maximum switch on-time			5		us
SWITCHING FREQUENCY AND SYNCHRONIZATION						
F _{OSC}	Switching frequency	R _T = 64.9 kΩ	320	400	480	kHz

6.5 Electrical Characteristics (続き)

Limits apply over operating junction temperature (T_J) range of -40°C to $+150^{\circ}\text{C}$, unless otherwise stated. Minimum and Maximum limits⁽¹⁾ are specified through test, design or statistical correlation. Typical values represent the most likely parametric norm at $T_J = 25^{\circ}\text{C}$, and are provided for reference purposes only. Unless otherwise stated, the following conditions apply: $V_{IN} = 24\text{ V}$.

PARAMETER		TEST CONDITIONS	MIN	TYP	MAX	UNIT
F_{SPREAD}	Spread of internal oscillator with Spread Spectrum Enabled		-8		8	%
VSYNC_HI	SYNC clock high level threshold				2	V
VSYNC_LO	SYNC clock low level threshold		0.6			V
$t_{\text{PULSE_H}}$	High duration needed to be recognized as a pulse				50	ns
C_{LOCK}	Time needed for clock to lock to a valid synchronization signal in sync cycles				230	us
STARTUP AND TRACKING						
t_{SS}	Internal soft-start time			4		ms
POWER GOOD						
$V_{\text{PG-HIGH-UP}}$	Power-Good upper threshold - rising	% of FB voltage	110%	112%	114%	
$V_{\text{PG-LOW-DN}}$	Power-Good lower threshold - falling	% of FB voltage	90%	92%	94%	
$V_{\text{PG-HYS}}$	Power-Good hysteresis (rising & falling)	% of FB voltage		2.2%		
$V_{\text{PG-VALID}}$	Minimum input voltage for proper Power-Good function				2	V
R_{PG}	Power-Good on-resistance	$V_{\text{EN}} = 0\text{ V}$		140		Ω
R_{PG}	Power-Good on-resistance	$V_{\text{EN}} = 3.3\text{V}$		92		Ω
$t_{\text{PGDFLT(fall)}}$	Glitch filter time constant for PGOOD function			40		us
THERMAL SHUTDOWN						
$T_{\text{SD-Rising}}^{(4)}$	Thermal shutdown	Shutdown threshold		163		$^{\circ}\text{C}$
$T_{\text{SD-Falling}}^{(4)}$	Thermal shutdown	Recovery threshold		150		$^{\circ}\text{C}$

- (1) MIN and MAX limits are 100% production tested at 25°C . Limits over the operating temperature range verified through correlation using Statistical Quality Control (SQC) methods. Limits are used to calculate Average Outgoing Quality Level (AOQL).
- (2) The current limit values in this table are tested, open loop, in production. They may differ from those found in a closed loop application.
- (3) Not production tested. Specified by correlation by design at 1A load
- (4) Not production tested. Specified by design

6.6 System Characteristics

The following specifications apply to a typical application circuit with nominal component values. Specifications in the typical (TYP) column apply to $T_J = 25^\circ\text{C}$ only. Specifications in the minimum (MIN) and maximum (MAX) columns apply to the case of typical components over the temperature range of $T_J = -40^\circ\text{C}$ to 150°C . *These specifications are not ensured by production testing.*

PARAMETER		TEST CONDITIONS	MIN	TYP	MAX	UNIT
V_{IN}	Operating input voltage range		4.2		80	V
V_{OUT}	Adjustable output voltage regulation ⁽¹⁾	PFM operation	-1.5%		2.5%	
V_{OUT}	Adjustable output voltage regulation ⁽¹⁾	FPWM operation	-1.5%		1.5%	
I_{SUPPLY}	Input supply current when in regulation	$V_{IN} = 24\text{ V}$, $V_{OUT} = 3.3\text{ V}$, $I_{OUT} = 0\text{ A}$, $R_{FBT} = 1\text{ M}\Omega$, PFM variant		40		μA
D_{MAX}	Maximum switch duty cycle ⁽²⁾			97%		
V_{HC}	FB pin voltage required to trip short-circuit hiccup mode			0.4		V
t_D	Switch voltage dead time			5		ns
F_{SSS}	Frequency span of spread spectrum operation			± 4		%
T_{SD}	Thermal shutdown temperature	Shutdown temperature		163		$^\circ\text{C}$
T_{SD}	Thermal shutdown temperature	Recovery temperature		150		$^\circ\text{C}$

- (1) Deviation in V_{OUT} from nominal output voltage value at $V_{IN} = 24\text{ V}$, $I_{OUT} = 0\text{ A}$ to full load
 (2) In dropout the switching frequency drops to increase the effective duty cycle. The lowest frequency is clamped at approximately: $F_{MIN} = 1 / (t_{ON-MAX} + t_{OFF-MIN})$. $D_{MAX} = t_{ON-MAX} / (t_{ON-MAX} + t_{OFF-MIN})$.

6.7 Typical Characteristics

Unless otherwise specified the following conditions apply: $T_A = 25^\circ\text{C}$, $V_{IN} = 24\text{ V}$, $f_{SW} = 400\text{ kHz}$

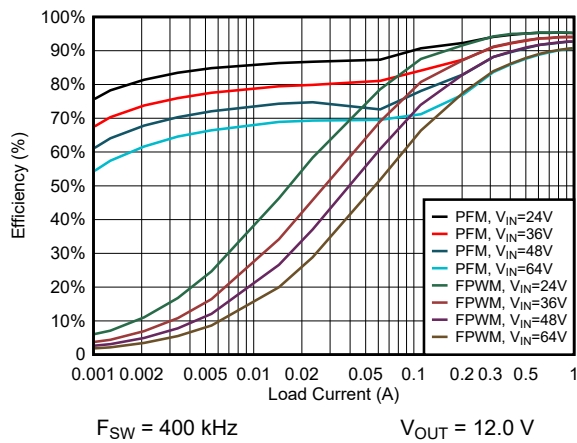

6-1. Efficiency vs Load Current

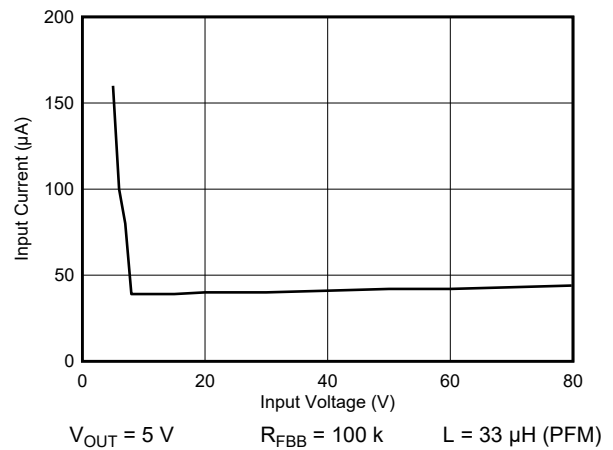

6-2. No Load Input Current vs Input Voltage

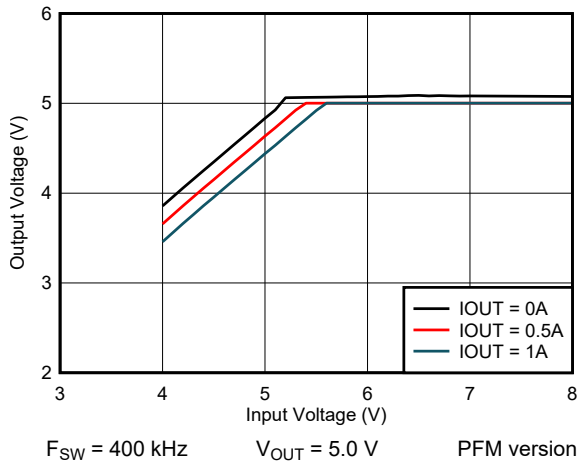

6-3. 5-V Dropout

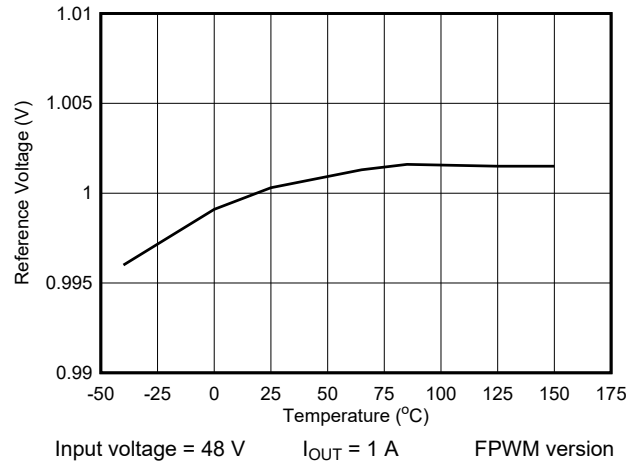

6-4. Reference Voltage vs Temperature

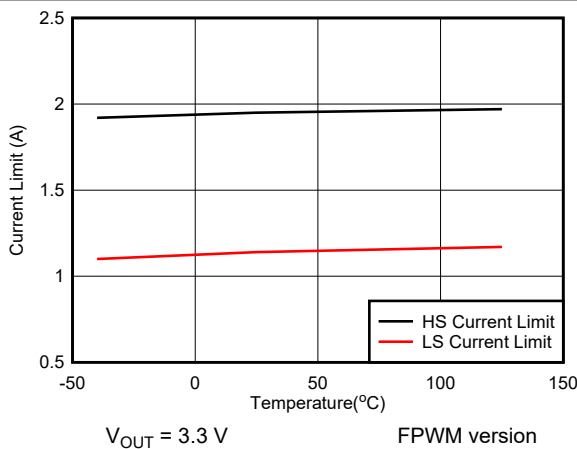

6-5. High-Side and Low-Side Current Limit vs Temperature

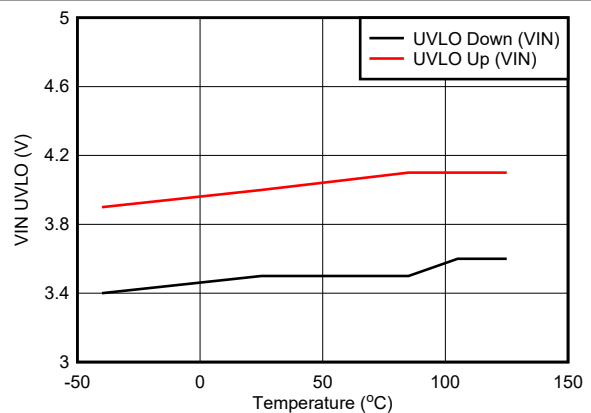

6-6. V_{IN} UVLO vs Temperature

7 Detailed Description

7.1 Overview

The LMR38010-Q1 converter is an easy-to-use synchronous step-down DC/DC converter that operates from a 4.2-V to 80-V supply voltage. The device is capable of delivering up to 1-A DC load current in a small solution size. The LMR38010-Q1 employs peak-current mode control. The device enters PFM mode at light load to achieve high efficiency for PFM version. A FPWM version is provided to achieve low output voltage ripple, tight output voltage regulation, and constant switching frequency at light load. The device is internally compensated, which reduces design time, and requires few external components.

Additional features, such as precision enable and internal soft start, provide a flexible and easy-to-use solution for a wide range of applications. Protection features include the following:

- Thermal shutdown
- V_{IN} undervoltage lockout
- Cycle-by-cycle current limit
- Hiccup mode short-circuit protection

The family requires very few external components and has a pinout designed for a simple, optimal PCB layout.

7.2 Functional Block Diagram

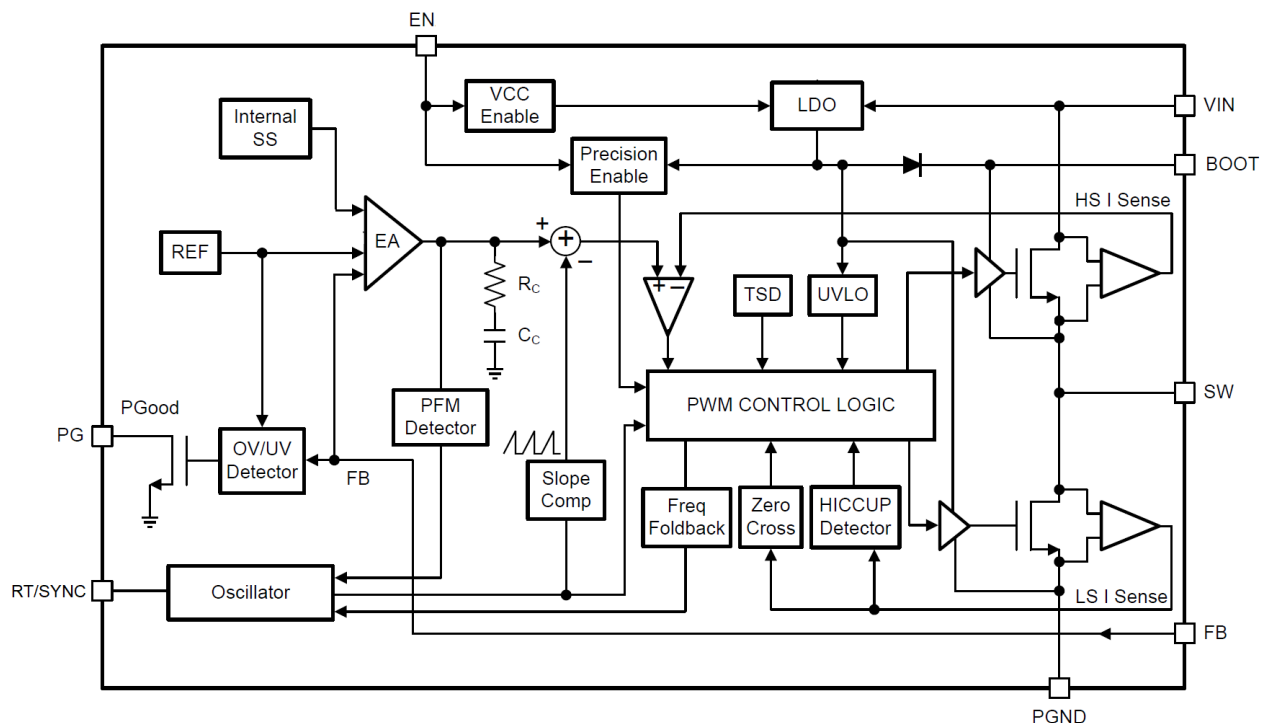

7.3 Feature Description

7.3.1 Fixed Frequency Peak Current Mode Control

The LMR38010-Q1 is a step-down synchronous buck converter with integrated high-side (HS) and low-side (LS) switches (synchronous rectifier). The LMR38010-Q1 supplies a regulated output voltage by turning on the high-side and low-side NMOS switches with controlled duty cycle. During high-side switch on time, the SW pin voltage swings up to approximately V_{IN} , and the inductor current, i_L , increases with a linear slope $(V_{IN} - V_{OUT}) / L$. When the high-side switch is turned off by the control logic, the low-side switch is turned on after an anti-shoot-through dead time. Inductor current discharges through the low-side switch with a slope of $-V_{OUT} / L$. The

control parameter of a buck converter is defined as Duty Cycle $D = t_{ON} / T_{SW}$, where t_{ON} is the high-side switch on time and T_{SW} is the switching period. The converter control loop maintains a constant output voltage by adjusting the duty cycle D . In an ideal buck converter where losses are ignored, D is proportional to the output voltage and inversely proportional to the input voltage: $D = V_{OUT} / V_{IN}$.

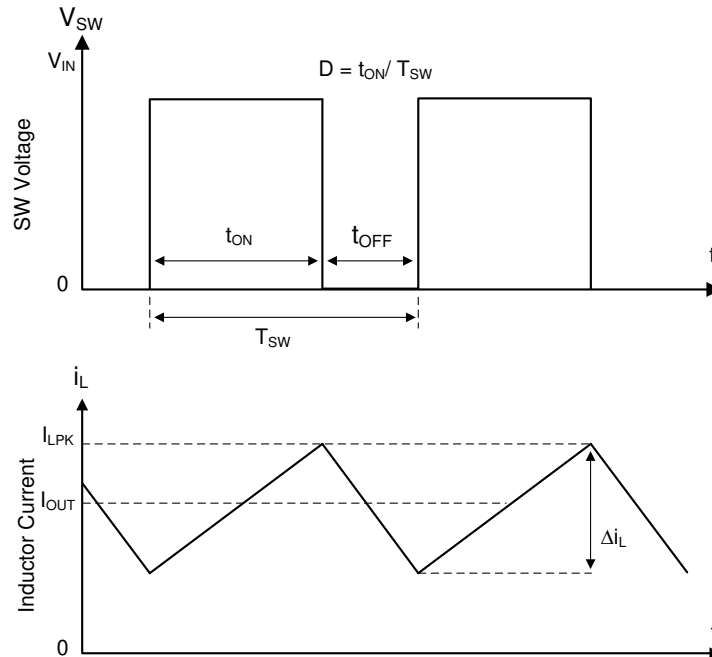

☒ 7-1. SW Node and Inductor Current Waveforms in Continuous Conduction Mode (CCM)

The LMR38010-Q1 employs fixed-frequency peak-current mode control. A voltage feedback loop is used to get accurate DC voltage regulation by adjusting the peak-current command based on voltage offset. The peak inductor current is sensed from the high-side switch and compared to the peak current threshold to control the on time of the high-side switch. The voltage feedback loop is internally compensated, which allows for fewer external components, making it easy to design and providing stable operation with almost any combination of output capacitors. The converter operates with fixed switching frequency at normal load condition. At light-load condition, the LMR38010-Q1 operates in PFM mode to maintain high efficiency (PFM version) or in FPWM mode for low output voltage ripple, tight output voltage regulation, and constant switching frequency (FPWM version).

7.3.2 Adjustable Output Voltage

A precision 1.0-V reference voltage (V_{REF}) is used to maintain a tightly regulated output voltage over the entire operating temperature range. The output voltage is set by a resistor divider from the output voltage to the FB pin. TI recommends to use 1% tolerance resistors with a low temperature coefficient for the FB divider. Select the bottom-side resistor R_{FBB} for the desired divider current and use 式 1 to calculate the top-side resistor R_{FBT} . TI recommends R_{FBT} in the range from 10 k Ω to 100 k Ω for most applications. A lower R_{FBT} value can be used if static loading is desired to reduce V_{OUT} offset in PFM operation. Lower R_{FBT} reduces efficiency at very light load. Less static current goes through a larger R_{FBT} and can be more desirable when light-load efficiency is critical. TI does not recommend R_{FBT} larger than 1 M Ω because it makes the feedback path more susceptible to noise. Larger R_{FBT} values require more carefully designed feedback path on the PCB. The tolerance and temperature variation of the resistor dividers affect the output voltage regulation.



図 7-2. Output Voltage Setting

$$R_{FBT} = \frac{V_{OUT} - V_{REF}}{V_{REF}} \times R_{FBB} \quad (1)$$

7.3.3 Enable

The voltage on the EN pin controls the ON or OFF operation of the LMR38010-Q1. A voltage below 0.95 V shuts the device down, while a voltage above 1.4 V is required to start the converter. The EN pin is an input and cannot be left open or floating. The simplest way to enable the operation of the LMR38010-Q1 is to connect the EN to VIN. This allows self-start-up of the LMR38010-Q1 when V_{IN} is within the operating range.

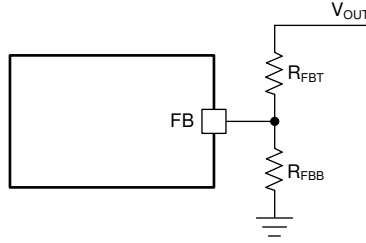
Many applications benefit from the employment of an enable divider R_{ENT} and R_{ENB} (図 7-3) to establish a precision system UVLO level for the converter. System UVLO can be used for supplies operating from utility power as well as battery power. System UVLO can be used for sequencing, making sure the user has reliable operation or supply protection, such as a battery discharge level. An external logic signal can also be used to drive EN input for system sequencing and protection. Note that the EN pin voltage must never be higher than V_{IN} + 0.3 V.



図 7-3. System UVLO by Enable Divider

7.3.4 Switching Frequency and Synchronization (RT/SYNC)

The switching frequency of the LMR38010-Q1 can be programmed by the resistor R_T from the RT/SYNC pin and GND pin. The RT/SYNC pin cannot be left floating or shorted to ground. To determine the timing resistance for a given switching frequency, use 式 2 or the curve in 図 7-4. 表 7-1 gives typical R_T values for a given f_{SW}.

$$R_T(k\Omega) = 30970 \times f_{SW}(kHz)^{-1.027} \quad (2)$$

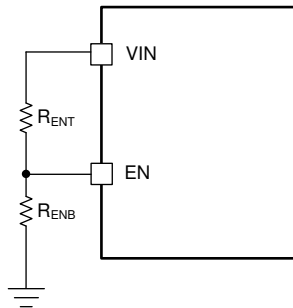

図 7-4. R_T Versus Frequency Curve

表 7-1. Typical Frequency Setting R_T Resistance

f _{sw} (kHz)	R _T (kΩ)
200	133
400	64.9
500	52.3
750	34.8
1000	25.5
1500	16.9
2000	12.7
2200	11.5

The LMR38010-Q1 switching action can also be synchronized to an external clock from 300 kHz to 2.1 MHz. Connect a square wave to the RT/SYNC pin through either circuit network shown in 図 7-5. The internal oscillator is synchronized by the falling edge of external clock. The recommendations for the external clock include: high level no lower than 2.0 V, low level no higher than 0.6 V, and have a pulse width greater than 50 ns. When using a low impedance signal source, the frequency setting resistor R_T is connected in parallel with an AC coupling capacitor, C_{COUP}, to a termination resistor, R_{TERM} (for example, 50 Ω). The two resistors in series provide the default frequency setting resistance when the signal source is turned off. A 10-pF ceramic capacitor can be used for C_{COUP}, and show the device synchronized to an external system clock.

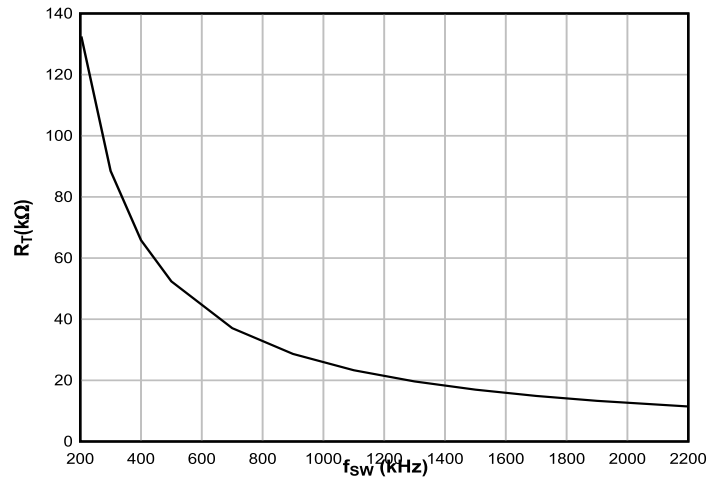

図 7-5. Synchronizing to an External Clock

7.3.5 Power-Good Flag Output

The power-good flag function (PG output pin) of the LMR38010-Q1 can be used to reset a system microprocessor whenever the output voltage is out of regulation. This open-drain output goes low under fault

conditions, such as current limit and thermal shutdown, as well as during normal start-up. A glitch filter prevents false flag operation for short excursions of the output voltage, such as during line and load transients. Output voltage excursions lasting less than t_{PG} do not trip the power-good flag. Note that during initial power up, a delay of approximately 4 ms (typical) is inserted from the time that EN is asserted to the time that the power-good flag goes high. This delay only occurs during start-up and is not encountered during normal operation of the power-good function.

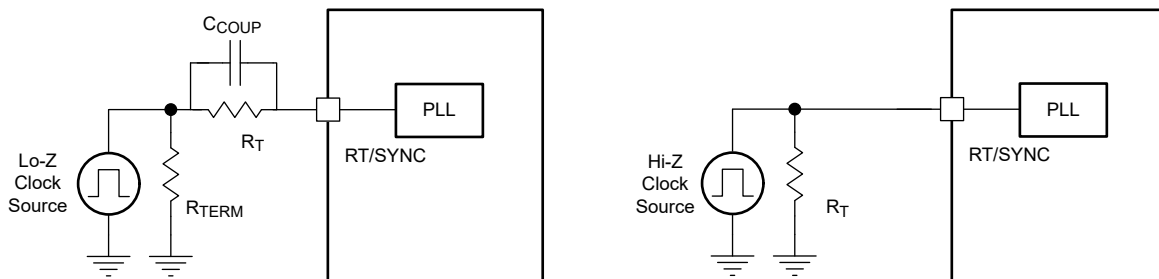
The power-good output consists of an open-drain NMOS, requiring an external pullup resistor to a suitable logic supply. It can also be pulled up to either VCC or V_{OUT} , through a 100-k Ω resistor, as desired. If this function is not needed, the PG pin must be left floating. When EN is pulled low, the flag output is also forced low. With EN low, power good remains valid as long as the input voltage is greater than or equal to 2 V (typical). Limit the current into the power-good flag pin to less than 5-mA D.C. The maximum current is internally limited to approximately 35 mA when the device is enabled and approximately 65 mA when the device is disabled. The internal current limit protects the device from any transient currents that can occur when discharging a filter capacitor connected to this output.



図 7-6. Static Power-Good Operation



☒ 7-7. Power-Good Timing Behavior

7.3.6 Minimum On Time, Minimum Off Time, and Frequency Foldback

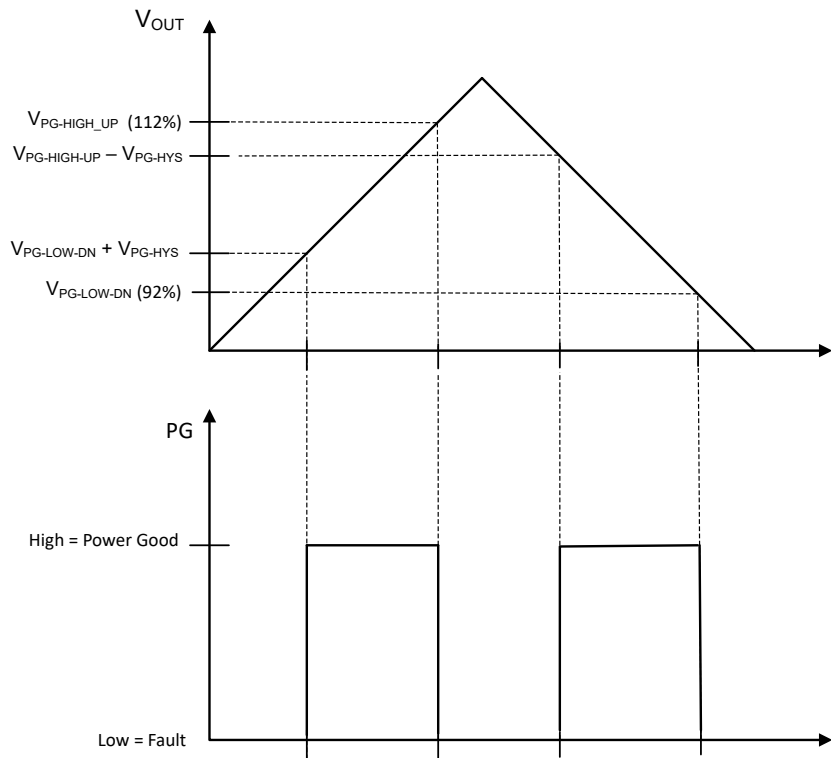
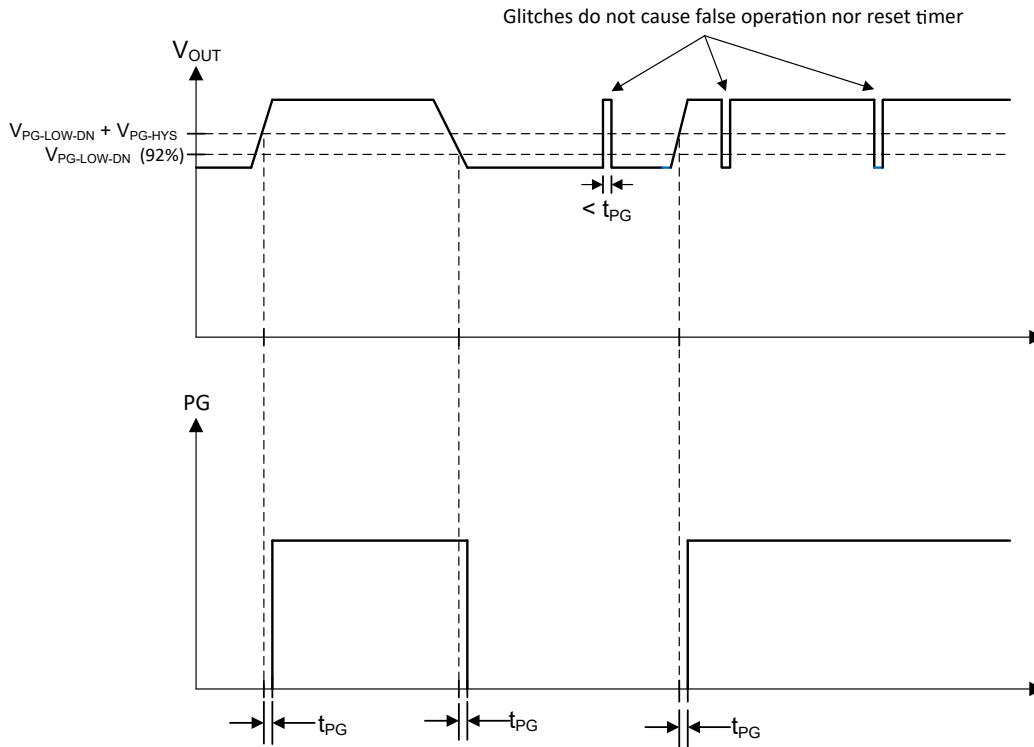
Minimum on time (T_{ON_MIN}) is the smallest duration of time that the high-side switch can be on. T_{ON_MIN} is typically 75 ns in the LMR38010-Q1. Minimum off time (T_{OFF_MIN}) is the smallest duration that the high-side switch can be off. T_{OFF_MIN} is typically 190 ns. In CCM operation, T_{ON_MIN} and T_{OFF_MIN} limit the voltage conversion range without switching frequency foldback.

The minimum duty cycle without frequency foldback allowed is:

$$D_{MIN} = T_{ON_MIN} \times f_{SW} \quad (3)$$

The maximum duty cycle without frequency foldback allowed is:

$$D_{MAX} = 1 - (T_{OFF_MIN} \times f_{SW}) \quad (4)$$

Given a required output voltage, the maximum V_{IN} without frequency foldback can be found by:

$$V_{IN_MAX} = \frac{V_{OUT}}{T_{ON_MIN} \times f_{SW}} \quad (5)$$

The minimum V_{IN} without frequency foldback can be calculated by:

$$V_{IN_MIN} = \frac{V_{OUT}}{1 - (T_{OFF_MIN} \times f_{SW})} \quad (6)$$

In the LMR38010-Q1, a frequency foldback scheme is employed after T_{ON_MIN} or T_{OFF_MIN} is triggered, which can extend the maximum duty cycle or lower the minimum duty cycle.

The on time decreases while V_{IN} voltage increases. After the on time decreases to T_{ON_MIN} , the switching frequency starts to decrease while V_{IN} continues to go up, which lowers the duty cycle further to keep V_{OUT} in regulation according to 式 3.

The frequency foldback scheme also works after larger duty cycle is needed under low V_{IN} condition. The frequency decreases after the device hits its T_{OFF_MIN} , which extends the maximum duty cycle according to 式 4. In such condition, the frequency can be as low as approximately 133 kHz minimum. Wide range of frequency foldback allows the LMR38010-Q1 output voltage stay in regulation with a much lower supply voltage V_{IN} , which leads to a lower effective dropout.

The fixed frequency operation at FPWM mode with switching frequency greater than 1.2 MHz, is maintained with minimum load current about 100 mA for wider input voltage range. And for very light load and switching frequency over 1.2 MHz, frequency drop can be expected during mintoff frequency foldback.

With frequency foldback, V_{IN_MAX} is raised, and V_{IN_MIN} is lowered by decreased f_{SW} .

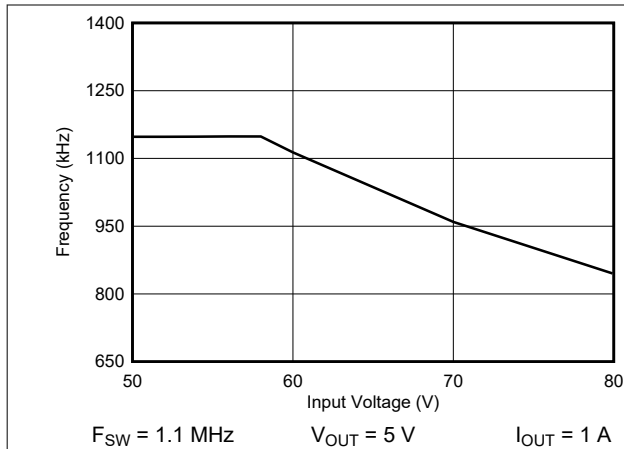

Figure 7-8. Typical Frequency Foldback at T_{ON_MIN}

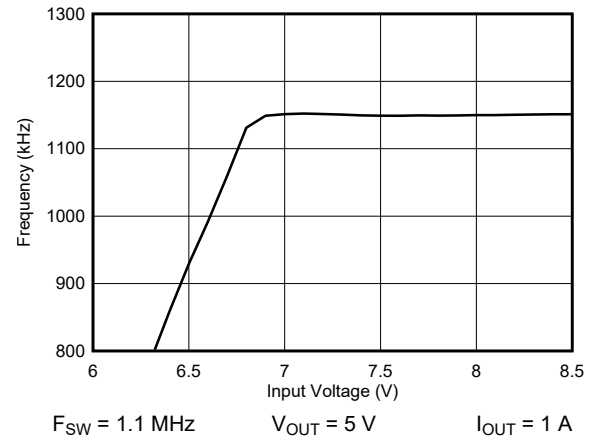

Figure 7-9. Typical Frequency Foldback at T_{OFF_MIN}

7.3.7 Bootstrap Voltage

The LMR38010-Q1 provides an integrated bootstrap voltage converter. A small capacitor between the BOOT and SW pins provides the gate drive voltage for the high-side MOSFET. The bootstrap capacitor is refreshed when the high-side MOSFET is off and the low-side switch conducts. The recommended value of the bootstrap capacitor is 0.1 μF . TI recommends a ceramic capacitor with an X7R or X5R grade dielectric with a voltage rating of 16 V or higher for stable performance over temperature and voltage.

7.3.8 Overcurrent and Short Circuit Protection

The LMR38010-Q1 is protected from overcurrent conditions by cycle-by-cycle current limit on both the peak and valley of the inductor current. Hiccup mode is activated if a fault condition persists to prevent overheating.

High-side MOSFET overcurrent protection is implemented by the nature of the peak current mode control. The high-side switch current is sensed when the high-side is turned on after a set blanking time. The high-side switch current is compared to the output of the error amplifier (EA) minus slope compensation every switching cycle. The peak current of high-side switch is limited by a clamped maximum peak current threshold, I_{HS_LIMIT} , which is constant.

The current going through the low-side MOSFET is also sensed and monitored. When the low-side switch turns on, the inductor current begins to ramp down. The low-side switch is turned OFF at the end of a switching cycle if its current is above the low-side current limit, I_{LS_LIMIT} . The low-side switch is kept on so that inductor current keeps ramping down until the inductor current ramps below the I_{LS_LIMIT} . Then the low-side switch is turned OFF and the high-side switch is turned on after a dead time. This is somewhat different to the more typical peak current limit and results in 式 7 for the maximum load current.

If the feedback voltage is lower than 40% of V_{REF} , the current of the low-side switch triggers I_{LS_LIMIT} for 256 consecutive cycles and hiccup current protection mode is activated. In hiccup mode, the converter shuts down and stays off for a period of hiccup, T_{HICCUP} (76-ms typical), before the LMR38010-Q1 tries to start again. If overcurrent or short-circuit fault condition still exist, hiccup repeats until the fault condition is removed. Hiccup mode reduces power dissipation under severe overcurrent conditions and prevents overheating and potential damage to the device.

$$I_{OUT_MAX} = I_{LS} + \left(\frac{V_{IN} - V_{OUT}}{L \times 2 \times f_{SW}} \right) \times \left(\frac{V_{OUT}}{V_{IN}} \right) \quad (7)$$

For FPWM version, the inductor current is allowed to go negative. When this current exceeds the low-side negative current limit, I_{LS_NEG} , the low-side switch is turned off and high-side switch is turned on immediately. This is used to protect the low-side switch from excessive negative current.

7.3.9 Soft Start

The integrated soft-start circuit prevents input inrush current impacting the LMR38010-Q1 and the input power supply. Soft start is achieved by slowly ramping up the target regulation voltage when the device is first enabled or powered up. The typical soft-start time is 4.0 ms.

The LMR38010-Q1 also employs overcurrent protection blanking time, T_{OCP_BLK} (18-ms typical), at the beginning of power up. Without this feature, in applications with a large amount of output capacitors and high V_{OUT} , the inrush current is large enough to trigger current-limit protection, which can make the device enter into hiccup mode. The device tries to restart after the hiccup period, then hits the current limit and enters into hiccup mode again, so V_{OUT} cannot ramp up to the setting voltage ever. By introducing the OCP blanking feature, the hiccup protection function is disabled during T_{OCP_BLK} , and LMR38010-Q1 charges the V_{OUT} with its maximum limited current, which maximizes the output current capacity during this period. Note that the peak current limit (I_{HS_LIMIT}) and valley current limit (I_{LS_LIMIT}) protection functions are still available during T_{OCP_BLK} , so there is no concern of inductor current running away.

7.3.10 Thermal Shutdown

The LMR38010-Q1 provides an internal thermal shutdown to protect the device when the junction temperature exceeds 163°C. Both high-side and low-side FETs stop switching in thermal shutdown. After the die temperature falls below 150°C, the device reinitiates the power-up sequence controlled by the internal soft-start circuitry.

7.4 Device Functional Modes

7.4.1 Auto Mode

In auto mode, the device moves between PWM and PFM as the load changes. At light loads, the regulator operates in PFM. At higher loads, the mode changes to PWM.

In PWM, the regulator operates as a constant frequency, current mode, full-synchronous converter using PWM to regulate the output voltage. While operating in this mode, the output voltage is regulated by switching at a constant frequency and modulating the duty cycle to control the power to the load. This provides excellent line and load regulation and low output voltage ripple.

In PFM, the high-side MOSFET is turned on in a burst of one or more pulses to provide energy to the load. The duration of the burst depends on how long it takes the inductor current to reach $I_{PEAK-MIN}$. The frequency of these bursts is adjusted to regulate the output, while diode emulation is used to maximize efficiency (see the [Glossary](#)). This mode provides high light-load efficiency by reducing the amount of input supply current required to regulate the output voltage at small loads. This trades off very good light-load efficiency for larger output voltage ripple and variable switching frequency. Also, a small increase in output voltage occurs at light loads. The actual switching frequency and output voltage ripple depend on the input voltage, output voltage, and load.

7.4.2 Forced PWM Operation

The forced PWM option is choiced for cases when constant frequency operation is more important than light-load efficiency.

In FPWM operation, the diode emulation feature is turned off. This means that the device remains in CCM under light loads. Under conditions where the device must reduce the on time or off time below the compliant minimum to maintain regulation, the frequency reduces to maintain the effective duty cycle required for regulation. This occurs for very high and very low input and output voltage ratios. In FPWM mode, a limited reverse current is allowed through the inductor, allowing power to pass from the output of the regulator to the input of the regulator. Note that in FPWM mode, larger currents pass through the inductor, if lightly loaded, than in auto mode. After loads are heavy enough to necessitate CCM operation, FPWM mode has no measurable effect on regulator operation.

7.4.3 Dropout

The dropout performance of any buck regulator is affected by the $R_{DS(ON)}$ of the power MOSFETs, the DC resistance of the inductor, and the maximum duty cycle that the controller can achieve. As the input voltage is reduced to the output voltage, the off time of the high-side MOSFET starts to approach the minimum value.

Beyond this point, the switching can become erratic and the output voltage falls out of regulation. To avoid this problem, the LMR38010-Q1 automatically reduces the switching frequency to increase the effective duty cycle and maintain regulation. In this data sheet, the dropout voltage is defined as the difference between the input and output voltage when the output has dropped by 1% of the nominal value. Under this condition, the switching frequency has dropped to its minimum value of about 140 kHz. Note that the 0.4-V short circuit detection threshold is not activated when in dropout mode.

7.4.4 Minimum Switch On Time

Every switching regulator has a minimum controllable on time dictated by the inherent delays and blanking times associated with the control circuits. This imposes a minimum switch duty cycle, therefore, a minimum conversion ratio. The constraint is encountered at high input voltages and low output voltages. To help extend the minimum controllable duty cycle, the LMR38010-Q1 automatically reduces the switching frequency when the minimum on-time limit is reached. This way, the converter can regulate the lowest programmable output voltage at the maximum input voltage. An estimate for the approximate input voltage for a given output voltage, before frequency foldback occurs, is found in 式 8 . As the input voltage is increased, the switch on time (duty cycle) reduces to regulate the output voltage. When the on time reaches the limit, the switching frequency drops, while the on time remains fixed.

$$V_{IN} \leq \frac{V_{OUT}}{t_{ON} \times f_{SW}} \quad (8)$$

8 Application and Implementation

注

以下のアプリケーション情報は、TI の製品仕様に含まれるものではなく、TI ではその正確性または完全性を保証いたしません。個々の目的に対する製品の適合性については、お客様の責任で判断していただくこととなります。お客様は自身の設計実装を検証しテストすることで、システムの機能を確認する必要があります。

8.1 Application Information

The LMR38010-Q1 step-down DC-to-DC converter is typically used to convert a higher DC voltage to a lower DC voltage with a maximum output current of 1 A. The following design procedure can be used to select components for the LMR38010-Q1. Alternately, use the WEBENCH Design Tool to generate a complete design. This tool uses an iterative design procedure and has access to a comprehensive database of components. This allows the tool to create an optimized design and allows the user to experiment with various options.

注

All of the capacitance values given in the following application information refer to *effective* values unless otherwise stated. The *effective* value is defined as the actual capacitance under DC bias and temperature, not the rated or nameplate values. Use high-quality, low-ESR, ceramic capacitors with an X7R or better dielectric throughout. All high value ceramic capacitors have a large voltage coefficient in addition to normal tolerances and temperature effects. Under DC bias the capacitance drops considerably. Large case sizes and higher voltage ratings are better in this regard. To help mitigate these effects, multiple capacitors can be used in parallel to bring the minimum *effective* capacitance up to the required value. This can also ease the RMS current requirements on a single capacitor. A careful study of bias and temperature variation of any capacitor bank must be made to ensure that the minimum value of *effective* capacitance is provided.

8.2 Typical Application

図 8-1 shows a typical application circuit for the LMR38010-Q1. This device is designed to function over a wide range of external components and system parameters. However, the internal compensation is optimized for a certain range of external inductance and output capacitance. As a quick-start guide, 表 8-1 provides typical component values for a range of the most common output voltages.



図 8-1. Example Application Circuit

表 8-1. Typical External Component Values for 1-A Output Current

f_{sw} (kHz)	V_{IN} (V) Typical	V_{OUT} (V)	L (μ H)	NOMINAL C_{OUT} (RATED CAPACITANCE)	MINIMUM C_{OUT} (RATED CAPACITANCE)	R_{FBT} (Ω)	R_{FBB} (Ω)
400	48	5	33	3 × 22 μ F	2 × 22 μ F	100 k	24.9 k
1000	24	5	10	2 × 22 μ F	2 × 15 μ F	100 k	24.9 k
400	48	12	68	1 × 22 μ F	1 × 15 μ F	100 k	9.09 k
1000	24	12	15	2 × 10 μ F	1 × 10 μ F	100 k	9.09 k
500	48	24	68	1 × 22 μ F	1 × 15 μ F	100 k	4.32 k

8.2.1 Design Requirements

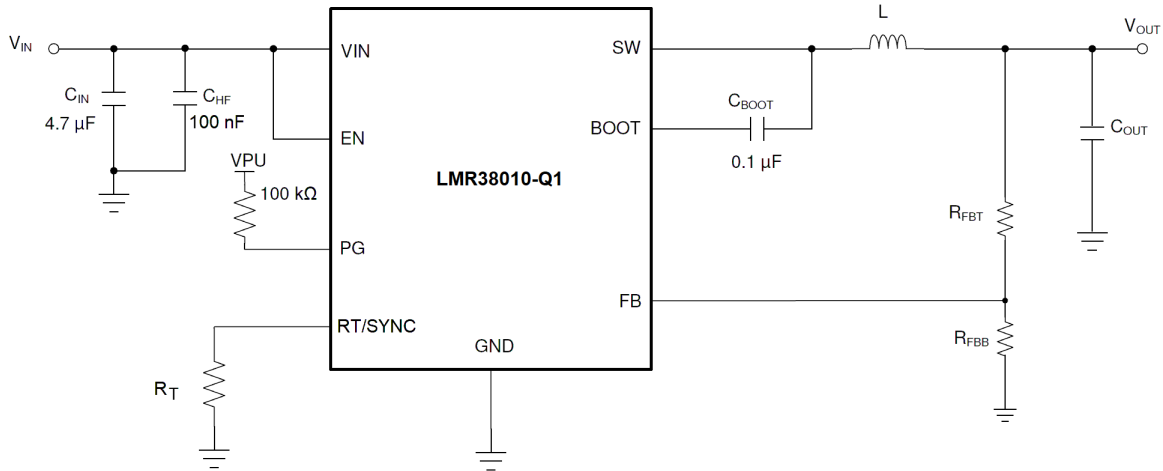
セクション 8.2.2 provides a detailed design procedure based on 表 8-2.

表 8-2. Detailed Design Parameters

DESIGN PARAMETER	EXAMPLE VALUE
Input voltage	6 V to 80 V
Output voltage	5 V
Maximum output current	0 A to 1 A
Switching frequency	400 kHz

8.2.2 Detailed Design Procedure

The following design procedure applies to 図 8-1 and 表 8-1.

8.2.2.1 Custom Design With WEBENCH® Tools

[Click here](#) to create a custom design using the LMR38010-Q1 device with the WEBENCH® Power Designer.

1. Start by entering the input voltage (V_{IN}), output voltage (V_{OUT}), and output current (I_{OUT}) requirements.
2. Optimize the design for key parameters such as efficiency, footprint, and cost using the optimizer dial.

3. Compare the generated design with other possible solutions from Texas Instruments.

The WEBENCH Power Designer provides a customized schematic along with a list of materials with real-time pricing and component availability.

In most cases, these actions are available:

- Run electrical simulations to see important waveforms and circuit performance
- Run thermal simulations to understand board thermal performance
- Export customized schematic and layout into popular CAD formats
- Print PDF reports for the design, and share the design with colleagues

Get more information about WEBENCH tools at www.ti.com/WEBENCH.

8.2.2.2 Choosing the Switching Frequency

The choice of switching frequency is a compromise between conversion efficiency and overall solution size. Lower switching frequency implies reduced switching losses and usually results in higher system efficiency. However, higher switching frequency allows the use of smaller inductors and output capacitors, hence, a more compact design. For this example, 400 kHz is used.

8.2.2.3 FB for Adjustable Output

In an adjustable output voltage version, pin 5 of the device is FB. The output voltage of the LMR38010-Q1 is externally adjustable using an external resistor divider network. The divider network is comprised of R_{FBT} and R_{FBB} and closes the loop between the output voltage and the converter. The converter regulates the output voltage by holding the voltage on the FB pin equal to the internal reference voltage, V_{REF} . The resistance of the divider is a compromise between excessive noise pickup and excessive loading of the output. Smaller values of resistance reduce noise sensitivity, but also reduce the light-load efficiency. The recommended value for R_{FBT} is 100 k Ω with a maximum value of 1 M Ω . After R_{FBT} is selected, 式 9 is used to select R_{FBB} . V_{REF} is nominally 1 V.

$$R_{FBB} = \frac{R_{FBT}}{\left[\frac{V_{OUT}}{V_{REF}} - 1 \right]} \quad (9)$$

For this 5-V example, $R_{FBT} = 100 \text{ k}\Omega$ and $R_{FBB} = 24.9 \text{ k}\Omega$ is chosen.

8.2.2.4 Inductor Selection

The parameters for selecting the inductor are the inductance and saturation current. The inductance is based on the desired peak-to-peak ripple current and is normally chosen to be in the range of 20% to 40% of the maximum output current. Experience shows that the best value for inductor ripple current is 30% of the maximum load current. Note that when selecting the ripple current for applications with much smaller maximum load than the maximum available from the device, use the maximum device current. 式 10 can be used to determine the value of inductance. The constant K is the percentage of inductor current ripple. For this example, choose $K = 0.4$ and find an inductance of $L = 28 \mu\text{H}$. Select the next standard value of $L = 33 \mu\text{H}$.

$$L = \frac{(V_{IN} - V_{OUT})}{f_{SW} \times K \times I_{OUT_{max}}} \times \frac{V_{OUT}}{V_{IN}} \quad (10)$$

Ideally, the saturation current rating of the inductor is at least as large as the high-side switch current limit, I_{SC} . This makes sure that the inductor does not saturate, even during a short circuit on the output. When the inductor core material saturates, the inductance falls to a very low value, causing the inductor current to rise very rapidly. Although the valley current limit, I_{LIMIT} , is designed to reduce the risk of current runaway, a saturated inductor can cause the current to rise to high values very rapidly. This can lead to component damage. Do not allow the inductor to saturate. Inductors with a ferrite core material have very *hard* saturation characteristics, but usually have lower core losses than powdered iron cores. Powdered iron cores exhibit a *soft* saturation, allowing some relaxation in the current rating of the inductor. However, they have more core losses at frequencies above

approximately 1 MHz. In any case, the inductor saturation current must not be less than the maximum peak inductor current at full load.

To avoid subharmonic oscillation, the inductance value must not be less than that given in 式 11:

$$L_{\text{MIN}} \geq M \times \frac{V_{\text{OUT}}}{f_{\text{SW}}} \quad (11)$$

where

- L_{MIN} = minimum inductance (H)
- $M = 0.25$ for a 1-A device
- f_{SW} = switching frequency (Hz)

The maximum inductance is limited by the minimum current ripple for the current mode control to perform correctly. As a rule-of-thumb, the minimum inductor ripple current must be no less than about 10% of the device maximum rated current under nominal conditions.

8.2.2.5 Output Capacitor Selection

The current mode control scheme of the LMR38010-Q1 devices allows operation over a wide range of output capacitance. The output capacitor bank is usually limited by the load transient requirements and stability rather than the output voltage ripple. Refer to 表 8-1 for typical output capacitor values for 5-V to 24-V output voltages. For a 5-V output design, TI recommends ceramic output capacitors for this example. For other designs with other output voltages, WEBENCH can be used as a starting point for selecting the value of output capacitor.

In practice, the output capacitor has the most influence on the transient response and loop-phase margin. Load transient testing and bode plots are the best way to validate any given design and must always be completed before the application goes into production. In addition to the required output capacitance, a small ceramic placed on the output can help reduce high-frequency noise. Small-case size ceramic capacitors in the range of 1 nF to 100 nF can be very helpful in reducing spikes on the output caused by inductor and board parasitics.

Limit the maximum value of total output capacitance to approximately 10 times the design value, or 1000 μF , whichever is smaller. Large values of output capacitance can adversely affect the start-up behavior of the regulator as well as the loop stability. If values larger than noted here must be used, then a careful study of start-up at full load and loop stability must be performed.

8.2.2.6 Input Capacitor Selection

The ceramic input capacitors provide a low impedance source to the regulator in addition to supplying the ripple current and isolating switching noise from other circuits. A minimum ceramic capacitance of 4.7 μF is required on the input of the LMR38010-Q1. This must be rated for at least the maximum input voltage that the application requires, preferably twice the maximum input voltage. This capacitance can be increased to help reduce input voltage ripple and maintain the input voltage during load transients. In addition, a small case size 100-nF to 220-nF ceramic capacitor must be used at the input, as close as possible to the regulator. This provides a high frequency bypass for the control circuits internal to the device. For this example, a 4.7- μF , 100-V, X7R (or better) ceramic capacitor is chosen. The 100 nF must also be rated at 100 V with an X7R dielectric.

Using an electrolytic capacitor on the input in parallel with the ceramics is desirable. This is especially true if long leads or traces are used to connect the input supply to the regulator. The moderate ESR of this capacitor can help damp any ringing on the input supply caused by the long power leads. The use of this additional capacitor also helps with voltage dips caused by input supplies with unusually high impedance.

Most of the input switching current passes through the ceramic input capacitor or capacitors. The approximate RMS value of this current can be calculated from 式 12 and must be checked against the manufacturers' maximum ratings.

$$I_{\text{RMS}} \cong \frac{I_{\text{OUT}}}{2} \quad (12)$$

8.2.2.7 C_{BOOT}

The LMR38010-Q1 requires a bootstrap capacitor connected between the BOOT pin and the SW pin. This capacitor stores energy that is used to supply the gate drivers for the power MOSFETs. A high-quality ceramic capacitor of 100 nF and at least 16 V is required.

8.2.2.8 External UVLO

In some cases, an input UVLO level different than that provided internal to the device is needed. This can be accomplished by using the circuit shown in [Figure 8-2](#). The turn-on voltage is designated as V_{ON} while the turn-off voltage is V_{OFF}. First, a value for R_{ENB} is chosen in the range of 10 kΩ to 100 kΩ, then [Equation 13](#) and [Equation 14](#) are used to calculate R_{ENT} and V_{OFF}.

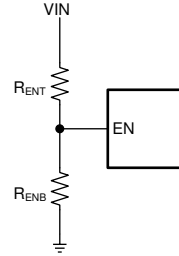

Figure 8-2. Setup for External UVLO Application

$$R_{ENT} = R_{ENB} \times \left(\frac{V_{ON}}{V_{EN-H}} - 1 \right) \quad (13)$$

$$V_{OFF} = V_{EN-L} \times \left(\frac{V_{ON}}{V_{EN-H}} \right) \quad (14)$$

where

- V_{ON} = V_{IN} turn-on voltage
- V_{OFF} = V_{IN} turn-off voltage

8.2.2.9 Maximum Ambient Temperature

As with any power conversion device, the device dissipates internal power while operating. The effect of this power dissipation is to raise the internal temperature of the converter above ambient. The internal die temperature (T_J) is a function of the ambient temperature, the power loss, and the effective thermal resistance, R_{θJA}, of the device and PCB combination. The maximum junction temperature for the LMR38010-Q1 must be limited to 150°C. This limit establishes a limit on the maximum device power dissipation and, therefore, the load current. [Equation 15](#) shows the relationships between the important parameters. Seeing that larger ambient temperatures (T_A) and larger values of R_{θJA} reduce the maximum available output current is easy. The converter efficiency can be estimated by using the curves provided in this data sheet. If the desired operating conditions cannot be found in one of the curves, interpolation can be used to estimate the efficiency. Alternatively, the EVM can be adjusted to match the desired application requirements and the efficiency can be measured directly. The correct value of R_{θJA} is more difficult to estimate. As stated in the [Semiconductor and IC Package Thermal Metrics](#), the values given in the *Thermal Information* are not valid for design purposes and must not be used to estimate the thermal performance of the application. The values reported in that table were measured under a specific set of conditions that are rarely obtained in an actual application.

$$I_{OUTMAX} = \left(\frac{T_J - T_A}{R_{\theta JA}} \right) \times \left(\frac{\eta}{1 - \eta} \right) \times \left(\frac{1}{V_{OUT}} \right) \quad (15)$$

where

- η = efficiency

The effective $R_{\theta JA}$ is a critical parameter and depends on many factors such as the following:

- Power dissipation
- Air temperature, flow
- PCB area
- Copper heat-sink area
- Number of thermal vias under the package
- Adjacent component placement

Use the following resources as guides to optimal thermal PCB design and estimating $R_{\theta JA}$ for a given application environment:

- [AN-2020 Thermal Design By Insight, Not Hindsight](#) application report
- [AN-1520 A Guide to Board Layout for Best Thermal Resistance for Exposed Packages](#) application report
- [Semiconductor and IC Package Thermal Metrics](#) application report
- [How to Properly Evaluate Junction Temperature with Thermal Metrics](#) application report
- [Using New Thermal Metrics](#) application report

8.2.3 Application Curves

Unless otherwise specified the following conditions apply: $V_{IN} = 48\text{ V}$, $L = 15\ \mu\text{H}$, $T_A = 25^\circ\text{C}$.

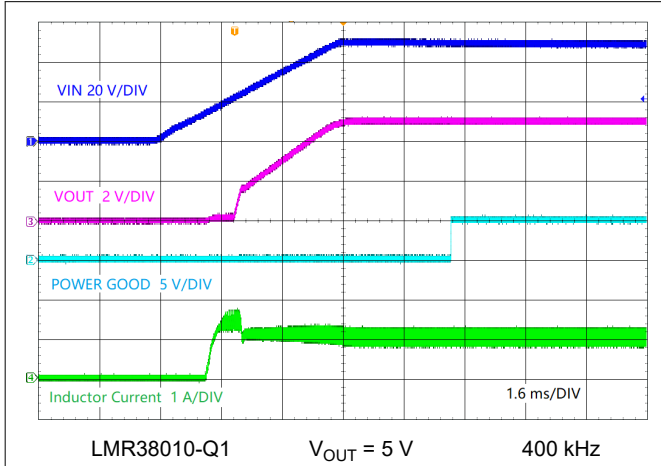

8-3. Start-Up by VIN

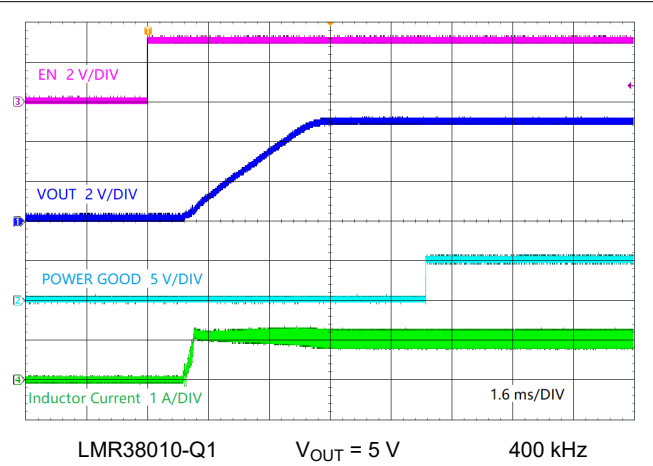

8-4. Start-Up by EN

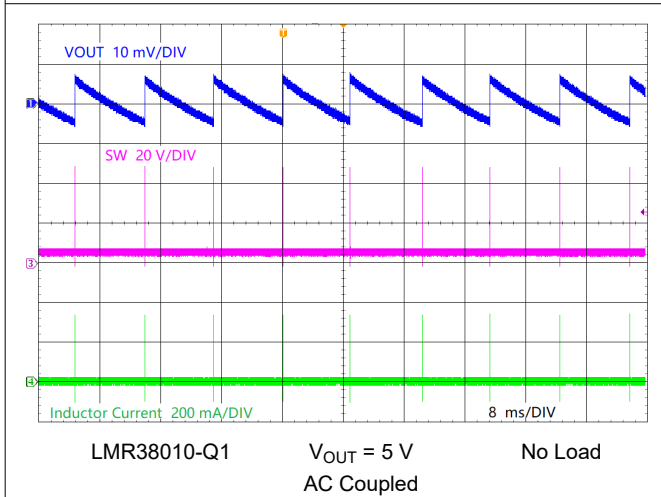

8-5. PFM Switching

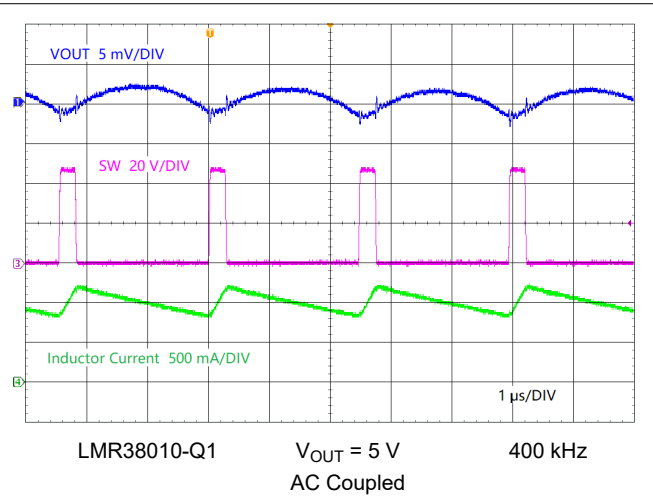

8-6. Full Load Switching

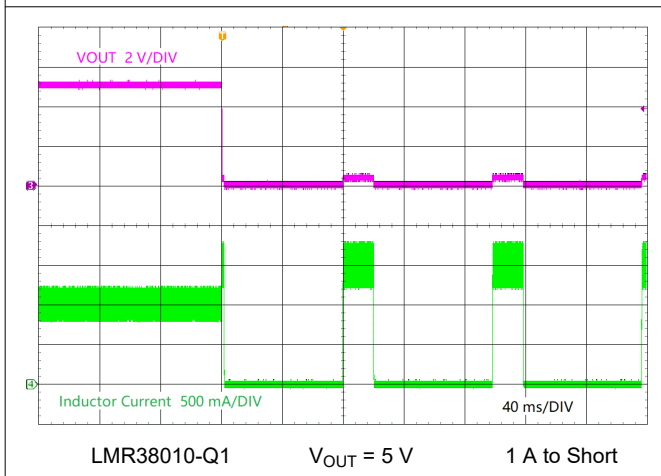

8-7. Short Circuit Applied

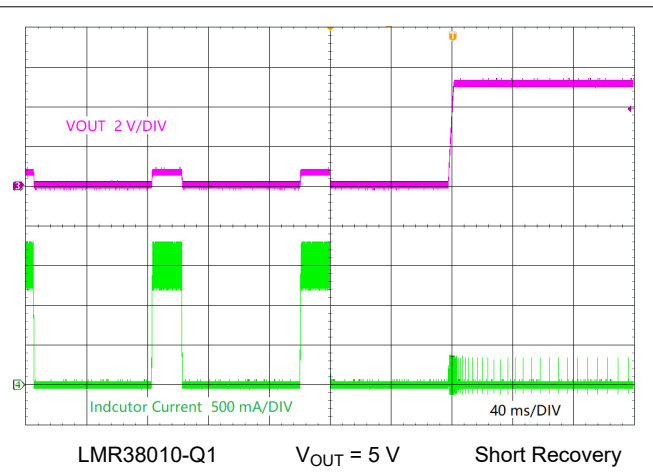

8-8. Short-Circuit Recovery

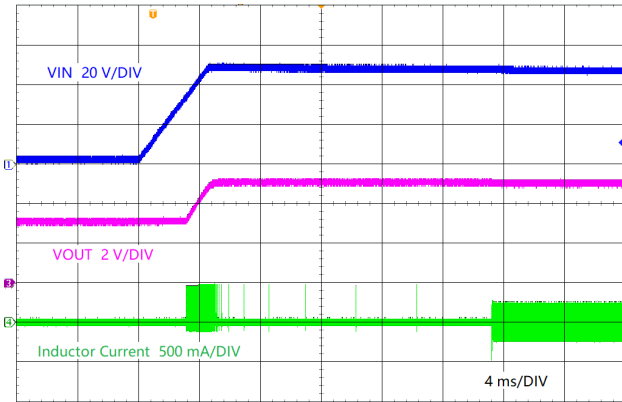

LMR38010-Q1 $V_{OUT} = 5\text{ V}$ No Load
FPWM Bias to 3 V

8-9. Start-Up with Prebias

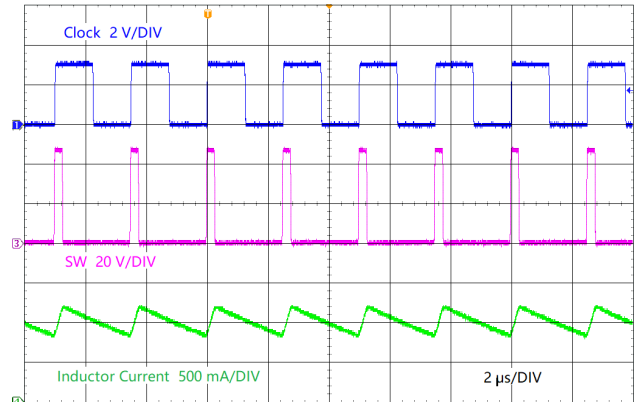

LMR38010-Q1 $V_{OUT} = 5\text{ V}$ 400 kHz

8-10. Frequency Synchronization

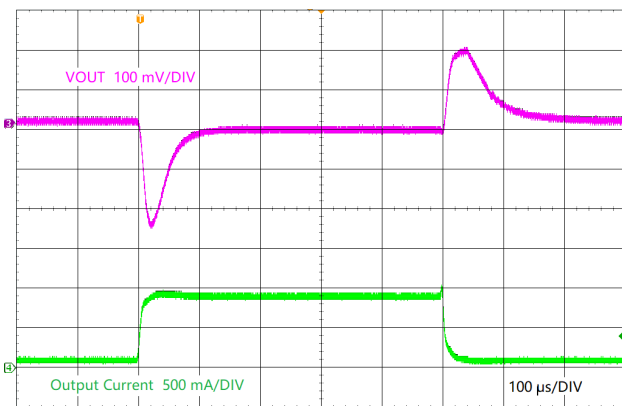

LMR38010-Q1 $V_{OUT} = 5\text{ V}$ 400 kHz
(AC Coupled)
100 mA to 900 mA at 200 mA/μs

8-11. Load Transient

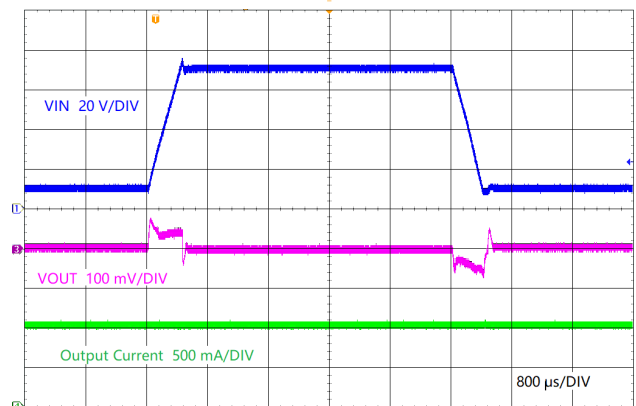

LMR38010-Q1 $V_{OUT} = 5\text{ V}$ 400 kHz
(AC Coupled)
10 V to 70 V at 200 V/ms

8-12. Line Transient

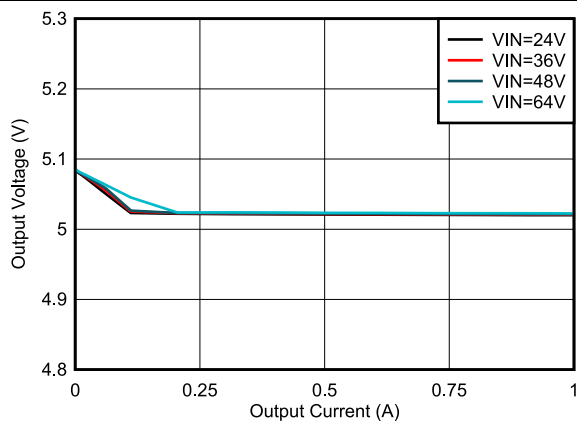

LMR38010-Q1 $V_{OUT} = 5\text{ V}$ 400 kHz
PFM Version

8-13. 5-V Load Regulation

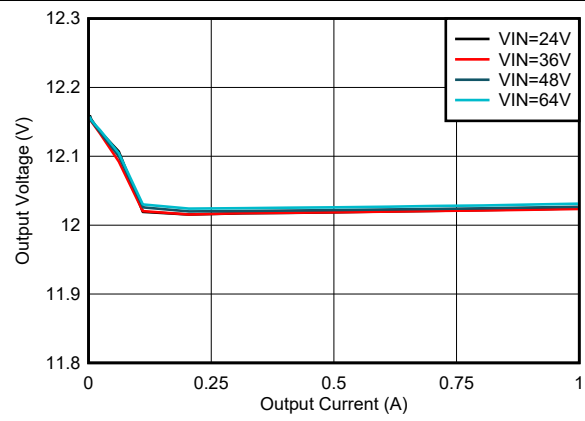

LMR38010-Q1 $V_{OUT} = 12\text{ V}$ 400 kHz
PFM Version

8-14. 12-V Load Regulation

8.3 Best Design Practices

- Do not exceed the [Absolute Maximum Ratings](#).
- Do not exceed the [Recommended Operating Conditions](#).
- Do not exceed the [ESD Ratings](#).
- Do not allow the EN input to float.
- Do not allow the output voltage to exceed the input voltage, nor go below ground.
- Follow all the guidelines and suggestions found in this data sheet before committing the design to production. TI application engineers are ready to help critique your design and PCB layout to help make your project a success.

8.4 Power Supply Recommendations

The characteristics of the input supply must be compatible with the [Absolute Maximum Ratings](#) and [Recommended Operating Conditions](#) found in this data sheet. In addition, the input supply must be capable of delivering the required input current to the loaded regulator. The average input current can be estimated with 式 16.

$$I_{IN} = \frac{V_{OUT} \times I_{OUT}}{V_{IN} \times \eta} \quad (16)$$

where

- η = efficiency

If the regulator is connected to the input supply through long wires or PCB traces, special care is required to achieve good performance. The parasitic inductance and resistance of the input cables can have an adverse effect on the operation of the regulator. The parasitic inductance, in combination with the low-ESR, ceramic input capacitors, can form an under damped resonant circuit, resulting in overvoltage transients at the input to the regulator. The parasitic resistance can cause the voltage at the VIN pin to dip whenever a load transient is applied to the output. If the application is operating close to the minimum input voltage, this dip can cause the regulator to momentarily shutdown and reset. The best way to solve these kind of issues is to reduce the distance from the input supply to the regulator, use an aluminum or tantalum input capacitor in parallel with the ceramics, or both. The moderate ESR of these types of capacitors help damp the input resonant circuit and reduce any overshoots. A value in the range of 22 μ F to 68 μ F is usually sufficient to provide input damping and help to hold the input voltage steady during large load transients.

Sometimes, for other system considerations, an input filter is used in front of the regulator. This usage can lead to instability, as well as some of the effects mentioned above, unless designed carefully. The [AN-2162 Simple Success With Conducted EMI From DCDC Converter application report](#) provides helpful suggestions when designing an input filter for any switching regulator.

In some cases, a transient voltage suppressor (TVS) is used on the input of regulators. One class of this device has a *snap-back* characteristic (thyristor type). TI does not recommend the use of a device with this type of characteristic. When the TVS fires, the clamping voltage falls to a very low value. If this voltage is less than the output voltage of the regulator, the output capacitors discharge through the device back to the input. This uncontrolled current flow can damage the device.

The input voltage must not be allowed to fall below the output voltage. In this scenario, such as a shorted input test, the output capacitors discharges through the internal parasitic diode found between the VIN and SW pins of the device. During this condition, the current can become uncontrolled, possibly causing damage to the device. If this scenario is considered likely, then use a Schottky diode between the input supply and the output.

8.5 Layout

8.5.1 Layout Guidelines

The PCB layout of any DC/DC converter is critical to the optimal performance of the design. Bad PCB layout can disrupt the operation of an otherwise good schematic design. Even if the converter regulates correctly, bad PCB

layout can mean the difference between a robust design and one that cannot be mass produced. Furthermore, the EMI performance of the regulator is dependent on the PCB layout, to a great extent. In a buck converter, the most critical PCB feature is the loop formed by the input capacitor or input capacitors, and power ground, as shown in [Figure 8-15](#). This loop carries large transient currents that can cause large transient voltages when reacting with the trace inductance. These unwanted transient voltages disrupt the proper operation of the converter. Because of this, the traces in this loop must be wide and short, and the loop area as small as possible to reduce the parasitic inductance. [Figure 8-16](#) shows a recommended layout for the critical components of the LMR38010-Q1.

- **Place the input capacitor or capacitors as close as possible to the VIN and GND terminals.** VIN and GND pins are adjacent, simplifying the input capacitor placement.
- **Place vias around the input capacitors on the VIN and GND planes.** Placing vias reduces the effective inductance and allows for a lower impedance path. Please refer to the evaluation board for guidance.
- **Use wide traces for the C_{BOOT} capacitor.** Place C_{BOOT} close to the device with short/wide traces to the BOOT and SW pins.
- **Place the feedback divider as close as possible to the FB pin of the device.** Place R_{FBB}, R_{FBT}, and C_{FF}, if used, physically close to the device. The connections to FB and GND must be short and close to those pins on the device. The connection to V_{OUT} can be somewhat longer. However, this latter trace must not be routed near any noise source (such as the SW node) that can capacitively couple into the feedback path of the regulator.
- **Use at least one ground plane in one of the middle layers.** This plane acts as a noise shield and also act as a heat dissipation path.
- **Connect the thermal pad to the ground plane.** The HSOIC package has a thermal pad (PAD) connection that must be soldered down to the PCB ground plane. This pad acts as a heat-sink connection and an electrical ground connection for the regulator. The integrity of this solder connection has a direct bearing on the total effective R_{θJA} of the application.
- **Provide wide paths for VIN, VOUT, and GND.** Making these paths as wide and direct as possible reduces any voltage drops on the input or output paths of the converter and maximizes efficiency.
- **Provide enough PCB area for proper heat sinking.** Enough copper area must be used to keep a low R_{θJA}, commensurate with the maximum load current and ambient temperature. Make the top and bottom PCB layers with two-ounce copper; and no less than one ounce. With the SOIC package, use an array of heat-sinking vias to connect the thermal pad (PAD) to the ground plane on the bottom PCB layer. If the PCB design uses multiple copper layers (recommended), thermal vias can also be connected to the inner layer heat-spreading ground planes.
- **Keep switch area small.** Keep the copper area connecting the SW pin to the inductor as short and wide as possible. At the same time the total area of this node must be minimized to help reduce radiated EMI.

See the following PCB layout resources for additional important guidelines:

- [AN-1149 Layout Guidelines for Switching Power Supplies application report](#)
- [AN-1229 Simple Switcher® PCB Layout Guidelines application report](#)
- [Construction Your Power Supply- Layout Considerations](#)
- [Low Radiated EMI Layout Made Simple with LM4360x and LM4600x application report](#)

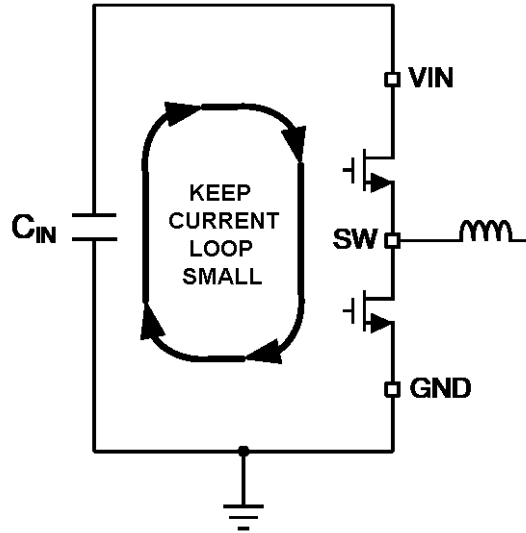



8-15. Current Loops with Fast Edges

8.5.1.1 Ground and Thermal Considerations

As mentioned above, TI recommends using one of the middle layers as a solid ground plane. A ground plane provides shielding for sensitive circuits and traces. A ground plane also provides a quiet reference potential for the control circuitry. GND pins are connected directly to the source of the low-side MOSFET switch, and also connected directly to the grounds of the input and output capacitors. The GND net contains noise at the switching frequency and can bounce due to load variations. The GND trace, as well as the VIN and SW traces, must be constrained to one side of the ground planes. The other side of the ground plane contains much less noise and must be used for sensitive routes.

TI recommends providing adequate device heat sinking by using the thermal pad (PAD) of the device as the primary thermal path. Use a minimum 4 × 3 array of 10-mil thermal vias to connect the PAD to the system ground plane heat sink. The vias must be evenly distributed under the PAD. Use as much copper as possible, for system ground plane, on the top and bottom layers for the best heat dissipation. Use a four-layer board with the copper thickness for the four layers, starting from the top as: 2 oz / 1 oz / 1 oz / 2 oz. A four-layer board with enough copper thickness, and proper layout, provides low current conduction impedance, proper shielding, and lower thermal resistance.

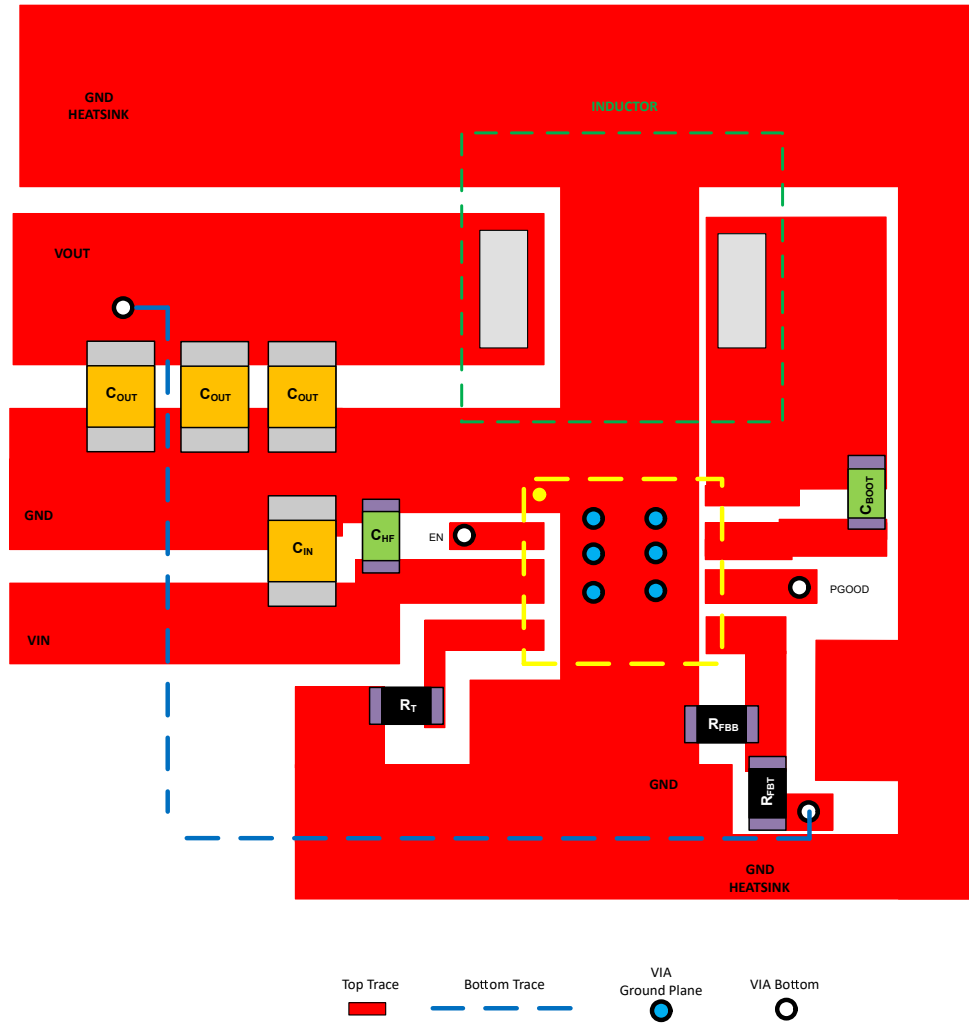
8.5.2 Layout Example



8-16. Example Layout for HSOIC (DDA) Package

9 Device and Documentation Support

9.1 Device Support

9.1.1 サード・パーティ製品に関する免責事項

サード・パーティ製品またはサービスに関するテキサス・インスツルメンツの出版物は、単独またはテキサス・インスツルメンツの製品、サービスと一緒に提供される場合に関係なく、サード・パーティ製品またはサービスの適合性に関する是認、サード・パーティ製品またはサービスの是認の表明を意味するものではありません。

9.1.2 Development Support

9.1.2.1 Custom Design With WEBENCH® Tools

[Click here](#) to create a custom design using the LMR38010-Q1 device with the WEBENCH® Power Designer.

1. Start by entering the input voltage (V_{IN}), output voltage (V_{OUT}), and output current (I_{OUT}) requirements.
2. Optimize the design for key parameters such as efficiency, footprint, and cost using the optimizer dial.
3. Compare the generated design with other possible solutions from Texas Instruments.

The WEBENCH Power Designer provides a customized schematic along with a list of materials with real-time pricing and component availability.

In most cases, these actions are available:

- Run electrical simulations to see important waveforms and circuit performance
- Run thermal simulations to understand board thermal performance
- Export customized schematic and layout into popular CAD formats
- Print PDF reports for the design, and share the design with colleagues

Get more information about WEBENCH tools at www.ti.com/WEBENCH.

9.2 Documentation Support

9.2.1 Related Documentation

For related documentation see the following:

- Texas Instruments, [AN-2162 Simple Success With Conducted EMI From DCDC Converter application report](#)
- Texas Instruments, [AN-2020 Thermal Design By Insight, Not Hindsight application report](#)
- Texas Instruments, [AN-1520 A Guide to Board Layout for Best Thermal Resistance for Exposed Packages application report](#)
- Texas Instruments, [How to Properly Evaluate Junction Temperature with Thermal Metrics application report](#)
- Texas Instruments, [Using New Thermal Metrics application report](#)
- Texas Instruments, [AN-1149 Layout Guidelines for Switching Power Supplies application report](#)
- Texas Instruments, [AN-1229 Simple Switcher® PCB Layout Guidelines application report](#)
- Texas Instruments, [Construction Your Power Supply- Layout Considerations](#)
- Texas Instruments, [Low Radiated EMI Layout Made Simple with LM4360x and LM4600x application report](#)

9.3 ドキュメントの更新通知を受け取る方法

ドキュメントの更新についての通知を受け取るには、www.tij.co.jp のデバイス製品フォルダを開いてください。[通知] をクリックして登録すると、変更されたすべての製品情報に関するダイジェストを毎週受け取ることができます。変更の詳細については、改訂されたドキュメントに含まれている改訂履歴をご覧ください。

9.4 サポート・リソース

テキサス・インスツルメンツ E2E™ サポート・フォーラムは、エンジニアが検証済みの回答と設計に関するヒントをエキスパートから迅速かつ直接得ることができる場所です。既存の回答を検索したり、独自の質問をしたりすることで、設計に必要な支援を迅速に得ることができます。

リンクされているコンテンツは、各寄稿者により「現状のまま」提供されるものです。これらはテキサス・インスツルメンツの仕様を構成するものではなく、必ずしもテキサス・インスツルメンツの見解を反映したものではありません。テキサス・インスツルメンツの[使用条件](#)を参照してください。

9.5 Trademarks

PowerPAD™ and テキサス・インスツルメンツ E2E™ are trademarks of Texas Instruments.
SIMPLE SWITCHER® and WEBENCH® are registered trademarks of Texas Instruments.
すべての商標は、それぞれの所有者に帰属します。

9.6 静電気放電に関する注意事項



この IC は、ESD によって破損する可能性があります。テキサス・インスツルメンツは、IC を取り扱う際には常に適切な注意を払うことを推奨します。正しい取り扱いおよび設置手順に従わない場合、デバイスを破損するおそれがあります。

ESD による破損は、わずかな性能低下からデバイスの完全な故障まで多岐にわたります。精密な IC の場合、パラメータがわずかに変化するだけで公表されている仕様から外れる可能性があるため、破損が発生しやすくなっています。

9.7 用語集

[テキサス・インスツルメンツ用語集](#) この用語集には、用語や略語の一覧および定義が記載されています。

10 Revision History

資料番号末尾の英字は改訂を表しています。その改訂履歴は英語版に準じています。

Changes from Revision A (May 2023) to Revision B (January 2024)	Page
• 「特長」一覧の WEBENCH のリンクを更新	1
• Updated SW to PGND less than 10-ns.....	4

Changes from Revision * (February 2023) to Revision A (May 2023)	Page
• ドキュメントのステータスを「事前情報」から「量産データ」に変更.....	1

11 Mechanical, Packaging, and Orderable Information

The following pages include mechanical, packaging, and orderable information. This information is the most current data available for the designated devices. This data is subject to change without notice and revision of this document. For browser-based versions of this data sheet, refer to the left-hand navigation.

重要なお知らせと免責事項

テキサス・インスツルメンツは、技術データと信頼性データ(データシートを含みます)、設計リソース(リファレンス デザインを含みます)、アプリケーションや設計に関する各種アドバイス、Web ツール、安全性情報、その他のリソースを、欠陥が存在する可能性のある「現状のまま」提供しており、商品性および特定目的に対する適合性の黙示保証、第三者の知的財産権の非侵害保証を含むいかなる保証も、明示的または黙示的にかかわらず拒否します。

これらのリソースは、テキサス・インスツルメンツ製品を使用する設計の経験を積んだ開発者への提供を意図したものです。(1) お客様のアプリケーションに適したテキサス・インスツルメンツ製品の選定、(2) お客様のアプリケーションの設計、検証、試験、(3) お客様のアプリケーションに該当する各種規格や、その他のあらゆる安全性、セキュリティ、規制、または他の要件への確実な適合に関する責任を、お客様のみが単独で負うものとします。

上記の各種リソースは、予告なく変更される可能性があります。これらのリソースは、リソースで説明されているテキサス・インスツルメンツ製品を使用するアプリケーションの開発の目的でのみ、テキサス・インスツルメンツはその使用をお客様に許諾します。これらのリソースに関して、他の目的で複製することや掲載することは禁止されています。テキサス・インスツルメンツや第三者の知的財産権のライセンスが付与されている訳ではありません。お客様は、これらのリソースを自身で使用した結果発生するあらゆる申し立て、損害、費用、損失、責任について、テキサス・インスツルメンツおよびその代理人を完全に補償するものとし、テキサス・インスツルメンツは一切の責任を拒否します。

テキサス・インスツルメンツの製品は、[テキサス・インスツルメンツの販売条件](#)、または [ti.com](https://www.ti.com) やかかるテキサス・インスツルメンツ製品の関連資料などのいずれかを通じて提供する適用可能な条項の下で提供されています。テキサス・インスツルメンツがこれらのリソースを提供することは、適用されるテキサス・インスツルメンツの保証または他の保証の放棄の拡大や変更を意味するものではありません。

お客様がいかなる追加条項または代替条項を提案した場合でも、テキサス・インスツルメンツはそれらに異議を唱え、拒否します。

郵送先住所: Texas Instruments, Post Office Box 655303, Dallas, Texas 75265
Copyright © 2024, Texas Instruments Incorporated

PACKAGING INFORMATION

Orderable Device	Status (1)	Package Type	Package Drawing	Pins	Package Qty	Eco Plan (2)	Lead finish/ Ball material (6)	MSL Peak Temp (3)	Op Temp (°C)	Device Marking (4/5)	Samples
LMR38010FSQDDARQ1	ACTIVE	SO PowerPAD	DDA	8	2500	RoHS & Green	NIPDAUAG	Level-2-260C-1 YEAR	-40 to 150	801FSQ	Samples
LMR38010SQDDARQ1	ACTIVE	SO PowerPAD	DDA	8	2500	RoHS & Green	NIPDAUAG	Level-2-260C-1 YEAR	-40 to 150	801SQ	Samples

(1) The marketing status values are defined as follows:

ACTIVE: Product device recommended for new designs.

LIFEBUY: TI has announced that the device will be discontinued, and a lifetime-buy period is in effect.

NRND: Not recommended for new designs. Device is in production to support existing customers, but TI does not recommend using this part in a new design.

PREVIEW: Device has been announced but is not in production. Samples may or may not be available.

OBsolete: TI has discontinued the production of the device.

(2) **RoHS:** TI defines "RoHS" to mean semiconductor products that are compliant with the current EU RoHS requirements for all 10 RoHS substances, including the requirement that RoHS substance do not exceed 0.1% by weight in homogeneous materials. Where designed to be soldered at high temperatures, "RoHS" products are suitable for use in specified lead-free processes. TI may reference these types of products as "Pb-Free".

RoHS Exempt: TI defines "RoHS Exempt" to mean products that contain lead but are compliant with EU RoHS pursuant to a specific EU RoHS exemption.

Green: TI defines "Green" to mean the content of Chlorine (Cl) and Bromine (Br) based flame retardants meet JS709B low halogen requirements of <=1000ppm threshold. Antimony trioxide based flame retardants must also meet the <=1000ppm threshold requirement.

(3) MSL, Peak Temp. - The Moisture Sensitivity Level rating according to the JEDEC industry standard classifications, and peak solder temperature.

(4) There may be additional marking, which relates to the logo, the lot trace code information, or the environmental category on the device.

(5) Multiple Device Markings will be inside parentheses. Only one Device Marking contained in parentheses and separated by a "~" will appear on a device. If a line is indented then it is a continuation of the previous line and the two combined represent the entire Device Marking for that device.

(6) Lead finish/Ball material - Orderable Devices may have multiple material finish options. Finish options are separated by a vertical ruled line. Lead finish/Ball material values may wrap to two lines if the finish value exceeds the maximum column width.

Important Information and Disclaimer:The information provided on this page represents TI's knowledge and belief as of the date that it is provided. TI bases its knowledge and belief on information provided by third parties, and makes no representation or warranty as to the accuracy of such information. Efforts are underway to better integrate information from third parties. TI has taken and continues to take reasonable steps to provide representative and accurate information but may not have conducted destructive testing or chemical analysis on incoming materials and chemicals. TI and TI suppliers consider certain information to be proprietary, and thus CAS numbers and other limited information may not be available for release.

In no event shall TI's liability arising out of such information exceed the total purchase price of the TI part(s) at issue in this document sold by TI to Customer on an annual basis.

OTHER QUALIFIED VERSIONS OF LMR38010-Q1 :

- Catalog : [LMR38010](#)

NOTE: Qualified Version Definitions:

- Catalog - TI's standard catalog product

TAPE AND REEL INFORMATION

QUADRANT ASSIGNMENTS FOR PIN 1 ORIENTATION IN TAPE

*All dimensions are nominal

Device	Package Type	Package Drawing	Pins	SPQ	Reel Diameter (mm)	Reel Width W1 (mm)	A0 (mm)	B0 (mm)	K0 (mm)	P1 (mm)	W (mm)	Pin1 Quadrant
LMR38010FSQDDARQ1	SO PowerPAD	DDA	8	2500	330.0	12.8	6.4	5.2	2.1	8.0	12.0	Q1
LMR38010SQDDARQ1	SO PowerPAD	DDA	8	2500	330.0	12.8	6.4	5.2	2.1	8.0	12.0	Q1

TAPE AND REEL BOX DIMENSIONS

*All dimensions are nominal

Device	Package Type	Package Drawing	Pins	SPQ	Length (mm)	Width (mm)	Height (mm)
LMR38010FSQDDARQ1	SO PowerPAD	DDA	8	2500	366.0	364.0	50.0
LMR38010SQDDARQ1	SO PowerPAD	DDA	8	2500	366.0	364.0	50.0

DDA (R-PDSO-G8)

PowerPAD™ PLASTIC SMALL-OUTLINE



- NOTES:
- A. All linear dimensions are in millimeters. Dimensioning and tolerancing per ASME Y14.5-1994.
 - B. This drawing is subject to change without notice.
 - C. Body dimensions do not include mold flash or protrusion not to exceed 0,15.
 - D. This package is designed to be soldered to a thermal pad on the board. Refer to Technical Brief, PowerPad Thermally Enhanced Package, Texas Instruments Literature No. SLMA002 for information regarding recommended board layout. This document is available at www.ti.com <<http://www.ti.com>>.
 - E. See the additional figure in the Product Data Sheet for details regarding the exposed thermal pad features and dimensions.
 - F. This package complies to JEDEC MS-012 variation BA

PowerPAD is a trademark of Texas Instruments.

DDA (R-PDSO-G8)

PowerPAD™ PLASTIC SMALL OUTLINE

THERMAL INFORMATION

This PowerPAD™ package incorporates an exposed thermal pad that is designed to be attached to a printed circuit board (PCB). The thermal pad must be soldered directly to the PCB. After soldering, the PCB can be used as a heatsink. In addition, through the use of thermal vias, the thermal pad can be attached directly to the appropriate copper plane shown in the electrical schematic for the device, or alternatively, can be attached to a special heatsink structure designed into the PCB. This design optimizes the heat transfer from the integrated circuit (IC).

For additional information on the PowerPAD package and how to take advantage of its heat dissipating abilities, refer to Technical Brief, PowerPAD Thermally Enhanced Package, Texas Instruments Literature No. SLMA002 and Application Brief, PowerPAD Made Easy, Texas Instruments Literature No. SLMA004. Both documents are available at www.ti.com.

The exposed thermal pad dimensions for this package are shown in the following illustration.



Exposed Thermal Pad Dimensions

4206322-6/L 05/12

NOTE: A. All linear dimensions are in millimeters

PowerPAD is a trademark of Texas Instruments



- NOTES:
- A. All linear dimensions are in millimeters.
 - B. This drawing is subject to change without notice.
 - C. Publication IPC-7351 is recommended for alternate designs.
 - D. This package is designed to be soldered to a thermal pad on the board. Refer to Technical Brief, PowerPad Thermally Enhanced Package, Texas Instruments Literature No. SLMA002, SLMA004, and also the Product Data Sheets for specific thermal information, via requirements, and recommended board layout. These documents are available at www.ti.com <<http://www.ti.com>>. Publication IPC-7351 is recommended for alternate designs.
 - E. Laser cutting apertures with trapezoidal walls and also rounding corners will offer better paste release. Customers should contact their board assembly site for stencil design recommendations. Example stencil design based on a 50% volumetric metal load solder paste. Refer to IPC-7525 for other stencil recommendations.
 - F. Customers should contact their board fabrication site for solder mask tolerances between and around signal pads.

PowerPAD is a trademark of Texas Instruments.

重要なお知らせと免責事項

TI は、技術データと信頼性データ（データシートを含みます）、設計リソース（リファレンス・デザインを含みます）、アプリケーションや設計に関する各種アドバイス、Web ツール、安全性情報、その他のリソースを、欠陥が存在する可能性のある「現状のまま」提供しており、商品性および特定目的に対する適合性の黙示保証、第三者の知的財産権の非侵害保証を含むいかなる保証も、明示的または黙示的にかかわらず拒否します。

これらのリソースは、TI 製品を使用する設計の経験を積んだ開発者への提供を意図したものです。(1) お客様のアプリケーションに適した TI 製品の選定、(2) お客様のアプリケーションの設計、検証、試験、(3) お客様のアプリケーションに該当する各種規格や、その他のあらゆる安全性、セキュリティ、規制、または他の要件への確実な適合に関する責任を、お客様のみが単独で負うものとし、

上記の各種リソースは、予告なく変更される可能性があります。これらのリソースは、リソースで説明されている TI 製品を使用するアプリケーションの開発の目的でのみ、TI はその使用をお客様に許諾します。これらのリソースに関して、他の目的で複製することや掲載することは禁止されています。TI や第三者の知的財産権のライセンスが付与されている訳ではありません。お客様は、これらのリソースを自身で使用した結果発生するあらゆる申し立て、損害、費用、損失、責任について、TI およびその代理人を完全に補償するものとし、TI は一切の責任を拒否します。

TI の製品は、[TI の販売条件](#)、または [ti.com](#) やかかる TI 製品の関連資料などのいずれかを通じて提供する適用可能な条項の下で提供されています。TI がこれらのリソースを提供することは、適用される TI の保証または他の保証の放棄の拡大や変更を意味するものではありません。

お客様がいかなる追加条項または代替条項を提案した場合でも、TI はそれらに異議を唱え、拒否します。

郵送先住所：Texas Instruments, Post Office Box 655303, Dallas, Texas 75265
Copyright © 2024, Texas Instruments Incorporated