

LPV521 ナノパワー、1.8V、RRIO、CMOS 入力オペアンプ

1 特長

- $V_S = 5V$ (特に記載のない限り標準値):
 - 電源電流 ($V_S = 0.3V$ 時): 400nA (最大値)
 - 動作電圧範囲: 1.6V~5.5V
 - 低い TCV_{OS} : 3.5 $\mu V/^\circ C$ (最大値)
 - V_{OS} : 1mV (最大値)
 - 入力バイアス電流: 40fA
 - PSRR: 109dB
 - CMRR: 102dB
 - 開ループ ゲイン: 132dB
 - ゲイン帯域幅積: 6.2kHz
 - スルーレート: 2.4V/ms
 - 入力電圧ノイズ ($f = 100Hz$ 時): 255nV/ \sqrt{Hz}
 - 温度範囲: -40 $^\circ C$ ~+125 $^\circ C$

2 アプリケーション

- ワイヤレス環境センサ
- グリッド アセット監視
- 電気メータ
- 煙探知器と熱探知器
- ガス検出器
- ポータブル エレクトロニクス
- サーモスタット
- フィールドトランスミッタとセンサ

3 概要

LPV521 は、非常に長いバッテリー寿命を必要とするアプリケーション向けに設計されたシングル ナノパワー 552nW アンプです。1.6V~5.5V の動作電圧範囲と標準 351nA の消費電流の組み合わせにより、RFID リーダーやリモートセンサなどのナノパワー アプリケーションに最適です。入力同相モード電圧はレール全体にわたって 0.1V であり、 TCV_{OS} が保証され、レール ツーレールの電圧出力性能を備えています。LPV521 の CMOS 入力段は注意深く設計され、標準で 40fA という低い I_{BIAS} 電流によって競合製品に差を付けています。この低い入力電流により、メガオーム抵抗や高インピーダンスのフォトダイオード、充電センサなどの状況で生じる、 I_{BIAS} や I_{OS} の誤差が大きく減少します。LPV521 は PowerWise® ファミリの製品であり、電力対性能比が非常に優れています。

広い入力同相モード電圧範囲、保証された 1mV の V_{OS} および 3.5 $\mu V/^\circ C$ の TCV_{OS} により、ハイサイドとローサイド両方の電流センシングで正確で安定した測定を実現します。

また、EMI 保護が組み込まれ、携帯電話や他の RFID リーダーからの不要な RF 信号による影響を低減しています。

LPV521 は、5 ピン SC70 および 8 ピン PDIP パッケージで供給されます。

パッケージ情報

| 部品番号 | パッケージ (1) | パッケージ サイズ(2) |
|--------|---------------|-----------------|
| LPV521 | DCK (SC70, 5) | 2mm × 2.1mm |
| | P (PDIP, 8) | 9.81mm × 9.43mm |

(1) 詳細については、[セクション 10](#) を参照してください。

(2) パッケージ サイズ (長さ × 幅) は公称値であり、該当する場合はピンも含まれます。

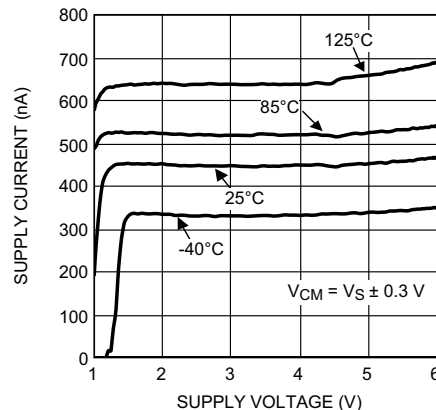

NanoPower の消費電流



Table of Contents

| | | | |
|--|-----------|--|-----------|
| 1 特長 | 1 | 7 Applications and Implementation | 19 |
| 2 アプリケーション | 1 | 7.1 Application Information..... | 19 |
| 3 概要 | 1 | 7.2 Typical Applications..... | 21 |
| 4 Pin Configuration and Functions | 2 | 7.3 Power Supply Recommendations..... | 24 |
| 5 Specifications | 3 | 7.4 Layout..... | 25 |
| 5.1 Absolute Maximum Ratings..... | 3 | 8 Device and Documentation Support | 26 |
| 5.2 ESD Ratings..... | 3 | 8.1 Device Support..... | 26 |
| 5.3 Recommended Operating Conditions..... | 3 | 8.2 Documentation Support..... | 26 |
| 5.4 Thermal Information..... | 4 | 8.3 ドキュメントの更新通知を受け取る方法..... | 26 |
| 5.5 Electrical Characteristics..... | 4 | 8.4 サポート・リソース..... | 26 |
| 5.6 Typical Characteristics..... | 8 | 8.5 Trademarks..... | 26 |
| 6 Detailed Description | 18 | 8.6 静電気放電に関する注意事項..... | 26 |
| 6.1 Overview..... | 18 | 8.7 用語集..... | 26 |
| 6.2 Functional Block Diagram..... | 18 | 9 Revision History | 27 |
| 6.3 Feature Description..... | 18 | 10 Mechanical, Packaging, and Orderable Information | 27 |
| 6.4 Device Functional Modes..... | 18 | | |

4 Pin Configuration and Functions



図 4-1. DCK Package, 5-Pin SC70 (Top View)



図 4-2. P Package, 8-Pin PDIP (Top View)

表 4-1. Pin Functions

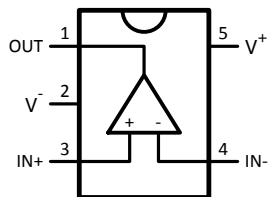
| NAME | PIN | | TYPE | DESCRIPTION |
|------|------------|----------|--------|-----------------------|
| | NO. | | | |
| | DCK (SC70) | P (PDIP) | | |
| IN+ | 3 | 3 | Input | Noninverting input |
| IN- | 4 | 2 | Input | Inverting input |
| OUT | 1 | 6 | Output | Output |
| NC | — | 1, 4, 5 | — | Do not connect |
| V+ | 5 | 8 | Power | Positive power supply |
| V- | 2 | 7 | Power | Negative power supply |

5 Specifications

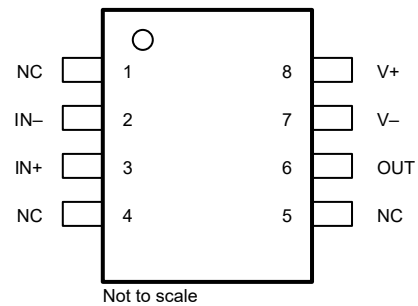
5.1 Absolute Maximum Ratings

over operating free-air temperature range (unless otherwise noted)⁽¹⁾

| | | MIN | MAX | UNIT |
|------------------|---|--------------------------------------|----------------------|------|
| | Any pin relative to V ⁻ | -0.3 | 6 | V |
| | Input voltage, IN ⁺ , IN ⁻ , OUT pins | V ⁻ - 0.3 | V ⁺ + 0.3 | V |
| | Input current, V ⁺ , V ⁻ , OUT pins | | 40 | mA |
| | Differential input voltage (V _{IN+} - V _{IN-}) | -300 | 300 | mV |
| T _J | Junction temperature ⁽²⁾ | -40 | 150 | °C |
| | Mounting temperature | Infrared or convection (30s) | 260 | °C |
| | | Wave soldering lead temperature (4s) | 260 | °C |
| T _{stg} | Storage temperature | -65 | 150 | °C |

- (1) Operation outside the *Absolute Maximum Ratings* may cause permanent device damage. *Absolute Maximum Ratings* do not imply functional operation of the device at these or any other conditions beyond those listed under *Recommended Operating Conditions*. If used outside the *Recommended Operating Conditions* but within the *Absolute Maximum Ratings*, the device may not be fully functional, and this may affect device reliability, functionality, performance, and shorten the device lifetime.
- (2) The maximum power dissipation is a function of T_J(MAX), θ_{JA}. The maximum allowable power dissipation at any ambient temperature is PD = (T_J(MAX) - T_A) / θ_{JA}. All numbers apply for packages soldered directly onto a printed circuit board (PCB).

5.2 ESD Ratings

| | | | VALUE | UNIT |
|---------------------------|-------------------------|---|-------|------|
| DCK (SC70) PACKAGE | | | | |
| V _(ESD) | Electrostatic discharge | Human-body model (HBM), per ANSI/ESDA/JEDEC JS-001 ⁽¹⁾ | ±2000 | V |
| | | Charged device model (CDM) per JEDEC specification JESD22-C101 ⁽²⁾ | ±1000 | |
| | | Machine model | ±200 | |
| P (PDIP) PACKAGE | | | | |
| V _(ESD) | Electrostatic discharge | Human-body model (HBM), per ANSI/ESDA/JEDEC JS-001 ⁽¹⁾ | ±2000 | V |
| | | Charged device model (CDM) per ANSI/ESDA/JEDEC JS-002 ⁽²⁾ | ±1000 | |
| | | Machine model | ±200 | |

- (1) JEDEC document JEP155 states that 500V HBM allows safe manufacturing with a standard ESD control process.
- (2) JEDEC document JEP157 states that 250V CDM allows safe manufacturing with a standard ESD control process.

5.3 Recommended Operating Conditions

over operating free-air temperature range (unless otherwise noted)⁽¹⁾

| | | MIN | NOM | MAX | UNIT |
|----------------|--|-----|-----|-----|------|
| V _S | Supply voltage, V _S = (V ⁺) - (V ⁻) | 1.6 | | 5.5 | V |
| T _A | Temperature ⁽²⁾ | -40 | | 125 | °C |

- (1) *Absolute Maximum Ratings* indicate limits beyond which damage may occur. *Recommended Operating Conditions* indicate conditions for which the device is intended to be functional, but specific performance is not tested. For tested specifications and test conditions, see *Electrical Characteristics*.
- (2) The maximum power dissipation is a function of T_J(MAX), θ_{JA}. The maximum allowable power dissipation at any ambient temperature is PD = (T_J(MAX) - T_A) / θ_{JA}. All numbers apply for packages soldered directly onto a PCB.

5.4 Thermal Information

| THERMAL METRIC ⁽¹⁾ | | LPV521 | | UNIT |
|-------------------------------|---|------------|----------|------|
| | | DCK (SC70) | P (PDIP) | |
| | | 5 PINS | 8 PINS | |
| $R_{\theta JA}$ | Junction-to-ambient thermal resistance ⁽²⁾ | 456 | 102.3 | °C/W |
| $R_{\theta JC(top)}$ | Junction-to-case(top) thermal resistance | 53.9 | 81.2 | °C/W |
| $R_{\theta JB}$ | Junction-to-board thermal resistance | 48.9 | 64.9 | °C/W |
| Ψ_{JT} | Junction-to-top characterization parameter | 6.6 | 47.6 | °C/W |
| Ψ_{JB} | Junction-to-board characterization parameter | 48.3 | 64.1 | °C/W |
| $R_{\theta JC(bot)}$ | Junction-to-case(bottom) thermal resistance | N/A | N/A | °C/W |

- (1) For information about traditional and new thermal metrics, see the [Semiconductor and IC Package Thermal Metrics](#) application report.
(2) The maximum power dissipation is a function of $T_J(MAX)$, θ_{JA} . The maximum allowable power dissipation at any ambient temperature is $P_D = (T_J(MAX) - T_A) / \theta_{JA}$. All numbers apply for packages soldered directly onto a PCB.

5.5 Electrical Characteristics

at $T_A = 25^\circ\text{C}$, $V^+ = 1.8\text{V}$, 3.3V , and 5V , $V^- = 0\text{V}$, $V_{CM} = V_O = V_S / 2$, and $R_L > 1\text{M}\Omega$ (unless otherwise noted)⁽¹⁾

| PARAMETER | | TEST CONDITIONS | | MIN | TYP | MAX | UNIT |
|---------------------------|---|---|--|-------|-----------|------|------------------------------|
| OFFSET VOLTAGE | | | | | | | |
| V_{OS} | Input offset voltage | $V_{CM} = V^- + 0.3\text{V}$ | | -1 | 0.1 | 1 | mV |
| | | | $T_A = -40^\circ\text{C to } +125^\circ\text{C}$ | -1.23 | | 1.23 | |
| | | $V_{CM} = V^+ - 0.3\text{V}$ | | -1 | 0.1 | 1 | |
| | | | $T_A = -40^\circ\text{C to } +125^\circ\text{C}$ | -1.23 | | 1.23 | |
| TCV_{OS} | Input offset voltage drift ⁽²⁾ | $T_A = -40^\circ\text{C to } +125^\circ\text{C}$ | $V^+ = 1.8\text{V}, 3.3\text{V}$ | | ± 0.4 | | $\mu\text{V}/^\circ\text{C}$ |
| | | | $V^+ = 5\text{V}$ | -3 | | 3 | |
| | | | | -3.5 | | 3.5 | |
| PSRR | Power-supply rejection ratio | $1.6\text{V} \leq V^+ \leq 5.5\text{V}$, $V_{CM} = 0.3\text{V}$ | | 85 | 109 | | dB |
| | | | $T_A = -40^\circ\text{C to } +125^\circ\text{C}$ | 76 | | | |
| INPUT BIAS CURRENT | | | | | | | |
| I_{BIAS} | Input bias current | $V^+ = 1.8\text{V}, 3.3\text{V}$ | | -1 | 0.01 | 1 | pA |
| | | | $V^+ = 5\text{V}$ | -1 | 0.04 | 1 | |
| | | | $T_A = -40^\circ\text{C to } +125^\circ\text{C}$ | -50 | | +50 | |
| I_{OS} | Input offset current | $V^+ = 1.8\text{V}$ | | | 10 | | fA |
| | | | $V^+ = 3.3\text{V}$ | | 20 | | |
| | | | $V^+ = 5\text{V}$ | | 60 | | |
| NOISE | | | | | | | |
| | Input-referred voltage noise | $V^+ = 1.8\text{V}$ | | | 24 | | μV_{PP} |
| | | | $V^+ = 3.3\text{V}, 5\text{V}$ | | 22 | | |
| e_n | Input-referred voltage noise density | $f = 100\text{Hz}$ | $V^+ = 1.8\text{V}$ | | 265 | | $\text{nV}/\sqrt{\text{Hz}}$ |
| | | | $V^+ = 3.3\text{V}$ | | 259 | | |
| | | | $V^+ = 5\text{V}$ | | 255 | | |
| i_n | Input-referred current noise | $f = 100\text{Hz}$ | | | 100 | | $\text{fA}/\sqrt{\text{Hz}}$ |

5.5 Electrical Characteristics (続き)

at $T_A = 25^\circ\text{C}$, $V^+ = 1.8\text{V}$, 3.3V , and 5V , $V^- = 0\text{V}$, $V_{\text{CM}} = V_O = V_S / 2$, and $R_L > 1\text{M}\Omega$ (unless otherwise noted)⁽¹⁾

| PARAMETER | | TEST CONDITIONS | | MIN | TYP | MAX | UNIT |
|---|-----------------------------|---|---|---------------|-----|---------------|------|
| INPUT VOLTAGE | | | | | | | |
| CMRR | Common-mode rejection ratio | $V^- \leq V_{\text{CM}} \leq V^+$ | $V^+ = 1.8\text{V}$ | 66 | 92 | dB | |
| | | | $V^+ = 1.8\text{V}, T_A = -40^\circ\text{C to } +125^\circ\text{C}$ | 60 | | | |
| | | | $V^+ = 3.3\text{V}$ | 72 | 97 | | |
| | | | $V^+ = 3.3\text{V}, T_A = -40^\circ\text{C to } +125^\circ\text{C}$ | 70 | | | |
| | | | $V^+ = 5\text{V}$ | 75 | 102 | | |
| | | | $V^+ = 5\text{V}, T_A = -40^\circ\text{C to } +125^\circ\text{C}$ | 74 | | | |
| | | $V^- \leq V_{\text{CM}} \leq V^+ - 1.1\text{V}$ | $V^+ = 1.8\text{V}$ | 75 | 101 | | |
| | | | $V^+ = 1.8\text{V}, T_A = -40^\circ\text{C to } +125^\circ\text{C}$ | 74 | | | |
| | | | $V^+ = 3.3\text{V}$ | 78 | 106 | | |
| | | | $V^+ = 3.3\text{V}, T_A = -40^\circ\text{C to } +125^\circ\text{C}$ | 75 | | | |
| | | | $V^+ = 5\text{V}$ | 84 | 108 | | |
| | | | $V^+ = 5\text{V}, T_A = -40^\circ\text{C to } +125^\circ\text{C}$ | 80 | | | |
| | | $V^+ - 0.6\text{V} \leq V_{\text{CM}} \leq V^+$ | $V^+ = 1.8\text{V}$ | 75 | 120 | | |
| | | | $V^+ = 1.8\text{V}, T_A = -40^\circ\text{C to } +125^\circ\text{C}$ | 53 | | | |
| | | | $V^+ = 3.3\text{V}$ | 77 | 121 | | |
| $V^+ = 3.3\text{V}, T_A = -40^\circ\text{C to } +125^\circ\text{C}$ | 76 | | | | | | |
| $V^+ = 5\text{V}$ | 77 | | 115 | | | | |
| $V^+ = 5\text{V}, T_A = -40^\circ\text{C to } +125^\circ\text{C}$ | 76 | | | | | | |
| CMVR | Common-mode voltage range | $V^+ = 1.8\text{V}$, CMRR $\geq 67\text{dB}$, $V^+ = 3.3\text{V}$, CMRR $\geq 72\text{dB}$, $V^+ = 5\text{V}$, CMRR $\geq 75\text{dB}$ | | $(V^-) - 0.1$ | | $(V^+) + 0.1$ | V |
| | | $T_A = -40^\circ\text{C to } +125^\circ\text{C}$, $V^+ = 1.8\text{V}$, CMRR $\geq 60\text{dB}$, $V^+ = 3.3\text{V}$, CMRR $\geq 70\text{dB}$, $V^+ = 5\text{V}$, CMRR $\geq 74\text{dB}$ | | (V^-) | | (V^+) | V |
| OPEN-LOOP GAIN | | | | | | | |
| A_{VOL} | Large-signal voltage gain | $V^- + 0.5\text{V} \leq V_O \leq V^+ - 0.5\text{V}$, $R_L = 100\text{k}\Omega$ to $V^+/2$ | $V^+ = 1.8\text{V}$ | 74 | 125 | dB | |
| | | | $V^+ = 1.8\text{V}, T_A = -40^\circ\text{C to } +125^\circ\text{C}$ | 73 | | | |
| | | | $V^+ = 3.3\text{V}$ | 82 | 120 | | |
| | | | $V^+ = 3.3\text{V}, T_A = -40^\circ\text{C to } +125^\circ\text{C}$ | 76 | | | |
| | | | $V^+ = 5\text{V}$ | 84 | 132 | | |
| | | | $V^+ = 5\text{V}, T_A = -40^\circ\text{C to } +125^\circ\text{C}$ | 76 | | | |
| FREQUENCY RESPONSE | | | | | | | |
| GBW | Gain bandwidth product | $C_L = 20\text{pF}$, $R_L = 100\text{k}\Omega$ | $V^+ = 1.8\text{V}$ | | 6.1 | kHz | |
| | | | $V^+ = 3.3\text{V}, 5\text{V}$ | | 6.2 | | |
| SR | Slew rate | Falling edge, $A_V = +1$, $V_{\text{IN}} = V^+$ to V^- | $V^+ = 1.8\text{V}$ | | 2.9 | V/ms | |
| | | | $V^+ = 3.3\text{V}$ | | 2.9 | | |
| | | | $V^+ = 5\text{V}$ | 1.1 | 2.7 | | |
| | | | $V^+ = 5\text{V}, T_A = -40^\circ\text{C to } +125^\circ\text{C}$ | 1.2 | | | |
| | | Rising edge, $A_V = +1$, $V_{\text{IN}} = V^-$ to V^+ | $V^+ = 1.8\text{V}$ | | 2.3 | | |
| | | | $V^+ = 3.3\text{V}$ | | 2.5 | | |
| | | | $V^+ = 5\text{V}$ | 1.1 | 2.4 | | |
| | | | $V^+ = 5\text{V}, T_A = -40^\circ\text{C to } +125^\circ\text{C}$ | 1.2 | | | |
| θ_m | Phase margin | $C_L = 20\text{pF}$, $R_L = 100\text{k}\Omega$ | $V^+ = 1.8\text{V}$ | | 72 | deg | |
| | | | $V^+ = 3.3\text{V}, 5\text{V}$ | | 73 | | |
| G_m | Gain margin | $C_L = 20\text{pF}$, $R_L = 100\text{k}\Omega$ | $V^+ = 1.8\text{V}, 3.3\text{V}$ | | 19 | dB | |
| | | | $V^+ = 5\text{V}$ | | 20 | | |

5.5 Electrical Characteristics (続き)

at $T_A = 25^\circ\text{C}$, $V^+ = 1.8\text{V}, 3.3\text{V}, \text{ and } 5\text{V}$, $V^- = 0\text{V}$, $V_{\text{CM}} = V_O = V_S / 2$, and $R_L > 1\text{ M}\Omega$ (unless otherwise noted)⁽¹⁾

| PARAMETER | | TEST CONDITIONS | | MIN | TYP | MAX | UNIT |
|---------------|-------------------------------|---|---|-----|-----|-----|------|
| OUTPUT | | | | | | | |
| V_O | Output voltage | Swing from positive rail, $R_L = 100\text{k}\Omega$ to $V^+/2$, $V_{\text{IN}}(\text{diff}) = 100\text{mV}$ | $V^+ = 1.8\text{V}$ | | 2 | 50 | mV |
| | | | $V^+ = 1.8\text{V}, T_A = -40^\circ\text{C to } +125^\circ\text{C}$ | | | 50 | |
| | | | $V^+ = 3.3\text{V}$ | | 3 | 50 | |
| | | | $V^+ = 3.3\text{V}, T_A = -40^\circ\text{C to } +125^\circ\text{C}$ | | | 50 | |
| | | | $V^+ = 5\text{V}$ | | 3 | 50 | |
| | | | $V^+ = 5\text{V}, T_A = -40^\circ\text{C to } +125^\circ\text{C}$ | | | 50 | |
| | | Swing from negative rail, $R_L = 100\text{k}\Omega$ to $V^+/2$, $V_{\text{IN}}(\text{diff}) = -100\text{mV}$ | $V^+ = 1.8\text{V}$ | | 2 | 50 | |
| | | | $V^+ = 1.8\text{V}, T_A = -40^\circ\text{C to } +125^\circ\text{C}$ | | | 50 | |
| | | | $V^+ = 3.3\text{V}$ | | 2 | 50 | |
| | | | $V^+ = 3.3\text{V}, T_A = -40^\circ\text{C to } +125^\circ\text{C}$ | | | 50 | |
| | | | $V^+ = 5\text{V}$ | | 3 | 50 | |
| | | | $V^+ = 5\text{V}, T_A = -40^\circ\text{C to } +125^\circ\text{C}$ | | | 50 | |
| I_O | Output current ⁽³⁾ | Sourcing, V_O to V^- , $V_{\text{IN}}(\text{diff}) = 100\text{mV}$ | $V^+ = 1.8\text{V}$ | 1 | 3 | | mA |
| | | | $V^+ = 1.8\text{V}, T_A = -40^\circ\text{C to } +125^\circ\text{C}$ | 0.5 | | | |
| | | | $V^+ = 3.3\text{V}$ | 5 | 11 | | |
| | | | $V^+ = 3.3\text{V}, T_A = -40^\circ\text{C to } +125^\circ\text{C}$ | 4 | | | |
| | | | $V^+ = 5\text{V}$ | 15 | 23 | | |
| | | | $V^+ = 5\text{V}, T_A = -40^\circ\text{C to } +125^\circ\text{C}$ | 8 | | | |
| | | Sinking, V_O to V^+ , $V_{\text{IN}}(\text{diff}) = -100\text{mV}$ | $V^+ = 1.8\text{V}$ | 1 | 3 | | |
| | | | $V^+ = 1.8\text{V}, T_A = -40^\circ\text{C to } +125^\circ\text{C}$ | 0.5 | | | |
| | | | $V^+ = 3.3\text{V}$ | 5 | 12 | | |
| | | | $V^+ = 3.3\text{V}, T_A = -40^\circ\text{C to } +125^\circ\text{C}$ | 4 | | | |
| | | | $V^+ = 5\text{V}$ | 15 | 22 | | |
| | | | $V^+ = 5\text{V}, T_A = -40^\circ\text{C to } +125^\circ\text{C}$ | 8 | | | |

5.5 Electrical Characteristics (続き)

at $T_A = 25^\circ\text{C}$, $V^+ = 1.8\text{V}$, 3.3V , and 5V , $V^- = 0\text{V}$, $V_{\text{CM}} = V_O = V_S / 2$, and $R_L > 1\text{M}\Omega$ (unless otherwise noted)⁽¹⁾

| PARAMETER | | TEST CONDITIONS | | MIN | TYP | MAX | UNIT | |
|-----------------------|---|--|---|-----|-----|-----|------|----|
| POWER SUPPLY | | | | | | | | |
| I_S | Supply current | $V_{\text{CM}} = V^- + 0.3\text{V}$ | $V^+ = 1.8\text{V}$ | | 345 | 400 | nA | |
| | | | $V^+ = 1.8\text{V}, T_A = -40^\circ\text{C to } +125^\circ\text{C}$ | | | | 580 | nA |
| | | | $V^+ = 3.3\text{V}$ | | 346 | 400 | nA | |
| | | | $V^+ = 3.3\text{V}, T_A = -40^\circ\text{C to } +125^\circ\text{C}$ | | | | 600 | nA |
| | | | $V^+ = 5\text{V}$ | | 351 | 400 | nA | |
| | | | $V^+ = 5\text{V}, T_A = -40^\circ\text{C to } +125^\circ\text{C}$ | | | | 620 | nA |
| | | $V_{\text{CM}} = V^+ - 0.3\text{V}$ | $V^+ = 1.8\text{V}$ | | 472 | 600 | nA | |
| | | | $V^+ = 1.8\text{V}, T_A = -40^\circ\text{C to } +125^\circ\text{C}$ | | | | 850 | nA |
| | | | $V^+ = 3.3\text{V}$ | | 471 | 600 | nA | |
| | | | $V^+ = 3.3\text{V}, T_A = -40^\circ\text{C to } +125^\circ\text{C}$ | | | | 860 | nA |
| | | | $V^+ = 5\text{V}$ | | 475 | 600 | nA | |
| | | | $V^+ = 5\text{V}, T_A = -40^\circ\text{C to } +125^\circ\text{C}$ | | | | 870 | nA |
| NOISE IMMUNITY | | | | | | | | |
| EMIRR | EMI rejection ratio, IN+ and IN- ⁽⁴⁾ | $V^+ = 5\text{V}, V_{\text{RF_PEAK}} = 100\text{mV}_P (-20\text{dB}_P)$ | $f = 400\text{MHz}$ | | 121 | | dB | |
| | | | $f = 900\text{MHz}$ | | 121 | | | |
| | | | $f = 1800\text{MHz}$ | | 124 | | | |
| | | | $f = 2400\text{MHz}$ | | 142 | | | |

- (1) *Electrical Characteristics* values apply only for factory testing conditions at the temperature indicated. Factory testing conditions result in very limited self-heating of the device such that $T_J = T_A$. No min and max specifications of parametric performance are indicated in the electrical tables under conditions of internal self-heating where $T_J > T_A$. *Absolute Maximum Ratings* indicate junction temperature limits beyond which the device may be permanently degraded, either mechanically or electrically.
- (2) The offset voltage average drift is determined by dividing the change in V_{OS} at the temperature extremes by the total temperature change.
- (3) The short circuit test is a momentary open-loop test.
- (4) The EMI rejection ratio is defined as $\text{EMIRR} = 20\log(V_{\text{RF_PEAK}}/\Delta V_{\text{OS}})$.

5.6 Typical Characteristics

at $T_J = 25^\circ\text{C}$ (unless otherwise specified)

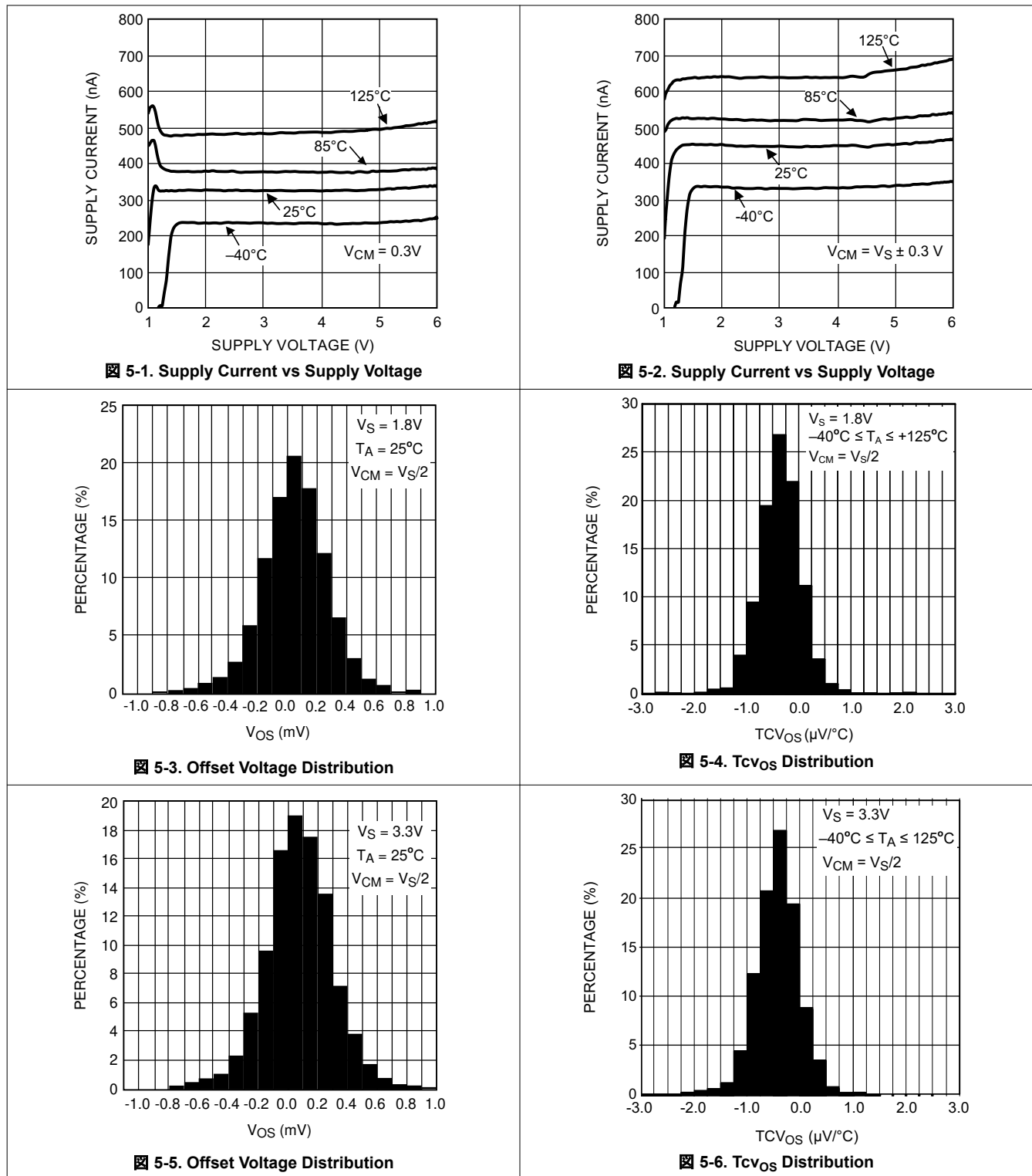

5.6 Typical Characteristics (continued)

at $T_J = 25^\circ\text{C}$ (unless otherwise specified)



図 5-7. Offset Voltage Distribution



図 5-8. TcvOss Distribution

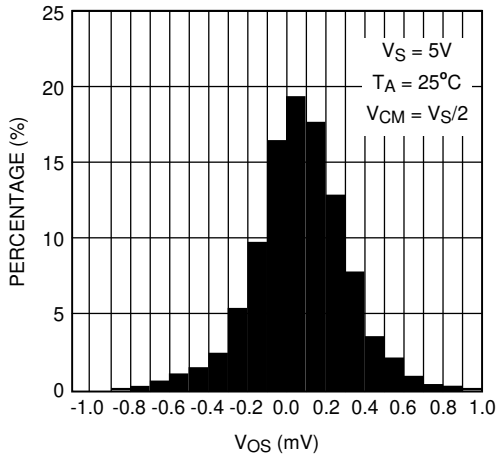

図 5-9. Input Offset Voltage vs Input Common Mode

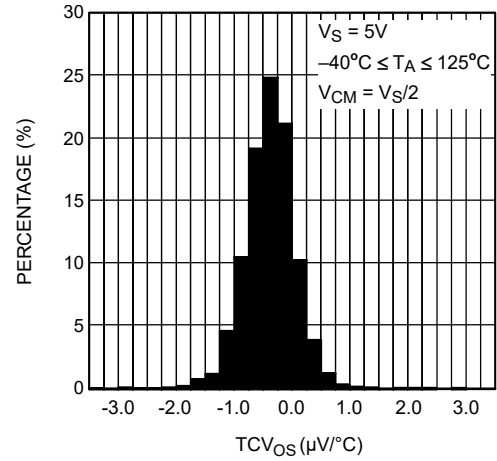

図 5-10. Input Offset Voltage vs Input Common Mode

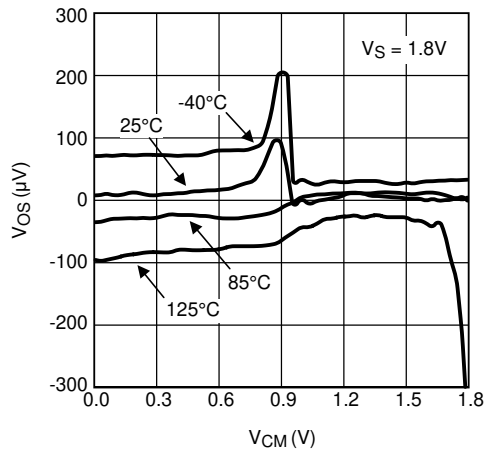

図 5-11. Input Offset Voltage vs Input Common Mode

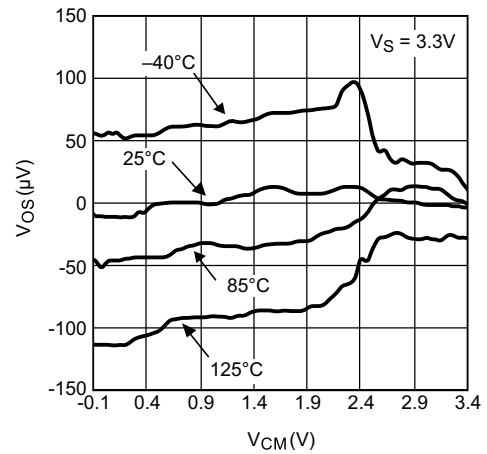

図 5-12. Input Offset Voltage vs Supply Voltage

5.6 Typical Characteristics (continued)

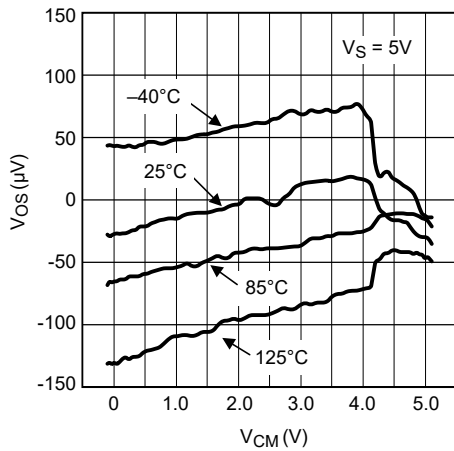
at $T_J = 25^\circ\text{C}$ (unless otherwise specified)

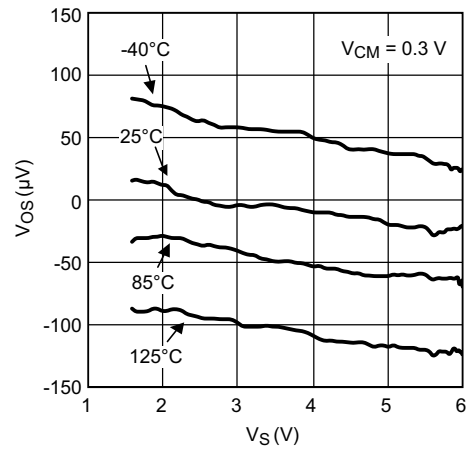

图 5-13. Input Offset Voltage vs Supply Voltage



图 5-14. Input Offset Voltage vs Output Voltage

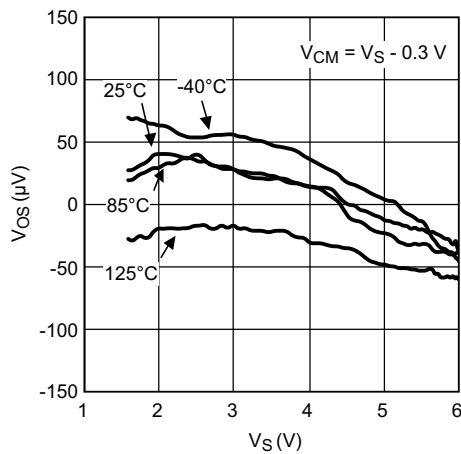

图 5-15. Input Offset Voltage vs Output Voltage

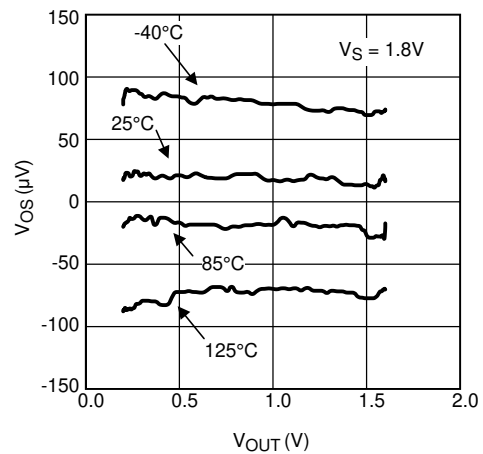

图 5-16. Input Offset Voltage vs Output Voltage

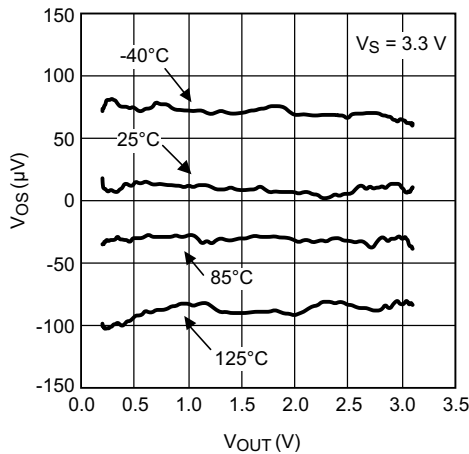

图 5-17. Input Offset Voltage vs Sourcing Current

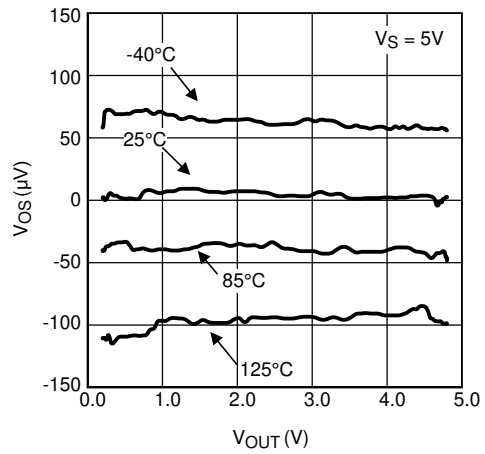

图 5-18. Input Offset Voltage vs Sourcing Current

5.6 Typical Characteristics (continued)

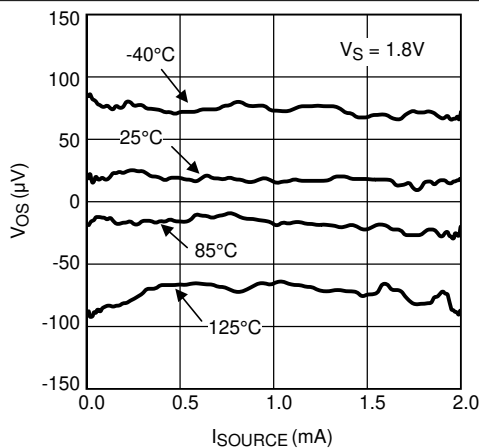
at $T_J = 25^\circ\text{C}$ (unless otherwise specified)

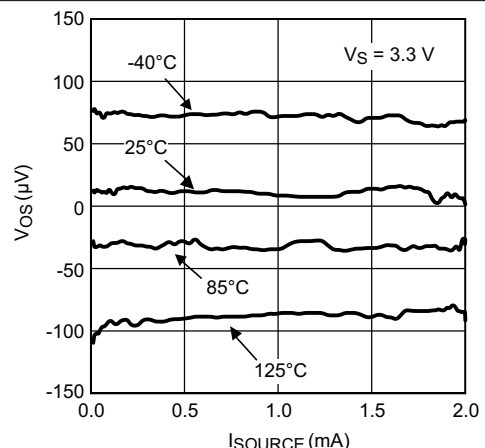

图 5-19. Input Offset Voltage vs Sourcing Current



图 5-20. Input Offset Voltage vs Sinking Current

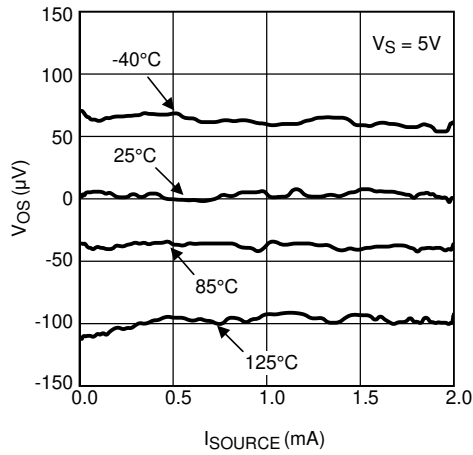

图 5-21. Input Offset Voltage vs Sinking Current

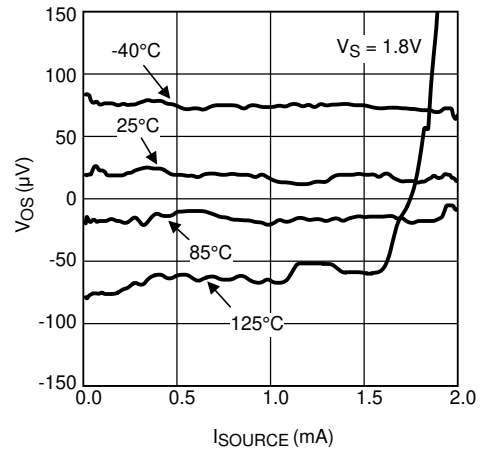

图 5-22. Input Offset Voltage vs Sinking Current

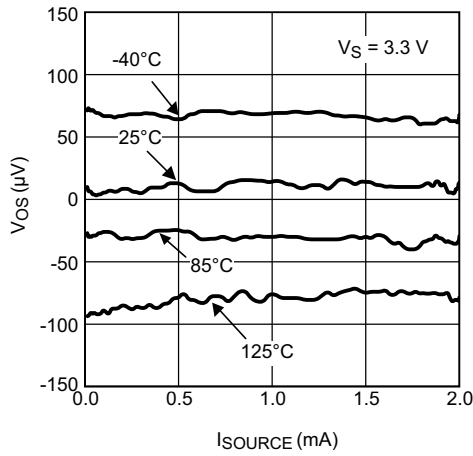

图 5-23. Sourcing Current vs Output Voltage

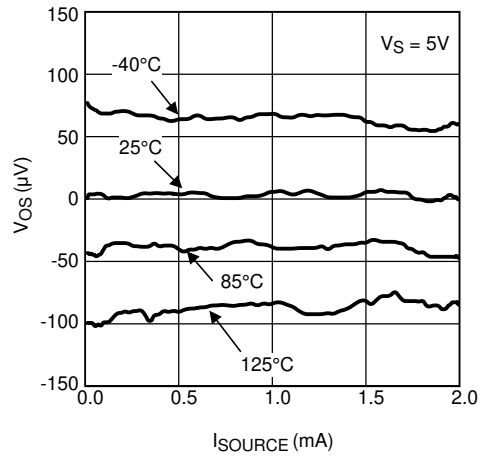

图 5-24. Sinking Current vs Output Voltage

5.6 Typical Characteristics (continued)

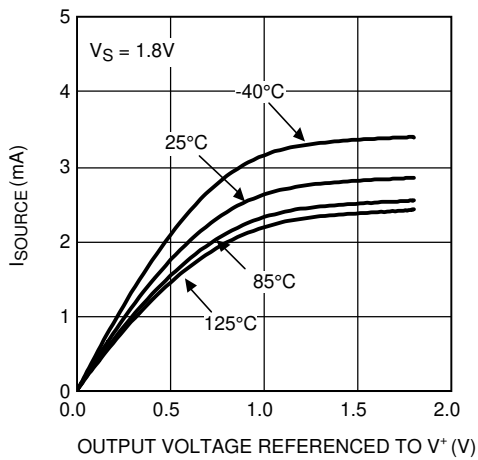
at $T_J = 25^\circ\text{C}$ (unless otherwise specified)

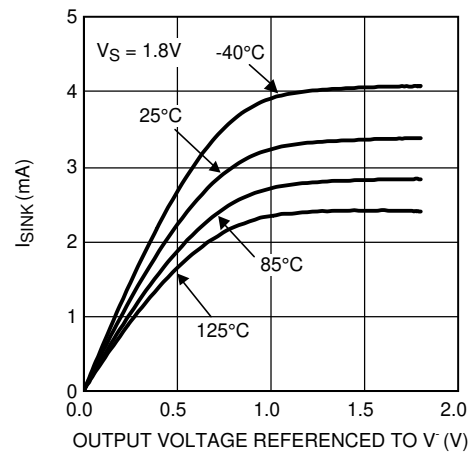
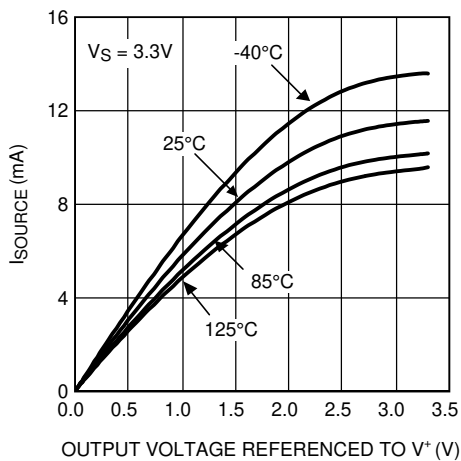

5-25. Sourcing Current vs Output Voltage

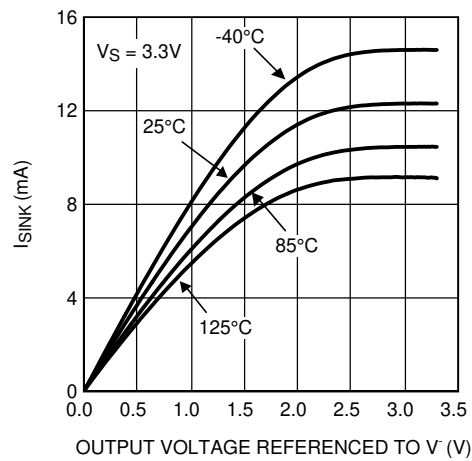

5-26. Sinking Current vs Output Voltage

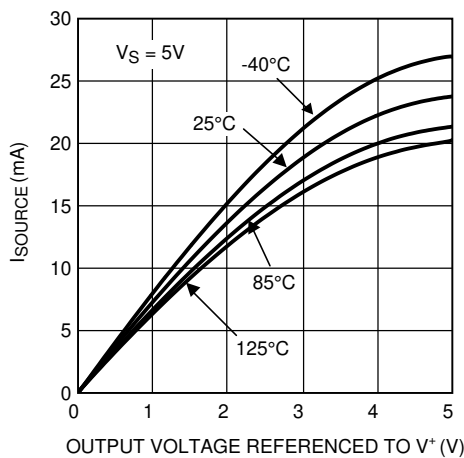

5-27. Sourcing Current vs Output Voltage

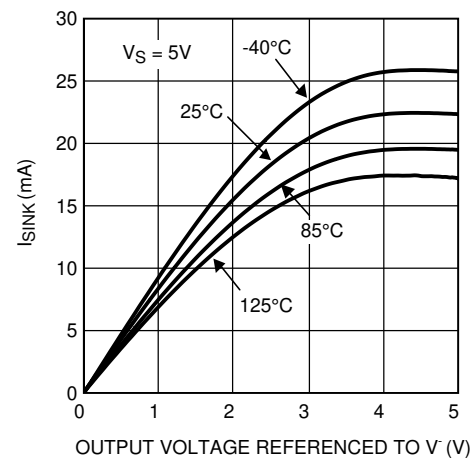

5-28. Sinking Current vs Output Voltage

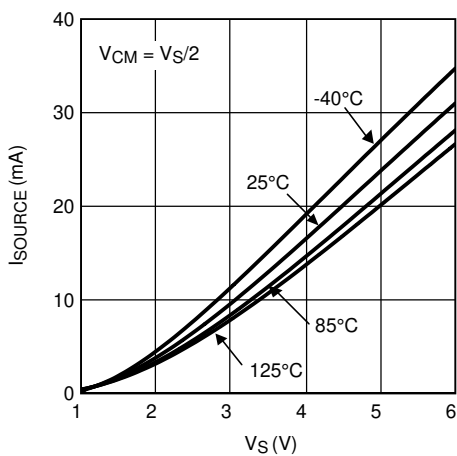

5-29. Sourcing Current vs Supply Voltage

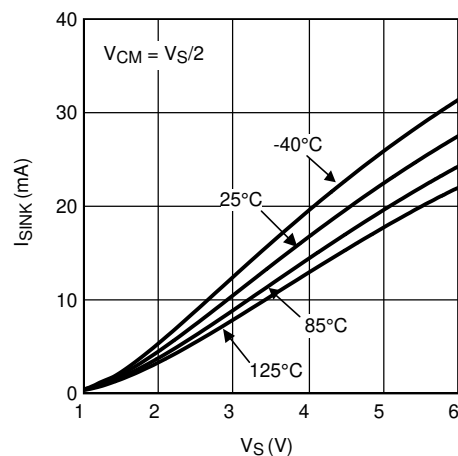

5-30. Sinking Current vs Supply Voltage

5.6 Typical Characteristics (continued)

at $T_J = 25^\circ\text{C}$ (unless otherwise specified)

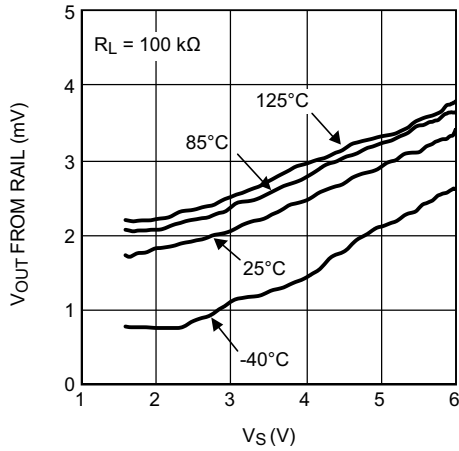

5-31. Output Swing High vs Supply Voltage

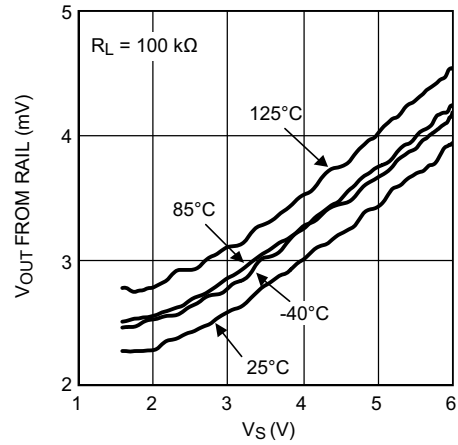

5-32. Output Swing Low vs Supply Voltage

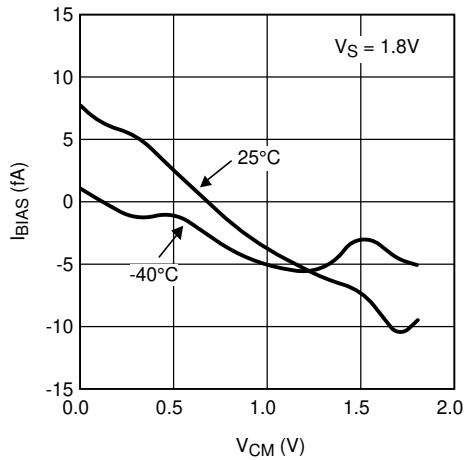

5-33. Input Bias Current vs Common Mode Voltage

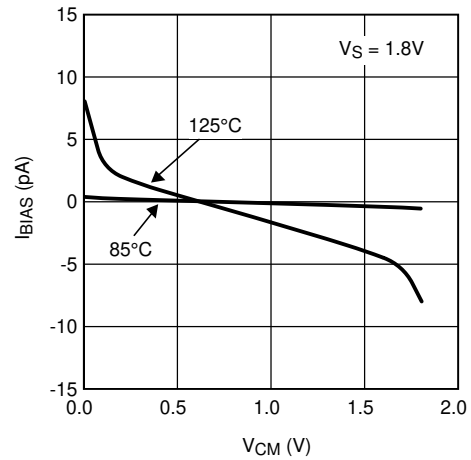

5-34. Input Bias Current vs Common Mode Voltage

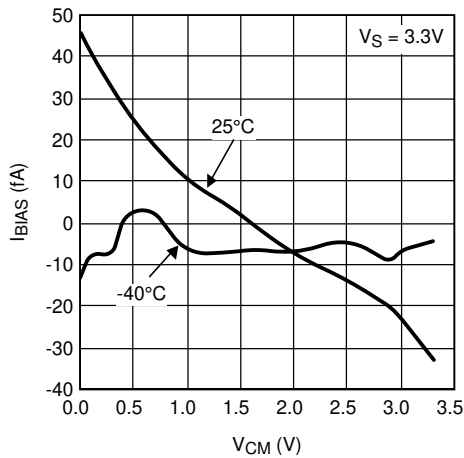

5-35. Input Bias Current vs Common Mode Voltage

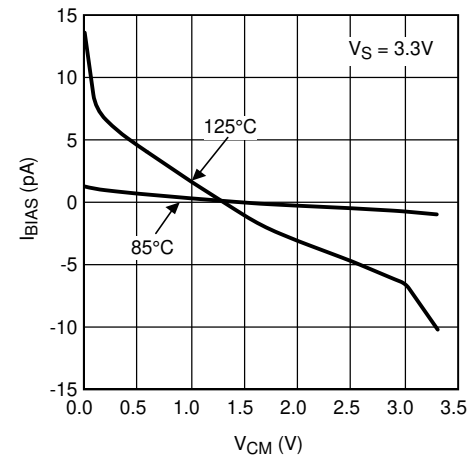

5-36. Input Bias Current vs Common Mode Voltage

5.6 Typical Characteristics (continued)

at $T_J = 25^\circ\text{C}$ (unless otherwise specified)

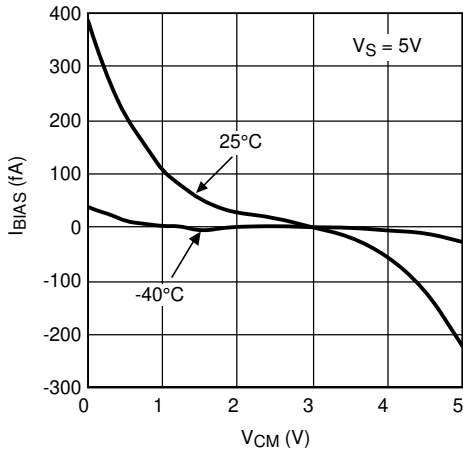

5-37. Input Bias Current vs Common Mode Voltage

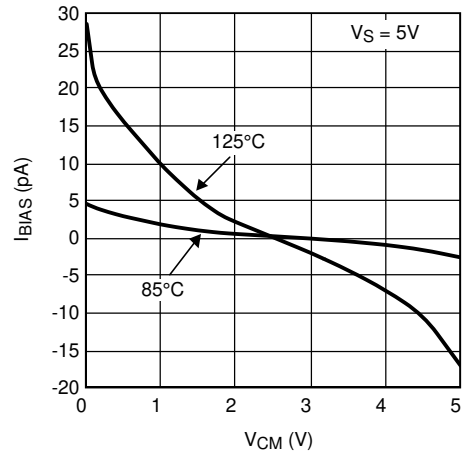

5-38. Input Bias Current vs Common Mode Voltage

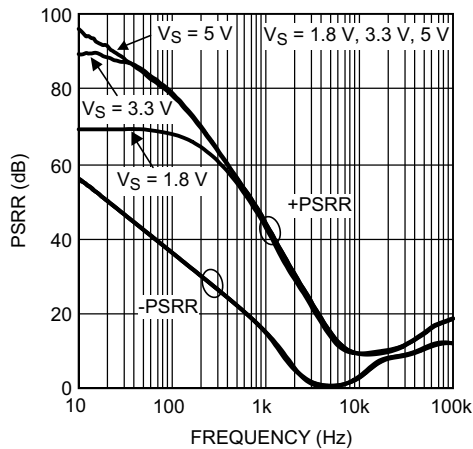

5-39. PSRR vs Frequency

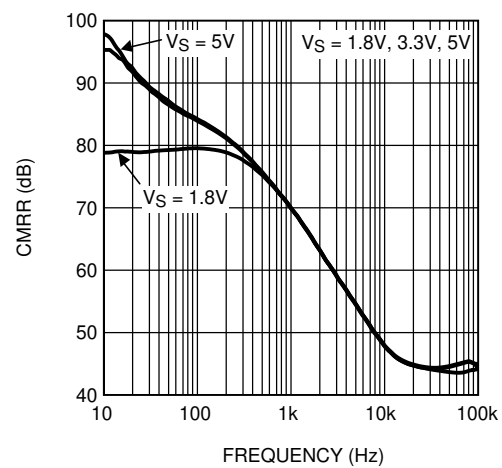

5-40. CMRR vs Frequency

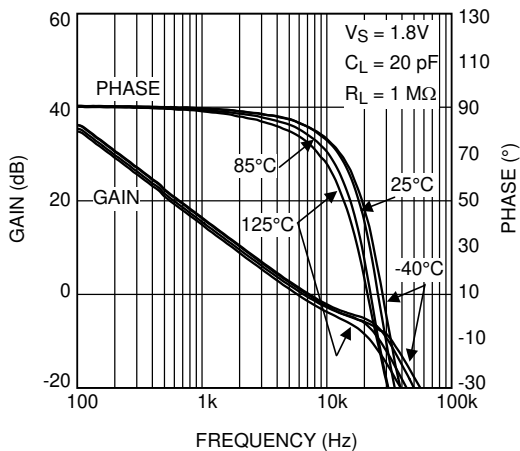

5-41. Frequency Response vs Temperature

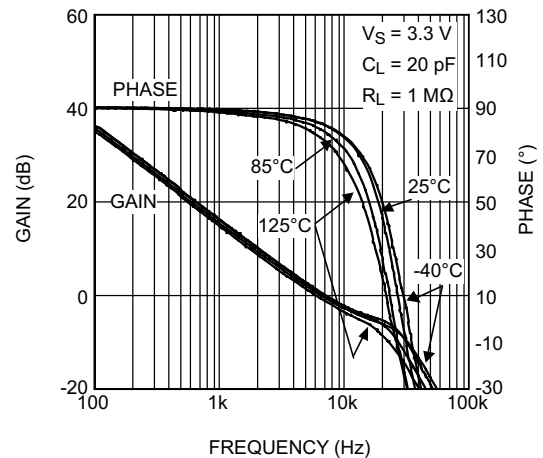

5-42. Frequency Response vs Temperature

5.6 Typical Characteristics (continued)

at $T_J = 25^\circ\text{C}$ (unless otherwise specified)



図 5-43. Frequency Response vs Temperature



図 5-44. Frequency Response vs R_L

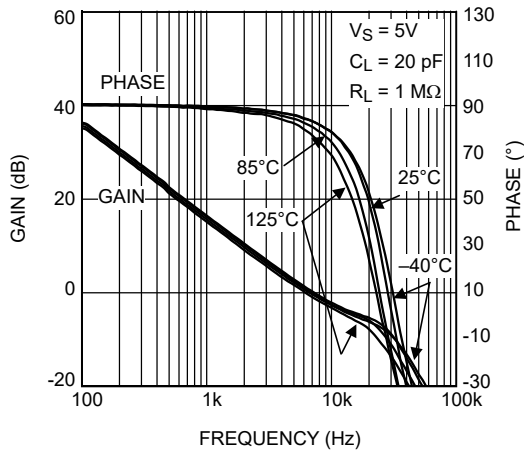

図 5-45. Frequency Response vs R_L

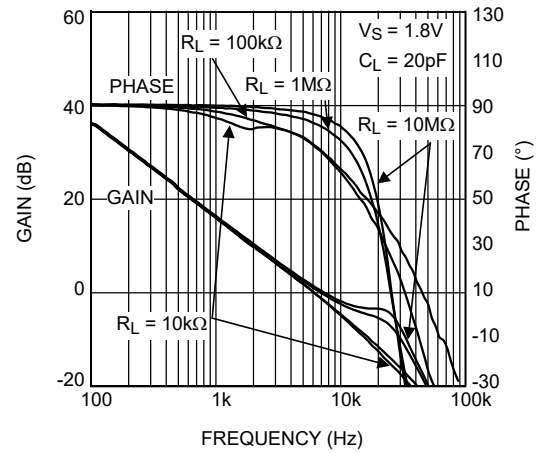

図 5-46. Frequency Response vs R_L

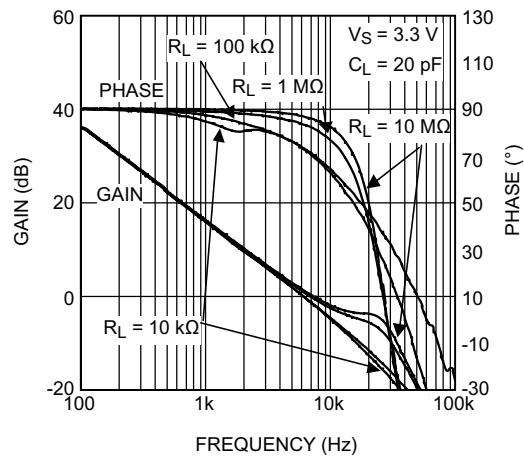

図 5-47. Frequency Response vs C_L

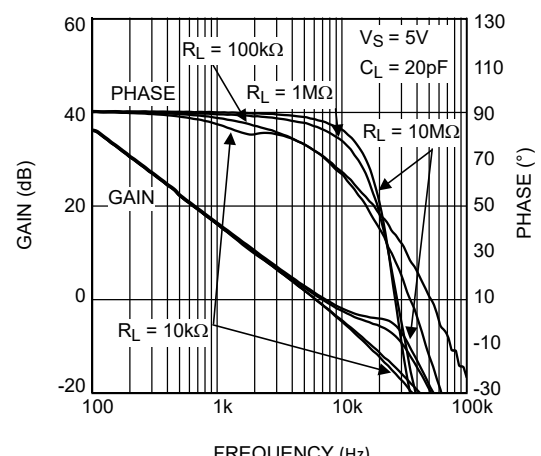

図 5-48. Frequency Response vs C_L

5.6 Typical Characteristics (continued)

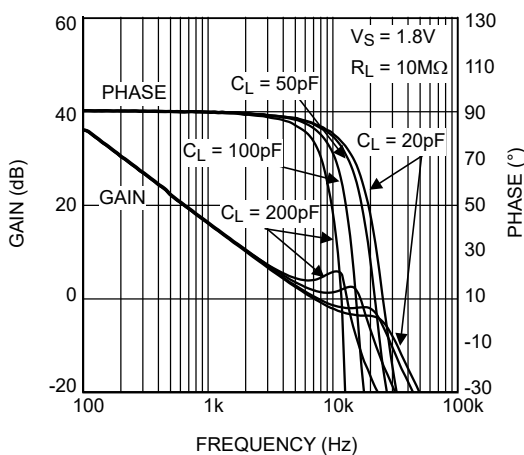
at $T_J = 25^\circ\text{C}$ (unless otherwise specified)

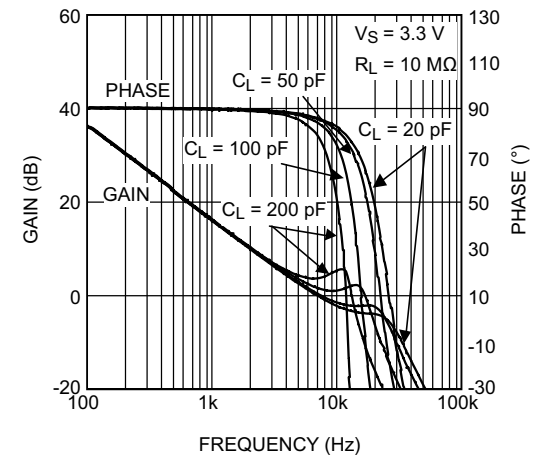
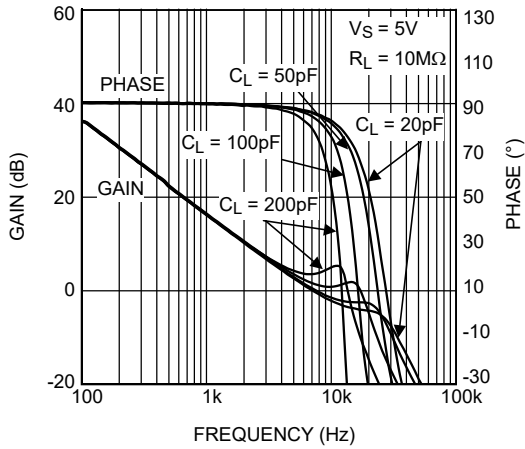

Figure 5-49. Frequency Response vs C_L

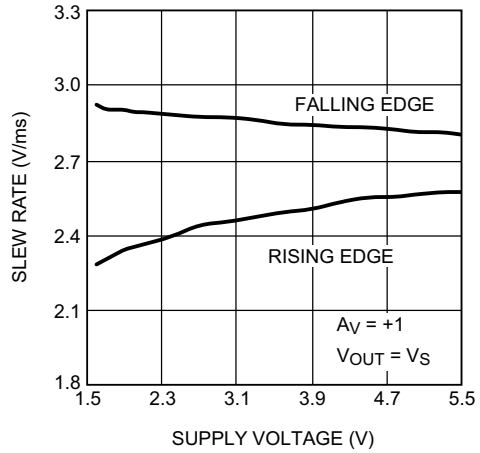

Figure 5-50. Slew Rate vs Supply Voltage

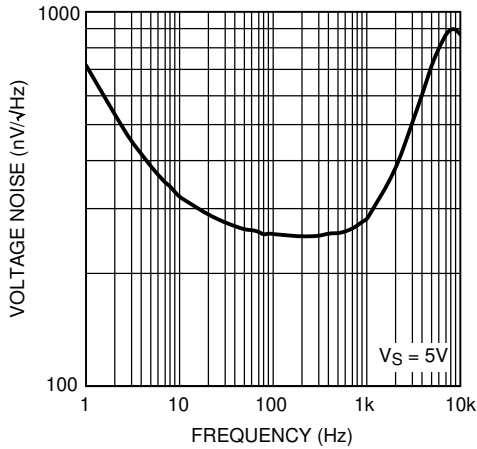

Figure 5-51. Voltage Noise vs Frequency

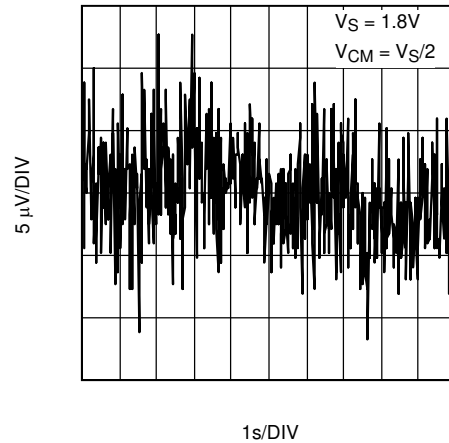

Figure 5-52. 0.1-Hz to 10-Hz Time Domain Voltage Noise

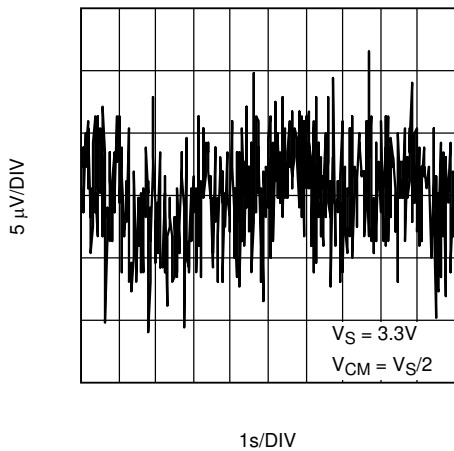

Figure 5-53. 0.1-Hz to 10-Hz Time Domain Voltage Noise

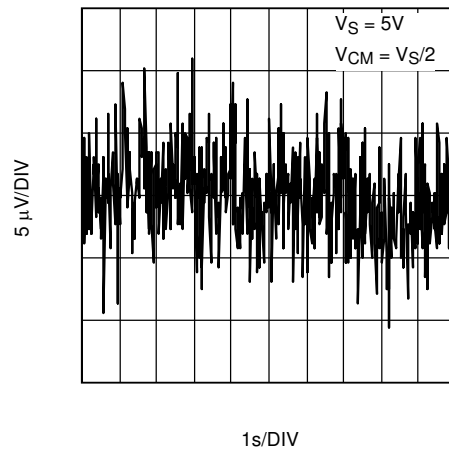
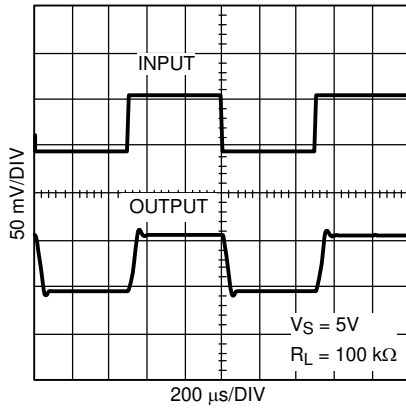

Figure 5-54. 0.1-Hz to 10-Hz Time Domain Voltage Noise

5.6 Typical Characteristics (continued)

at $T_J = 25^\circ\text{C}$ (unless otherwise specified)



5-55. Small-Signal Pulse Response

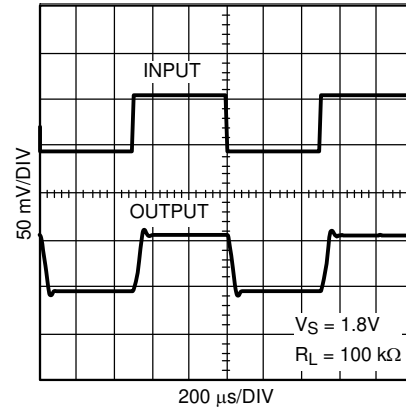

5-56. Small-Signal Pulse Response

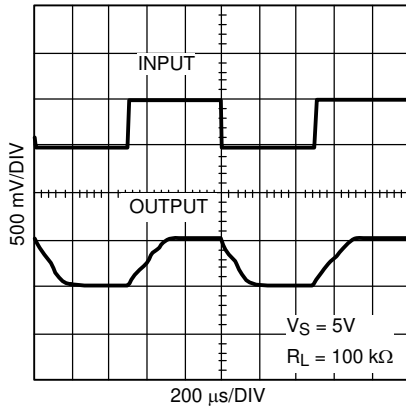

5-57. Large-Signal Pulse Response

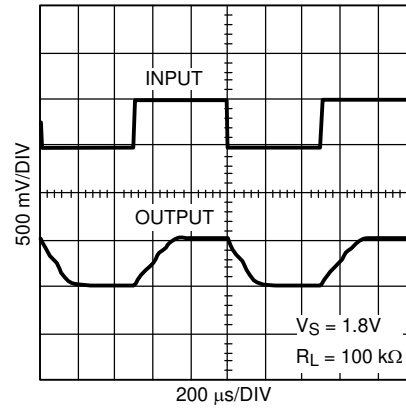

5-58. Large-Signal Pulse Response

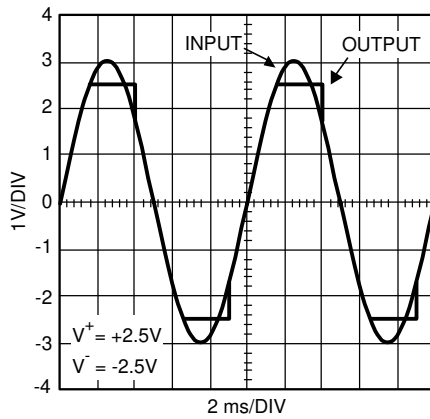

5-59. Overload Recovery Waveform

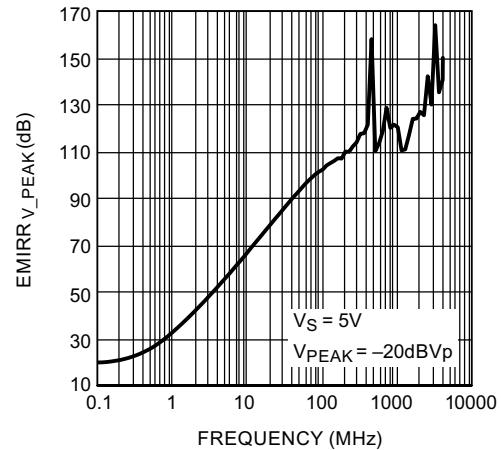

5-60. EMIRR vs Frequency

6 Detailed Description

6.1 Overview

The LPV521 is fabricated with Texas Instruments' state-of-the-art VIP50 process. This proprietary process dramatically improves the performance of Texas Instruments' low-power and low-voltage operational amplifiers. The following sections showcase the advantages of the VIP50 process and highlight circuits that enable ultra-low power consumption.

6.2 Functional Block Diagram



図 6-1. Block Diagram

6.3 Feature Description

The amplifier differential inputs consist of a noninverting input (+IN) and an inverting input (–IN). The amplifier amplifies only the difference in voltage between the two inputs, which is called the differential input voltage. The output voltage of the op-amp V_{OUT} is given by 式 1:

$$V_{OUT} = A_{OL} (IN^+ - IN^-) \quad (1)$$

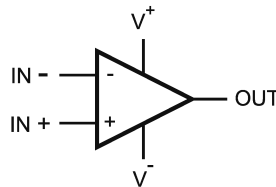
where A_{OL} is the open-loop gain of the amplifier, typically around 132dB (4,000,000 ×, or 0.25μV/V).

6.4 Device Functional Modes

6.4.1 Input Stage

The LPV521 has a rail-to-rail input that provides more flexibility for the system designer. Rail-to-rail input is achieved by using in parallel, one PMOS differential pair and one NMOS differential pair. When the common mode input voltage (V_{CM}) is near V^+ , the NMOS pair is on and the PMOS pair is off. When V_{CM} is near V^- , the NMOS pair is off and the PMOS pair is on. When V_{CM} is between V^+ and V^- , internal logic decides how much current each differential pair get. This special logic maintains stable and low-distortion amplifier operation within the entire common-mode voltage range.

Both input stages have an offset voltage (V_{OS}) characteristic; therefore, the offset voltage of the LPV521 becomes a function of V_{CM} . V_{OS} has a crossover point at 1.0V less than V^+ . See the *Input Offset Voltage vs Input Common Mode* curves in the *Typical Characteristics*. Take care in situations where the input signal amplitude is comparable to the V_{OS} value or the design requires high accuracy. In these situations, the input signal must avoid the crossover point. In addition, parameters such as PSRR and CMRR that involve the input offset voltage are also affected by changes in V_{CM} across the differential-pair transition region.

6.4.2 Output Stage

The LPV521 output voltage swings 3mV from rails at a 3.3V supply, which provides the maximum possible dynamic range at the output. This feature is particularly important when operating on low supply voltages.

The LPV521 maximum output voltage swing defines the maximum swing possible under a particular output load. The LPV521 output swings 50mV from the rail at a 5V supply with an output load of 100kΩ.

7 Applications and Implementation

注

以下のアプリケーション情報は、TI の製品仕様に含まれるものではなく、TI ではその正確性または完全性を保証いたしません。個々の目的に対する製品の適合性については、お客様の責任で判断していただくこととなります。お客様は自身の設計実装を検証しテストすることで、システムの機能を確認する必要があります。

7.1 Application Information

The LPV521 is specified for operation from 1.6V to 5.5V ($\pm 0.8V$ to $\pm 2.25V$). Many of the specifications apply from -40°C to $+125^{\circ}\text{C}$. The LMV521 features rail-to-rail input and rail-to-rail output swings while consuming only nanowatts of power. Parameters that exhibit significant variance with regard to operating voltage or temperature are presented in [セクション 5.6](#).

7.1.1 Driving Capacitive Load

The LPV521 is internally compensated for stable unity gain operation, with a 6.2kHz, typical gain bandwidth. However, the unity gain follower is the most sensitive configuration to capacitive load. The combination of a capacitive load placed at the output of an amplifier along with the amplifier output impedance creates a phase lag, which reduces the phase margin of the amplifier. If the phase margin is significantly reduced, the response is underdamped, and causes peaking in the transfer. When there is too much peaking, the op amp can start oscillating.



図 7-1. Resistive Isolation of Capacitive Load

To drive heavy capacitive loads, use an isolation resistor, R_{ISO} , as in [図 7-1](#). By using this isolation resistor, the capacitive load is isolated from the amplifier output. The larger the value of R_{ISO} , the more stable the amplifier. If the value of R_{ISO} is sufficiently large, the feedback loop is stable, independent of the value of C_L . However, larger values of R_{ISO} result in reduced output swing and reduced output current drive.

[表 7-1](#) shows the recommended minimum R_{ISO} values for a 5V supply. [図 7-2](#) shows the typical response obtained with the $C_L = 50\text{pF}$ and $R_{ISO} = 154\text{k}\Omega$. The other values of R_{ISO} in [Table 7-1](#) are chosen to achieve similar dampening at the respective capacitive loads. Notice that for the LPV521 with larger a C_L , a smaller R_{ISO} can be used for stability. However, for a given C_L , a larger R_{ISO} provides a more damped response. For capacitive loads of 20pF and less, no isolation resistor is needed.

表 7-1. Recommended Minimum R_{ISO} Values for a 5V Supply

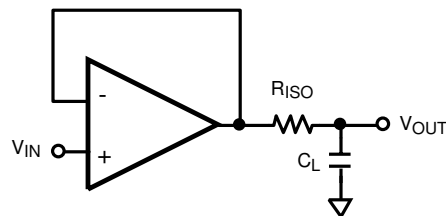
| C_L | R_{ISO} |
|-------------|----------------|
| 0pF to 20pF | Not needed |
| 50pF | 154k Ω |
| 100pF | 118k Ω |
| 500pF | 52.3k Ω |
| 1nF | 33.2k Ω |
| 5nF | 17.4k Ω |
| 10nF | 13.3k Ω |



図 7-2. Step Response

7.1.2 EMI Suppression

The near-ubiquity of cellular, Bluetooth®, and Wi-Fi® signals and the rapid rise of sensing systems incorporating wireless radios make electromagnetic interference (EMI) an evermore important design consideration for precision signal paths. Though RF signals lie outside the op-amp band, RF carrier switching can modulate the dc offset of the op amp. Also some common RF modulation schemes can induce down-converted components. The added dc offset and the induced signals are amplified with the signal of interest and thus corrupt the measurement. The LPV521 uses on-chip filters to reject these unwanted RF signals at the inputs and power supply pins, thereby preserving the integrity of the precision signal path.

Twisted pair cabling and the active front-end common-mode rejection provide immunity against low-frequency noise (for example, 60Hz or 50Hz mains) but are ineffective against RF interference. Even a few centimeters of printed circuit board (PCB) trace and wiring for sensors located close to the amplifier can pick up significant 1GHz RF. The integrated EMI filters of the LPV521 reduce or eliminate external shielding and filtering requirements, thus increasing system robustness. A larger EMIRR means more rejection of the RF interference. For more information on EMIRR, see the [AN-1698 A Specification for EMI Hardened Operational Amplifiers application report](#).

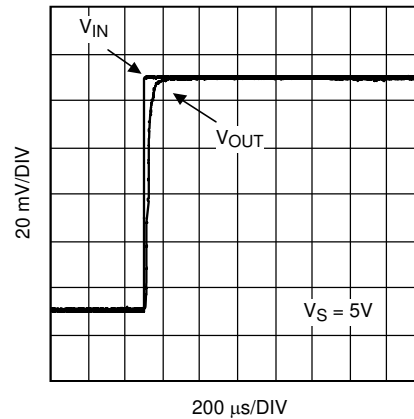
7.2 Typical Applications

7.2.1 60Hz Twin T-Notch Filter



図 7-3. 60Hz Notch Filter

7.2.1.1 Design Requirements

Small signals from transducers in remote and distributed sensing applications commonly suffer strong 60Hz interference from ac power lines. The circuit of 図 7-3 notches out the 60Hz and provides a gain $A_V = 2$ for the sensor signal represented by a 1kHz sine wave. Similar stages can be cascaded to remove 2nd and 3rd harmonics of 60Hz. Thanks to the nA power consumption of the LPV521, even five such circuits can run for 9.5 years from a small CR2032 lithium cell. These batteries have a nominal voltage of 3V and an end of life voltage of 2V. With an operating voltage from 1.6V to 5.5V, the LPV521 can function over this voltage range.

7.2.1.2 Detailed Design Procedure

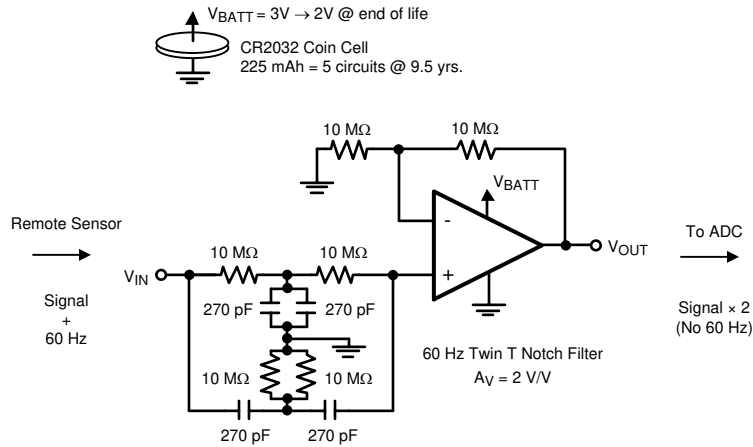
The notch frequency is set by $F_0 = 1 / 2\pi RC$. To achieve a 60Hz notch, use $R = 10\text{M}\Omega$ and $C = 270\text{pF}$. If eliminating 50Hz noise, which is common in European systems, use $R = 11.8\text{M}\Omega$ and $C = 270\text{pF}$.

The twin T notch filter works by having two separate paths from V_{IN} to the amplifier input. A low-frequency path through resistors R-R and another separate high-frequency path through capacitors C-C. However, at frequencies around the notch frequency, the two paths have opposing phase angles and the two signals tend to cancel at the amplifier input.

To ensure that the target center frequency is achieved, and to maximize the notch depth (Q factor), balance the filter as much as possible. To obtain circuit balance, while overcoming limitations of available standard resistor and capacitor values, use passives in parallel to achieve the $2C$ and $R/2$ circuit requirements for the filter components that connect to ground.

To ensure that passive component values stay as expected, clean the board with alcohol, rinse with deionized water, and air dry. Ensure that the board remains in a relatively low humidity environment to minimize moisture that can increase the conductivity of board components. Also large resistors come with considerable parasitic stray capacitance; the effects can be reduced by cutting out the ground plane below components of concern.

Use Large resistors in the feedback network to minimize battery drain. When designing with large resistors, consider the resistor thermal noise, op-amp current noise, as well as op-amp voltage noise in the noise analysis of the circuit. The noise analysis for the circuit in 図 7-3 can be done over a bandwidth of 5kHz, which takes the conservative approach of overestimating the bandwidth (LPV521 typical GBW/A_V is less). The total noise at the output is approximately $800\mu\text{V}_{PP}$, which is excellent considering the total consumption of the circuit is only 540nA. The dominant noise terms are op-amp voltage noise ($550\mu\text{V}_{PP}$), current noise through the feedback network ($430\mu\text{V}_{PP}$), and current noise through the notch filter network ($280\mu\text{V}_{PP}$). Thus, the total circuit noise is less than $\frac{1}{2}$ LSB of a 10-bit system with a 2V reference, which is 1mV.

7.2.1.3 Application Curve



図 7-4. 60Hz Notch Filter Waveform

7.2.2 Portable Gas Detection Sensor

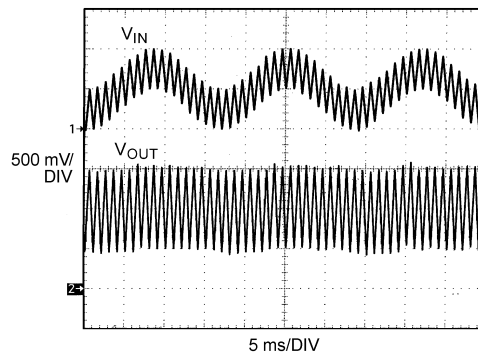

図 7-5. Precision Oxygen Sensor

7.2.2.1 Design Requirements

Gas sensors are used in many different industrial and medical applications. Gas sensors generate a current that is proportional to the percentage of a particular gas sensed in an air sample. This current goes through a load resistor and the resulting voltage drop is measured. The LPV521 is an excellent choice for this application because the device draws only 345nA of current and operates on supply voltages down to 1.6V. Depending on the sensed gas and sensitivity of the sensor, the output current can be in the order of tens of microamperes to a few milliamperes. Gas sensor data sheets often specify a recommended load resistor value or suggest a range of load resistors from which to choose.

Oxygen sensors are used when air quality or oxygen delivered to a patient needs to be monitored. Fresh air contains 20.9% oxygen. Air samples containing less than 18% oxygen are considered dangerous. This application detects oxygen in air. Oxygen sensors are also used in industrial applications where the environment must lack oxygen. An example is when food is vacuum packed. There are two main categories: oxygen sensors that sense oxygen when oxygen is abundantly present (for example, in air or near an oxygen tank), and oxygen sensors that detect traces of oxygen in ppm.

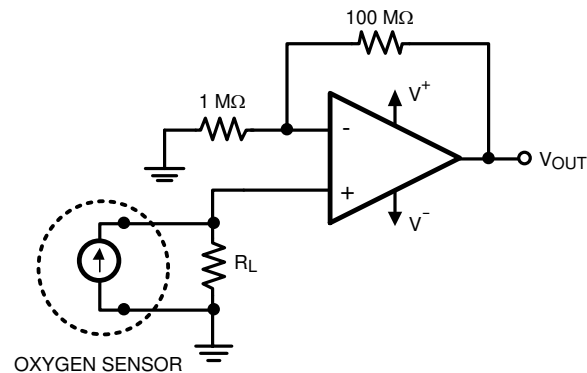
7.2.2.2 Detailed Design Procedure

Figure 7-5 shows a typical circuit used to amplify the output of an oxygen detector. The oxygen sensor outputs a known current through the load resistor. This value changes with the amount of oxygen present in the air sample. Oxygen sensors usually recommend a particular load resistor value or specify a range of acceptable values for the load resistor. The use of the nanopower LPV521 means minimal power usage by the op amp, and enhanced battery life. With the components shown in Figure 7-5, the circuit consumes less than 0.5µA of current, so that even batteries used in compact portable electronics, with low mAh charge ratings, can last beyond the life of the oxygen sensor. The precision specifications of the LPV521, such as the very low offset voltage, low TCV_{OS} , low input bias current, high CMRR, and high PSRR are other factors that make the LPV521 a great choice for this application.

7.2.2.3 Application Curve

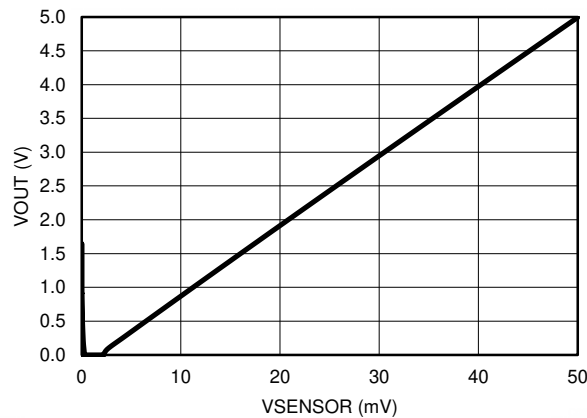

Figure 7-6. Calculated Oxygen Sensor Circuit Output (Single 5V Supply)

7.2.3 High-Side Battery Current Sensing

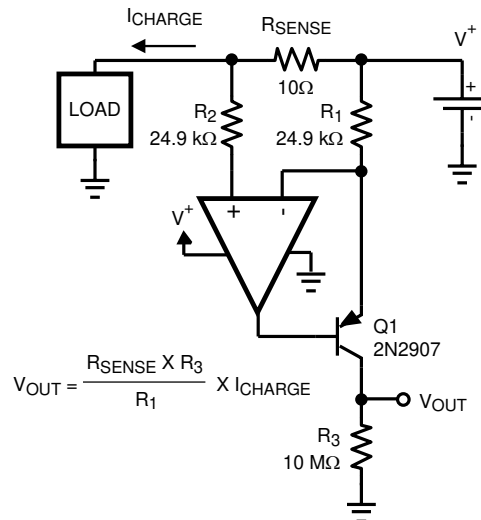

Figure 7-7. High-Side Current Sensing

7.2.3.1 Design Requirements

The rail-to-rail common-mode input range and the very low quiescent current make the LPV521 an excellent choice for use in high-side and low-side battery current-sensing applications. The high-side current-sensing

circuit in [Figure 7-7](#) is commonly used in a battery charger to monitor the charging current to prevent overcharging. A sense resistor R_{SENSE} is connected in series with the battery.

7.2.3.2 Detailed Design Procedure

The theoretical output voltage of the circuit is $V_{\text{OUT}} = [(R_{\text{SENSE}} \times R_3) / R_1] \times I_{\text{CHARGE}}$. In reality, however, as a result of the finite current gain of the transistor (β), the current that travels through R_3 is not I_{CHARGE} . Instead, R_3 is $\alpha \times I_{\text{CHARGE}}$ or $\beta / (\beta + 1) \times I_{\text{CHARGE}}$. A Darlington pair can be used to increase the β and performance of the measuring circuit.

Using the components shown in [Figure 7-7](#) results in $V_{\text{OUT}} \approx 4000\Omega \times I_{\text{CHARGE}}$. This result is needed to amplify a 1mA I_{CHARGE} to near full-scale of an analog-to-digital converter (ADC) with V_{REF} at 4.1V. A resistor, R_2 is used at the noninverting input of the amplifier, with the same value as R_1 to minimize offset voltage.

Selecting values per [Figure 7-7](#) limits the current traveling through the $R_1 - Q1 - R_3$ leg of the circuit to under 1 μ A, which is on the same order as the LPV521 supply current. Increasing resistors R_1 , R_2 , and R_3 decreases the measuring circuit supply current and extends battery life.

Decreasing R_{SENSE} minimizes error due to resistor tolerance; however, this decrease also decreases $V_{\text{SENSE}} = I_{\text{CHARGE}} \times R_{\text{SENSE}}$, and in turn, the amplifier offset voltage has a more significant contribution to the total error of the circuit. With the components shown in [Figure 7-7](#), the measurement circuit supply current can be kept below 1.5 μ A and measure 100 μ A to 1mA.

7.2.3.3 Application Curve

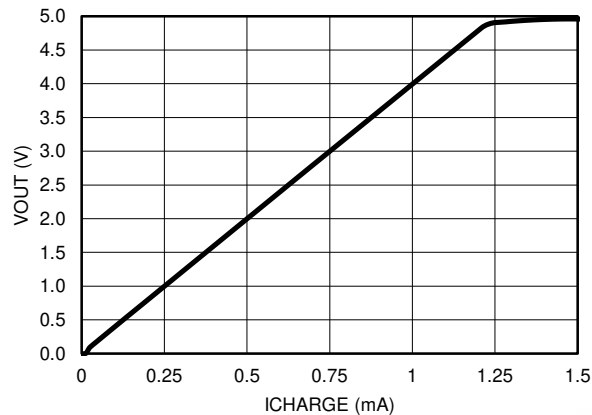

Figure 7-8. Calculated High-Side Current Sense Circuit Output

7.3 Power Supply Recommendations

The LPV521 is specified for operation from 1.6V to 5.5V ($\pm 0.8V$ to $\pm 2.75V$) over a -40°C to $+125^\circ\text{C}$ temperature range. Parameters that can exhibit significant variance with regard to operating voltage or temperature are presented in the [Section 5.6](#).

注意

Supply voltages greater than 6 V can permanently damage the device.

Low bandwidth nanopower devices do not have good high frequency ($> 1\text{kHz}$) ac PSRR rejection against high-frequency switching supplies and other kHz and greater noise sources; therefore, extra supply filtering is recommended if kHz-range noise is expected on the power-supply lines.

7.4 Layout

7.4.1 Layout Guidelines

For best operational performance of the device, use good printed circuit board (PCB) layout practices, including:

- Noise can propagate into analog circuitry through the power pins of the circuit as a whole and the op amp. Use bypass capacitors to reduce the coupled noise by providing low-impedance power sources local to the analog circuitry.
- Connect low-ESR, 0.1 μ F ceramic bypass capacitors between each supply pin and ground, placed as close to the device as possible. A single bypass capacitor from V+ to ground is applicable for single-supply applications.
- Separate grounding for analog and digital portions of circuitry is one of the simplest and most-effective methods of noise suppression. One or more layers on multilayer PCBs are usually devoted to ground planes. A ground plane helps distribute heat and reduces EMI noise pickup. Physically separate digital and analog grounds paying attention to the flow of the ground current.
- To reduce parasitic coupling, run the input traces as far away from the supply or output traces as possible. If not possible, cross the sensitive trace perpendicular as opposed to in parallel with the noisy trace.
- Place the external components as close to the device as possible. [セクション 7.4.2](#) shows how keeping RF and RG close to the inverting input minimizes parasitic capacitance.
- Keep the length of input traces as short as possible. Always remember that the input traces are the most sensitive part of the circuit.
- Consider a driven, low-impedance guard ring around the critical traces. A guard ring can significantly reduce leakage currents from nearby traces that are at different potentials.

7.4.2 Layout Example

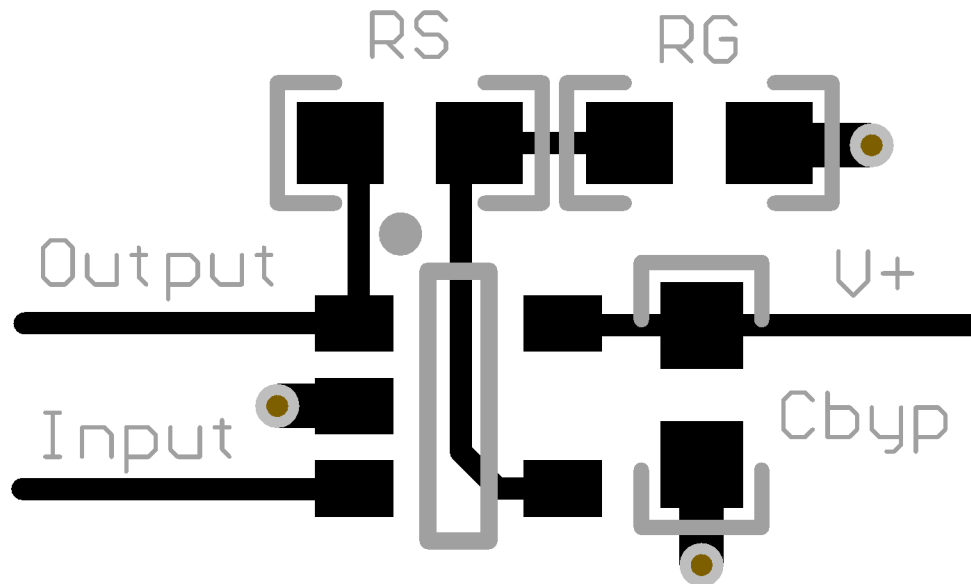

☒ 7-9. Noninverting Layout Example

8 Device and Documentation Support

8.1 Device Support

8.1.1 Development Support

- [LPV521 PSPICE Model](#)
- TINA-TI SPICE-Based Analog Simulation Program, <http://www.ti.com/tool/tina-ti>
- [Capacitive Load Drive Solution Using an Isolation Resistor](#) reference design
- DIP Adapter Evaluation Module, <http://www.ti.com/tool/dip-adapter-evm>
- Evaluation board for 5-pin, north-facing amplifiers in the SC70 package, [SNOA487](#).
- Manual for LMH730268 Evaluation board [551012922-001](#)

8.2 Documentation Support

8.2.1 Related Documentation

For related documentation, see the following:

- Texas Instruments, [Feedback Plots Define Op Amp AC Performance](#) application bulletin
- Texas Instruments, [AN-1698 A Specification for EMI Hardened Operational Amplifiers](#) application report
- Texas Instruments, [EMI Rejection Ratio of Operational Amplifiers](#) application report
- Texas Instruments, [Handbook of Operational Amplifier Applications](#) application report

8.3 ドキュメントの更新通知を受け取る方法

ドキュメントの更新についての通知を受け取るには、www.tij.co.jp のデバイス製品フォルダを開いてください。[通知] をクリックして登録すると、変更されたすべての製品情報に関するダイジェストを毎週受け取ることができます。変更の詳細については、改訂されたドキュメントに含まれている改訂履歴をご覧ください。

8.4 サポート・リソース

[テキサス・インスツルメンツ E2E™ サポート・フォーラム](#)は、エンジニアが検証済みの回答と設計に関するヒントをエキスパートから迅速かつ直接得ることができる場所です。既存の回答を検索したり、独自の質問をしたりすることで、設計に必要な支援を迅速に得ることができます。

リンクされているコンテンツは、各寄稿者により「現状のまま」提供されるものです。これらはテキサス・インスツルメンツの仕様を構成するものではなく、必ずしもテキサス・インスツルメンツの見解を反映したものではありません。テキサス・インスツルメンツの[使用条件](#)を参照してください。

8.5 Trademarks

テキサス・インスツルメンツ E2E™ is a trademark of Texas Instruments.

PowerWise® is a registered trademark of Texas Instruments.

Bluetooth® is a registered trademark of Bluetooth SIG, Inc..

Wi-Fi® is a registered trademark of The Wi-Fi Alliance.

すべての商標は、それぞれの所有者に帰属します。

8.6 静電気放電に関する注意事項



この IC は、ESD によって破損する可能性があります。テキサス・インスツルメンツは、IC を取り扱う際には常に適切な注意を払うことを推奨します。正しい取り扱いおよび設置手順に従わない場合、デバイスを破損するおそれがあります。

ESD による破損は、わずかな性能低下からデバイスの完全な故障まで多岐にわたります。精密な IC の場合、パラメータがわずかに変化するだけで公表されている仕様から外れる可能性があるため、破損が発生しやすくなっています。

8.7 用語集

[テキサス・インスツルメンツ用語集](#)

この用語集には、用語や略語の一覧および定義が記載されています。

9 Revision History

資料番号末尾の英字は改訂を表しています。その改訂履歴は英語版に準じています。

| Changes from Revision D (December 2014) to Revision E (July 2024) | Page |
|--|-------------|
| • ドキュメント全体にわたって表、図、相互参照の採番方法を更新..... | 1 |
| • P (PDIP、8) パッケージと関連する内容をドキュメントに追加..... | 1 |
| • 「アプリケーション」を更新..... | 1 |
| • 「パッケージ情報」表を更新..... | 1 |
| • Added missing thermal information for DCK (SC70) package..... | 4 |
| • Moved all <i>Electrical Characteristics</i> tables into one table..... | 4 |
| • Updated <i>Electrical Characteristics</i> note 1..... | 4 |
| • Added missing CMRR test condition for $V_+ = 5V$ | 4 |
| • Updated common mode voltage range to fix the incorrect conditions..... | 4 |
| • Updated Figure 5-4 and Figure 5-6, <i>TcvOS Distribution</i> , to fix test condition typos..... | 8 |
| • Changed A_{OL} typical value from "100 dB (100,000 ×, or 10 $\mu V/V$)" to "132dB (4000,000 ×, or 0.25 $\mu V/V$)" in <i>Feature Description</i> | 18 |

| Changes from Revision C (February 2013) to Revision D (December 2014) | Page |
|---|-------------|
| • 「ピン構成および機能」セクション、「ESD 定格」表、「機能説明」セクション、「デバイスの機能モード」セクション、「アプリケーションと実装」セクション、「電源に関する推奨事項」セクション、「レイアウト」セクション、「デバイスおよびドキュメントのサポート」セクション、「メカニカル、パッケージ、および注文情報」セクションを追加..... | 1 |

10 Mechanical, Packaging, and Orderable Information

The following pages include mechanical, packaging, and orderable information. This information is the most current data available for the designated devices. This data is subject to change without notice and revision of this document. For browser-based versions of this data sheet, refer to the left-hand navigation.

重要なお知らせと免責事項

テキサス・インスツルメンツは、技術データと信頼性データ (データシートを含みます)、設計リソース (リファレンス デザインを含みます)、アプリケーションや設計に関する各種アドバイス、Web ツール、安全性情報、その他のリソースを、欠陥が存在する可能性のある「現状のまま」提供しており、商品性および特定目的に対する適合性の黙示保証、第三者の知的財産権の非侵害保証を含むいかなる保証も、明示的または黙示的にかかわらず拒否します。

これらのリソースは、テキサス・インスツルメンツ製品を使用する設計の経験を積んだ開発者への提供を意図したものです。(1) お客様のアプリケーションに適した テキサス・インスツルメンツ製品の選定、(2) お客様のアプリケーションの設計、検証、試験、(3) お客様のアプリケーションに該当する各種規格や、その他のあらゆる安全性、セキュリティ、規制、または他の要件への確実な適合に関する責任を、お客様のみが単独で負うものとします。

上記の各種リソースは、予告なく変更される可能性があります。これらのリソースは、リソースで説明されている テキサス・インスツルメンツ製品を使用するアプリケーションの開発の目的でのみ、テキサス・インスツルメンツはその使用をお客様に許諾します。これらのリソースに関して、他の目的で複製することや掲載することは禁止されています。テキサス・インスツルメンツや第三者の知的財産権のライセンスが付与されている訳ではありません。お客様は、これらのリソースを自身で使用した結果発生するあらゆる申し立て、損害、費用、損失、責任について、テキサス・インスツルメンツおよびその代理人を完全に補償するものとし、テキサス・インスツルメンツは一切の責任を拒否します。

テキサス・インスツルメンツの製品は、[テキサス・インスツルメンツの販売条件](#)、または [ti.com](https://www.ti.com) やかかる テキサス・インスツルメンツ製品の関連資料などのいずれかを通じて提供する適用可能な条項の下で提供されています。テキサス・インスツルメンツがこれらのリソースを提供することは、適用されるテキサス・インスツルメンツの保証または他の保証の放棄の拡大や変更を意味するものではありません。

お客様がいかなる追加条項または代替条項を提案した場合でも、テキサス・インスツルメンツはそれらに異議を唱え、拒否します。

郵送先住所: Texas Instruments, Post Office Box 655303, Dallas, Texas 75265

Copyright © 2024, Texas Instruments Incorporated

PACKAGING INFORMATION

| Orderable Device | Status (1) | Package Type | Package Drawing | Pins | Package Qty | Eco Plan (2) | Lead finish/ Ball material (6) | MSL Peak Temp (3) | Op Temp (°C) | Device Marking (4/5) | Samples |
|------------------|---------------|--------------|-----------------|------|-------------|-----------------|--------------------------------------|----------------------|--------------|-------------------------|-------------------------|
| LPV521MG/NOPB | ACTIVE | SC70 | DCK | 5 | 1000 | RoHS & Green | Call TI SN | Level-1-260C-UNLIM | -40 to 125 | AHA | Samples |
| LPV521MGE/NOPB | ACTIVE | SC70 | DCK | 5 | 250 | RoHS & Green | Call TI SN | Level-1-260C-UNLIM | -40 to 125 | AHA | Samples |
| LPV521MGX/NOPB | ACTIVE | SC70 | DCK | 5 | 3000 | RoHS & Green | Call TI SN | Level-1-260C-UNLIM | -40 to 125 | AHA | Samples |
| LPV521P | ACTIVE | PDIP | P | 8 | 50 | RoHS & Green | NIPDAU | N / A for Pkg Type | -40 to 125 | LPV521 | Samples |

(1) The marketing status values are defined as follows:

ACTIVE: Product device recommended for new designs.

LIFEBUY: TI has announced that the device will be discontinued, and a lifetime-buy period is in effect.

NRND: Not recommended for new designs. Device is in production to support existing customers, but TI does not recommend using this part in a new design.

PREVIEW: Device has been announced but is not in production. Samples may or may not be available.

OBSELETE: TI has discontinued the production of the device.

(2) **RoHS:** TI defines "RoHS" to mean semiconductor products that are compliant with the current EU RoHS requirements for all 10 RoHS substances, including the requirement that RoHS substance do not exceed 0.1% by weight in homogeneous materials. Where designed to be soldered at high temperatures, "RoHS" products are suitable for use in specified lead-free processes. TI may reference these types of products as "Pb-Free".

RoHS Exempt: TI defines "RoHS Exempt" to mean products that contain lead but are compliant with EU RoHS pursuant to a specific EU RoHS exemption.

Green: TI defines "Green" to mean the content of Chlorine (Cl) and Bromine (Br) based flame retardants meet JS709B low halogen requirements of <=1000ppm threshold. Antimony trioxide based flame retardants must also meet the <=1000ppm threshold requirement.

(3) MSL, Peak Temp. - The Moisture Sensitivity Level rating according to the JEDEC industry standard classifications, and peak solder temperature.

(4) There may be additional marking, which relates to the logo, the lot trace code information, or the environmental category on the device.

(5) Multiple Device Markings will be inside parentheses. Only one Device Marking contained in parentheses and separated by a "-" will appear on a device. If a line is indented then it is a continuation of the previous line and the two combined represent the entire Device Marking for that device.

(6) Lead finish/Ball material - Orderable Devices may have multiple material finish options. Finish options are separated by a vertical ruled line. Lead finish/Ball material values may wrap to two lines if the finish value exceeds the maximum column width.

Important Information and Disclaimer:The information provided on this page represents TI's knowledge and belief as of the date that it is provided. TI bases its knowledge and belief on information provided by third parties, and makes no representation or warranty as to the accuracy of such information. Efforts are underway to better integrate information from third parties. TI has taken and

continues to take reasonable steps to provide representative and accurate information but may not have conducted destructive testing or chemical analysis on incoming materials and chemicals. TI and TI suppliers consider certain information to be proprietary, and thus CAS numbers and other limited information may not be available for release.

In no event shall TI's liability arising out of such information exceed the total purchase price of the TI part(s) at issue in this document sold by TI to Customer on an annual basis.

TAPE AND REEL INFORMATION

QUADRANT ASSIGNMENTS FOR PIN 1 ORIENTATION IN TAPE

*All dimensions are nominal

| Device | Package Type | Package Drawing | Pins | SPQ | Reel Diameter (mm) | Reel Width W1 (mm) | A0 (mm) | B0 (mm) | K0 (mm) | P1 (mm) | W (mm) | Pin1 Quadrant |
|----------------|--------------|-----------------|------|------|--------------------|--------------------|---------|---------|---------|---------|--------|---------------|
| LPV521MG/NOPB | SC70 | DCK | 5 | 1000 | 178.0 | 8.4 | 2.25 | 2.45 | 1.2 | 4.0 | 8.0 | Q3 |
| LPV521MGE/NOPB | SC70 | DCK | 5 | 250 | 178.0 | 8.4 | 2.25 | 2.45 | 1.2 | 4.0 | 8.0 | Q3 |
| LPV521MGX/NOPB | SC70 | DCK | 5 | 3000 | 178.0 | 8.4 | 2.25 | 2.45 | 1.2 | 4.0 | 8.0 | Q3 |

TAPE AND REEL BOX DIMENSIONS

*All dimensions are nominal

| Device | Package Type | Package Drawing | Pins | SPQ | Length (mm) | Width (mm) | Height (mm) |
|----------------|--------------|-----------------|------|------|-------------|------------|-------------|
| LPV521MG/NOPB | SC70 | DCK | 5 | 1000 | 208.0 | 191.0 | 35.0 |
| LPV521MGE/NOPB | SC70 | DCK | 5 | 250 | 208.0 | 191.0 | 35.0 |
| LPV521MGX/NOPB | SC70 | DCK | 5 | 3000 | 208.0 | 191.0 | 35.0 |

TUBE

*All dimensions are nominal

| Device | Package Name | Package Type | Pins | SPQ | L (mm) | W (mm) | T (μm) | B (mm) |
|---------|--------------|--------------|------|-----|--------|--------|--------|--------|
| LPV521P | P | PDIP | 8 | 50 | 506 | 13.97 | 11230 | 4.32 |

P (R-PDIP-T8)

PLASTIC DUAL-IN-LINE PACKAGE



- NOTES:
- A. All linear dimensions are in inches (millimeters).
 - B. This drawing is subject to change without notice.
 - C. Falls within JEDEC MS-001 variation BA.

DCK0005A



PACKAGE OUTLINE

SOT - 1.1 max height

SMALL OUTLINE TRANSISTOR

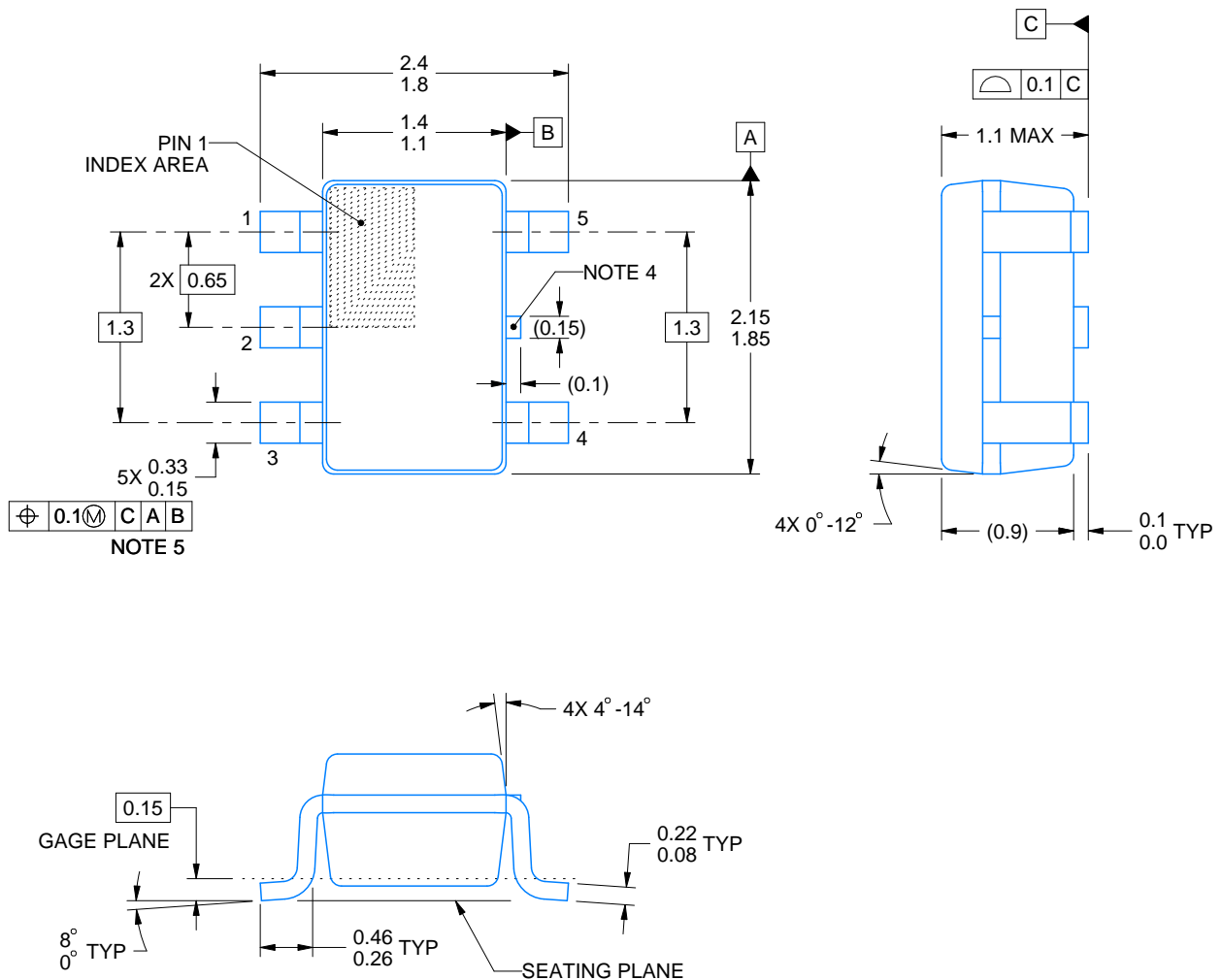

4214834/F 08/2024

NOTES:

1. All linear dimensions are in millimeters. Any dimensions in parenthesis are for reference only. Dimensioning and tolerancing per ASME Y14.5M.
2. This drawing is subject to change without notice.
3. Reference JEDEC MO-203.
4. Support pin may differ or may not be present.
5. Lead width does not comply with JEDEC.
6. Body dimensions do not include mold flash, protrusions, or gate burrs. Mold flash, protrusions, or gate burrs shall not exceed 0.25mm per side

EXAMPLE BOARD LAYOUT

DCK0005A

SOT - 1.1 max height

SMALL OUTLINE TRANSISTOR

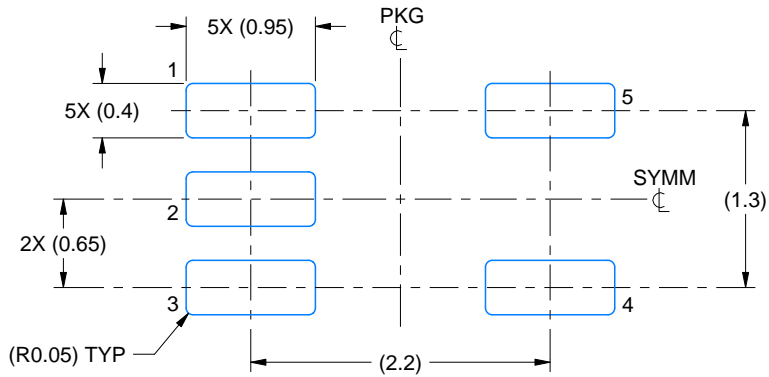

LAND PATTERN EXAMPLE
EXPOSED METAL SHOWN
SCALE:18X

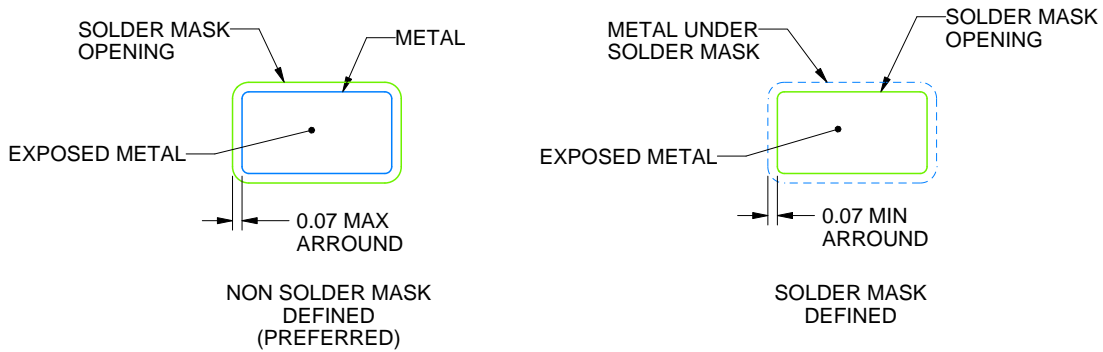

SOLDER MASK DETAILS

4214834/F 08/2024

NOTES: (continued)

- 7. Publication IPC-7351 may have alternate designs.
- 8. Solder mask tolerances between and around signal pads can vary based on board fabrication site.

EXAMPLE STENCIL DESIGN

DCK0005A

SOT - 1.1 max height

SMALL OUTLINE TRANSISTOR



SOLDER PASTE EXAMPLE
BASED ON 0.125 THICK STENCIL
SCALE: 18X

4214834/F 08/2024

NOTES: (continued)

9. Laser cutting apertures with trapezoidal walls and rounded corners may offer better paste release. IPC-7525 may have alternate design recommendations.
10. Board assembly site may have different recommendations for stencil design.

重要なお知らせと免責事項

TI は、技術データと信頼性データ (データシートを含みます)、設計リソース (リファレンス・デザインを含みます)、アプリケーションや設計に関する各種アドバイス、Web ツール、安全性情報、その他のリソースを、欠陥が存在する可能性のある「現状のまま」提供しており、商品性および特定目的に対する適合性の黙示保証、第三者の知的財産権の非侵害保証を含むいかなる保証も、明示的または黙示的にかかわらず拒否します。

これらのリソースは、TI 製品を使用する設計の経験を積んだ開発者への提供を意図したものです。(1) お客様のアプリケーションに適した TI 製品の選定、(2) お客様のアプリケーションの設計、検証、試験、(3) お客様のアプリケーションに該当する各種規格や、その他のあらゆる安全性、セキュリティ、規制、または他の要件への確実な適合に関する責任を、お客様のみが単独で負うものとし、

上記の各種リソースは、予告なく変更される可能性があります。これらのリソースは、リソースで説明されている TI 製品を使用するアプリケーションの開発の目的でのみ、TI はその使用をお客様に許諾します。これらのリソースに関して、他の目的で複製することや掲載することは禁止されています。TI や第三者の知的財産権のライセンスが付与されている訳ではありません。お客様は、これらのリソースを自身で使用した結果発生するあらゆる申し立て、損害、費用、損失、責任について、TI およびその代理人を完全に補償するものとし、TI は一切の責任を拒否します。

TI の製品は、[TI の販売条件](#)、または [ti.com](#) やかかる TI 製品の関連資料などのいずれかを通じて提供する適用可能な条項の下で提供されています。TI がこれらのリソースを提供することは、適用される TI の保証または他の保証の放棄の拡大や変更を意味するものではありません。

お客様がいかなる追加条項または代替条項を提案した場合でも、TI はそれらに異議を唱え、拒否します。

郵送先住所 : Texas Instruments, Post Office Box 655303, Dallas, Texas 75265
Copyright © 2024, Texas Instruments Incorporated