

OPAx323 20MHz 高帯域幅、114dB CMRR、低電圧 (1.7V~5.5V)、RRIO ゼロクロス オペアンプ

1 特長

- 1.7V~5.5V アプリケーション用ゼロクロス アンプ
- 大きいレール ツー レール CMRR: 114dB (標準値)
- 高ゲイン帯域幅積: 20MHz
- 高速スルーレート: 標準値 33V/ μ s
- 高速 0.01% セトリング: 標準値 200ns (2V 刻みの場合)
- 低い入力オフセット電圧: $\pm 150\mu$ V (標準値)
- 低ノイズフロア: 標準値 5.5nV/ $\sqrt{\text{Hz}}$ (10kHz 時)
- 大出力電流: 標準値 $\pm 110\text{mA}$ の I_{SC} (5.5V 時)
- 静止電流: 1.6mA/チャンネル (標準値)
- レール ツー レール 入出力
- ユニティゲイン安定
- 持続的な発振なしで最大 150pF を駆動
- 内部 RFI および EMI フィルタ付きの入力ピン
- 動作温度範囲: -40°C ~ 125°C

2 アプリケーション

- [ADC 用アンプ・ドライバ](#)
- [ハイサイド電流センス](#)
- [モータ・ロータリー・エンコーダ](#)
- [トランスインピーダンス・フォトダイオード・アンプ](#)
- [オーディオ・マイクロフォン・プリアンプ](#)
- [超音波トランスデューサ](#)

3 概要

OPAx323 ファミリのオペアンプには、ゼロクロスオーバー入力段とレール ツー レール出力段を備えた、シングル (OPA323)、デュアル (OPA2323)、クワッド チャンネル (OPA4323)、低電圧 (1.7V~5.5V)、広帯域 (20MHz) アンプがあります。ゼロクロスオーバー入力段により、OPAx323 は ADC ドライバ アプリケーションで一般的なレール ツー レール スイングを備えた入力信号について、高い直線性と低い歪みを実現できます。20MHz のゲイン帯域幅により、必要なセトリング性能に応じて 0.5MSPS~5MSPS の ADC サンプリング速度で、高速なセトリング応答が得られます。OPAx323 は、標準値の静止電流がわずか 1.6mA であり、消費電力削減に最適化されています。

OPAx323 は、最大オフセットドリフト $2\mu\text{V}/^{\circ}\text{C}$ および最小 100dB の CMRR で、熱ノイズフロア 5.5nV/ $\sqrt{\text{Hz}}$ を備えているため、ホイートストンブリッジなど高ゲインの電圧センシング アプリケーションで、高精度の性能を簡単にサポートします。より高い精度 (低オフセット、ドリフト、ノイズ、歪み、CMRR) と、より高いゲイン帯域幅 (高速セトリングとス

ルーイング) の独特な組み合わせにより、モータ ロータリー エンコーダ、マイクロフォン オーディオ プリアンプ、超音波トランスデューサなど、さまざまなアプリケーションで使用できます。

OPAx323 は 33V/ μ s の高いスルーレートを実現しているため、モータ電流センシング アプリケーションでフォルトを高速検出できます。従来のアンプとは異なり、ゼロクロスオーバー入力段により、ローサイドとハイサイド両方のセンシング アプリケーションで同一の精度性能が得られるため、OPAx323 はソーラー スtring インバータ、電力供給、グリッド、EV インフラストラクチャなどさまざまな最終機器の電流センシングに最適です。OPAx323S デバイスにはシャットダウン機能があり、さらに消費電力を削減し、アイドル時にアンプをディセーブルできます。このファミリには、すべてのチャンネル バリエーションで標準サイズと小型サイズに加えて、リード付きおよび QFN パッケージがあります。

製品情報

部品番号 ⁽¹⁾	チャンネル数	パッケージ ⁽⁴⁾	パッケージ サイズ ⁽⁵⁾
OPA323	シングル	DBV (SOT-23, 5) ⁽³⁾	2.9mm × 2.8mm
		DCK (SC70, 5)	2mm × 1.25mm
		DRL (SOT-5X3, 5) ⁽³⁾	1.6mm × 1.6mm
OPA323S ⁽²⁾	シングル、シャットダウン	DBV (SOT-23, 6) ⁽³⁾	2.9mm × 2.8mm
		DCK (SC70, 6) ⁽³⁾	2mm × 1.25mm
OPA2323	デュアル	D (SOIC, 8)	4.9mm × 6mm
		DDF (SOT-23, 8)	2.9mm × 2.8mm
		DSG (WSON, 8) ⁽³⁾	2mm × 2mm
		DGK (VSSOP, 8)	3mm × 4.9mm
		PW (TSSOP, 8) ⁽³⁾	3mm × 6.4mm
OPA2323S ⁽²⁾	デュアル、シャットダウン	RUG (X2QFN, 10) ⁽³⁾	1.5mm × 2mm
OPA4323	クワッド	D (SOIC, 14) ⁽³⁾	8.65mm × 6mm
		PW (TSSOP, 14)	5mm × 6.4mm
		RUC (X2QFN, 14) ⁽³⁾	2mm × 2mm
		DYY (SOT-23, 14)	4.2mm × 3.26mm
OPA4323S ⁽²⁾	クワッド、シャットダウン	RTE (WQFN, 16) ⁽³⁾	3mm × 3mm

- (1) [セクション 4](#) を参照してください。
- (2) 部品番号はプレビュー専用です。
- (3) パッケージはプレビュー専用です。
- (4) 詳細については、[セクション 11](#) を参照してください。
- (5) パッケージ サイズ (長さ × 幅) は公称値であり、該当する場合はピンも含まれます。



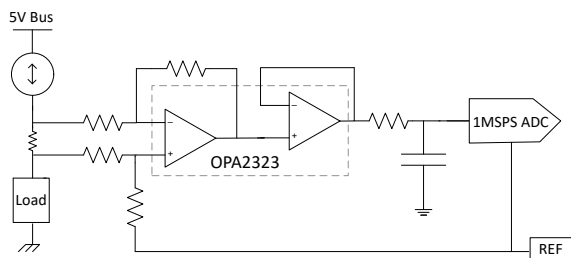

双方向、ハイサイド電流センス アンプと ADC ドライ バ

Table of Contents

1 特長	1	7.3 Feature Description	29
2 アプリケーション	1	7.4 Device Functional Modes	34
3 概要	1	8 Application and Implementation	35
4 Device Comparison Table	3	8.1 Application Information.....	35
5 Pin Configuration and Functions	4	8.2 Typical Application.....	35
6 Specifications	10	8.3 Power Supply Recommendations.....	37
6.1 Absolute Maximum Ratings.....	10	8.4 Layout.....	37
6.2 ESD Ratings.....	10	9 Device and Documentation Support	39
6.3 Recommended Operating Conditions.....	10	9.1 Documentation Support.....	39
6.4 Thermal Information for Single Channel.....	10	9.2 ドキュメントの更新通知を受け取る方法.....	39
6.5 Thermal Information for Dual Channel.....	11	9.3 サポート・リソース.....	39
6.6 Thermal Information for Quad Channel.....	11	9.4 静電気放電に関する注意事項.....	39
6.7 Electrical Characteristics.....	12	9.5 用語集.....	39
6.8 Typical Characteristics.....	15	10 Revision History	39
7 Detailed Description	27	11 Mechanical, Packaging, and Orderable Information	40
7.1 Overview.....	27		
7.2 Functional Block Diagram.....	28		

4 Device Comparison Table

DEVICE	NO. OF CHANNELS	SHDN	PACKAGE LEADS										
			SC70 DCK	SOIC D	SOT-23 DBV ⁽²⁾	SOT-23 DDF	SOT-553 DRL ⁽²⁾	SOT-23 DYY	TSSOP PW	VSSOP DGK	WQFN RTE ⁽²⁾	WSON DSG ⁽²⁾	X2QFN RUG ⁽²⁾
OPA323	1	NO	5	—	5	—	5	—	—	—	—	—	—
OPA323S ⁽¹⁾	1	YES	6	—	6	—	—	—	—	—	—	—	—
OPA2323	2	NO	—	8	—	8	—	—	—	8	8	—	8
OPA2323S ⁽¹⁾	2	YES	—	—	—	—	—	—	—	—	—	—	10
OPA4323	4	NO	—	14	—	—	—	—	14	14	—	—	—
OPA4323S	4	YES	—	—	—	—	—	—	—	—	16	—	—

- (1) Devices are preview only.
(2) Packages are preview only.

5 Pin Configuration and Functions



図 5-1. OPA323 DBV Package,
5-Pin SOT-23
(Top View)



図 5-2. OPA323 DCK and DRL Package,
5-Pin SC70 and 5-Pin SOT-5X3
(Top View)

表 5-1. Pin Functions: OPA323

NAME	PIN		TYPE ⁽¹⁾	DESCRIPTION
	SOT-23	SC70, SOT-5X3		
IN-	4	3	I	Inverting input
IN+	3	1	I	Noninverting input
OUT	1	4	O	Output
V-	2	2	I	Negative (low) supply or ground (for single-supply operation)
V+	5	5	I	Positive (high) supply

(1) I = input, O = output

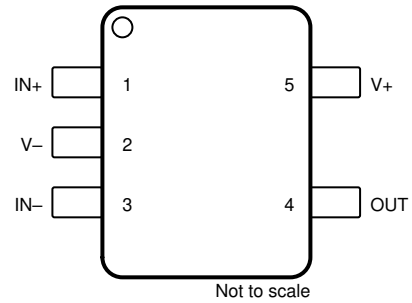
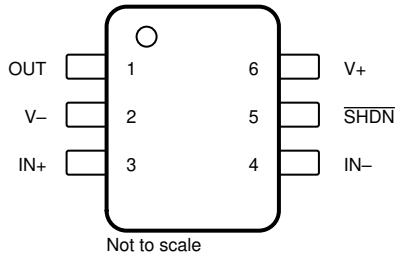

**図 5-3. OPA323S DBV Package,
6-Pin SOT-23
(Top View)**

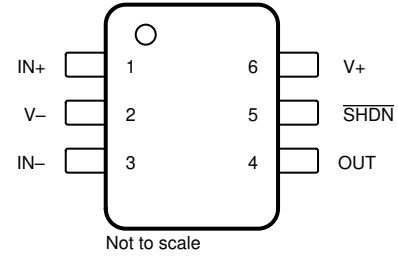

**図 5-4. OPA323S DCK Package,
6-Pin SC70
(Top View)**

表 5-2. Pin Functions: OPA323S

NAME	PIN		TYPE ⁽¹⁾	DESCRIPTION
	SOT-23	SC70		
IN-	4	3	I	Inverting input
IN+	3	1	I	Noninverting input
OUT	1	4	O	Output
SHDN	5	5	I	Shutdown: low = amp disabled, high = amp enabled See Shutdown Function for more information
V-	2	2	I	Negative (low) supply or ground (for single-supply operation)
V+	6	6	I	Positive (high) supply

(1) I = input, O = output

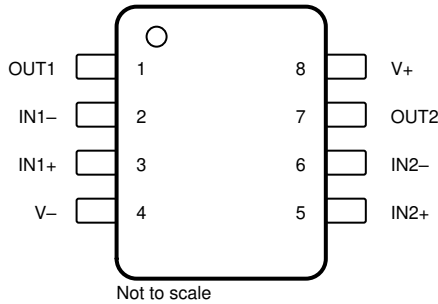

Not to scale

図 5-5. OPA2323 D, PW, DGK, and DDF Package, SOIC, TSSOP, VSSOP, and SOT-23-THIN (Top View)

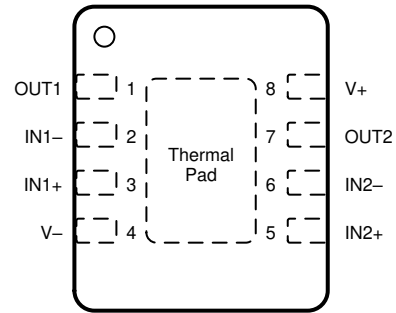

Not to scale

Connect exposed thermal pad to V-. For more information, see [Packages with an Exposed Thermal Pad](#).

図 5-6. OPA2323 DSG Package, 8-Pin WSON with Exposed Thermal Pad (Top View)

表 5-3. Pin Functions: OPA2323

PIN		TYPE ⁽¹⁾	DESCRIPTION
NAME	SOIC, TSSOP, VSSOP, SOT-23-THIN, WSON		
IN1-	2	I	Inverting input, channel 1
IN1+	3	I	Noninverting input, channel 1
IN2-	6	I	Inverting input, channel 2
IN2+	5	I	Noninverting input, channel 2
OUT1	1	O	Output, channel 1
OUT2	7	O	Output, channel 2
V-	4	I	Negative (low) supply or ground (for single-supply operation)
V+	8	I	Positive (high) supply

(1) I = input, O = output

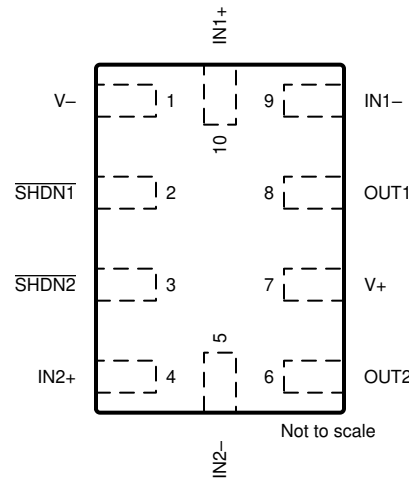

**図 5-7. OPA2323S RUG Package
10-Pin X2QFN
(Top View)**

表 5-4. Pin Functions: OPA2323S

PIN		TYPE ⁽¹⁾	DESCRIPTION
NAME	X2QFN		
IN1-	9	I	Inverting input, channel 1
IN1+	10	I	Noninverting input, channel 1
IN2-	5	I	Inverting input, channel 2
IN2+	4	I	Noninverting input, channel 2
OUT1	8	O	Output, channel 1
OUT2	6	O	Output, channel 2
SHDN1	2	I	Shutdown: low = amp disabled, high = amp enabled, channel 1. For more information, see Shutdown Function .
SHDN2	3	I	Shutdown: low = amp disabled, high = amp enabled, channel 2. For more information, see Shutdown Function .
V-	1	I	Negative (low) supply or ground (for single-supply operation)
V+	7	I	Positive (high) supply

(1) I = input, O = output



図 5-8. OPA4323 D, PW and DYY Package, 14-Pin SOIC, TSSOP, SOT-23-THN (Top View)

表 5-5. Pin Functions: OPA4323

PIN		TYPE ⁽¹⁾	DESCRIPTION
NAME	SOIC, TSSOP		
IN1-	2	I	Inverting input, channel 1
IN1+	3	I	Noninverting input, channel 1
IN2-	6	I	Inverting input, channel 2
IN2+	5	I	Noninverting input, channel 2
IN3-	9	I	Inverting input, channel 3
IN3+	10	I	Noninverting input, channel 3
IN4-	13	I	Inverting input, channel 4
IN4+	12	I	Noninverting input, channel 4
OUT1	1	O	Output, channel 1
OUT2	7	O	Output, channel 2
OUT3	8	O	Output, channel 3
OUT4	14	O	Output, channel 4
V-	11	I	Negative (low) supply or ground (for single-supply operation)
V+	4	I	Positive (high) supply

(1) I = input, O = output

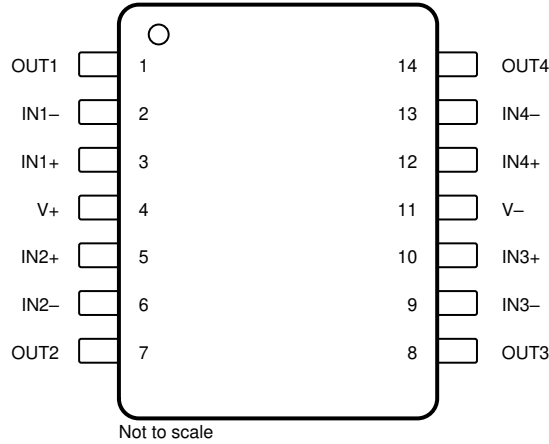
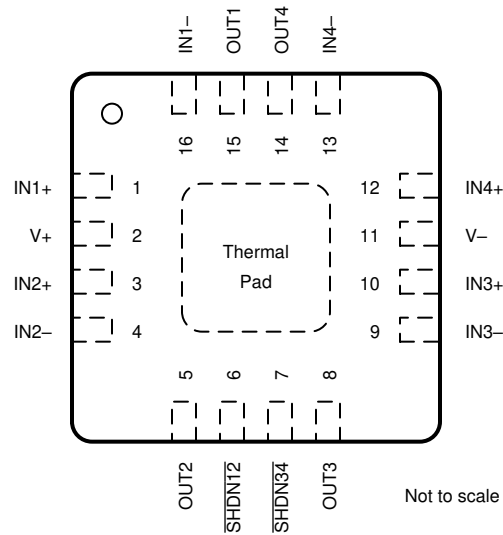

A. Connect thermal pad to V-.

図 5-9. OPA4323S RTE Package,
16-Pin WQFN With Exposed Thermal Pad
(Top View)

表 5-6. Pin Functions: OPA4323S

PIN		TYPE ⁽¹⁾	DESCRIPTION
NAME	WQFN		
IN1+	1	I	Noninverting input, channel 1
IN1-	16	I	Inverting input, channel 1
IN2+	3	I	Noninverting input, channel 2
IN2-	4	I	Inverting input, channel 2
IN3+	10	I	Noninverting input, channel 3
IN3-	9	I	Inverting input, channel 3
IN4+	12	I	Noninverting input, channel 4
IN4-	13	I	Inverting input, channel 4
SHDN12	6	I	Shutdown: low = amp disabled, high = amp enabled, channel 1 and 2. For more information, see Shutdown Function .
SHDN34	7	I	Shutdown: low = amp disabled, high = amp enabled, channel 3 and 4. For more information, see Shutdown Function .
OUT1	15	O	Output, channel 1
OUT2	5	O	Output, channel 2
OUT3	8	O	Output, channel 3
OUT4	14	O	Output, channel 4
V-	11	I	Negative (low) supply or ground (for single-supply operation)
V+	2	I	Positive (high) supply

(1) I = input, O = output

6 Specifications

6.1 Absolute Maximum Ratings

over operating ambient temperature range (unless otherwise noted) ⁽¹⁾

		MIN	MAX	UNIT
Supply voltage, $V_S = (V+) - (V-)$	Supply voltage, $V_S = (V+) - (V-)$	0	7.0	V
Signal input pins	Common-mode voltage ^{(2) (3)}	-0.5	6.0	V
	Differential voltage ^{(2) (3)}		±6.0	V
	Current ⁽³⁾	-10	10	mA
Output short-circuit ⁽⁴⁾		Continuous		
Operating ambient temperature, T_A		-55	150	°C
Junction temperature, T_J			150	°C
Storage temperature, T_{stg}		-65	150	°C

- Operation outside the Absolute Maximum Ratings may cause permanent device damage. Absolute Maximum Ratings do not imply functional operation of the device at these or any other conditions beyond those listed under Recommended Operating Conditions. If used outside the Recommended Operating Conditions but within the Absolute Maximum Ratings, the device may not be fully functional, and this may affect device reliability, functionality, performance, and shorten the device lifetime.
- Input pins can swing beyond (V+) as long as they stay within 6V. No diode structure from input pins to (V+).
- Input pins are diode-clamped to (V-). Input signals that 0.3V below (V-) must be current-limited to 10mA or less.
- Short-circuit to ground, one amplifier per package.

6.2 ESD Ratings

			VALUE	UNIT	
$V_{(ESD)}$	Electrostatic discharge	Human-body model (HBM), per ANSI/ESDA/JEDEC JS-001 ⁽¹⁾	±4000	V	
		Charged-device model (CDM), per ANSI/ESDA/JEDEC JS-002 ⁽²⁾	OPA4323	±500	V
			OPA323, OPA2323	±250	V

- JEDEC document JEP155 states that 500V HBM allows safe manufacturing with a standard ESD control process.
- JEDEC document JEP157 states that 250V CDM allows safe manufacturing with a standard ESD control process.

6.3 Recommended Operating Conditions

over operating ambient temperature range (unless otherwise noted)

		MIN	MAX	UNIT
V_S	Supply voltage, (V+) – (V-)	1.7	5.5	V
C_{BYP}	Bypass capacitor on the power supply pins ⁽¹⁾	0.1		µF
T_A	Specified temperature	-40	125	°C

- For C_{BYP} , use low-ESR ceramic capacitors between each supply pin and ground. Only one C_{BYP} is sufficient for single supply operation. Ensure that C_{BYP} is placed as close to the device as possible and the supply trace routes through C_{BYP} before reaching the supply pin.

6.4 Thermal Information for Single Channel

THERMAL METRIC ⁽¹⁾		OPA323			OPA323S		UNIT
		DBV ⁽²⁾ (SOT-23)	DCK (SC70)	DRL ⁽²⁾ (SOT-5X3)	DBV ⁽²⁾ (SOT-23)	DCK ⁽²⁾ (SC70)	
		5 PINS	5 PINS	5 PINS	6 PINS	6 PINS	
$R_{\theta JA}$	Junction-to-ambient thermal resistance	189.3	196.7	TBD	168.8	TBD	°C/W
$R_{\theta JC(top)}$	Junction-to-case (top) thermal resistance	86.9	104.5	TBD	87.8	TBD	°C/W
$R_{\theta JB}$	Junction-to-board thermal resistance	55.9	44.8	TBD	49.3	TBD	°C/W
Ψ_{JT}	Junction-to-top characterization parameter	23.7	18.7	TBD	25.6	TBD	°C/W
Ψ_{JB}	Junction-to-board characterization parameter	55.5	44.5	TBD	49.0	TBD	°C/W
$R_{\theta JC(bot)}$	Junction-to-case (bottom) thermal resistance	n/a	n/a	TBD	n/a	TBD	°C/W

- For more information about traditional and new thermal metrics, see the [Semiconductor and IC Package Thermal Metrics](#) application report.

(2) This package option is preview.

6.5 Thermal Information for Dual Channel

THERMAL METRIC ⁽¹⁾		OPA2323					OPA2323S	UNIT
		D ⁽²⁾ (SOIC)	PW ⁽²⁾ (TSSOP)	DGK (VSSOP)	DDF (SOT-23-8)	DSG ⁽²⁾ (WSON)	RUG ⁽²⁾ (X2QFN)	
		8 PINS	8 PINS	8 PINS	8 PINS	8 PINS	10 PINS	
R _{θJA}	Junction-to-ambient thermal resistance	139.0	TBD	173.6	149.6	TBD	144.8	°C/W
R _{θJC(top)}	Junction-to-case (top) thermal resistance	81.2	TBD	65.1	72.9	TBD	47.1	°C/W
R _{θJB}	Junction-to-board thermal resistance	82.4	TBD	95.1	68.4	TBD	76.0	°C/W
ψ _{JT}	Junction-to-top characterization parameter	31.3	TBD	10.0	4.0	TBD	0.8	°C/W
ψ _{JB}	Junction-to-board characterization parameter	81.6	TBD	93.5	68.1	TBD	75.8	°C/W
R _{θJC(bot)}	Junction-to-case (bottom) thermal resistance	n/a	TBD	n/a	n/a	TBD	n/a	°C/W

(1) For more information about traditional and new thermal metrics, see the [Semiconductor and IC Package Thermal Metrics](#) application report.

(2) This package option is preview.

6.6 Thermal Information for Quad Channel

THERMAL METRIC ⁽¹⁾		OPA4323			OPA4323S	UNIT
		D ⁽²⁾ (SOIC)	PW (TSSOP)	DYY (SOT)	RTE ⁽²⁾ (WQFN)	
		14 PINS	14 PINS	14 PINS	16 PINS	
R _{θJA}	Junction-to-ambient thermal resistance	TBD	115.8	113.7	48.7	°C/W
R _{θJC(top)}	Junction-to-case (top) thermal resistance	TBD	44.9	49.1	52.0	°C/W
R _{θJB}	Junction-to-board thermal resistance	TBD	58.7	42.4	23.9	°C/W
ψ _{JT}	Junction-to-top characterization parameter	TBD	5.2	1.6	1.2	°C/W
ψ _{JB}	Junction-to-board characterization parameter	TBD	58.1	42.2	23.9	°C/W
R _{θJC(bot)}	Junction-to-case (bottom) thermal resistance	TBD	n/a	n/a	8.2	°C/W

(1) For more information about traditional and new thermal metrics, see the [Semiconductor and IC Package Thermal Metrics](#) application report.

(2) This package option is preview.

6.7 Electrical Characteristics

For $V_S = (V+) - (V-) = 1.8V$ to $5.5V$ ($\pm 0.85V$ to $\pm 2.75V$) at $T_A = 25^\circ C$, $R_L = 10k\Omega$ connected to $V_S / 2$, $V_{CM} = V_S / 2$, and $V_{O UT} = V_S / 2$, unless otherwise noted.

PARAMETER		TEST CONDITIONS		MIN	TYP	MAX	UNIT
OFFSET VOLTAGE							
V_{OS}	Input offset voltage	$V_S = 1.8V$ to $5.5V$			± 0.15	± 1.25	mV
		$V_S = 1.8V$ to $5.5V$	$T_A = -40^\circ C$ to $125^\circ C$			± 1.35	
dV_{OS}/dT	Input offset voltage drift (1)	$V_S = 1.8V$ to $5.5V$			± 0.4	± 1.8	$\mu V/^\circ C$
PSRR	Input offset voltage versus power supply	$V_S = 1.8V$ to $5.5V$			± 5	± 20	$\mu V/V$
	Channel separation	$f = 10kHz$			± 1		$\mu V/V$
INPUT BIAS CURRENT							
I_B	Input bias current (1)	$V_S = 1.8V$ and $V_S = 5V$			± 0.5	± 20	pA
		$V_S = 1.8V$ and $V_S = 5V$	$T_A = -40^\circ C$ to $125^\circ C$			± 1600	pA
I_{OS}	Input offset current (1)	$V_S = 1.8V$ and $V_S = 5V$			± 0.25		pA
		$V_S = 1.8V$ and $V_S = 5V$	$T_A = -40^\circ C$ to $125^\circ C$			± 120	pA
NOISE							
E_N	Input voltage noise	$f = 0.1Hz$ to $10Hz$			2.8		μV_{PP}
e_N	Input voltage noise density	$f = 100Hz$			24		nV/ \sqrt{Hz}
		$f = 1kHz$			9		
		$f = 10kHz$			5.5		
i_N	Input current noise (2)	$f = 1kHz$			20		fA/ \sqrt{Hz}
INPUT VOLTAGE RANGE							
V_I	Input voltage range	$V_S = 1.8V$ to $5.5V$			$(V-) - 0.2$	$(V+) + 0.15$	V
CMRR	Common-mode rejection ratio	$V_S = 5.5V, (V-) - 0.2V \leq V_{CM} \leq (V+) + 0.10V$			100	114	dB
		$V_S = 5.5V, (V-) - 0.2V \leq V_{CM} \leq (V+) + 0.15V$			90	104	dB
		$V_S = 5.5V, (V-) - 0.2V \leq V_{CM} \leq (V+) + 0.15V$	$T_A = -40^\circ C$ to $125^\circ C$		84		dB
		$V_S = 1.8V, (V-) - 0.1V \leq V_{CM} \leq (V+) + 0.05V$			85	103	dB
		$V_S = 1.8V, (V-) - 0.1V \leq V_{CM} \leq (V+) + 0.05V$	$T_A = -40^\circ C$ to $125^\circ C$		80		dB
INPUT IMPEDANCE							
Z_{ID}	Differential				$80 \parallel 2$		$G\Omega \parallel pF$
Z_{ICM}	Common-mode				$100 \parallel 1$		$G\Omega \parallel pF$
OPEN-LOOP GAIN							
A_{OL}	Open-loop voltage gain	$V_S = 1.8V, (V-) + 0.1V < V_O < (V+) - 0.1V, R_L = 10k\Omega$ to $V_S / 2$			103	120	dB
		$V_S = 1.8V, (V-) + 0.2V < V_O < (V+) - 0.2V, R_L = 2k\Omega$ to $V_S / 2$			100	115	dB
		$V_S = 5.5V, (V-) + 0.1V < V_O < (V+) - 0.1V, R_L = 10k\Omega$ to $V_S / 2$			112	125	dB
		$V_S = 5.5V, (V-) + 0.2V < V_O < (V+) - 0.2V, R_L = 2k\Omega$ to $V_S / 2$			108	120	dB
FREQUENCY RESPONSE							
GBW	Gain-bandwidth product	$V_S = 5.5V, G = +1, R_L = 10k\Omega, C_L = 100pF$		$T_A = 25^\circ C$		20	MHz
SR	Slew rate	$V_S = 5.5V, G = +1, V_{STEP} = 5V, R_L = 10k\Omega, C_L = 100pF$				33	V/ μs
THD+N	Total harmonic distortion + noise (3)	$V_S = 5V, G = +1, V_O = 4V_{P-P}, f = 10kHz, R_L = 600\Omega$ to $V_S / 2, C_L = 50pF$				0.00125	%
t_s	Settling time	To 0.1%, $V_S = 5.5V, V_{STEP} = 4V, G = +1, C_L = 10pF$				200	ns
		To 0.1%, $V_S = 5.5V, V_{STEP} = 2V, G = +1, C_L = 10pF$				150	
		To 0.01%, $V_S = 5.5V, V_{STEP} = 4V, G = +1, C_L = 10pF$				250	
		To 0.01%, $V_S = 5.5V, V_{STEP} = 2V, G = +1, C_L = 10pF$				200	

6.7 Electrical Characteristics (続き)

For $V_S = (V_+) - (V_-) = 1.8V$ to $5.5V$ ($\pm 0.85V$ to $\pm 2.75V$) at $T_A = 25^\circ C$, $R_L = 10k\Omega$ connected to $V_S / 2$, $V_{CM} = V_S / 2$, and $V_{O\ UT} = V_S / 2$, unless otherwise noted.

PARAMETER		TEST CONDITIONS	MIN	TYP	MAX	UNIT
GM	Gain Margin	$V_S = 5.5V$, $G = +1$, $R_L = 10k\Omega$, $C_L = 30pF$		15		dB
		$V_S = 1.8V$, $G = +1$, $R_L = 10k\Omega$, $C_L = 30pF$		15		dB
PM	Phase Margin	$V_S = 5.5V$, $G = +1$, $R_L = 10k\Omega$, $C_L = 30pF$		50		°
		$V_S = 1.8V$, $G = +1$, $R_L = 10k\Omega$, $C_L = 30pF$		52.5		°
$t_{overload}$	Overload recovery time	$V_{IN} \times gain > V_S$		130		ns
EMIRR	Electro-magnetic interference rejection ratio	$f = 1.8GHz$, $V_{IN_EMIRR} = 100mV$		62		dB
OUTPUT						
V_o	Voltage output swing from rail	$V_S = 1.8V$, $R_L = 10k\Omega$ to $V_S / 2$		15	25	mV
		$V_S = 5.5V$, $R_L = 10k\Omega$ to $V_S / 2$		25	35	mV
		$V_S = 5.5V$, $R_L = 2k\Omega$ to $V_S / 2$		45	55	mV
I_{sc}	Short-circuit current (4)	$V_S = 1.8V$	± 20	± 40		mA
		$V_S = 5.5V$	± 80	± 110		mA
Z_o	Open-loop output impedance	$f = 10kHz$		80		Ω
POWER SUPPLY						
I_Q	Quiescent current per amplifier	$V_S = 5.5V$, $I_o = 0A$	$T_A = -40^\circ C$ to $125^\circ C$	1.6	1.9	mA
				2.0		
	Power-on time	$V_S = 0V$ to $5.5V$, 90% I_Q Level		25		μs
SHUTDOWN						
I_{QSD}	Shutdown current per amplifier (7)	All amplifiers disabled, $SHDN = V_-$		0.5	1	μA
		All amplifiers disabled, $SHDN = V_-$, $T_A = -40^\circ C$ to $125^\circ C$			1.5	μA
Z_{SHDN}	Output impedance during shutdown (7)	Amplifier disabled		43 11.5		$G\Omega$ pF
V_{IH}	Logic high threshold voltage (amplifier enabled) (7)			$(V_-) + 1V$		V
V_{IL}	Logic low threshold voltage (amplifier disabled)			$(V_-) + 0.2V$		V
t_{ON}	Amplifier enable time (full shutdown) (5) (6) (7)	$G = +1$, $V_{CM} = V_S / 2$, $V_o = 0.9 \times V_S / 2$, R_L connected to V_-		1		μs
	Amplifier enable time (partial shutdown) (5) (6) (7)	$G = +1$, $V_{CM} = V_S / 2$, $V_o = 0.9 \times V_S / 2$, R_L connected to V_-		1		
t_{OFF}	Amplifier disable time (5) (7)	$G = +1$, $V_{CM} = V_S / 2$, $V_o = 0.1 \times V_S / 2$, R_L connected to V_-		1		μs
	SHDN pin input bias current (per pin) (7)	$(V_+) \geq SHDN \geq (V_-) + 1V$		50		nA
		$(V_-) \leq SHDN \leq (V_-) + 0.2V$		100		

(1) Max or min limit is specified based on characterization results.

(2) Typical input current noise data to be specified based on design simulation results

- (3) Third-order filter; bandwidth = 80kHz at -3dB.
- (4) Short circuit current specified here is average of sourcing and sinking short circuit currents
- (5) Disable time (t_{OFF}) and enable time (t_{ON}) are defined as the time interval between the 50% point of the signal applied to the \overline{SHDN} pin and the point at which the output voltage reaches the 10% (disable) or 90% (enable) level.
- (6) Full shutdown refers to the dual device having both channels 1 and 2 disabled ($\overline{SHDN1} = \overline{SHDN2} = V-$) and the quad device having all channels 1 to 4 disabled ($\overline{SHDN12} = \overline{SHDN34} = V-$). For partial shutdown, only one \overline{SHDN} pin is exercised; in this mode, the internal biasing circuitry remains operational and the enable time is shorter.
- (7) Shutdown section is on preview

6.8 Typical Characteristics

at $T_A = 25^\circ\text{C}$, $V_+ = 2.75\text{V}$, $V_- = -2.75\text{V}$, $R_L = 10\text{k}\Omega$ connected to $V_S / 2$, $V_{CM} = V_S / 2$, and $V_{OUT} = V_S / 2$ (unless otherwise noted)

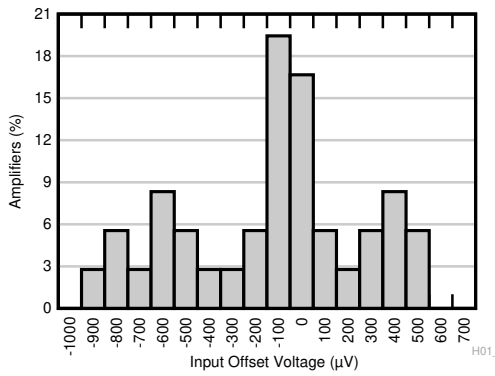

$V_S = 5.5\text{V}$ $V_{CM} = V_S / 2$ $T_A = 25^\circ\text{C}$
No. of devices = 36 Mean = $-32\mu\text{V}$ Sigma = $190\mu\text{V}$

6-1. Input Offset Voltage Distribution Histogram

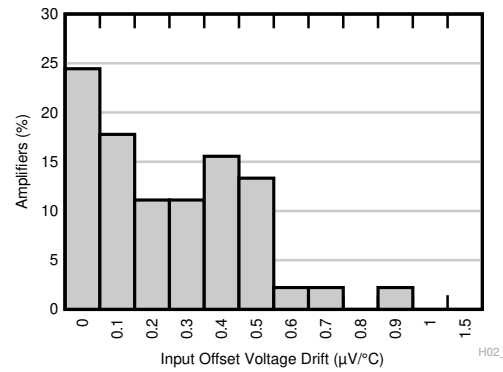

$V_S = 5.5\text{V}$ $V_{CM} = V_S / 2$ $T_A = -40^\circ\text{C}$ to $+125^\circ\text{C}$
No. of devices = 36
Mean = $0.28\mu\text{V}/^\circ\text{C}$ Sigma = $0.22\mu\text{V}/^\circ\text{C}$

6-2. Input Offset Voltage Drift Distribution Histogram

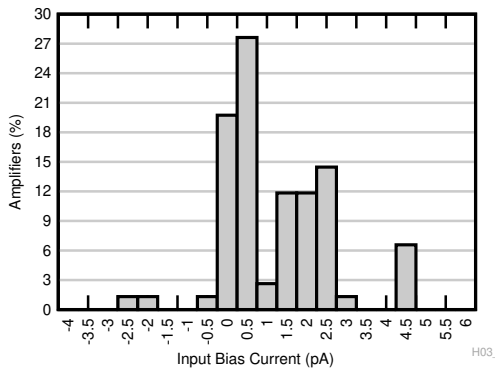

$V_S = 5.5\text{V}$ $V_{CM} = V_S / 2$ $T_A = 25^\circ\text{C}$
No. of devices = 90 Mean = 1pA Sigma = 2pA

6-3. Input Bias Current Distribution Histogram

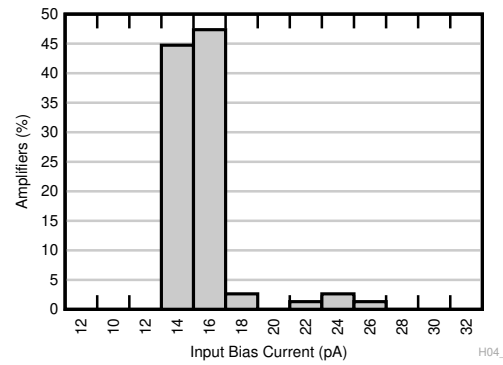

$V_S = 5.5\text{V}$ $V_{CM} = V_S / 2$ $T_A = 85^\circ\text{C}$
No. of devices = 90 Mean = 13pA Sigma = 2pA

6-4. Input Bias Current Distribution Histogram

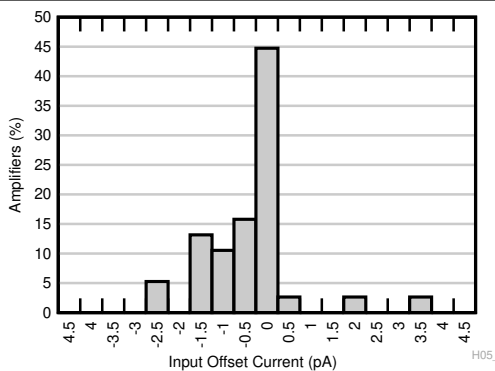

$V_S = 5.5\text{V}$ $V_{CM} = V_S / 2$ $T_A = 25^\circ\text{C}$
No. of devices = 45 Mean = -0.1pA Sigma = 1.7pA

6-5. Input Offset Current Distribution Histogram

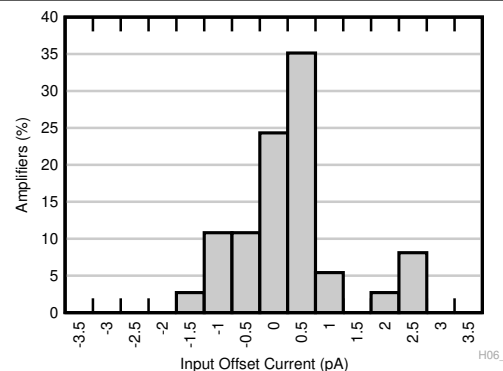

$V_S = 5.5\text{V}$ $V_{CM} = V_S / 2$ $T_A = 85^\circ\text{C}$
No. of devices = 45 Mean = 1.1pA Sigma = 2.1pA

6-6. Input Offset Current Distribution Histogram

6.8 Typical Characteristics (continued)

at $T_A = 25^\circ\text{C}$, $V_+ = 2.75\text{V}$, $V_- = -2.75\text{V}$, $R_L = 10\text{k}\Omega$ connected to $V_S / 2$, $V_{CM} = V_S / 2$, and $V_{OUT} = V_S / 2$ (unless otherwise noted)



图 6-7. Input Offset Voltage vs Supply Voltage



图 6-8. Input Offset Voltage vs Supply Voltage

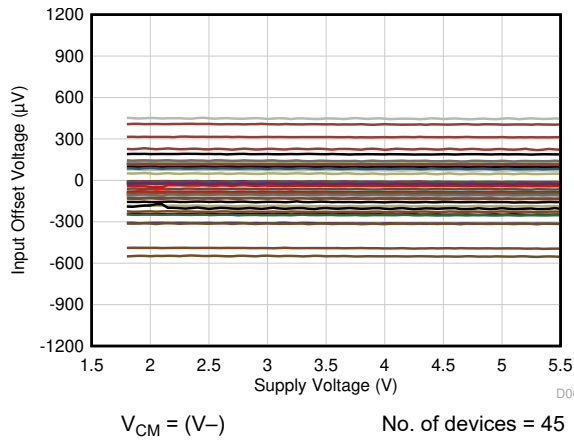

图 6-9. Input Offset Voltage vs Temperature

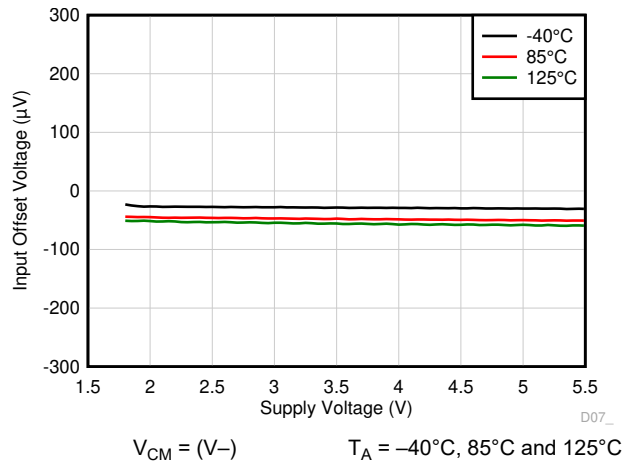

图 6-10. Input Offset Voltage vs Common-Mode

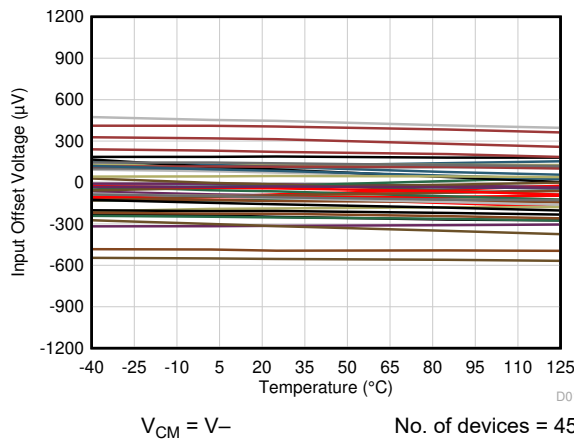

图 6-11. Input Offset Voltage vs Common-Mode

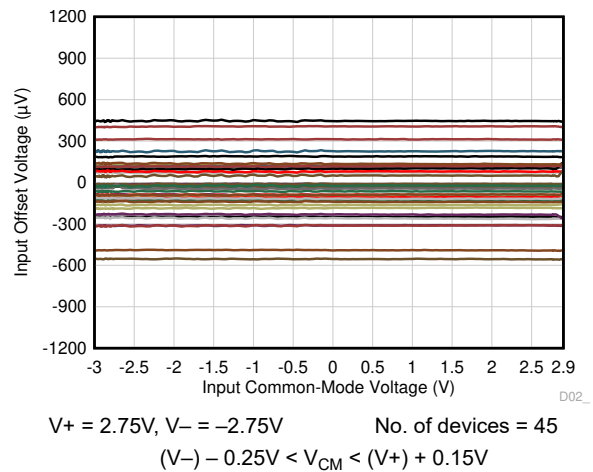

图 6-12. Input Offset Voltage vs Common-Mode

6.8 Typical Characteristics (continued)

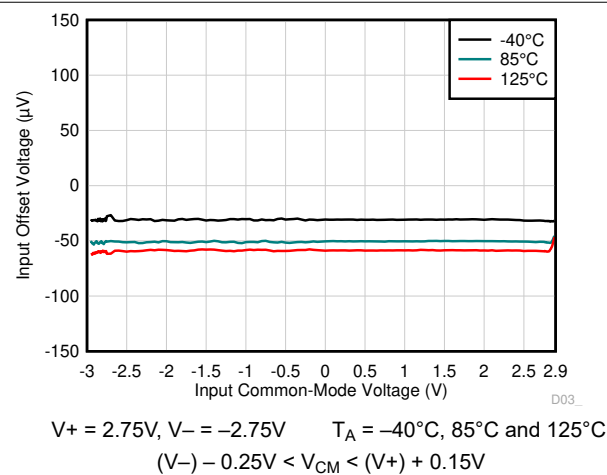
at $T_A = 25^\circ\text{C}$, $V_+ = 2.75\text{V}$, $V_- = -2.75\text{V}$, $R_L = 10\text{k}\Omega$ connected to $V_S / 2$, $V_{CM} = V_S / 2$, and $V_{OUT} = V_S / 2$ (unless otherwise noted)

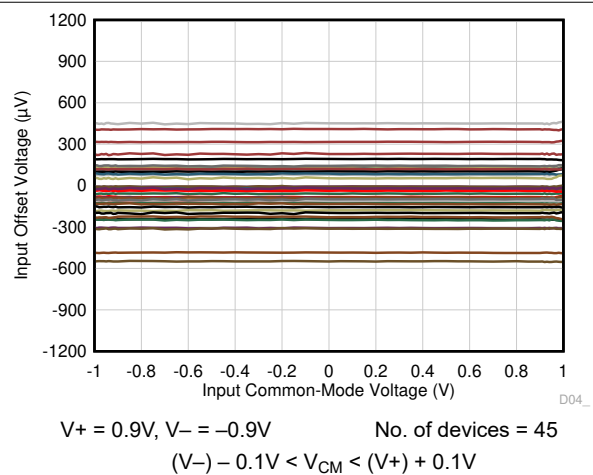
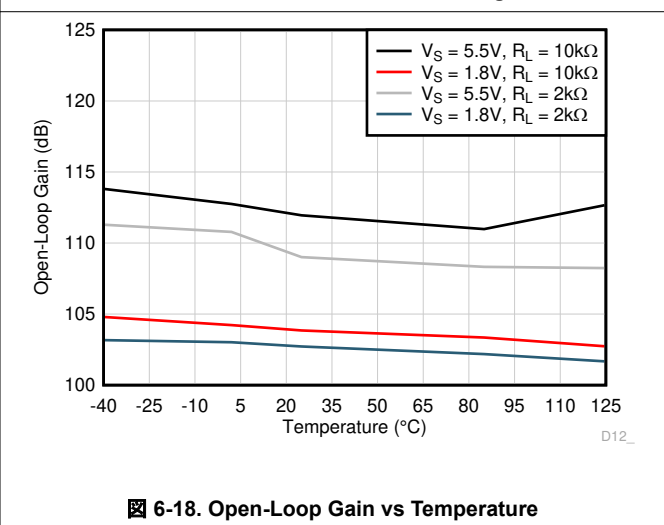
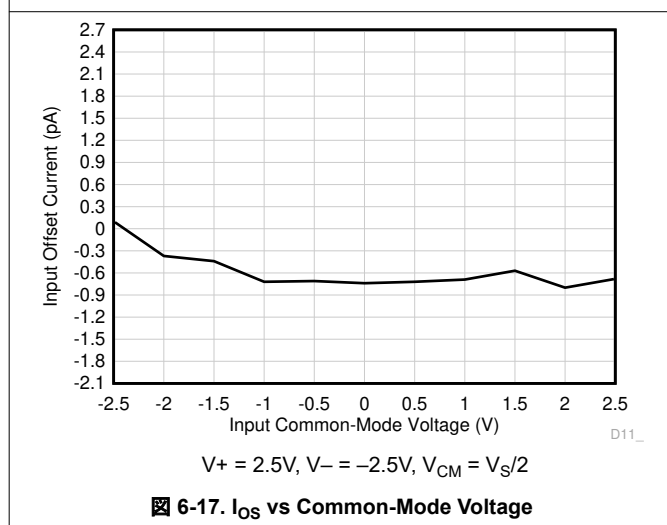
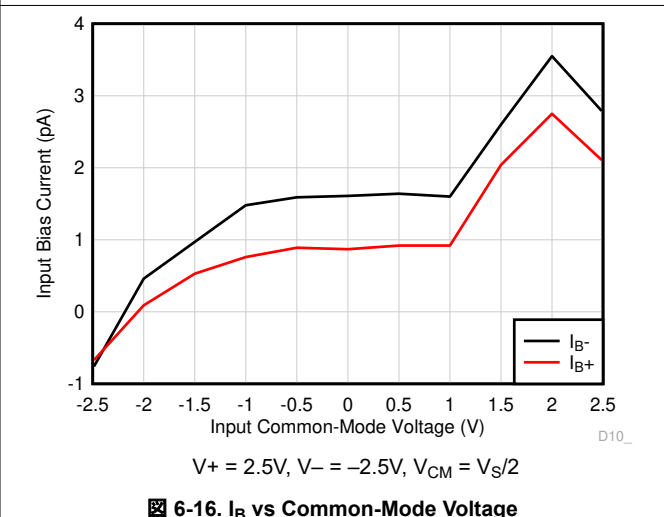
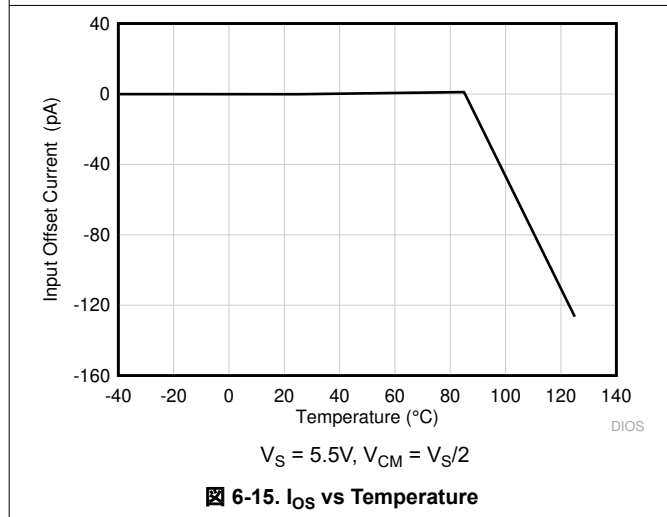
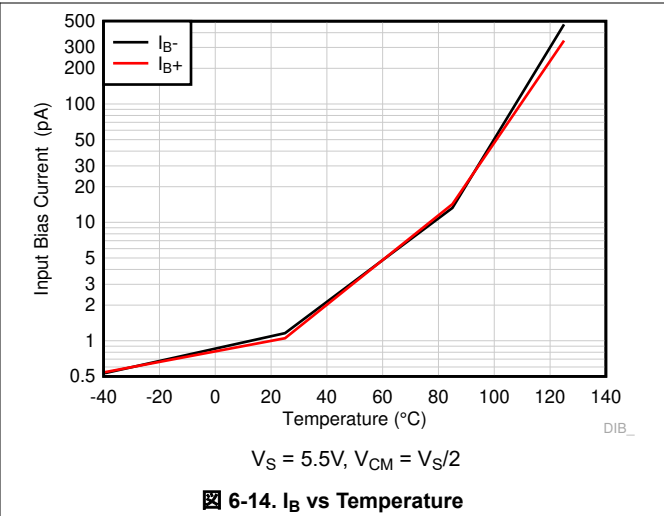
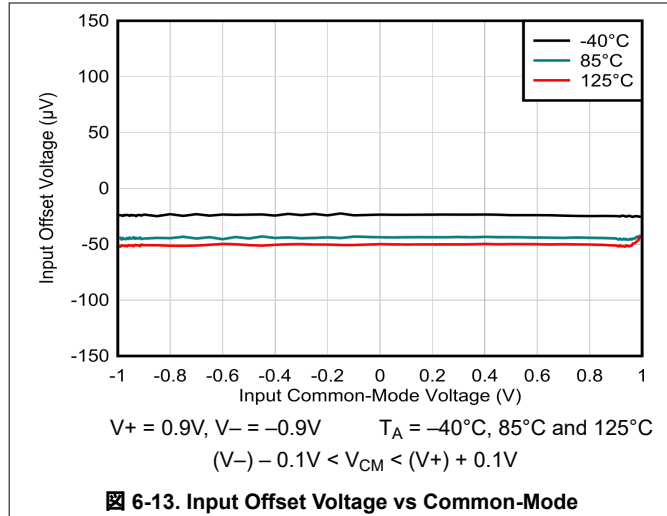

6.8 Typical Characteristics (continued)

at $T_A = 25^\circ\text{C}$, $V_+ = 2.75\text{V}$, $V_- = -2.75\text{V}$, $R_L = 10\text{k}\Omega$ connected to $V_S / 2$, $V_{CM} = V_S / 2$, and $V_{OUT} = V_S / 2$ (unless otherwise noted)

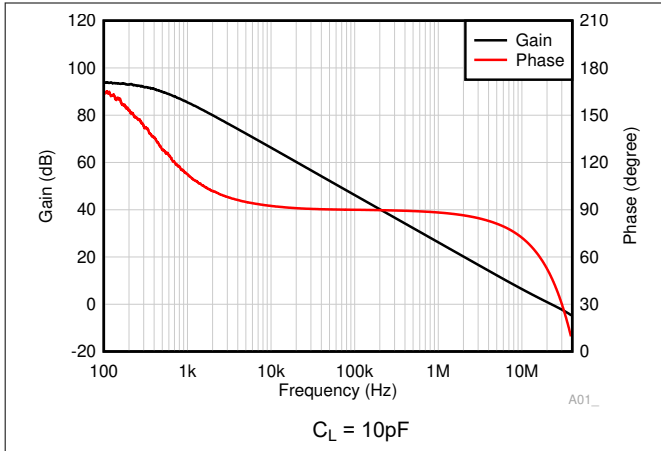

6-19. Open-Loop Gain and Phase vs Frequency

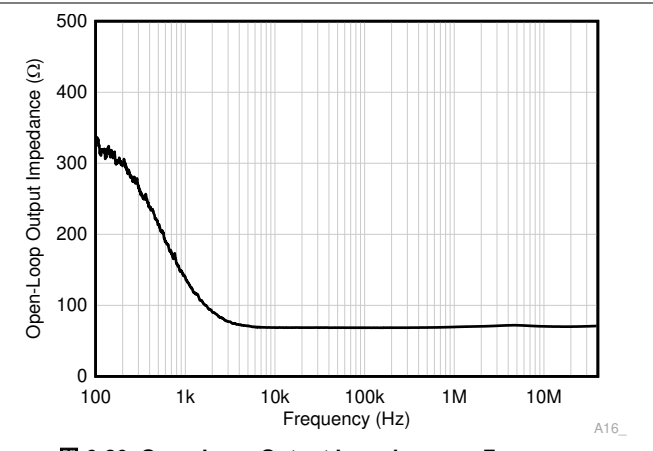

6-20. Open-Loop Output Impedance vs Frequency

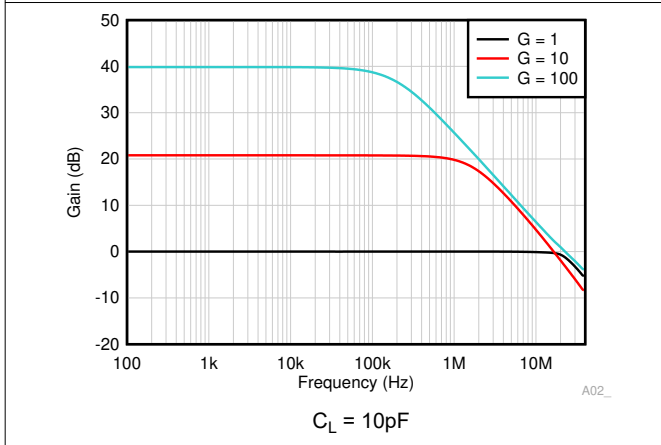

6-21. Closed-Loop Gain vs Frequency

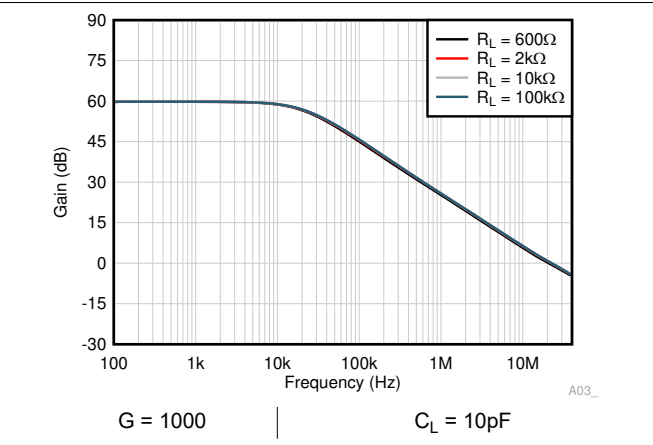

6-22. Closed-Loop Gain vs Frequency

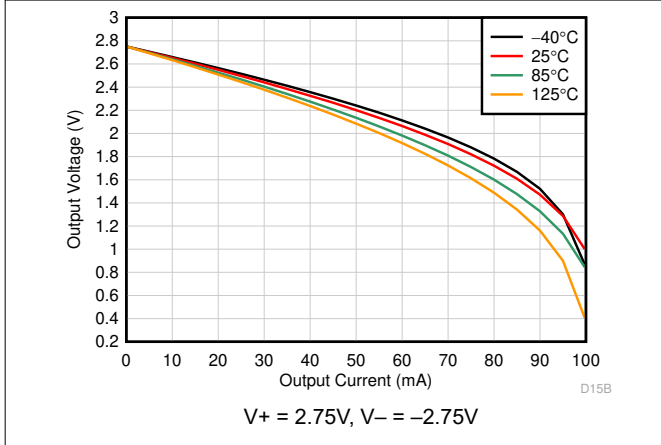

6-23. Output Voltage Swing vs Output Current (Sourcing)

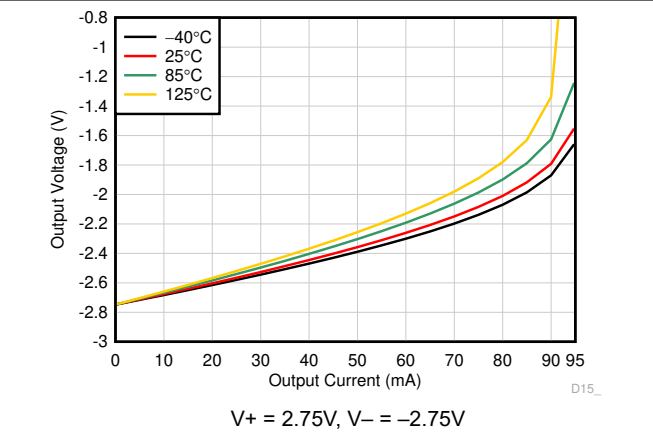

6-24. Output Voltage Swing vs Output Current (Sinking)

6.8 Typical Characteristics (continued)

at $T_A = 25^\circ\text{C}$, $V_+ = 2.75\text{V}$, $V_- = -2.75\text{V}$, $R_L = 10\text{k}\Omega$ connected to $V_S / 2$, $V_{CM} = V_S / 2$, and $V_{OUT} = V_S / 2$ (unless otherwise noted)

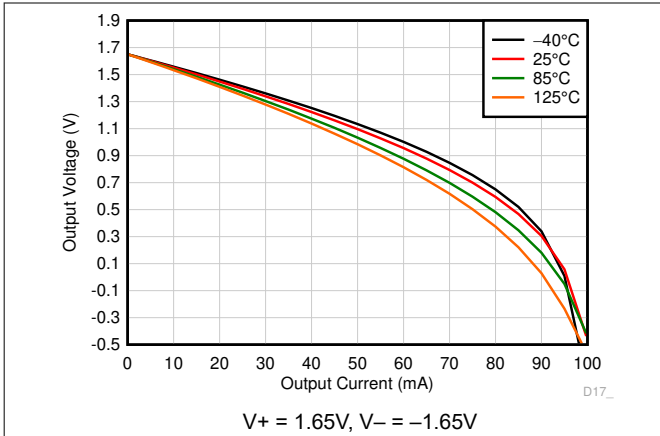

6-25. Output Voltage Swing vs Output Current (Sourcing)

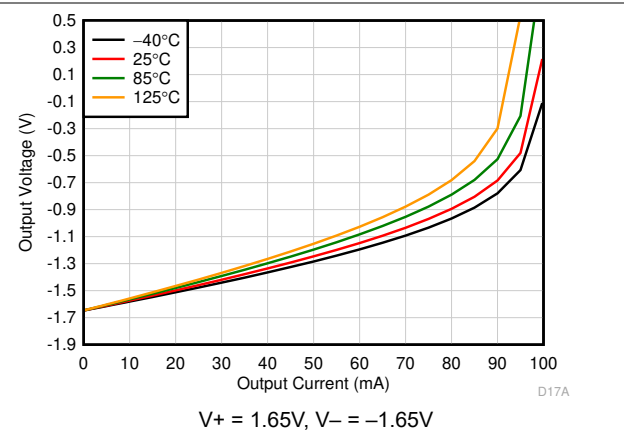

6-26. Output Voltage Swing vs Output Current (Sinking)

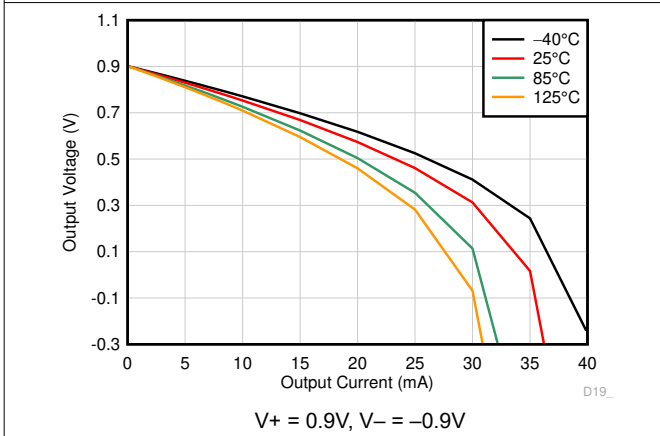

6-27. Output Voltage Swing vs Output Current (Sourcing)

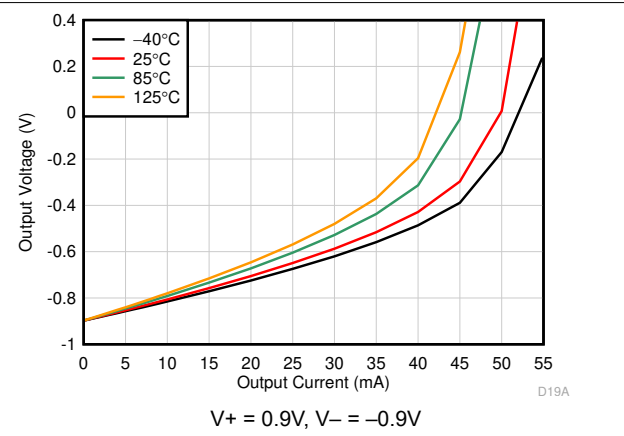

6-28. Output Voltage Swing vs Output Current (Sinking)

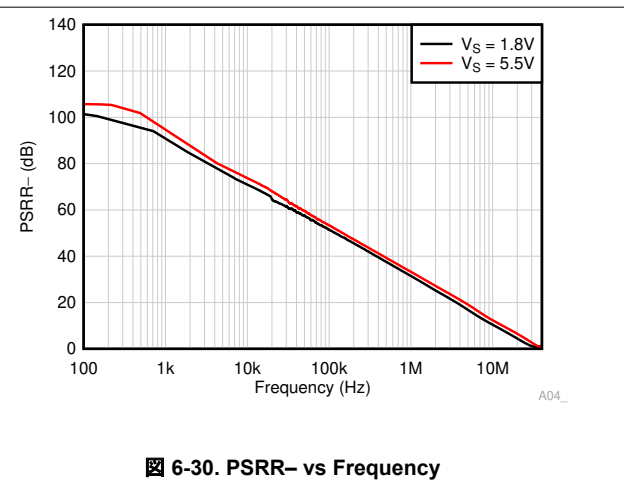
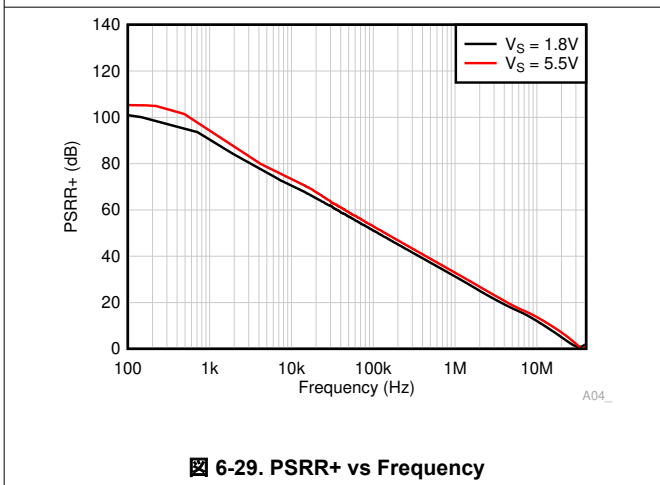

6.8 Typical Characteristics (continued)

at $T_A = 25^\circ\text{C}$, $V_+ = 2.75\text{V}$, $V_- = -2.75\text{V}$, $R_L = 10\text{k}\Omega$ connected to $V_S / 2$, $V_{CM} = V_S / 2$, and $V_{OUT} = V_S / 2$ (unless otherwise noted)

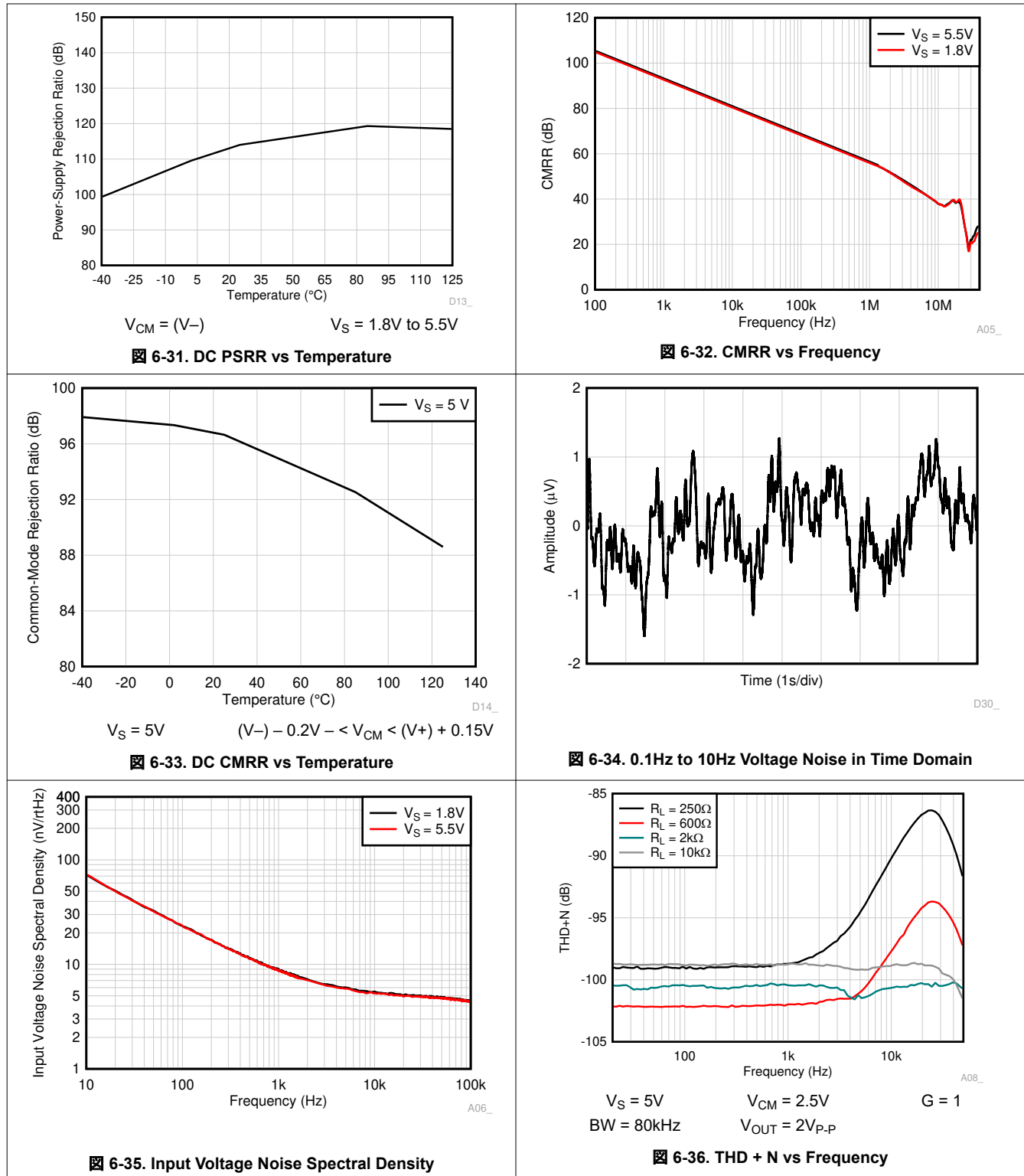

6.8 Typical Characteristics (continued)

at $T_A = 25^\circ\text{C}$, $V_+ = 2.75\text{V}$, $V_- = -2.75\text{V}$, $R_L = 10\text{k}\Omega$ connected to $V_S / 2$, $V_{CM} = V_S / 2$, and $V_{OUT} = V_S / 2$ (unless otherwise noted)

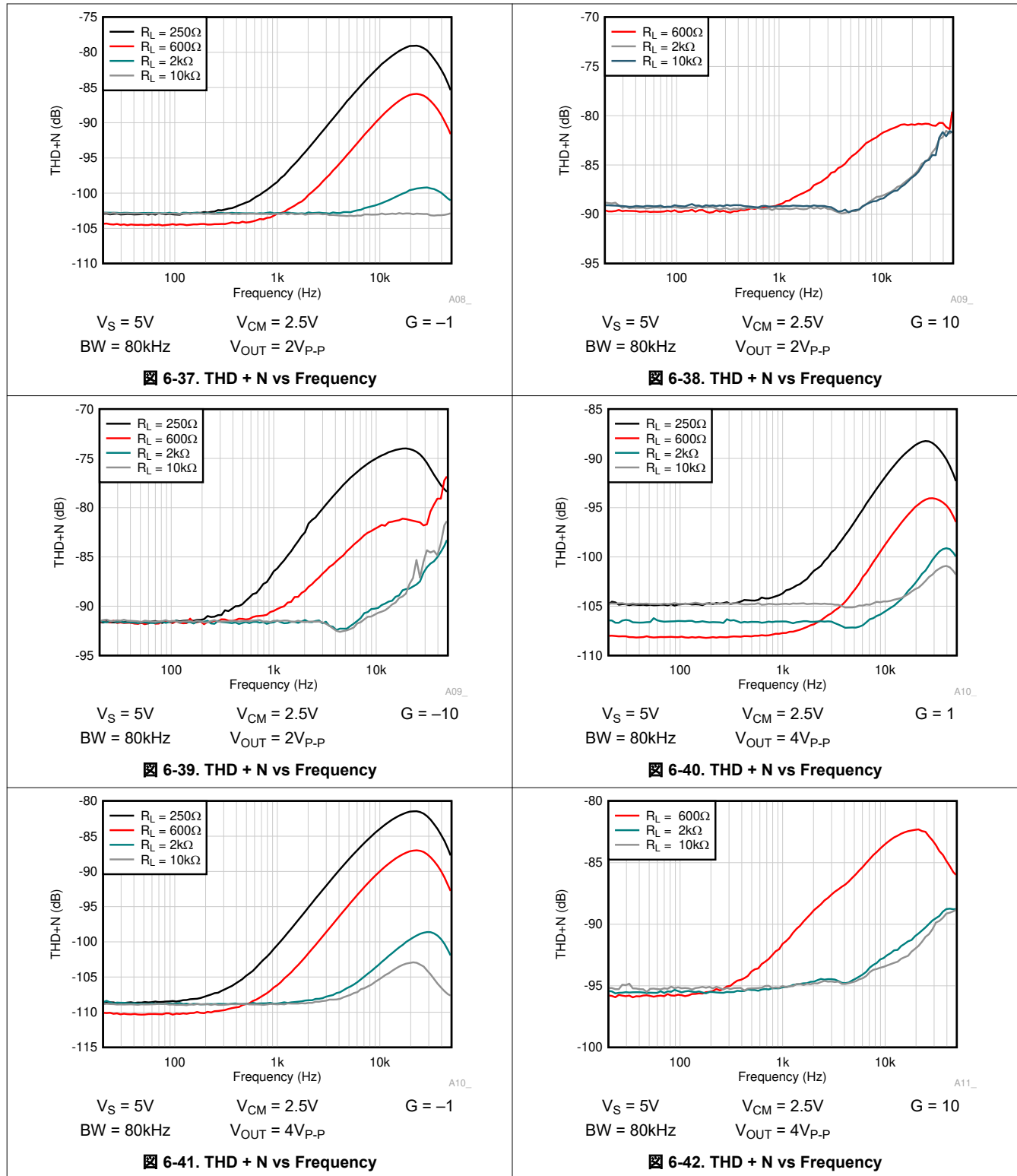

6.8 Typical Characteristics (continued)

at $T_A = 25^\circ\text{C}$, $V_+ = 2.75\text{V}$, $V_- = -2.75\text{V}$, $R_L = 10\text{k}\Omega$ connected to $V_S / 2$, $V_{CM} = V_S / 2$, and $V_{OUT} = V_S / 2$ (unless otherwise noted)



图 6-43. THD + N vs Frequency



图 6-44. THD + N vs Frequency

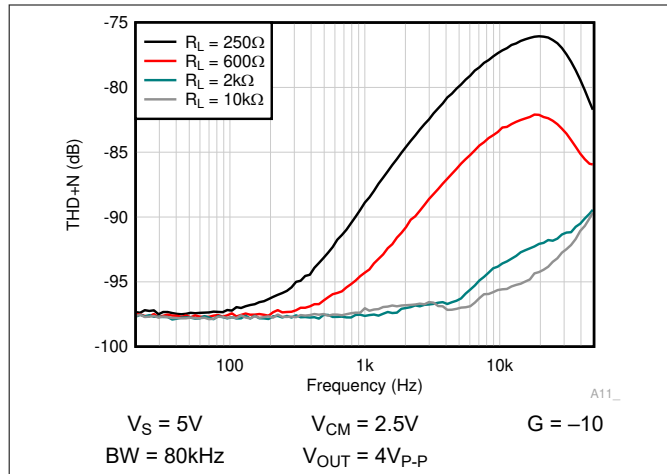

图 6-45. THD + N vs Frequency

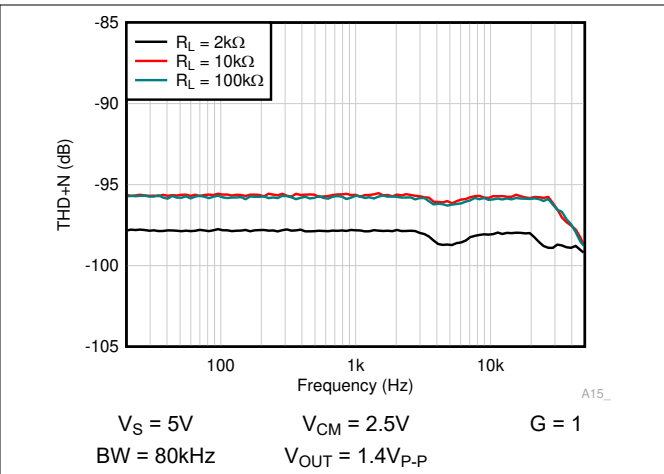

图 6-46. THD + N vs Frequency

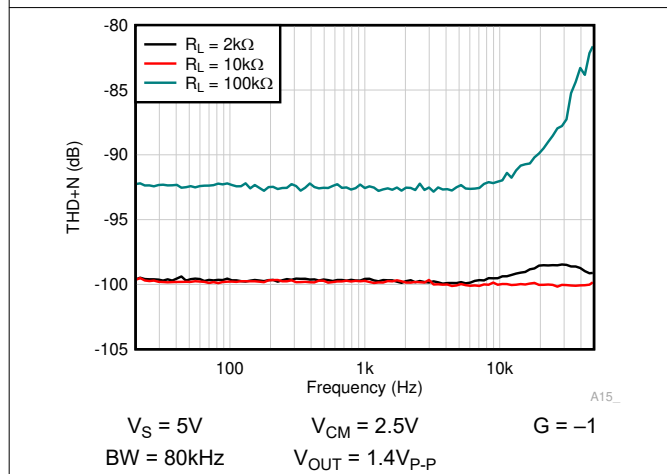

图 6-47. THD + N vs Frequency

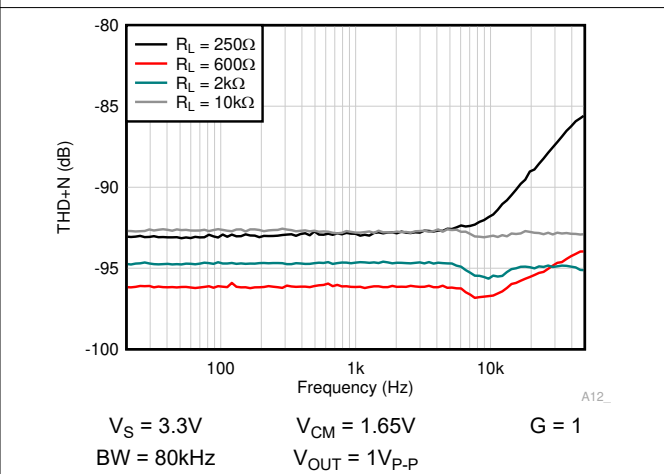

图 6-48. THD + N vs Amplitude

6.8 Typical Characteristics (continued)

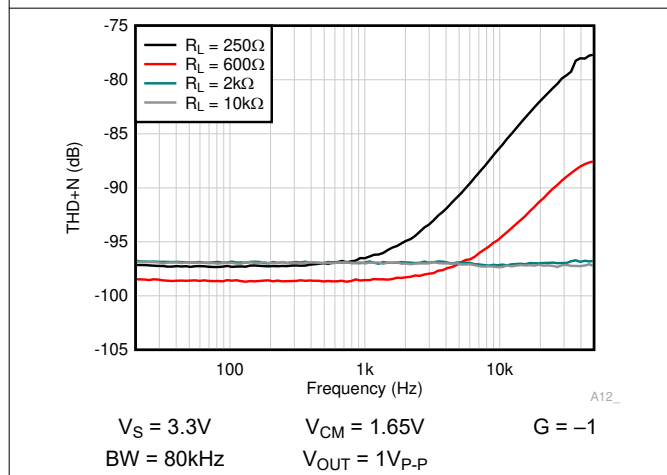
at $T_A = 25^\circ\text{C}$, $V_+ = 2.75\text{V}$, $V_- = -2.75\text{V}$, $R_L = 10\text{k}\Omega$ connected to $V_S / 2$, $V_{CM} = V_S / 2$, and $V_{OUT} = V_S / 2$ (unless otherwise noted)

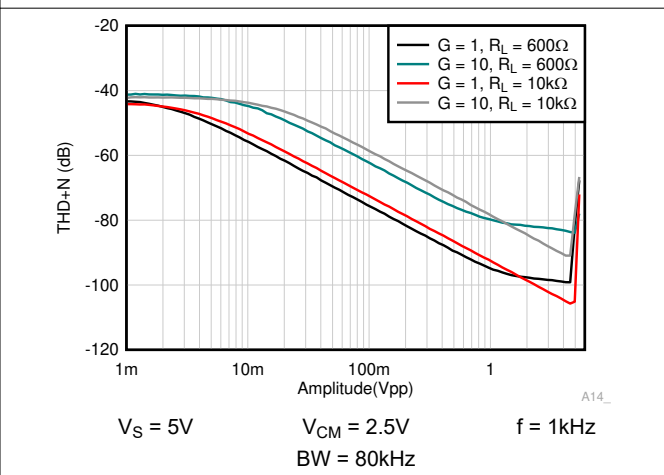
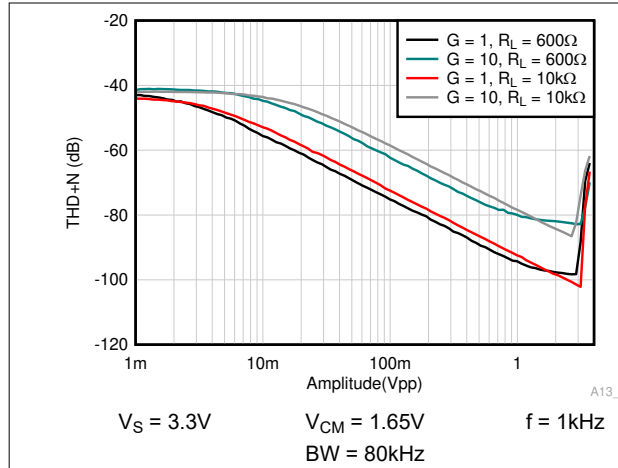

Figure 6-49. THD + N vs Amplitude

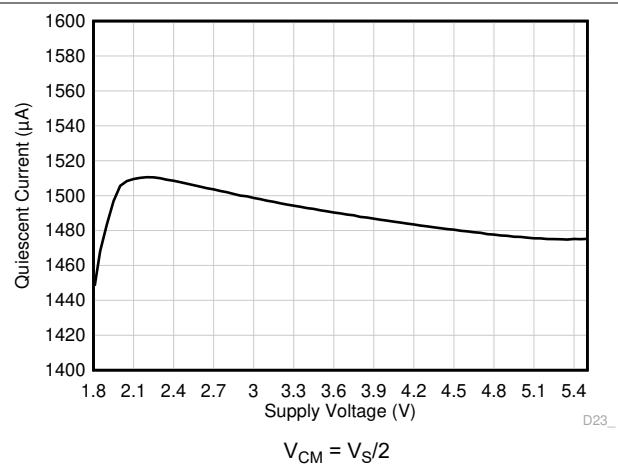

Figure 6-50. Quiescent Current vs Supply Voltage

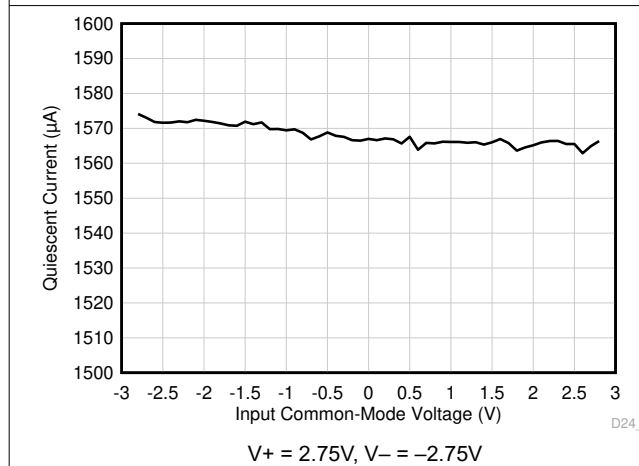

Figure 6-51. Quiescent Current vs Common-Mode Voltage

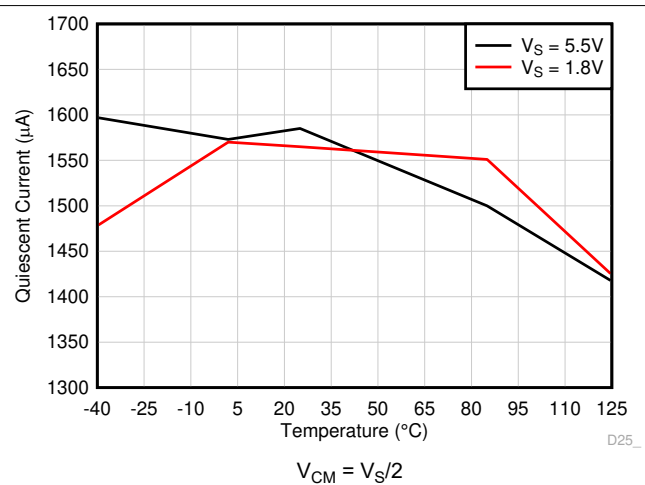

Figure 6-52. Quiescent Current vs Temperature

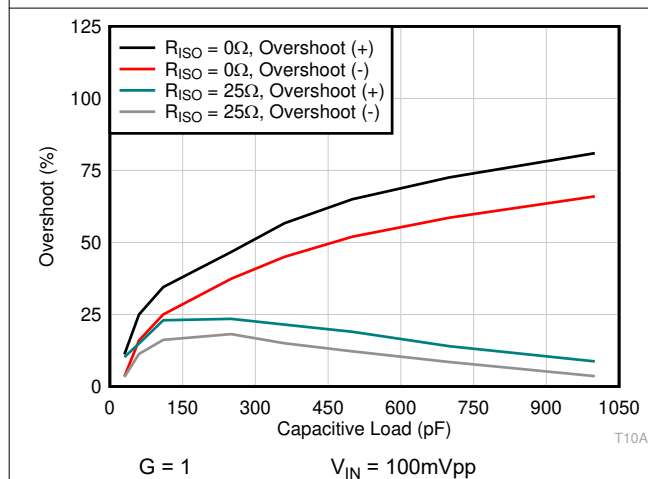

Figure 6-53. Small Signal Overshoot vs Capacitive Load

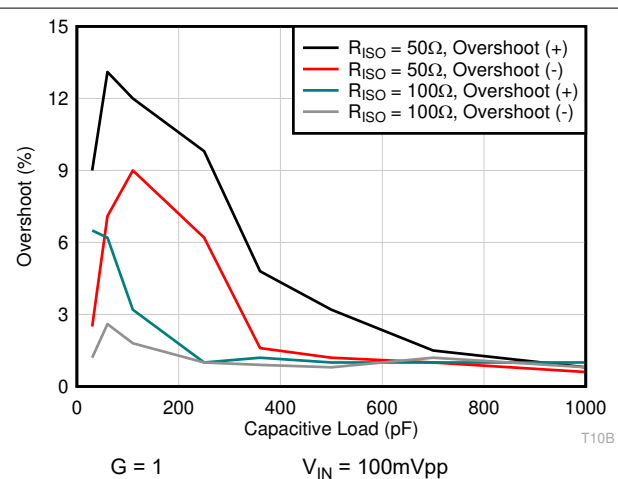
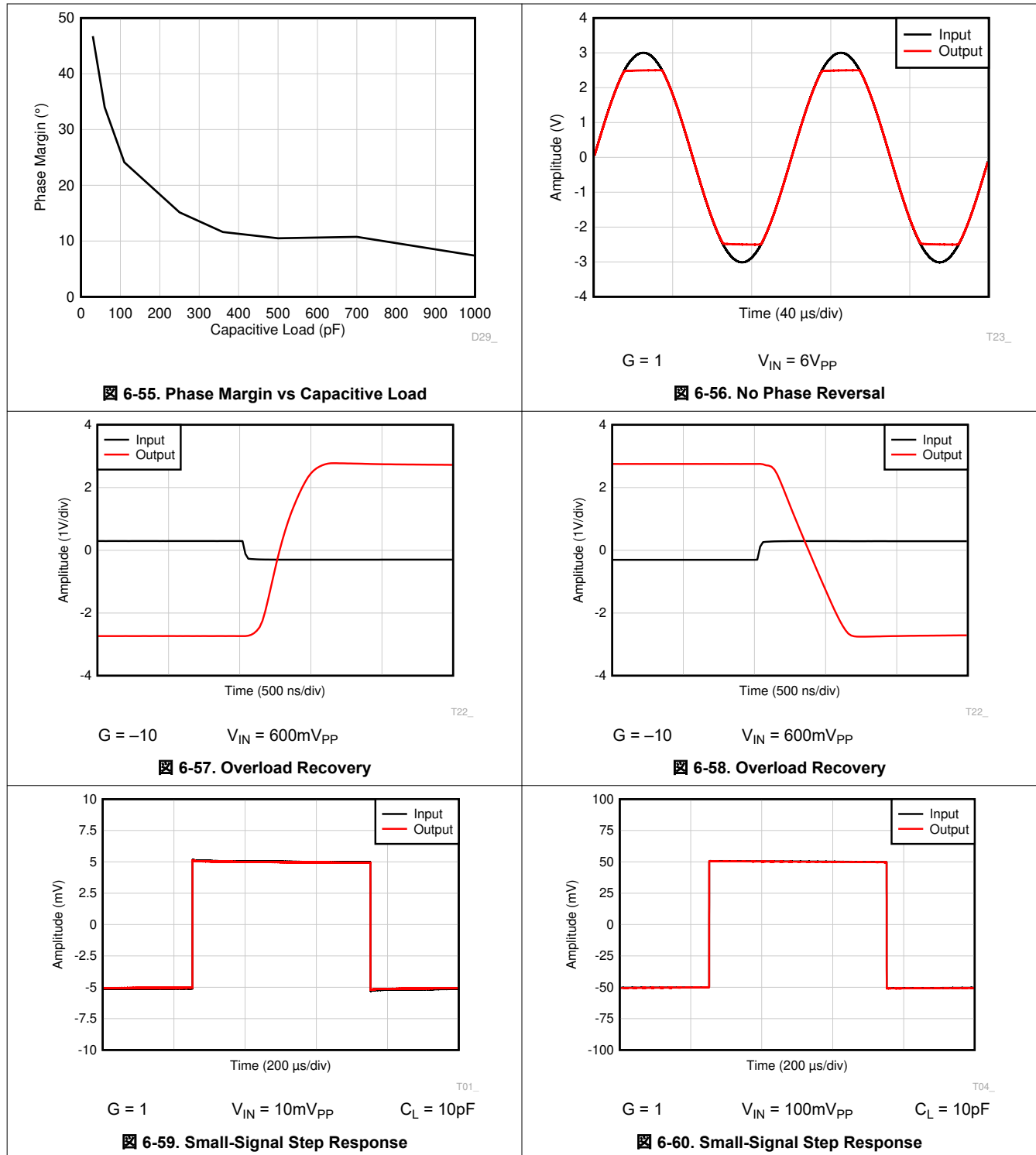

Figure 6-54. Small Signal Overshoot vs Capacitive Load

6.8 Typical Characteristics (continued)

at $T_A = 25^\circ\text{C}$, $V_+ = 2.75\text{V}$, $V_- = -2.75\text{V}$, $R_L = 10\text{k}\Omega$ connected to $V_S / 2$, $V_{CM} = V_S / 2$, and $V_{OUT} = V_S / 2$ (unless otherwise noted)



6.8 Typical Characteristics (continued)

at $T_A = 25^\circ\text{C}$, $V_+ = 2.75\text{V}$, $V_- = -2.75\text{V}$, $R_L = 10\text{k}\Omega$ connected to $V_S / 2$, $V_{CM} = V_S / 2$, and $V_{OUT} = V_S / 2$ (unless otherwise noted)

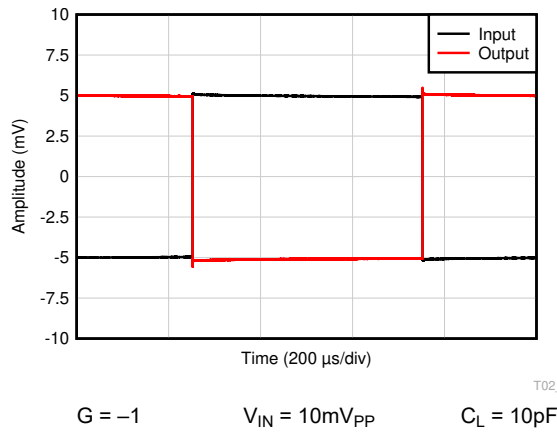

6-61. Small-Signal Step Response

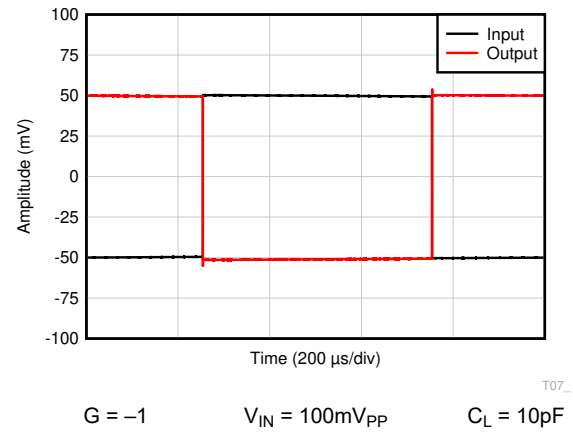

6-62. Small-Signal Step Response

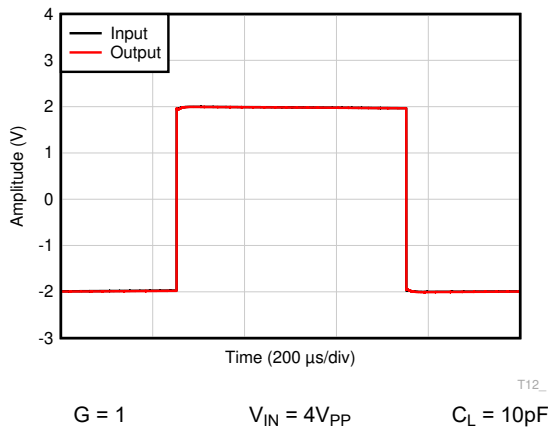

6-63. Large-Signal Step Response

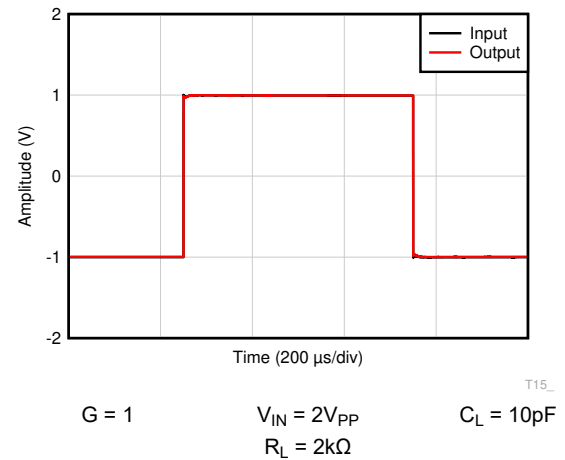

6-64. Large-Signal Step Response

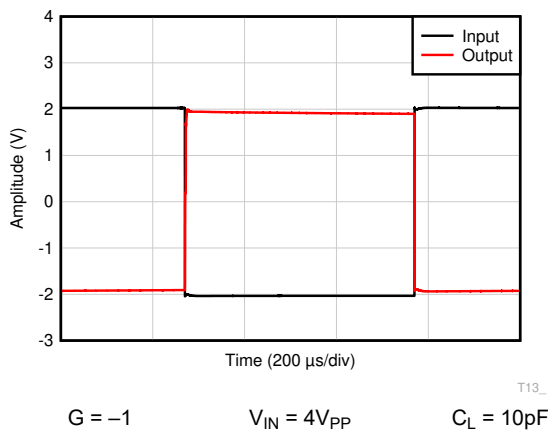

6-65. Large-Signal Step Response

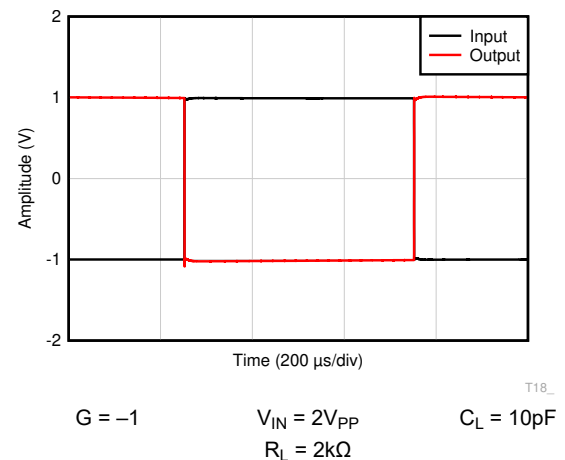

6-66. Large-Signal Step Response

6.8 Typical Characteristics (continued)

at $T_A = 25^\circ\text{C}$, $V_+ = 2.75\text{V}$, $V_- = -2.75\text{V}$, $R_L = 10\text{k}\Omega$ connected to $V_S / 2$, $V_{CM} = V_S / 2$, and $V_{OUT} = V_S / 2$ (unless otherwise noted)

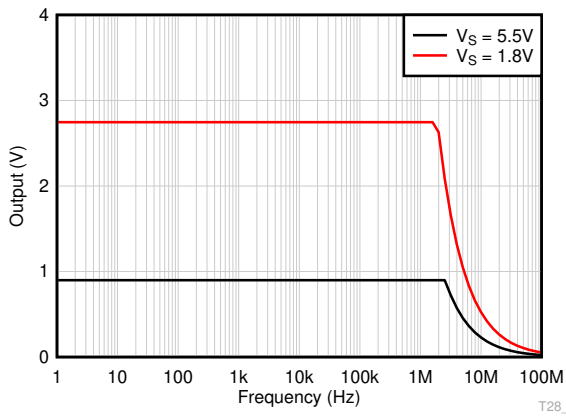

6-67. Maximum Output Voltage vs Frequency

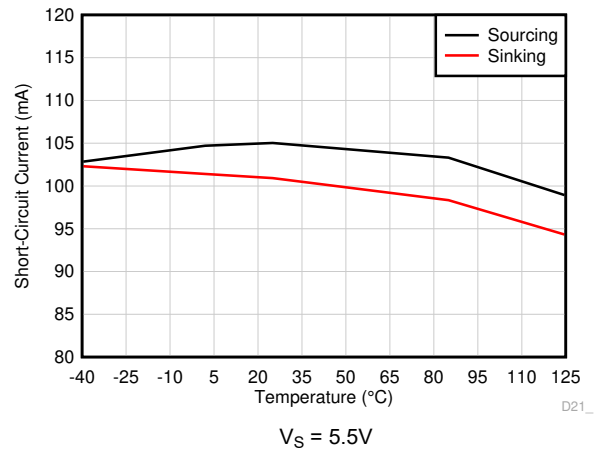

6-68. Short-Circuit Current vs Temperature

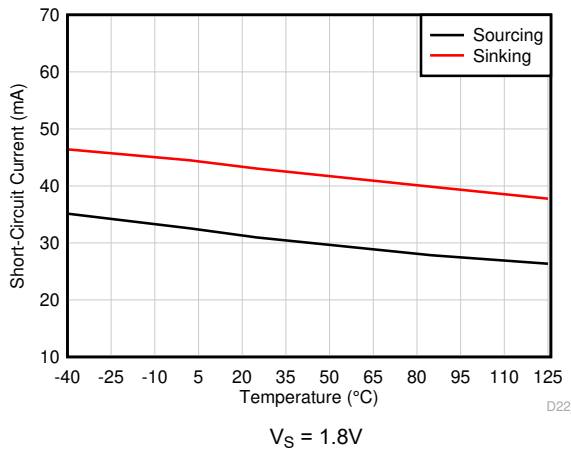

6-69. Short-Circuit Current vs Temperature

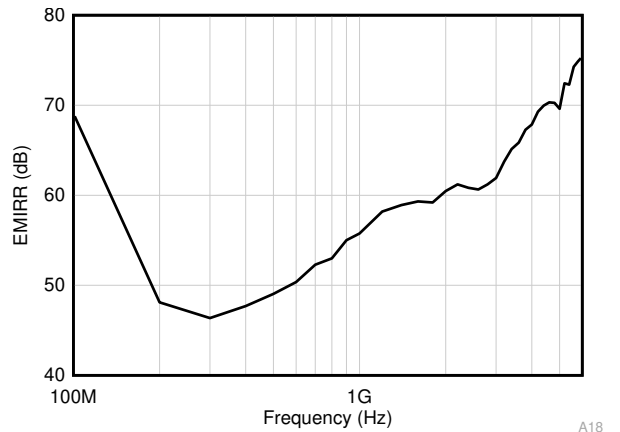

6-70. Electromagnetic Interference Rejection Ratio Referred to Noninverting Input (EMIRR+) vs Frequency

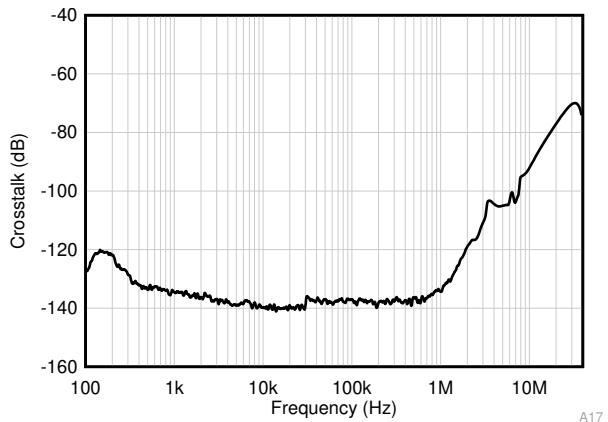

6-71. Channel Separation

7 Detailed Description

7.1 Overview

The OPAx323 family of op amps includes single / dual / quad channel (OPA323, OPA2323, OPA4323), ultra low-voltage (1.7V to 5.5V), high-bandwidth (20MHz) amplifiers. This family of amplifiers feature a zero-crossover input stage and a rail-to-rail output stage that can be used for variety of applications across industrial and automotive markets. The input common-mode voltage range includes signal swing beyond the supply rails, and allows the OPAx323 to be used in many single-supply or dual supply configurations. Rail-to-rail output swing significantly increases dynamic range, especially in low-supply applications with the class AB output stage capable of driving smaller resistive loads.

The OPAx323 family of zero-cross input stage amplifiers achieve high linearity for input signals with rail-to-rail swing that are typical in ADC driver applications in comparison to the complementary input stage amplifiers. Gain-bandwidth of 20MHz helps provide a fast settling response for ADC sampling speeds between 0.5 to 5MSPS depending on the settling performance required. The OPAx323 easily supports precision performance in high gain voltage sensing applications (such as the wheatstone bridge), as the device features maximum offset of 1.25mV and drift of 1.8 μ V/ $^{\circ}$ C. This unique combination of high precision and high gain-bandwidth enables use in multiple applications such as the motor rotary encoders, microphone audio pre-amplifiers and ultrasonic transducers.

The OPAx323 family consumes only 1.6mA supply current per channel for 20MHz gain bandwidth, thus providing a good AC performance at a very low power consumption. These devices achieve a high slew-rate of 33V/ μ s allowing for fast detection of faults in motor current sensing applications. The zero-cross over input stage provides identical AC and DC performance for both low and high-side sensing applications, thus making the OPAx323 the best choice for current sensing in a variety of end equipments such as the solar string inverters, power delivery, grid, and EV infrastructure. Precision transimpedance and voltage gain applications are well served with a low input bias current (0.5pA typical, 20pA maximum), a good PSRR (20 μ V/V maximum), CMRR (100dB minimum), and A_{OL} (114dB minimum). The device has 60 $^{\circ}$ of typical phase margin with no load and drives up to 75pF with a phase margin of 35 $^{\circ}$.

The OPAx323 has an internal current limit that enables additional robustness when operating with high output current while driving smaller output impedance like 68 Ω , 128 Ω , and 256 Ω loads in audio applications. The OPAx323 can swing very close to the rails and has a short circuit current of \pm 80mA minimum at 5.5V power supply. The OPAx323S devices provide shutdown functionality for additional power savings and help disable the amplifier when idle. These op amps feature an integrated radio frequency immunity (RFI) and electro-magnetic interference (EMI) rejection filter, unity-gain stability, and no-phase reversal in input overdrive conditions.

7.2 Functional Block Diagram

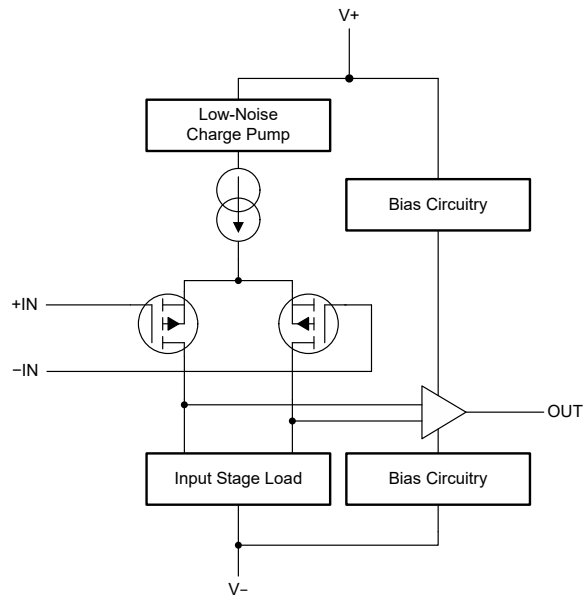

7.3 Feature Description

7.3.1 Operating Voltage

The OPAx323 series of operational amplifiers is fully specified from 1.8V to 5.5V and is designed for amplifier operation from 1.7V to 1.8V. In addition, many specifications apply from -40°C to 125°C . Parameters that vary significantly with operating voltages or temperature are provided in the [Typical Characteristics](#) section. TI highly recommends to add low-ESR ceramic bypass capacitors (C_{BYP}) between each supply pin and ground. Only one C_{BYP} is sufficient for single supply operation. Make sure that C_{BYP} is placed as close to the device as possible and the power supply trace routes through C_{BYP} before reaching the amplifier power supply terminals.

7.3.2 Rail-to-Rail Input

The input common-mode voltage range of the OPAx323 series extends beyond the supply rails with a common-mode rejection ratio (CMRR) of 100dB minimum at 5.5V as specified in [Electrical Characteristics](#). The device is designed to have a good performance of 85dB minimum CMRR even when operating at an ultra-low supply voltage of 1.8V. This is made possible by using a zero-cross input stage architecture for the amplifier input pair.

Most commercial amplifiers employ a complementary input stage architecture which often limits the rail-to-rail CMRR to less than 65dB. This is because the offset performance across the rail-to-rail input common-mode range is not linear. One of the input pairs, usually, the P-channel pair with better offset, noise performance is designed to cover the majority of the common-mode range with the N-channel pair slated to slowly take over at a certain threshold voltage from the positive rail. The creates a big jump in the offset voltage across common mode when transitioning across the input pairs as shown in [TLV900x Offset Voltage vs Common-Mode](#). This offset jump not only affects CMRR but also limits linearity / THD for rail-to-rail input signals.

The OPAx323 achieves linear offset performance over the entire rail-to-rail input range by extending the common-mode-range of a single P-channel input pair using an internal charge pump as shown in the [Functional Block Diagram](#). This eliminates the need for the N-channel input pair and the resulting offset jump caused by input pair transitions.

The OPAx323 exhibits near to zero shift in offset voltage across the entire common-mode voltage as shown in [Figure 7-1](#). This is crucial to achieving high linearity in ADC driver and audio driver applications.

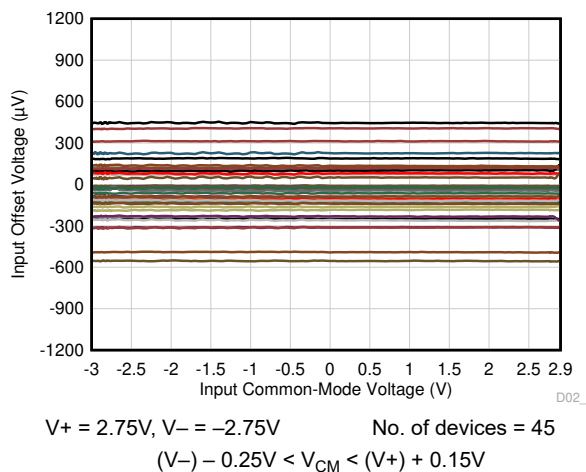

Figure 7-1. OPAx323 Offset Voltage vs Common-Mode

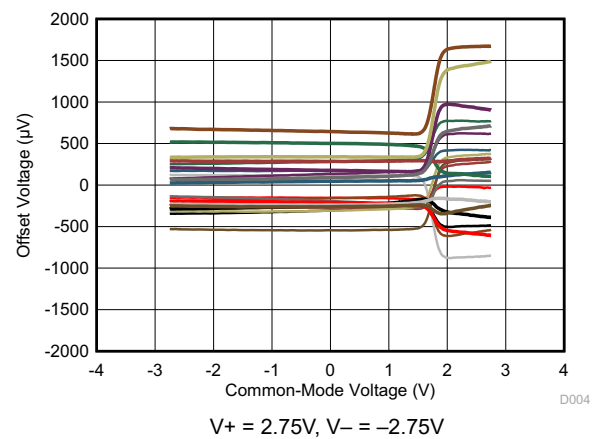

Figure 7-2. TLV900x Offset Voltage vs Common-Mode

7.3.3 Rail-to-Rail Output

The OPAx323 delivers a robust output drive capability. An output stage with common-source transistors is used to achieve full rail-to-rail output swing capability. The device is designed to have a minimum output short circuit current of $\pm 80\text{mA}$, making the device an excellent choice for audio driver applications at room temperature and

at 5.5V. For resistive loads up to 2k Ω and a power supply of 5.5V, the output swings within a maximum of 55mV to either supply rail, thereby using almost the entire input range of an ADC in ADC driver applications.

7.3.4 Common-Mode Rejection Ratio (CMRR)

The OPAX323 achieves excellent DC and AC CMRR performance. The device is designed to have a DC CMRR performance at two supply voltages (5.5V and 1.8V) for the entire operating temperature range (-40°C to 125°C). DC CMRR is specified for common-mode beyond rails over a input voltage range of $(V-) - 0.2\text{V} \leq V_{\text{CM}} \leq (V+) + 0.15\text{V}$ for 5.5V operation and $(V-) - 0.1\text{V} \leq V_{\text{CM}} \leq (V+) + 0.05\text{V}$ for 1.8V operation. AC CMRR is shown in [Typical Characteristics](#) and is subject to the routing of input traces on the PCB board. For good performance, maintain a short and symmetrical input trace for the two amplifier input terminals.

7.3.5 Capacitive Load and Stability

The OPAX323 is designed for use in applications where driving a capacitive load is required. As with all operational amplifiers, there can be specific instances where the device can become unstable. The particular operational amplifier circuit configuration, layout, gain, and output loading are some of the factors to consider when establishing whether or not an amplifier is stable in operation.

An operational amplifier in the unity-gain (1V/V) buffer configuration that drives a capacitive load exhibits a greater tendency to be unstable than an amplifier operating at a higher noise gain. The capacitive load, in conjunction with the operational amplifier output resistance, creates a pole within the feedback loop that degrades the phase margin. The degradation of the phase margin increases when capacitive loading increases. When operating in the unity-gain configuration, the OPAX323 has a phase margin of 50° with 30pF of capacitive load. The device remains stable with pure capacitive loads up to approximately 75pF with acceptable phase margin of 35° and has no sustained oscillations up to 150pF. The equivalent series resistance (ESR) of some very large capacitors (greater than 1 μF) is sometimes sufficient to alter the phase characteristics in the feedback loop such that the amplifier remains stable. Increasing the amplifier closed-loop gain allows the amplifier to drive increasingly larger capacitance. This increased capability is evident when measuring the overshoot response of the amplifier at higher voltage gains.

One technique for increasing the capacitive load drive capability of the amplifier operating in a unity-gain configuration is to insert a small resistor (typically 10 Ω to 50 Ω) in series with the output, as shown in [Figure 7-3](#). This resistor significantly reduces the overshoot and ringing associated with large capacitive loads. This is usually the circuit configuration used in ADC driver application with C_{load} serving as a charge bucket for the ADC sampling capacitor.

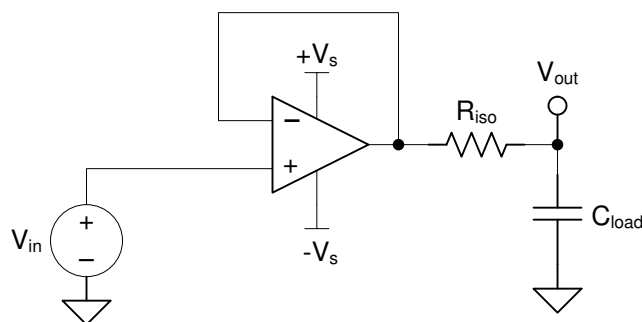

Figure 7-3. Improving Capacitive Load Drive

7.3.6 Overload Recovery

Overload recovery is defined as the time required for the operational amplifier output to recover from a saturated state to a linear state. The output stage of the operational amplifier enters a saturation region when the output voltage exceeds the rated operating voltage, because of the high input voltage or high gain. After one of the outputs enters the saturation region, the output stage requires additional time to return to the linear operating state which is referred to as overload recovery time. After the output stage returns to linear operating state, the

amplifier begins to slew at the specified slew rate. Therefore, the propagation delay (in case of an overload condition) is the sum of the overload recovery time and the slew time.

The overload recovery time for the OPAx323 family is designed to be approximately 130ns typical.

7.3.7 EMI Rejection

The OPAx323 uses integrated electromagnetic interference (EMI) filtering to reduce the effects of EMI from sources such as wireless communications (radio frequency interference - RFI) and densely-populated boards with a mix of analog signal chain and digital components. EMI immunity can be improved with circuit design techniques; the OPAx323 benefits from these design improvements. Texas Instruments has developed the ability to accurately measure and quantify the immunity of an operational amplifier over a broad frequency spectrum extending from 10MHz to 6GHz. [図 7-4](#) shows the results of this testing on the OPAx323. [表 7-1](#) shows the EMIRR IN+ values for the OPAx323 at particular frequencies commonly encountered in real-world applications. The [EMI Rejection Ratio of Operational Amplifiers application report](#) contains detailed information on the topic of EMIRR performance relating to op amps and is available for download from www.ti.com.



図 7-4. EMIRR Testing

表 7-1. OPAX323 EMIRR IN+ for Frequencies of Interest

FREQUENCY	APPLICATION OR ALLOCATION	EMIRR IN+
400MHz	Mobile radio, mobile satellite, space operation, weather, radar, ultra-high frequency (UHF) applications	48dB
900MHz	Global system for mobile communications (GSM) applications, radio communication, navigation, GPS (to 1.6GHz), GSM, aeronautical mobile, UHF applications	56dB
1.8GHz	GSM applications, mobile personal communications, broadband, satellite, L-band (1GHz to 2GHz)	60dB
2.4GHz	802.11b, 802.11g, 802.11n, Bluetooth®, mobile personal communications, industrial, scientific and medical (ISM) radio band, amateur radio and satellite, S-band (2GHz to 4GHz)	61dB
3.6GHz	Radiolocation, aero communication and navigation, satellite, mobile, S-band	67dB
5GHz	802.11a, 802.11n, aero communication and navigation, mobile communication, space and satellite operation, C-band (4GHz to 8GHz)	70dB

7.3.8 ESD and Electrical Overstress

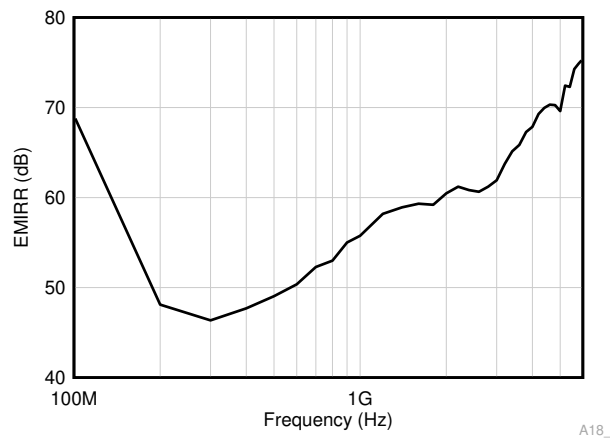
Designers often ask questions about the capability of an operational amplifier to withstand electrical overstress. These questions tend to focus on the device inputs, but can involve the supply voltage pins or even the output pin. Each of these different pin functions have electrical stress limits determined by the voltage breakdown characteristics of the particular semiconductor fabrication process and specific circuits connected to the pin. Additionally, internal electrostatic discharge (ESD) protection is built into these circuits to protect them from accidental ESD events both before and during product assembly.

Having a good understanding of this basic ESD circuitry and relevance to an electrical overstress event is helpful. [Figure 7-5](#) shows the ESD circuits contained in the OPAX323 devices. The ESD protection circuitry involves several current-steering diodes connected from the input and output pins and routed back to the internal power supply lines, where the input and output pins meet at an absorption device internal to the operational amplifier. This protection circuitry is intended to remain inactive during normal circuit operation.

Note that the OPAX323 features no current-steering diodes connected between the input and positive power-supply pin.



図 7-5. Equivalent Internal ESD Circuitry

7.3.9 Input ESD Protection

The OPAX323 family incorporates internal ESD protection circuits on all pins. For inputs, this protection primarily consists of fail safe ESD input structures which feature no current-steering diodes connected between the input and positive power-supply pin as shown in the [Figure 7-5](#). This feature is very useful during power sequencing scenarios where input signal can be present before the positive power supply rail. A fail safe input ESD structure

prevents any short between inputs and positive power supply. For further details, refer to [Op Amp ESD Protection Structures](#) application note.

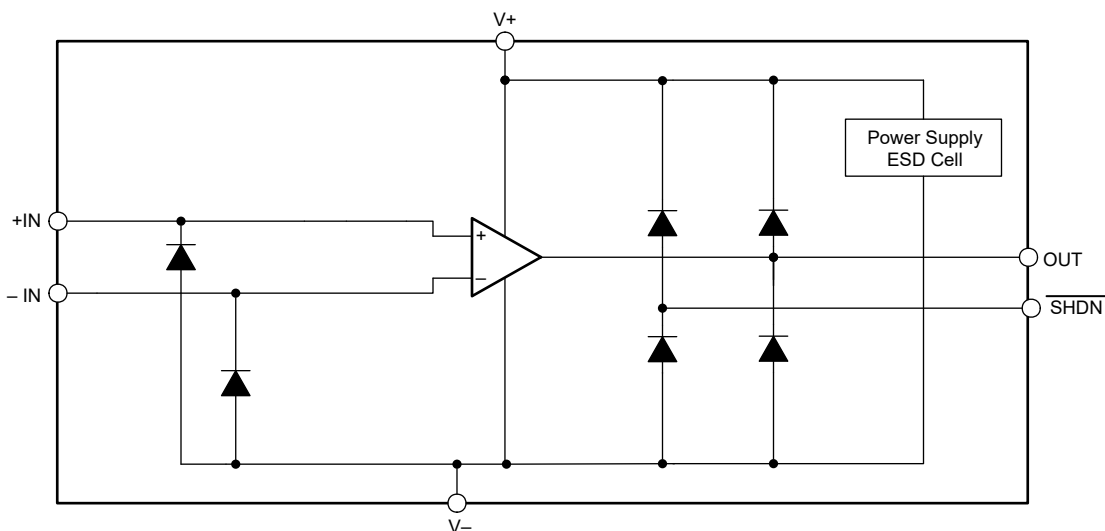
7.3.10 Shutdown Function

The OPAx323S devices feature $\overline{\text{SHDN}}$ pins that disable the op amp, placing the op amp into a low-power standby mode. In this mode, the op amp typically consumes less than 1000nA at room temperature. The $\overline{\text{SHDN}}$ pins are active low, meaning that shutdown mode is enabled when the input to the $\overline{\text{SHDN}}$ pin is a valid logic low.

The $\overline{\text{SHDN}}$ pins are referenced to the negative supply voltage of the op amp. The threshold of the shutdown feature lies around 500mV (typical) and does not change with respect to the supply voltage. Hysteresis has been included in the switching threshold to provide for smooth switching characteristics. For optimal shutdown behavior, the $\overline{\text{SHDN}}$ pins must be driven with valid logic signals. A valid logic low is defined as a voltage between V^- and $(V^-) + 0.2V$. A valid logic high is defined as a voltage between $(V^-) + 1V$ and V^+ . To enable the amplifier, the $\overline{\text{SHDN}}$ pins must be driven to a valid logic high. To disable the amplifier, the $\overline{\text{SHDN}}$ pins must be driven to a valid logic low. TI highly recommends to not leave the shutdown pin floating, but to connect the shutdown pin to a valid high or low voltage. The maximum voltage allowed at the $\overline{\text{SHDN}}$ pins is $(V^+) + 0.5V$. Exceeding this voltage level damages the device.

The $\overline{\text{SHDN}}$ pins are high-impedance CMOS inputs. Dual op amp versions are independently controlled and quad op amp versions are controlled in pairs with logic inputs. For battery-operated applications, this feature can be used to greatly reduce the average current and extend battery life. The enable and disable time is targeted to be under 1 μ s for full shutdown of all channels. When disabled, the output assumes a high-impedance state. This architecture allows the OPAx323S to operate as a gated amplifier (or to have the device output multiplexed onto a common analog output bus). Shutdown time (t_{OFF}) depends on loading conditions as any charge on the output capacitor needs to be discharged by any external resistive load or the op-amp. To achieve the 1 μ s shutdown time, the specified 10k Ω load to midsupply ($V_S / 2$) is required with no capacitive load.

7.3.11 Packages with an Exposed Thermal Pad

The OPAx323 family is available in packages such as the WQFN-16 (RTE) and WSON-8 (DSG), which feature an exposed thermal pad. Inside the package, the die is attached to this thermal pad using an electrically conductive compound. For this reason, when using a package with an exposed thermal pad, the thermal pad must be connected to V₋. Attaching the thermal pad to a potential other than V₋ is not allowed, and the performance of the device may not be consistent with the [Electrical Characteristics](#) table when doing so.

7.4 Device Functional Modes

The OPAx323 devices have one functional mode. These devices are powered on as long as the power-supply voltage is between 1.7V ($\pm 0.85V$) and 5.5V ($\pm 2.75V$).

The OPAx323S devices feature a shutdown pin, which can be used to place the op amp into a low-power mode. For more information, see the [Shutdown Function](#) section.

8 Application and Implementation

注

Information in the following applications sections is not part of the TI component specification, and TI does not warrant its accuracy or completeness. TI's customers are responsible for determining suitability of components for their purposes, as well as validating and testing their design implementation to confirm system functionality.

8.1 Application Information

The OPAx323 family of rail-to-rail input and output operational amplifiers is specifically designed for variety of high gain and high speed applications. These devices operate from 1.7V to 5.5V, are unity-gain stable, and are also an excellent choice for a wide range of general-purpose applications. The output stage is capable of driving small resistive loads connected to any point between V+ and V– as long as the device is not forced into short circuit mode. The input common-mode voltage range includes beyond the rail signal swing and allows the OPAx323 series to be used in many single-supply or dual supply configurations.

8.2 Typical Application

8.2.1 OPAx323 in Low-Side, Current Sensing Application

☒ 8-1 shows the OPA323 configured in a low-side current sensing application.

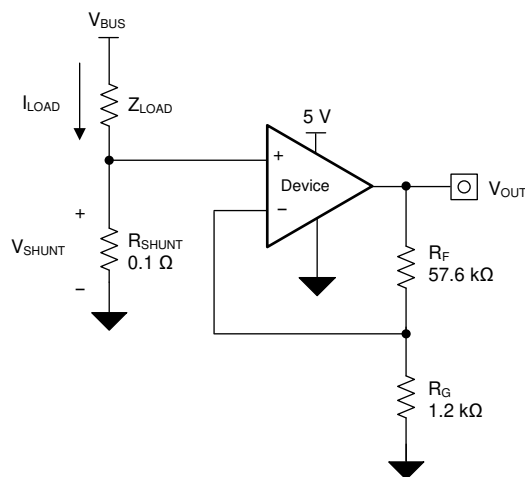

☒ 8-1. OPA323 in a Low-Side, Current-Sensing Application

8.2.1.1 Design Requirements

The design requirements for this design are:

- Load current: 0A to 1A
- Maximum output voltage: 4.9V
- Maximum shunt voltage: 100mV

8.2.1.2 Detailed Design Procedure

The transfer function of the circuit in [Figure 8-1](#) is given in [Equation 1](#).

$$V_{OUT} = I_{LOAD} \times R_{SHUNT} \times \text{Gain} \quad (1)$$

The load current (I_{LOAD}) produces a voltage drop across the shunt resistor (R_{SHUNT}). The load current is set from 0A to 1A. To keep the shunt voltage below 100 mV at maximum load current, the largest shunt resistor is defined using [Equation 2](#).

$$R_{SHUNT} = \frac{V_{SHUNT_MAX}}{I_{LOAD_MAX}} = \frac{100 \text{ mV}}{1 \text{ A}} = 100 \text{ m}\Omega \quad (2)$$

Using [Equation 2](#), R_{SHUNT} is calculated to be 100m Ω . The voltage drop produced by I_{LOAD} and R_{SHUNT} is amplified by the OPA323 to produce an output voltage of approximately 0V to 4.9V. The gain needed by the OPA323 to produce the necessary output voltage is calculated using [Equation 3](#).

$$\text{Gain} = \frac{V_{OUT_MAX} - V_{OUT_MIN}}{V_{IN_MAX} - V_{IN_MIN}} \quad (3)$$

Using [Equation 3](#), the required gain is calculated to be 49V/V, which is set with resistors R_F and R_G . [Equation 4](#) sizes the resistors R_F and R_G , to set the gain of the OPA323 to 49V/V.

$$\text{Gain} = 1 + \frac{R_F}{R_G} \quad (4)$$

Selecting R_F as 57.6k Ω and R_G as 1.2k Ω provides a combination that equals 49V/V. [Figure 8-2](#) shows the measured transfer function of the circuit shown in [Figure 8-1](#). Notice that the gain is only a function of the feedback and gain resistors. This gain is adjusted by varying the ratio of the resistors and the actual resistors values are determined by the impedance levels that the designer wants to establish. The impedance level determines the current drain, the effect that stray capacitance has, and a few other behaviors. There is no optimal impedance selection that works for every system; choose an impedance that is best for the system parameters.

8.2.1.3 Application Curve

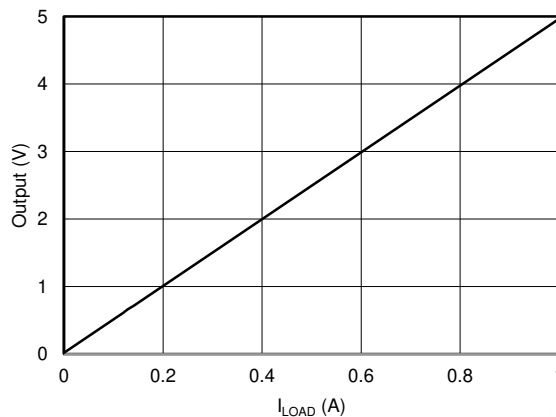

Figure 8-2. Low-Side, Current-Sense Transfer Function

8.3 Power Supply Recommendations

The OPAx323 is tested for amplifier operation at 1.7V and is fully specified from 1.8V to 5.5V ($\pm 0.9V$ to $\pm 2.75V$); many specifications apply from -40°C to 125°C . [Electrical Characteristics](#) presents parameters that can exhibit significant variance regarding operating voltage or temperature.

注意

Supply voltages larger than 7V can permanently damage the device; for more information, see the [Absolute Maximum Ratings](#) table.

TI highly recommends to add low-ESR ceramic bypass capacitors (C_{BYP}) between each supply pin and ground. Only one C_{BYP} is sufficient for single supply operation. Place the C_{BYP} as close to the device as possible to reduce coupling errors from noisy or high-impedance power supplies. Make sure the power supply trace routes through C_{BYP} before reaching the amplifier power supply terminals. For more information, see [Layout Guidelines](#).

8.4 Layout

8.4.1 Layout Guidelines

For best operational performance, use good printed circuit board (PCB) layout practices, including:

- Noise can propagate into analog circuitry through the power connections of the board and propagate to the power pins of the op amp itself. Bypass capacitors are used to reduce the coupled noise by providing a low-impedance path to ground.
 - Connect low-ESR, 0.1 μF ceramic bypass capacitors between each supply pin and ground, placed as close to the device as possible. One bypass capacitor from $V+$ to ground is adequate for single-supply applications.
- Separate grounding for analog and digital portions of circuitry is one of the simplest and most effective methods of noise suppression. One or more layers on multilayer PCBs are usually devoted to ground planes. A ground plane helps distribute heat and reduces electromagnetic interference (EMI) noise pickup. Take care to physically separate digital and analog grounds, paying attention to the flow of the ground current.
- To reduce parasitic coupling, run the input traces as far away from the supply or output traces as possible. If these traces cannot be kept separate, then cross the sensitive trace at a 90 degree angle, which is much better as opposed to running the traces in parallel with the noisy trace.
- Place the external components as close to the device as possible, as shown in [Layout Example](#). Keeping R_1 and R_2 close to the inverting input minimizes parasitic capacitance.
- Keep the length of input traces as short as possible. Remember that the input traces are the most sensitive part of the circuit.
- Consider a driven, low-impedance guard ring around the critical traces. A guard ring can significantly reduce leakage currents from nearby traces that are at different potentials.
- TI recommends cleaning the PCB following board assembly for best performance.
- Any precision integrated circuit can experience performance shifts resulting from moisture ingress into the plastic package. Following any aqueous PCB cleaning process, TI recommends baking the PCB assembly to remove moisture introduced into the device packaging during the cleaning process. A low-temperature, post-cleaning bake at 85°C for 30 minutes is sufficient for most circumstances.

8.4.2 Layout Example

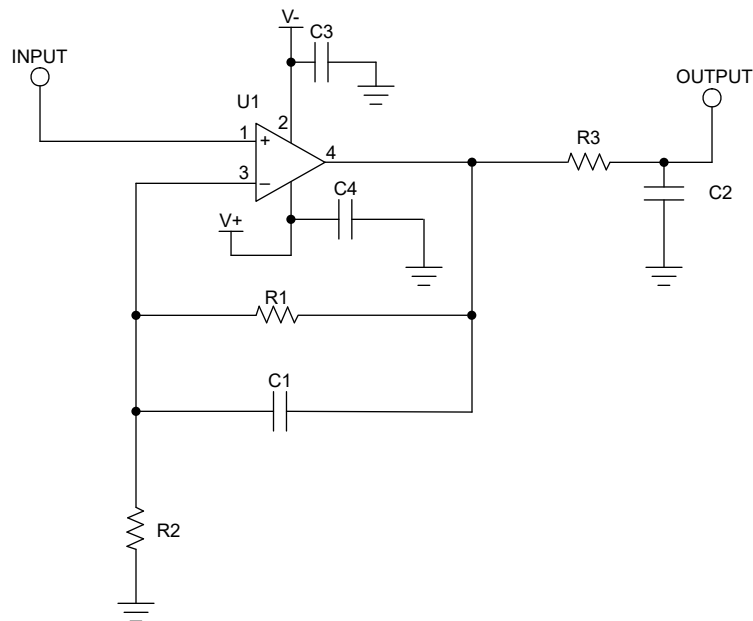

Note: C3 and C4 are C_{BYP} capacitors

图 8-3. Schematic for Noninverting Configuration Layout Example



图 8-4. Operational Amplifier Board Layout for Noninverting Configuration - SC70 (DCK) Package

9 Device and Documentation Support

9.1 Documentation Support

9.1.1 Related Documentation

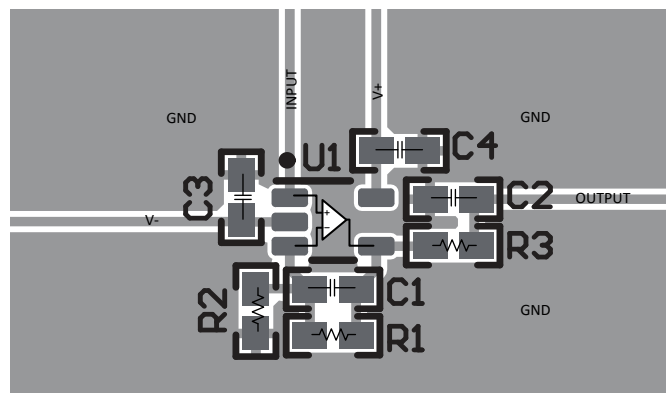
For related documentation see the following:

- Texas Instruments, [QFN/SON PCB Attachment application note](#)
- Texas Instruments, [Quad Flatpack No-Lead Logic Packages application note](#)

9.2 ドキュメントの更新通知を受け取る方法

ドキュメントの更新についての通知を受け取るには、www.tij.co.jp のデバイス製品フォルダを開いてください。[通知] をクリックして登録すると、変更されたすべての製品情報に関するダイジェストを毎週受け取ることができます。変更の詳細については、改訂されたドキュメントに含まれている改訂履歴をご覧ください。

9.3 サポート・リソース

テキサス・インスツルメンツ E2E™ サポート・フォーラムは、エンジニアが検証済みの回答と設計に関するヒントをエキスパートから迅速かつ直接得ることができる場所です。既存の回答を検索したり、独自の質問をしたりすることで、設計に必要な支援を迅速に得ることができます。

リンクされているコンテンツは、各寄稿者により「現状のまま」提供されるものです。これらはテキサス・インスツルメンツの仕様を構成するものではなく、必ずしもテキサス・インスツルメンツの見解を反映したものではありません。テキサス・インスツルメンツの[使用条件](#)を参照してください。

Trademarks

テキサス・インスツルメンツ E2E™ is a trademark of Texas Instruments.

Bluetooth® is a registered trademark of Bluetooth SIG, Inc.

すべての商標は、それぞれの所有者に帰属します。

9.4 静電気放電に関する注意事項



この IC は、ESD によって破損する可能性があります。テキサス・インスツルメンツは、IC を取り扱う際には常に適切な注意を払うことを推奨します。正しい取り扱いおよび設置手順に従わない場合、デバイスを破損するおそれがあります。

ESD による破損は、わずかな性能低下からデバイスの完全な故障まで多岐にわたります。精密な IC の場合、パラメータがわずかに変化するだけで公表されている仕様から外れる可能性があるため、破損が発生しやすくなっています。

9.5 用語集

[テキサス・インスツルメンツ用語集](#) この用語集には、用語や略語の一覧および定義が記載されています。

10 Revision History

資料番号末尾の英字は改訂を表しています。その改訂履歴は英語版に準じています。

Changes from Revision A (November 2023) to Revision B (April 2024)	Page
• DGK (VSSOP, 8), DDF (SOT23-THN) OPA2323 および DYY (SOT23-THN) OPA4323 のステータスを「プレビュー」から「アクティブ」に変更.....	1
• データシートのタイトルで CMRR の値を 100dB から 114dB に変更.....	1
• 「製品情報」表で DYY (SOT-23) パッケージ オプションを 16 ピンから 14 ピンに変更し、パッケージを OPA4323S から OPA4323 へ移動.....	1
• Changed the DYY (SOT-23) package option from 16 to 14 pins and moved the package from OPA4323S to OPA4323 in <i>Device Comparison</i> table.....	3
• Removed OPA4310 information from the data sheet.....	12
• Changed the <i>Typical Characteristics</i> section to add more plots.....	15
• Changed the <i>Rail-to-Rail input</i> section.....	29
• Changed the EMIRR Testing plot in <i>EMI Rejection</i> section.....	31

- Changed the EMIRR IN+ values for the 900MHz, 1.8GHz, 2.4GHz, 3.6GHz, and 5GHz frequency options in *OPAx323 EMIRR IN+ for Frequencies of Interest* table..... [31](#)

Changes from Revision * (October 2023) to Revision A (November 2023)	Page
---	-------------

- | | |
|--|-------------------|
| • DCK (SC70、5) OPA323 のステータスをプレビューからアクティブに変更 | 1 |
| • D (SOIC、8) OPA2323 のステータスをプレビューからアクティブに変更 | 1 |

11 Mechanical, Packaging, and Orderable Information

The following pages include mechanical, packaging, and orderable information. This information is the most current data available for the designated devices. This data is subject to change without notice and revision of this document. For browser-based versions of this data sheet, refer to the left-hand navigation.

重要なお知らせと免責事項

テキサス・インスツルメンツは、技術データと信頼性データ(データシートを含みます)、設計リソース(リファレンス デザインを含みます)、アプリケーションや設計に関する各種アドバイス、Web ツール、安全性情報、その他のリソースを、欠陥が存在する可能性のある「現状のまま」提供しており、商品性および特定目的に対する適合性の黙示保証、第三者の知的財産権の非侵害保証を含むいかなる保証も、明示的または黙示的にかかわらず拒否します。

これらのリソースは、テキサス・インスツルメンツ製品を使用する設計の経験を積んだ開発者への提供を意図したものです。(1) お客様のアプリケーションに適したテキサス・インスツルメンツ製品の選定、(2) お客様のアプリケーションの設計、検証、試験、(3) お客様のアプリケーションに該当する各種規格や、その他のあらゆる安全性、セキュリティ、規制、または他の要件への確実な適合に関する責任を、お客様のみが単独で負うものとします。

上記の各種リソースは、予告なく変更される可能性があります。これらのリソースは、リソースで説明されているテキサス・インスツルメンツ製品を使用するアプリケーションの開発の目的でのみ、テキサス・インスツルメンツはその使用をお客様に許諾します。これらのリソースに関して、他の目的で複製することや掲載することは禁止されています。テキサス・インスツルメンツや第三者の知的財産権のライセンスが付与されている訳ではありません。お客様は、これらのリソースを自身で使用した結果発生するあらゆる申し立て、損害、費用、損失、責任について、テキサス・インスツルメンツおよびその代理人を完全に補償するものとし、テキサス・インスツルメンツは一切の責任を拒否します。

テキサス・インスツルメンツの製品は、[テキサス・インスツルメンツの販売条件](#)、または [ti.com](https://www.ti.com) やかかるテキサス・インスツルメンツ製品の関連資料などのいずれかを通じて提供する適用可能な条項の下で提供されています。テキサス・インスツルメンツがこれらのリソースを提供することは、適用されるテキサス・インスツルメンツの保証または他の保証の放棄の拡大や変更を意味するものではありません。

お客様がいかなる追加条項または代替条項を提案した場合でも、テキサス・インスツルメンツはそれらに異議を唱え、拒否します。

郵送先住所: Texas Instruments, Post Office Box 655303, Dallas, Texas 75265
Copyright © 2024, Texas Instruments Incorporated

PACKAGING INFORMATION

Orderable Device	Status (1)	Package Type	Package Drawing	Pins	Package Qty	Eco Plan (2)	Lead finish/ Ball material (6)	MSL Peak Temp (3)	Op Temp (°C)	Device Marking (4/5)	Samples
OPA2323IDDFR	ACTIVE	SOT-23-THIN	DDF	8	3000	RoHS & Green	NIPDAU	Level-1-260C-UNLIM	-40 to 125	23DDF	Samples
OPA2323IDGKR	ACTIVE	VSSOP	DGK	8	2500	RoHS & Green	NIPDAU	Level-1-260C-UNLIM	-40 to 125	2DGK	Samples
OPA2323IDR	ACTIVE	SOIC	D	8	3000	RoHS & Green	NIPDAU	Level-1-260C-UNLIM	-40 to 125	2323ID	Samples
OPA323IDCKR	ACTIVE	SC70	DCK	5	3000	RoHS & Green	SN	Level-1-260C-UNLIM	-40 to 125	1RG	Samples
OPA4323IDYYR	ACTIVE	SOT-23-THIN	DYY	14	3000	RoHS & Green	NIPDAU	Level-1-260C-UNLIM	125 to -40	O4323IDYYR	Samples
OPA4323IPWR	ACTIVE	TSSOP	PW	14	3000	RoHS & Green	NIPDAU	Level-1-260C-UNLIM	125 to -40	O4323PW	Samples

(1) The marketing status values are defined as follows:

ACTIVE: Product device recommended for new designs.

LIFEBUY: TI has announced that the device will be discontinued, and a lifetime-buy period is in effect.

NRND: Not recommended for new designs. Device is in production to support existing customers, but TI does not recommend using this part in a new design.

PREVIEW: Device has been announced but is not in production. Samples may or may not be available.

OBSELETE: TI has discontinued the production of the device.

(2) **RoHS:** TI defines "RoHS" to mean semiconductor products that are compliant with the current EU RoHS requirements for all 10 RoHS substances, including the requirement that RoHS substance do not exceed 0.1% by weight in homogeneous materials. Where designed to be soldered at high temperatures, "RoHS" products are suitable for use in specified lead-free processes. TI may reference these types of products as "Pb-Free".

RoHS Exempt: TI defines "RoHS Exempt" to mean products that contain lead but are compliant with EU RoHS pursuant to a specific EU RoHS exemption.

Green: TI defines "Green" to mean the content of Chlorine (Cl) and Bromine (Br) based flame retardants meet JS709B low halogen requirements of <=1000ppm threshold. Antimony trioxide based flame retardants must also meet the <=1000ppm threshold requirement.

(3) MSL, Peak Temp. - The Moisture Sensitivity Level rating according to the JEDEC industry standard classifications, and peak solder temperature.

(4) There may be additional marking, which relates to the logo, the lot trace code information, or the environmental category on the device.

(5) Multiple Device Markings will be inside parentheses. Only one Device Marking contained in parentheses and separated by a "-" will appear on a device. If a line is indented then it is a continuation of the previous line and the two combined represent the entire Device Marking for that device.

(6) Lead finish/Ball material - Orderable Devices may have multiple material finish options. Finish options are separated by a vertical ruled line. Lead finish/Ball material values may wrap to two lines if the finish value exceeds the maximum column width.

Important Information and Disclaimer: The information provided on this page represents TI's knowledge and belief as of the date that it is provided. TI bases its knowledge and belief on information provided by third parties, and makes no representation or warranty as to the accuracy of such information. Efforts are underway to better integrate information from third parties. TI has taken and continues to take reasonable steps to provide representative and accurate information but may not have conducted destructive testing or chemical analysis on incoming materials and chemicals. TI and TI suppliers consider certain information to be proprietary, and thus CAS numbers and other limited information may not be available for release.

In no event shall TI's liability arising out of such information exceed the total purchase price of the TI part(s) at issue in this document sold by TI to Customer on an annual basis.

TAPE AND REEL INFORMATION

QUADRANT ASSIGNMENTS FOR PIN 1 ORIENTATION IN TAPE

*All dimensions are nominal

Device	Package Type	Package Drawing	Pins	SPQ	Reel Diameter (mm)	Reel Width W1 (mm)	A0 (mm)	B0 (mm)	K0 (mm)	P1 (mm)	W (mm)	Pin1 Quadrant
OPA2323IDDFR	SOT-23-THIN	DDF	8	3000	180.0	8.4	3.2	3.2	1.4	4.0	8.0	Q3
OPA2323IDGKR	VSSOP	DGK	8	2500	330.0	12.4	5.3	3.4	1.4	8.0	12.0	Q1
OPA2323IDR	SOIC	D	8	3000	330.0	12.4	6.4	5.2	2.1	8.0	12.0	Q1
OPA323IDCKR	SC70	DCK	5	3000	178.0	9.0	2.4	2.5	1.2	4.0	8.0	Q3
OPA4323IDYYR	SOT-23-THIN	DYY	14	3000	330.0	12.4	4.8	3.6	1.6	8.0	12.0	Q3
OPA4323IPWR	TSSOP	PW	14	3000	330.0	12.4	6.9	5.6	1.6	8.0	12.0	Q1

TAPE AND REEL BOX DIMENSIONS

*All dimensions are nominal

Device	Package Type	Package Drawing	Pins	SPQ	Length (mm)	Width (mm)	Height (mm)
OPA2323IDDFR	SOT-23-THIN	DDF	8	3000	210.0	185.0	35.0
OPA2323IDGKR	VSSOP	DGK	8	2500	356.0	356.0	35.0
OPA2323IDR	SOIC	D	8	3000	356.0	356.0	35.0
OPA323IDCKR	SC70	DCK	5	3000	190.0	190.0	30.0
OPA4323IDYYR	SOT-23-THIN	DYY	14	3000	336.6	336.6	31.8
OPA4323IPWR	TSSOP	PW	14	3000	356.0	356.0	35.0

DCK0005A



PACKAGE OUTLINE

SOT - 1.1 max height

SMALL OUTLINE TRANSISTOR

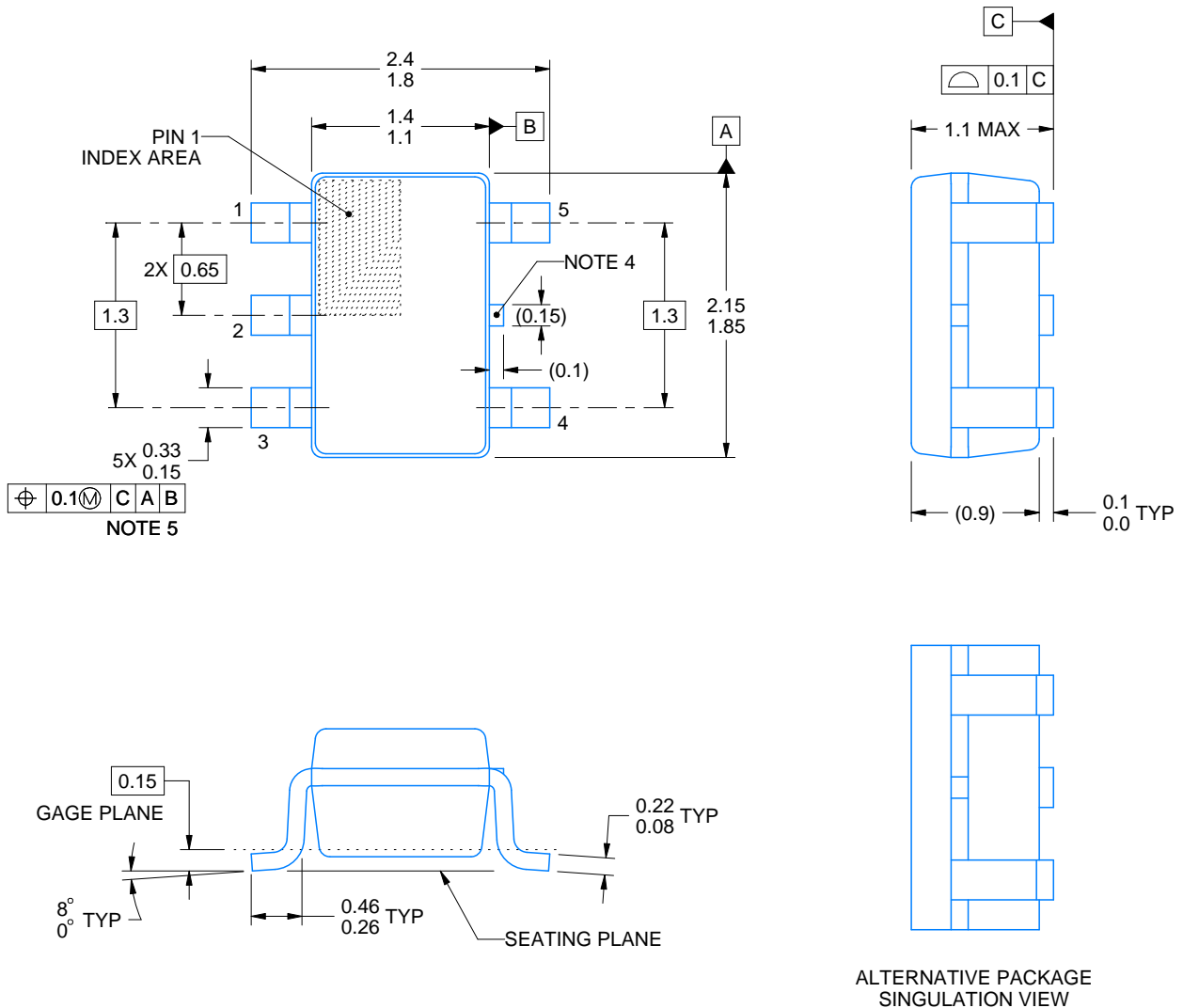

4214834/E 06/2024

NOTES:

1. All linear dimensions are in millimeters. Any dimensions in parenthesis are for reference only. Dimensioning and tolerancing per ASME Y14.5M.
2. This drawing is subject to change without notice.
3. Reference JEDEC MO-203.
4. Support pin may differ or may not be present.
5. Lead width does not comply with JEDEC.
6. Body dimensions do not include mold flash, protrusions, or gate burrs. Mold flash, protrusions, or gate burrs shall not exceed 0.25mm per side

EXAMPLE BOARD LAYOUT

DCK0005A

SOT - 1.1 max height

SMALL OUTLINE TRANSISTOR



LAND PATTERN EXAMPLE
EXPOSED METAL SHOWN
SCALE:18X

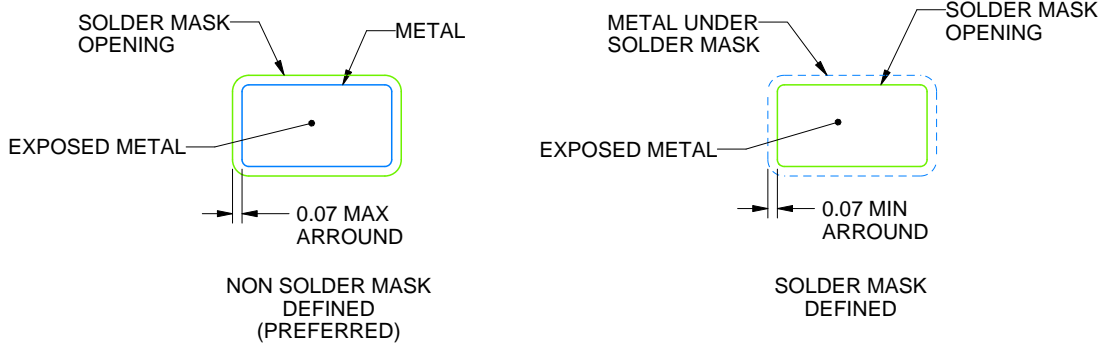

SOLDER MASK DETAILS

4214834/E 06/2024

NOTES: (continued)

- 7. Publication IPC-7351 may have alternate designs.
- 8. Solder mask tolerances between and around signal pads can vary based on board fabrication site.

EXAMPLE STENCIL DESIGN

DCK0005A

SOT - 1.1 max height

SMALL OUTLINE TRANSISTOR



SOLDER PASTE EXAMPLE
BASED ON 0.125 THICK STENCIL
SCALE: 18X

4214834/E 06/2024

NOTES: (continued)

9. Laser cutting apertures with trapezoidal walls and rounded corners may offer better paste release. IPC-7525 may have alternate design recommendations.
10. Board assembly site may have different recommendations for stencil design.

DGK0008A



PACKAGE OUTLINE

VSSOP - 1.1 mm max height

SMALL OUTLINE PACKAGE



NOTES:

PowerPAD is a trademark of Texas Instruments.

1. All linear dimensions are in millimeters. Any dimensions in parenthesis are for reference only. Dimensioning and tolerancing per ASME Y14.5M.
2. This drawing is subject to change without notice.
3. This dimension does not include mold flash, protrusions, or gate burrs. Mold flash, protrusions, or gate burrs shall not exceed 0.15 mm per side.
4. This dimension does not include interlead flash. Interlead flash shall not exceed 0.25 mm per side.
5. Reference JEDEC registration MO-187.

EXAMPLE BOARD LAYOUT

DGK0008A

™ VSSOP - 1.1 mm max height

SMALL OUTLINE PACKAGE



LAND PATTERN EXAMPLE
EXPOSED METAL SHOWN
SCALE: 15X



SOLDER MASK DETAILS

4214862/A 04/2023

NOTES: (continued)

6. Publication IPC-7351 may have alternate designs.
7. Solder mask tolerances between and around signal pads can vary based on board fabrication site.
8. Vias are optional depending on application, refer to device data sheet. If any vias are implemented, refer to their locations shown on this view. It is recommended that vias under paste be filled, plugged or tented.
9. Size of metal pad may vary due to creepage requirement.

EXAMPLE STENCIL DESIGN

DGK0008A

TM VSSOP - 1.1 mm max height

SMALL OUTLINE PACKAGE



SOLDER PASTE EXAMPLE
SCALE: 15X

4214862/A 04/2023

NOTES: (continued)

11. Laser cutting apertures with trapezoidal walls and rounded corners may offer better paste release. IPC-7525 may have alternate design recommendations.
12. Board assembly site may have different recommendations for stencil design.

GENERIC PACKAGE VIEW

RTE 16

WQFN - 0.8 mm max height

3 x 3, 0.5 mm pitch

PLASTIC QUAD FLATPACK - NO LEAD

This image is a representation of the package family, actual package may vary.
Refer to the product data sheet for package details.

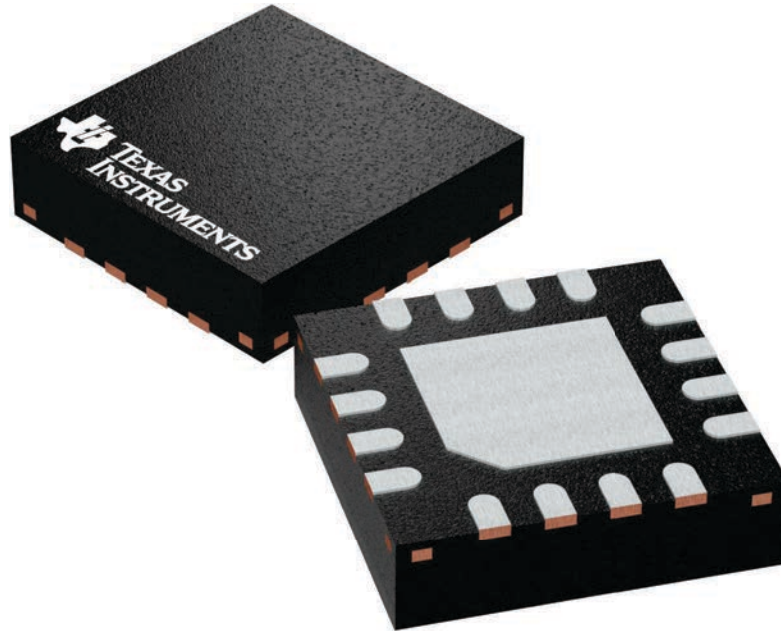

4225944/A

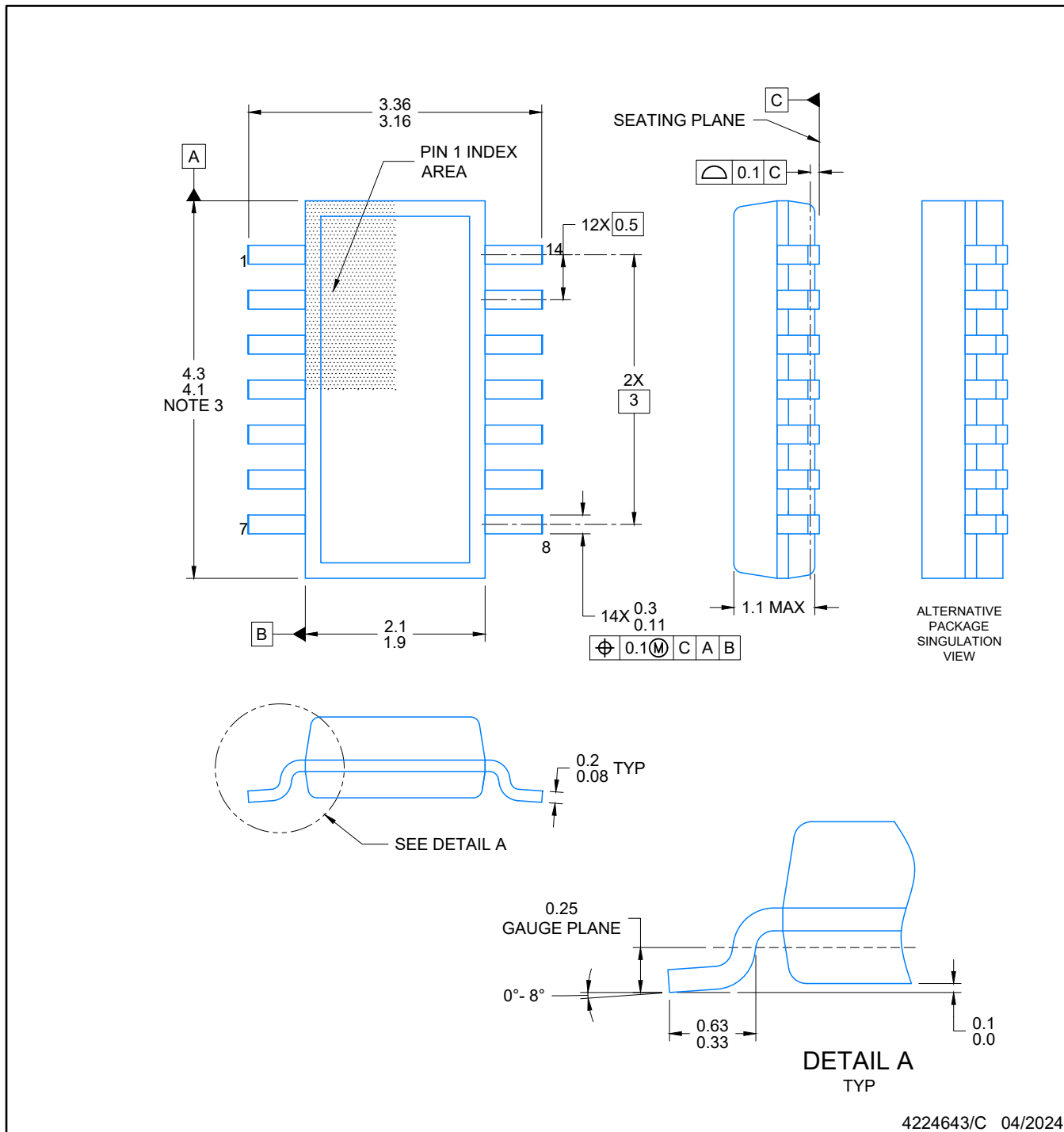

4224643/C 04/2024

NOTES:

1. All linear dimensions are in millimeters. Any dimensions in parenthesis are for reference only. Dimensioning and tolerancing per ASME Y14.5M.
2. This drawing is subject to change without notice.
3. This dimension does not include mold flash, protrusions, or gate burrs. Mold flash, protrusions, or gate burrs shall not exceed 0.15 per side.
4. This dimension does not include interlead flash. Interlead flash shall not exceed 0.50 per side.
5. Reference JEDEC Registration MO-345, Variation AB

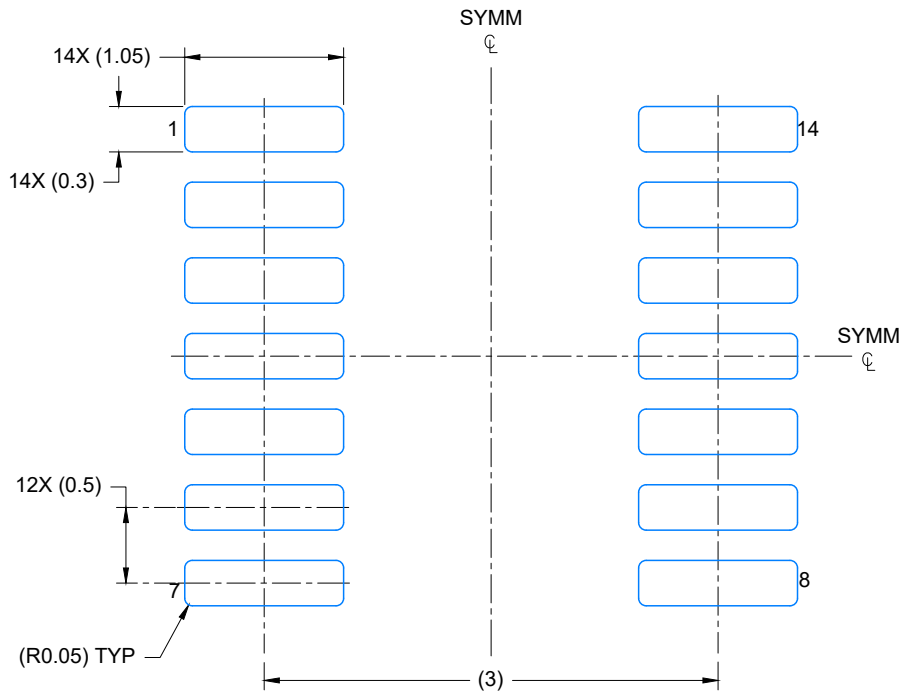

LAND PATTERN EXAMPLE
EXPOSED METAL SHOWN
SCALE: 20X

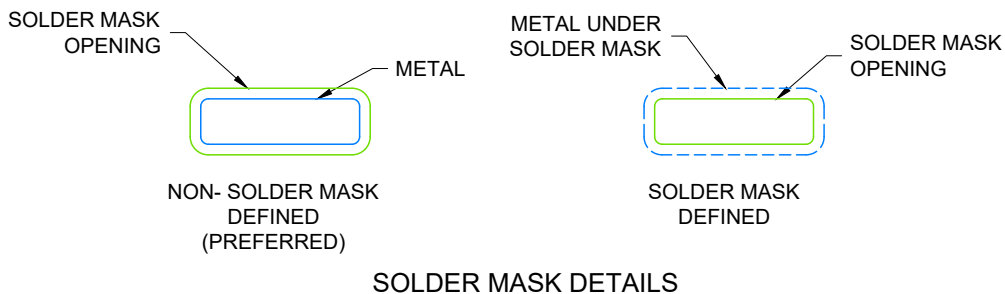

4224643/C 04/2024

NOTES: (continued)

- 6. Publication IPC-7351 may have alternate designs.
- 7. Solder mask tolerances between and around signal pads can vary based on board fabrication site.

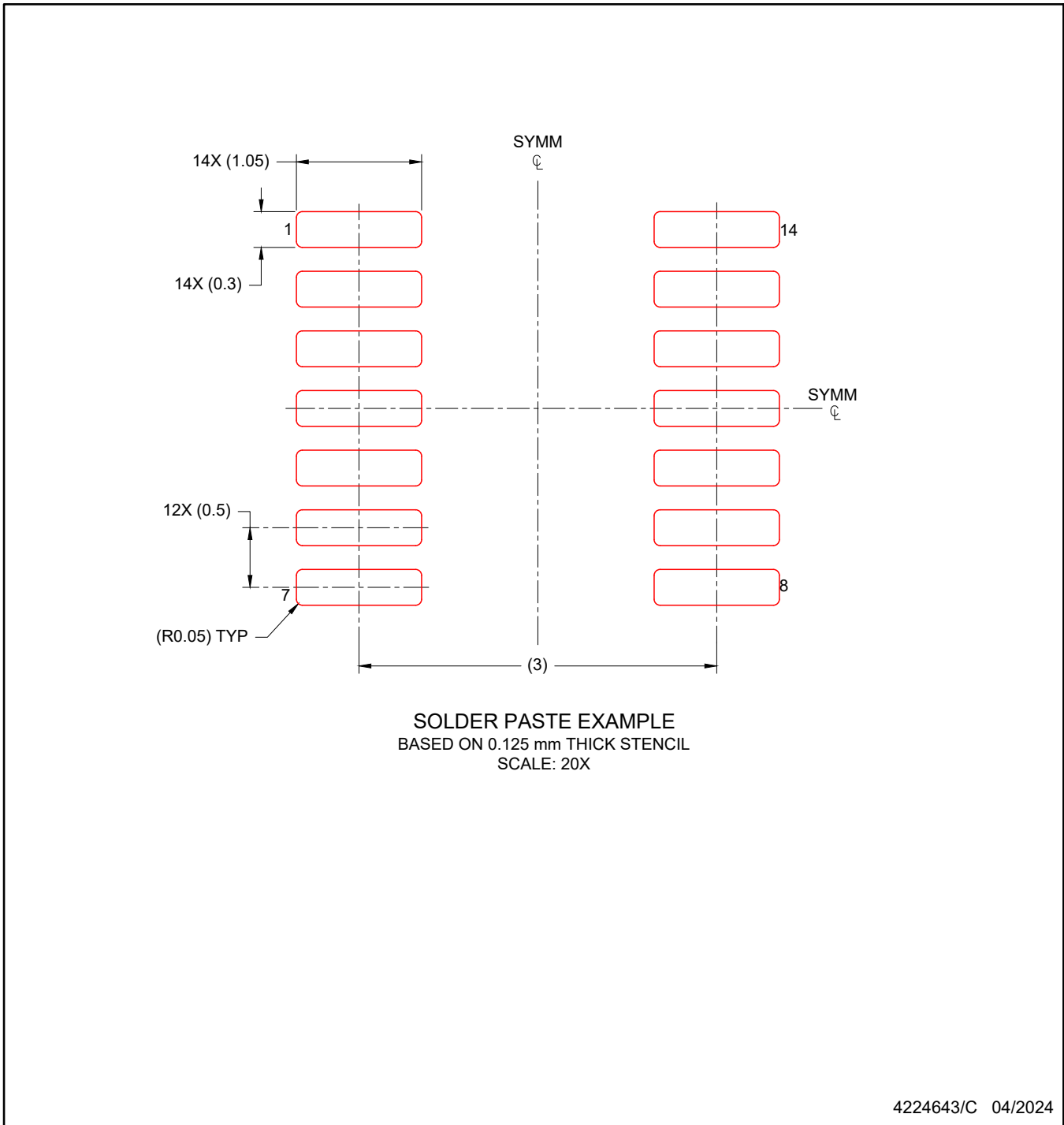

NOTES: (continued)

- 8. Laser cutting apertures with trapezoidal walls and rounded corners may offer better paste release. IPC-7525 may have alternate design recommendations.
- 9. Board assembly site may have different recommendations for stencil design.

PW (R-PDSO-G14)

PLASTIC SMALL OUTLINE



- NOTES:
- A. All linear dimensions are in millimeters. Dimensioning and tolerancing per ASME Y14.5M-1994.
 - B. This drawing is subject to change without notice.
 - C. Body length does not include mold flash, protrusions, or gate burrs. Mold flash, protrusions, or gate burrs shall not exceed 0,15 each side.
 - D. Body width does not include interlead flash. Interlead flash shall not exceed 0,25 each side.
 - E. Falls within JEDEC MO-153

DDF0008A



PACKAGE OUTLINE

SOT-23-THIN - 1.1 mm max height

PLASTIC SMALL OUTLINE



4222047/E 07/2024

NOTES:

1. All linear dimensions are in millimeters. Any dimensions in parenthesis are for reference only. Dimensioning and tolerancing per ASME Y14.5M.
2. This drawing is subject to change without notice.
3. This dimension does not include mold flash, protrusions, or gate burrs. Mold flash, protrusions, or gate burrs shall not exceed 0.15 mm per side.

EXAMPLE BOARD LAYOUT

DDF0008A

SOT-23-THIN - 1.1 mm max height

PLASTIC SMALL OUTLINE

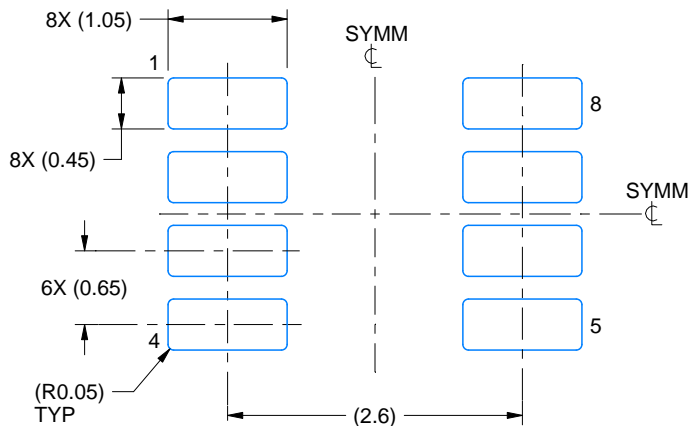

LAND PATTERN EXAMPLE
EXPOSED METAL SHOWN
SCALE:15X

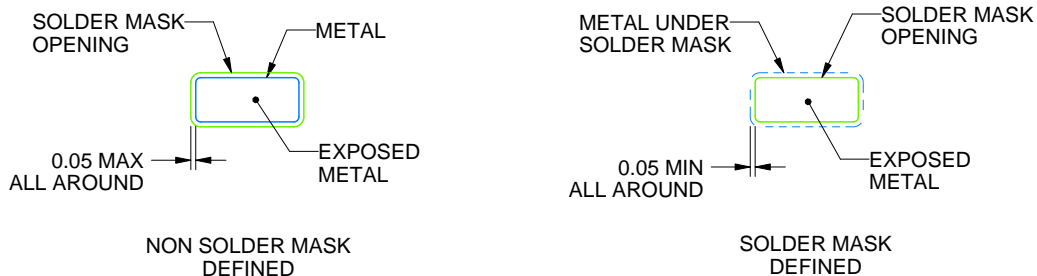

SOLDER MASK DETAILS

4222047/E 07/2024

NOTES: (continued)

- 4. Publication IPC-7351 may have alternate designs.
- 5. Solder mask tolerances between and around signal pads can vary based on board fabrication site.

EXAMPLE STENCIL DESIGN

DDF0008A

SOT-23-THIN - 1.1 mm max height

PLASTIC SMALL OUTLINE



SOLDER PASTE EXAMPLE
BASED ON 0.125 mm THICK STENCIL
SCALE:15X

4222047/E 07/2024

NOTES: (continued)

6. Laser cutting apertures with trapezoidal walls and rounded corners may offer better paste release. IPC-7525 may have alternate design recommendations.
7. Board assembly site may have different recommendations for stencil design.

RUG (R-PQFP-N10)

PLASTIC QUAD FLATPACK

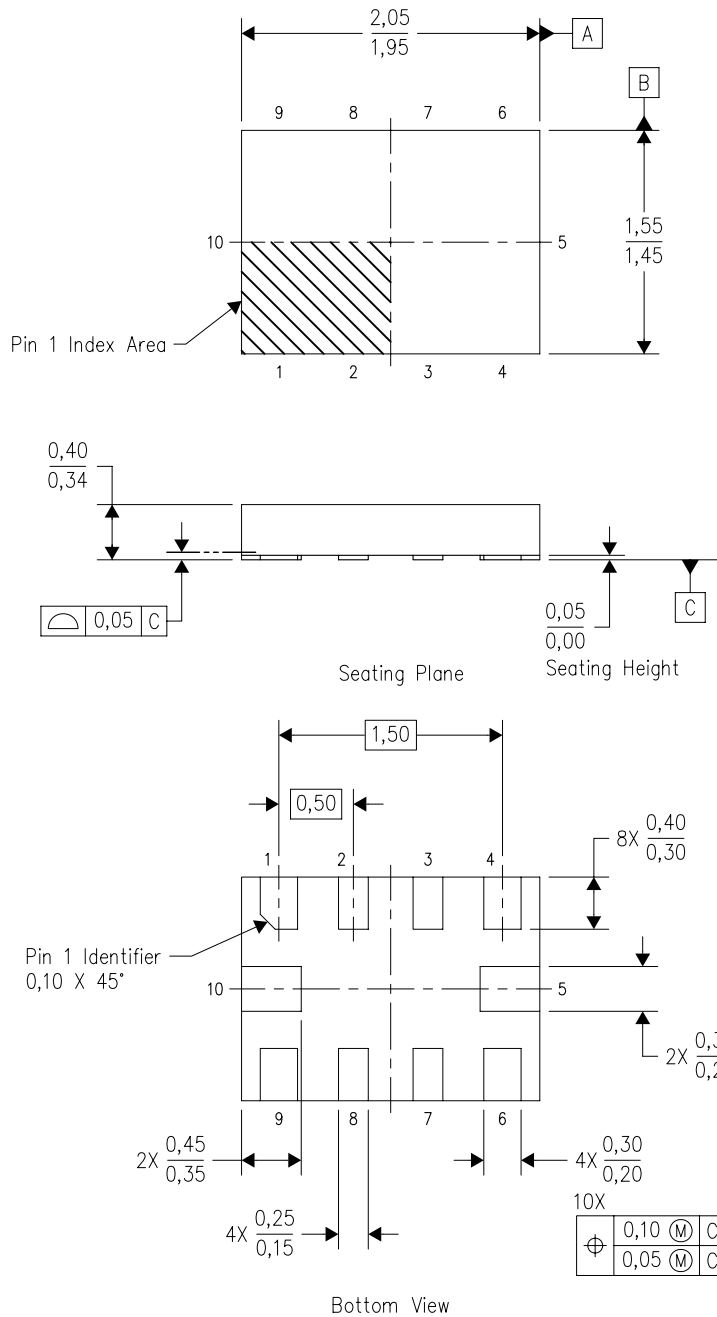

4208528-3/B 04/2008

- NOTES:
- All linear dimensions are in millimeters. Dimensioning and tolerancing per ASME Y14.5M-1994.
 - This drawing is subject to change without notice.
 - QFN (Quad Flatpack No-Lead) package configuration.
 - This package complies to JEDEC MO-288 variation X2EFD.



D0008A

PACKAGE OUTLINE

SOIC - 1.75 mm max height

SMALL OUTLINE INTEGRATED CIRCUIT



4214825/C 02/2019

NOTES:

- Linear dimensions are in inches [millimeters]. Dimensions in parenthesis are for reference only. Controlling dimensions are in inches. Dimensioning and tolerancing per ASME Y14.5M.
- This drawing is subject to change without notice.
- This dimension does not include mold flash, protrusions, or gate burrs. Mold flash, protrusions, or gate burrs shall not exceed $.006$ [0.15] per side.
- This dimension does not include interlead flash.
- Reference JEDEC registration MS-012, variation AA.

EXAMPLE BOARD LAYOUT

D0008A

SOIC - 1.75 mm max height

SMALL OUTLINE INTEGRATED CIRCUIT



LAND PATTERN EXAMPLE
EXPOSED METAL SHOWN
SCALE:8X



SOLDER MASK DETAILS

4214825/C 02/2019

NOTES: (continued)

- 6. Publication IPC-7351 may have alternate designs.
- 7. Solder mask tolerances between and around signal pads can vary based on board fabrication site.

EXAMPLE STENCIL DESIGN

D0008A

SOIC - 1.75 mm max height

SMALL OUTLINE INTEGRATED CIRCUIT



SOLDER PASTE EXAMPLE
BASED ON .005 INCH [0.125 MM] THICK STENCIL
SCALE:8X

4214825/C 02/2019

NOTES: (continued)

8. Laser cutting apertures with trapezoidal walls and rounded corners may offer better paste release. IPC-7525 may have alternate design recommendations.
9. Board assembly site may have different recommendations for stencil design.

DBV0006A



PACKAGE OUTLINE

SOT-23 - 1.45 mm max height

SMALL OUTLINE TRANSISTOR

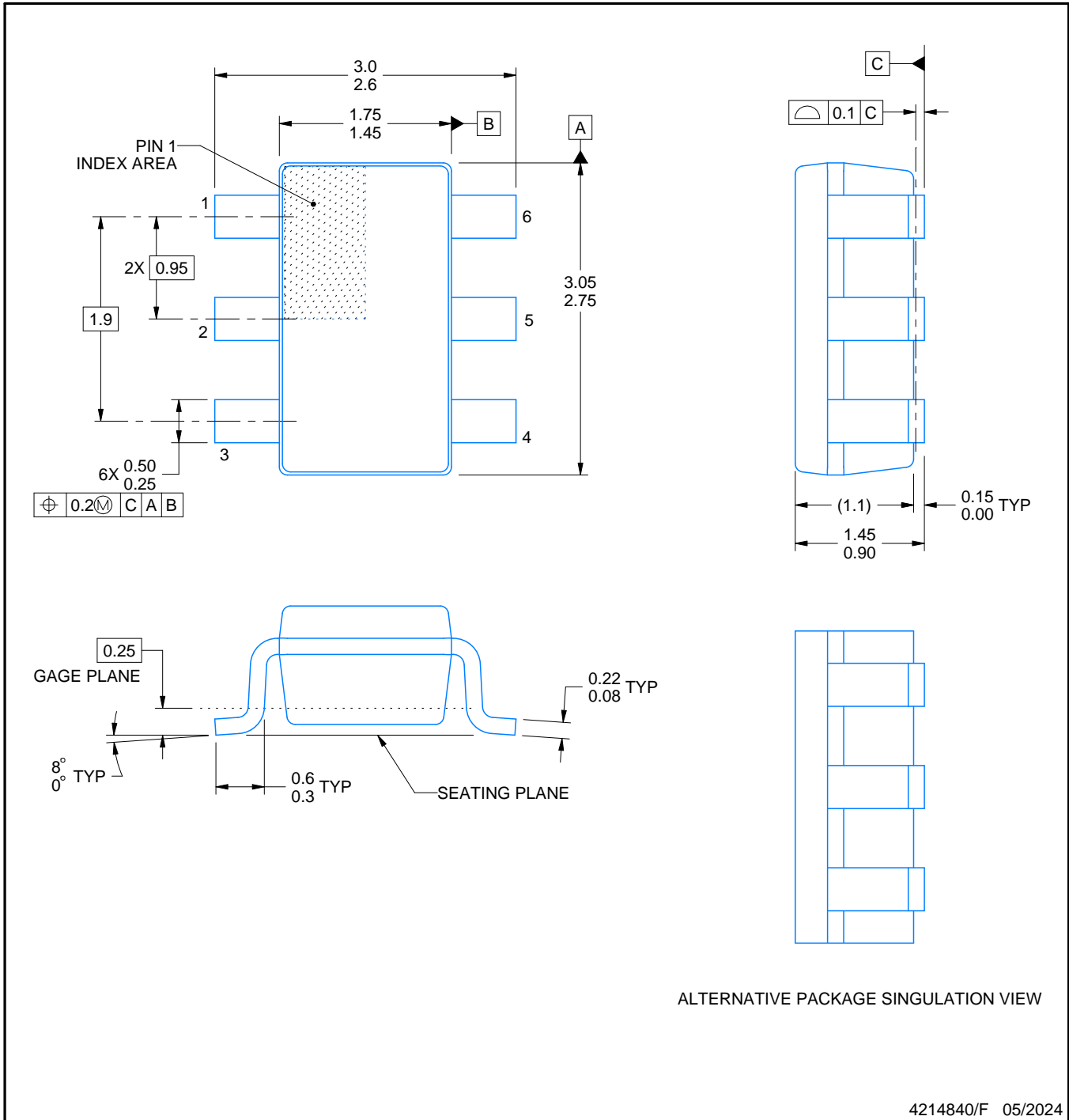

NOTES:

1. All linear dimensions are in millimeters. Any dimensions in parenthesis are for reference only. Dimensioning and tolerancing per ASME Y14.5M.
2. This drawing is subject to change without notice.
3. Body dimensions do not include mold flash or protrusion. Mold flash and protrusion shall not exceed 0.25 per side.
4. Leads 1,2,3 may be wider than leads 4,5,6 for package orientation.
5. Reference JEDEC MO-178.

EXAMPLE BOARD LAYOUT

DBV0006A

SOT-23 - 1.45 mm max height

SMALL OUTLINE TRANSISTOR

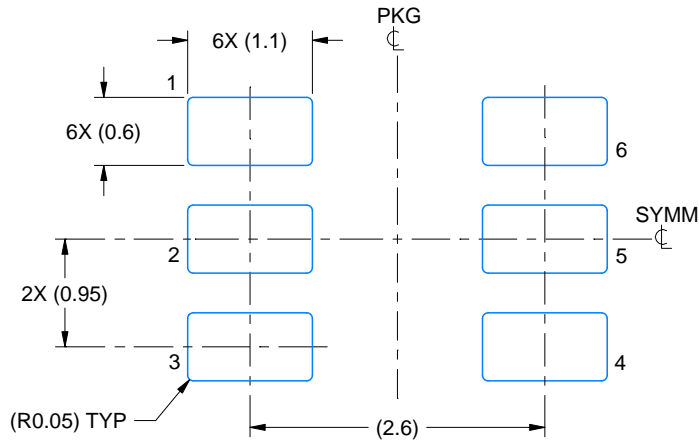

LAND PATTERN EXAMPLE
EXPOSED METAL SHOWN
SCALE:15X

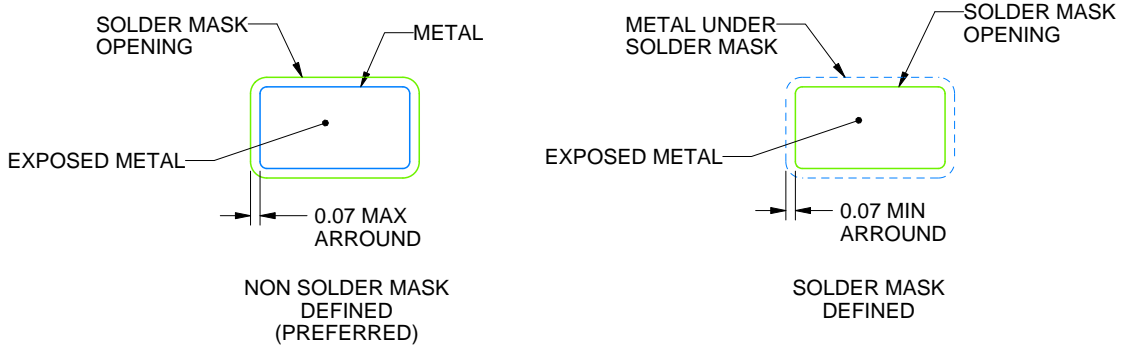

SOLDER MASK DETAILS

4214840/F 05/2024

NOTES: (continued)

- 6. Publication IPC-7351 may have alternate designs.
- 7. Solder mask tolerances between and around signal pads can vary based on board fabrication site.

EXAMPLE STENCIL DESIGN

DBV0006A

SOT-23 - 1.45 mm max height

SMALL OUTLINE TRANSISTOR



SOLDER PASTE EXAMPLE
BASED ON 0.125 mm THICK STENCIL
SCALE:15X

4214840/F 05/2024

NOTES: (continued)

8. Laser cutting apertures with trapezoidal walls and rounded corners may offer better paste release. IPC-7525 may have alternate design recommendations.
9. Board assembly site may have different recommendations for stencil design.

重要なお知らせと免責事項

TI は、技術データと信頼性データ (データシートを含みます)、設計リソース (リファレンス・デザインを含みます)、アプリケーションや設計に関する各種アドバイス、Web ツール、安全性情報、その他のリソースを、欠陥が存在する可能性のある「現状のまま」提供しており、商品性および特定目的に対する適合性の黙示保証、第三者の知的財産権の非侵害保証を含むいかなる保証も、明示的または黙示的にかかわらず拒否します。

これらのリソースは、TI 製品を使用する設計の経験を積んだ開発者への提供を意図したものです。(1) お客様のアプリケーションに適した TI 製品の選定、(2) お客様のアプリケーションの設計、検証、試験、(3) お客様のアプリケーションに該当する各種規格や、その他のあらゆる安全性、セキュリティ、規制、または他の要件への確実な適合に関する責任を、お客様のみが単独で負うものとし、

上記の各種リソースは、予告なく変更される可能性があります。これらのリソースは、リソースで説明されている TI 製品を使用するアプリケーションの開発の目的でのみ、TI はその使用をお客様に許諾します。これらのリソースに関して、他の目的で複製することや掲載することは禁止されています。TI や第三者の知的財産権のライセンスが付与されている訳ではありません。お客様は、これらのリソースを自身で使用した結果発生するあらゆる申し立て、損害、費用、損失、責任について、TI およびその代理人を完全に補償するものとし、TI は一切の責任を拒否します。

TI の製品は、[TI の販売条件](#)、または [ti.com](#) やかかる TI 製品の関連資料などのいずれかを通じて提供する適用可能な条項の下で提供されています。TI がこれらのリソースを提供することは、適用される TI の保証または他の保証の放棄の拡大や変更を意味するものではありません。

お客様がいかなる追加条項または代替条項を提案した場合でも、TI はそれらに異議を唱え、拒否します。

郵送先住所 : Texas Instruments, Post Office Box 655303, Dallas, Texas 75265
Copyright © 2024, Texas Instruments Incorporated