

OPA863 低消費電力、110MHz、レール・ツー・レール入出力、電圧帰還型オペアンプ

1 特長

- 広い帯域幅
 - ユニティ・ゲイン帯域幅: 110MHz ($A_V = 1V/V$)
 - ゲイン帯域幅積: 50MHz
- 低い消費電力
 - 静止電流: 700 μ A/チャンネル (標準値)
 - パワーダウン・モード: 1.5 μ A (最大値、 $V_S = 3V$)
 - 電源電圧: 2.7V~12.6V
- 入力電圧ノイズ: 5.9nV/ \sqrt{Hz}
- スルーレート: 105V/ μ s
- レール・ツー・レール入出力
- HD₂/HD₃: -129dBc/-138dBc (20kHz、2V_{PP} 時)
- 動作温度範囲: -40°C~+125°C
- 追加機能:
 - 過負荷電力制限
 - 出力短絡保護
- 高精度バージョン: [OPA863A](#)

2 アプリケーション

- 低消費電力の SAR および $\Delta\Sigma$ ADC ドライバ
- ADC リファレンス・バッファ
- ローサイド電流センシング
- フォトダイオード TIA インターフェイス
- 誘導性センシング
- 超音波流量計
- マルチファンクション・プリンタ (プリンタ複合機)
- MDAC 出力バッファ
- ゲインおよびアクティブ・フィルタ段

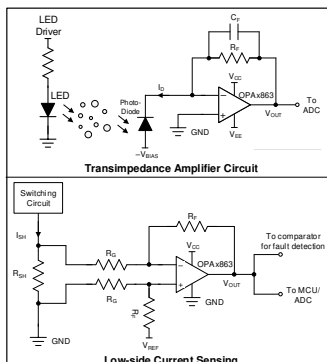

OPA863 を使用したアプリケーション回路

3 概要

OPA863 デバイスは、2.7V~12.6V の電源電圧範囲で動作するように設計された低消費電力、ユニティ・ゲイン安定、レール・ツー・レール入出力の電圧帰還型オペアンプです。OPA863 のチャンネルあたりの消費電流はわずか 700 μ A であり、ゲイン帯域幅積は 50MHz、スルーレートは 105V/ μ s、電圧ノイズ密度は 5.9nV/ \sqrt{Hz} です。

2.7V 電源で動作するレール・ツー・レール入力段は、携帯型バッテリー駆動アプリケーションに便利です。レール・ツー・レール入力段は、全入力同相電圧範囲にわたってゲイン帯域幅積とノイズに対してよく調整されているため、広い入力ダイナミック・レンジで優れた性能を実現します。OPA863 は、パワー・ダウン (PD) モードを備えており、3V 電源を使用した場合の PD 時静止電流 (I_Q) は 1.5 μ A (最大値) で、電源オン/オフ時間は 6.5 μ s 以内です。

OPA863 は、飽和出力での静止電流 I_Q の増加を抑えるために、過負荷電力制限機能を備えており、電力が問題となるバッテリー駆動システムでの過剰な電力消費を防止できます。出力段は短絡保護されており、これらのデバイスは耐久性が求められる環境に対応しています。

製品情報 (1)(2)

部品番号	チャンネル数	パッケージ
OPA863	シングル	DBV (SOT-23, 5)
		DBV (SOT-23, 6)
OPA2863	デュアル	DGK (VSSOP, 8)
		RUN (WQFN, 10)
		D (SOIC, 8)
OPA4863	クワッド	PW (TSSOP, 14)

- 利用可能なパッケージについては、このデータシートの末尾にある注文情報を参照してください。
- 関連製品については、「[デバイス比較](#)」を参照してください。

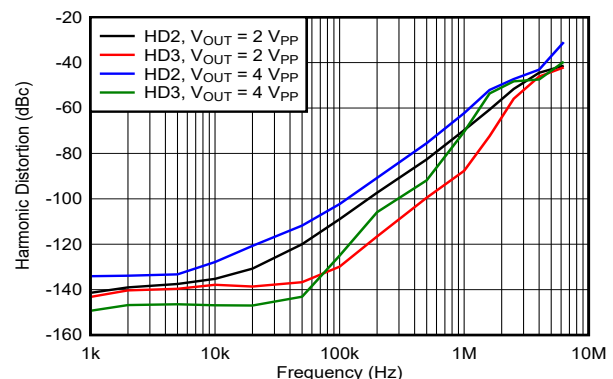

歪み性能 ($G = 1V/V$)



Table of Contents

1 特長.....	1	8.1 Overview.....	21
2 アプリケーション.....	1	8.2 Functional Block Diagram.....	21
3 概要.....	1	8.3 Feature Description.....	22
4 Revision History.....	2	8.4 Device Functional Modes.....	23
5 Device Comparison Table.....	3	9 Application and Implementation.....	24
6 Pin Configuration and Functions.....	3	9.1 Application Information.....	24
7 Specifications.....	6	9.2 Typical Applications.....	24
7.1 Absolute Maximum Ratings.....	6	9.3 Power Supply Recommendations.....	28
7.2 ESD Ratings.....	6	9.4 Layout.....	28
7.3 Recommended Operating Conditions.....	6	10 Device and Documentation Support.....	30
7.4 Thermal Information: OPA863.....	7	10.1 Documentation Support.....	30
7.5 Thermal Information: OPA2863.....	7	10.2 ドキュメントの更新通知を受け取る方法.....	30
7.6 Thermal Information: OPA4863.....	7	10.3 サポート・リソース.....	30
7.7 Electrical Characteristics: $V_S = 10\text{ V}$	8	10.4 Trademarks.....	30
7.8 Electrical Characteristics: $V_S = 3\text{ V}$	10	10.5 静電気放電に関する注意事項.....	30
7.9 Typical Characteristics: $V_S = 10\text{ V}$	12	10.6 用語集.....	30
7.10 Typical Characteristics: $V_S = 3\text{ V}$	17	11 Mechanical, Packaging, and Orderable Information.....	30
7.11 Typical Characteristics: $V_S = 3\text{ V to }10\text{ V}$	19		
8 Detailed Description.....	21		

4 Revision History

資料番号末尾の英字は改訂を表しています。その改訂履歴は英語版に準じています。

Changes from Revision I (December 2022) to Revision J (June 2023)	Page
• OPA4863 PW パッケージ、14 ピン TSSOP のステータスを「プレビュー」から「量産」に変更し、関連コンテンツを追加.....	1
Changes from Revision H (August 2022) to Revision I (December 2022)	Page
• DBV パッケージ、5 ピン SOT23 のステータスを「プレビュー」から「量産」に変更.....	1
Changes from Revision G (July 2022) to Revision H (August 2022)	Page
• Changed the status of the RUN Package, from: <i>preview</i> to: <i>production</i>	3
Changes from Revision F (April 2022) to Revision G (July 2022)	Page
• 「特長」セクションに機能安全の情報を追加.....	1
• DBV パッケージ、5 ピン SOT23 をデータシートに追加.....	1
• Changed the status of the D Package, from: <i>preview</i> to: <i>production</i>	3
• Updated the <i>Output Voltage vs Load Current</i> and <i>Output Voltage vs Load Current</i> figures to show typical device performance.....	12
Changes from Revision E (November 2021) to Revision F (April 2022)	Page
• D パッケージ、8 ピン SOIC および RUN パッケージ、10 ピン WQFN をデータシートに追加.....	1

5 Device Comparison Table

DEVICE	$\pm V_S$ (V)	I_Q / CHANNEL (mA)	GBWP (MHz)	SLEW RATE (V/ μ s)	VOLTAGE NOISE (nV/ $\sqrt{\text{Hz}}$)	AMPLIFIER DESCRIPTION
OPA2863	± 6.3	0.70	50	105	5.9	Unity-gain stable RRIO Bipolar Amplifier
LMH6643	± 6.4	2.7	65	130	17	Unity-gain stable NRI/RRO Bipolar Amplifier
OPAx810	± 13.5	3.6	70	200	6.3	Unity-gain stable RRIO FET-Input Amplifier
OPAx837	± 2.7	0.6	50	105	4.7	Unity-gain stable NRI/RRO Bipolar Amplifier
OPAx607	± 2.75	0.9	50	24	3.8	Decompensated Gain of 6 V/V stable CMOS Amplifier

6 Pin Configuration and Functions

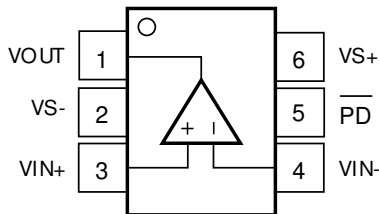

6-1. OPA863 DBV Package, 6-Pin SOT-23 (Top View)

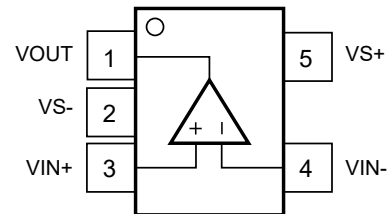

6-2. OPA863 DBV Package, 5-Pin SOT-23 (Top View)

表 6-1. Pin Functions: OPA863

NAME	PIN		TYPE ⁽¹⁾	DESCRIPTION
	NO.			
	DBV (SOT-23, 5)	DBV (SOT-23, 6)		
PD	—	5	I	Power down. Low = disabled, high = normal operation (pin must be driven).
VIN+	3	3	I	Noninverting input pin
VIN-	4	4	I	Inverting input pin
VOUT	1	1	O	Output pin
VS-	2	2	P	Negative power-supply pin
VS+	5	6	P	Positive power-supply pin

(1) I = input, O = output, and P = power.



图 6-3. OPA2863 D Package, 8-Pin SOIC and DGK Package, 8-Pin VSSOP, (Top View)



图 6-4. OPA2863 RUN Package, 10-Pin WQFN (Top View)

表 6-2. Pin Functions: OPA2863

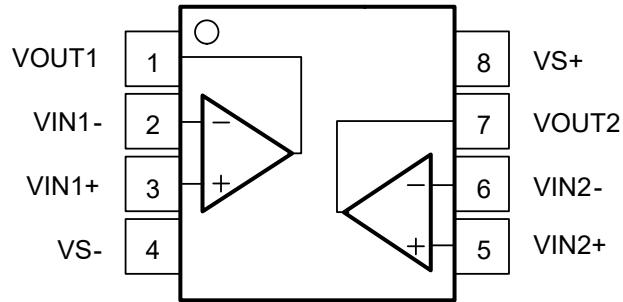
NAME	PIN NO.		TYPE ⁽¹⁾	DESCRIPTION
	D (SOIC), DGK (VSSOP)	RUN (WQFN)		
PD1	—	4	I	Amplifier 1 power down. Low = disabled, high = normal operation (pin must be driven).
PD2	—	6	I	Amplifier 2 power down. Low = disabled, high = normal operation (pin must be driven).
VIN1-	2	2	I	Amplifier 1 inverting input pin
VIN1+	3	3	I	Amplifier 1 noninverting input pin
VIN2-	6	8	I	Amplifier 2 inverting input pin
VIN2+	5	7	I	Amplifier 2 noninverting input pin
VOUT1	1	1	O	Amplifier 1 output pin
VOUT2	7	9	O	Amplifier 2 output pin
VS-	4	5	P	Negative power-supply pin
VS+	8	10	P	Positive power-supply pin

(1) I = input, O = output, and P = power.

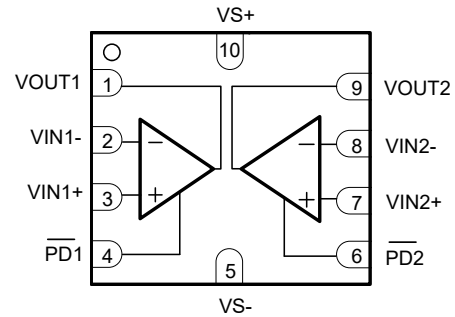
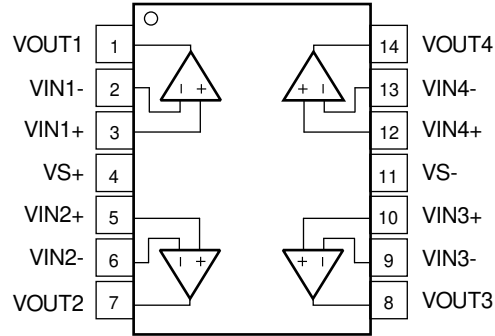

**图 6-5. OPA4863 PW Package,
14-Pin TSSOP
(Top View)**

表 6-3. Pin Functions: OPA4863

PIN		TYPE ⁽¹⁾	DESCRIPTION
NAME	NO.		
VIN1-	2	I	Amplifier 1 inverting input pin
VIN1+	3	I	Amplifier 1 noninverting input pin
VIN2-	6	I	Amplifier 2 inverting input pin
VIN2+	5	I	Amplifier 2 noninverting input pin
VIN3-	9	I	Amplifier 3 inverting input pin
VIN3+	10	I	Amplifier 3 noninverting input pin
VIN4-	13	I	Amplifier 4 inverting input pin
VIN4+	12	I	Amplifier 4 noninverting input pin
VOUT1	1	O	Amplifier 1 output pin
VOUT2	7	O	Amplifier 2 output pin
VOUT3	8	O	Amplifier 3 output pin
VOUT4	14	O	Amplifier 4 output pin
VS-	11	P	Negative power-supply pin
VS+	4	P	Positive power-supply pin

(1) I = input, O = output, and P = power.

7 Specifications

7.1 Absolute Maximum Ratings

over operating free-air temperature range (unless otherwise noted)⁽¹⁾

		MIN	MAX	UNIT
V_{S-} to V_{S+}	Supply voltage		13	V
	Supply turn-on/off maximum dV/dt, DBV-6 and D packages		0.1	V/ μ s
V_I	Input voltage	$V_{S-} - 0.5$	$V_{S+} + 0.5$	V
V_{ID}	Differential input voltage		± 1	V
I_I	Continuous input current ⁽²⁾		± 10	mA
I_O	Continuous output current ⁽³⁾		± 30	mA
	Continuous power dissipation	See Thermal Information		
T_J	Maximum junction temperature		150	$^{\circ}$ C
T_A	Operating free-air temperature	-40	125	$^{\circ}$ C
T_{stg}	Storage temperature	-65	150	$^{\circ}$ C

- (1) Operation outside the *Absolute Maximum Ratings* may cause permanent device damage. *Absolute Maximum Ratings* do not imply functional operation of the device at these or any other conditions beyond those listed under *Recommended Operating Conditions*. If used outside the *Recommended Operating Conditions* but within the *Absolute Maximum Ratings*, the device may not be fully functional, and this may affect device reliability, functionality, performance, and shorten the device lifetime.
- (2) Continuous input current limit for both the ESD diodes to supply pins and amplifier differential input clamp diode. The differential input clamp diode limits the voltage across it to 1 V with this continuous input current flowing through it.
- (3) Long-term continuous current for electromigration limits.

7.2 ESD Ratings

			VALUE	UNIT
$V_{(ESD)}$	Electrostatic discharge	Human body model (HBM), per ANSI/ESDA/JEDEC JS-001 ⁽¹⁾	± 2000	V
		Charged device model (CDM), per ANSI/ESDA/JEDEC JS-002 ⁽²⁾	± 1000	

- (1) JEDEC document JEP155 states that 500-V HBM allows safe manufacturing with a standard ESD control process.
- (2) JEDEC document JEP157 states that 250-V CDM allows safe manufacturing with a standard ESD control process.

7.3 Recommended Operating Conditions

over operating free-air temperature range (unless otherwise noted)

		MIN	NOM	MAX	UNIT
$V_{S+} - V_{S-}$	Total supply voltage	2.7	10	12.6	V
T_A	Ambient temperature	-40	25	125	$^{\circ}$ C

7.4 Thermal Information: OPA863

THERMAL METRIC ⁽¹⁾		OPA863		UNIT
		DBV (SOT-23)		
		5 PINS	6 PINS	
R _{θJA}	Junction-to-ambient thermal resistance	168.3	161.8	°C/W
R _{θJC(top)}	Junction-to-case (top) thermal resistance	64.3	73.9	°C/W
R _{θJB}	Junction-to-board thermal resistance	40.6	42.6	°C/W
Ψ _{JT}	Junction-to-top characterization parameter	14.2	21.2	°C/W
Y _{JB}	Junction-to-board characterization parameter	40.3	42.5	°C/W

(1) For more information about traditional and new thermal metrics, see the [Semiconductor and IC Package Thermal Metrics](#) application report.

7.5 Thermal Information: OPA2863

THERMAL METRIC ⁽¹⁾		OPA2863			UNIT
		DGK (VSSOP)	D (SOIC)	RUN (WQFN)	
		8 PINS	8 PINS	10 PINS	
R _{θJA}	Junction-to-ambient thermal resistance	180.3	120.0	110.2	°C/W
R _{θJC(top)}	Junction-to-case (top) thermal resistance	67.5	63.3	66.8	°C/W
R _{θJB}	Junction-to-board thermal resistance	101.9	63.2	43.6	°C/W
Ψ _{JT}	Junction-to-top characterization parameter	9.8	17.2	2.9	°C/W
Y _{JB}	Junction-to-board characterization parameter	100.1	62.5	43.5	°C/W

(1) For more information about traditional and new thermal metrics, see the [Semiconductor and IC Package Thermal Metrics](#) application report.

7.6 Thermal Information: OPA4863

THERMAL METRIC ⁽¹⁾		OPA4863	UNIT
		PW (TSSOP)	
		14 PINS	
R _{θJA}	Junction-to-ambient thermal resistance	99.5	°C/W
R _{θJC(top)}	Junction-to-case (top) thermal resistance	27.6	°C/W
R _{θJB}	Junction-to-board thermal resistance	56.1	°C/W
Ψ _{JT}	Junction-to-top characterization parameter	4.4	°C/W
Y _{JB}	Junction-to-board characterization parameter	55.3	°C/W

(1) For more information about traditional and new thermal metrics, see the [Semiconductor and IC Package Thermal Metrics](#) application report.

7.7 Electrical Characteristics: $V_S = 10\text{ V}$

at $V_{S+} = 5\text{ V}$, $V_{S-} = -5\text{ V}$, $G = 1\text{ V/V}$, $R_F = 0\ \Omega$ for $G = 1\text{ V/V}$, otherwise $R_F = 1\text{ k}\Omega$ for other gains, $C_L = 1\text{ pF}$, $R_L = 2\text{ k}\Omega$ referred to mid-supply, input and output common-mode is at mid-supply, and $T_A \cong 25^\circ\text{C}$ (unless otherwise noted)

PARAMETER		TEST CONDITIONS	MIN	TYP	MAX	UNIT
AC PERFORMANCE						
SSBW	Small-signal bandwidth	$V_{OUT} = 20\text{ mV}_{PP}$, $G = 1$, $< 1\text{ dB}$ peaking		110		MHz
GBWP	Gain-bandwidth product			50		MHz
LSBW	Large-signal bandwidth	$V_{OUT} = 2\text{ V}_{PP}$		17		MHz
	Bandwidth for 0.1-dB flatness	$V_{OUT} = 20\text{ mV}_{PP}$		15		MHz
SR	Slew rate	$V_{OUT} = 2\text{-V}$ step, $G = -1$		105		V/ μs
	Rise, fall time	$V_{OUT} = 200\text{-mV}$ step		9		ns
	Settling time to 0.1%	$V_{OUT} = 2\text{-V}$ step		57		ns
	Settling time to 0.01%			70		
	Overshoot/undershoot	$V_{OUT} = 2\text{-V}$ step		1		%
	Overdrive recovery time	$G = -1$, 0.5 V overdrive beyond supplies		70		ns
		$G = 1$, 0.5 V overdrive beyond supplies		100		
HD2	Second-order harmonic distortion	$f = 20\text{ kHz}$, $V_{OUT} = 2\text{ V}_{PP}$		-129		dBc
HD3	Third-order harmonic distortion			-138		
HD2	Second-order harmonic distortion	$f = 100\text{ kHz}$, $V_{OUT} = 2\text{ V}_{PP}$		-107		dBc
HD3	Third-order harmonic distortion			-125		
e_N	Input voltage noise	Flatband, 1/f corner at 25 Hz		5.9		nV/ $\sqrt{\text{Hz}}$
i_N	Input current noise	Flatband, 1/f corner at 2 kHz		0.4		pA/ $\sqrt{\text{Hz}}$
	Closed-loop output impedance	$f = 1\text{ MHz}$		0.2		Ω
	Channel-to-channel crosstalk	$f = 1\text{ MHz}$, $V_{OUT} = 2\text{ V}_{PP}$, OPA2863		-124		dBc
DC PERFORMANCE						
A_{OL}	Open-loop voltage gain	$V_{OUT} = \pm 2.5\text{ V}$	110	128		dB
V_{OS}	Input-referred offset voltage		-1.3	± 0.4	1.3	mV
	Input offset voltage drift	$T_A = -40^\circ\text{C}$ to $+125^\circ\text{C}$, D, DBV-5, RUN and DGK packages	-3.5	± 1	3.5	$\mu\text{V}/^\circ\text{C}$
		$T_A = -40^\circ\text{C}$ to $+125^\circ\text{C}$, PW package	-4	± 1	4	
		$T_A = 0^\circ\text{C}$ to $+85^\circ\text{C}$, DBV-6 package	-4.4	± 1	4.4	
		$T_A = -40^\circ\text{C}$ to $+125^\circ\text{C}$, DBV-6 package	-4.9	± 1	4.9	
	Input bias current	$T_A \cong 25^\circ\text{C}$		0.3	0.73	μA
		$T_A = -40^\circ\text{C}$ to $+85^\circ\text{C}$			1.2	
		$T_A = -40^\circ\text{C}$ to $+125^\circ\text{C}$			1.6	
	Input bias current drift	$T_A = -40^\circ\text{C}$ to $+125^\circ\text{C}$		± 3	7.6	nA/ $^\circ\text{C}$
	Input offset current		-30	± 10	30	nA
INPUT						
	Input common-mode voltage range		$V_{S-}-0.2$		$V_{S+}+0.2$	V
CMRR	Common-mode rejection ratio	$V_{CM} = V_{S-} - 0.2\text{ V}$ to $V_{S+} - 1.6\text{ V}$	100	120		dB
	Input impedance common-mode			650 0.8		M Ω pF
	Input impedance differential mode			200 0.5		k Ω pF
OUTPUT						
V_{OL}	Output voltage, low	$T_A \cong 25^\circ\text{C}$		$V_{S-}+0.14$	$V_{S-}+0.2$	V
		$T_A = -40^\circ\text{C}$ to $+125^\circ\text{C}$		$V_{S-}+0.15$	$V_{S-}+0.22$	
V_{OH}	Output voltage, high	$T_A \cong 25^\circ\text{C}$	$V_{S+}-0.2$	$V_{S+}-0.14$		V
		$T_A = -40^\circ\text{C}$ to $+125^\circ\text{C}$	$V_{S+}-0.2$	$V_{S+}-0.15$		

7.7 Electrical Characteristics: $V_S = 10\text{ V}$ (continued)

at $V_{S+} = 5\text{ V}$, $V_{S-} = -5\text{ V}$, $G = 1\text{ V/V}$, $R_F = 0\ \Omega$ for $G = 1\text{ V/V}$, otherwise $R_F = 1\text{ k}\Omega$ for other gains, $C_L = 1\text{ pF}$, $R_L = 2\text{ k}\Omega$ referenced to mid-supply, input and output common-mode is at mid-supply, and $T_A \cong 25^\circ\text{C}$ (unless otherwise noted)

PARAMETER		TEST CONDITIONS	MIN	TYP	MAX	UNIT
	Linear output drive (sourcing/sinking)	$V_{OUT} = \pm 2.5\text{ V}$, $\Delta V_{OS} < 1\text{ mV}$ OPA863 and OPA2863 ⁽¹⁾	25	30		mA
	Short-circuit current			45		mA
POWER SUPPLY						
I_Q	Quiescent current per amplifier	$T_A \cong 25^\circ\text{C}$		700	970	μA
		$T_A = -40^\circ\text{C}$ to $+125^\circ\text{C}$			1280	
PSRR	Power-supply rejection ratio	$\Delta V_S = \pm 2\text{ V}$ ⁽²⁾	100	120		dB
POWER DOWN (Pin Must be Driven)						
	Enable voltage threshold	Specified <i>on</i> above $V_{S+} - 0.5\text{ V}$			4.5	V
	Disable voltage threshold	Specified <i>off</i> below $V_{S+} - 1.5\text{ V}$	3.5			V
	Power-down quiescent current per channel	$P\bar{D} \leq V_{S+} - 1.5\text{ V}$		2	3.3	μA
	Power-down pin bias current			2	50	nA
	Turn-on time delay			6		μs
	Turn-off time delay			4.5		μs
AUXILIARY INPUT STAGE						
	Gain-bandwidth product			50		MHz
	Input voltage noise	Flatband, 1/f corner at 25 Hz		6		nV/ $\sqrt{\text{Hz}}$
	Input current noise	Flatband, 1/f corner at 100 Hz		0.4		pA/ $\sqrt{\text{Hz}}$
	Input-referred offset voltage		-1.3	± 0.15	1.3	mV
	Input bias current	$T_A \cong 25^\circ\text{C}$		0.2	0.6	μA
		$T_A = -40^\circ\text{C}$ to $+125^\circ\text{C}$		0.2	1.3	
	Common-mode rejection ratio	$V_{CM} = 4.1\text{ V}$ to 5.2 V	100	120		dB
	Power supply rejection ratio	$\Delta V_S = \pm 0.6\text{ V}$	100	120		dB

- (1) Change in input offset voltage from no-load condition.
- (2) Change in supply voltage from the default test condition with only one of the positive or negative supplies changing corresponding to +PSRR and -PSRR.

7.8 Electrical Characteristics: $V_S = 3\text{ V}$

at $V_{S+} = 3\text{ V}$, $V_{S-} = 0\text{ V}$, $G = 1$, $R_F = 0\ \Omega$ for $G = 1\text{ V/V}$, otherwise $R_F = 1\text{ k}\Omega$ for other gains, $C_L = 1\text{ pF}$, $R_L = 2\text{ k}\Omega$ connected to 1 V , input and output $V_{CM} = 1\text{ V}$, and $T_A \cong 25^\circ\text{C}$ (unless otherwise noted)

PARAMETER		TEST CONDITIONS	MIN	TYP	MAX	UNIT
AC PERFORMANCE						
SSBW	Small-signal bandwidth	$V_{OUT} = 20\text{ mV}_{PP}$, $G = 1$		97		MHz
GBWP	Gain-bandwidth product			50		MHz
LSBW	Large-signal bandwidth	$V_{OUT} = 1\text{ V}_{PP}$		26		MHz
	Bandwidth for 0.1-dB flatness	$V_{OUT} = 20\text{ mV}_{PP}$		10		MHz
SR	Slew rate	$V_{OUT} = 1\text{-V step}$, Gain = -1		105		V/ μs
	Rise, fall time	$V_{OUT} = 200\text{-mV step}$		10		ns
	Settling time to 0.1%	$V_{OUT} = 1\text{-V step}$		58		ns
	Settling time to 0.01%			90		
	Overshoot	$V_{OUT} = 1\text{-V step}$		2		%
	Undershoot			16		
	Overdrive recovery time	$G = -1$, 0.5V overdrive beyond supplies		95		ns
		$G = 1$, 0.5V overdrive beyond supplies		100		
HD2	Second-order harmonic distortion	$f = 20\text{ kHz}$, $V_{OUT} = 1\text{ V}_{PP}$		-123		dBc
HD3	Third-order harmonic distortion			-132		
HD2	Second-order harmonic distortion	$f = 100\text{ kHz}$, $V_{OUT} = 1\text{ V}_{PP}$		-109		dBc
HD3	Third-order harmonic distortion			-129		
e_N	Input voltage noise	Flatband, 1/f corner at 25 Hz		6		nV/ $\sqrt{\text{Hz}}$
i_N	Input current noise	Flatband, 1/f corner at 2 kHz		0.4		pA/ $\sqrt{\text{Hz}}$
	Closed-loop output impedance	$f = 1\text{ MHz}$		0.2		Ω
	Channel-to-channel crosstalk	$f = 1\text{ MHz}$, $V_{OUT} = 1\text{ V}_{PP}$, OPA2863		-127		dBc
DC PERFORMANCE						
A_{OL}	Open-loop voltage gain	$V_{OUT} = 1\text{ V to }2\text{ V}$	104	123		dB
V_{OS}	Input-referred offset voltage		-1.3	± 0.4	1.3	mV
	Input offset voltage drift	$T_A = -40^\circ\text{C to }+125^\circ\text{C}$, D, DBV-5, RUN, and DGK packages	-3.5	± 1	3.5	$\mu\text{V}/^\circ\text{C}$
		$T_A = -40^\circ\text{C to }+125^\circ\text{C}$, PW package	-4	± 1	4	
		$T_A = 0^\circ\text{C to }+85^\circ\text{C}$, DBV-6 package	-4.4	± 1	4.4	
		$T_A = -40^\circ\text{C to }+125^\circ\text{C}$, DBV-6 package	-5	± 1	5	
	Input bias current	$T_A \cong 25^\circ\text{C}$		0.3	0.73	μA
		$T_A = -40^\circ\text{C to }+85^\circ\text{C}$			1.2	
		$T_A = -40^\circ\text{C to }+125^\circ\text{C}$			1.56	
	Input bias current drift	$T_A = -40^\circ\text{C to }+125^\circ\text{C}$		± 3	7.4	nA/ $^\circ\text{C}$
	Input offset current		-30	± 10	30	nA
INPUT						
	Input common-mode voltage range		$V_{S-}-0.2$	$V_{S+}+0.2$		V
CMRR	Common-mode rejection ratio	$V_{CM} = V_{S-} - 0.2\text{ V to }V_{S+} - 1.6\text{ V}$	94	115		dB
	Input impedance common-mode			360 0.9		M Ω pF
	Input impedance differential mode			200 0.5		k Ω pF

7.8 Electrical Characteristics: $V_S = 3\text{ V}$ (continued)

at $V_{S+} = 3\text{ V}$, $V_{S-} = 0\text{ V}$, $G = 1$, $R_F = 0\ \Omega$ for $G = 1\text{ V/V}$, otherwise $R_F = 1\text{ k}\Omega$ for other gains, $C_L = 1\text{ pF}$, $R_L = 2\text{ k}\Omega$ connected to 1 V , input and output $V_{CM} = 1\text{ V}$, and $T_A \cong 25^\circ\text{C}$ (unless otherwise noted)

PARAMETER		TEST CONDITIONS	MIN	TYP	MAX	UNIT
OUTPUT						
V_{OL}	Output voltage, low	$T_A \cong 25^\circ\text{C}$		$V_{S-} + 0.13$	$V_{S-} + 0.15$	V
		$T_A = -40^\circ\text{C}$ to $+125^\circ\text{C}$		$V_{S-} + 0.13$	$V_{S-} + 0.16$	
V_{OH}	Output voltage, high	$T_A \cong 25^\circ\text{C}$	$V_{S+} - 0.15$	$V_{S+} - 0.13$		V
		$T_A = -40^\circ\text{C}$ to $+125^\circ\text{C}$	$V_{S+} - 0.15$	$V_{S+} - 0.13$		
	Linear output drive (sourcing/sinking)	$V_{OUT} = \pm 0.7\text{ V}$, $\Delta V_{OS} < 1\text{ mV}$ OPA863 and OPA2863 ⁽¹⁾	23	33		mA
	Short-circuit current			45		mA
POWER SUPPLY						
I_Q	Quiescent current per amplifier	$T_A \cong 25^\circ\text{C}$		690	910	μA
		$T_A = -40^\circ\text{C}$ to $+125^\circ\text{C}$			1180	
PSRR	Power-supply rejection ratio	$\Delta V_S = \pm 1\text{ V}$ ⁽²⁾	100	120		dB
POWER DOWN (Pin Must be Driven)						
	Enable voltage threshold	Specified <i>on</i> above $V_{S+} - 0.5\text{ V}$			2.5	V
	Disable voltage threshold	Specified <i>off</i> below $V_{S+} - 1.5\text{ V}$	1.5			V
	Power-down quiescent current per channel	$PD \leq V_{S+} - 1.5\text{ V}$		0.8	1.5	μA
	Power-down pin bias current			1	50	nA
	Turn-on time delay			6.5		μs
	Turn-off time delay			5		μs
AUXILIARY INPUT STAGE						
	Gain-bandwidth product			50		MHz
	Input voltage noise	Flatband, 1/f corner at 25 Hz		6		nV/ $\sqrt{\text{Hz}}$
	Input current noise	Flatband, 1/f corner at 100 Hz		0.4		pA/ $\sqrt{\text{Hz}}$
	Input-referred offset voltage		-1.3	± 0.15	1.3	mV
	Input bias current	$T_A \cong 25^\circ\text{C}$		0.2	0.6	μA
		$T_A = -40^\circ\text{C}$ to $+125^\circ\text{C}$		0.4	1.2	
	Common-mode rejection ratio	$V_{CM} = 2.1\text{ V}$ to 3.2 V	100	120		dB
	Power supply rejection ratio	$\Delta V_S = \pm 0.6\text{ V}$	100	115		dB

(1) Change in input offset voltage from no-load condition.

(2) Change in supply voltage from the default test condition with only one of the positive or negative supplies changing corresponding to +PSRR and -PSRR.

7.9 Typical Characteristics: $V_S = 10\text{ V}$

at $V_{S+} = 5\text{ V}$, $V_{S-} = -5\text{ V}$, $R_F = 0\ \Omega$ for Gain = 1 V/V, otherwise $R_F = 1\text{ k}\Omega$ for other gains, $C_L = 1\text{ pF}$, $R_L = 2\text{ k}\Omega$ referenced to mid-supply, $G = 1\text{ V/V}$, input and output referenced to mid-supply, and $T_A \cong 25^\circ\text{C}$ (unless otherwise noted)

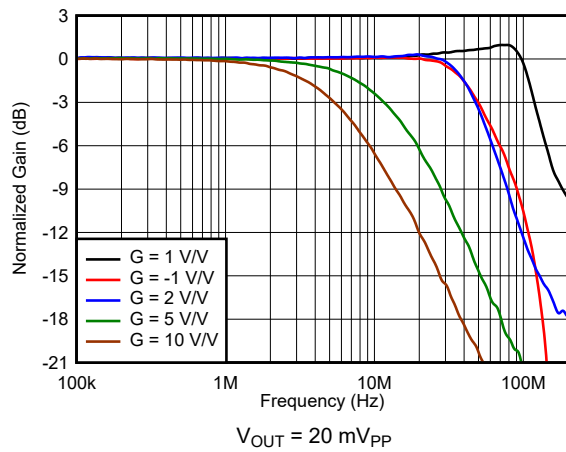

7-1. Small-Signal Frequency Response vs Gain

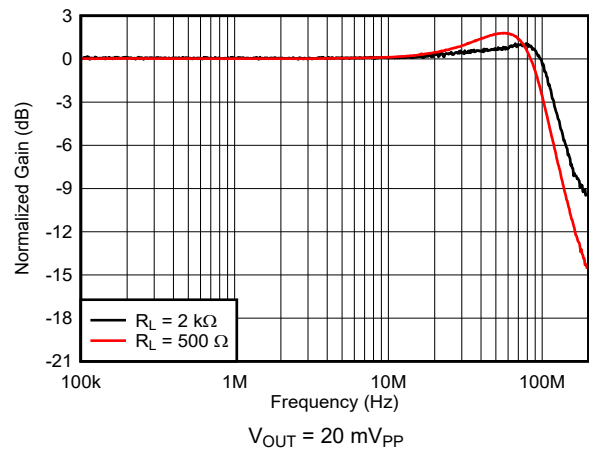

7-2. Small-Signal Frequency Response vs Output Load

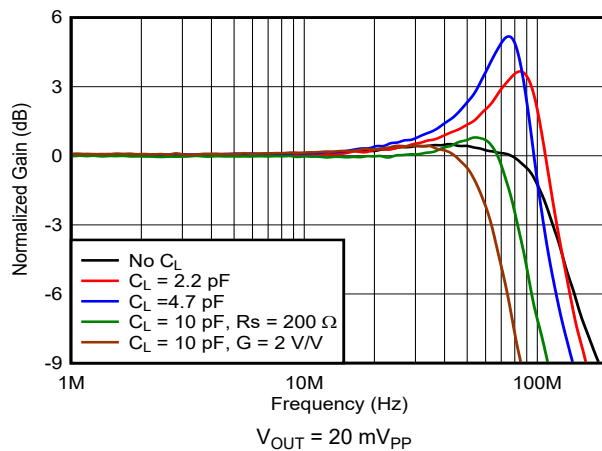

7-3. Frequency Response vs Load Capacitance

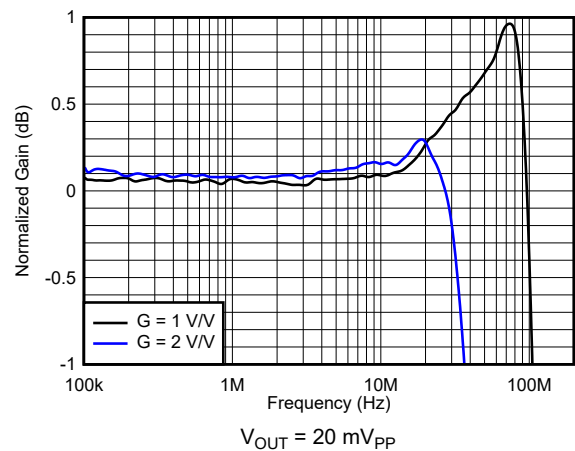

7-4. Small-Signal Response Flatness vs Gain

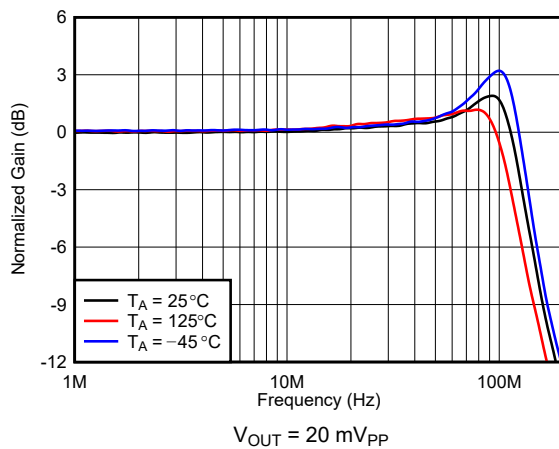

7-5. Frequency Response vs Ambient Temperature

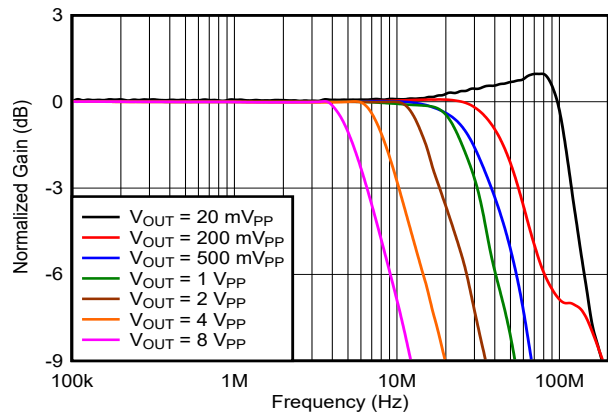

7-6. Frequency Response vs Output Voltage

7.9 Typical Characteristics: $V_S = 10\text{ V}$ (continued)

at $V_{S+} = 5\text{ V}$, $V_{S-} = -5\text{ V}$, $R_F = 0\ \Omega$ for Gain = 1 V/V, otherwise $R_F = 1\text{ k}\Omega$ for other gains, $C_L = 1\text{ pF}$, $R_L = 2\text{ k}\Omega$ referenced to mid-supply, $G = 1\text{ V/V}$, input and output referenced to mid-supply, and $T_A \cong 25^\circ\text{C}$ (unless otherwise noted)

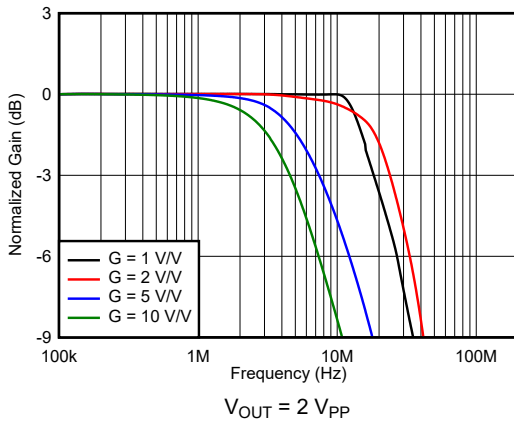

7-7. Large-Signal Frequency Response vs Gain

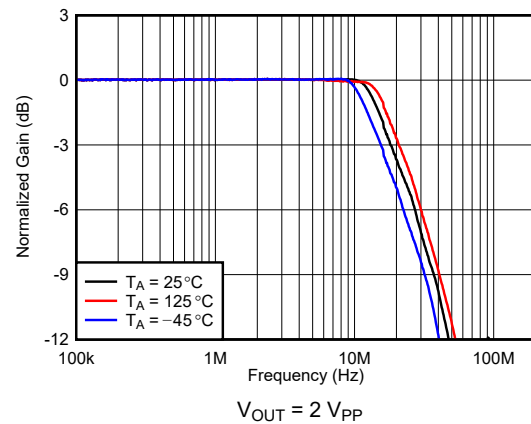

7-8. Frequency Response vs Ambient Temperature

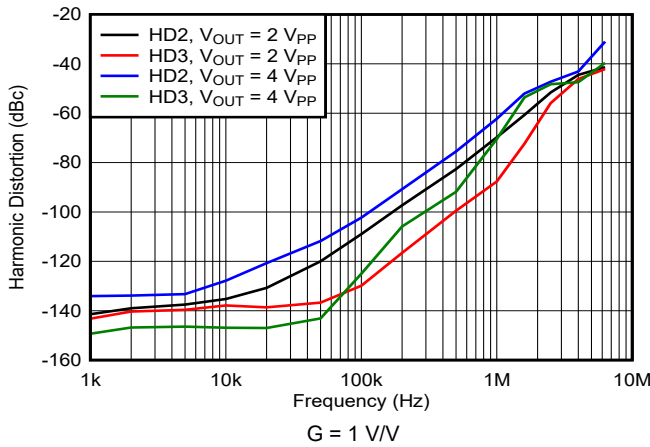

7-9. Harmonic Distortion vs Frequency

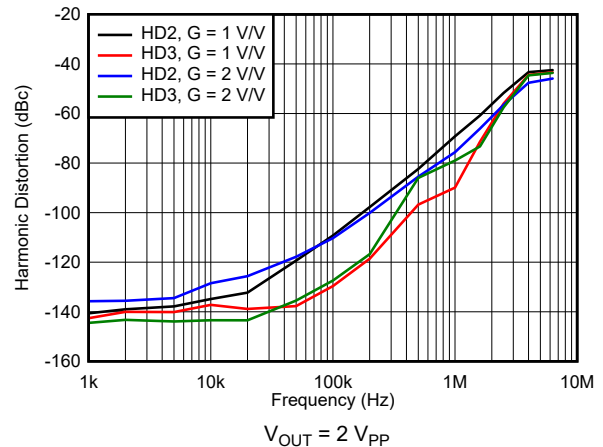

7-10. Harmonic Distortion vs Gain

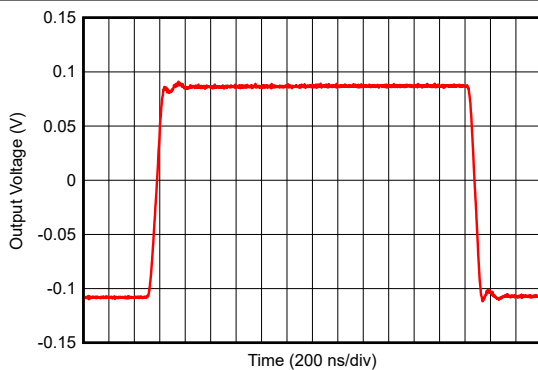

7-11. Small-Signal Transient Response

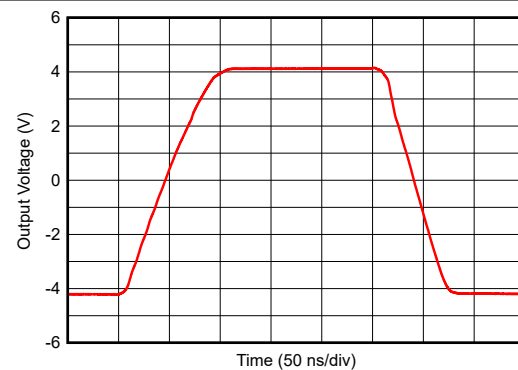

7-12. Large-Signal Transient Response

7.9 Typical Characteristics: $V_S = 10\text{ V}$ (continued)

at $V_{S+} = 5\text{ V}$, $V_{S-} = -5\text{ V}$, $R_F = 0\ \Omega$ for Gain = 1 V/V, otherwise $R_F = 1\text{ k}\Omega$ for other gains, $C_L = 1\text{ pF}$, $R_L = 2\text{ k}\Omega$ referenced to mid-supply, $G = 1\text{ V/V}$, input and output referenced to mid-supply, and $T_A \cong 25^\circ\text{C}$ (unless otherwise noted)

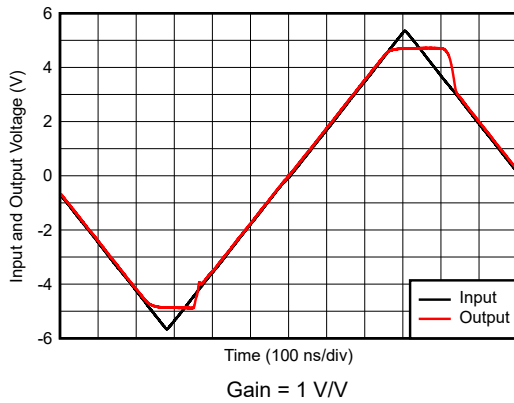

7-13. Input Overdrive Recovery

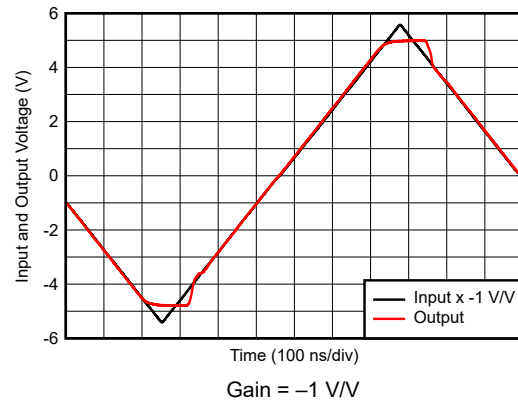

7-14. Output Overdrive Recovery

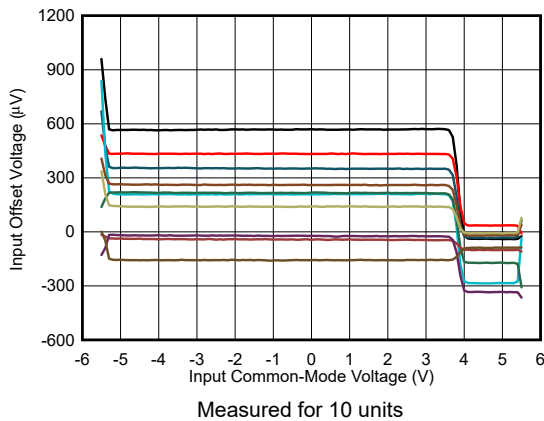

7-15. Input Offset Voltage vs Input Common-Mode Voltage

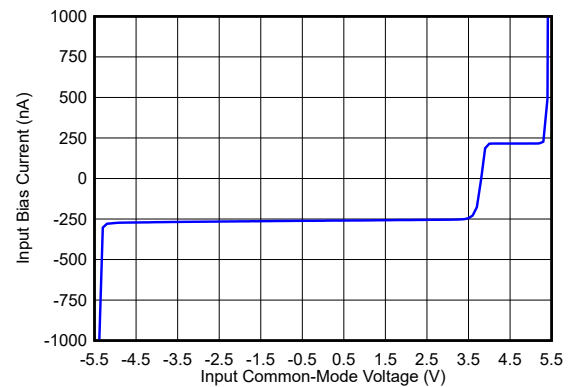

7-16. Input Bias Current vs Input Common-Mode Voltage

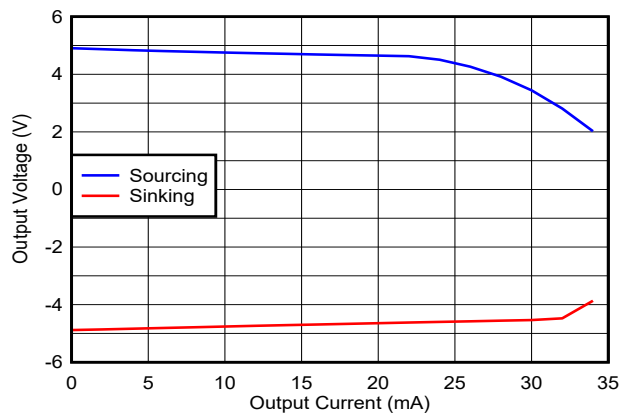

7-17. Output Voltage vs Load Current

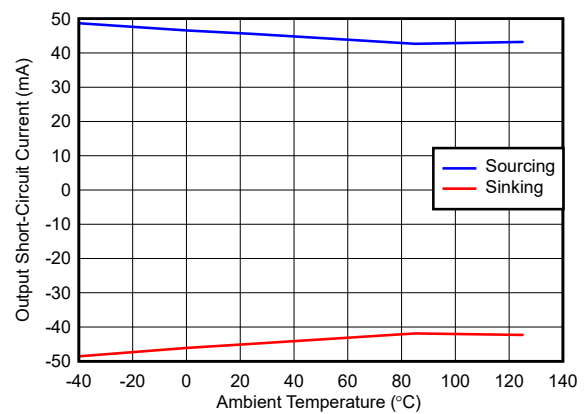

7-18. Output Short-Circuit Current vs Ambient Temperature

7.9 Typical Characteristics: $V_S = 10\text{ V}$ (continued)

at $V_{S+} = 5\text{ V}$, $V_{S-} = -5\text{ V}$, $R_F = 0\ \Omega$ for Gain = 1 V/V, otherwise $R_F = 1\text{ k}\Omega$ for other gains, $C_L = 1\text{ pF}$, $R_L = 2\text{ k}\Omega$ referenced to mid-supply, $G = 1\text{ V/V}$, input and output referenced to mid-supply, and $T_A \cong 25^\circ\text{C}$ (unless otherwise noted)

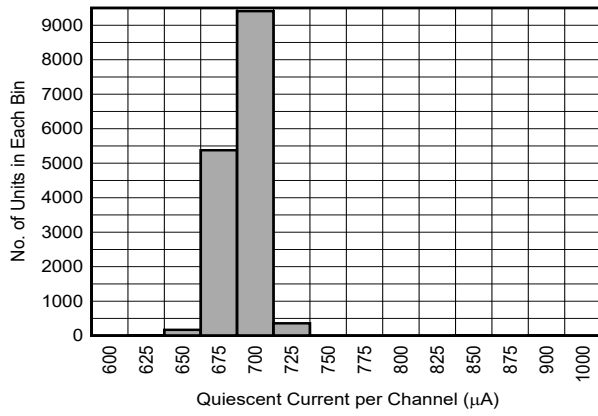

Fig 7-19. Quiescent Current Distribution

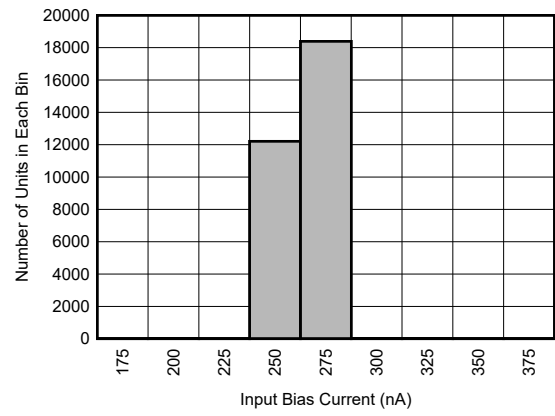

Fig 7-20. Input Bias Current Distribution

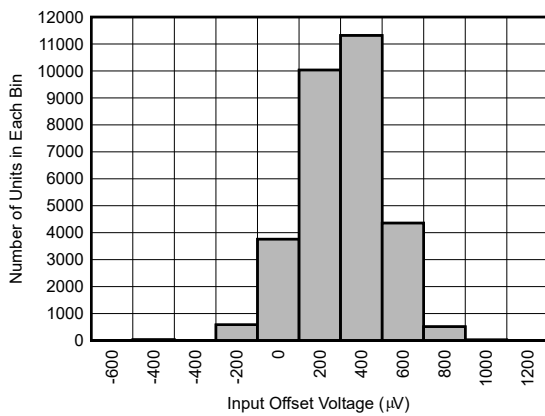

Fig 7-21. Input Offset Voltage Distribution

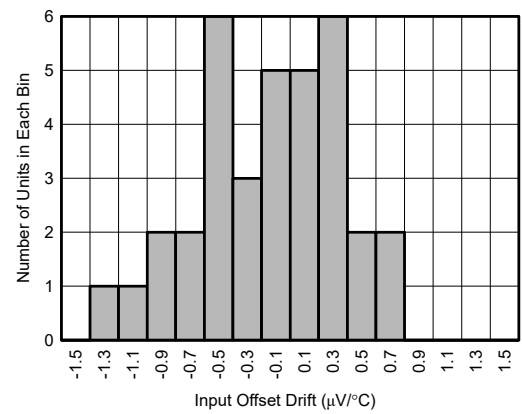

Fig 7-22. Input Offset Voltage Drift Distribution

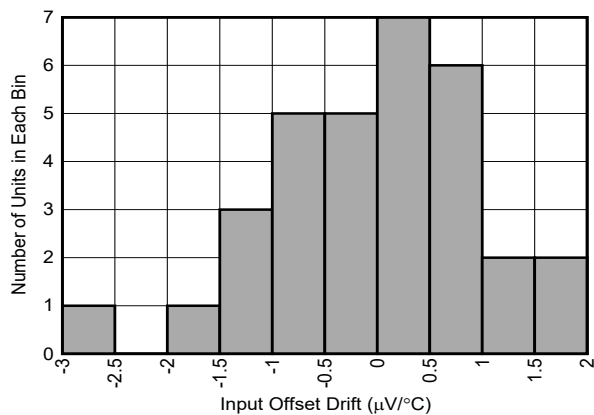

Fig 7-23. Input Offset Voltage Drift Distribution

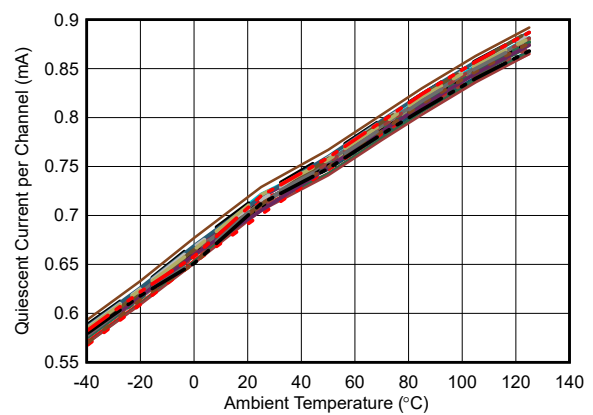
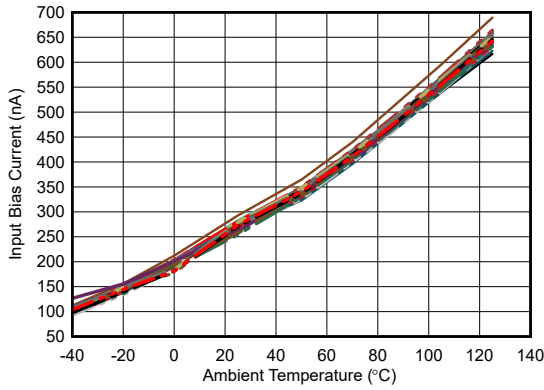

Fig 7-24. Quiescent Current vs Ambient Temperature

7.9 Typical Characteristics: $V_S = 10\text{ V}$ (continued)

at $V_{S+} = 5\text{ V}$, $V_{S-} = -5\text{ V}$, $R_F = 0\ \Omega$ for Gain = 1 V/V, otherwise $R_F = 1\text{ k}\Omega$ for other gains, $C_L = 1\text{ pF}$, $R_L = 2\text{ k}\Omega$ referenced to mid-supply, $G = 1\text{ V/V}$, input and output referenced to mid-supply, and $T_A \cong 25^\circ\text{C}$ (unless otherwise noted)



7-25. Input Bias Current vs Ambient Temperature

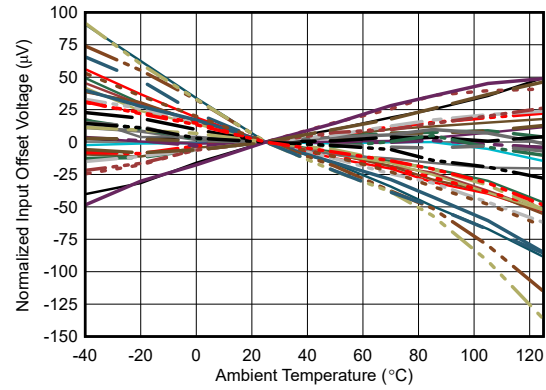

7-26. Input Offset Voltage vs Ambient Temperature

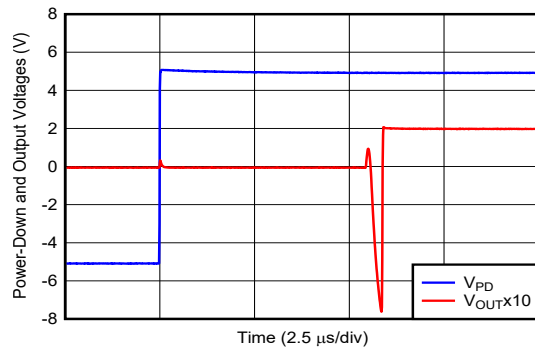

7-27. Turn-On Time to DC Input

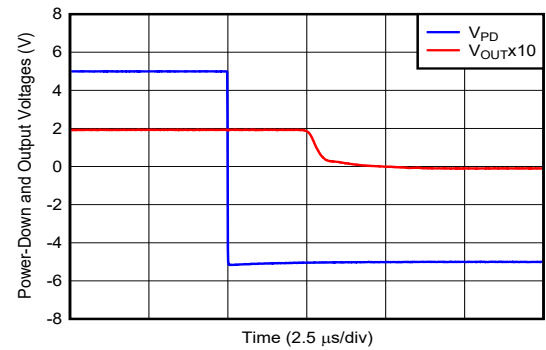

7-28. Turn-Off Time to DC Input

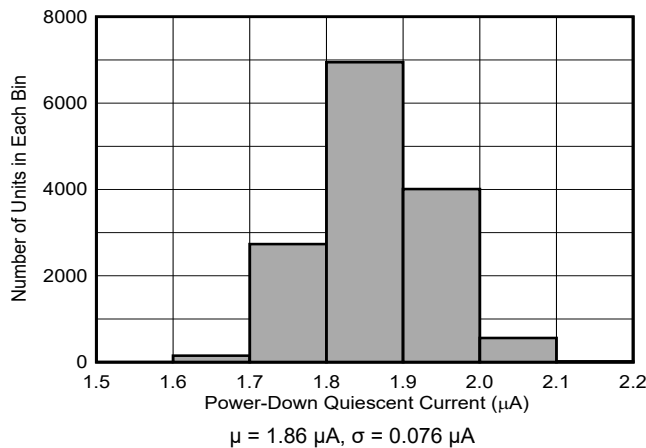

7-29. Power-Down Quiescent Current Distribution

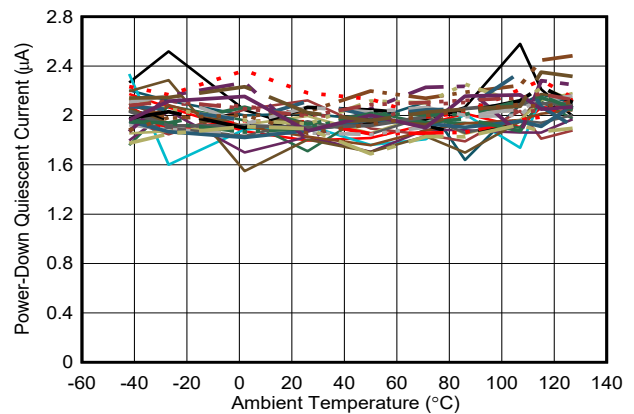

7-30. Power-Down I_Q vs Ambient Temperature

7.10 Typical Characteristics: $V_S = 3\text{ V}$

at $V_{S+} = 3\text{ V}$, $V_{S-} = 0\text{ V}$, $R_F = 0\ \Omega$ for Gain = 1 V/V, otherwise $R_F = 1\text{ k}\Omega$ for other gains, $C_L = 1\text{ pF}$, $R_L = 2\text{ k}\Omega$ connected to 1 V, $G = 1\text{ V/V}$, input and output $V_{CM} = 1\text{ V}$, and $T_A \cong 25^\circ\text{C}$ (unless otherwise noted)

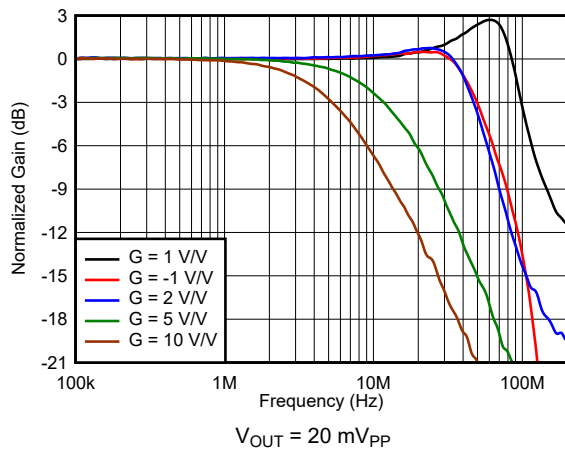

7-31. Small-Signal Frequency Response vs Gain

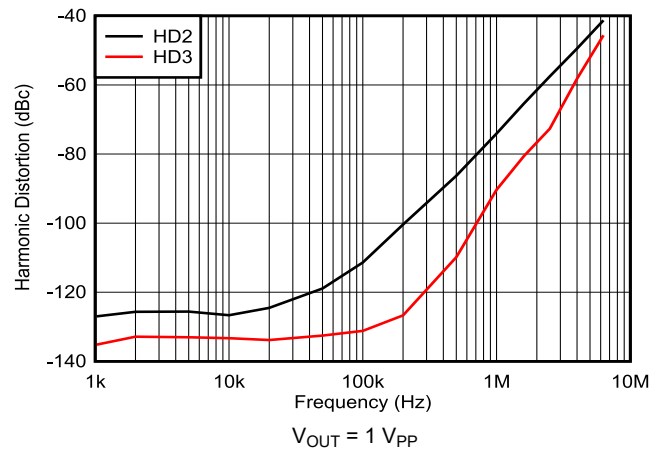

7-32. Harmonic Distortion vs Frequency

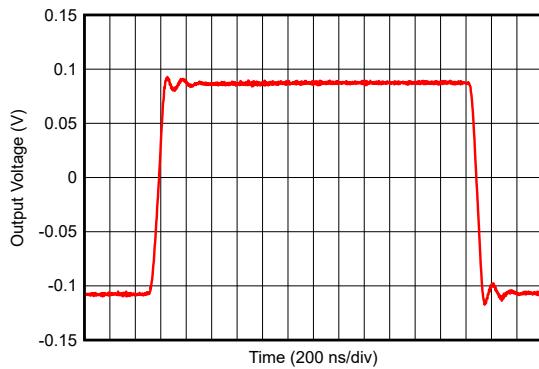

7-33. Small-Signal Transient Response

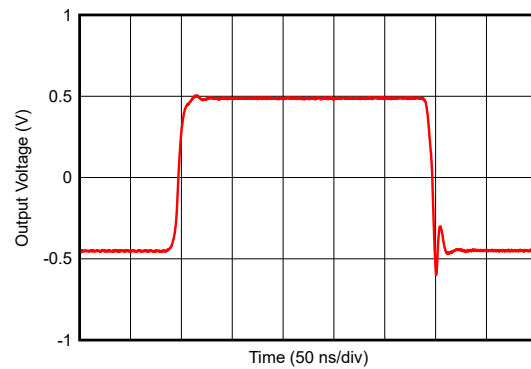

7-34. Large-Signal Transient Response

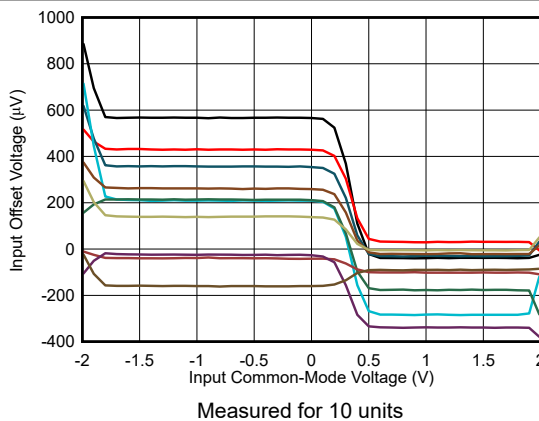

7-35. Input Offset Voltage vs Input Common-Mode Voltage

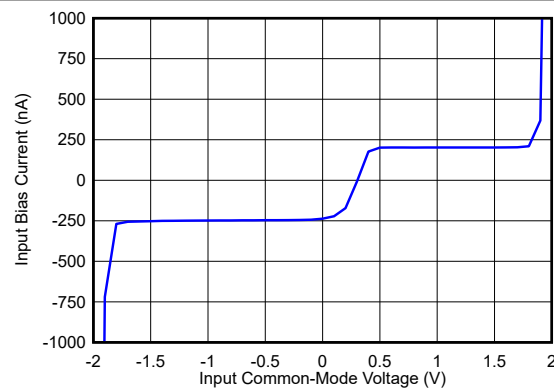

7-36. Input Bias Current vs Input Common-Mode Voltage

7.10 Typical Characteristics: $V_S = 3\text{ V}$ (continued)

at $V_{S+} = 3\text{ V}$, $V_{S-} = 0\text{ V}$, $R_F = 0\ \Omega$ for Gain = 1 V/V, otherwise $R_F = 1\text{ k}\Omega$ for other gains, $C_L = 1\text{ pF}$, $R_L = 2\text{ k}\Omega$ connected to 1 V, $G = 1\text{ V/V}$, input and output $V_{CM} = 1\text{ V}$, and $T_A \cong 25^\circ\text{C}$ (unless otherwise noted)

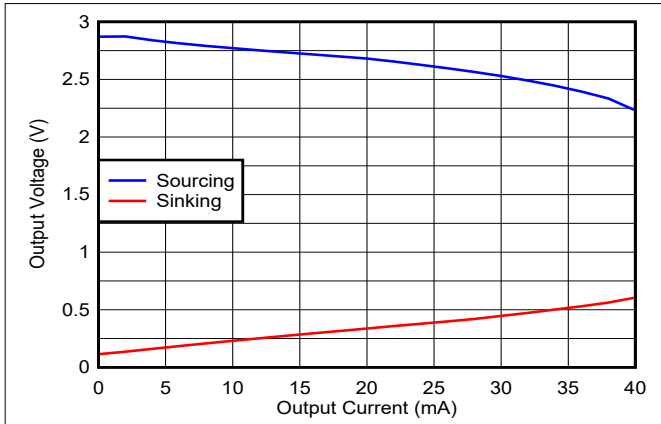

7-37. Output Voltage vs Load Current

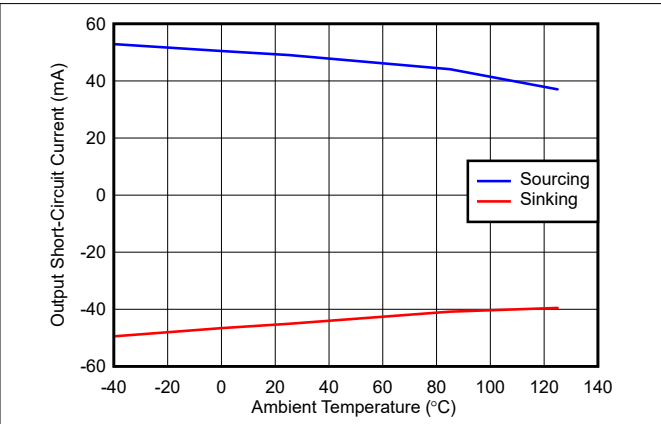

7-38. Output Short-Circuit Current vs Ambient Temperature

Output saturated and then short-circuited to other supply

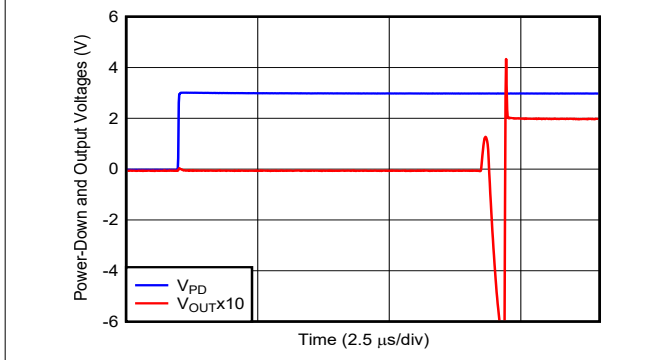

7-39. Turn-On Time to DC Input

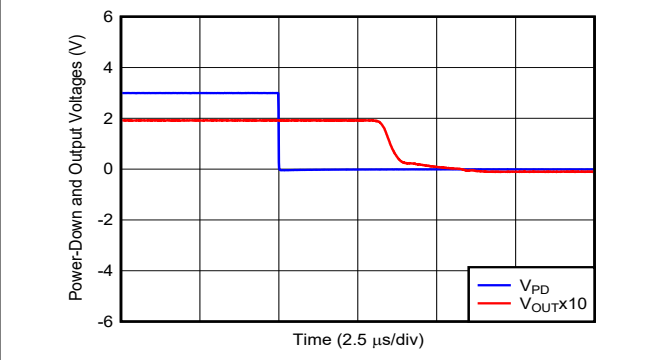

7-40. Turn-Off Time to DC Input

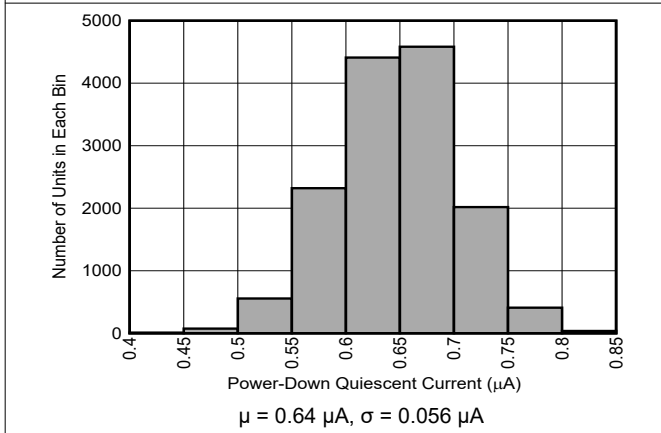

7-41. Power-Down Quiescent Current Distribution

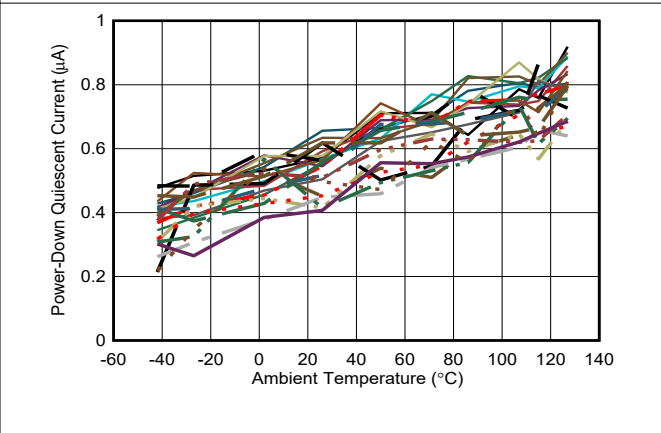

7-42. Power-Down I_Q vs Ambient Temperature

7.11 Typical Characteristics: $V_S = 3\text{ V to }10\text{ V}$

at $V_{OUT} = 2\text{ V}_{PP}$, $R_F = 0\ \Omega$ for Gain = 1 V/V, otherwise $R_F = 1\text{ k}\Omega$ for other gains, $C_L = 1\text{ pF}$, $R_L = 2\text{ k}\Omega$ referenced to mid-supply, $G = 1\text{ V/V}$, input and output referenced to mid-supply, and $T_A \cong 25^\circ\text{C}$ (unless otherwise noted)

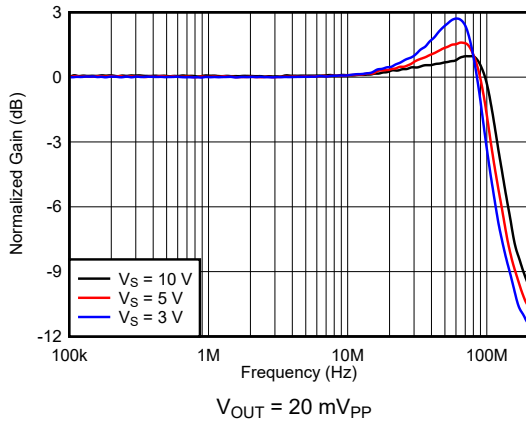

7-43. Frequency Response vs Supply Voltage

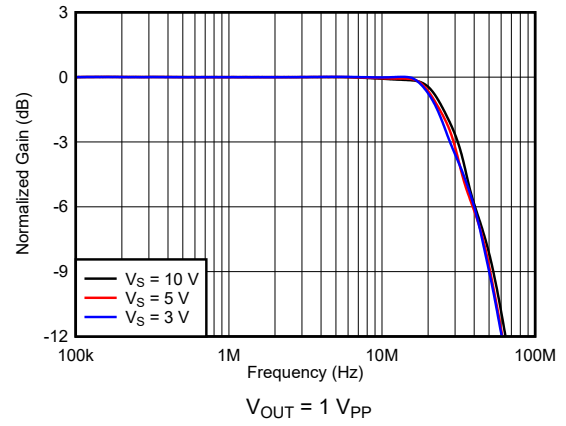

7-44. Frequency Response vs Supply Voltage

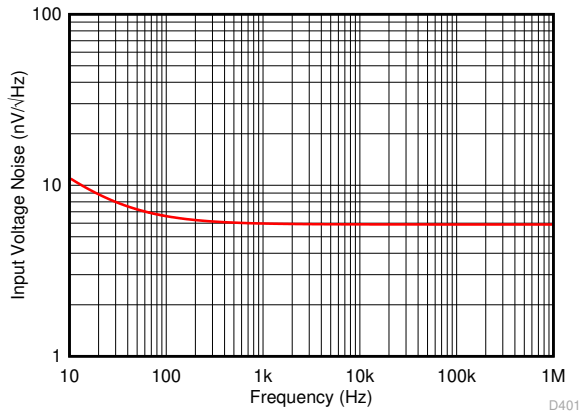

7-45. Input Voltage Noise Density vs Frequency

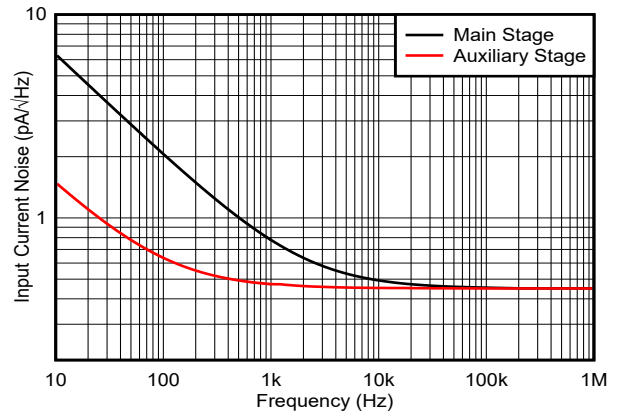

7-46. Input Current Noise Density vs Frequency

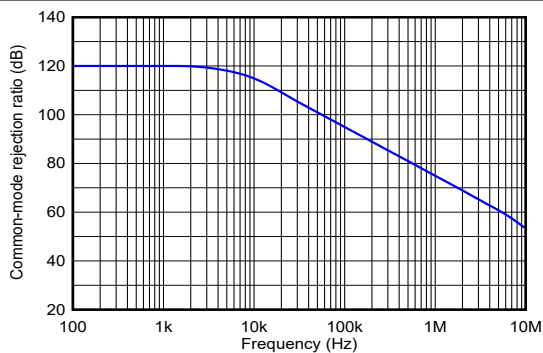

7-47. Common-Mode Rejection Ratio vs Frequency

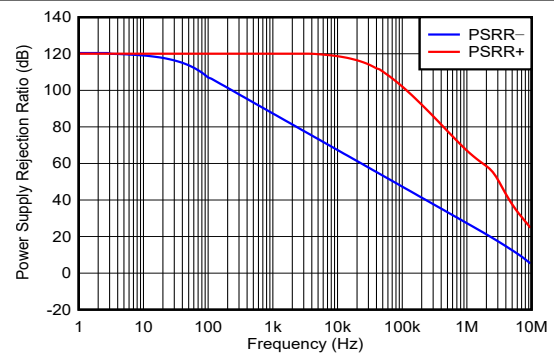

7-48. Power Supply Rejection Ratio vs Frequency

7.11 Typical Characteristics: $V_S = 3\text{ V to }10\text{ V}$ (continued)

at $V_{OUT} = 2\text{ V}_{PP}$, $R_F = 0\ \Omega$ for Gain = 1 V/V, otherwise $R_F = 1\text{ k}\Omega$ for other gains, $C_L = 1\text{ pF}$, $R_L = 2\text{ k}\Omega$ referenced to mid-supply, $G = 1\text{ V/V}$, input and output referenced to mid-supply, and $T_A \cong 25^\circ\text{C}$ (unless otherwise noted)

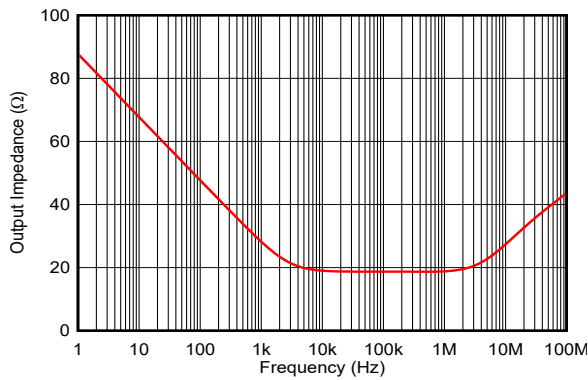

7-49. Open-Loop Output Impedance vs Frequency

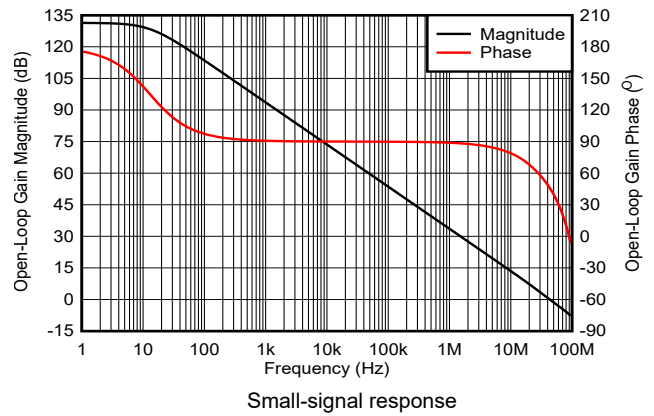

7-50. Open-Loop Gain and Phase vs Frequency

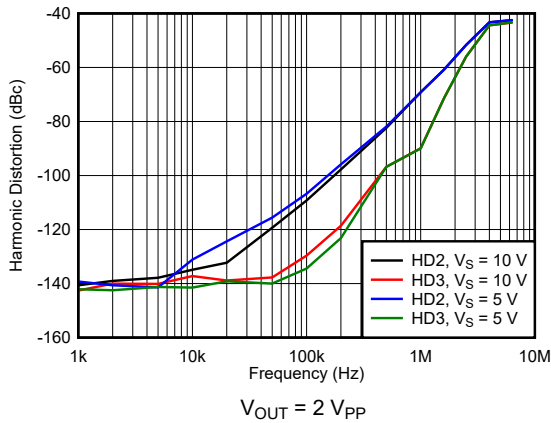

7-51. Harmonic Distortion vs Supply Voltage

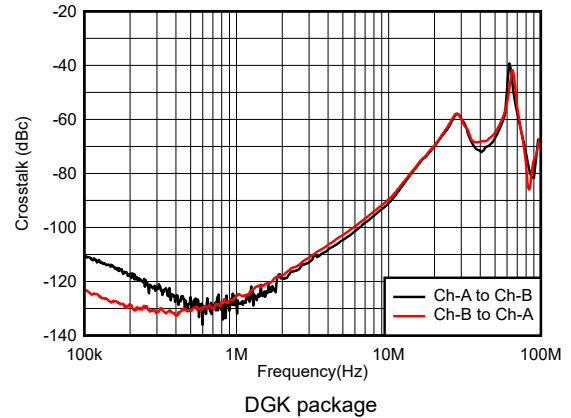

7-52. Crosstalk vs Frequency

8 Detailed Description

8.1 Overview

The OPAx863 devices are low-power, 50-MHz, rail-to-rail input and output (RRIO), bipolar, voltage-feedback operational amplifiers with a voltage noise density of 5.9 nV/√Hz and 1/f noise corner at 25 Hz. The OPAx863 work with a wide-supply voltage range of 2.7 V to 12.6 V, and consume only 700 μA quiescent current. The OPAx863 operate with a 2.7 V supply, are RRIO capable, consume low-power, and offer a power-down mode, which makes them great amplifiers for 3.3-V or lower-voltage applications that require excellent ac performance. The main and auxiliary input stages of the amplifier are matched for gain bandwidth product (GBW), noise, and offset voltage and designed for applications that require wide dynamic input range and good SNR.

The device includes an overload power limit feature which limits the increase in quiescent current with overdriven and saturated outputs to either of the supply rails. For more details of this overload power limit feature, see [セクション 8.3.2.1](#). The amplifier's output is protected against short-circuit fault conditions.

The OPAx863 feature a power-down mode (PD) with a PD quiescent current of 1.5 μA (maximum) with a 3-V supply, with turn-on and turn-off time within less than 6.5 μs.

8.2 Functional Block Diagram

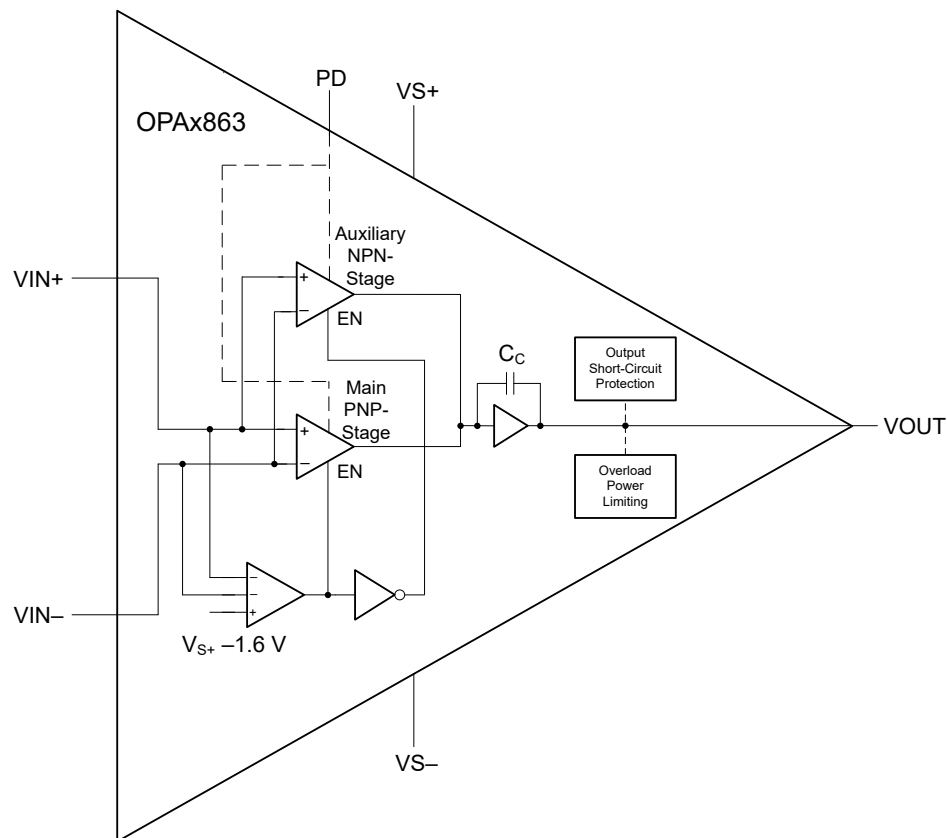

8.3 Feature Description

8.3.1 Input Stage

The OPAx863 include a rail-to-rail input stage. The main stage differential pair using PNP bipolar transistors operates for common-mode input voltages from $V_{S-} - 0.2\text{ V}$ to $V_{S+} - 1.6\text{ V}$. The amplifier inputs transition into the auxiliary stage using NPN transistors for common-mode input voltages from $V_{S+} - 1.6\text{ V}$ till $V_{S+} + 0.2\text{ V}$. The PNP and NPN input stages offer a gain-bandwidth product of 50 MHz and a voltage noise density of 6.3 nV/ $\sqrt{\text{Hz}}$. The offset voltage for the two input stages is matched to lie within the device specifications. The auxiliary NPN input stage does not use the slew-boost circuit during large-signal transient response. The input bias current for the PNP and NPN input stages is opposite in polarity, which adds an additional offset based on the values of the gain-setting and feedback resistors. A common-mode input voltage transition between these input stages causes a crossover distortion that must be considered in high-frequency applications requiring excellent linearity. Limit the common-mode input voltage to $V_{S+} - 1.6\text{ V}$ (maximum) for main-stage operation across process and ambient temperature.

The OPAx863 are bipolar amplifiers; therefore, the two inputs are protected with antiparallel back-to-back diodes between the inputs, which limits the maximum input differential voltage to 1 V. The amplifier is slew limited, and the two inputs are pulled apart up to 1 V when the antiparallel diodes begin to conduct in very fast input or output transient conditions. Make sure to use gain-setting and feedback resistors large enough to limit the current through these diodes in such conditions.

8.3.2 Output Stage

The OPAx863 feature a rail-to-rail output stage with possible signal swing from $V_{S-} + 0.2\text{ V}$ to $V_{S+} - 0.2\text{ V}$. Violating the output headroom of either supply causes output signal clipping and introduces distortion.

The OPAx863 integrate an output short-circuit protection circuit that makes the device rugged for use in real-world applications.

8.3.2.1 Overload Power Limit

The OPAx863 include overload power limiting that limits the increase in device quiescent current with output saturated to either of the supplies. Typically, when an amplifier output saturates, the two inputs are pulled apart, which can enable the slew-boost circuit. The input differential voltage is an error voltage in negative feedback that the amplifier core nullifies by engaging the slew-boost circuit and driving the output stage deeper into saturation. After the input to an amplifier attains a value large enough to saturate the output, any further increase in this input excitation results in a finite input differential voltage. As the output stage transistor is pushed deeper into saturation, the base-to-collector current gain (h_{FE}) drops with an increase in the base and collector current, and an increase in the device quiescent current. This increase in quiescent current can cause a catastrophic failure in multichannel, high-gain, high-density front-end designs, and reduce operating lifetime in portable, battery-powered systems.

The OPAx863 overload power limiting includes an intelligent output saturation-detection circuit that limits the device quiescent current to 2.2-mA per channel under dc overload conditions. This increase in quiescent current is smaller with ac input or output and output saturation duration for only a fraction of the overall signal time period. 表 8-1 compares the increase in quiescent current with 50-mV input overdrive for OPAx863 devices and other voltage-feedback amplifiers without overload power limit.

表 8-1. Quiescent Current With Saturated Outputs

DEVICE	INPUT DIFFERENTIAL VOLTAGE	QUIESCENT CURRENT DURING OVERLOAD	INCREASE IN I_Q FROM STEADY-STATE CONDITION
OPAx863 with overload power limit	50 mV	1.1 mA	1.57 ×
Competitor amplifier without overload power limit	50 mV	1.96 mA	3.43 ×

8.3.3 ESD Protection

As [Figure 8-1](#) shows, all device pins are protected with internal ESD protection diodes to the power supplies. These diodes provide moderate protection to input overdrive voltages greater than the supplies. The protection diodes typically support 10-mA continuous input and output currents. Use series current limiting resistors if input voltages exceeding the supply voltages occur at the amplifier inputs, which makes sure that the current through the ESD diodes remains within the rated value. OPAx863 is a bipolar amplifier; therefore, the two inputs are protected with antiparallel, back-to-back diodes between the inputs that limits the maximum input differential voltage to approximately 1 V. Make sure to use gain-setting and feedback resistors large enough to limit the current through these diodes in fast slewing conditions.

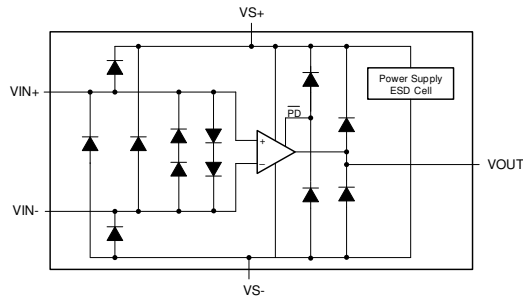

Figure 8-1. Internal ESD Protection

8.4 Device Functional Modes

8.4.1 Power-Down Mode

The OPAx863 includes a power-down mode for low-power standby operation with a quiescent current of only 1.5 μA (maximum) with a 3-V supply and high output impedance. Many low-power systems are active for only a small time interval when the parameters of interest are measured and remain in low-power standby mode for a majority of the time and an overall small average power consumption. The OPAx863 enables such a low-power operation with quick turn-on within less than 6.5 μs . See the *Electrical Characteristics* tables for power-down pin control thresholds.

Always drive $\overline{\text{PD}}$ pin to avoid false triggering and oscillations. If power-down mode is not used, then connect the $\overline{\text{PD}}$ pin to V_{S+} . For applications that need power-down mode, use an external pull-up resistor from the $\overline{\text{PD}}$ pin to V_{S+} (driven with an open-collector power-down control logic).

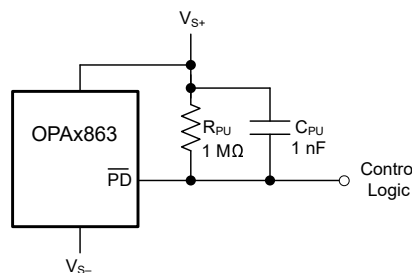

Figure 8-2. Power Down Control

[Figure 8-2](#) shows the choice of value of the pull-up resistor R_{PU} , which impacts the current consumption in power-down mode. Using a large R_{PU} reduces power consumption, but increases the noise at the PD pin, which can cause the amplifier to power down. A 1-nF capacitor can be used in parallel with R_{PU} to avoid coupling of external noise and false triggering. For the case of the $\overline{\text{PD}}$ pin driven to V_{S-} , the I_{PU} current through R_{PU} is given as:

$$I_{\text{PU}} = \frac{V_{S+} - V_{S-}}{R_{\text{PU}}} \quad (1)$$

9 Application and Implementation

注

以下のアプリケーション情報は、TI の製品仕様に含まれるものではなく、TI ではその正確性または完全性を保証いたしません。個々の目的に対する製品の適合性については、お客様の責任で判断していただくこととなります。お客様は自身の設計実装を検証しテストすることで、システムの機能を確認する必要があります。

9.1 Application Information

The OPAx863 are classic voltage-feedback amplifiers with two high-impedance inputs and a low-impedance output. These devices have a GBW of 50 MHz, 5.9 nV/√Hz of noise, RRIO capability, and precision performance consuming only 700 μA quiescent current per channel. These features make the OPAx863 an excellent choice for use in low-side current sensing, ADC input driver, and reference buffering with fast settling, buffers, high gain and filter circuits. The overload power limit makes the OPAx863 truly low-power in high-gain, multichannel systems limiting any increase in quiescent current during output overload conditions.

9.2 Typical Applications

9.2.1 Low-Side Current Sensing

Power converters use current-mode feedback control for excellent transient response and multiphase load sharing. Inverter stages control the phase currents for torque control in motor drives. As a result of the simplicity and low-cost, many of these topologies use difference-amplifier-based, low-side current sensing.  9-1 shows the use of the OPAx863 in a difference amplifier circuit for low-side current sensing.

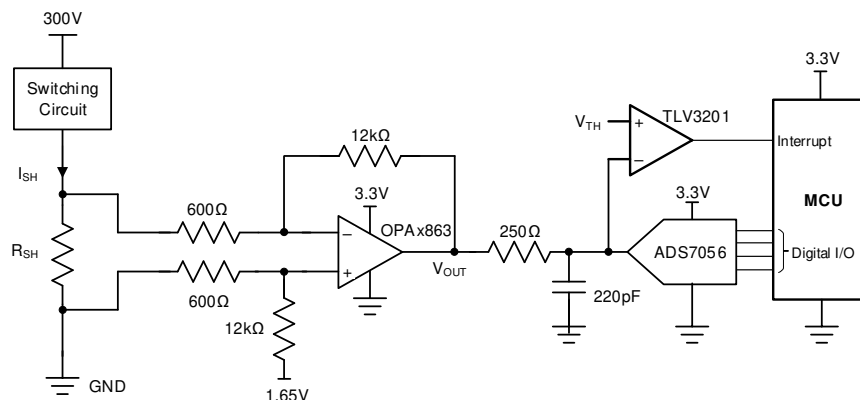

 9-1. Low-Side Current Sensing in Power Converters

9.2.1.1 Design Requirements

表 9-1. Design Requirements

PARAMETER	DESIGN REQUIREMENT
Shunt resistor	10 mΩ
Input current	15 A _{PP}
Output voltage	3 V _{PP}
Switching frequency	50 kHz
Data acquisition	1 MSPS with 0.1% accuracy
Input voltage due to ground bounce	10 V _{pk}

9.2.1.2 Detailed Design Procedure

In a difference amplifier circuit, the output voltage is given by:

$$V_O = \frac{R_F}{R_G} I_{SH} R_{SH} + V_{REF} \quad (2)$$

For lowest system noise, small values of R_F and R_G are preferred. The smallest value of R_G is limited by the input transient voltage (10 V here) seen by the circuit, and is given by:

$$R_G = \frac{V_{IN(max.)} - V_D - V_S}{I_{D(max.)}} \quad (3)$$

Where,

- $V_{IN(maximum)}$ is the maximum input transient voltage seen by the circuit.
- V_D is the forward voltage drop of ESD diodes at the amplifier input.
- $I_{D(maximum)}$ is the maximum current rating of the ESD diodes at the amplifier input.

For a difference amplifier gain of 20 V/V, an R_F of 12 k Ω and R_G of 600 Ω are used. With a clock frequency of 40 MHz and the ADS7056 sampling at 1 MSPS, the available acquisition time for amplifier output settling is 550 ns. [Figure 9-2](#) shows the simulation results for the circuit in [Figure 9-1](#). The worst-case peak-to-peak input transient condition is simulated. The output of the OPAx863 device settles to within 0.1% accuracy within 543 ns. If using a slower clock frequency with the ADC is desired, then the acquisition time reduces with the same sampling rate, which degrades measurement accuracy. Alternatively, the sampling rate can be reduced to recover the required acquisition time and 0.1% accuracy.

9.2.1.3 Application Curves

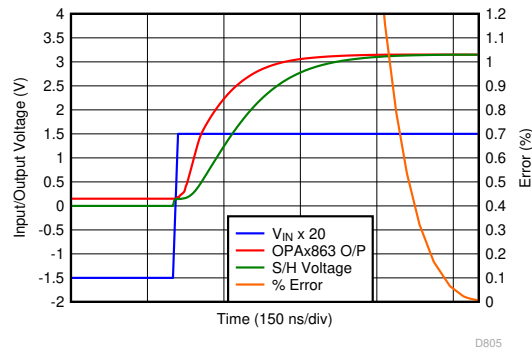

Figure 9-2. 0.1% Settling Performance

9.2.2 Front-End Gain and Filtering

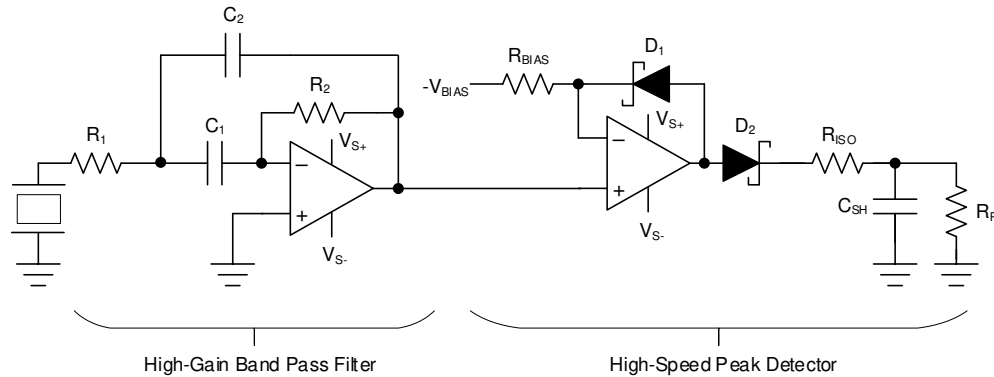

Figure 9-3. High-Gain Narrow Bandpass Filter and Peak Detector Circuit

Ultrasonic signaling is used for proximity and obstacle detection, level sensing, sonars, and so forth. Such signal chains detect the amplitude of received ultrasonic signal at a particular center frequency. Figure 9-3 shows a high-gain narrow bandpass filter and peak detector circuit using any of the OPAX863 devices. The signal at the frequency of interest is filtered out, gained, and peak detected to report the amplitude at the output of this circuit. The phase information is lost in this circuit. The OPAX863 devices are used with the 50-MHz GBW to add a single-stage gain and filtering, and the peak detection capability is easily made with the RRIO capability of these amplifiers.

9.2.3 Low-Power SAR ADC Driver and Reference Buffer

Figure 9-4 shows the use of the OPAX863 as a SAR ADC input driver and reference buffer driving the ADS7945 sensors, which are used for interface with the physical environment, exhibit high output impedance, and cannot drive SAR ADC inputs directly. A wide-GBW amplifier, such as the OPAX863, is needed to charge the switching capacitors at the SAR ADC input, and quickly settle to the required accuracy within the given acquisition time. The ADC core draws transient current from the reference input during the conversion (digitization) phase, which must be driven with a wide-GBW amplifier to offer fast settling and maintain a stable reference voltage for excellent digitization performance. The OPAX863 reference buffer is used in a composite loop with the OPA378 precision amplifier because of limitations in precision performance of wide-GBW amplifiers. The precision amplifier maintains low-offset output, whereas the OPAX863 devices provide the output drive and fast-settling performance.

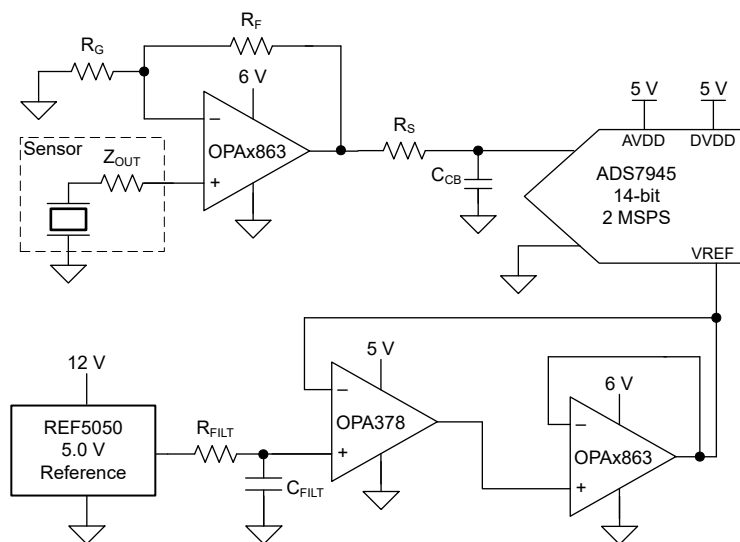

Figure 9-4. OPAX863 as Low-Power SAR ADC Driver

9.2.4 Variable Reference Generator Using MDAC

High-speed amplifiers can be used as a voltage buffer at MDAC output to generate a fast-settling variable reference voltage. [Figure 9-5](#) shows a representative circuit using [DAC8801](#) and [OPAx863](#).

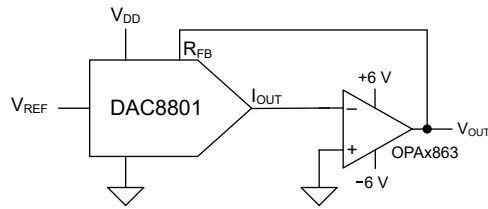

Figure 9-5. Variable Reference Generator Using MDAC and OPAx863

9.2.5 Clamp-On Ultrasonic Flow Meter

[Figure 9-6](#) shows how ultrasonic flow meters measure the rate of flow of a liquid using transit-time difference ($t_{12} - t_{21}$), which depends on the flow rate. [Figure 9-6](#) shows a representative schematic for a non-intrusive ultrasonic flow meter using the [OPAx863](#) and 12-V transducer excitation. The [OPAx863](#) are used for the forward path as a unity-gain buffer for 12-V pulsed transducer excitation at NODE 1. At the same time, the receiver circuit at NODE 2 (which also uses the [OPAx863](#)) first provides an ac-gain followed by a dc-level shift to lead to the PGA, ADC, and processor within the [MSP430™](#) microcontroller.

NODE 2 and NODE 1 use similar transmit and receive circuits (discussed previously) for the reverse path. The [OPAx863](#) wide GBW of 50 MHz introduces minimal phase-delay and low-noise for excellent flow rate measurement. The amplifier stays in power-down mode for a majority of the time in battery-powered systems. This configuration results in very small average system-level power consumption and prolonged battery lifetime with the 1.5- μ A (maximum) power-down mode quiescent current with a 3-V supply. The transmit and receive signal chains are connected to the same point at the respective node transducers. Therefore, the [OPAx863](#) 12.6-V supply voltage capability enables 12-V transducer excitation without any damage to the front-end, or a need for external switches, thus enabling a more compact solution. These specifications make the [OPAx863](#) an excellent choice for flow measurements in large diameter pipes and non-intrusive flow meters. The [TIDM-02003 reference design](#) discusses an ultrasonic gas flow sensing subsystem which uses high-speed amplifiers for front-end amplification.

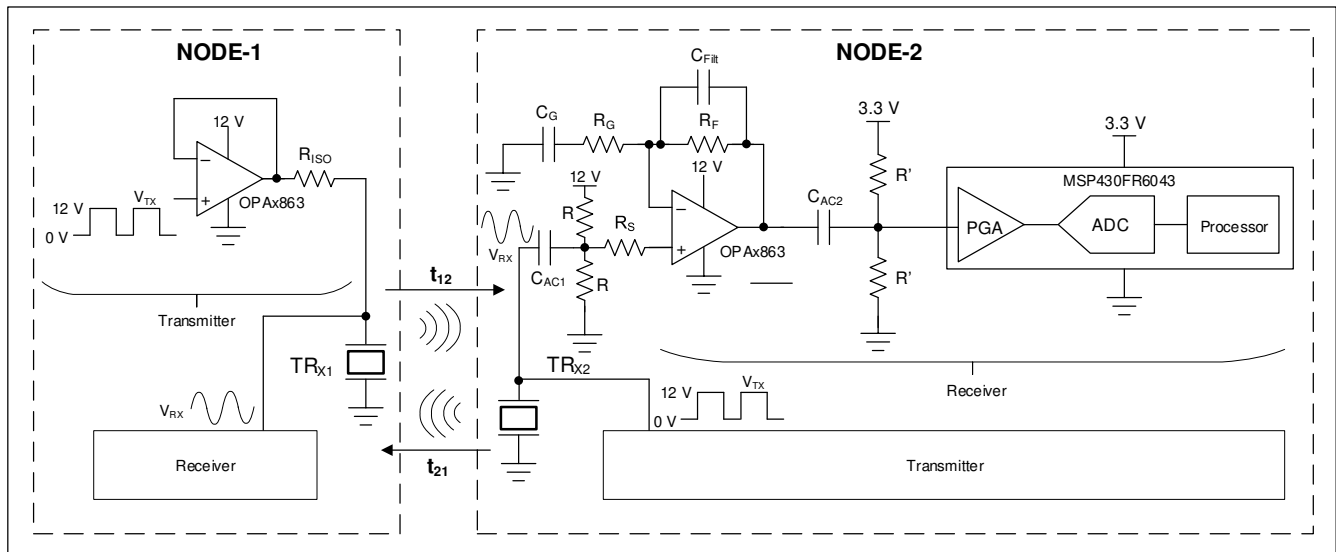

Figure 9-6. Non-Intrusive Ultrasonic Flow Meter

9.3 Power Supply Recommendations

The OPAx863 is intended to operate on supplies ranging from 2.7 V to 12.6 V. The OPAx863 devices operate on single-sided supplies, split and balanced bipolar supplies, or unbalanced bipolar supplies. Operating from a single supply has numerous advantages. The dc errors, due to the $-PSRR$ term, can be minimized with the negative supply at ground. Typically, ac performance improves slightly at 10-V operation with minimal increase in supply current. Minimize the distance (< 0.1 in) from the power supply pins to high-frequency, 0.01- μ F decoupling capacitors. A larger capacitor (2.2 μ F typical) is used along with a high-frequency, 0.01- μ F supply-decoupling capacitor at the device supply pins. Only the positive supply has these capacitors for single-supply operation. Use these capacitors from each supply to ground when a split-supply is used. If necessary, place the larger capacitors further from the device and share these capacitors among several devices in the same area of the printed circuit board (PCB). An optional supply decoupling capacitor across the two power supplies (for split-supply operation) reduces second harmonic distortion.

9.4 Layout

9.4.1 Layout Guidelines

Achieving optimum performance with a high-frequency amplifier (like the OPAx863) requires careful attention to board layout parasitics and external component types. The [OPA2863 DGK Evaluation Module user's guide](#) can be used as a reference when designing the circuit board. Recommendations that optimize performance includes the following:

1. **Minimize parasitic capacitance** to any ac ground for all of the signal I/O pins. Parasitic capacitance on the output and inverting input pins can cause instability on the noninverting input and can react with the source impedance to cause unintentional band-limiting. Open a window around the signal I/O pins in all of the ground and power planes around those pins to reduce unwanted capacitance. Otherwise, ground and power planes must be unbroken elsewhere on the board.
2. **Minimize the distance** (< 0.1 in) from the power-supply pins to high-frequency 0.01- μ F decoupling capacitors. Avoid narrow power and ground traces to minimize inductance between the pins and the decoupling capacitors. The power-supply connections must always be decoupled with these capacitors. Larger (2.2- μ F to 6.8- μ F) decoupling capacitors, effective at lower frequency, must also be used on the supply pins. These capacitors can be placed somewhat farther from the device and shared among several devices in the same area of the PCB.
3. **Careful selection and placement of external components preserves the high-frequency performance of the OPAx863.** Resistors must be a low reactance type. Surface-mount resistors work best and allow a tighter overall layout. Other network components, such as noninverting input termination resistors, must also be placed close to the package. Keep resistor values as low as possible and consistent with load-driving considerations. Lowering the resistor values keeps the resistor noise terms low and minimizes the effect of the parasitic capacitance. Lower resistor values, however, increase the dynamic power consumption because R_F and R_G become part of the amplifier output load network.

9.4.1.1 Thermal Considerations

The OPAx863 does not require heat sinking or airflow in most applications. The maximum allowed junction temperature sets the maximum allowed internal power dissipation. Do not allow the maximum junction temperature to exceed 150°C.

Operating junction temperature (T_J) is given by,

$$T_J = T_A + P_D \times R_{\theta JA} \quad (4)$$

where

- T_A is the ambient temperature
- P_D is the total power dissipation internal to the amplifier
- $R_{\theta JA}$ is the junction-to-ambient thermal resistance

The total power dissipation $P_D = P_{DQ} + P_{DL}$

where

- $P_{DQ} = (V_{S+} - V_{S-}) \times I_{OQ}$, is the power dissipation due to the amplifier quiescent current
- $P_{DL(max)} = V_S^2 / (4 \times R_L)$, is the internal power dissipation due to the output load current

As a worst-case example, compute the maximum T_J using an OPA2863-DGK (VSSOP package) configured as a unity gain buffer, operating on ± 6 -V supplies at an ambient temperature of 25°C and driving a grounded 500- Ω load.

$$P_D = 12 \text{ V} \times 2 \text{ mA} + 6^2 / (4 \times 500 \text{ } \Omega) = 42 \text{ mW} \quad (5)$$

Maximum $T_J = 25^\circ\text{C} + (0.042 \text{ W} \times 180.3^\circ\text{C/W}) = 33^\circ\text{C}$, which is much less than the maximum allowed junction temperature of 150°C.

9.4.2 Layout Example

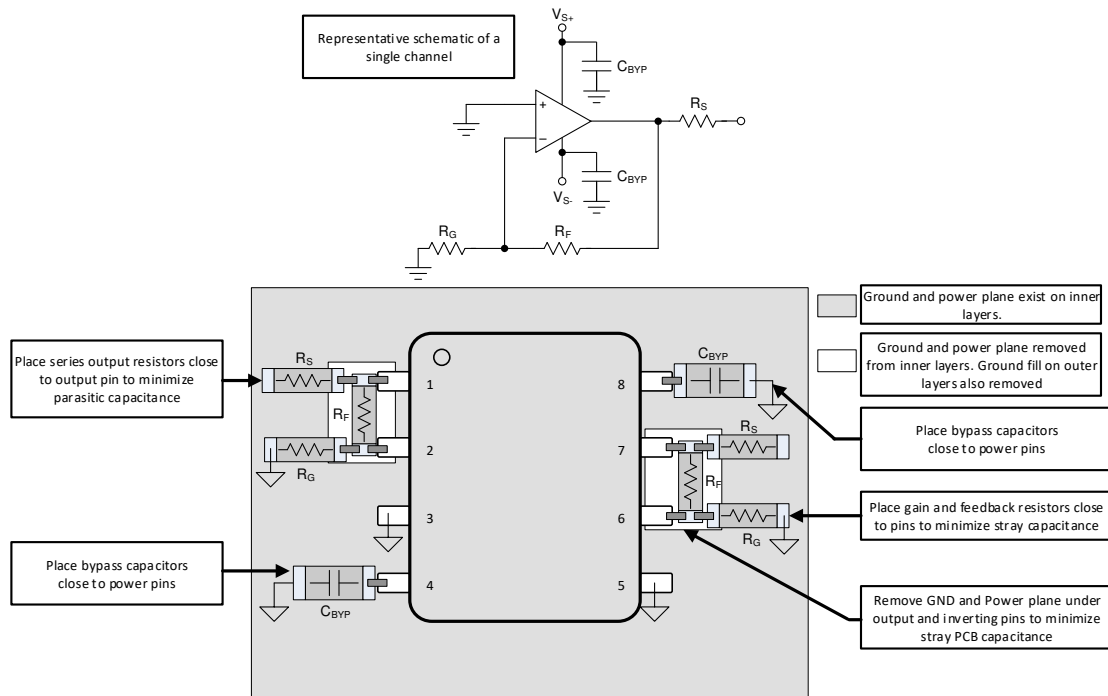

9-7. Layout Recommendation for Dual-Channel DGK Package

10 Device and Documentation Support

10.1 Documentation Support

10.1.1 Related Documentation

For related documentation, see the following:

- Texas Instruments, [OPA2863ADGK Evaluation Module user's guide](#)
- Texas Instruments, [Single-Supply Op Amp Design Techniques application report](#)

10.2 ドキュメントの更新通知を受け取る方法

ドキュメントの更新についての通知を受け取るには、[ti.com](#) のデバイス製品フォルダを開いてください。「更新の通知を受け取る」をクリックして登録すると、変更されたすべての製品情報に関するダイジェストを毎週受け取れます。変更の詳細については、修正されたドキュメントに含まれている改訂履歴をご覧ください。

10.3 サポート・リソース

[TI E2E™ サポート・フォーラム](#)は、エンジニアが検証済みの回答と設計に関するヒントをエキスパートから迅速かつ直接得ることができる場所です。既存の回答を検索したり、独自の質問をしたりすることで、設計に必要な支援を迅速に得ることができます。

リンクされているコンテンツは、該当する貢献者により、現状のまま提供されるものです。これらは TI の仕様を構成するものではなく、必ずしも TI の見解を反映したものではありません。TI の[使用条件](#)を参照してください。

10.4 Trademarks

MSP430™ and TI E2E™ are trademarks of Texas Instruments.

すべての商標は、それぞれの所有者に帰属します。

10.5 静電気放電に関する注意事項



この IC は、ESD によって破損する可能性があります。テキサス・インスツルメンツは、IC を取り扱う際には常に適切な注意を払うことを推奨します。正しい取り扱いおよび設置手順に従わない場合、デバイスを破損するおそれがあります。

ESD による破損は、わずかな性能低下からデバイスの完全な故障まで多岐にわたります。精密な IC の場合、パラメータがわずかに変化するだけで公表されている仕様から外れる可能性があるため、破損が発生しやすくなっています。

10.6 用語集

[テキサス・インスツルメンツ用語集](#) この用語集には、用語や略語の一覧および定義が記載されています。

11 Mechanical, Packaging, and Orderable Information

The following pages include mechanical, packaging, and orderable information. This information is the most current data available for the designated devices. This data is subject to change without notice and revision of this document. For browser-based versions of this data sheet, refer to the left-hand navigation.

PACKAGING INFORMATION

Orderable Device	Status (1)	Package Type	Package Drawing	Pins	Package Qty	Eco Plan (2)	Lead finish/ Ball material (6)	MSL Peak Temp (3)	Op Temp (°C)	Device Marking (4/5)	Samples
OPA2863DR	ACTIVE	SOIC	D	8	3000	RoHS & Green	NIPDAU	Level-1-260C-UNLIM	-40 to 125	O2863D	Samples
OPA2863IDGKR	ACTIVE	VSSOP	DGK	8	2500	RoHS & Green	NIPDAUAG SN	Level-2-260C-1 YEAR	-40 to 125	2FJ4	Samples
OPA2863RUNR	ACTIVE	QFN	RUN	10	3000	RoHS & Green	NIPDAUAG	Level-2-260C-1 YEAR	-40 to 125	O263	Samples
OPA4863PWR	ACTIVE	TSSOP	PW	14	3000	RoHS & Green	NIPDAU	Level-1-260C-UNLIM	-40 to 125	OPA4863	Samples
OPA863DBVR	ACTIVE	SOT-23	DBV	5	3000	RoHS & Green	SN	Level-1-260C-UNLIM	-40 to 125	2QS5	Samples
OPA863SIDBVR	ACTIVE	SOT-23	DBV	6	3000	RoHS & Green	SN	Level-1-260C-UNLIM	-40 to 125	O863	Samples

(1) The marketing status values are defined as follows:

ACTIVE: Product device recommended for new designs.

LIFEBUY: TI has announced that the device will be discontinued, and a lifetime-buy period is in effect.

NRND: Not recommended for new designs. Device is in production to support existing customers, but TI does not recommend using this part in a new design.

PREVIEW: Device has been announced but is not in production. Samples may or may not be available.

OBSELETE: TI has discontinued the production of the device.

(2) **RoHS:** TI defines "RoHS" to mean semiconductor products that are compliant with the current EU RoHS requirements for all 10 RoHS substances, including the requirement that RoHS substance do not exceed 0.1% by weight in homogeneous materials. Where designed to be soldered at high temperatures, "RoHS" products are suitable for use in specified lead-free processes. TI may reference these types of products as "Pb-Free".

RoHS Exempt: TI defines "RoHS Exempt" to mean products that contain lead but are compliant with EU RoHS pursuant to a specific EU RoHS exemption.

Green: TI defines "Green" to mean the content of Chlorine (Cl) and Bromine (Br) based flame retardants meet JS709B low halogen requirements of <=1000ppm threshold. Antimony trioxide based flame retardants must also meet the <=1000ppm threshold requirement.

(3) MSL, Peak Temp. - The Moisture Sensitivity Level rating according to the JEDEC industry standard classifications, and peak solder temperature.

(4) There may be additional marking, which relates to the logo, the lot trace code information, or the environmental category on the device.

(5) Multiple Device Markings will be inside parentheses. Only one Device Marking contained in parentheses and separated by a "-" will appear on a device. If a line is indented then it is a continuation of the previous line and the two combined represent the entire Device Marking for that device.

(6) Lead finish/Ball material - Orderable Devices may have multiple material finish options. Finish options are separated by a vertical ruled line. Lead finish/Ball material values may wrap to two lines if the finish value exceeds the maximum column width.

Important Information and Disclaimer: The information provided on this page represents TI's knowledge and belief as of the date that it is provided. TI bases its knowledge and belief on information provided by third parties, and makes no representation or warranty as to the accuracy of such information. Efforts are underway to better integrate information from third parties. TI has taken and continues to take reasonable steps to provide representative and accurate information but may not have conducted destructive testing or chemical analysis on incoming materials and chemicals. TI and TI suppliers consider certain information to be proprietary, and thus CAS numbers and other limited information may not be available for release.

In no event shall TI's liability arising out of such information exceed the total purchase price of the TI part(s) at issue in this document sold by TI to Customer on an annual basis.

OTHER QUALIFIED VERSIONS OF OPA2863 :

- Automotive : [OPA2863-Q1](#)

NOTE: Qualified Version Definitions:

- Automotive - Q100 devices qualified for high-reliability automotive applications targeting zero defects

TAPE AND REEL INFORMATION

QUADRANT ASSIGNMENTS FOR PIN 1 ORIENTATION IN TAPE

*All dimensions are nominal

Device	Package Type	Package Drawing	Pins	SPQ	Reel Diameter (mm)	Reel Width W1 (mm)	A0 (mm)	B0 (mm)	K0 (mm)	P1 (mm)	W (mm)	Pin1 Quadrant
OPA2863DR	SOIC	D	8	3000	330.0	12.4	6.4	5.2	2.1	8.0	12.0	Q1
OPA2863IDGKR	VSSOP	DGK	8	2500	330.0	12.4	5.25	3.35	1.25	8.0	12.0	Q1
OPA2863RUNR	QFN	RUN	10	3000	180.0	8.4	2.2	2.2	1.2	4.0	8.0	Q2
OPA4863PWR	TSSOP	PW	14	3000	330.0	12.4	6.9	5.6	1.6	8.0	12.0	Q1
OPA863DBVR	SOT-23	DBV	5	3000	178.0	9.0	3.3	3.2	1.4	4.0	8.0	Q3
OPA863SIDBVR	SOT-23	DBV	6	3000	178.0	9.0	3.3	3.2	1.4	4.0	8.0	Q3

TAPE AND REEL BOX DIMENSIONS

*All dimensions are nominal

Device	Package Type	Package Drawing	Pins	SPQ	Length (mm)	Width (mm)	Height (mm)
OPA2863DR	SOIC	D	8	3000	356.0	356.0	35.0
OPA2863IDGKR	VSSOP	DGK	8	2500	366.0	364.0	50.0
OPA2863RUNR	QFN	RUN	10	3000	213.0	191.0	35.0
OPA4863PWR	TSSOP	PW	14	3000	356.0	356.0	35.0
OPA863DBVR	SOT-23	DBV	5	3000	180.0	180.0	18.0
OPA863SIDBVR	SOT-23	DBV	6	3000	190.0	190.0	30.0

DBV0006A



PACKAGE OUTLINE

SOT-23 - 1.45 mm max height

SMALL OUTLINE TRANSISTOR



4214840/G 08/2024

NOTES:

1. All linear dimensions are in millimeters. Any dimensions in parenthesis are for reference only. Dimensioning and tolerancing per ASME Y14.5M.
2. This drawing is subject to change without notice.
3. Body dimensions do not include mold flash or protrusion. Mold flash and protrusion shall not exceed 0.25 per side.
4. Leads 1,2,3 may be wider than leads 4,5,6 for package orientation.
5. Reference JEDEC MO-178.

EXAMPLE BOARD LAYOUT

DBV0006A

SOT-23 - 1.45 mm max height

SMALL OUTLINE TRANSISTOR



LAND PATTERN EXAMPLE
EXPOSED METAL SHOWN
SCALE:15X



SOLDER MASK DETAILS

4214840/G 08/2024

NOTES: (continued)

- 6. Publication IPC-7351 may have alternate designs.
- 7. Solder mask tolerances between and around signal pads can vary based on board fabrication site.

EXAMPLE STENCIL DESIGN

DBV0006A

SOT-23 - 1.45 mm max height

SMALL OUTLINE TRANSISTOR



SOLDER PASTE EXAMPLE
BASED ON 0.125 mm THICK STENCIL
SCALE:15X

4214840/G 08/2024

NOTES: (continued)

8. Laser cutting apertures with trapezoidal walls and rounded corners may offer better paste release. IPC-7525 may have alternate design recommendations.
9. Board assembly site may have different recommendations for stencil design.



NOTES:

1. All linear dimensions are in millimeters. Any dimensions in parenthesis are for reference only. Dimensioning and tolerancing per ASME Y14.5M.
2. This drawing is subject to change without notice.
3. This dimension does not include mold flash, protrusions, or gate burrs. Mold flash, protrusions, or gate burrs shall not exceed 0.15 mm per side.
4. This dimension does not include interlead flash. Interlead flash shall not exceed 0.25 mm per side.
5. Reference JEDEC registration MO-153.

EXAMPLE BOARD LAYOUT

PW0014A

TSSOP - 1.2 mm max height

SMALL OUTLINE PACKAGE



LAND PATTERN EXAMPLE
EXPOSED METAL SHOWN
SCALE: 10X



4220202/B 12/2023

NOTES: (continued)

- 6. Publication IPC-7351 may have alternate designs.
- 7. Solder mask tolerances between and around signal pads can vary based on board fabrication site.

EXAMPLE STENCIL DESIGN

PW0014A

TSSOP - 1.2 mm max height

SMALL OUTLINE PACKAGE



SOLDER PASTE EXAMPLE
BASED ON 0.125 mm THICK STENCIL
SCALE: 10X

4220202/B 12/2023

NOTES: (continued)

8. Laser cutting apertures with trapezoidal walls and rounded corners may offer better paste release. IPC-7525 may have alternate design recommendations.
9. Board assembly site may have different recommendations for stencil design.



DBV0005A

PACKAGE OUTLINE

SOT-23 - 1.45 mm max height

SMALL OUTLINE TRANSISTOR

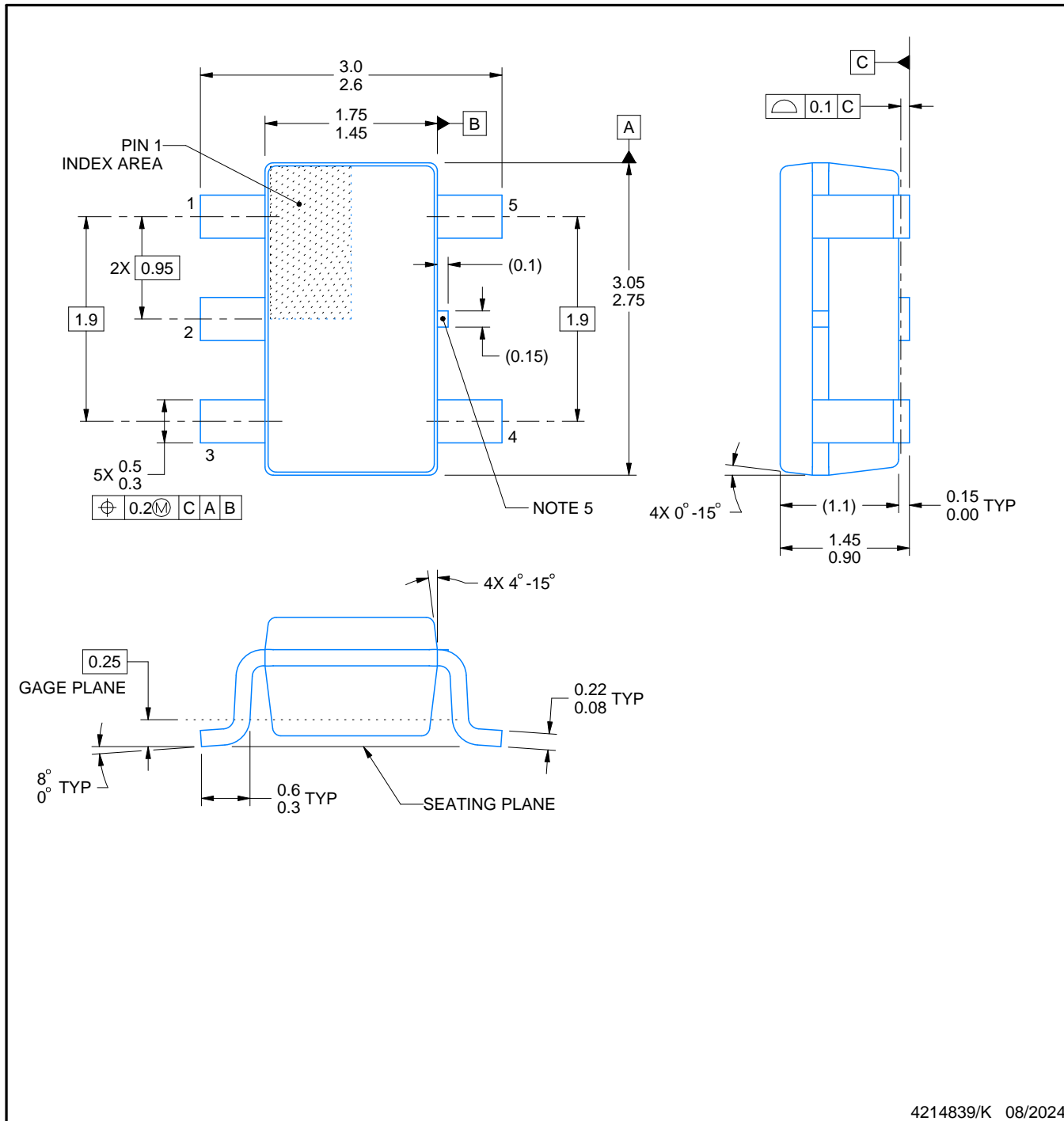

4214839/K 08/2024

NOTES:

- 1. All linear dimensions are in millimeters. Any dimensions in parenthesis are for reference only. Dimensioning and tolerancing per ASME Y14.5M.
- 2. This drawing is subject to change without notice.
- 3. Reference JEDEC MO-178.
- 4. Body dimensions do not include mold flash, protrusions, or gate burrs. Mold flash, protrusions, or gate burrs shall not exceed 0.25 mm per side.
- 5. Support pin may differ or may not be present.

EXAMPLE BOARD LAYOUT

DBV0005A

SOT-23 - 1.45 mm max height

SMALL OUTLINE TRANSISTOR



LAND PATTERN EXAMPLE
EXPOSED METAL SHOWN
SCALE:15X



SOLDER MASK DETAILS

4214839/K 08/2024

NOTES: (continued)

- 6. Publication IPC-7351 may have alternate designs.
- 7. Solder mask tolerances between and around signal pads can vary based on board fabrication site.

EXAMPLE STENCIL DESIGN

DBV0005A

SOT-23 - 1.45 mm max height

SMALL OUTLINE TRANSISTOR



SOLDER PASTE EXAMPLE
BASED ON 0.125 mm THICK STENCIL
SCALE:15X

4214839/K 08/2024

NOTES: (continued)

8. Laser cutting apertures with trapezoidal walls and rounded corners may offer better paste release. IPC-7525 may have alternate design recommendations.
9. Board assembly site may have different recommendations for stencil design.

DGK0008A



PACKAGE OUTLINE

VSSOP - 1.1 mm max height

SMALL OUTLINE PACKAGE



4214862/A 04/2023

NOTES:

PowerPAD is a trademark of Texas Instruments.

1. All linear dimensions are in millimeters. Any dimensions in parenthesis are for reference only. Dimensioning and tolerancing per ASME Y14.5M.
2. This drawing is subject to change without notice.
3. This dimension does not include mold flash, protrusions, or gate burrs. Mold flash, protrusions, or gate burrs shall not exceed 0.15 mm per side.
4. This dimension does not include interlead flash. Interlead flash shall not exceed 0.25 mm per side.
5. Reference JEDEC registration MO-187.

EXAMPLE BOARD LAYOUT

DGK0008A

™ VSSOP - 1.1 mm max height

SMALL OUTLINE PACKAGE



LAND PATTERN EXAMPLE
EXPOSED METAL SHOWN
SCALE: 15X



SOLDER MASK DETAILS

4214862/A 04/2023

NOTES: (continued)

6. Publication IPC-7351 may have alternate designs.
7. Solder mask tolerances between and around signal pads can vary based on board fabrication site.
8. Vias are optional depending on application, refer to device data sheet. If any vias are implemented, refer to their locations shown on this view. It is recommended that vias under paste be filled, plugged or tented.
9. Size of metal pad may vary due to creepage requirement.

EXAMPLE STENCIL DESIGN

DGK0008A

TM VSSOP - 1.1 mm max height

SMALL OUTLINE PACKAGE



SOLDER PASTE EXAMPLE
SCALE: 15X

4214862/A 04/2023

NOTES: (continued)

11. Laser cutting apertures with trapezoidal walls and rounded corners may offer better paste release. IPC-7525 may have alternate design recommendations.
12. Board assembly site may have different recommendations for stencil design.

GENERIC PACKAGE VIEW

RUN 10

WQFN - 0.8 mm max height

2 X 2, 0.5 mm pitch

PLASTIC QUAD FLATPACK - NO LEAD

This image is a representation of the package family, actual package may vary.
Refer to the product data sheet for package details.

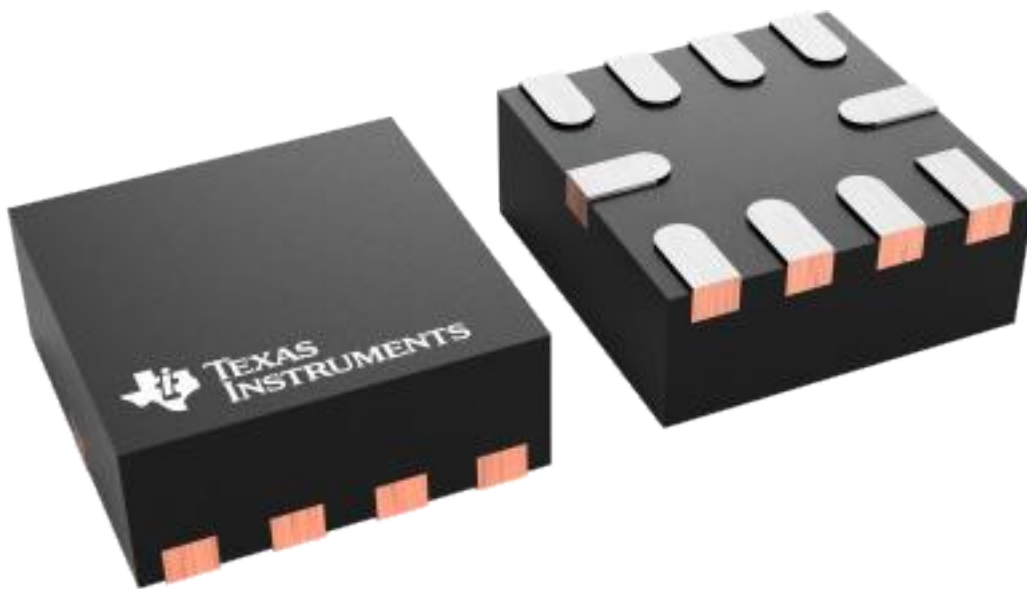

4228249/A

RUN0010B

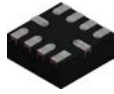

PACKAGE OUTLINE

WQFN - 0.8 mm max height

PLASTIC QUAD FLATPACK - NO LEAD

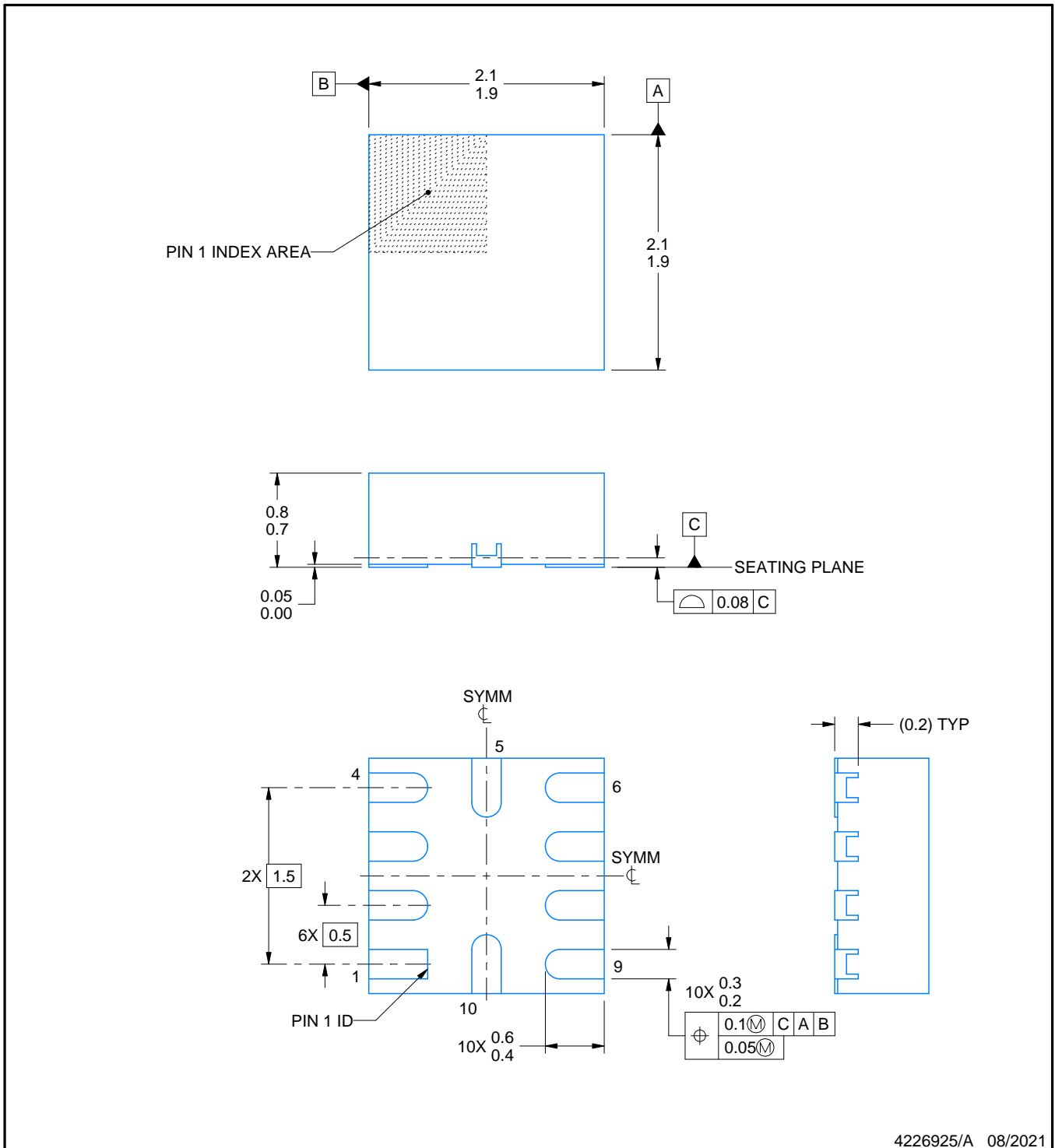

NOTES:

1. All linear dimensions are in millimeters. Any dimensions in parenthesis are for reference only. Dimensioning and tolerancing per ASME Y14.5M.
2. This drawing is subject to change without notice.

EXAMPLE BOARD LAYOUT

RUN0010B

WQFN - 0.8 mm max height

PLASTIC QUAD FLATPACK - NO LEAD

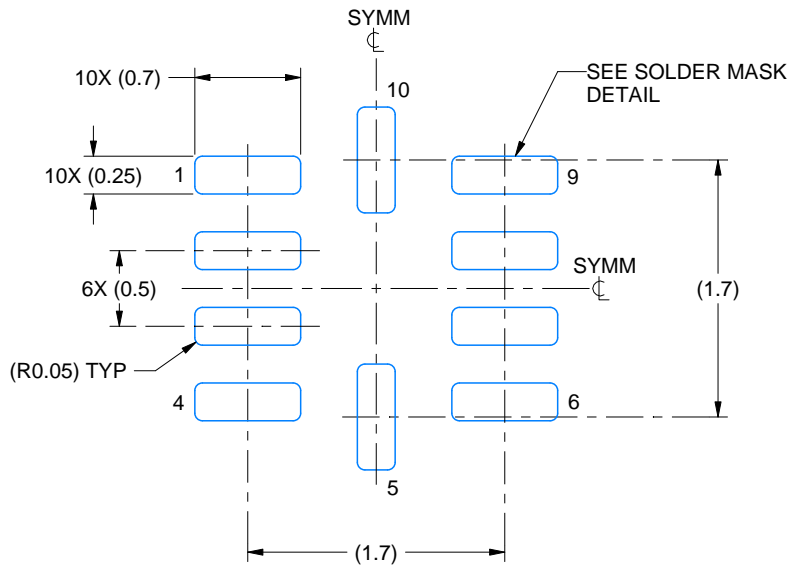

LAND PATTERN EXAMPLE
EXPOSED METAL SHOWN
SCALE: 20X

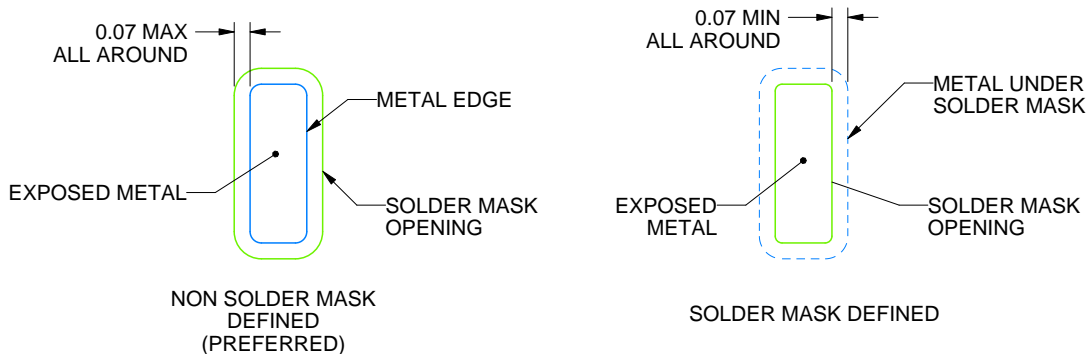

SOLDER MASK DETAILS

4226925/A 08/2021

NOTES: (continued)

- This package is designed to be soldered to a thermal pad on the board. For more information, see Texas Instruments literature number SLUA271 (www.ti.com/lit/slua271).

EXAMPLE STENCIL DESIGN

RUN0010B

WQFN - 0.8 mm max height

PLASTIC QUAD FLATPACK - NO LEAD

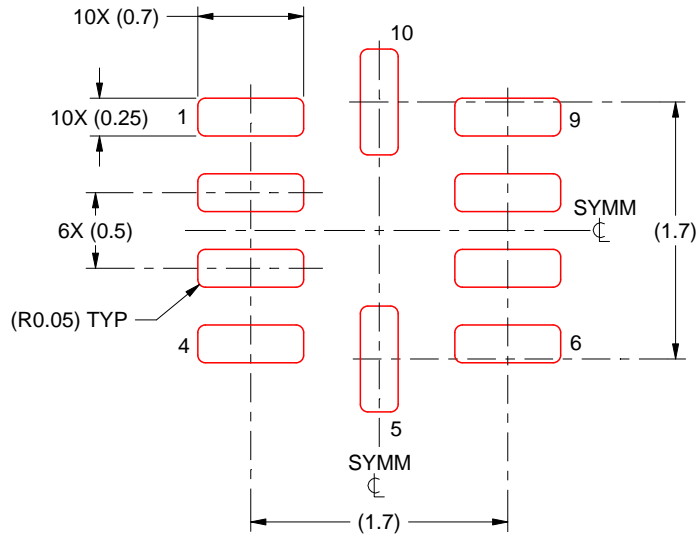

SOLDER PASTE EXAMPLE
BASED ON 0.125 MM THICK STENCIL
SCALE: 20X

4226925/A 08/2021

NOTES: (continued)

4. Laser cutting apertures with trapezoidal walls and rounded corners may offer better paste release. IPC-7525 may have alternate design recommendations.

D0008A



PACKAGE OUTLINE

SOIC - 1.75 mm max height

SMALL OUTLINE INTEGRATED CIRCUIT



4214825/C 02/2019

NOTES:

1. Linear dimensions are in inches [millimeters]. Dimensions in parenthesis are for reference only. Controlling dimensions are in inches. Dimensioning and tolerancing per ASME Y14.5M.
2. This drawing is subject to change without notice.
3. This dimension does not include mold flash, protrusions, or gate burrs. Mold flash, protrusions, or gate burrs shall not exceed $.006$ [0.15] per side.
4. This dimension does not include interlead flash.
5. Reference JEDEC registration MS-012, variation AA.

EXAMPLE BOARD LAYOUT

D0008A

SOIC - 1.75 mm max height

SMALL OUTLINE INTEGRATED CIRCUIT



LAND PATTERN EXAMPLE
 EXPOSED METAL SHOWN
 SCALE:8X



SOLDER MASK DETAILS

4214825/C 02/2019

NOTES: (continued)

- 6. Publication IPC-7351 may have alternate designs.
- 7. Solder mask tolerances between and around signal pads can vary based on board fabrication site.

EXAMPLE STENCIL DESIGN

D0008A

SOIC - 1.75 mm max height

SMALL OUTLINE INTEGRATED CIRCUIT



SOLDER PASTE EXAMPLE
BASED ON .005 INCH [0.125 MM] THICK STENCIL
SCALE:8X

4214825/C 02/2019

NOTES: (continued)

8. Laser cutting apertures with trapezoidal walls and rounded corners may offer better paste release. IPC-7525 may have alternate design recommendations.
9. Board assembly site may have different recommendations for stencil design.

重要なお知らせと免責事項

TI は、技術データと信頼性データ（データシートを含みます）、設計リソース（リファレンス・デザインを含みます）、アプリケーションや設計に関する各種アドバイス、Web ツール、安全性情報、その他のリソースを、欠陥が存在する可能性のある「現状のまま」提供しており、商品性および特定目的に対する適合性の黙示保証、第三者の知的財産権の非侵害保証を含むいかなる保証も、明示的または黙示的にかかわらず拒否します。

これらのリソースは、TI 製品を使用する設計の経験を積んだ開発者への提供を意図したものです。(1) お客様のアプリケーションに適した TI 製品の選定、(2) お客様のアプリケーションの設計、検証、試験、(3) お客様のアプリケーションに該当する各種規格や、その他のあらゆる安全性、セキュリティ、規制、または他の要件への確実な適合に関する責任を、お客様のみが単独で負うものとします。

上記の各種リソースは、予告なく変更される可能性があります。これらのリソースは、リソースで説明されている TI 製品を使用するアプリケーションの開発の目的でのみ、TI はその使用をお客様に許諾します。これらのリソースに関して、他の目的で複製することや掲載することは禁止されています。TI や第三者の知的財産権のライセンスが付与されている訳ではありません。お客様は、これらのリソースを自身で使用した結果発生するあらゆる申し立て、損害、費用、損失、責任について、TI およびその代理人を完全に補償するものとし、TI は一切の責任を拒否します。

TI の製品は、[TI の販売条件](#)、または [ti.com](#) やかかる TI 製品の関連資料などのいずれかを通じて提供する適用可能な条項の下で提供されています。TI がこれらのリソースを提供することは、適用される TI の保証または他の保証の放棄の拡大や変更を意味するものではありません。

お客様がいかなる追加条項または代替条項を提案した場合でも、TI はそれらに異議を唱え、拒否します。

郵送先住所：Texas Instruments, Post Office Box 655303, Dallas, Texas 75265
Copyright © 2024, Texas Instruments Incorporated