

SN74HCS7266-Q1 車載用、シュミット・トリガ入力を搭載したクワッド 2 入力 XNOR ゲート

1 特長

- 車載アプリケーション用に AEC-Q100 認定済み
 - デバイス温度グレード 1: -40°C ~ +125°C、T_A
 - デバイス HBM ESD 分類レベル 2
 - デバイス CDM ESD 分類レベル C6
- 広い動作電圧範囲: 2V ~ 6V
- シュミット・トリガ入力により低速またはノイズの多い入力信号に対応
- 低消費電力
 - I_{CC}: 100nA (標準値)
 - 入力リーク電流: ±100nA (標準値)
- 5V で ±7.8mA の出力駆動能力

2 アプリケーション

- 入力信号の位相差の検出
- 選択可能なインバータ / バッファの作成

3 概要

このデバイスには、4 つの独立した 2 入力 XNOR ゲートと、シュミット・トリガ入力が内蔵されています。各ゲートはブール関数 $Y = A \oplus B$ を正論理で実行します。

製品情報(1)

| 型番 | パッケージ | 本体サイズ(公称) |
|-------------------|------------|---------------|
| SN74HCS7266QDRQ1 | SOIC (14) | 8.70mm×3.90mm |
| SN74HCS7266QPWRQ1 | TSSOP (14) | 5.00mm×4.40mm |

(1) 利用可能なすべてのパッケージについては、このデータシートの末尾にある注文情報を参照してください。

シュミットトリガ入力の利点

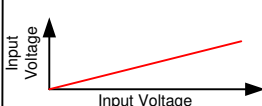
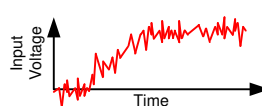
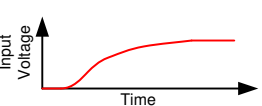
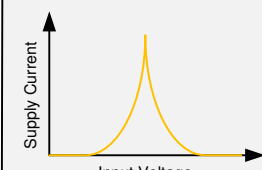
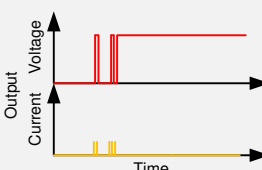
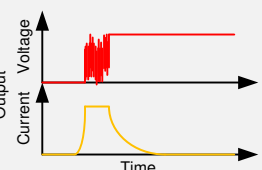
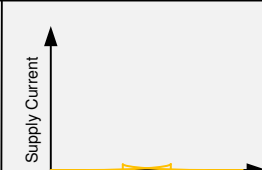
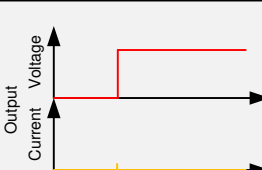
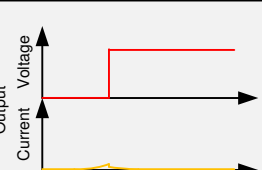
| | Low Power | Noise Rejection | Supports Slow Inputs |
|---|---|--|---|
| Input Voltage Waveforms |  |  |  |
| Standard CMOS Input Response Waveforms |  |  |  |
| Schmitt-trigger CMOS Input Response Waveforms |  |  |  |

目次

| | | | | | |
|----------|--|----------|-----------|---|-----------|
| 1 | 特長 | 1 | 8.3 | Feature Description | 7 |
| 2 | アプリケーション | 1 | 8.4 | Device Functional Modes | 8 |
| 3 | 概要 | 1 | 9 | Application and Implementation | 9 |
| 4 | 改訂履歴 | 2 | 9.1 | Application Information | 9 |
| 5 | Pin Configuration and Functions | 3 | 9.2 | Typical Application | 9 |
| 6 | Specifications | 3 | 10 | Power Supply Recommendations | 12 |
| 6.1 | Absolute Maximum Ratings | 3 | 11 | Layout | 12 |
| 6.2 | ESD Ratings | 4 | 11.1 | Layout Guidelines | 12 |
| 6.3 | Recommended Operating Conditions | 4 | 11.2 | Layout Example | 12 |
| 6.4 | Thermal Information | 4 | 12 | デバイスおよびドキュメントのサポート | 13 |
| 6.5 | Electrical Characteristics | 4 | 12.1 | ドキュメントのサポート | 13 |
| 6.6 | Switching Characteristics | 5 | 12.2 | 関連リンク | 13 |
| 6.7 | Typical Characteristics | 5 | 12.3 | コミュニティ・リソース | 13 |
| 7 | Parameter Measurement Information | 5 | 12.4 | 商標 | 13 |
| 8 | Detailed Description | 7 | 12.5 | 静電気放電に関する注意事項 | 13 |
| 8.1 | Overview | 7 | 12.6 | Glossary | 13 |
| 8.2 | Functional Block Diagram | 7 | 13 | メカニカル、パッケージ、および注文情報 | 13 |

4 改訂履歴

資料番号末尾の英字は改訂を表しています。その改訂履歴は英語版に準じています。

2019年8月発行のものから更新

Page

| | |
|--|----------|
| • 「製品情報」表に D パッケージを追加 | 1 |
| • Added D package column to <i>Thermal Information</i> table | 4 |

5 Pin Configuration and Functions

D or PW Package
14-Pin SOIC or TSSOP
Top View

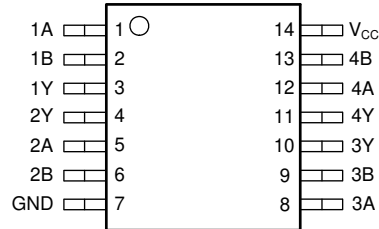

Pin Functions

| PIN | | I/O | DESCRIPTION |
|-----------------|-----|--------|---------------------|
| NAME | NO. | | |
| 1A | 1 | Input | Channel 1, Input A |
| 1B | 2 | Input | Channel 1, Input B |
| 1Y | 3 | Output | Channel 1, Output Y |
| 2Y | 4 | Output | Channel 2, Output Y |
| 2A | 5 | Input | Channel 2, Input A |
| 2B | 6 | Input | Channel 2, Input B |
| GND | 7 | — | Ground |
| 3A | 8 | Input | Channel 3, Input A |
| 3B | 9 | Input | Channel 3, Input B |
| 3Y | 10 | Output | Channel 3, Output Y |
| 4Y | 11 | Output | Channel 4, Output Y |
| 4A | 12 | Input | Channel 4, Input A |
| 4B | 13 | Input | Channel 4, Input B |
| V _{CC} | 14 | — | Positive Supply |

6 Specifications

6.1 Absolute Maximum Ratings

over operating free-air temperature range (unless otherwise noted)⁽¹⁾

| | | | MIN | MAX | UNIT |
|------------------|---|---|------|-----|------|
| V _{CC} | Supply voltage | | -0.5 | 7 | V |
| I _{IK} | Input clamp current ⁽²⁾ | V _I < -0.5 V or V _I > V _{CC} + 0.5 V | | ±20 | mA |
| I _{OK} | Output clamp current ⁽²⁾ | V _I < -0.5 V or V _I > V _{CC} + 0.5 V | | ±20 | mA |
| I _O | Continuous output current | V _O = 0 to V _{CC} | | ±35 | mA |
| | Continuous current through V _{CC} or GND | | | ±70 | mA |
| T _J | Junction temperature ⁽³⁾ | | | 150 | °C |
| T _{stg} | Storage temperature | | -65 | 150 | °C |

(1) Stresses beyond those listed under *Absolute Maximum Rating* may cause permanent damage to the device. These are stress ratings only, which do not imply functional operation of the device at these or any other conditions beyond those indicated under *Recommended Operating Condition*. Exposure to absolute-maximum-rated conditions for extended periods may affect device reliability.

(2) The input and output voltage ratings may be exceeded if the input and output current ratings are observed.

(3) Guaranteed by design.

6.2 ESD Ratings

| | | | VALUE | UNIT |
|--------------------|-------------------------|---|-------|------|
| V _(ESD) | Electrostatic discharge | Human body model (HBM), per AEC Q100-002 ⁽¹⁾ HBM ESD Classification Level 2 | ±4000 | V |
| | | Charged device model (CDM), per AEC Q100-011 CDM ESD Classification Level C6 | ±1500 | |

(1) AEC Q100-002 indicate that HBM stressing shall be in accordance with the ANSI/ESDA/JEDEC JS-001 specification.

6.3 Recommended Operating Conditions

over operating free-air temperature range (unless otherwise noted)

| | | MIN | NOM | MAX | UNIT |
|-----------------|---------------------|-----|-----|-----------------|------|
| V _{CC} | Supply voltage | 2 | 5 | 6 | V |
| V _I | Input voltage | 0 | | V _{CC} | V |
| V _O | Output voltage | 0 | | V _{CC} | V |
| T _A | Ambient temperature | -40 | | 125 | °C |

6.4 Thermal Information

| THERMAL METRIC | SN74HCS7266-Q1 | | UNIT | |
|-----------------------|--|----------|-------|------|
| | PW (TSSOP) | D (SOIC) | | |
| | 14 PINS | 14 PINS | | |
| R _{θJA} | Junction-to-ambient thermal resistance | 151.7 | 133.6 | °C/W |
| R _{θJC(top)} | Junction-to-case (top) thermal resistance | 79.4 | 89.0 | °C/W |
| R _{θJB} | Junction-to-board thermal resistance | 94.7 | 89.5 | °C/W |
| Ψ _{JT} | Junction-to-top characterization parameter | 25.2 | 45.5 | °C/W |
| Ψ _{JB} | Junction-to-board characterization parameter | 94.1 | 89.1 | °C/W |
| R _{θJC(bot)} | Junction-to-case (bottom) thermal resistance | N/A | N/A | °C/W |

6.5 Electrical Characteristics

over operating free-air temperature range; typical values measured at T_A = 25°C (unless otherwise noted).

| PARAMETER | | TEST CONDITIONS | V _{CC} | MIN | TYP | MAX | UNIT | |
|-----------------|---|---|---------------------------|------------|-----------------------|-------------------------|------|------|
| V _{T+} | Positive switching threshold | | 2 V | 0.7 | | 1.5 | V | |
| | | | 4.5 V | 1.7 | | 3.15 | | |
| | | | 6 V | 2.1 | | 4.2 | | |
| V _{T-} | Negative switching threshold | | 2 V | 0.3 | | 1.0 | V | |
| | | | 4.5 V | 0.9 | | 2.2 | | |
| | | | 6 V | 1.2 | | 3.0 | | |
| ΔV _T | Hysteresis (V _{T+} - V _{T-}) | | 2 V | 0.2 | | 1.0 | V | |
| | | | 4.5 V | 0.4 | | 1.4 | | |
| | | | 6 V | 0.6 | | 1.6 | | |
| V _{OH} | High-level output voltage | V _I = V _{IH} or V _{IL} | I _{OH} = -20 μA | 2 V to 6 V | V _{CC} - 0.1 | V _{CC} - 0.002 | V | |
| | | | I _{OH} = -6 mA | 4.5 V | 4.0 | 4.3 | | |
| | | | I _{OH} = -7.8 mA | 6 V | 5.4 | 5.75 | | |
| V _{OL} | Low-level output voltage | V _I = V _{IH} or V _{IL} | I _{OL} = 20 μA | 2 V to 6 V | | 0.002 | V | |
| | | | I _{OL} = 6 mA | 4.5 V | | 0.18 | | 0.30 |
| | | | I _{OL} = 7.8 mA | 6 V | | 0.22 | | 0.33 |
| I _I | Input leakage current | V _I = V _{CC} or 0 | 6 V | | ±100 | ±1000 | nA | |
| I _{CC} | Supply current | V _I = V _{CC} or 0, I _O = 0 | 6 V | | 0.1 | | 2 μA | |
| C _i | Input capacitance | | 2 V to 6 V | | | | 5 pF | |
| C _{pd} | Power dissipation capacitance per gate | No load | 2 V to 6 V | | 10 | | pF | |

6.6 Switching Characteristics

$C_L = 50$ pF; over operating free-air temperature range; typical values measured at $T_A = 25^\circ\text{C}$ (unless otherwise noted). See [Parameter Measurement Information](#).

| PARAMETER | | FROM (INPUT) | TO (OUTPUT) | V_{CC} | MIN | TYP | MAX | UNIT |
|-----------|-------------------|--------------|-------------|----------|-----|-----|-----|------|
| t_{pd} | Propagation delay | A or B | Y | 2 V | | 14 | 40 | ns |
| | | | | 4.5 V | | 6 | 17 | |
| | | | | 6 V | | 5 | 16 | |
| t_t | Transition-time | | Y | 2 V | | 9 | 16 | ns |
| | | | | 4.5 V | | 5 | 9 | |
| | | | | 6 V | | 4 | 8 | |

6.7 Typical Characteristics

$T_A = 25^\circ\text{C}$

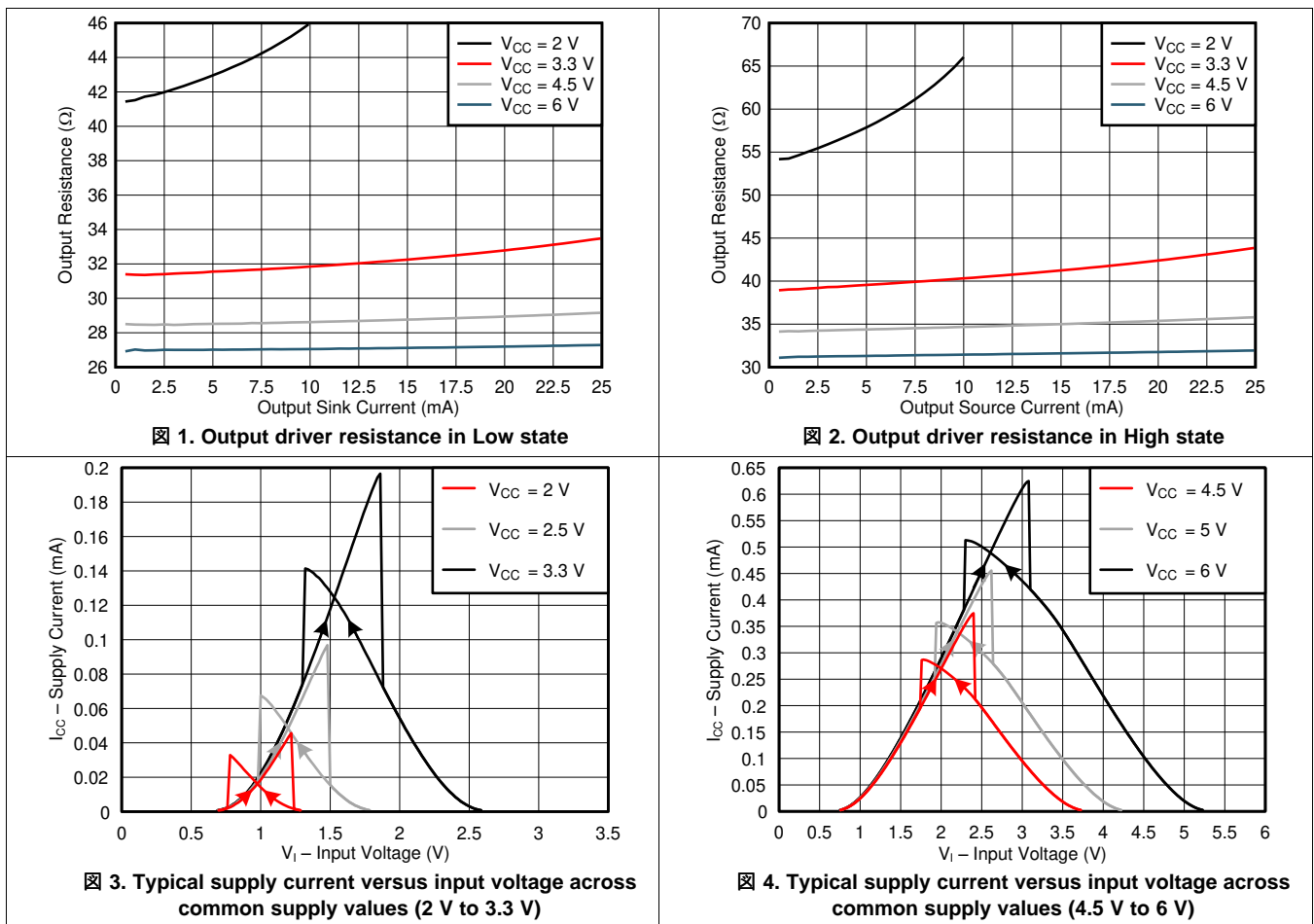

7 Parameter Measurement Information

- Phase relationships between waveforms were chosen arbitrarily. All input pulses are supplied by generators having the following characteristics: $\text{PRR} \leq 1$ MHz, $Z_O = 50 \Omega$, $t_t < 2.5$ ns.
- The outputs are measured one at a time, with one input transition per measurement.

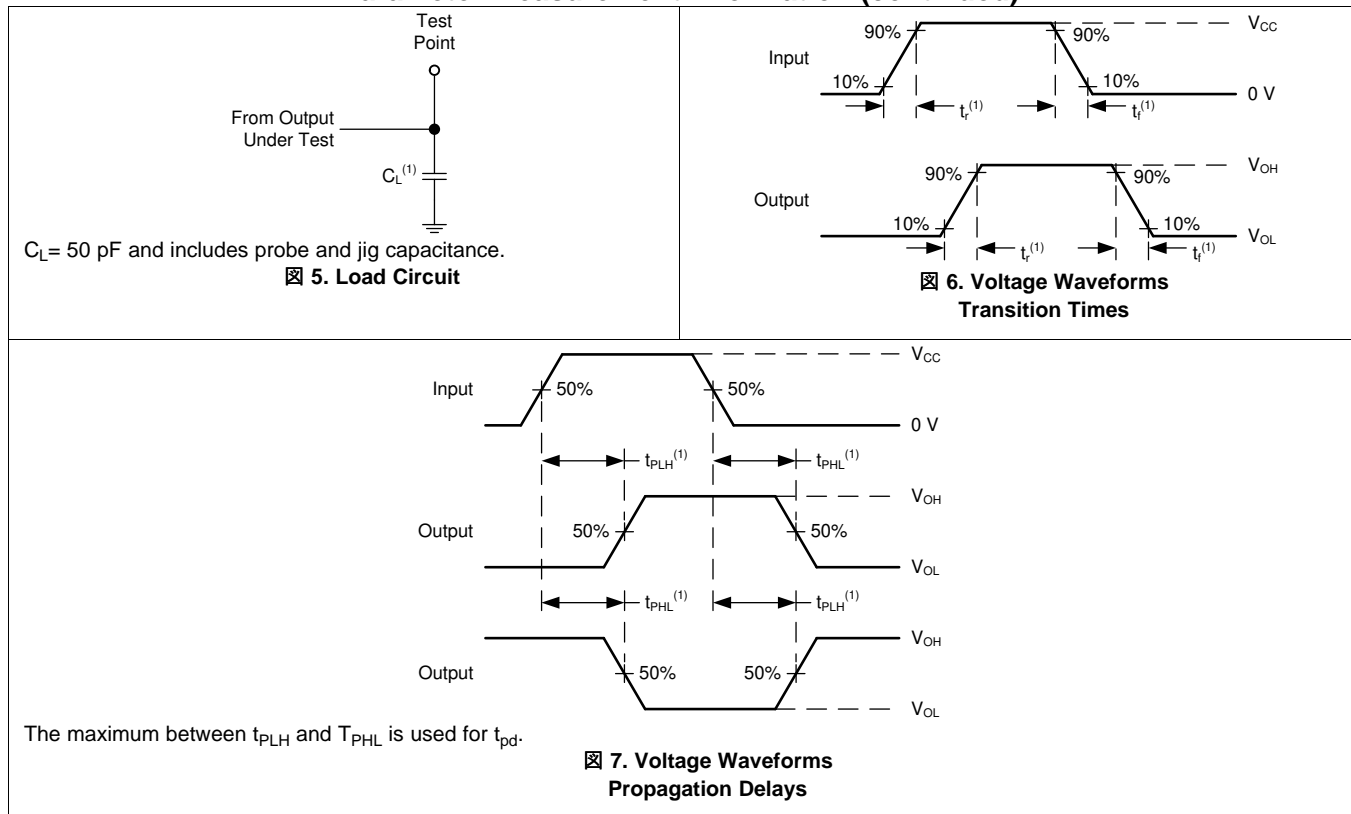
Parameter Measurement Information (continued)

8 Detailed Description

8.1 Overview

This device contains four independent 2-input XNOR Gates with Schmitt-trigger inputs. Each gate performs the Boolean function $Y = A \oplus B$ in positive logic.

8.2 Functional Block Diagram

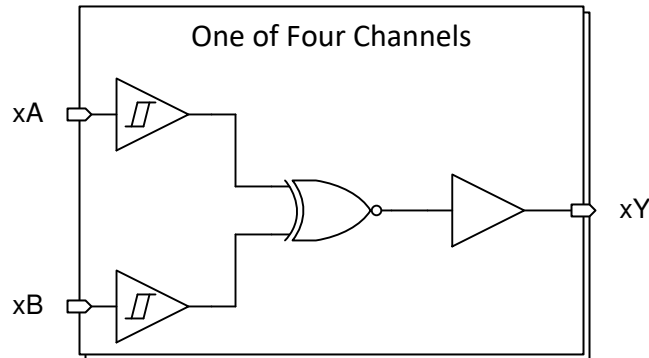

8.3 Feature Description

8.3.1 Balanced CMOS Push-Pull Outputs

A balanced output allows the device to sink and source similar currents. The drive capability of this device may create fast edges into light loads so routing and load conditions should be considered to prevent ringing. Additionally, the outputs of this device are capable of driving larger currents than the device can sustain without being damaged. It is important for the output power of the device to be limited to avoid damage due to over-current. The electrical and thermal limits defined in the [Absolute Maximum Ratings](#) must be followed at all times.

8.3.2 CMOS Schmitt-Trigger Inputs

Standard CMOS inputs are high impedance and are typically modeled as a resistor in parallel with the input capacitance given in the [Electrical Characteristics](#). The worst case resistance is calculated with the maximum input voltage, given in the [Absolute Maximum Ratings](#), and the maximum input leakage current, given in the [Electrical Characteristics](#), using ohm's law ($R = V \div I$).

The Schmitt-trigger input architecture provides hysteresis as defined by ΔV_T in the [Electrical Characteristics](#), which makes this device extremely tolerant to slow or noisy inputs. While the inputs can be driven much slower than standard CMOS inputs, it is still recommended to properly terminate unused inputs. Driving the inputs slowly will also increase dynamic current consumption of the device. For additional information regarding Schmitt-trigger inputs, please see [Understanding Schmitt Triggers](#).

8.3.3 Clamp Diode Structure

The inputs and outputs to this device have both positive and negative clamping diodes as depicted in [Figure 8](#).

注意

Voltages beyond the values specified in the [Absolute Maximum Ratings](#) table can cause damage to the device. The input negative-voltage and output voltage ratings may be exceeded if the input and output clamp-current ratings are observed.

Feature Description (continued)

图 8. Electrical Placement of Clamping Diodes for Each Input and Output
8.4 Device Functional Modes
表 1. Function Table

| INPUTS | | OUTPUT Y |
|--------|---|-------------|
| A | B | |
| L | L | H |
| L | H | L |
| H | L | L |
| H | H | H |

9 Application and Implementation

注

Information in the following applications sections is not part of the TI component specification, and TI does not warrant its accuracy or completeness. TI's customers are responsible for determining suitability of components for their purposes. Customers should validate and test their design implementation to confirm system functionality.

9.1 Application Information

In this application, a 2-input XNOR gate is used as a phase difference detector as shown in [Figure 9](#). The remaining three gates can be used for other applications in the system, or the inputs can be grounded and the channels left unused.

The SN74HCS7266-Q1 is used to identify phase difference between a reference clock and another input clock. Whenever the clock states are different, the XNOR output will pulse LOW until the clocks return to the same state. The output is fed into a low-pass filter to obtain a DC representation of the phase difference.

Typically, clock signals have fast transition rates, but additional filtering can be added to the clock signals which can lead to slower transitions rates. This makes the SN74HCS7266-Q1 ideal for the application because it has Schmitt-trigger inputs that do not have input transition rate requirements.

9.2 Typical Application

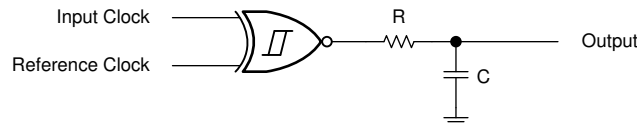

Figure 9. Typical application block diagram

9.2.1 Design Requirements

- All signals in the system operate at 5 V
- The XNOR outputs LOW if any of these conditions apply:
 - Input clock is in a HIGH state while the reference clock is in a LOW state
 - Input clock is in a LOW state while the reference clock is in a HIGH state

9.2.1.1 Power Considerations

Ensure the desired supply voltage is within the range specified in the [Recommended Operating Conditions](#). The supply voltage sets the device's electrical characteristics as described in the [Electrical Characteristics](#).

The supply must be capable of sourcing current equal to the total current to be sourced by all outputs of the SN74HCS7266-Q1 plus the maximum supply current, I_{CC} , listed in the [Electrical Characteristics](#). The logic device can only source or sink as much current as it is provided at the supply and ground pins, respectively. Be sure not to exceed the maximum total current through GND or V_{CC} listed in the [Absolute Maximum Ratings](#).

The SN74HCS7266-Q1 can drive a load with a total capacitance less than or equal to 50 pF connected to a high-impedance CMOS input while still meeting all of the datasheet specifications. Larger capacitive loads can be applied, however it is not recommended to exceed 70 pF.

Total power consumption can be calculated using the information provided in [CMOS Power Consumption and \$C_{pd}\$ Calculation](#).

Thermal increase can be calculated using the information provided in [Thermal Characteristics of Standard Linear and Logic \(SLL\) Packages and Devices](#).

Typical Application (continued)

注意

The maximum junction temperature, $T_J(\text{max})$ listed in the [Absolute Maximum Ratings](#), is an *additional limitation* to prevent damage to the device. Do not violate any values listed in the [Absolute Maximum Ratings](#). These limits are provided to prevent damage to the device.

9.2.1.2 Input Considerations

Input signals must cross $V_{t(\text{min})}$ to be considered a logic LOW, and $V_{t(\text{max})}$ to be considered a logic HIGH. Do not exceed the maximum input voltage range found in the [Absolute Maximum Ratings](#).

Unused inputs must be terminated to either V_{CC} or ground. These can be directly terminated if the input is completely unused, or they can be connected with a pull-up or pull-down resistor if the input is to be used sometimes, but not always. A pull-up resistor is used for a default state of HIGH, and a pull-down resistor is used for a default state of LOW. The resistor size is limited by drive current of the controller, leakage current into the SN74HCS7266-Q1, as specified in the [Electrical Characteristics](#), and the desired input transition rate. A 10-k Ω resistor value is often used due to these factors.

The SN74HCS7266-Q1 has no input signal transition rate requirements because it has Schmitt-trigger inputs.

Another benefit to having Schmitt-trigger inputs is the ability to reject noise. Noise with a large enough amplitude can still cause issues. To know how much noise is too much, please refer to the $\Delta V_T(\text{min})$ in the [Electrical Characteristics](#). This hysteresis value will provide the peak-to-peak limit.

Unlike what happens with standard CMOS inputs, Schmitt-trigger inputs can be held at any valid value without causing huge increases in power consumption. The typical additional current caused by holding an input at a value other than V_{CC} or ground is plotted in the [Typical Characteristics](#).

Refer to the [Feature Description](#) for additional information regarding the inputs for this device.

9.2.1.3 Output Considerations

The positive supply voltage is used to produce the output HIGH voltage. Drawing current from the output will decrease the output voltage as specified by the V_{OH} specification in the [Electrical Characteristics](#). Similarly, the ground voltage is used to produce the output LOW voltage. Sinking current into the output will increase the output voltage as specified by the V_{OL} specification in the [Electrical Characteristics](#). The plots in and provide a typical relationship between output voltage and current for this device.

Unused outputs can be left floating.

Refer to [Feature Description](#) for additional information regarding the outputs for this device.

9.2.2 Detailed Design Procedure

1. Add a decoupling capacitor from V_{CC} to GND. The capacitor needs to be placed physically close to the device and electrically close to both the V_{CC} and GND pins. An example layout is shown in the [Layout](#).
2. Ensure the capacitive load at the output is ≤ 70 pF. This is not a hard limit, however it will ensure optimal performance. This can be accomplished by providing short, appropriately sized traces from the SN74HCS7266-Q1 to the receiving device.
3. Ensure the resistive load at the output is larger than $(V_{CC} / 25 \text{ mA}) \Omega$. This will ensure that the maximum output current from the [Absolute Maximum Ratings](#) is not violated. Most CMOS inputs have a resistive load measured in megaohms; much larger than the minimum calculated above.
4. Thermal issues are rarely a concern for logic gates, however the power consumption and thermal increase can be calculated using the steps provided in the application report, [CMOS Power Consumption and Cpd Calculation](#)

Typical Application (continued)

9.2.3 Application Curves

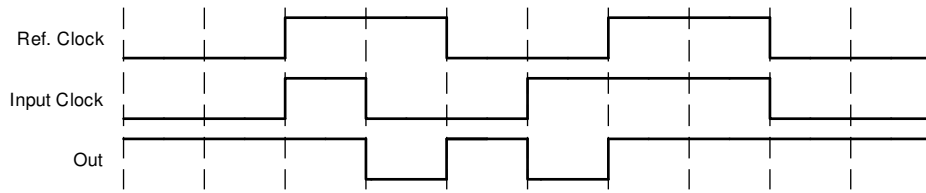

⊠ 10. Application timing diagram

10 Power Supply Recommendations

The power supply can be any voltage between the minimum and maximum supply voltage rating located in the [Recommended Operating Conditions](#). Each V_{CC} terminal should have a good bypass capacitor to prevent power disturbance. A 0.1- μF capacitor is recommended for this device. It is acceptable to parallel multiple bypass caps to reject different frequencies of noise. The 0.1- μF and 1- μF capacitors are commonly used in parallel. The bypass capacitor should be installed as close to the power terminal as possible for best results, as shown in [Figure 11](#).

11 Layout

11.1 Layout Guidelines

When using multiple-input and multiple-channel logic devices inputs must not ever be left floating. In many cases, functions or parts of functions of digital logic devices are unused; for example, when only two inputs of a triple-input AND gate are used or only 3 of the 4 buffer gates are used. Such unused input pins must not be left unconnected because the undefined voltages at the outside connections result in undefined operational states. All unused inputs of digital logic devices must be connected to a logic high or logic low voltage, as defined by the input voltage specifications, to prevent them from floating. The logic level that must be applied to any particular unused input depends on the function of the device. Generally, the inputs are tied to GND or V_{CC} , whichever makes more sense for the logic function or is more convenient.

11.2 Layout Example

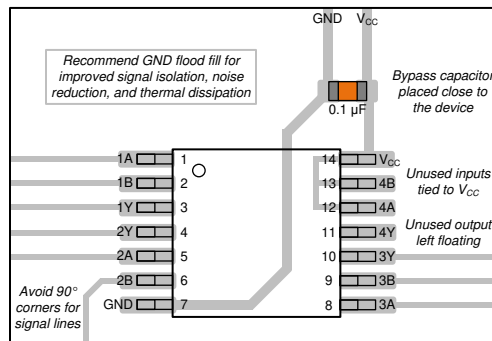

Figure 11. Example layout for the SN74HCS7266-Q1

12 デバイスおよびドキュメントのサポート

12.1 ドキュメントのサポート

12.1.1 関連資料

関連資料については、以下を参照してください。

- 『[HCMOS Design Considerations](#)』(英語)
- 『[CMOS Power Consumption and Cpd Calculation](#)』(英語)
- 『[Designing With Logic](#)』(英語)

12.2 関連リンク

次の表に、クイック・アクセス・リンクを示します。カテゴリには、技術資料、サポートおよびコミュニティ・リソース、ツールとソフトウェア、およびサンプル注文またはご購入へのクイック・アクセスが含まれます。

12.3 コミュニティ・リソース

TI E2E™ [support forums](#) are an engineer's go-to source for fast, verified answers and design help — straight from the experts. Search existing answers or ask your own question to get the quick design help you need.

Linked content is provided "AS IS" by the respective contributors. They do not constitute TI specifications and do not necessarily reflect TI's views; see TI's [Terms of Use](#).

12.4 商標

E2E is a trademark of Texas Instruments.

All other trademarks are the property of their respective owners.

12.5 静電気放電に関する注意事項



これらのデバイスは、限定的なESD(静電破壊)保護機能を内蔵しています。保存時または取り扱い時は、MOSゲートに対する静電破壊を防止するために、リード線同士をショートさせておくか、デバイスを導電フォームに入れる必要があります。

12.6 Glossary

[SLYZ022](#) — *TI Glossary*.

This glossary lists and explains terms, acronyms, and definitions.

13 メカニカル、パッケージ、および注文情報

以降のページには、メカニカル、パッケージ、および注文に関する情報が記載されています。この情報は、そのデバイスについて利用可能な最新のデータです。このデータは予告なく変更されることがあり、ドキュメントが改訂される場合もあります。本データシートのブラウザ版を使用されている場合は、画面左側の説明をご覧ください。

PACKAGING INFORMATION

| Orderable Device | Status (1) | Package Type | Package Drawing | Pins | Package Qty | Eco Plan (2) | Lead finish/ Ball material (6) | MSL Peak Temp (3) | Op Temp (°C) | Device Marking (4/5) | Samples |
|-------------------|---------------|--------------|-----------------|------|-------------|-----------------|--------------------------------------|----------------------|--------------|-------------------------|-------------------------|
| SN74HCS7266QDRQ1 | ACTIVE | SOIC | D | 14 | 2500 | RoHS & Green | NIPDAU | Level-1-260C-UNLIM | -40 to 125 | HCS7266Q | Samples |
| SN74HCS7266QPWRQ1 | ACTIVE | TSSOP | PW | 14 | 2000 | RoHS & Green | NIPDAU | Level-1-260C-UNLIM | -40 to 125 | HC7266Q | Samples |

(1) The marketing status values are defined as follows:

ACTIVE: Product device recommended for new designs.

LIFEBUY: TI has announced that the device will be discontinued, and a lifetime-buy period is in effect.

NRND: Not recommended for new designs. Device is in production to support existing customers, but TI does not recommend using this part in a new design.

PREVIEW: Device has been announced but is not in production. Samples may or may not be available.

OBSOLETE: TI has discontinued the production of the device.

(2) **RoHS:** TI defines "RoHS" to mean semiconductor products that are compliant with the current EU RoHS requirements for all 10 RoHS substances, including the requirement that RoHS substance do not exceed 0.1% by weight in homogeneous materials. Where designed to be soldered at high temperatures, "RoHS" products are suitable for use in specified lead-free processes. TI may reference these types of products as "Pb-Free".

RoHS Exempt: TI defines "RoHS Exempt" to mean products that contain lead but are compliant with EU RoHS pursuant to a specific EU RoHS exemption.

Green: TI defines "Green" to mean the content of Chlorine (Cl) and Bromine (Br) based flame retardants meet JS709B low halogen requirements of <=1000ppm threshold. Antimony trioxide based flame retardants must also meet the <=1000ppm threshold requirement.

(3) MSL, Peak Temp. - The Moisture Sensitivity Level rating according to the JEDEC industry standard classifications, and peak solder temperature.

(4) There may be additional marking, which relates to the logo, the lot trace code information, or the environmental category on the device.

(5) Multiple Device Markings will be inside parentheses. Only one Device Marking contained in parentheses and separated by a "~" will appear on a device. If a line is indented then it is a continuation of the previous line and the two combined represent the entire Device Marking for that device.

(6) Lead finish/Ball material - Orderable Devices may have multiple material finish options. Finish options are separated by a vertical ruled line. Lead finish/Ball material values may wrap to two lines if the finish value exceeds the maximum column width.

Important Information and Disclaimer:The information provided on this page represents TI's knowledge and belief as of the date that it is provided. TI bases its knowledge and belief on information provided by third parties, and makes no representation or warranty as to the accuracy of such information. Efforts are underway to better integrate information from third parties. TI has taken and continues to take reasonable steps to provide representative and accurate information but may not have conducted destructive testing or chemical analysis on incoming materials and chemicals. TI and TI suppliers consider certain information to be proprietary, and thus CAS numbers and other limited information may not be available for release.

In no event shall TI's liability arising out of such information exceed the total purchase price of the TI part(s) at issue in this document sold by TI to Customer on an annual basis.



NOTES:

1. All linear dimensions are in millimeters. Any dimensions in parenthesis are for reference only. Dimensioning and tolerancing per ASME Y14.5M.
2. This drawing is subject to change without notice.
3. This dimension does not include mold flash, protrusions, or gate burrs. Mold flash, protrusions, or gate burrs shall not exceed 0.15 mm per side.
4. This dimension does not include interlead flash. Interlead flash shall not exceed 0.25 mm per side.
5. Reference JEDEC registration MO-153.

EXAMPLE BOARD LAYOUT

PW0014A

TSSOP - 1.2 mm max height

SMALL OUTLINE PACKAGE



LAND PATTERN EXAMPLE
EXPOSED METAL SHOWN
SCALE: 10X



4220202/B 12/2023

NOTES: (continued)

- 6. Publication IPC-7351 may have alternate designs.
- 7. Solder mask tolerances between and around signal pads can vary based on board fabrication site.

EXAMPLE STENCIL DESIGN

PW0014A

TSSOP - 1.2 mm max height

SMALL OUTLINE PACKAGE



SOLDER PASTE EXAMPLE
BASED ON 0.125 mm THICK STENCIL
SCALE: 10X

4220202/B 12/2023

NOTES: (continued)

8. Laser cutting apertures with trapezoidal walls and rounded corners may offer better paste release. IPC-7525 may have alternate design recommendations.
9. Board assembly site may have different recommendations for stencil design.



D0014A

PACKAGE OUTLINE

SOIC - 1.75 mm max height

SMALL OUTLINE INTEGRATED CIRCUIT



4220718/A 09/2016

NOTES:

1. All linear dimensions are in millimeters. Dimensions in parenthesis are for reference only. Dimensioning and tolerancing per ASME Y14.5M.
2. This drawing is subject to change without notice.
3. This dimension does not include mold flash, protrusions, or gate burrs. Mold flash, protrusions, or gate burrs shall not exceed 0.15 mm, per side.
4. This dimension does not include interlead flash. Interlead flash shall not exceed 0.43 mm, per side.
5. Reference JEDEC registration MS-012, variation AB.

EXAMPLE BOARD LAYOUT

D0014A

SOIC - 1.75 mm max height

SMALL OUTLINE INTEGRATED CIRCUIT



LAND PATTERN EXAMPLE
SCALE:8X



SOLDER MASK DETAILS

4220718/A 09/2016

NOTES: (continued)

6. Publication IPC-7351 may have alternate designs.

7. Solder mask tolerances between and around signal pads can vary based on board fabrication site.

EXAMPLE STENCIL DESIGN

D0014A

SOIC - 1.75 mm max height

SMALL OUTLINE INTEGRATED CIRCUIT



SOLDER PASTE EXAMPLE
BASED ON 0.125 mm THICK STENCIL
SCALE:8X

4220718/A 09/2016

NOTES: (continued)

8. Laser cutting apertures with trapezoidal walls and rounded corners may offer better paste release. IPC-7525 may have alternate design recommendations.
9. Board assembly site may have different recommendations for stencil design.

重要なお知らせと免責事項

TI は、技術データと信頼性データ（データシートを含みます）、設計リソース（リファレンス・デザインを含みます）、アプリケーションや設計に関する各種アドバイス、Web ツール、安全性情報、その他のリソースを、欠陥が存在する可能性のある「現状のまま」提供しており、商品性および特定目的に対する適合性の黙示保証、第三者の知的財産権の非侵害保証を含むいかなる保証も、明示的または黙示的にかかわらず拒否します。

これらのリソースは、TI 製品を使用する設計の経験を積んだ開発者への提供を意図したものです。(1) お客様のアプリケーションに適した TI 製品の選定、(2) お客様のアプリケーションの設計、検証、試験、(3) お客様のアプリケーションに該当する各種規格や、その他のあらゆる安全性、セキュリティ、規制、または他の要件への確実な適合に関する責任を、お客様のみが単独で負うものとします。

上記の各種リソースは、予告なく変更される可能性があります。これらのリソースは、リソースで説明されている TI 製品を使用するアプリケーションの開発の目的でのみ、TI はその使用をお客様に許諾します。これらのリソースに関して、他の目的で複製することや掲載することは禁止されています。TI や第三者の知的財産権のライセンスが付与されている訳ではありません。お客様は、これらのリソースを自身で使用した結果発生するあらゆる申し立て、損害、費用、損失、責任について、TI およびその代理人を完全に補償するものとし、TI は一切の責任を拒否します。

TI の製品は、[TI の販売条件](#)、または [ti.com](#) やかかる TI 製品の関連資料などのいずれかを通じて提供する適用可能な条項の下で提供されています。TI がこれらのリソースを提供することは、適用される TI の保証または他の保証の放棄の拡大や変更を意味するものではありません。

お客様がいかなる追加条項または代替条項を提案した場合でも、TI はそれらに異議を唱え、拒否します。

郵送先住所：Texas Instruments, Post Office Box 655303, Dallas, Texas 75265
Copyright © 2024, Texas Instruments Incorporated