

TAA5212 118dB のダイナミックレンジ、低消費電力、高性能 ステレオ オーディオ ADC

1 特長

- ADC チャンネル
 - ステレオ高性能 ADC
 - 性能:
 - ライン差動入力のダイナミックレンジ: 118dB
 - マイクフォン差動入力のダイナミックレンジ: 118dB
 - THD+N: -95dB
 - チャンネル加算モードで高 SNR をサポート
 - 入力電圧:
 - 差動、2V_{RMS} フルスケール入力
 - シングルエンド、1V_{RMS} フルスケール入力
 - 入力ミックス / マルチプレクサ オプション
 - サンプルレート (f_S) = 8kHz ~ 768kHz
 - プログラム可能なマイクフォン バイアス (最大 3V)
- 共通機能
 - 最大 4 つのレコード チャンネル
 - 2 チャンネル アナログ + 2 チャンネル デジタル
 - 1 チャンネル アナログ + 3 チャンネル デジタル
 - 4 チャンネル デジタル
 - 音声アクティビティ検出
 - 低レイテンシフィルタ選択
 - プログラム可能で HPF およびバイクワッド フィルタ
 - I²C & SPI 制御インターフェイス
 - オーディオ シリアル インターフェイス
 - フォーマット: TDM、I²S、または左揃え
 - ワード長: 16、20、24 または 32 ビット
 - プログラム可能な PLL による柔軟なクロック供給
 - 低消費電力モード
 - レコードの未定 mW
 - 単電源動作 1.8V または 3.3V
 - I/O 電源動作: 1.2V、1.8V、または 3.3V
 - 温度グレード 1: -40°C ≤ T_A ≤ +125°C

2 アプリケーション

- 陸上モバイル無線
- IP ネットワーク カメラ
- IP 電話
- テレビ会議システム
- 業務用オーディオ ミキサ / 制御卓

3 概要

TAA5212 は、2V_{RMS} 差動入力、118dB ADC を備えた高性能 ステレオ ADC です。TAA5212 は、差動入力とシングルエンド入力の両方をサポートしています。このデバイスは、マイクフォンとライン入力の両方の入力を、ADC チャンネルで AC および DC 結合オプションによりサポートしています。TAA5212 は、プログラム可能なチャンネル ゲイン、デジタル音量制御、低ジッタの位相ロック ループ (PLL)、プログラム可能なハイパス フィルタ (HPF)、プログラム可能な EQ およびバイクワッド フィルタ、低レイテンシのフィルタ モード、を内蔵しており、最高 768kHz のサンプル レートに対応できます。TAA5212 は時分割多重化 (TDM)、I²S、または左揃え (LJ) オーディオ フォーマットに対応しており、I²C または SPI で制御できます。これらの高性能な機能を搭載し、単一電源で動作するので、TAA5212 はスペースの制約が厳しいオーディオ アプリケーションに最適です。

製品情報

部品番号	パッケージ ⁽¹⁾	本体サイズ (公称)
TAA5212	WQFN (28)	4mm × 4mm、0.5mm ピッチ

- (1) 利用可能なパッケージについては、このデータシートの末尾にある注文情報を参照してください。

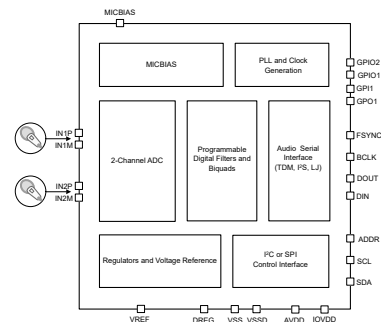

概略ブロック図



Table of Contents

1 特長	1	8 Detailed Description	15
2 アプリケーション	1	8.1 Overview.....	15
3 概要	1	8.2 Functional Block Diagram.....	15
4 Revision History	2	8.3 Feature Description.....	16
5 Pin Configuration and Functions	3	8.4 Device Functional Modes.....	41
6 Specifications	5	8.5 Register Maps.....	41
6.1 Absolute Maximum Ratings.....	5	8.6 Feature Description.....	115
6.2 ESD Ratings.....	5	8.7 Device Functional Modes.....	115
6.3 Recommended Operating Conditions.....	5	9 Application and Implementation	116
6.4 Thermal Information.....	6	9.1 Application Information.....	116
6.5 Electrical Characteristics.....	6	9.2 Typical Application.....	116
6.6 Timing Requirements: I ² C Interface.....	11	10 Power Supply Recommendations	119
6.7 Switching Characteristics: I ² C Interface.....	12	11 Layout	120
6.8 Timing Requirements: SPI Interface.....	12	11.1 Layout Guidelines.....	120
6.9 Switching Characteristics: SPI Interface.....	12	11.2 Layout Example.....	120
6.10 Timing Requirements: TDM, I ² S or LJ Interface.....	12	12 Device and Documentation Support	121
6.11 Switching Characteristics: TDM, I ² S or LJ Interface.....	13	12.1 Documentation Support.....	121
6.12 Timing Requirements: PDM Digital Microphone Interface.....	13	12.2 ドキュメントの更新通知を受け取る方法.....	121
6.13 Switching Characteristics: PDM Digital Microphone Interface.....	13	12.3 サポート・リソース.....	121
7 Parameter Measurement Information	14	12.4 Trademarks.....	121
		12.5 静電気放電に関する注意事項.....	121
		12.6 用語集.....	121

4 Revision History

資料番号末尾の英字は改訂を表しています。その改訂履歴は英語版に準じています。

DATE	REVISION	NOTES
January 2022	*	Initial Release

5 Pin Configuration and Functions



図 5-1. 28-Pin QFN With Exposed Thermal Pad, Top View

表 5-1. Pin Functions

PIN		TYPE ⁽¹⁾	DESCRIPTION
NAME	NO.		
DREG	1	Digital Supply	Digital on-chip regulator output voltage for digital supply (1.5 V, nominal)
BCLK	2	Digital I/O	Audio serial data interface bus bit clock
FSYNC	3	Digital I/O	Audio serial data interface bus frame synchronization signal
DOUT	4	Digital I/O	Audio serial data interface bus output
DIN	5	Digital Input	Audio serial data interface bus input
IOVDD	6	Digital Supply	Digital I/O power supply (1.8 V or 3.3 V, nominal)
VSS	A2	Ground	Ground Pin. Short directly to board Ground Plane.
SCL	7	Digital Input	Clock for I ² C Control Interface
SDA	8	Digital Input	Data for I ² C Control Interface
GPIO1	9	Digital I/O	General-purpose digital input/output 0 (multipurpose functions such as daisy-chain input, audio data output, PLL input clock source, interrupt, and so forth)
GPIO2	10	Digital I/O	General-purpose digital input/output 1 (multipurpose functions such as daisy-chain input, audio data output, PLL input clock source, interrupt, and so forth)
GPO1	11	Digital Output	General-purpose digital output 1 (multipurpose functions such as audio data output, interrupt, and so forth)
GPI1	12	Digital Input	General-purpose digital input 1 (multipurpose functions such as daisy-chain input, PLL input clock source, and so forth)

表 5-1. Pin Functions (続き)

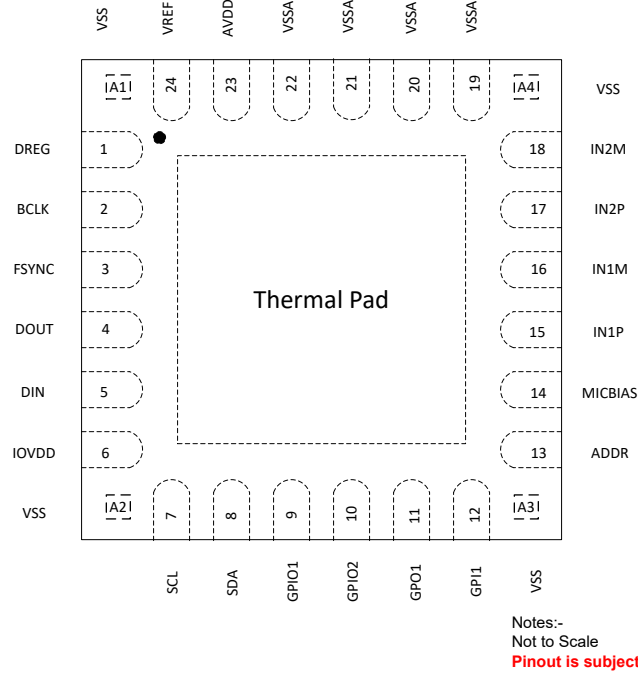
PIN		TYPE ⁽¹⁾	DESCRIPTION
NAME	NO.		
VSS	A3	Ground	Ground Pin. Short directly to board Ground Plane.
ADDR	13	Analog Input	I2C Address
MICBIAS	14	Analog	MICBIAS Output (Programmable output upto 3V)
IN1P	15	Analog Input	Analog Input 1P Pin
IN1M	16	Analog Input	Analog Input 1M Pin
IN2P	17	Analog Input	Analog Input 2P Pin
IN2M	18	Analog Input	Analog Input 2M Pin
VSS	A4	Ground	Ground Pin. Short directly to board Ground Plane.
VSSA	19	Ground	Ground Pin. Short directly to board Ground Plane.
VSSA	20	Ground	Ground Pin. Short directly to board Ground Plane.
VSSA	21	Ground	Ground Pin. Short directly to board Ground Plane.
VSSA	22	Ground	Ground Pin. Short directly to board Ground Plane.
AVDD	23	Analog Supply	Analog power (3.3 V, nominal)
VREF	24	Analog	Analog reference voltage filter output
VSS	A1	Ground	Ground Pin. Short directly to board Ground Plane.

(1) I = Input, O = Output, I/O = Input or Output, G = Ground, P = Power.

6 Specifications

6.1 Absolute Maximum Ratings

over the operating ambient temperature range (unless otherwise noted)⁽¹⁾

		MIN	MAX	UNIT
Supply voltage	AVDD to AVSS	-0.3	3.9	V
Supply voltage	IOVDD to VSS (thermal pad)	-0.3	3.9	V
Ground voltage differences	AVSS to VSS (thermal pad)	-0.3	0.3	V
Analog input voltage	Analog input pins voltage to AVSS	-0.3	5.656	V
Digital input voltage	Digital input pins voltage to VSS (thermal pad)	-0.3	IOVDD + 0.3	V
Temperature	Functional ambient, T _A	-55	125	°C
	Operating ambient, T _A	-40	125	
	Junction, T _J	-40	150	
	Storage, T _{stg}	-65	150	

- (1) Stresses beyond those listed under *Absolute Maximum Ratings* may cause permanent damage to the device. These are stress ratings only, which do not imply functional operation of the device at these or any other conditions beyond those indicated under *Recommended Operating Conditions*. Exposure to absolute-maximum-rated conditions for extended periods may affect device reliability.

6.2 ESD Ratings

			VALUE	UNIT
V _(ESD)	Electrostatic discharge	Human-body model (HBM), per AEC Q100-002 ⁽¹⁾	±2000	V
V _(ESD)	Electrostatic discharge	Charged-device model (CDM), per AEC Q100-011	±500	

- (1) AEC Q100-002 indicates that HBM stressing shall be in accordance with the ANSI/ESDA/JEDEC JS-001 specification.

6.3 Recommended Operating Conditions

		MIN	NOM	MAX	UNIT
POWER					
AVDD ⁽¹⁾	Analog supply voltage to AVSS AVDD-3.3V Operation	3.0	3.3	3.6	V
AVDD ⁽¹⁾	Analog supply voltage to AVSS - AVDD 1.8V operation	1.65	1.8	1.95	V
IOVDD	IO supply voltage to VSS (thermal pad) - IOVDD 3.3-V operation	3.0	3.3	3.6	V
	IO supply voltage to VSS (thermal pad) - IOVDD 1.8-V operation	1.65	1.8	1.95	
IOVDD	IO supply voltage to VSS (thermal pad) - IOVDD 1.2-V operation	1.08	1.2	1.32	V
INPUTS					
INxx	Analog input pins voltage to AVSS for line-in recording	0		5.6	V
INxx	Analog input pins voltage to AVSS for microphone recording	0.1	MICBIAS - 0.1		V
	Digital input pins voltage to VSS (thermal pad)	0		IOVDD	V
ADDR	ADDR pin w.r.t AVSS	0		AVDD	V
TEMPERATURE					
T _A	Operating ambient temperature	-40		125	°C

		MIN	NOM	MAX	UNIT
OTHERS					
	GPIOx or GPIx (used as MCLK input) clock frequency			36.864 ⁽²⁾	MHz
C _b	SCL and SDA bus capacitance for I ² C interface supports standard-mode and fast-mode			400	pF
	SCL and SDA bus capacitance for I ² C interface supports fast-mode plus			550	
C _L	Digital output load capacitance		20	50	pF

- (1) AVSS and VSS (thermal pad); all ground pins must be tied together and must not differ in voltage by more than 0.2 V.
(2) MCLK input rise time (V_{IL} to V_{IH}) and fall time (V_{IH} to V_{IL}) must be less than 5 ns. For better audio noise performance, MCLK input must be used with low jitter.

6.4 Thermal Information

THERMAL METRIC ⁽¹⁾		TAA5212		UNIT
		RGE (WQFN)		
		28 PINS		
R _{θJA}	Junction-to-ambient thermal resistance	38.4		°C/W
R _{θJC(top)}	Junction-to-case (top) thermal resistance	26.3		°C/W
R _{θJB}	Junction-to-board thermal resistance	15.9		°C/W
ψ _{JT}	Junction-to-top characterization parameter	0.5		°C/W
ψ _{JB}	Junction-to-board characterization parameter	15.8		°C/W
R _{θJC(bot)}	Junction-to-case (bottom) thermal resistance	13.8		°C/W

- (1) For more information about traditional and new thermal metrics, see the [spra953](#) application report.

6.5 Electrical Characteristics

at T_A = 25°C, AVDD = 3.3 V, IOVDD = 3.3 V, f_{IN} = 1-kHz sinusoidal signal, f_S = 48 kHz, 32-bit audio data, BCLK = 256 × f_S, TDM target mode and PLL on (unless otherwise noted)

PARAMETER	TEST CONDITIONS		MIN	NOM	MAX	UNIT
ADC PERFORMANCE FOR INPUT RECORDING						
	Differential input full-scale AC signal voltage	AC-coupled input		2		V _{RMS}
	Differential input full-scale AC signal voltage	DC-coupled input		4		V _{RMS}
	Single-ended input full-scale AC signal voltage	AC-coupled input		1		V _{RMS}
	Single-ended input full-scale AC signal voltage	DC-coupled input		2		V _{RMS}
SNR	Signal-to-noise ratio, A-weighted ^{(1) (2)}	IN1 differential AC-coupled input selected and AC signal shorted to ground, 0-dB channel gain		118		dB
SNR	Signal-to-noise ratio, A-weighted ^{(1) (2)}	IN1 differential AC-coupled input selected and AC signal shorted to ground, 12-dB channel gain		103		dB
SNR	Signal-to-noise ratio, A-weighted ^{(1) (2)}	IN1 differential DC-coupled input selected and AC signal shorted to ground, 0-dB channel gain, Device in High Common Mode Tolerance Mode (ADC_CH1_CM_TOL and ADC_CH2_CM_TOL=2'b10)		110		dB
SNR	Signal-to-noise ratio, A-weighted ^{(1) (2)}	IN1 differential DC-coupled input selected and AC signal shorted to ground, 12-dB channel gain, Device in High Common Mode Tolerance Mode (ADC_CH1_CM_TOL and ADC_CH2_CM_TOL=2'b10)		98		dB

at $T_A = 25^\circ\text{C}$, $AVDD = 3.3\text{ V}$, $IOVDD = 3.3\text{ V}$, $f_{IN} = 1\text{-kHz}$ sinusoidal signal, $f_S = 48\text{ kHz}$, 32-bit audio data, $BCLK = 256 \times f_S$, TDM target mode and PLL on (unless otherwise noted)

PARAMETER		TEST CONDITIONS	MIN	NOM	MAX	UNIT
SNR	Signal-to-noise ratio, A-weighted ^{(1) (2)}	Wideband Mode: IN1 differential DC-coupled input selected and AC signal shorted to ground, 0-dB channel gain (Integrated till 20KHz A-Weighted)				dB
SNR	Signal-to-noise ratio ^{(1) (2)}	Wideband Mode: IN1 differential DC-coupled input selected and AC signal shorted to ground, 0-dB channel gain (Integrated till 100KHz)		91		dB
SNR	Signal-to-noise ratio, A-weighted ^{(1) (2)}	Power Tune Mode: IN1 differential AC-coupled input selected and AC signal shorted to ground, 0-dB channel gain		106		dB
		Power Tune Mode: IN1 differential DC-coupled input selected and AC signal shorted to ground, 0-dB channel gain		106		
		Power Tune Mode: IN1 differential DC-coupled input selected and AC signal shorted to ground, 12-dB channel gain		94		
SNR	Signal-to-noise ratio, A-weighted ^{(1) (2)}	1.8V AVDD Operation: IN1 differential AC-coupled input selected and AC signal shorted to ground, 0-dB channel gain		110		dB
		1.8V AVDD Operation: IN1 differential DC-coupled input selected and AC signal shorted to ground, 0-dB channel gain		104		
SNR	Signal-to-noise ratio, A-weighted ^{(1) (2)}	1.8V AVDD Operation: IN1 differential DC-coupled input selected and AC signal shorted to ground, 12-dB channel gain		92		dB
SNR	Signal-to-noise ratio, A-weighted ^{(1) (2)}	1.8V AVDD Operation + Power Tune Mode: IN1 differential AC-coupled input selected and AC signal shorted to ground, 0-dB channel gain		104		dB
		1.8V AVDD Operation + Power Tune Mode: IN1 differential DC-coupled input selected and AC signal shorted to ground, 0-dB channel gain		100		
		1.8V AVDD Operation + Power Tune Mode: IN1 differential DC-coupled input selected and AC signal shorted to ground, 12-dB channel gain		88		
DR	Dynamic range, A-weighted ⁽²⁾	IN1 differential AC-coupled input selected and –60-dB full-scale AC signal input, 0-dB channel gain		118		dB
		IN1 differential DC-coupled input selected and –60-dB full-scale AC signal input, 0-dB channel gain		110		
DR	Dynamic range, A-weighted ⁽²⁾	IN1 differential DC-coupled input selected and –72-dB full-scale AC signal input, 12-dB channel gain		98		dB
DR	Dynamic range, A-weighted ⁽²⁾	Power Tune Mode: IN1 differential AC-coupled input selected and –60-dB full-scale AC signal input, 0-dB channel gain		106		dB
		Power Tune Mode: IN1 differential DC-coupled input selected and –60-dB full-scale AC signal input, 0-dB channel gain		106		
		Power Tune Mode: IN1 differential DC-coupled input selected and –72-dB full-scale AC signal input, 12-dB channel gain		94		

at $T_A = 25^\circ\text{C}$, $AVDD = 3.3\text{ V}$, $IOVDD = 3.3\text{ V}$, $f_{IN} = 1\text{-kHz}$ sinusoidal signal, $f_S = 48\text{ kHz}$, 32-bit audio data, $BCLK = 256 \times f_S$, TDM target mode and PLL on (unless otherwise noted)

PARAMETER		TEST CONDITIONS	MIN	NOM	MAX	UNIT
DR	Dynamic range, A-weighted ⁽²⁾	1.8V AVDD Operation: IN1 differential AC-coupled input selected and –60-dB full-scale AC signal input, 0-dB channel gain	106	110		dB
		1.8V AVDD Operation: IN1 differential DC-coupled input selected and –60-dB full-scale AC signal input, 0-dB channel gain		104		
DR	Dynamic range, A-weighted ⁽²⁾	1.8V AVDD Operation: IN1 differential DC-coupled input selected and –72-dB full-scale AC signal input, 12-dB channel gain		92		dB
DR	Dynamic range, A-weighted ⁽²⁾	1.8V AVDD Operation + Power Tune Mode: IN1 differential AC-coupled input selected and –60-dB full-scale AC signal input, 0-dB channel gain		104		dB
		1.8V AVDD Operation + Power Tune Mode: IN1 differential DC-coupled input selected and –60-dB full-scale AC signal input, 0-dB channel gain		100		
		1.8V AVDD Operation + Power Tune Mode: IN1 differential DC-coupled input selected and –72-dB full-scale AC signal input, 12-dB channel gain		88		
THD+N	Total harmonic distortion ⁽²⁾	IN1 differential AC-coupled input selected and –1-dB full-scale AC signal input, 0-dB channel gain		–95	TBD	dB
		IN1 differential DC-coupled input selected and –1-dB full-scale AC signal input, 0-dB channel gain		–95		
THD+N	Total harmonic distortion ⁽²⁾	IN1 differential DC-coupled input selected and –13-dB full-scale AC signal input, 12-dB channel gain		–91		dB
ADC OTHER PARAMETERS						
	Input impedance	Differential input, between INxP and INxM, 5kΩ Mode		5.5		kΩ
	Input impedance	Differential input, between INxP and INxM, 10kΩ Mode		11		kΩ
	Input impedance	Differential input, between INxP and INxM, 40kΩ Mode		44		kΩ
	Input impedance	Single-ended input, between INxP and INxM, 5kΩ Mode		2.75		kΩ
	Input impedance	Single-ended input, between INxP and INxM, 10kΩ Mode		5.5		kΩ
	Input impedance	Single-ended input, between INxP and INxM, 40kΩ Mode		22		kΩ
	Offset	Shorted Input.		TBD		mV
	Digital volume control range	Programmable 0.5-dB steps	–80		47	dB
	Input Signal Bandwidth	Upto 192KSPS FS Rate		0.46		FS
		>192KSPS		90		kHz
	Output data sample rate	Programmable	3.675		768	kHz
	Output data sample word length	Programmable	16		32	Bits
	Digital high-pass filter cutoff frequency	First-order IIR filter with programmable coefficients, –3-dB point (default setting)		2		Hz
	Interchannel isolation	–1-dB full-scale AC signal line-in input to non measurement channel		–134		dB
	Interchannel gain mismatch	–6-dB full-scale AC signal line-in input, 0-dB channel gain		0.1		dB

at $T_A = 25^\circ\text{C}$, $AVDD = 3.3\text{ V}$, $IOVDD = 3.3\text{ V}$, $f_{IN} = 1\text{-kHz}$ sinusoidal signal, $f_S = 48\text{ kHz}$, 32-bit audio data, $BCLK = 256 \times f_S$, TDM target mode and PLL on (unless otherwise noted)

PARAMETER		TEST CONDITIONS	MIN	NOM	MAX	UNIT
	Interchannel phase mismatch	1-kHz sinusoidal signal		0.01		Degrees
PSRR	Power-supply rejection ratio	100-mV _{PP} , 1-kHz sinusoidal signal on AVDD, differential input selected, 0-dB channel gain		92		dB
CMRR	Common-mode rejection ratio	Differential microphone input selected, 0-dB channel gain, 1-V _{RMS} AC input, 1-kHz signal on both pins and measure level at output, ADC_CHx_CFG0 D3-2 register bits set to 2b'10 to configure device in high CMRR performance mode		80		dB
MICROPHONE BIAS						
	MICBIAS noise	BW = 20 Hz to 20 kHz, A-weighted, 1- μF capacitor between MICBIAS and AVSS		2		μV_{RMS}
	MICBIAS voltage	Bypass to AVDD		AVDD		V
	MICBIAS voltage	AVDD=1.8V		1.375		V
	MICBIAS voltage	AVDD=3.3V		2.75		V
DIGITAL I/O						
$V_{IL(\text{SHDNZ})}$	Low-level digital input logic voltage threshold	SHDNZ pin	-0.3		$0.25 \times IOVDD$	V
$V_{IH(\text{SHDNZ})}$	High-level digital input logic voltage threshold	SHDNZ pin	$0.75 \times IOVDD$		$IOVDD + 0.3$	V
V_{IL}	Low-level digital input logic voltage threshold	All digital pins except SDA and SCL, IOVDD 1.8-V operation	-0.3		$0.35 \times IOVDD$	V
		All digital pins except SDA and SCL, IOVDD 3.3-V operation	-0.3		0.8	
V_{IH}	High-level digital input logic voltage threshold	All digital pins except SDA and SCL, IOVDD 1.8-V operation	$0.65 \times IOVDD$		$IOVDD + 0.3$	V
		All digital pins except SDA and SCL, IOVDD 3.3-V operation	2		$IOVDD + 0.3$	
V_{OL}	Low-level digital output voltage	All digital pins except SDA and SCL, $I_{OL} = -2\text{ mA}$, IOVDD 1.8-V operation			0.45	V
		All digital pins except SDA and SCL, $I_{OL} = -2\text{ mA}$, IOVDD 3.3-V operation			0.4	
V_{OH}	High-level digital output voltage	All digital pins except SDA and SCL, $I_{OH} = 2\text{ mA}$, IOVDD 1.8-V operation	$IOVDD - 0.45$			V
		All digital pins except SDA and SCL, $I_{OH} = 2\text{ mA}$, IOVDD 3.3-V operation	2.4			
$V_{IL(12C)}$	Low-level digital input logic voltage threshold	SDA and SCL	-0.5		$0.3 \times IOVDD$	V
$V_{IH(12C)}$	High-level digital input logic voltage threshold	SDA and SCL	$0.7 \times IOVDD$		$IOVDD + 0.5$	V
$V_{OL1(12C)}$	Low-level digital output voltage	SDA, $I_{OL(12C)} = -3\text{ mA}$, $IOVDD > 2\text{ V}$			0.4	V
$V_{OL2(12C)}$	Low-level digital output voltage	SDA, $I_{OL(12C)} = -2\text{ mA}$, $IOVDD \leq 2\text{ V}$			$0.2 \times IOVDD$	V
$I_{OL(12C)}$	Low-level digital output current	SDA, $V_{OL(12C)} = 0.4\text{ V}$, standard-mode or fast-mode	3			mA
		SDA, $V_{OL(12C)} = 0.4\text{ V}$, fast-mode plus	20			
I_{IL}	Input logic-low leakage for digital inputs	All digital pins, input = 0 V	-5	0.1	5	μA
I_{IH}	Input logic-high leakage for digital inputs	All digital pins, input = IOVDD	-5	0.1	5	μA

at $T_A = 25^\circ\text{C}$, $AVDD = 3.3\text{ V}$, $IOVDD = 3.3\text{ V}$, $f_{IN} = 1\text{-kHz}$ sinusoidal signal, $f_S = 48\text{ kHz}$, 32-bit audio data, $BCLK = 256 \times f_S$, TDM target mode and PLL on (unless otherwise noted)

PARAMETER		TEST CONDITIONS	MIN	NOM	MAX	UNIT
C_{IN}	Input capacitance for digital inputs	All digital pins		5		pF
R_{PD}	Pulldown resistance for digital I/O pins when asserted on			20		k Ω
TYPICAL SUPPLY CURRENT CONSUMPTION						
I_{AVDD}	Current consumption in sleep mode (software shutdown mode)	All device external clocks stopped	TBD			μA
I_{IOVDD}			1			
I_{AVDD}	Current consumption when MICBIAS ON, MICBIAS voltage 10 V, 30 mA load, ADC off	$f_S = 48\text{ kHz}$, $BCLK = 256 \times f_S$	TBD			mA
I_{IOVDD}			0.01			
I_{AVDD}	Current consumption with ADC 2-channel operation at f_S 16-kHz, MICBIAS off, PLL on, $BCLK = 512 \times f_S$		TBD			mA
I_{IOVDD}			0.1			
I_{AVDD}	Current consumption with ADC 2-channel operation at f_S 48-kHz, MICBIAS on, PLL off, $BCLK = 512 \times f_S$		TBD			mA
I_{IOVDD}			0.1			

- (1) Ratio of output level with 1-kHz full-scale sine-wave input, to the output level with the AC signal input shorted to ground, measured A-weighted over a 20-Hz to 20-kHz bandwidth using an audio analyzer.
- (2) All performance measurements done with 20-kHz low-pass filter and, where noted, A-weighted filter. Failure to use such a filter can result in higher THD and lower SNR and dynamic range readings than shown in the Electrical Characteristics. The low-pass filter removes out-of-band noise, which, although not audible, can affect dynamic specification values.

6.6 Timing Requirements: I²C Interface

at T_A = 25°C, IOVDD = 3.3 V or 1.8 V (unless otherwise noted); see TBD for timing diagram

		MIN	NOM	MAX	UNIT
STANDARD-MODE					
f _{SCL}	SCL clock frequency	0		100	kHz
t _{HD,STA}	Hold time (repeated) START condition. After this period, the first clock pulse is generated.	4			μs
t _{LOW}	Low period of the SCL clock	4.7			μs
t _{HIGH}	High period of the SCL clock	4			μs
t _{SU,STA}	Setup time for a repeated START condition	4.7			μs
t _{HD,DAT}	Data hold time	0		3.45	μs
t _{SU,DAT}	Data setup time	250			ns
t _r	SDA and SCL rise time			1000	ns
t _f	SDA and SCL fall time			300	ns
t _{SU,STO}	Setup time for STOP condition	4			μs
t _{BUF}	Bus free time between a STOP and START condition	4.7			μs
FAST-MODE					
f _{SCL}	SCL clock frequency	0		400	kHz
t _{HD,STA}	Hold time (repeated) START condition. After this period, the first clock pulse is generated.	0.6			μs
t _{LOW}	Low period of the SCL clock	1.3			μs
t _{HIGH}	High period of the SCL clock	0.6			μs
t _{SU,STA}	Setup time for a repeated START condition	0.6			μs
t _{HD,DAT}	Data hold time	0		0.9	μs
t _{SU,DAT}	Data setup time	100			ns
t _r	SDA and SCL rise time	20		300	ns
t _f	SDA and SCL fall time		20 × (IOVDD / 5.5 V)	300	ns
t _{SU,STO}	Setup time for STOP condition	0.6			μs
t _{BUF}	Bus free time between a STOP and START condition	1.3			μs
FAST-MODE PLUS					
f _{SCL}	SCL clock frequency	0		1000	kHz
t _{HD,STA}	Hold time (repeated) START condition. After this period, the first clock pulse is generated.	0.26			μs
t _{LOW}	Low period of the SCL clock	0.5			μs
t _{HIGH}	High period of the SCL clock	0.26			μs
t _{SU,STA}	Setup time for a repeated START condition	0.26			μs
t _{HD,DAT}	Data hold time	0			μs
t _{SU,DAT}	Data setup time	50			ns
t _r	SDA and SCL Rise Time			120	ns
t _f	SDA and SCL Fall Time		20 × (IOVDD / 5.5 V)	120	ns
t _{SU,STO}	Setup time for STOP condition	0.26			μs
t _{BUF}	Bus free time between a STOP and START condition	0.5			μs

6.7 Switching Characteristics: I²C Interface

at T_A = 25°C, IOVDD = 3.3 V or 1.8 V (unless otherwise noted); see TBD for timing diagram

PARAMETER		TEST CONDITIONS	MIN	TYP	MAX	UNIT
t _d (SDA)	SCL to SDA delay	Standard-mode	200		1250	ns
		Fast-mode	200		850	ns
		Fast-mode plus			400	ns

6.8 Timing Requirements: SPI Interface

at T_A = 25°C, IOVDD = 3.3 V or 1.8 V and 20-pF load on all outputs (unless otherwise noted); see TBD for timing diagram

PARAMETER		TEST CONDITIONS	MIN	NOM	MAX	UNIT
t _(SCLK)	SCLK period		40			ns
t _H (SCLK)	SCLK high pulse duration		18			ns
t _L (SCLK)	SCLK low pulse duration		18			ns
t _{LEAD}	Enable lead time		16			ns
t _{TRAIL}	Enable trail time		16			ns
t _{DSEQ}	Sequential transfer delay		20			ns
t _{SU} (MOSI)	MOSI data setup time		8			ns
t _{HLD} (MOSI)	MOSI data hold time		8			ns
t _r (SCLK)	SCLK rise time	10% - 90% rise time			6	ns
t _f (SCLK)	SCLK fall time	90% - 10% fall time			6	ns

6.9 Switching Characteristics: SPI Interface

at T_A = 25°C, IOVDD = 3.3 V or 1.8 V and 20-pF load on all outputs (unless otherwise noted); see for timing diagram

PARAMETER		TEST CONDITIONS	MIN	TYP	MAX	UNIT
t _a (MISO)	MISO access time	IOVDD = 1.8 V			18	ns
		IOVDD = 3.3 V			14	
t _d (MISO)	SCLK to MISO delay	50% of SCLK to 50% of MISO, IOVDD = 1.8 V			19	ns
		50% of SCLK to 50% of MISO, IOVDD = 3.3 V			15	
t _{dis} (MISO)	MISO disable time	IOVDD = 1.8 V			18	ns
		IOVDD = 3.3 V			14	

6.10 Timing Requirements: TDM, I²S or LJ Interface

at T_A = 25°C, IOVDD = 3.3 V or 1.8 V and 20-pF load on all outputs (unless otherwise noted); see for timing diagram

PARAMETER		TEST CONDITIONS	MIN	NOM	MAX	UNIT
t _(BCLK)	BCLK period		40			ns
t _H (BCLK)	BCLK high pulse duration ⁽¹⁾		18			ns
t _L (BCLK)	BCLK low pulse duration ⁽¹⁾		18			ns
t _{SU} (FSYNC)	FSYNC setup time		8			ns
t _{HLD} (FSYNC)	FSYNC hold time		8			ns
t _r (BCLK)	BCLK rise time	10% - 90% rise time			10	ns
t _f (BCLK)	BCLK fall time	90% - 10% fall time			10	ns

- (1) The BCLK minimum high or low pulse duration must be higher than 25 ns (to meet the timing specifications), if the SDO_{UT} data line is latched on the opposite BCLK edge polarity than the edge used by the device to transmit SDO_{UT} data.

6.11 Switching Characteristics: TDM, I²S or LJ Interface

at T_A = 25°C, IOVDD = 3.3 V or 1.8 V and 20-pF load on all outputs (unless otherwise noted); see TBD for timing diagram

PARAMETER	TEST CONDITIONS	MIN	TYP	MAX	UNIT
t _d (SDOUT-BCLK)	BCLK to SDOUT delay	50% of BCLK to 50% of SDOUT, IOVDD = 1.8 V		18	ns
		50% of BCLK to 50% of SDOUT, IOVDD = 3.3 V		14	
t _d (SDOUT-FSYNC)	FSYNC to SDOUT delay in TDM or LJ mode (for MSB data with TX_OFFSET = 0)	50% of FSYNC to 50% of SDOUT, IOVDD = 1.8 V		18	ns
		50% of FSYNC to 50% of SDOUT, IOVDD = 3.3 V		14	
f _(BCLK)	BCLK output clock frequency; master mode (1)			24.576	MHz
t _H (BCLK)	BCLK high pulse duration; master mode	IOVDD = 1.8 V		14	ns
		IOVDD = 3.3 V		14	
t _L (BCLK)	BCLK low pulse duration; master mode	IOVDD = 1.8 V		14	ns
		IOVDD = 3.3 V		14	
t _d (FSYNC)	BCLK to FSYNC delay; master mode	50% of BCLK to 50% of FSYNC, IOVDD = 1.8 V		18	ns
		50% of BCLK to 50% of FSYNC, IOVDD = 3.3 V		14	
t _r (BCLK)	BCLK rise time; master mode	10% - 90% rise time, IOVDD = 1.8 V		10	ns
		10% - 90% rise time, IOVDD = 3.3 V		10	
t _f (BCLK)	BCLK fall time; master mode	90% - 10% fall time, IOVDD = 1.8 V		8	ns
		90% - 10% fall time, IOVDD = 3.3 V		8	

(1) The BCLK output clock frequency must be lower than 18.5 MHz (to meet the timing specifications), if the SDOUT data line is latched on the opposite BCLK edge polarity than the edge used by the device to transmit SDOUT data.

6.12 Timing Requirements: PDM Digital Microphone Interface

at T_A = 25°C, IOVDD = 3.3 V or 1.8 V and 20-pF load on all outputs (unless otherwise noted); see TBD for timing diagram

PARAMETER	TEST CONDITIONS	MIN	NOM	MAX	UNIT
t _{SU} (PDMINx)	PDMINx setup time	30			ns
t _{HLD} (PDMINx)	PDMINx hold time	TBD			ns

6.13 Switching Characteristics: PDM Digital Microphone Interface

at T_A = 25°C, IOVDD = 3.3 V or 1.8 V and 20-pF load on all outputs (unless otherwise noted); see TBD for timing diagram

PARAMETER	TEST CONDITIONS	MIN	TYP	MAX	UNIT
f _(PDMCLK)	PDMCLK clock frequency	0.768		6.144	MHz
t _H (PDMCLK)	PDMCLK high pulse duration	72			ns
t _L (PDMCLK)	PDMCLK low pulse duration	72			ns
t _r (PDMCLK)	PDMCLK rise time	10% - 90% rise time		8	ns
t _f (PDMCLK)	PDMCLK fall time	90% - 10% fall time		8	ns

7 Parameter Measurement Information

ADVANCE INFORMATION

8 Detailed Description

8.1 Overview

The TAA5212 is from a scalable family of devices. As part of the extended family of devices, the TAA5212 consists of a high-performance, low-power, flexible, mono/stereo, audio analog-to-digital converter (ADC). This device is intended for applications such as ruggedized communication equipment, IP network camera, Professional Audio and multimedia applications. The high dynamic range of this device enables far-field audio recording with high fidelity. This device integrates a host of features that reduce cost, board space, and power consumption in space-constrained system designs. Package, performance, and compatible configuration registers across extended family make this device well suited for scalable system designs.

The TAA5212 consists of the following blocks:

- 2-channel, multibit, high-performance delta-sigma ($\Delta\Sigma$) ADCs
- Configurable single-ended or differential audio inputs with 2V_{rms} signal swing
- Low-noise programmable microphone bias output
- Automatic gain controller (AGC)
- Programmable Decimation filters with linear-phase or low-latency filter
- Programmable channel gain, volume control, and biquad filters for each channel
- Programmable phase and gain calibration with fine resolution for each channel
- Programmable High-pass filter (HPF) and digital channel mixer
- Pulse density modulation (PDM) digital microphone interface with high-performance decimation filter
- Dual I²S or TDM Interface with Independent Sample Rate(Synchronous)
- Synchronous Sample Rate Converter(SRC)
- Integrated low-jitter, phase-locked loop (PLL) supporting a wide range of system clocks
- Integrated digital and analog voltage regulators to support single-supply operation

Communication to the TAA5212 for configuring the control registers is supported using an I²C and SPI interface. The device supports a highly flexible audio serial interface [time-division multiplexing (TDM), I²S, or left-justified (LJ)] to transmit audio data seamlessly in the system across devices.

8.2 Functional Block Diagram

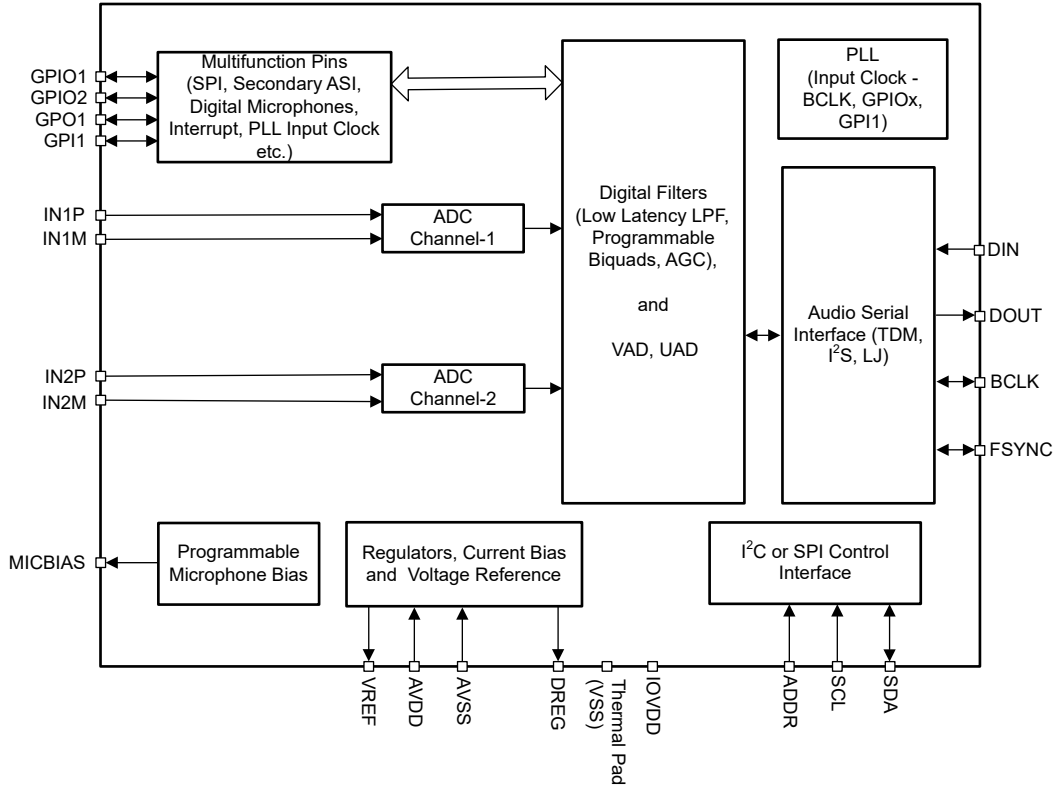

8-1. Functional Block Diagram

8.3 Feature Description

8.3.1 Hardware Control

The device supports simple hardware-pin-controlled options to select a specific mode of operation and audio interface for a given system. The MD0 to MD6 pins allow the device to be controlled by either pullup or pulldown resistors.

8.3.2 Serial Interfaces

This device has two serial interfaces: control and audio data. The control serial interface is used for device configuration. The audio data serial interface is used for transmitting audio data to the host device.

8.3.2.1 Control Serial Interfaces

The device contains configuration registers and programmable coefficients that can be set to the desired values for a specific system and application use. All these registers can be accessed using either I²C or SPI communication to the device. For more information, see the [セクション 8.5](#) section.

8.3.2.2 Audio Serial Interfaces

Digital audio data flows between the host processor and the TAA5212 on the digital audio serial interface (ASI), or audio bus. This highly flexible ASI bus includes a TDM mode for multichannel operation, support for I²S or left-justified protocols format, programmable data length options, very flexible controller-target configurability for bus clock lines and the ability to communicate with multiple devices within a system directly.

The TAA5212 supports up to two ASI Interfaces. Secondary ASI Clock and Data Pins can be configured by setting GPIO's. Frame Sync of two ASI's must be synchronous. See the for more details on Secondary ASI.

The bus protocol TDM, I²S, or left-justified (LJ) format can be selected for primary ASI by using the PASI_FORMAT[1:0], P0_R26_D[7:6] register bits. As shown in 表 8-1 and 表 8-2, these modes are all most significant byte (MSB)-first, pulse code modulation (PCM) data format, with the output channel data word-length programmable as 16, 20, 24, or 32 bits by configuring the PASI_WLEN[1:0], P0_R26_D[5:4] register bits.

表 8-1. Primary Audio Serial Interface Format

P0_R26_D[7:6] : PASI_FORMAT[1:0]	PRIMARY AUDIO SERIAL INTERFACE FORMAT
00 (default)	Time division multiplexing (TDM) mode
01	Inter IC sound (I ² S) mode
10	Left-justified (LJ) mode
11	Reserved (do not use this setting)

表 8-2. Primary Audio Serial Interface Data Word-Length

P0_R7_D[5:4] : PASI_WLEN[1:0]	PRIMARY AUDIO OUTPUT CHANNEL DATA WORD-LENGTH
00	Data word-length set to 16 bits
01	Data word-length set to 20 bits
10	Data word-length set to 24 bits
11 (default)	Data word-length set to 32 bits

The frame sync pin, FSYNC, is used in this audio bus protocol to define the beginning of a frame and has the same frequency as the output data sample rates. The bit clock pin, BCLK, is used to clock out the digital audio data across the serial bus. The number of bit-clock cycles in a frame must accommodate multiple device active output channels with the programmed data word length.

A frame consists of multiple time-division channel slots (up to 32) to allow all input/output channel audio data transmissions to complete on the audio bus by a device or multiple devices sharing the same audio bus. The device supports up to eight input channels and eight output channels that can be configured on primary ASI bus to place their audio data on bus slot 0 to slot 31. 表 8-3 lists the output channel-1 slot configuration settings. In I²S and LJ mode, the slots are divided into two sets, left-channel slots and right-channel slots, as described in the セクション 8.3.2.2.2 and セクション 8.3.2.2.3 sections.

表 8-3. Output Channel-1 Slot Assignment Settings

P0_R30_D[4:0] : PASI_TX_CH1_SLOT[4:0]	OUTPUT CHANNEL 1 SLOT ASSIGNMENT
0 0000 = 0d (default)	Slot 0 for TDM or left slot 0 for I ² S, LJ.
0 0001 = 1d	Slot 1 for TDM or left slot 1 for LJ.
...	...
0 1111 = 15d	Slot 15 for TDM or left slot 15 for LJ.
1 0000 = 32d	Slot 16 for TDM or right slot 0 for I ² S, LJ.
...	...
1 1110 = 30d	Slot 30 for TDM or right slot 14 for LJ.
1 1111 = 31d	Slot 31 for TDM or right slot 15 for LJ.

Similarly, the slot assignment setting for output channel 2 to channel 8 can be done using the PASI_TX_CH2_SLOT (P0_R31) to PASI_TX_CH8_SLOT (P0_R37) registers and for input channel 1 to channel 8 by using the PASI_RX_CH1_SLOT (P0_R40) to PAS_RX_CH8_SLOT (P0_R47), respectively.

The slot word length is the same as the primary ASI channel word length set for the device. The output channel data word length must be set to the same value for all TAA5212 devices if all devices share the same ASI bus in a system. The maximum number of slots possible for the ASI bus in a system is limited by the available bus bandwidth, which depends upon the BCLK frequency, output data sample rate used, and the channel data word length configured.

The device also includes a feature that offsets the start of the slot data transfer with respect to the frame sync by up to 31 cycles of the bit clock. Offset can be configured independently for input and output data paths. 表 8-4 and 表 8-5 lists the programmable offset configuration settings for transmission and receive paths respectively.

表 8-4. Programmable Offset Settings for the ASI Slot Start for transmission

P0_R28_D[4:0] : PASI_TX_OFFSET[4:0]	PROGRAMMABLE OFFSET SETTING FOR SLOT DATA TRANSMISSION START
0 0000 = 0d (default)	The device follows the standard protocol timing without any offset.
0 0001 = 1d	Slot start is offset by one BCLK cycle, as compared to standard protocol timing. For I ² S or LJ, the left and right slot start is offset by one BCLK cycle, as compared to standard protocol timing.
.....
1 1110 = 30d	Slot start is offset by 30 BCLK cycles, as compared to standard protocol timing. For I ² S or LJ, the left and right slot start is offset by 30 BCLK cycles, as compared to standard protocol timing.
1 1111 = 31d	Slot start is offset by 31 BCLK cycles, as compared to standard protocol timing. For I ² S or LJ, the left and right slot start is offset by 31 BCLK cycles, as compared to standard protocol timing.

表 8-5. Programmable Offset Settings for the ASI Slot Start for Receive

P0_R38_D[4:0] : PASI_RX_OFFSET[4:0]	PROGRAMMABLE OFFSET SETTING FOR SLOT DATA RECEIVE START
0 0000 = 0d (default)	The device follows the standard protocol timing without any offset.
0 0001 = 1d	Slot start is offset by one BCLK cycle, as compared to standard protocol timing. For I ² S or LJ, the left and right slot start is offset by one BCLK cycle, as compared to standard protocol timing.
.....
1 1110 = 30d	Slot start is offset by 30 BCLK cycles, as compared to standard protocol timing. For I ² S or LJ, the left and right slot start is offset by 30 BCLK cycles, as compared to standard protocol timing.
1 1111 = 31d	Slot start is offset by 31 BCLK cycles, as compared to standard protocol timing. For I ² S or LJ, the left and right slot start is offset by 31 BCLK cycles, as compared to standard protocol timing.

The device also features the ability to invert the polarity of the frame sync pin, FSYNC, used to transfer the audio data as compared to the default FSYNC polarity used in standard protocol timing. This feature can be set using the PASI_FSYNC_POL, P0_R26_D3 register bit. Similarly, the device can invert the polarity of the bit clock pin, BCLK, which can be set using the PASI_BCLK_POL, P0_R26_D2 register bit.

In addition, the word clock and bit clock can be independently configured in either Controller or Target mode, for flexible connectivity to a wide variety of processors. The word clock is used to define the beginning of a frame, and may be programmed as either a pulse or a square-wave signal. The frequency of this clock corresponds to the maximum of the selected ADC sampling frequencies.

8.3.2.2.1 Time Division Multiplexed Audio (TDM) Interface

In TDM mode, also known as DSP mode, the rising edge of FSYNC starts the data transfer with the slot 0 data first. Immediately after the slot 0 data transmission, the remaining slot data are transmitted in order. FSYNC and each data bit (except the MSB of slot 0 when TX_OFFSET equals 0) is transmitted on the rising edge of BCLK. 図 8-2 to 図 8-5 illustrate the protocol timing for TDM operation with various configurations.

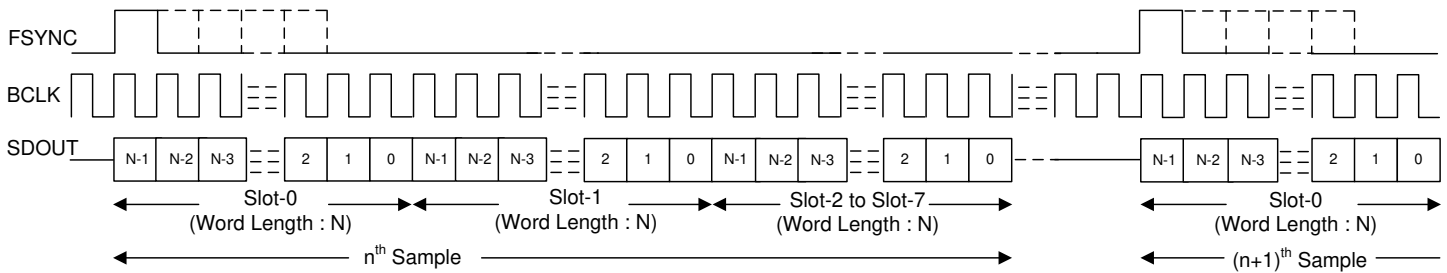

8-2. TDM Mode Standard Protocol Timing ($PASI_TX_OFFSET = 0$)

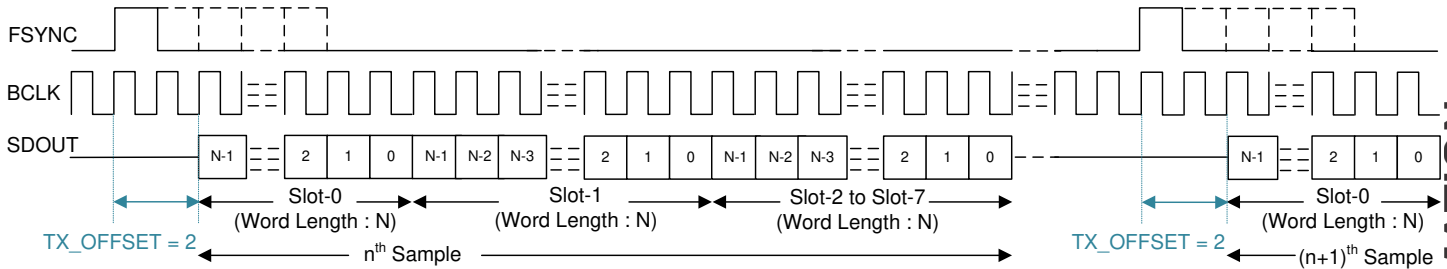

8-3. TDM Mode Protocol Timing ($PASI_TX_OFFSET = 2$)

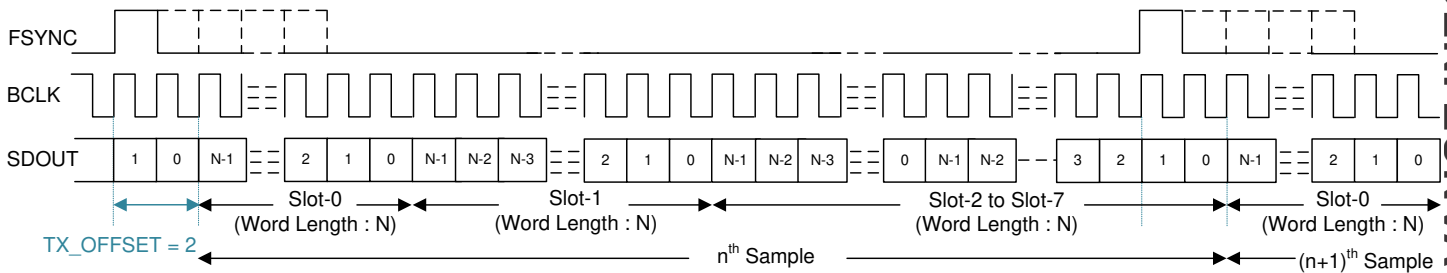

8-4. TDM Mode Protocol Timing (No Idle BCLK Cycles, $PASI_TX_OFFSET = 2$)

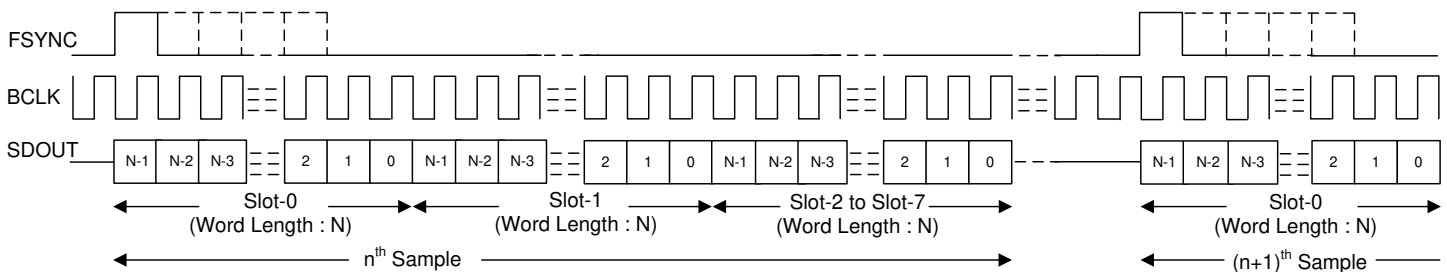



8-5. TDM Mode Protocol Timing ($PASI_TX_OFFSET = 0$ and $PASI_BCLK_POL = 1$)

For proper operation of the audio bus in TDM mode, the number of bit clocks per frame must be greater than or equal to the number of active output channels times the programmed word length of the output channel data. The device supports FSYNC as a pulse with a 1-cycle-wide bit clock, but also supports multiples as well. For a higher BCLK frequency operation, using TDM mode with a $PASI_TX_OFFSET$ value higher than 0 is recommended.

8.3.2.2.2 Inter IC Sound (I²S) Interface

The standard I²S protocol is defined for only two channels: left and right. The device extends the same protocol timing for multichannel operation. In I²S mode, the MSB of the left slot 0 is transmitted on the falling edge of BCLK in the second cycle after the falling edge of FSYNC. Immediately after the left slot 0 data transmission, the

remaining left slot data are transmitted in order. The MSB of the right slot 0 is transmitted on the falling edge of BCLK in the second cycle after the *rising* edge of FSYNC. Immediately after the right slot 0 data transmission, the remaining right slot data are transmitted in order. FSYNC and each data bit is transmitted on the falling edge of BCLK.  8-6 to  8-9 illustrate the protocol timing for I²S operation with various configurations.

ADVANCE INFORMATION

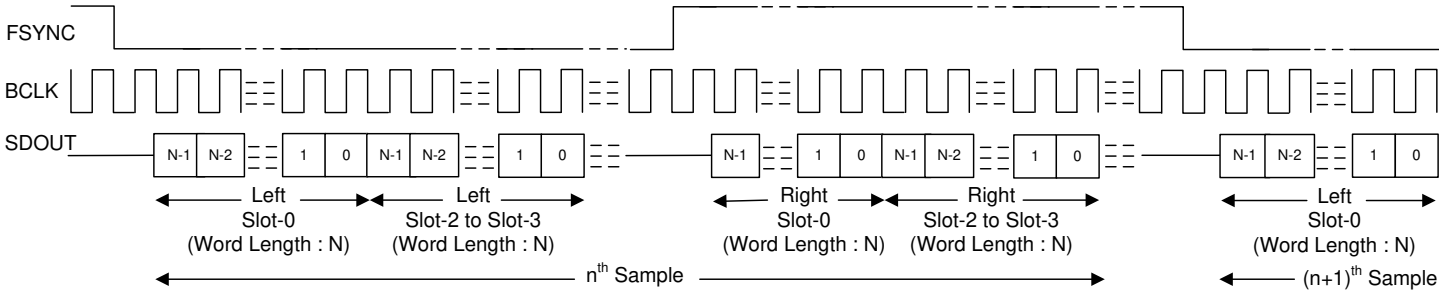

 8-6. I²S Mode Standard Protocol Timing (PASI_TX_OFFSET = 0)

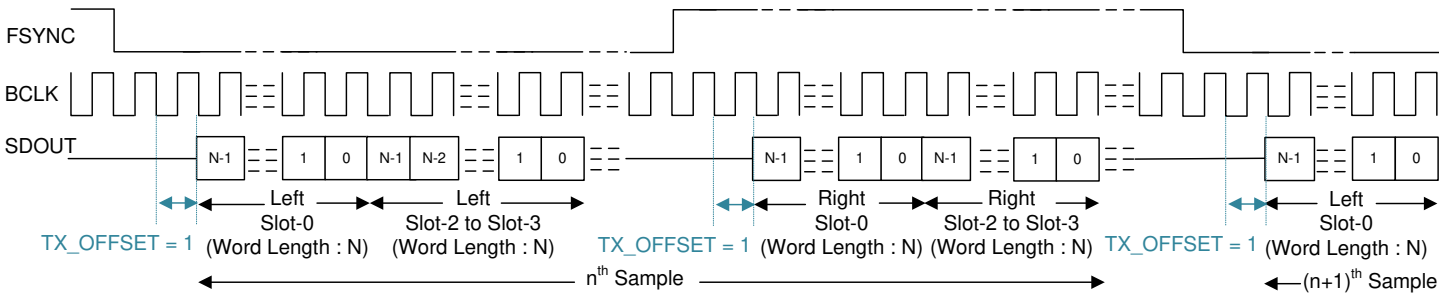

 8-7. I²S Protocol Timing (PASI_TX_OFFSET = 1)

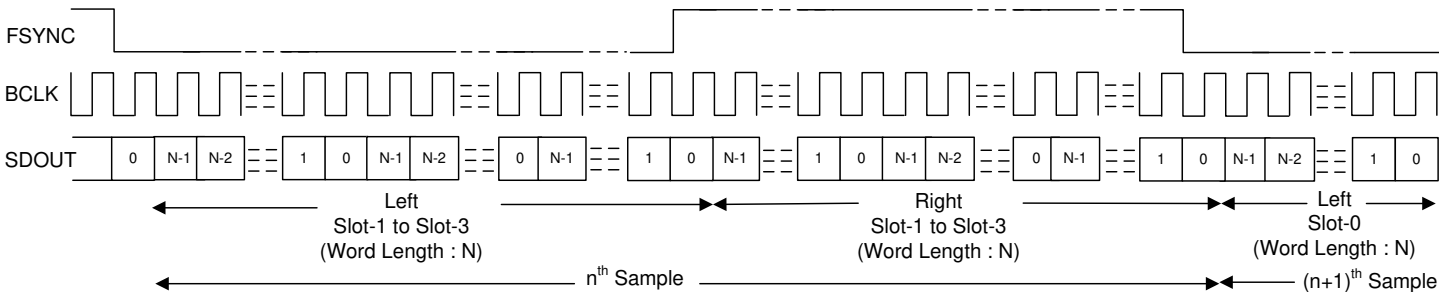

 8-8. I²S Protocol Timing (No Idle BCLK Cycles, PASI_TX_OFFSET = 0)

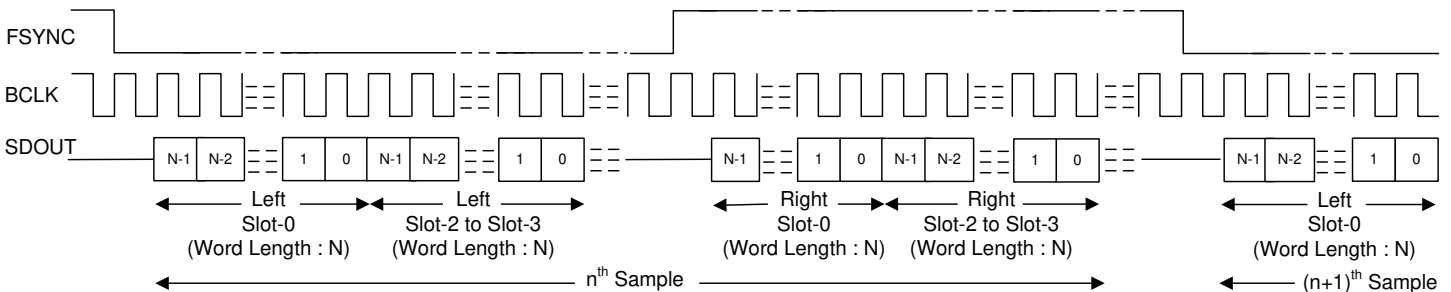

 8-9. I²S Protocol Timing (PASI_TX_OFFSET = 0 and PASI_BCLK_POL = 1)

For proper operation of the audio bus in I²S mode, the number of bit clocks per frame must be greater than or equal to the number of active output channels (including left and right slots) times the programmed word length

of the output channel data. The device FSYNC low pulse must be a number of BCLK cycles wide that is greater than or equal to the number of active left slots times the data word length configured. Similarly, the FSYNC high pulse must be a number of BCLK cycles wide that is greater than or equal to the number of active right slots times the data word length configured.

8.3.2.2.3 Left-Justified (LJ) Interface

The standard LJ protocol is defined for only two channels: left and right. The device extends the same protocol timing for multichannel operation. In LJ mode, the MSB of the left slot 0 is transmitted in the same BCLK cycle after the *rising* edge of FSYNC. Each subsequent data bit is transmitted on the falling edge of BCLK. Immediately after the left slot 0 data transmission, the remaining left slot data are transmitted in order. The MSB of the right slot 0 is transmitted in the same BCLK cycle after the *falling* edge of FSYNC. Each subsequent data bit is transmitted on the falling edge of BCLK. Immediately after the right slot 0 data transmission, the remaining right slot data are transmitted in order. FSYNC is transmitted on the falling edge of BCLK. 8-10 to 8-13 illustrate the protocol timing for LJ operation with various configurations.

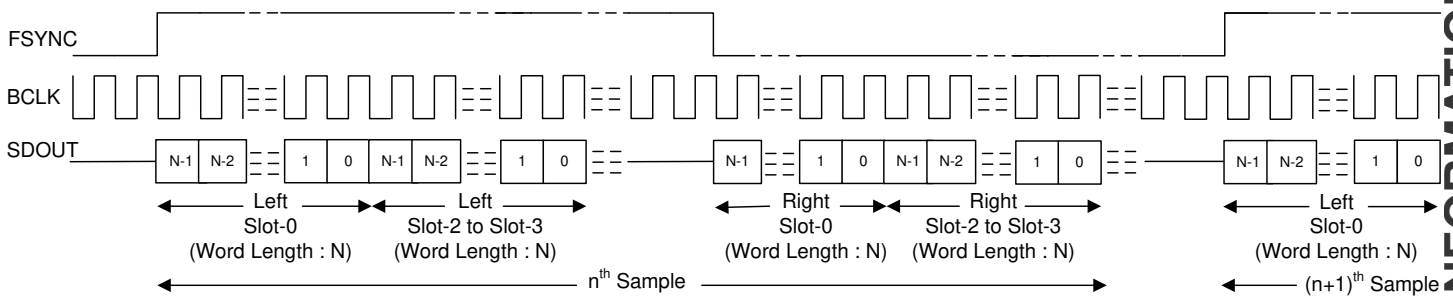

8-10. LJ Mode Standard Protocol Timing (TX_OFFSET = 0)

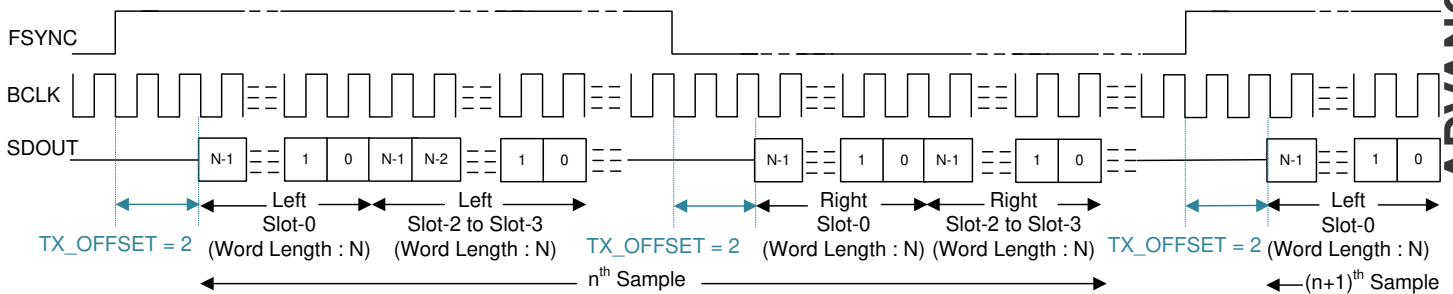

8-11. LJ Protocol Timing (TX_OFFSET = 2)

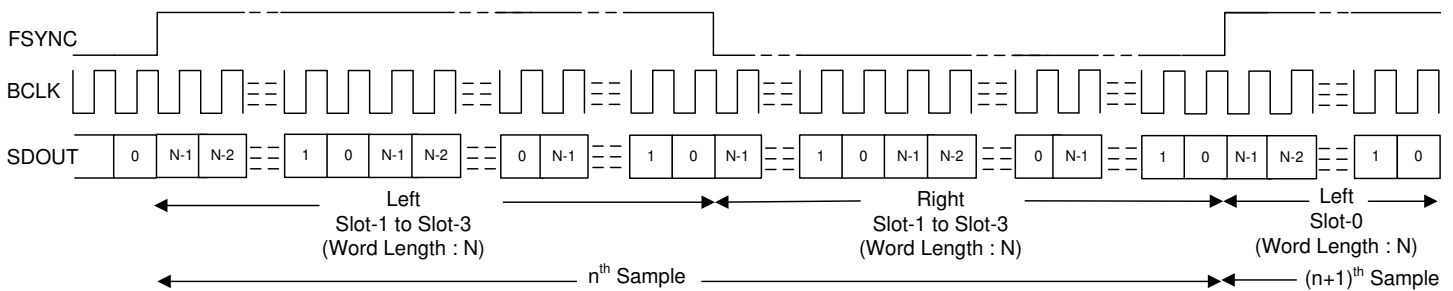

8-12. LJ Protocol Timing (No Idle BCLK Cycles, TX_OFFSET = 0)



図 8-13. LJ Protocol Timing (TX_OFFSET = 1 and BCLK_POL = 1)

For proper operation of the audio bus in LJ mode, the number of bit clocks per frame must be greater than or equal to the number of active output channels (including left and right slots) times the programmed word length of the output channel data. The device FSYNC high pulse must be a number of BCLK cycles wide that is greater than or equal to the number of active left slots times the data word length configured. Similarly, the FSYNC low pulse must be number of BCLK cycles wide that is greater than or equal to the number of active right slots times the data word length configured. For a higher BCLK frequency operation, using LJ mode with a TX_OFFSET value higher than 0 is recommended.

8.3.2.3 Using Multiple Devices With Shared Buses

The device has many supported features and flexible options that can be used in the system to seamlessly connect multiple TAA5212 devices by sharing a single common I²C or SPI control bus and an audio serial interface bus. This architecture enables multiple applications to be applied to a system that require a microphone or speaker array for beam-forming operation, audio conferencing, noise cancellation, and so forth. 図 8-14 shows a diagram of multiple TAA5212 devices in a configuration where the control and audio data buses are shared.

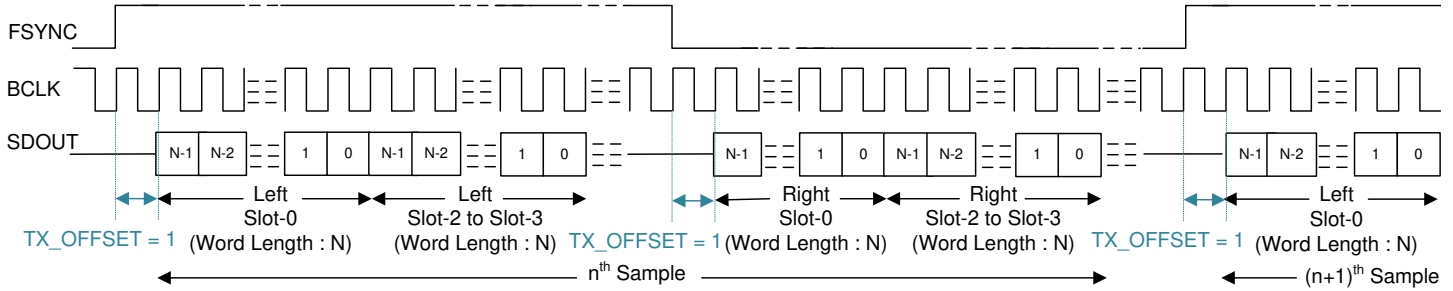

図 8-14. Multiple TAA5212 Devices With Shared Control and Audio Data Buses

The TAA5212 consists of the following features to enable seamless connection and interaction of multiple devices using a shared bus:

- Supports up to four pin-programmable I²C target addresses
- I²C broadcast simultaneously writes to (or triggers) all TAA5212 devices
- Supports up to 32 configuration input/output channel slots for the audio serial interface
- Tri-state feature (with enable and disable) for the unused audio data slots of the device
- Supports a bus-holder feature (with enable and disable) to keep the last driven value on the audio bus
- The GPIOx, GPI1 or GPO1 pin can be configured as a secondary input/output data lane or as a secondary audio serial interface

- The GPIOx, GPI1 or GPO1 pin can be used in a daisy-chain configuration of multiple TAA5212 devices
- Supports one BCLK cycle data latching timing to relax the timing requirement for the high-speed interface
- Programmable controller and target options for both primary and secondary audio serial interface
- Ability to synchronize the multiple devices for the simultaneous sampling requirement across devices

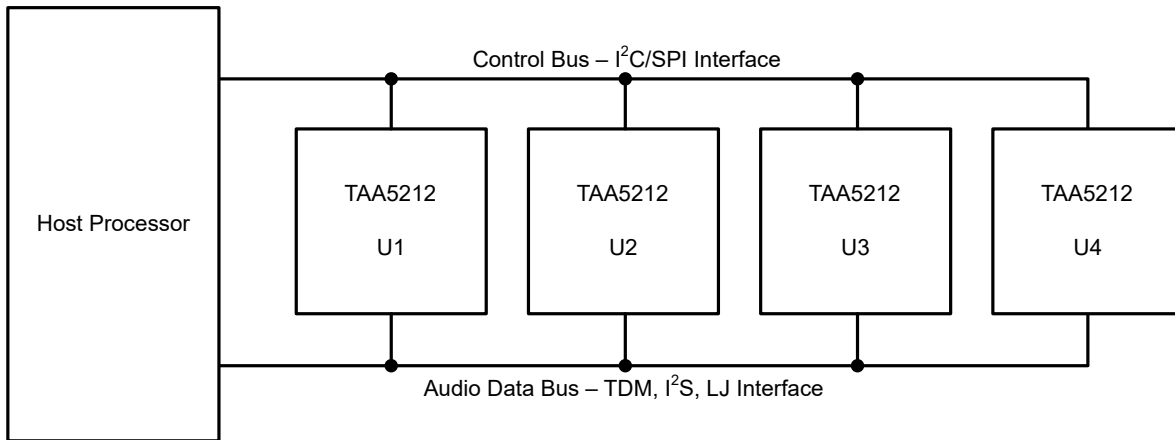
See the [Multiple TAC5x1x Devices With a Shared TDM and I²C/SPI Bus application report](#) for further details.

8.3.3 Phase-Locked Loop (PLL) and Clock Generation

The device has a smart auto-configuration block to generate all necessary internal clocks required for the ADC modulator and the digital filter engine used for signal processing. This configuration is done by monitoring the frequency of the FSYNC and BCLK signal on the audio buses.

The device supports the various data sample rates (of the FSYNC signal frequency) and the BCLK to FSYNC ratio to configure all clock dividers, including the PLL configuration, internally without host programming. 表 8-6 and 表 8-7 list the supported FSYNC and BCLK frequencies.

表 8-6. Supported FSYNC (Multiples or Submultiples of 48 kHz) and BCLK Frequencies

BCLK TO FSYNC RATIO	BCLK (MHz)								
	FSYNC (8 kHz)	FSYNC (16 kHz)	FSYNC (24 kHz)	FSYNC (32 kHz)	FSYNC (48 kHz)	FSYNC (96 kHz)	FSYNC (192 kHz)	FSYNC (384 kHz)	FSYNC (768 kHz)
16	Reserved	0.256	0.384	0.512	0.768	1.536	3.072	6.144	12.288
24	Reserved	0.384	0.576	0.768	1.152	2.304	4.608	9.216	18.432
32	0.256	0.512	0.768	1.024	1.536	3.072	6.144	12.288	24.576
48	0.384	0.768	1.152	1.536	2.304	4.608	9.216	18.432	Reserved
64	0.512	1.024	1.536	2.048	3.072	6.144	12.288	24.576	Reserved
96	0.768	1.536	2.304	3.072	4.608	9.216	18.432	Reserved	Reserved
128	1.024	2.048	3.072	4.096	6.144	12.288	24.576	Reserved	Reserved
192	1.536	3.072	4.608	6.144	9.216	18.432	Reserved	Reserved	Reserved
256	2.048	4.096	6.144	8.192	12.288	24.576	Reserved	Reserved	Reserved
384	3.072	6.144	9.216	12.288	18.432	Reserved	Reserved	Reserved	Reserved
512	4.096	8.192	12.288	16.384	24.576	Reserved	Reserved	Reserved	Reserved
1024	8.192	16.384	24.576	Reserved	Reserved	Reserved	Reserved	Reserved	Reserved
2048	16.384	Reserved	Reserved	Reserved	Reserved	Reserved	Reserved	Reserved	Reserved

表 8-7. Supported FSYNC (Multiples or Submultiples of 44.1 kHz) and BCLK Frequencies

BCLK TO FSYNC RATIO	BCLK (MHz)								
	FSYNC (7.35 kHz)	FSYNC (14.7 kHz)	FSYNC (22.05 kHz)	FSYNC (29.4 kHz)	FSYNC (44.1 kHz)	FSYNC (88.2 kHz)	FSYNC (176.4 kHz)	FSYNC (352.8 kHz)	FSYNC (705.6 kHz)
16	Reserved	Reserved	0.3528	0.4704	0.7056	1.4112	2.8224	5.6448	11.2896
24	Reserved	0.3528	0.5292	0.7056	1.0584	2.1168	4.2336	8.4672	16.9344
32	Reserved	0.4704	0.7056	0.9408	1.4112	2.8224	5.6448	11.2896	22.5792
48	0.3528	0.7056	1.0584	1.4112	2.1168	4.2336	8.4672	16.9344	Reserved
64	0.4704	0.9408	1.4112	1.8816	2.8224	5.6448	11.2896	22.5792	Reserved
96	0.7056	1.4112	2.1168	2.8224	4.2336	8.4672	16.9344	Reserved	Reserved
128	0.9408	1.8816	2.8224	3.7632	5.6448	11.2896	22.5792	Reserved	Reserved
192	1.4112	2.8224	4.2336	5.6448	8.4672	16.9344	Reserved	Reserved	Reserved
256	1.8816	3.7632	5.6448	7.5264	11.2896	22.5792	Reserved	Reserved	Reserved
384	2.8224	5.6448	8.4672	11.2896	16.9344	Reserved	Reserved	Reserved	Reserved
512	3.7632	7.5264	11.2896	15.0528	22.5792	Reserved	Reserved	Reserved	Reserved
1024	7.5264	15.0528	22.5792	Reserved	Reserved	Reserved	Reserved	Reserved	Reserved
2048	15.0528	Reserved	Reserved	Reserved	Reserved	Reserved	Reserved	Reserved	Reserved

The TAA5212 also supports non-Audio sample rates beyond those listed in prior tables. Refer to [Configuring Non-Audio Sample Rates for TAC5x1x devices](#) for more details.

The TAA5212 sample rate can be configured using registers CLK_DET0 (P0_R62) and CLK_DET1 (P0_R63) for primary and secondary ASI respectively. These registers also capture the device auto detect result for the

ADVANCE INFORMATION

FSYNC frequency in auto detection mode. The registers CLK_DET2 (P0_R64) and CLK_DET3 (P0_R65) capture the BCLK to FSYNC ratio detected of the device . If the device finds any unsupported combinations of FSYNC frequency and BCLK to FSYNC ratios, the device generates an ASI clock-error interrupt and mutes all the channels accordingly.

The TAA5212 also supports enabling channels while some ADC channels are already in operation. This requires a pre-configuration before power to describe maximum number of channels which can be enabled while in operation to ensure proper clock generation and use. This can be configured by using register DYN_PUPD_CFG (P0_R119). ADC_DYN_PUPD_EN bit can be used to enable ADC channels dynamic power up. Number of channels can be configured using ADC_DYN_MAXCH_SEL bit.

The device uses an integrated, low-jitter, phase-locked loop (PLL) to generate internal clocks required for the modulators and digital filter engine, as well as other control blocks. The device also supports an option to use BCLK, GPIOx, or the GPI1 pin (as CCLK) as the audio clock source without using the PLL to reduce power consumption. However, the ADC performance may degrade based on jitter from the external clock source, and some processing features may not be supported if the external audio clock source frequency is not high enough. Therefore, TI recommends using the PLL for high-performance applications. More details and information on how to configure and use the device in low-power mode without using the PLL are discussed in the [TAC5x1x Power Consumption Matrix Across Various Usage Scenarios application report](#).

The device also supports an audio bus controller mode operation using the GPIOx or GPI1 pin (as CCLK) as the reference input clock source and supports various flexible options and a wide variety of system clocks. More details and information on controller mode configuration and operation are discussed in the [Configuring and Operating TAC5x1x as an Audio Bus Controller application report](#).

The audio bus clock error detection and auto-detect feature automatically generates all internal clocks, but can be disabled using the IGNORE_CLK_ERR (P0_R4_D6) and CUSTOM_CLK_CFG (P0_R50_D0) register bits, respectively. In the system, this disable feature can be used to support custom clock frequencies that are not covered by the auto detect scheme. For such application use cases, care must be taken to ensure that the multiple clock dividers are all configured appropriately. Therefore, TI recommends using the PPC3 GUI for device configuration settings; for more details see the [TAC5212EVM-PDK Evaluation module user's guide](#) and the [PurePath™ console graphical development suite](#).

8.3.4 Input Channel Configurations

The device consists of two pairs of analog input pins (INxP and INxM) that can be configured as differential inputs or single-ended inputs for the recording channel. The device supports simultaneous recording of up to two channels using the high-performance multichannel ADC. The input source for the analog pins can be from electret condenser analog microphones, microelectrical-mechanical system (MEMS) analog microphones, or line-in (auxiliary) inputs from the system board. Analog inputs support differential input, single-ended inputs(two pin and one-pin) with AC and DC coupling options. Additionally, if the application uses digital PDM microphones for the recording, GPIO,GPI and GPO pins can be reconfigured in the device to support up to four channels for the digital microphone recording. TAA5212 supports incremental mode of ADC where analog input channels can be used for DC measurements. This can be configured by setting IADC_EN(P0_R81_D7). 表 8-8 shows the input source selection for the record channel.

表 8-8. Input Source Selection for the Record Channel

P0_R80_D[7:6] : ADC_CH1_INSRC[1:0]	INPUT CHANNEL 1 RECORD SOURCE SELECTION
00 (default)	Analog differential input for channel 1
01	Analog single-ended Input for channel 1 (Signal on one input pin and Ground on other pin)
10	Analog single-ended Input on IN1P
11	Analog single-ended Input on IN1M

Similarly, the input source selection setting for input channel 2 can be configured using the ADC_CH2_INSRC[1:0] (P0_R85_D[7:6]) register bits.

Typically, voice or audio signal inputs are capacitively coupled (AC-coupled) to the device; however, the device also supports an option for DC-coupled inputs to save board space. This configuration can be done independently for each channel by setting the input common mode tolerance in ADC_CH1_CM_TOL (P0_R60_D[3:2]), ADC_CH2_CM_TOL (P0_R85_D[3:2]) register bits. The INM pin can be directly grounded in Rail to Rail Common Mode (see [Figure 8-15](#)), but the INM pin must be grounded after the AC-coupling capacitor whenever ADC_CHx_INSRC is set to 2'b01 and ADC_CHx_CM_TOL is set to 2'b01 (see [Figure 8-16](#)) for the single-ended input configuration. For the best dynamic range performance, the differential AC-coupled input must be used.

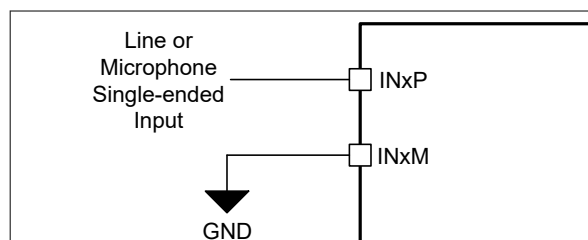

Figure 8-15. Single-Ended DC-Coupled Input Connection

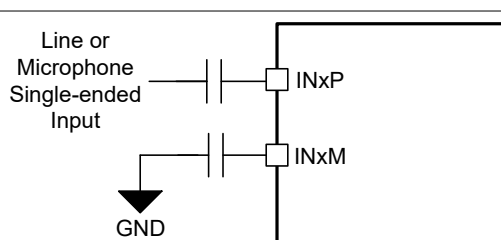

Figure 8-16. Single-Ended AC-Coupled Input Connection

The device allows for flexibility in choosing the typical input impedance on INxP or INxM from 5 k Ω (default), 10 k Ω , and 40 k Ω based on the input source impedance. The higher input impedance results in slightly higher noise or lower dynamic range. [Table 8-9](#) lists the configuration register settings for the input impedance for the record channel.

Table 8-9. Input Impedance Selection for the Record Channel

P0_R80_D[5:4] : ADC_CH1_IMP[1:0]	CHANNEL 1 INPUT IMPEDANCE SELECTION
00 (default)	Channel 1 input impedance typical value is 5 k Ω on INxP or INxM
01	Channel 1 input impedance typical value is 10 k Ω on INxP or INxM
10	Channel 1 input impedance typical value is 40 k Ω on INxP or INxM
11	Reserved (do not use this setting)

Similarly, the input impedance selection setting for input channel 2 can be configured using the ADC_CH2_IMP[1:0] (P0_R85_D[5:4]).

The value of the coupling capacitor in AC-coupled mode must be chosen so that the high-pass filter formed by the coupling capacitor and the input impedance do not affect the signal content. Before proper recording can begin, this coupling capacitor must be charged up to the common-mode voltage at power-up. To enable quick charging, the device has modes to speed up the charging of the coupling capacitor. The default value of the quick-charge timing is set for a coupling capacitor up to 1 μ F. However, if a higher-value capacitor is used in the system, then the quick-charging timing can be increased by using the INCAP_QCHG (P0_R5_D[7:6]) register bits. For best distortion performance, use the low-voltage coefficient capacitors for AC coupling.

8.3.5 Reference Voltage

All audio data converters require a DC reference voltage. The TAA5212 achieves low-noise performance by internally generating a low-noise reference voltage. This reference voltage is generated using a band-gap circuit with high PSRR performance. This audio converter reference voltage must be filtered externally using a minimum 1- μ F capacitor connected from the VREF pin to analog ground (VSS).

The value of this reference voltage can be configured using the P0_R77_D[1:0] register bits and must be set to an appropriate value based on the desired full-scale input for the device and the AVDD supply voltage available in the system. The default VREF value is set to 2.75 V, which in turn supports a 2- V_{RMS} differential full-scale input to the device. The required minimum AVDD voltage for this mode is 3 V. The TAA5212 also supports

double swing mode with $4-V_{RMS}$ differential swing which can be enabled by setting ADC_CHx_FULLSCALE_VAL to 1. 表 8-10 lists the various VREF settings supported along with required AVDD range and the supported full-scale input signal for that configuration.

表 8-10. VREF Programmable Settings

P0_R77_D[1:0] : VREF[1:0]	VREF OUTPUT VOLTAGE	DIFFERENTIAL FULL-SCALE INPUT SUPPORTED	SINGLE-ENDED FULL-SCALE INPUT SUPPORTED	AVDD RANGE REQUIREMENT
00 (default)	2.75 V	$2 V_{RMS}$ ($4 V_{RMS}$ supported in high swing mode)	$1 V_{RMS}$	3 V to 3.6 V
01	2.5 V	$1.818 V_{RMS}$	$0.909 V_{RMS}$	2.8 V to 3.6 V
10	1.375 V	$1 V_{RMS}$	$0.5 V_{RMS}$	1.7 V to 1.9 V
11	Reserved	Reserved	Reserved	Reserved

To achieve low-power consumption, this audio reference block is powered down as described in the セクション 8.4 section. When exiting sleep mode, the audio reference block is powered up using the internal fast-charge scheme and the VREF pin settles to its steady-state voltage after the settling time (a function of the decoupling capacitor on the VREF pin). This time is approximately equal to 3.5 ms when using a 1- μ F decoupling capacitor. If a higher-value decoupling capacitor is used on the VREF pin, the fast-charge setting must be reconfigured using the VREF_QCHG (P0_R2_D[4:3]) register bits, which support options of 3.5 ms (default), 10 ms, 50 ms, or 100 ms.

8.3.6 Programmable Microphone Bias

The device integrates a built-in, low-noise microphone bias pin that can be used in the system for biasing electret-condenser microphones or providing the supply to the MEMS analog or digital microphone. The integrated bias amplifier supports up to 10 mA of load current that can be used for multiple microphones and is designed to provide a combination of high PSRR, low noise, and programmable bias voltages to allow the biasing to be fine tuned for specific microphone combinations.

When using this MICBIAS pin for biasing or supplying to multiple microphones, avoid any common impedance on the board layout for the MICBIAS connection to minimize coupling across microphones. 表 8-11 shows the available microphone bias programmable options.

表 8-11. MICBIAS Programmable Settings

P0_R77_D[3:2] : MICBIAS_VAL[1:0]	P0_R77_D[1:0] : VREF_FSCALE[1:0]	MICBIAS OUTPUT VOLTAGE
00 (default)	00 (default)	2.75 V (same as the VREF output)
	01	2.5 V (same as the VREF output)
	10	1.375 V (same as the VREF output)
	11	Reserved (do not use these settings)
01	00 (default)	1.375 V (0.5 times the VREF output)
	01	1.250 V (0.5 times the VREF output)
	10 or 11	Reserved (do not use these settings)
10	XX	Reserved (do not use these settings)
11	XX	Same as AVDD

The microphone bias output can be powered on or powered off (default) by configuring the MICBIAS_PDZ, P0_R120_D5 register bit. Additionally, the device provides an option to configure the GPIO1 or GPIO pin to directly control the microphone bias output powering on or off. This feature is useful to control the microphone directly without engaging the host for I²C or SPI communication. The MICBIAS_PDZ, P0_R120_D5 register bit value is ignored if the GPIO1 or GPIO pin is configured to set the microphone bias on or off.

8.3.7 Signal-Chain Processing

The TAA5212 signal chain is comprised of very-low-noise, high-performance, and low-power analog blocks and highly flexible and programmable digital processing blocks. The high performance and flexibility combined with a compact package makes the TAA5212 optimized for a variety of end-equipments and applications that require multichannel audio capture and playback. [セクション 8.3.7.1](#) describe key components in ADC signal chain further.

8.3.7.1 ADC Signal-Chain

Figure 8-17 shows the key components of record path signal chain.

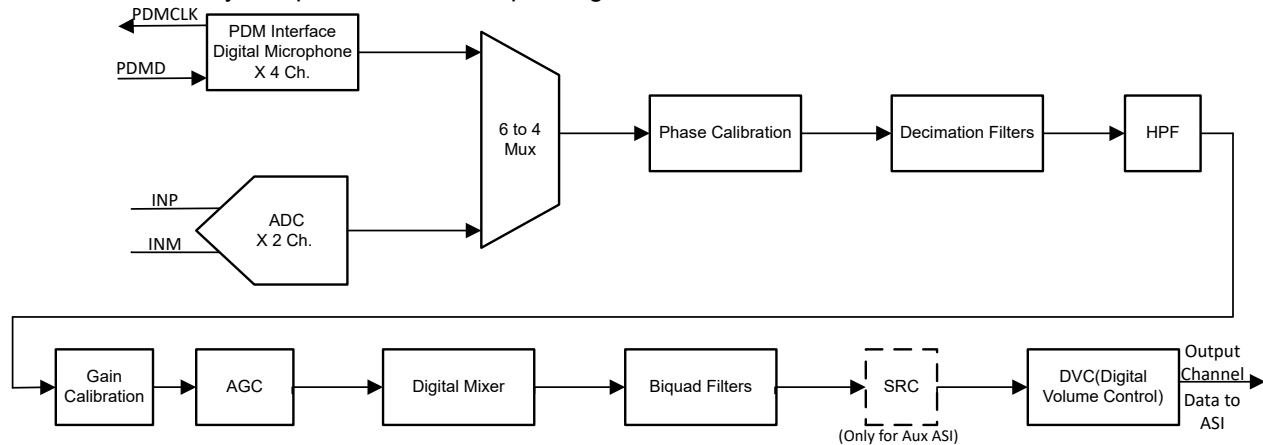

Figure 8-17. ADC Signal-Chain Processing Flowchart

The front-end ADC is very low noise, with a 115-dB dynamic range performance. This low-noise and low-distortion, multibit, delta-sigma ADC enables the TAA5212 to record a far-field audio signal with very high fidelity, both in quiet and loud environments. Moreover, the ADC architecture has inherent antialias filtering with a high rejection of out-of-band frequency noise around multiple modulator frequency components. Therefore, the device prevents noise from aliasing into the audio band during ADC sampling. Further on in the signal chain, an integrated, high-performance multistage digital decimation filter sharply cuts off any out-of-band frequency noise with high stop-band attenuation.

The device also has an integrated programmable biquad filter that allows for custom low-pass, high-pass, or any other desired frequency shaping. Thus, the overall signal chain architecture removes the requirement to add external components for antialiasing low-pass filtering, and thus saves drastically on the external system component cost and board space. See the [TAC5212 Integrated Analog Antialiasing Filter and Flexible Digital Filter application report](#) for further details.

The signal chain also consists of various highly programmable digital processing blocks such as phase calibration, gain calibration, high-pass filter, digital summer or mixer, biquad filters, synchronous sample rate converter and volume control. The details on these processing blocks are discussed further in this section. The device also supports up to four digital PDM microphone recording channels when the analog record channels are not used.

The desired input channels for recording can be enabled or disabled by using the CH_EN (P0_R118) register, and the output channels for the audio serial interface can be enabled or disabled by using the ASI_TX_CHx_CFG register. In general, the device supports simultaneous power-up and power-down of all active channels for simultaneous recording. However, based on the application needs, if some channels must be powered-up or powered-down dynamically when the other channel recording is on, then that use case is supported by setting the DYN_PUPD_CFG register.

The device supports an input signal bandwidth up to 100 kHz, which allows the high-frequency non-audio signal to be recorded by using a 216-kHz (or higher) sample rate. Wide bandwidth mode can be enabled or disabled by setting ADC_CHx_BW_MODE bit.

For sample rates of 48 kHz or lower, the device supports all features and various programmable processing blocks. However, for sample rates higher than 48 kHz, there are limitations in the number of simultaneous channel recording and playback supported and the number of biquad filters and such. See the [TAC5212 Sampling Rates and Programmable Processing Blocks Supported application report](#) for further details.

8.3.7.1.1 Programmable Channel Gain and Digital Volume Control

The device has an independent programmable channel gain setting for each input channel that can be set to the appropriate value based on the maximum input signal expected in the system and the ADC VREF setting used (see the [セクション 8.3.5](#) section), which determines the ADC full-scale signal level.

The device has a programmable digital volume control with a range from –80 dB to 47 dB in steps of 0.5 dB with the option to mute the channel recording. The digital volume control value can be changed dynamically while the ADC channel is powered-up and recording. During volume control changes, the soft ramp-up or ramp-down volume feature is used internally to avoid any audible artifacts. Soft-stepping can be entirely disabled using the ADC_DSP_DISABLE_SOFT_STEP (P0_R114_D1) register bit.

The digital volume control setting is independently available for each output channel, including the digital microphone record channel. However, the device also supports an option to gang-up the volume control setting for all channels together using the channel 1 digital volume control setting, regardless if channel 1 is powered up or powered down. This gang-up can be enabled using the ADC_DSP_DVOL_GANG (P0_R114_D0) register bit.

表 8-12 shows the programmable options available for the digital volume control.

表 8-12. Digital Volume Control (DVC) Programmable Settings

P0_R82_D[7:0] : ADC_CH1_DVOL[7:0]	DVC SETTING FOR OUTPUT CHANNEL 1
0000 0000 = 0d	Output channel 1 DVC is set to mute
0000 0001 = 1d	Output channel 1 DVC is set to –80 dB
0000 0010 = 2d	Output channel 1 DVC is set to –79.5 dB
0000 0011 = 3d	Output channel 1 DVC is set to –79 dB
...	...
1010 0000 = 160d	Output channel 1 DVC is set to –0.5 dB
1010 0001 = 161d (default)	Output channel 1 DVC is set to 0 dB
1010 0010 = 162d	Output channel 1 DVC is set to 0.5 dB
...	...
1111 1101 = 253d	Output channel 1 DVC is set to 46 dB
1111 1110 = 254d	Output channel 1 DVC is set to 46.5 dB
1111 1111 = 255d	Output channel 1 DVC is set to 47 dB

Similarly, the digital volume control setting for output channel 2 to channel 4 can be configured using the CH2_DVOL (P0_R87) to CH4_DVOL (P0_R95) register bits, respectively.

The internal digital processing engine soft ramps up the volume from a muted level to the programmed volume level when the channel is powered up, and the internal digital processing engine soft ramps down the volume from a programmed volume to mute when the channel is powered down. This soft-stepping of volume is done to prevent abruptly powering up and powering down the record channel. This feature can also be entirely disabled using the ADC_DSP_DISABLE_SOFT_STEP (P0_R114_D1) register bit.

8.3.7.1.2 Programmable Channel Gain Calibration

Along with the digital volume control, this device also provides programmable channel gain calibration. The gain of each channel can be finely calibrated or adjusted in steps of 0.1 dB for a range of –0.8-dB to 0.7-dB gain error. This adjustment is useful when trying to match the gain across channels resulting from external components and microphone sensitivity. This feature, in combination with the regular digital volume control, allows the gains across all channels to be matched for a wide gain error range with a resolution of 0.1 dB. 表 8-13 shows the programmable options available for the channel gain calibration.

表 8-13. Channel Gain Calibration Programmable Settings

P0_R83_D[7:4] : ADC_CH1_FGAIN[3:0]	CHANNEL GAIN CALIBRATION SETTING FOR INPUT CHANNEL 1
0000 = 0d	Input channel 1 gain calibration is set to –0.8 dB

表 8-13. Channel Gain Calibration Programmable Settings (続き)

P0_R83_D[7:4] : ADC_CH1_FGAIN[3:0]	CHANNEL GAIN CALIBRATION SETTING FOR INPUT CHANNEL 1
0001 = 1d	Input channel 1 gain calibration is set to -0.7 dB
...	...
1000 = 8d (default)	Input channel 1 gain calibration is set to 0 dB
...	...
1110 = 14d	Input channel 1 gain calibration is set to 0.6 dB
1111 = 15d	Input channel 1 gain calibration is set to 0.7 dB

Similarly, the channel gain calibration setting for input channel 2 to channel 4 can be configured using the ADC_CH2_CFG3 (P0_R88) to ADC_CH4_CFG3 (P0_R96) register bits, respectively.

8.3.7.1.3 Programmable Channel Phase Calibration

In addition to the gain calibration, the phase delay in each channel can be finely calibrated or adjusted in steps of one modulator clock cycle for a cycle range of 0 to 255 for the phase error. The modulator clock, the same clock used for ADC_MOD_CLK, is 6.144 MHz (the output data sample rate is multiples or submultiples of 48 kHz) or 5.6448 MHz (the output data sample rate is multiples or submultiples of 44.1 kHz) irrespective of the analog microphone or digital microphone use case. This feature is very useful for many applications that must match the phase with fine resolution between each channel, including any phase mismatch across channels resulting from external components or microphones. 表 8-14 shows the available programmable options for channel phase calibration.

表 8-14. Channel Phase Calibration Programmable Settings

P0_R64_D[7:0] : CH1_PCAL[7:0]	CHANNEL PHASE CALIBRATION SETTING FOR INPUT CHANNEL 1
0000 0000 = 0d (default)	Input channel 1 phase calibration with no delay
0000 0001 = 1d	Input channel 1 phase calibration delay is set to one cycle of the modulator clock
0000 0010 = 2d	Input channel 1 phase calibration delay is set to two cycles of the modulator clock
...	...
1111 1110 = 254d	Input channel 1 phase calibration delay is set to 254 cycles of the modulator clock
1111 1111 = 255d	Input channel 1 phase calibration delay is set to 255 cycles of the modulator clock

Similarly, the channel phase calibration setting for input channel 2 to channel 8 can be configured using the CH2_PCAL (P0_R69) to CH8_PCAL (P0_R99) register bits, respectively.

The phase calibration feature must not be used when the analog input and PDM input are used together for simultaneous conversion.

8.3.7.1.4 Programmable Digital High-Pass Filter

To remove the DC offset component and attenuate the undesired low-frequency noise content in the record data, the device supports a programmable high-pass filter (HPF). The HPF is not a channel-independent filter setting but is globally applicable for all ADC channels. This HPF is constructed using the first-order infinite impulse response (IIR) filter, and is efficient enough to filter out possible DC components of the signal. 表 8-15 shows the predefined -3-dB cutoff frequencies available that can be set by using the ADC_DSP_HPF_SEL[1:0] register bits of P0_R114. Additionally, to achieve a custom -3-dB cutoff frequency for a specific application, the device also allows the first-order IIR filter coefficients to be programmed when the HPF_SEL[1:0] register bits are set to 2'b00. 図 8-18 illustrates a frequency response plot for the HPF filter.

表 8-15. HPF Programmable Settings

P0_R107_D[1:0] : HPF_SEL[1:0]	-3-dB CUTOFF FREQUENCY SETTING	-3-dB CUTOFF FREQUENCY AT 16-kHz SAMPLE RATE	-3-dB CUTOFF FREQUENCY AT 48-kHz SAMPLE RATE
00	Programmable 1st-order IIR filter	Programmable 1st-order IIR filter	Programmable 1st-order IIR filter
01 (default)	$0.00002 \times f_s$	0.25 Hz	1 Hz

表 8-15. HPF Programmable Settings (続き)

P0_R107_D[1:0] : HPF_SEL[1:0]	-3-dB CUTOFF FREQUENCY SETTING	-3-dB CUTOFF FREQUENCY AT 16-kHz SAMPLE RATE	-3-dB CUTOFF FREQUENCY AT 48-kHz SAMPLE RATE
10	$0.00025 \times f_s$	4 Hz	12 Hz
11	$0.002 \times f_s$	32 Hz	96 Hz



図 8-18. HPF Filter Frequency Response Plot

D003

式 1 gives the transfer function for the first-order programmable IIR filter:

$$H(z) = \frac{N_0 + N_1 z^{-1}}{2^{31} - D_1 z^{-1}} \quad (1)$$

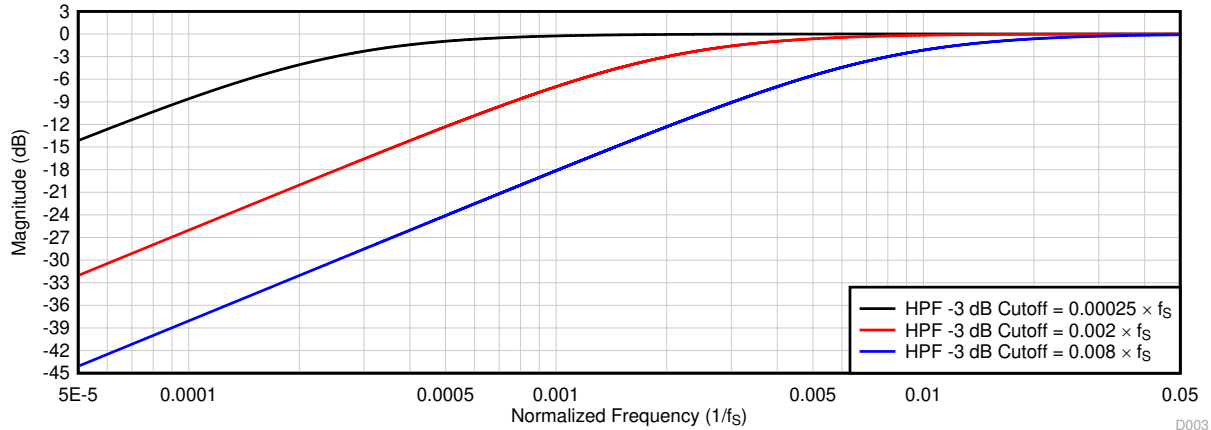
The frequency response for this first-order programmable IIR filter with default coefficients is flat at a gain of 0 dB (all-pass filter). The host device can override the frequency response by programming the IIR coefficients in 表 8-16 to achieve the desired frequency response for high-pass filtering or any other desired filtering. If HPF_SEL[1:0] are set to 2'b00, the host device must write these coefficients values for the desired frequency response before powering-up any ADC channel for recording. 表 8-16 shows the filter coefficients for the first-order IIR filter.

表 8-16. 1st-Order IIR Filter Coefficients

FILTER	FILTER COEFFICIENT	DEFAULT COEFFICIENT VALUE	COEFFICIENT REGISTER MAPPING
Programmable 1st-order IIR filter (can be allocated to HPF or any other desired filter)	N_0	0x7FFFFFFF	P4_R72-R75
	N_1	0x00000000	P4_R76-R79
	D_1	0x00000000	P4_R80-R83

8.3.7.1.5 Programmable Digital Biquad Filters

The device supports up to 12 programmable digital biquad filters available for ADC signal chain limited to 3/ channel. These highly efficient filters achieve the desired frequency response. The TAA5212 also supports on the fly programmable Biquad filters for two channel record use case. In digital signal processing, a digital biquad filter is a second-order, recursive linear filter with two poles and two zeros. 式 2 gives the transfer function of each biquad filter:

$$H(z) = \frac{N_0 + 2N_1z^{-1} + N_2z^{-2}}{2^{31} - 2D_1z^{-1} - D_2z^{-2}} \quad (2)$$

The frequency response for the biquad filter section with default coefficients is flat at a gain of 0 dB (all-pass filter). The host device can override the frequency response by programming the biquad coefficients to achieve the desired frequency response for a low-pass, high-pass, or any other desired frequency shaping. The programmable coefficients for the mixer operation are located in the *Programmable Coefficient Registers: Page = 0x02* and *Programmable Coefficient Registers: Page = 0x03* sections. If biquad filtering is required, then the host device must write these coefficients values before powering up any ADC channels for recording. In two channel use case, the TAA5212 also supports on the fly programmable filters. In this case, Device uses two banks of filters for one channel with a switch bit to perform the switch from one filter bank to the other. As described in 表 8-17, these biquad filters can be allocated for each output channel based on the ADC_DSP_BQ_CFG[1:0] register setting of P0_R114. By setting BIQUAD_CFG[1:0] to 2'b00, the biquad filtering for all record channels is disabled and the host device can choose this setting if no additional filtering is required for the system application. See the [TAC5212 Programmable Biquad Filter Configuration and Applications application report](#) for further details.

表 8-17. Biquad Filter Allocation to the Record Output Channel

PROGRAMMABLE BIQUAD FILTER	RECORD OUTPUT CHANNEL ALLOCATION USING P0_R114_D[3:2] REGISTER SETTING		
	ADC_DSP_BQ_CFG[1:0] = 2'b01 (1 Biquad per Channel)	ADC_DSP_BQ_CFG[1:0] = 2'b10 (Default) (2 Biquads per Channel)	ADC_DSP_BQ_CFG[1:0] = 2'b11 (3 Biquads per Channel)
Biquad filter 1	Allocated to output channel 1	Allocated to output channel 1	Allocated to output channel 1
Biquad filter 2	Allocated to output channel 2	Allocated to output channel 2	Allocated to output channel 2
Biquad filter 3	Allocated to output channel 3	Allocated to output channel 3	Allocated to output channel 3
Biquad filter 4	Allocated to output channel 4	Allocated to output channel 4	Allocated to output channel 4
Biquad filter 5	Not used	Allocated to output channel 1	Allocated to output channel 1
Biquad filter 6	Not used	Allocated to output channel 2	Allocated to output channel 2
Biquad filter 7	Not used	Allocated to output channel 3	Allocated to output channel 3
Biquad filter 8	Not used	Allocated to output channel 4	Allocated to output channel 4
Biquad filter 9	Not used	Not used	Allocated to output channel 1
Biquad filter 10	Not used	Not used	Allocated to output channel 2
Biquad filter 11	Not used	Not used	Allocated to output channel 3
Biquad filter 12	Not used	Not used	Allocated to output channel 4

表 8-18 shows the biquad filter coefficients mapping to the register space.

表 8-18. Biquad Filter Coefficients Register Mapping

PROGRAMMABLE BIQUAD FILTER	BIQUAD FILTER COEFFICIENTS REGISTER MAPPING	PROGRAMMABLE BIQUAD FILTER	BIQUAD FILTER COEFFICIENTS REGISTER MAPPING
Biquad filter 1	P8_R8-R27	Biquad filter 7	P9_R8-R27
Biquad filter 2	P8_R28-R47	Biquad filter 8	P9_R28-R47
Biquad filter 3	P8_R48-R67	Biquad filter 9	P9_R48-R67
Biquad filter 4	P8_R68-R87	Biquad filter 10	P9_R68-R87
Biquad filter 5	P8_R88-R107	Biquad filter 11	P9_R88-R107
Biquad filter 6	P8_R108-R127	Biquad filter 12	P9_R108-R127

8.3.7.1.6 Programmable Channel Summer and Digital Mixer

For applications that require an even higher SNR than that supported for each channel, the device digital summing mode can be used. In this mode, the digital record data are summed up across the channel with an equal weightage factor, which helps in reducing the effective record noise.

The device supports a fully programmable mixer feature that can mix the various input channels with their custom programmable scale factor to generate the final output channels.  8-19 shows a block diagram that describes the mixer 1 operation to generate output channel 1.

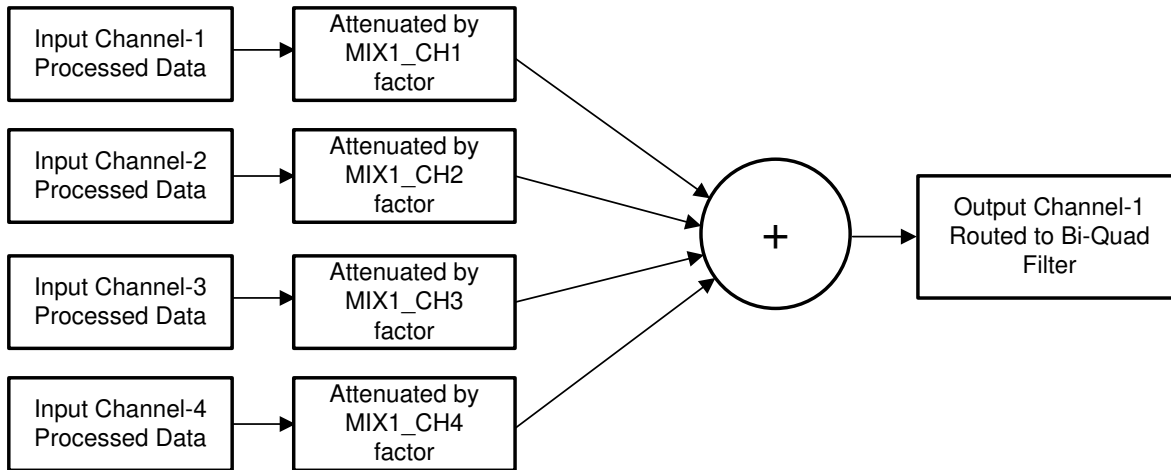

 8-19. Programmable Digital Mixer Block Diagram

A similar mixer operation is performed by mixer 2, mixer 3, and mixer 4 to generate output channel 2, channel 3, and channel 4, respectively.

8.3.7.1.7 Configurable Digital Decimation Filters

The device record channel includes a high dynamic range, built-in digital decimation filter to process the oversampled data from the multibit delta-sigma ($\Delta\Sigma$) modulator to generate digital data at the same Nyquist sampling rate as the FSYNC rate. The decimation filters in the device have Linear Phase response making them suitable for a wide variety of Audio applications.

8.3.7.1.7.1 Linear Phase Filters

The linear phase decimation filters are the default filters set by the device and can be used for all applications that require a perfect linear phase with zero-phase deviation within the pass-band specification of the filter. The filter performance specifications and various plots for all supported output sampling rates are listed in this section.

8.3.7.1.7.1.1 Sampling Rate: 16 kHz or 14.7 kHz

図 8-20 and 図 8-21 respectively show the magnitude response and the pass-band ripple for a decimation filter with a sampling rate of 16 kHz or 14.7 kHz. 表 8-19 lists the specifications for a decimation filter with a 16-kHz or 14.7-kHz sampling rate.



表 8-19. Linear Phase Decimation Filter Specifications

PARAMETER	TEST CONDITIONS	MIN	TYP	MAX	UNIT
Pass-band ripple	Frequency range is 0 to $0.454 \times f_s$	-0.05		0.05	dB
Stop-band attenuation	Frequency range is $0.6 \times f_s$ to $4 \times f_s$	80.2			dB
	Frequency range is $4 \times f_s$ onwards	84.7			
Group delay or latency	Frequency range is 0 to $0.454 \times f_s$		16.1		$1/f_s$

8.3.7.1.7.1.2 Sampling Rate: 24 kHz or 22.05 kHz

図 8-22 and 図 8-23 respectively show the magnitude response and the pass-band ripple for a decimation filter with a sampling rate of 24 kHz or 22.05 kHz. 表 8-20 lists the specifications for a decimation filter with an 24-kHz or 22.05-kHz sampling rate.

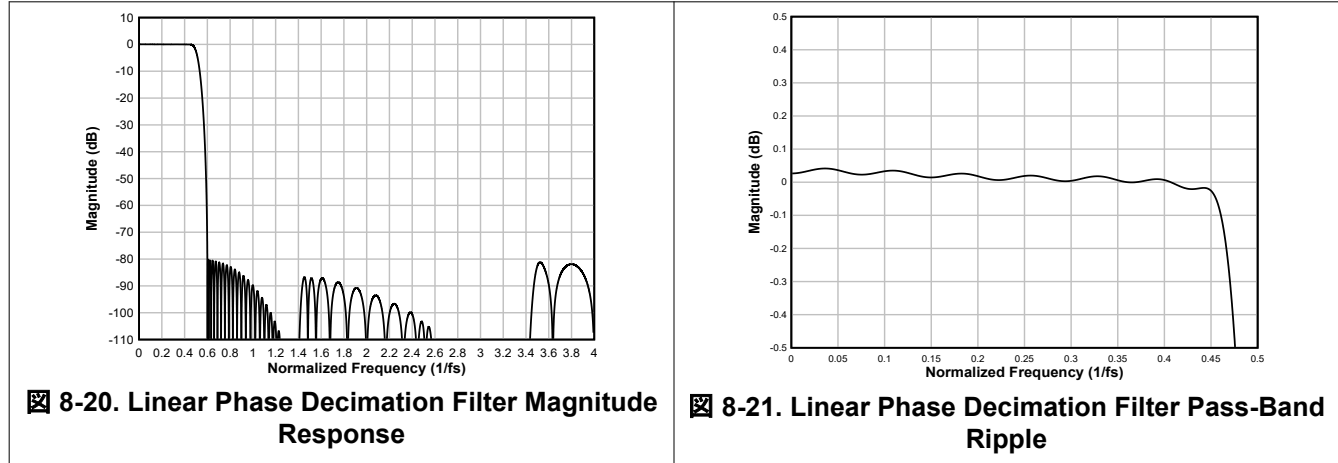

表 8-20. Linear Phase Decimation Filter Specifications

PARAMETER	TEST CONDITIONS	MIN	TYP	MAX	UNIT
Pass-band ripple	Frequency range is 0 to $0.454 \times f_s$	-0.05		0.05	dB

表 8-20. Linear Phase Decimation Filter Specifications (続き)

PARAMETER	TEST CONDITIONS	MIN	TYP	MAX	UNIT
Stop-band attenuation	Frequency range is $0.6 \times f_s$ to $4 \times f_s$	80.6			dB
	Frequency range is $4 \times f_s$ onwards	92.9			
Group delay or latency	Frequency range is 0 to $0.454 \times f_s$		14.7		$1/f_s$

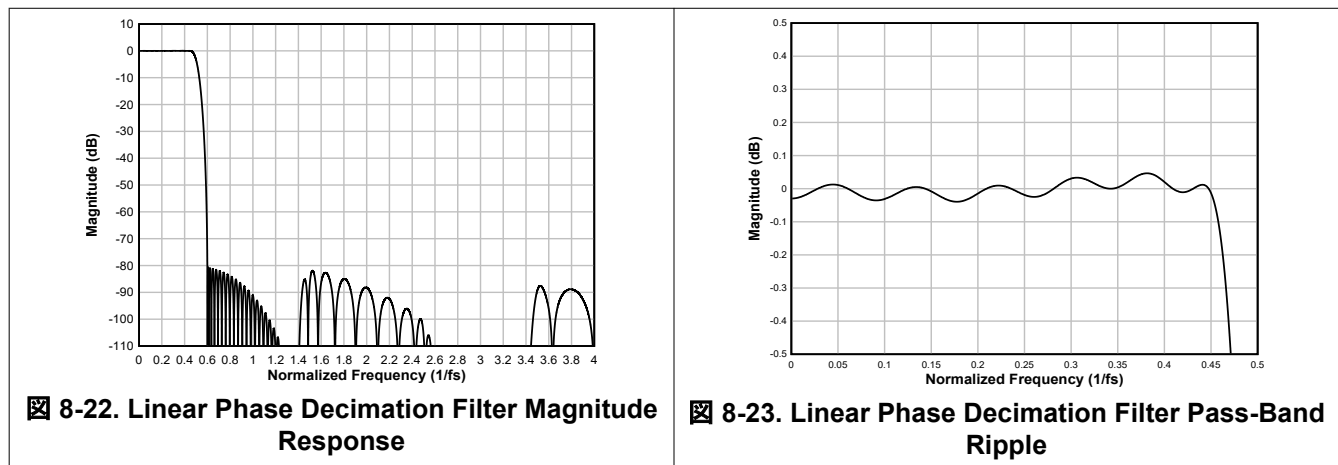
8.3.7.1.7.1.3 Sampling Rate: 32 kHz or 29.4 kHz

図 8-24 and 図 8-25 respectively show the magnitude response and the pass-band ripple for a decimation filter with a sampling rate of 32 kHz or 29.4 kHz. 表 8-21 lists the specifications for a decimation filter with an 32-kHz or 29.4-kHz sampling rate.



表 8-21. Linear Phase Decimation Filter Specifications

PARAMETER	TEST CONDITIONS	MIN	TYP	MAX	UNIT
Pass-band ripple	Frequency range is 0 to $0.454 \times f_s$	-0.05		0.05	dB
Stop-band attenuation	Frequency range is $0.6 \times f_s$ to $4 \times f_s$	80.6			
	Frequency range is $4 \times f_s$ onwards	92.9			
Group delay or latency	Frequency range is 0 to $0.454 \times f_s$		14.7		$1/f_s$

8.3.7.1.7.1.4 Sampling Rate: 48 kHz or 44.1 kHz

図 8-26 and 図 8-27 respectively show the magnitude response and the pass-band ripple for a decimation filter with a sampling rate of 48 kHz or 44.1 kHz. 表 8-22 lists the specifications for a decimation filter with an 48-kHz or 44.1-kHz sampling rate.

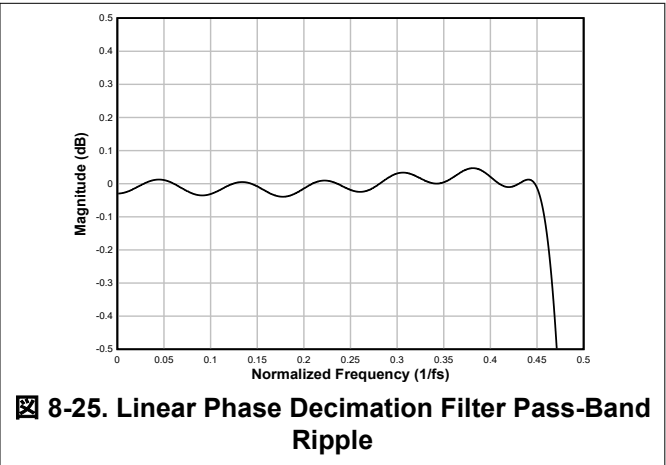
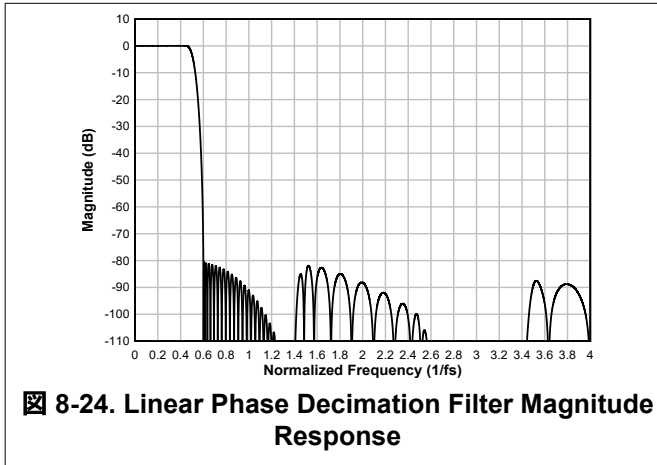

图 8-26. Linear Phase Decimation Filter Magnitude Response



图 8-27. Linear Phase Decimation Filter Pass-Band Ripple

表 8-22. Linear Phase Decimation Filter Specifications

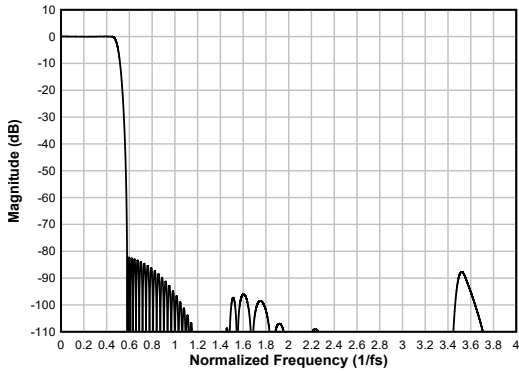
PARAMETER	TEST CONDITIONS	MIN	TYP	MAX	UNIT
Pass-band ripple	Frequency range is 0 to $0.454 \times f_s$	-0.052		0.05	dB
Stop-band attenuation	Frequency range is $0.58 \times f_s$ to $4 \times f_s$	82.2			
	Frequency range is $4 \times f_s$ onwards	97.9			
Group delay or latency	Frequency range is 0 to $0.454 \times f_s$		17.0		$1/f_s$

8.3.7.1.7.1.5 Sampling Rate: 96 kHz or 88.2 kHz

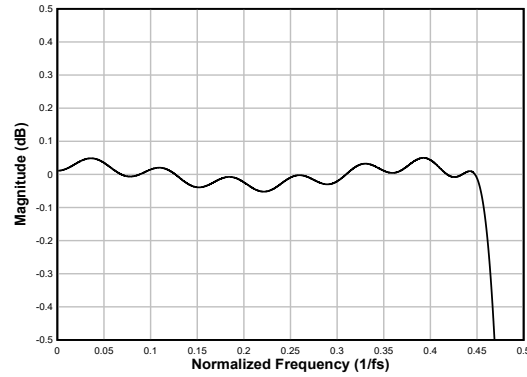
图 8-28 and 图 8-29 respectively show the magnitude response and the pass-band ripple for a decimation filter with a sampling rate of 96 kHz or 88.2 kHz. 表 8-23 lists the specifications for a decimation filter with an 96-kHz or 88.2-kHz sampling rate.



图 8-28. Linear Phase Decimation Filter Magnitude Response



图 8-29. Linear Phase Decimation Filter Pass-Band Ripple

表 8-23. Linear Phase Decimation Filter Specifications

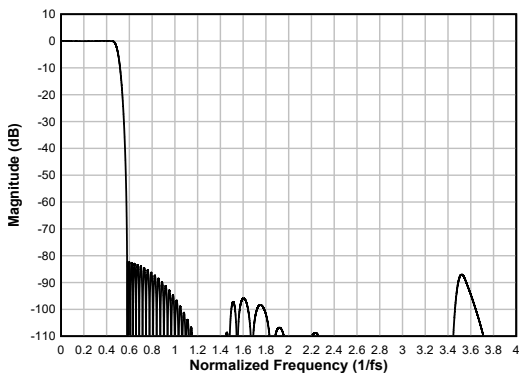
PARAMETER	TEST CONDITIONS	MIN	TYP	MAX	UNIT
Pass-band ripple	Frequency range is 0 to $0.454 \times f_s$	-0.05		0.058	dB
Stop-band attenuation	Frequency range is $0.58 \times f_s$ to $4 \times f_s$	82.2			
	Frequency range is $4 \times f_s$ onwards	96.9			
Group delay or latency	Frequency range is 0 to $0.454 \times f_s$		16.9		$1/f_s$

8.3.8 Interrupts, Status, and Digital I/O Pin Multiplexing

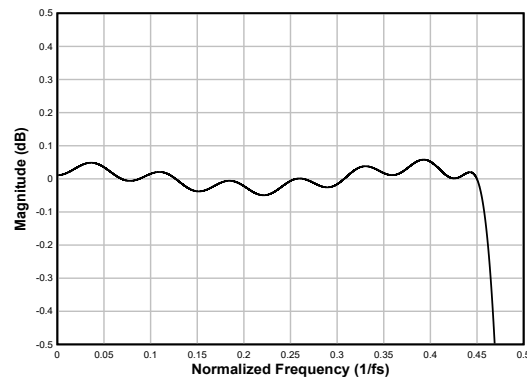
Certain events in the device may require host processor intervention and can be used to trigger interrupts to the host processor. One such event is an audio serial interface (ASI) bus error. The device powers down the record channels if any faults are detected with the ASI bus error clocks, such as:

- Invalid FSYNC frequency
- Invalid SBCLK to FSYNC ratio
- Long pauses of the SBCLK or FSYNC clocks

When an ASI bus clock error is detected, the device shuts down all the record and playback channels as quickly as possible. After all ASI bus clock errors are resolved, the device volume ramps back to its previous state to recover the audio. During an ASI bus clock error, the internal interrupt request (IRQ) interrupt signal asserts low if the clock error interrupt mask register bit INT_MASK0[7] (P1_R47_D7) is set low. The clock fault is also available for readback in the latched fault status register bit INT_LTCH0 (P1_R52), which is a read-only register. Reading the latched fault status register, INT_LTCH0, clears all latched fault status. The device can be additionally configured to route the internal IRQ interrupt signal on the GPIOx or GPO1 pins and also can be configured as open-drain outputs so that these pins can be wire-ANDed to the open-drain interrupt outputs of other devices.

The IRQ interrupt signal can either be configured as active low or active high polarity by setting the INT_POL (P0_R66_D7) register bit. This signal can also be configured as a single pulse or a series of pulses by programming the INT_EVENT[1:0] (P0_R66_D[6:5]) register bits. If the interrupts are configured as a series of pulses, the events trigger the start of pulses that stop when the latched fault status register is read to determine the cause of the interrupt.

The device also supports read-only live-status registers to determine if the channels are powered up or down and if the device is in sleep mode or not. These status registers are located in the DEV_STS0 (P0_R121) and DEV_STS1 (P0_R122) register bits.

The device has a multifunctional GPIO1 pin that can be configured for a desired specific function. 表 8-24 lists all possible allocations of these multifunctional pins for the various features.

表 8-24. Multifunction Pin Assignments

ROW	PIN FUNCTION	GPIO1	GPIO2	GPO1	GPI1
—	—	GPIO1_CFG	GPO2_CFG	GPO1_CFG	GPI1_CFG
—	—	P0_R10[7:4]	P0_R11[7:4]	P0_R12[7:4]	P0_R13[1]
A	Pin disabled	S ⁽¹⁾	S (default)	S (default)	S (default)
B	General-purpose output (GPO)	S	S	S	NS
C	Interrupt output (IRQ)	S (default)	S	S	NS
D	Power down for all ADC channels	S	S	NS	S
E	PDM clock output (PDMCLK)	S	S	S	NS
F	MiCBias on/off input (BIASEN)	S	S	NS	S
G	General-purpose input (GPI)	S	S	NS	S
H	Controller clock input (CCLK)	S	S	S	S
I	ASI daisy-chain input	S	S	NS	S
J	PDM data input 1 (PDMIN1)	S	S	NS	S
K	PDM data input 2 (PDMIN2)	S	S	NS	S
L	ASI DOUT	S	S	S	NS
M	ASI BCLK	S	S	S	S
N	ASI FSYNC	S	S	S	S
O	General Purpose Clock Out	S	S	S	NS
P	Incremental ADC Conversion Start	S	S	NS	S

(1) S means the feature mentioned in this row is *supported* for the respective GPIO1, GPOx, or GPIx pin mentioned in this column.

Each GPOx or GPIOx pin can be independently set for the desired drive configurations setting using the GPIOx_DRV[2:0] or GPO1_DRV[2:0] register bits. 表 8-25 lists the drive configuration settings.

表 8-25. GPIO or GPOx Pins Drive Configuration Settings

P0_R10_D[2:0] : GPIO1_DRV[2:0]	GPIO OUTPUT DRIVE CONFIGURATION SETTINGS FOR GPIO1
000	The GPIO1 pin is set to high impedance (floated)
001	The GPIO1 pin is set to be driven active low or active high
010 (default)	The GPIO1 pin is set to be driven active low or weak high (on-chip pullup)
011	The GPIO1 pin is set to be driven active low or Hi-Z (floated)
100	The GPIO1 pin is set to be driven weak low (on-chip pulldown) or active high
101	The GPIO1 pin is set to be driven Hi-Z (floated) or active high
110 and 111	Reserved (do not use these settings)

Similarly, the GPO1 pin can be configured using the GPO1_DRV(P0_R12) register bits.

When configured as a general-purpose output (GPO), the GPIOx or GPO1 pin values can be driven by writing the GPO_GPI_VAL (P0_R14) registers. The GPIO_MON bits (P0_R14_D[3:1]) can be used to readback the status of the GPIOx or GPI1 pin when configured as a general-purpose input (GPI).

8.3.9 Programmable Channel Phase Calibration

In addition to the gain calibration, the phase delay in each channel can be finely calibrated or adjusted in steps of one modulator clock cycle for a cycle range of 0 to 255 for the phase error. The modulator clock, the same clock used for ADC_MOD_CLK, is 6.144 MHz (the output data sample rate is multiples or submultiples of 48 kHz) or 5.6448 MHz (the output data sample rate is multiples or submultiples of 44.1 kHz) irrespective of the analog microphone or digital microphone use case. This feature is very useful for many applications that must match the phase with fine resolution between each channel, including any phase mismatch across channels resulting from external components or microphones. 表 8-26 shows the available programmable options for channel phase calibration.

表 8-26. Channel Phase Calibration Programmable Settings

P0_R64_D[7:0] : CH1_PCAL[7:0]	CHANNEL PHASE CALIBRATION SETTING FOR INPUT CHANNEL 1
0000 0000 = 0d (default)	Input channel 1 phase calibration with no delay

表 8-26. Channel Phase Calibration Programmable Settings (続き)

P0_R64_D[7:0] : CH1_PCAL[7:0]	CHANNEL PHASE CALIBRATION SETTING FOR INPUT CHANNEL 1
0000 0001 = 1d	Input channel 1 phase calibration delay is set to one cycle of the modulator clock
0000 0010 = 2d	Input channel 1 phase calibration delay is set to two cycles of the modulator clock
...	...
1111 1110 = 254d	Input channel 1 phase calibration delay is set to 254 cycles of the modulator clock
1111 1111 = 255d	Input channel 1 phase calibration delay is set to 255 cycles of the modulator clock

Similarly, the channel phase calibration setting for input channel 2 to channel 8 can be configured using the CH2_PCAL (P0_R69) to CH8_PCAL (P0_R99) register bits, respectively.

The phase calibration feature must not be used when the analog input and PDM input are used together for simultaneous conversion.

8.4 Device Functional Modes

8.5 Register Maps

This section describes the control registers for the device in detail. All these registers are eight bits in width and allocated to device configuration and programmable coefficients settings. These registers are mapped internally using a page scheme that can be controlled using either I²C or SPI communication to the device. Each page contains 128 bytes of registers. All device configuration registers are stored in page 0, page 1 and page 3. Page 0 is the default page setting at power up (and after a software reset). The device current page can be switch to a new desired page by using the PAGE[7:0] bits located in register 0 of every page.

Do not read from or write to reserved pages or reserved registers. Write only default values for the reserved bits in the valid registers.

The procedure for register access across pages is:

- Select page N (write data *N* to register 0 regardless of the current page number)
- Read or write data from or to valid registers in page N
- Select the new page M (write data *M* to register 0 regardless of the current page number)
- Read or write data from or to valid registers in page M
- Repeat as needed

8.5.1 VEGA Registers

表 8-27 lists the memory-mapped registers for the VEGA registers. All register offset addresses not listed in 表 8-27 should be considered as reserved locations and the register contents should not be modified.

表 8-27. VEGA Registers

Address	Acronym	Register Name	Reset Value	Section
0x0	PAGE_CFG	Device page register	0x00	PAGE_CFG Register (Address = 0x0) [Reset = 0x00]
0x1	SW_RESET	Software reset register	0x00	SW_RESET Register (Address = 0x1) [Reset = 0x00]
0x2	VREF_CFG		0x00	VREF_CFG Register (Address = 0x2) [Reset = 0x00]
0x3	AVDD_IOVDD_STS		0x00	AVDD_IOVDD_STS Register (Address = 0x3) [Reset = 0x00]
0x4	MISC_CFG		0x00	MISC_CFG Register (Address = 0x4) [Reset = 0x00]
0x5	MISC_CFG1		0x15	MISC_CFG1 Register (Address = 0x5) [Reset = 0x15]
0x7	MISC_CFG0	Misc. configuration register	0x00	MISC_CFG0 Register (Address = 0x7) [Reset = 0x00]
0xA	GPIO1_CFG0	GPIO1 configuration register 0	0x32	GPIO1_CFG0 Register (Address = 0xA) [Reset = 0x32]
0xB	GPIO2_CFG0	GPIO2 configuration register 0	0x00	GPIO2_CFG0 Register (Address = 0xB) [Reset = 0x00]
0xC	GPO1_CFG0	GPO1 configuration register 0	0x00	GPO1_CFG0 Register (Address = 0xC) [Reset = 0x00]
0xD	GPI_CFG	GPI1 configuration register 0	0x00	GPI_CFG Register (Address = 0xD) [Reset = 0x00]
0xE	GPO_GPI_VAL	GPIO, GPO output value register	0x00	GPO_GPI_VAL Register (Address = 0xE) [Reset = 0x00]
0xF	INTF_CFG0	Interface configuration register 0	0x00	INTF_CFG0 Register (Address = 0xF) [Reset = 0x00]
0x10	INTF_CFG1	Interface configuration register 1	0x52	INTF_CFG1 Register (Address = 0x10) [Reset = 0x52]
0x11	INTF_CFG2	Interface configuration register 2	0x80	INTF_CFG2 Register (Address = 0x11) [Reset = 0x80]
0x12	INTF_CFG3	Interface configuration register 3	0x00	INTF_CFG3 Register (Address = 0x12) [Reset = 0x00]
0x13	INTF_CFG4	Interface configuration register 3	0x00	INTF_CFG4 Register (Address = 0x13) [Reset = 0x00]

表 8-27. VEGA Registers (続き)

Address	Acronym	Register Name	Reset Value	Section
0x14	INTF_CFG5	Interface configuration register 4	0x00	INTF_CFG5 Register (Address = 0x14) [Reset = 0x00]
0x15	INTF_CFG6	Interface configuration register 5	0x00	INTF_CFG6 Register (Address = 0x15) [Reset = 0x00]
0x18	ASI_CFG0	ASI configuration register 0	0x40	ASI_CFG0 Register (Address = 0x18) [Reset = 0x40]
0x19	ASI_CFG1	ASI configuration register 1	0x00	ASI_CFG1 Register (Address = 0x19) [Reset = 0x00]
0x1A	PASI_CFG0	Primary ASI configuration register 0	0x30	PASI_CFG0 Register (Address = 0x1A) [Reset = 0x30]
0x1B	PASI_TX_CFG0	PASI TX configuration register 0	0x00	PASI_TX_CFG0 Register (Address = 0x1B) [Reset = 0x00]
0x1C	PASI_TX_CFG1	PASI TX configuration register 1	0x00	PASI_TX_CFG1 Register (Address = 0x1C) [Reset = 0x00]
0x1D	PASI_TX_CFG2	PASI TX configuration register 2	0x00	PASI_TX_CFG2 Register (Address = 0x1D) [Reset = 0x00]
0x1E	PASI_TX_CH1_CFG	PASI TX Channel 1 configuration register	0x20	PASI_TX_CH1_CFG Register (Address = 0x1E) [Reset = 0x20]
0x1F	PASI_TX_CH2_CFG	PASI TX Channel 2 configuration register	0x21	PASI_TX_CH2_CFG Register (Address = 0x1F) [Reset = 0x21]
0x20	PASI_TX_CH3_CFG	PASI TX Channel 3 configuration register	0x02	PASI_TX_CH3_CFG Register (Address = 0x20) [Reset = 0x02]
0x21	PASI_TX_CH4_CFG	PASI TX Channel 4 configuration register	0x03	PASI_TX_CH4_CFG Register (Address = 0x21) [Reset = 0x03]
0x22	PASI_TX_CH5_CFG	PASI TX Channel 5 configuration register	0x04	PASI_TX_CH5_CFG Register (Address = 0x22) [Reset = 0x04]
0x23	PASI_TX_CH6_CFG	PASI TX Channel 6 configuration register	0x05	PASI_TX_CH6_CFG Register (Address = 0x23) [Reset = 0x05]
0x24	PASI_TX_CH7_CFG	PASI TX Channel 7 configuration register	0x06	PASI_TX_CH7_CFG Register (Address = 0x24) [Reset = 0x06]
0x26	PASI_RX_CFG0	PASI RX configuration register 0	0x00	PASI_RX_CFG0 Register (Address = 0x26) [Reset = 0x00]
0x32	CLK_CFG0	Clock configuration register 0	0x00	CLK_CFG0 Register (Address = 0x32) [Reset = 0x00]

表 8-27. VEGA Registers (続き)

Address	Acronym	Register Name	Reset Value	Section
0x33	CLK_CFG1	Clock configuration register 1	0x00	CLK_CFG1 Register (Address = 0x33) [Reset = 0x00]
0x34	CLK_CFG2	Clock configuration register 2	0x40	CLK_CFG2 Register (Address = 0x34) [Reset = 0x40]
0x35	CNT_CLK_CFG0	controller mode clock configuration register 0	0x00	CNT_CLK_CFG0 Register (Address = 0x35) [Reset = 0x00]
0x36	CNT_CLK_CFG1	controller mode clock configuration register 1	0x00	CNT_CLK_CFG1 Register (Address = 0x36) [Reset = 0x00]
0x37	CNT_CLK_CFG2	controller mode clock configuration register 2	0x20	CNT_CLK_CFG2 Register (Address = 0x37) [Reset = 0x20]
0x38	CNT_CLK_CFG3	controller mode clock configuration register 3	0x00	CNT_CLK_CFG3 Register (Address = 0x38) [Reset = 0x00]
0x39	CNT_CLK_CFG4	controller mode clock configuration register 4	0x00	CNT_CLK_CFG4 Register (Address = 0x39) [Reset = 0x00]
0x3A	CNT_CLK_CFG5	controller mode clock configuration register 5	0x00	CNT_CLK_CFG5 Register (Address = 0x3A) [Reset = 0x00]
0x3B	CNT_CLK_CFG6	controller mode clock configuration register 6	0x00	CNT_CLK_CFG6 Register (Address = 0x3B) [Reset = 0x00]
0x3C	CLK_ERR_STS0	Clock error and status register 0	0x00	CLK_ERR_STS0 Register (Address = 0x3C) [Reset = 0x00]
0x3D	CLK_ERR_STS1	Clock error and status register 1	0x00	CLK_ERR_STS1 Register (Address = 0x3D) [Reset = 0x00]
0x3E	CLK_DET_STS0	Clock ratio detection register 0	0x00	CLK_DET_STS0 Register (Address = 0x3E) [Reset = 0x00]
0x3F	CLK_DET_STS1	Clock ratio detection register 1	0x00	CLK_DET_STS1 Register (Address = 0x3F) [Reset = 0x00]
0x40	CLK_DET_STS2	Clock ratio detection register 2	0x00	CLK_DET_STS2 Register (Address = 0x40) [Reset = 0x00]
0x41	CLK_DET_STS3	Clock ratio detection register 3	0x00	CLK_DET_STS3 Register (Address = 0x41) [Reset = 0x00]
0x42	INT_CFG	Interrupt configuration register	0x00	INT_CFG Register (Address = 0x42) [Reset = 0x00]
0x4B	ADC_DAC_MISC_CFG	ADC overload Response configuration register	0x00	ADC_DAC_MISC_C FG Register (Address = 0x4B) [Reset = 0x00]

表 8-27. VEGA Registers (続き)

Address	Acronym	Register Name	Reset Value	Section
0x4C	IADC_CFG	IADC configuration register	0x5C	IADC_CFG Register (Address = 0x4C) [Reset = 0x5C]
0x4D	VREF_CFG	Power tune configuration register 0	0x00	VREF_CFG Register (Address = 0x2) [Reset = 0x00]
0x4E	PWR_TUNE_CFG0	Power tune configuration register 0	0x00	PWR_TUNE_CFG0 Register (Address = 0x4E) [Reset = 0x00]
0x50	ADC_CH1_CFG0	ADC Channel 1 configuration register 0	0x00	ADC_CH1_CFG0 Register (Address = 0x50) [Reset = 0x00]
0x51	ADC_CH_CFG	ADC Channel configuration register	0x00	ADC_CH_CFG Register (Address = 0x51) [Reset = 0x00]
0x52	ADC_CH1_CFG2	ADC Channel 1 configuration register 2	0xA1	ADC_CH1_CFG2 Register (Address = 0x52) [Reset = 0xA1]
0x53	ADC_CH1_CFG3	ADC Channel 1 configuration register 3	0x80	ADC_CH1_CFG3 Register (Address = 0x53) [Reset = 0x80]
0x54	ADC_CH1_CFG4	ADC Channel 1 configuration register 4	0x00	ADC_CH1_CFG4 Register (Address = 0x54) [Reset = 0x00]
0x55	ADC_CH2_CFG0	ADC Channel 2 configuration register 0	0x00	ADC_CH2_CFG0 Register (Address = 0x55) [Reset = 0x00]
0x57	ADC_CH2_CFG2	Channel 2 configuration register 2	0xA1	ADC_CH2_CFG2 Register (Address = 0x57) [Reset = 0xA1]
0x58	ADC_CH2_CFG3	ADC Channel 2 configuration register 3	0x80	ADC_CH2_CFG3 Register (Address = 0x58) [Reset = 0x80]
0x59	ADC_CH2_CFG4	ADC Channel 2 configuration register 4	0x00	ADC_CH2_CFG4 Register (Address = 0x59) [Reset = 0x00]
0x5A	ADC_CH3_CFG0	ADC Channel 3 configuration register 0	0x00	ADC_CH3_CFG0 Register (Address = 0x5A) [Reset = 0x00]
0x5B	ADC_CH3_CFG2	ADC Channel 3 configuration register 2	0xA1	ADC_CH3_CFG2 Register (Address = 0x5B) [Reset = 0xA1]
0x5C	ADC_CH3_CFG3	ADC Channel 3 configuration register 3	0x80	ADC_CH3_CFG3 Register (Address = 0x5C) [Reset = 0x80]
0x5D	ADC_CH3_CFG4	ADC Channel 3 configuration register 4	0x00	ADC_CH3_CFG4 Register (Address = 0x5D) [Reset = 0x00]

表 8-27. VEGA Registers (続き)

Address	Acronym	Register Name	Reset Value	Section
0x5E	ADC_CH4_CFG0	ADC Channel 4 configuration register 0	0x00	ADC_CH4_CFG0 Register (Address = 0x5E) [Reset = 0x00]
0x5F	ADC_CH4_CFG2	Channel 4 configuration register 2	0xA1	ADC_CH4_CFG2 Register (Address = 0x5F) [Reset = 0xA1]
0x60	ADC_CH4_CFG3	ADC Channel 4 configuration register 3	0x80	ADC_CH4_CFG3 Register (Address = 0x60) [Reset = 0x80]
0x61	ADC_CH4_CFG4	ADC Channel 4 configuration register 4	0x00	ADC_CH4_CFG4 Register (Address = 0x61) [Reset = 0x00]
0x62	ADC_CFG1	ADC configuration register	0x00	ADC_CFG1 Register (Address = 0x62) [Reset = 0x00]
0x72	DSP_CFG0	DSP configuration register 0	0x18	DSP_CFG0 Register (Address = 0x72) [Reset = 0x18]
0x76	CH_EN	Channel enable configuration register	0xCC	CH_EN Register (Address = 0x76) [Reset = 0xCC]
0x77	DYN_PUPD_CFG	Power up configuration register	0x00	DYN_PUPD_CFG Register (Address = 0x77) [Reset = 0x00]
0x78	PWR_CFG	Power up configuration register	0x00	PWR_CFG Register (Address = 0x78) [Reset = 0x00]
0x79	DEV_STS0	Device status value register 0	0x00	DEV_STS0 Register (Address = 0x79) [Reset = 0x00]
0x7A	DEV_STS1	Device status value register 1	0x80	DEV_STS1 Register (Address = 0x7A) [Reset = 0x80]
0x7E	I2C_CKSUM	I ² C checksum register	0x00	I2C_CKSUM Register (Address = 0x7E) [Reset = 0x00]

8.5.1.1 PAGE_CFG Register (Address = 0x0) [Reset = 0x00]

PAGE_CFG is shown in 表 8-28.

Return to the [Summary Table](#).

The device memory map is divided into pages. This register sets the page.

表 8-28. PAGE_CFG Register Field Descriptions

Bit	Field	Type	Reset	Description
7-0	PAGE[7:0]	R/W	00000000b	These bits set the device page. 0d = Page 0 1d = Page 1 2d to 254d = Page 2 to page 254 respectively 255d = Page 255

8.5.1.2 SW_RESET Register (Address = 0x1) [Reset = 0x00]

SW_RESET is shown in 表 8-29.

Return to the [Summary Table](#).

This register is the software reset register. Asserting a software reset places all register values in their default power-on-reset (POR) state.

表 8-29. SW_RESET Register Field Descriptions

Bit	Field	Type	Reset	Description
7-1	RESERVED	R	0000000b	Reserved bits; Write only reset value
0	SW_RESET	R/W	0b	Software reset. This bit is self clearing. 0d = Do not reset 1d = Reset all registers to their reset values

8.5.1.3 VREF_CFG Register (Address = 0x2) [Reset = 0x00]

VREF_CFG is shown in 表 8-30.

Return to the [Summary Table](#).

表 8-30. VREF_CFG Register Field Descriptions

Bit	Field	Type	Reset	Description
7-6	RESERVED	R/W	00b	Reserved bits; Write only reset values
5-4	VREF_QCHG[1:0]	R/W	00b	The duration of the quick-charge for the VREF external capacitor is set using an internal series impedance of 200 Ω. 0d = VREF quick-charge duration of 3.5 ms (typical) 1d = VREF quick-charge duration of 10 ms (typical) 2d = VREF quick-charge duration of 50 ms (typical) 3d = VREF quick-charge duration of 100 ms (typical)
3	SLEEP_EXIT_VREF_EN	R/W	0b	Sleep mode exit configuration 0d = Only DREG Enabled 1d = DREG and VREF enabled
2	AVDD_MODE	R/W	0b	AVDD mode configuration. 0d = Internal AREG regulator is used (Should be used for AVDD > 2V) 1d = AVDD 1.8V used directly for AREG (Strictly use this setting for AVDD 1.7V-1.9V)
1	IOVDD_IO_MODE	R/W	0b	IOVDD mode configuration. 0d = IOVDD at 3.3V / 1.8V / 1.2V (speed limitation applicable for 1.8V and 1.2V) 1d = IOVDD at 1.8V / 1.2V only (no speed limitation - Strictly don't use this setting for IOVDD > 2V).
0	SLEEP_ENZ	R/W	0b	Sleep mode setting. 0d = Device is in sleep mode 1d = Device is not in sleep mode

8.5.1.4 AVDD_IOVDD_STS Register (Address = 0x3) [Reset = 0x00]

AVDD_IOVDD_STS is shown in 表 8-31.

Return to the [Summary Table](#).

表 8-31. AVDD_IOVDD_STS Register Field Descriptions

Bit	Field	Type	Reset	Description
7	AVDD_MODE_STS	R	0b	AVDD mode status flag register. 0d = AVDD_MODE as per configured 1d = AVDD > 2V (AVDD_MODE forced to 0d)

表 8-31. AVDD_IOVDD_STS Register Field Descriptions (続き)

Bit	Field	Type	Reset	Description
6	IOVDD_IO_MODE_STS	R	0b	IOVDD mode status flag register. 0d = IOVDD_MODE as per configured 1d = IOVDD > 2V (IOVDD_IO_MODE forced to 0d)
5-2	RESERVED	R	0000b	Reserved bits; Write only reset values
1	RESERVED	R	0b	Reserved bit; Write only reset value
0	RESERVED	R/W	0b	Reserved bit; Write only reset value

8.5.1.5 MISC_CFG Register (Address = 0x4) [Reset = 0x00]

MISC_CFG is shown in 表 8-32.

Return to the [Summary Table](#).

表 8-32. MISC_CFG Register Field Descriptions

Bit	Field	Type	Reset	Description
7	RESERVED	R/W	0b	Reserved bit; Write only reset value
6	IGNORE_CLK_ERR	R/W	0b	Clock error detection action 0b = Reset on Clock error 1b = Ignore Clock error
5	RESERVED	R/W	0b	Reserved bit; Write only reset value
4	RESERVED	R/W	0b	Reserved bit; Write only reset value
3	RESERVED	R/W	0b	Reserved bit; Write only reset value
2	RESERVED	R/W	0b	Reserved bit; Write only reset value
1	I2C_BRDCAST_EN	R/W	0b	I ² C broadcast addressing setting. 0d = I ² C broadcast mode disabled 1d = I ² C broadcast mode enabled; the I ² C target address is fixed with pin-controlled LSB bits as '0'
0	RESERVED	R/W	0b	Reserved bit; Write only reset value

8.5.1.6 MISC_CFG1 Register (Address = 0x5) [Reset = 0x15]

MISC_CFG1 is shown in 表 8-33.

Return to the [Summary Table](#).

表 8-33. MISC_CFG1 Register Field Descriptions

Bit	Field	Type	Reset	Description
7-6	INCAP_QCHG[1:0]	R/W	00b	The duration of the quick-charge for the external AC-coupling capacitor is set using an internal series impedance of 800 Ω. 0d = INxP, INxM quick-charge duration of 2.5 ms (typical) 1d = INxP, INxM quick-charge duration of 12.5 ms (typical) 2d = INxP, INxM quick-charge duration of 25 ms (typical) 3d = INxP, INxM quick-charge duration of 50 ms (typical)
5-4	SHDN_CFG[1:0]	R/W	01b	Shutdown configuration. 0d = DREG is powered down immediately after IOVDD is deasserted 1d = DREG remains active to enable a clean shut down until a time-out(DREG_KA_TIME) is reached; after the time-out period, DREG is forced to power off 2d = DREG remains active until the device cleanly shuts down 3d = Reserved; Don't use

表 8-33. MISC_CFG1 Register Field Descriptions (続き)

Bit	Field	Type	Reset	Description
3-2	DREG_KA_TIME[1:0]	R/W	01b	These bits set how long DREG remains active after IOVDD is deasserted. 0d = DREG remains active for 30 ms (typical) 1d = DREG remains active for 25 ms (typical) 2d = DREG remains active for 10 ms (typical) 3d = DREG remains active for 5 ms (typical)
1-0	RESERVED	R/W	01b	Reserved bits; Write only reset values

8.5.1.7 MISC_CFG0 Register (Address = 0x7) [Reset = 0x00]

MISC_CFG0 is shown in 表 8-34.

Return to the [Summary Table](#).

This register configures the device Misc.

表 8-34. MISC_CFG0 Register Field Descriptions

Bit	Field	Type	Reset	Description
7	RESERVED	R/W	0b	Reserved bit; Write only reset value
6	RESERVED	R/W	0b	Reserved bit; Write only reset value
5	RESERVED	R/W	0b	Reserved bit; Write only reset value
4	HW_RESET_ON_CLK_S TOP_EN	R/W	0b	Assertion of Hard Reset when clock selected by CLK_SRC_SEL is not available for 2ms config 0d = disable 1d = enable
3-0	RESERVED	R	0000b	Reserved bits; Write only reset values

8.5.1.8 GPIO1_CFG0 Register (Address = 0xA) [Reset = 0x32]

GPIO1_CFG0 is shown in 表 8-35.

Return to the [Summary Table](#).

This register is the GPIO1 configuration register 0.

表 8-35. GPIO1_CFG0 Register Field Descriptions

Bit	Field	Type	Reset	Description
7-4	GPIO1_CFG[3:0]	R/W	0011b	GPIO1 configuration. 0d = GPIO1 is disabled 1d = GPIO1 is configured as a general-purpose input (GPI) or any other input function 2d = GPIO1 is configured as a general-purpose output (GPO) 3d = GPIO1 is configured as a chip interrupt output (IRQ) 4d = GPIO1 is configured as a PDM clock output (PDMCLK) 5d = GPIO1 is configured as primary ASI DOUT 6d = GPIO1 is configured as primary ASI DOUT2 7d = GPIO1 is configured as secondary ASI DOUT 8d = GPIO1 is configured as secondary ASI DOUT2 9d = GPIO1 is configured as secondary ASI BCLK output 10d = GPIO1 is configured as secondary ASI FSYNC output 11d = GPIO1 is configured as general purpose CLKOUT 12d = GPIO1 is configured as PASI DOUT and SASI DOUT muxed 13d = GPIO1 is configured as DAISY_OUT for DIN Daisy 14d to 15d = Reserved
3	RESERVED	R	0b	Reserved bit; Write only reset value

表 8-35. GPIO1_CFG0 Register Field Descriptions (続き)

Bit	Field	Type	Reset	Description
2-0	GPIO1_DRV[2:0]	R/W	010b	GPIO1 output drive configuration. (Not valid if GPIO1_CFG configured as I ² S out) 0d = Hi-Z output 1d = Drive active low and active high 2d = Drive active low and weak high 3d = Drive active low and Hi-Z 4d = Drive weak low and active high 5d = Drive Hi-Z and active high 6d to 7d = Reserved; Don't use

8.5.1.9 GPIO2_CFG0 Register (Address = 0xB) [Reset = 0x00]

GPIO2_CFG0 is shown in 表 8-36.

Return to the [Summary Table](#).

This register is the GPIO2 configuration register 0.

表 8-36. GPIO2_CFG0 Register Field Descriptions

Bit	Field	Type	Reset	Description
7-4	GPIO2_CFG[3:0]	R/W	0000b	GPIO2 configuration. 0d = GPIO2 is disabled 1d = GPIO2 is configured as a general-purpose input (GPI) or any other input function 2d = GPIO2 is configured as a general-purpose output (GPO) 3d = GPIO2 is configured as a chip interrupt output (IRQ) 4d = GPIO2 is configured as a PDM clock output (PDMCLK) 5d = GPIO2 is configured as primary ASI DOUT 6d = GPIO2 is configured as primary ASI DOUT2 7d = GPIO2 is configured as secondary ASI DOUT 8d = GPIO2 is configured as secondary ASI DOUT2 9d = GPIO2 is configured as secondary ASI BCLK output 10d = GPIO2 is configured as secondary ASI FSYNC output 11d = GPIO2 is configured as general purpose CLKOUT 12d = GPIO2 is configured as PASI DOUT and SASI DOUT muxed 13d = GPIO2 is configured as DAISY_OUT for DIN Daisy 14d to 15d = Reserved
3	RESERVED	R	0b	Reserved bit; Write only reset value
2-0	GPIO2_DRV[2:0]	R/W	000b	GPIO2 output drive configuration. (Not valid if GPIO2_CFG configured as I ² S out) 0d = Hi-Z output 1d = Drive active low and active high 2d = Drive active low and weak high 3d = Drive active low and Hi-Z 4d = Drive weak low and active high 5d = Drive Hi-Z and active high 6d to 7d = Reserved; Don't use

8.5.1.10 GPO1_CFG0 Register (Address = 0xC) [Reset = 0x00]

GPO1_CFG0 is shown in 表 8-37.

Return to the [Summary Table](#).

This register is the GPO1 configuration register 0.

表 8-37. GPO1_CFG0 Register Field Descriptions

Bit	Field	Type	Reset	Description
7-4	GPO1_CFG[3:0]	R/W	0000b	GPO1 configuration.(For SPI mode, this pin act as DO and the below configuration settings are not applicable) 0d = GPO1 is disabled 1d = Reserved 2d = GPO1 is configured as a general-purpose output (GPO) 3d = GPO1 is configured as a chip interrupt output (IRQ) 4d = GPO1 is configured as a PDM clock output (PDMCLK) 5d = GPO1 is configured as primary ASI DOUT 6d = GPO1 is configured as primary ASI DOUT2 7d = GPO1 is configured as secondary ASI DOUT 8d = GPO1 is configured as secondary ASI DOUT2 9d = GPO1 is configured as secondary ASI BCLK output 10d = GPO1 is configured as secondary ASI FSYNC output 11d = GPO1 is configured as general purpose CLKOUT 12d = GPO1 is configured as PASI DOUT and SASI DOUT muxed 13d = GPO1 is configured as DAISY_OUT for DIN Daisy 14d to 15d = Reserved
3	RESERVED	R/W	0b	Reserved bit; Write only reset value
2-0	GPO1_DRV[2:0]	R/W	000b	GPO1 output drive configuration. (Not valid if GPO1_CFG configured as I ² S out) 0d = Hi-Z output 1d = Drive active low and active high 2d = Drive active low and weak high 3d = Drive active low and Hi-Z 4d = Drive weak low and active high 5d = Drive Hi-Z and active high 6d to 7d = Reserved; Don't use

8.5.1.11 GPI_CFG Register (Address = 0xD) [Reset = 0x00]

GPI_CFG is shown in 表 8-38.

Return to the [Summary Table](#).

This register is the GPI1 configuration register 0.

表 8-38. GPI_CFG Register Field Descriptions

Bit	Field	Type	Reset	Description
7-2	RESERVED	R	000000b	Reserved bits; Write only reset values
1	GPI1_CFG	R/W	0b	GPI1 configuration.(For SPI mode, this pin act as CSZ and the below configuration settings are not applicable) 0d = GPI1 is disabled 1d = GPI1 is configured as a general-purpose input (GPI) or any other input function
0	RESERVED	R/W	0b	Reserved bit; Write only reset value

8.5.1.12 GPO_GPI_VAL Register (Address = 0xE) [Reset = 0x00]

GPO_GPI_VAL is shown in 表 8-39.

Return to the [Summary Table](#).

This register is the GPIO and GPO output value register.

表 8-39. GPO_GPI_VAL Register Field Descriptions

Bit	Field	Type	Reset	Description
7	GPIO1_VAL	R/W	0b	GPIO1 output value when configured as a GPO. 0d = Drive the output with a value of 0 1d = Drive the output with a value of 1
6	GPIO2_VAL	R/W	0b	GPIO2 output value when configured as a GPO. 0d = Drive the output with a value of 0 1d = Drive the output with a value of 1
5	GPO1_VAL	R/W	0b	GPO1 output value when configured as a GPO. 0d = Drive the output with a value of 0 1d = Drive the output with a value of 1
4	RESERVED	R	0b	Reserved bit; Write only reset value
3	GPIO1_MON	R	0b	GPIO1 monitor value when configured as a GPI. 0d = Input monitor value 0 1d = Input monitor value 1
2	GPIO2_MON	R	0b	GPIO2 monitor value when configured as a GPI. 0d = Input monitor value 0 1d = Input monitor value 1
1	GPI1_MON	R	0b	GPI1 monitor value when configured as a GPI. 0d = Input monitor value 0 1d = Input monitor value 1
0	RESERVED	R	0b	Reserved bit; Write only reset value

8.5.1.13 INTF_CFG0 Register (Address = 0xF) [Reset = 0x00]

INTF_CFG0 is shown in 表 8-40.

Return to the [Summary Table](#).

This register is the interface configuration register 0.

表 8-40. INTF_CFG0 Register Field Descriptions

Bit	Field	Type	Reset	Description
7	RESERVED	R	0b	Reserved bit; Write only reset value
6-5	CCLK_SEL[1:0]	R/W	00b	CCLK select configuration. 0d = CCLK is disabled 1d = GPIO1 2d = GPIO2 3d = GPI1
4-2	PASI_DIN2_SEL[2:0]	R/W	000b	Primary ASI DIN2 select configuration. 0d = Primary ASI DIN2 is disabled 1d = GPIO1 2d = GPIO2 3d = GPI1 4d = DOUT 5d = Primary ASI DIN 6d to 7d = Reserved
1	PASI_BCLK_SEL	R/W	0b	Primary ASI BCLK select configuration. 0d = Primary ASI BCLK is BCLK 1d = Primary ASI BCLK is Secondary ASI BCLK
0	PASI_FSYNC_SEL	R/W	0b	Primary ASI FSYNC select configuration. 0d = Primary ASI FSYNC is FSYNC 1d = Primary ASI FSYNC is Secondary ASI FSYNC

8.5.1.14 INTF_CFG1 Register (Address = 0x10) [Reset = 0x52]

INTF_CFG1 is shown in 表 8-41.

Return to the [Summary Table](#).

This register is the interface configuration register 1.

表 8-41. INTF_CFG1 Register Field Descriptions

Bit	Field	Type	Reset	Description
7-4	DOUT_SEL[3:0]	R/W	0101b	DOUT select configuration. 0d = DOUT is disabled 1d = DOUT is configured as input 2d = DOUT is configured as a general-purpose output (GPO) 3d = DOUT is configured as a chip interrupt output (IRQ) 4d = DOUT is configured as a PDM clock output (PDMCLK) 5d = DOUT is configured as primary ASI DOUT 6d = DOUT is configured as primary ASI DOUT2 7d = DOUT is configured as secondary ASI DOUT 8d = DOUT is configured as secondary ASI DOUT2 9d = DOUT is configured as secondary ASI BCLK output 10d = DOUT is configured as secondary ASI FSYNC output 11d = DOUT is configured as general purpose CLKOUT 12d = DOUT is configured as PASI DOUT and SASI DOUT muxed 13d = DOUT is configured as DAISY_OUT for DIN Daisy 14d = DOUT is configured as DIN(LOOPBACK) 15d = Reserved
3	DOUT_VAL	R/W	0b	DOUT output value when configured as a GPO. 0d = Drive the output with a value of 0 1d = Drive the output with a value of 1
2-0	DOUT_DRV[2:0]	R/W	010b	DOUT output drive configuration. 0d = Hi-Z output 1d = Drive active low and active high 2d = Drive active low and weak high 3d = Drive active low and Hi-Z 4d = Drive weak low and active high 5d = Drive Hi-Z and active high 6d to 7d = Reserved; Don't use

8.5.1.15 INTF_CFG2 Register (Address = 0x11) [Reset = 0x80]

INTF_CFG2 is shown in [表 8-42](#).

Return to the [Summary Table](#).

This register is the interface configuration register 2.

表 8-42. INTF_CFG2 Register Field Descriptions

Bit	Field	Type	Reset	Description
7	PASI_DIN_EN	R/W	1b	Primary ASI DIN enable configuration. 0d = Primary ASI DIN is disabled 1d = Primary ASI DIN is enabled
6-4	SASI_FSYNC_SEL[2:0]	R/W	000b	Secondary ASI FSYNC select configuration. 0d = Secondary ASI disabled 1d = GPIO1 2d = GPIO2 3d = GPI1 4d = Reserved 5d = Primary ASI FSYNC 6d to 7d = Reserved

表 8-42. INTF_CFG2 Register Field Descriptions (続き)

Bit	Field	Type	Reset	Description
3-1	SASI_BCLK_SEL[2:0]	R/W	000b	Secondary ASI BCLK select configuration. 0d = Secondary ASI disabled 1d = GPIO1 2d = GPIO2 3d = GPI1 4d = Reserved 5d = Primary ASI BCLK 6d to 7d = Reserved
0	RESERVED	R	0b	Reserved bit; Write only reset value

8.5.1.16 INTF_CFG3 Register (Address = 0x12) [Reset = 0x00]

INTF_CFG3 is shown in 表 8-43.

Return to the [Summary Table](#).

This register is the interface configuration register 3.

表 8-43. INTF_CFG3 Register Field Descriptions

Bit	Field	Type	Reset	Description
7-5	SASI_DIN_SEL[2:0]	R/W	000b	Secondary ASI DIN select configuration. 0d = Secondary ASI DIN is disabled 1d = GPIO1 2d = GPIO2 3d = GPI1 4d = DOUT 5d = Primary ASI DIN 6d to 7d = Reserved
4-2	SASI_DIN2_SEL[2:0]	R/W	000b	Secondary ASI DIN2 select configuration. 0d = Secondary ASI DIN2 is disabled 1d = GPIO1 2d = GPIO2 3d = GPI1 4d = DOUT 5d = Primary ASI DIN 6d to 7d = Reserved
1-0	RESERVED	R	00b	Reserved bits; Write only reset values

8.5.1.17 INTF_CFG4 Register (Address = 0x13) [Reset = 0x00]

INTF_CFG4 is shown in 表 8-44.

Return to the [Summary Table](#).

This register is the interface configuration register 3.

表 8-44. INTF_CFG4 Register Field Descriptions

Bit	Field	Type	Reset	Description
7	PDM_CH1_SEL	R/W	0b	PDM select configuration for channel 1 of record path. 0d = Channel 1 is analog (ADC) type on the record path 1d = Channel 1 is digital (PDM) type on the record path
6	PDM_CH2_SEL	R/W	0b	PDM select configuration for channel 2 of record path. 0d = Channel 2 is analog (ADC) type on the record path 1d = Channel 2 is digital (PDM) type on the record path

表 8-44. INTF_CFG4 Register Field Descriptions (続き)

Bit	Field	Type	Reset	Description
5	PDMDIN1_EDGE	R/W	0b	PDMCLK latching edge used for channel 1 and channel 2 data. 0d = Channel 1 data are latched on the negative edge, channel 2 data are latched on the positive edge 1d = Channel 1 data are latched on the positive edge, channel 2 data are latched on the negative edge
4	PDMDIN2_EDGE	R/W	0b	PDMCLK latching edge used for channel 3 and channel 4 data. 0d = Channel 3 data are latched on the negative edge, channel 4 data are latched on the positive edge 1d = Channel 3 data are latched on the positive edge, channel 4 data are latched on the negative edge
3-2	PDM_DIN1_SEL[1:0]	R/W	00b	PDM data channels 1 and 2 select configuration. 0d = PDM data channels 1 and 2 are disabled 1d = GPIO1 2d = GPIO2 3d = GPI1
1-0	PDM_DIN2_SEL[1:0]	R/W	00b	PDM data channels 3 and 4 select configuration. 0d = PDM data channels 3 and 4 are disabled 1d = GPIO1 2d = GPIO2 3d = GPI1

8.5.1.18 INTF_CFG5 Register (Address = 0x14) [Reset = 0x00]

INTF_CFG5 is shown in 表 8-45.

Return to the [Summary Table](#).

This register is the interface configuration register 4.

表 8-45. INTF_CFG5 Register Field Descriptions

Bit	Field	Type	Reset	Description
7	PDM_DIN_SEL_OVRD	R/W	0b	PDM data channels (1 and 2)/(3 and 4) select configuration override. 0d = No Override 1d = PDM_DIN1/2_SEL if configured as GPI1 will be overridden as DIN
6	DOOUT_WITH_DIN	R/W	0b	DOOUT used as both ASI OUT and ASI IN 0d = DOOUT based on DOOUT_SEL 1d = DOOUT used as both ASI OUT and ASI DIN
5-4	PD_ADC_GPIO[1:0]	R/W	00b	Power down ADC using GPIO select configuration.(ADC powered down if any one of the PD_ADC_GPIO/ADC_PDZ is configured power down) 0d = Power down ADC using GPIO is disabled 1d = Power down ADC using GPIO1 2d = Power down ADC using GPIO2 3d = Power down ADC using GPI1
3-2	PD_DAC_GPIO[1:0]	R/W	00b	Power down DAC using GPIO select configuration.(DAC powered down if any one of the PD_DAC_GPIO/DAC_PDZ is configured power down) 0d = Power down DAC using GPIO is disabled 1d = Power down DAC using GPIO1 2d = Power down DAC using GPIO2 3d = Power down DAC using GPI1
1	RESERVED	R/W	0b	Reserved bit; Write only reset value
0	RESERVED	R/W	0b	Reserved bit; Write only reset value

8.5.1.19 INTF_CFG6 Register (Address = 0x15) [Reset = 0x00]

INTF_CFG6 is shown in [表 8-46](#).

Return to the [Summary Table](#).

This register is the interface configuration register 5.

表 8-46. INTF_CFG6 Register Field Descriptions

Bit	Field	Type	Reset	Description
7-6	EN_MBIAS_GPIO[1:0]	R/W	00b	Enable MICBIAS using GPIO select configuration. 0d = Enable MICBIAS using GPIO is disabled 1d = Enable MICBIAS using GPIO1 2d = Enable MICBIAS using GPIO2 3d = Enable MICBIAS using GPI1
5-4	IADC_CONVST_GPIO[1:0]]	R/W	00b	IADC conversion start using GPIO select configuration. 0d = Enable IADC using GPIO is disabled 1d = Enable IADC using GPIO1 2d = Enable IADC using GPIO2 3d = Enable IADC using GPI1
3-0	RESERVED	R	0000b	Reserved bits; Write only reset value

8.5.1.20 ASI_CFG0 Register (Address = 0x18) [Reset = 0x40]

ASI_CFG0 is shown in [表 8-47](#).

Return to the [Summary Table](#).

This register is the ASI configuration register 0.

表 8-47. ASI_CFG0 Register Field Descriptions

Bit	Field	Type	Reset	Description
7	PASI_DIS	R/W	0b	Disable or enable primary ASI (PASI). 0d = Primary ASI enabled 1d = Primary ASI disabled
6	SASI_DIS	R/W	1b	Disable or enable secondary ASI (SASI). 0d = Secondary ASI enabled 1d = Secondary ASI disabled
5	SASI_CFG_GANG	R/W	0b	All configurations of secondary ASI ganged with primary ASI. 0d = Secondary ASI has independent configurations 1d = Secondary ASI configurations same as primary ASI
4-3	DAISY_EN[1:0]	R/W	00b	Daisy chain feature enable (only 1 ASI with 1 DOUT AND DIN available) 0d = Daisy chain disabled 1d = PASI daisy chain enabled (Secondary ASI not available) 2d = SASI daisy chain enabled (Primary ASI not available) 3d = Reserved; Don't use
2-0	DAISY_IN_SEL[2:0]	R/W	000b	Daisy input select configuration. 0d = Daisy input disabled 1d = GPIO1 2d = GPIO2 3d = GPI1 4d = Reserved 5d = DIN 6d to 7d = Reserved

8.5.1.21 ASI_CFG1 Register (Address = 0x19) [Reset = 0x00]

ASI_CFG1 is shown in [表 8-48](#).

Return to the [Summary Table](#).

This register is the ASI configuration register 1.

表 8-48. ASI_CFG1 Register Field Descriptions

Bit	Field	Type	Reset	Description
7-6	ASI_DOUT_CFG[1:0]	R/W	00b	ASI data output configuration. 0d = 1 data output for Primary ASI and 1 data output for Secondary ASI 1d = 2 data outputs for Primary ASI 2d = 2 data outputs for Secondary ASI 3d = Reserved; Don't use
5-4	ASI_DIN_CFG[1:0]	R/W	00b	ASI data input configuration. 0d = 1 data input for Primary ASI and 1 data input for Secondary ASI 1d = 2 data inputs for Primary ASI 2d = 2 data inputs for Secondary ASI 3d = Reserved; Don't use
3	RESERVED	R/W	0b	Reserved bit; Write only reset value
2	RESERVED	R/W	0b	Reserved bit; Write only reset value
1	RESERVED	R/W	0b	Reserved bit; Write only reset value
0	RESERVED	R	0b	Reserved bit; Write only reset value

8.5.1.22 PASI_CFG0 Register (Address = 0x1A) [Reset = 0x30]

PASI_CFG0 is shown in [表 8-49](#).

Return to the [Summary Table](#).

This register is the ASI configuration register 0.

表 8-49. PASI_CFG0 Register Field Descriptions

Bit	Field	Type	Reset	Description
7-6	PASI_FORMAT[1:0]	R/W	00b	Primary ASI protocol format. 0d = TDM mode 1d = I ² S mode 2d = LJ (left-justified) mode 3d = Reserved; Don't use
5-4	PASI_WLEN[1:0]	R/W	11b	Primary ASI word or slot length. 0d = 16 bits (Recommended: This setting to be used with 10-kΩ input impedance configuration) 1d = 20 bits 2d = 24 bits 3d = 32 bits
3	PASI_FSYNC_POL	R/W	0b	ASI FSYNC polarity (for PASI protocol only). 0d = Default polarity as per standard protocol 1d = Inverted polarity with respect to standard protocol
2	PASI_BCLK_POL	R/W	0b	ASI BCLK polarity (for PASI protocol only). 0d = Default polarity as per standard protocol 1d = Inverted polarity with respect to standard protocol
1	PASI_BUS_ERR	R/W	0b	ASI bus error detection. 0d = Enable bus error detection 1d = Disable bus error detection
0	PASI_BUS_ERR_RCOV	R/W	0b	ASI bus error auto resume. 0d = Enable auto resume after bus error recovery 1d = Disable auto resume after bus error recovery and remain powered down until host configures the device

8.5.1.23 PASI_TX_CFG0 Register (Address = 0x1B) [Reset = 0x00]

PASI_TX_CFG0 is shown in [表 8-50](#).

Return to the [Summary Table](#).

This register is the PASI TX configuration register 0.

表 8-50. PASI_TX_CFG0 Register Field Descriptions

Bit	Field	Type	Reset	Description
7	PASI_TX_EDGE	R/W	0b	Primary ASI data output (on the primary and secondary data pin) transmit edge. 0d = Default edge as per the protocol configuration setting in PASI_BCLK_POL 1d = Inverted following edge (half cycle delay) with respect to the default edge setting
6	PASI_TX_FILL	R/W	0b	Primary ASI data output (on the primary and secondary data pin) for any unused cycles 0d = Always transmit 0 for unused cycles 1d = Always use Hi-Z for unused cycles
5	PASI_TX_LSB	R/W	0b	Primary ASI data output (on the primary and secondary data pin) for LSB transmissions. 0d = Transmit the LSB for a full cycle 1d = Transmit the LSB for the first half cycle and Hi-Z for the second half cycle
4-3	PASI_TX_KEEPER[1:0]	R/W	00b	Primary ASI data output (on the primary and secondary data pin) bus keeper. 0d = Bus keeper is always disabled 1d = Bus keeper is always enabled 2d = Bus keeper is enabled during LSB transmissions only for one cycle 3d = Bus keeper is enabled during LSB transmissions only for one and half cycles
2	PASI_TX_USE_INT_FSYNC	R/W	0b	Primary ASI uses internal FSYNC for output data generation in Controller mode configuration as applicable. 0d = Use external FSYNC for ASI protocol data generation 1d = Use internal FSYNC for ASI protocol data generation
1	PASI_TX_USE_INT_BCLK	R/W	0b	Primary ASI uses internal BCLK for output data generation in Controller mode configuration. 0d = Use external BCLK for ASI protocol data generation 1d = Use internal BCLK for ASI protocol data generation
0	PASI_TDM_PULSE_WIDTH	R/W	0b	Primary ASI fsync pulse width in TDM format. (Valid for Controller mode) 0d = Fsync pulse is 1 bclk period wide 1d = Fsync pulse is 2 bclk period wide

8.5.1.24 PASI_TX_CFG1 Register (Address = 0x1C) [Reset = 0x00]

PASI_TX_CFG1 is shown in [表 8-51](#).

Return to the [Summary Table](#).

This register is the PASI TX configuration register 1.

表 8-51. PASI_TX_CFG1 Register Field Descriptions

Bit	Field	Type	Reset	Description
7-5	RESERVED	R	000b	Reserved bits; Write only reset values

表 8-51. PASI_TX_CFG1 Register Field Descriptions (続き)

Bit	Field	Type	Reset	Description
4-0	PASI_TX_OFFSET[4:0]	R/W	00000b	Primary ASI output data MSB slot 0 offset (on the primary and secondary data pin). 0d = ASI data MSB location has no offset and is as per standard protocol 1d = ASI data MSB location (TDM mode is slot 0 or I ² S, LJ mode is the left and right slot 0) offset of one BCLK cycle with respect to standard protocol 2d = ASI data MSB location (TDM mode is slot 0 or I ² S, LJ mode is the left and right slot 0) offset of two BCLK cycles with respect to standard protocol 3d to 30d = ASI data MSB location (TDM mode is slot 0 or I ² S, LJ mode is the left and right slot 0) offset assigned as per configuration 31d = ASI data MSB location (TDM mode is slot 0 or I ² S, LJ mode is the left and right slot 0) offset of 31 BCLK cycles with respect to standard protocol

8.5.1.25 PASI_TX_CFG2 Register (Address = 0x1D) [Reset = 0x00]

PASI_TX_CFG2 is shown in 表 8-52.

Return to the [Summary Table](#).

This register is the PASI TX configuration register 2.

表 8-52. PASI_TX_CFG2 Register Field Descriptions

Bit	Field	Type	Reset	Description
7	PASI_TX_CH8_SEL	R/W	0b	Primary ASI output channel 8 select. 0d = Primary ASI channel 8 output is on DOUT 1d = Primary ASI channel 8 output is on DOUT2
6	PASI_TX_CH7_SEL	R/W	0b	Primary ASI output channel 7 select. 0d = Primary ASI channel 7 output is on DOUT 1d = Primary ASI channel 7 output is on DOUT2
5	PASI_TX_CH6_SEL	R/W	0b	Primary ASI output channel 6 select. 0d = Primary ASI channel 6 output is on DOUT 1d = Primary ASI channel 6 output is on DOUT2
4	PASI_TX_CH5_SEL	R/W	0b	Primary ASI output channel 5 select. 0d = Primary ASI channel 5 output is on DOUT 1d = Primary ASI channel 5 output is on DOUT2
3	PASI_TX_CH4_SEL	R/W	0b	Primary ASI output channel 4 select. 0d = Primary ASI channel 4 output is on DOUT 1d = Primary ASI channel 4 output is on DOUT2
2	PASI_TX_CH3_SEL	R/W	0b	Primary ASI output channel 3 select. 0d = Primary ASI channel 3 output is on DOUT 1d = Primary ASI channel 3 output is on DOUT2
1	PASI_TX_CH2_SEL	R/W	0b	Primary ASI output channel 2 select. 0d = Primary ASI channel 2 output is on DOUT 1d = Primary ASI channel 2 output is on DOUT2
0	PASI_TX_CH1_SEL	R/W	0b	Primary ASI output channel 1 select. 0d = Primary ASI channel 1 output is on DOUT 1d = Primary ASI channel 1 output is on DOUT2

8.5.1.26 PASI_TX_CH1_CFG Register (Address = 0x1E) [Reset = 0x20]

PASI_TX_CH1_CFG is shown in 表 8-53.

Return to the [Summary Table](#).

This register is the PASI TX Channel 1 configuration register.

表 8-53. PASI_TX_CH1_CFG Register Field Descriptions

Bit	Field	Type	Reset	Description
7-6	RESERVED	R	00b	Reserved bits; Write only reset values
5	PASI_TX_CH1_CFG	R/W	1b	Primary ASI output channel 1 configuration. 0d = Primary ASI channel 1 output is in a tri-state condition 1d = Primary ASI channel 1 output corresponds to ADC/PDM Channel 1 data
4-0	PASI_TX_CH1_SLOT_NUM[4:0]	R/W	00000b	Primary ASI output channel 1 slot assignment. 0d = TDM is slot 0 or I ² S, LJ is left slot 0 1d = TDM is slot 1 or I ² S, LJ is left slot 1 2d to 14d = Slot assigned as per configuration 15d = TDM is slot 15 or I ² S, LJ is left slot 15 16d = TDM is slot 16 or I ² S, LJ is right slot 0 17d = TDM is slot 17 or I ² S, LJ is right slot 1 18d to 30d = Slot assigned as per configuration 31d = TDM is slot 31 or I ² S, LJ is right slot 15

8.5.1.27 PASI_TX_CH2_CFG Register (Address = 0x1F) [Reset = 0x21]

PASI_TX_CH2_CFG is shown in [表 8-54](#).

Return to the [Summary Table](#).

This register is the PASI TX Channel 2 configuration register.

表 8-54. PASI_TX_CH2_CFG Register Field Descriptions

Bit	Field	Type	Reset	Description
7-6	RESERVED	R	00b	Reserved bits; Write only reset values
5	PASI_TX_CH2_CFG	R/W	1b	Primary ASI output channel 2 configuration. 0d = Primary ASI channel 2 output is in a tri-state condition 1d = Primary ASI channel 2 output corresponds to ADC/PDM Channel 2 data
4-0	PASI_TX_CH2_SLOT_NUM[4:0]	R/W	00001b	Primary ASI output channel 2 slot assignment. 0d = TDM is slot 0 or I ² S, LJ is left slot 0 1d = TDM is slot 1 or I ² S, LJ is left slot 1 2d to 14d = Slot assigned as per configuration 15d = TDM is slot 15 or I ² S, LJ is left slot 15 16d = TDM is slot 16 or I ² S, LJ is right slot 0 17d = TDM is slot 17 or I ² S, LJ is right slot 1 18d to 30d = Slot assigned as per configuration 31d = TDM is slot 31 or I ² S, LJ is right slot 15

8.5.1.28 PASI_TX_CH3_CFG Register (Address = 0x20) [Reset = 0x02]

PASI_TX_CH3_CFG is shown in [表 8-55](#).

Return to the [Summary Table](#).

This register is the PASI TX Channel 3 configuration register.

表 8-55. PASI_TX_CH3_CFG Register Field Descriptions

Bit	Field	Type	Reset	Description
7	RESERVED	R	0b	Reserved bit; Write only reset value

表 8-55. PASI_TX_CH3_CFG Register Field Descriptions (続き)

Bit	Field	Type	Reset	Description
6-5	PASI_TX_CH3_CFG[1:0]	R/W	00b	Primary ASI output channel 3 configuration. 0d = Primary ASI channel 3 output is in a tri-state condition 1d = Primary ASI channel 3 output corresponds to PDM Channel 3 data 2d = Primary ASI channel 3 output corresponds to VBAT data Dont use
4-0	PASI_TX_CH3_SLOT_NUM[4:0]	R/W	00010b	Primary ASI output channel 3 slot assignment. 0d = TDM is slot 0 or I ² S, LJ is left slot 0 1d = TDM is slot 1 or I ² S, LJ is left slot 1 2d to 14d = Slot assigned as per configuration 15d = TDM is slot 15 or I ² S, LJ is left slot 15 16d = TDM is slot 16 or I ² S, LJ is right slot 0 17d = TDM is slot 17 or I ² S, LJ is right slot 1 18d to 30d = Slot assigned as per configuration 31d = TDM is slot 31 or I ² S, LJ is right slot 15

8.5.1.29 PASI_TX_CH4_CFG Register (Address = 0x21) [Reset = 0x03]

PASI_TX_CH4_CFG is shown in 表 8-56.

Return to the [Summary Table](#).

This register is the PASI TX Channel 4 configuration register.

表 8-56. PASI_TX_CH4_CFG Register Field Descriptions

Bit	Field	Type	Reset	Description
7	RESERVED	R	0b	Reserved bit; Write only reset value
6-5	PASI_TX_CH4_CFG[1:0]	R/W	00b	Primary ASI output channel 4 configuration. 0d = Primary ASI channel 4 output is in a tri-state condition 1d = Primary ASI channel 4 output corresponds to PDM Channel 4 data 2d = Primary ASI channel 4 output corresponds to TEMP data Dont use
4-0	PASI_TX_CH4_SLOT_NUM[4:0]	R/W	00011b	Primary ASI output channel 4 slot assignment. 0d = TDM is slot 0 or I ² S, LJ is left slot 0 1d = TDM is slot 1 or I ² S, LJ is left slot 1 2d to 14d = Slot assigned as per configuration 15d = TDM is slot 15 or I ² S, LJ is left slot 15 16d = TDM is slot 16 or I ² S, LJ is right slot 0 17d = TDM is slot 17 or I ² S, LJ is right slot 1 18d to 30d = Slot assigned as per configuration 31d = TDM is slot 31 or I ² S, LJ is right slot 15

8.5.1.30 PASI_TX_CH5_CFG Register (Address = 0x22) [Reset = 0x04]

PASI_TX_CH5_CFG is shown in 表 8-57.

Return to the [Summary Table](#).

This register is the PASI TX Channel 5 configuration register.

表 8-57. PASI_TX_CH5_CFG Register Field Descriptions

Bit	Field	Type	Reset	Description
7	RESERVED	R	0b	Reserved bit; Write only reset value

表 8-57. PASI_TX_CH5_CFG Register Field Descriptions (続き)

Bit	Field	Type	Reset	Description
6-5	PASI_TX_CH5_CFG[1:0]	R/W	00b	Primary ASI output channel 5 configuration. 0d = Primary ASI channel 5 output is in a tri-state condition 1d = Primary ASI channel 5 output corresponds to ASI Input Channel 1 loopback data Dont use Dont use
4-0	PASI_TX_CH5_SLOT_NUM[4:0]	R/W	00100b	Primary ASI output channel 5 slot assignment. 0d = TDM is slot 0 or I ² S, LJ is left slot 0 1d = TDM is slot 1 or I ² S, LJ is left slot 1 2d to 14d = Slot assigned as per configuration 15d = TDM is slot 15 or I ² S, LJ is left slot 15 16d = TDM is slot 16 or I ² S, LJ is right slot 0 17d = TDM is slot 17 or I ² S, LJ is right slot 1 18d to 30d = Slot assigned as per configuration 31d = TDM is slot 31 or I ² S, LJ is right slot 15

8.5.1.31 PASI_TX_CH6_CFG Register (Address = 0x23) [Reset = 0x05]

PASI_TX_CH6_CFG is shown in 表 8-58.

Return to the [Summary Table](#).

This register is the PASI TX Channel 6 configuration register.

表 8-58. PASI_TX_CH6_CFG Register Field Descriptions

Bit	Field	Type	Reset	Description
7	RESERVED	R	0b	Reserved bit; Write only reset value
6-5	PASI_TX_CH6_CFG[1:0]	R/W	00b	Primary ASI output channel 6 configuration. 0d = Primary ASI channel 6 output is in a tri-state condition 1d = Primary ASI channel 6 output corresponds to ASI Input Channel 2 loopback data Dont use Dont use
4-0	PASI_TX_CH6_SLOT_NUM[4:0]	R/W	00101b	Primary ASI output channel 6 slot assignment. 0d = TDM is slot 0 or I ² S, LJ is left slot 0 1d = TDM is slot 1 or I ² S, LJ is left slot 1 2d to 14d = Slot assigned as per configuration 15d = TDM is slot 15 or I ² S, LJ is left slot 15 16d = TDM is slot 16 or I ² S, LJ is right slot 0 17d = TDM is slot 17 or I ² S, LJ is right slot 1 18d to 30d = Slot assigned as per configuration 31d = TDM is slot 31 or I ² S, LJ is right slot 15

8.5.1.32 PASI_TX_CH7_CFG Register (Address = 0x24) [Reset = 0x06]

PASI_TX_CH7_CFG is shown in 表 8-59.

Return to the [Summary Table](#).

This register is the PASI TX Channel 7 configuration register.

表 8-59. PASI_TX_CH7_CFG Register Field Descriptions

Bit	Field	Type	Reset	Description
7	RESERVED	R	0b	Reserved bit; Write only reset value

表 8-59. PASI_TX_CH7_CFG Register Field Descriptions (続き)

Bit	Field	Type	Reset	Description
6-5	PASI_TX_CH7_CFG[1:0]	R/W	00b	Primary ASI output channel 7 configuration. 0d = Primary ASI channel 7 output is in a tri-state condition 1d = Primary ASI channel 7 output corresponds to {VBAT_WLby2, TEMP_WLby2} Dont use Dont use
4-0	PASI_TX_CH7_SLOT_NUM[4:0]	R/W	00110b	Primary ASI output channel 7 slot assignment. 0d = TDM is slot 0 or I ² S, LJ is left slot 0 1d = TDM is slot 1 or I ² S, LJ is left slot 1 2d to 14d = Slot assigned as per configuration 15d = TDM is slot 15 or I ² S, LJ is left slot 15 16d = TDM is slot 16 or I ² S, LJ is right slot 0 17d = TDM is slot 17 or I ² S, LJ is right slot 1 18d to 30d = Slot assigned as per configuration 31d = TDM is slot 31 or I ² S, LJ is right slot 15

8.5.1.33 PASI_RX_CFG0 Register (Address = 0x26) [Reset = 0x00]

PASI_RX_CFG0 is shown in 表 8-60.

Return to the [Summary Table](#).

This register is the PASI RX configuration register 0.

表 8-60. PASI_RX_CFG0 Register Field Descriptions

Bit	Field	Type	Reset	Description
7	PASI_RX_EDGE	R/W	0b	Primary ASI data input (on the primary and secondary data pin) receive edge. 0d = Default edge as per the protocol configuration setting in PASI_BCLK_POL 1d = Inverted following edge (half cycle delay) with respect to the default edge setting
6	PASI_RX_USE_INT_FSYNC	R/W	0b	Primary ASI uses internal FSYNC for input data latching in Controller mode configuration as applicable. 0d = Use external FSYNC for ASI protocol data latching 1d = Use internal FSYNC for ASI protocol data latching
5	PASI_RX_USE_INT_BCLK	R/W	0b	Primary ASI uses internal BCLK for input data latching in Controller mode configuration. 0d = Use external BCLK for ASI protocol data latching 1d = Use internal BCLK for ASI protocol data latching
4-0	PASI_RX_OFFSET[4:0]	R/W	00000b	Primary ASI data input MSB slot 0 offset (on the primary and secondary data pin). 0d = ASI data MSB location has no offset and is as per standard protocol 1d = ASI data MSB location (TDM mode is slot 0 or I ² S, LJ mode is the left and right slot 0) offset of one BCLK cycle with respect to standard protocol 2d = ASI data MSB location (TDM mode is slot 0 or I ² S, LJ mode is the left and right slot 0) offset of two BCLK cycles with respect to standard protocol 3d to 30d = ASI data MSB location (TDM mode is slot 0 or I ² S, LJ mode is the left and right slot 0) offset assigned as per configuration 31d = ASI data MSB location (TDM mode is slot 0 or I ² S, LJ mode is the left and right slot 0) offset of 31 BCLK cycles with respect to standard protocol

8.5.1.34 CLK_CFG0 Register (Address = 0x32) [Reset = 0x00]

CLK_CFG0 is shown in 表 8-61.

Return to the [Summary Table](#).

This register is the clock configuration register 0.

表 8-61. CLK_CFG0 Register Field Descriptions

Bit	Field	Type	Reset	Description
7-2	PASI_SAMP_RATE[5:0]	R/W	000000b	Primary ASI sample rate configuration. -Typical (Allowed Range) 0d = Primary ASI sampling rate auto detected in the device 1d = 768000 (670320-791040) 2d = 614400 (536256-632832) 3d = 512000 (446880-527360) 4d = 438857 (383040-452022) 5d = 384000 (335160-395520) 6d = 341333 (297920-351573) 7d = 307200 (268128-316416) 8d = 256000 (223440-263680) 9d = 219429 (191520-226011) 10d = 192000 (167580-197760) 11d = 170667 (148960-175786) 12d = 153600 (134064-158208) 13d = 128000 (111720-131840) 14d = 109714 (95760-113005) 15d = 96000 (83790-98880) 16d = 85333 (74480-87893) 17d = 76800 (67032-79104) 18d = 64000 (55860-65920) 19d = 54857 (47880-56502) 20d = 48000 (41895-49440) 21d = 42667 (37240-43946) 22d = 38400 (33516-39552) 23d = 32000 (27930-32960) 24d = 27429 (23940-28251) 25d = 24000 (20947-24720) 26d = 21333 (18620-21973) 27d = 19200 (16758-19776) 28d = 16000 (13965-16480) 29d = 13714 (11970-14125) 30d = 12000 (10473-12360) 31d = 10667 (9310-10986) 32d = 9600 (8379-9888) 33d = 8000 (6982-8240) 34d = 6857 (5985-7062) 35d = 6000 (5236-6180) 36d = 5333 (4655-5493) 37d = 4800 (4189-4944) 38d = 4000 (3491-4120) 39d = 3429 (2992-3531) 40d = 3000 (2618-3090) 41d-63d = Reserved
1	PASI_FS_RATE_NO_LIM	R/W	0b	Limit sampling rate to standard audio sample rates only. 0d = Standard audio rates with 1% tolerance supported using auto mode 1d = Standard audio rates with 5% tolerance supported using auto mode
0	CUSTOM_CLK_CFG	R/W	0b	Custom clock configuration enable, all dividers and mux selects need to be manually configured. 0d = Auto clock configuration 1d = Custom clock configuration

8.5.1.35 CLK_CFG1 Register (Address = 0x33) [Reset = 0x00]

CLK_CFG1 is shown in 表 8-62.

Return to the [Summary Table](#).

This register is the clock configuration register 1.

表 8-62. CLK_CFG1 Register Field Descriptions

Bit	Field	Type	Reset	Description
7-2	SASI_SAMP_RATE[5:0]	R/W	000000b	Secondary ASI sample rate configuration. -Typical (Range) 0d = Secondary ASI sampling rate auto detected in the device 1d = 768000 (670320-791040) 2d = 614400 (536256-632832) 3d = 512000 (446880-527360) 4d = 438857 (383040-452022) 5d = 384000 (335160-395520) 6d = 341333 (297920-351573) 7d = 307200 (268128-316416) 8d = 256000 (223440-263680) 9d = 219429 (191520-226011) 10d = 192000 (167580-197760) 11d = 170667 (148960-175786) 12d = 153600 (134064-158208) 13d = 128000 (111720-131840) 14d = 109714 (95760-113005) 15d = 96000 (83790-98880) 16d = 85333 (74480-87893) 17d = 76800 (67032-79104) 18d = 64000 (55860-65920) 19d = 54857 (47880-56502) 20d = 48000 (41895-49440) 21d = 42667 (37240-43946) 22d = 38400 (33516-39552) 23d = 32000 (27930-32960) 24d = 27429 (23940-28251) 25d = 24000 (20947-24720) 26d = 21333 (18620-21973) 27d = 19200 (16758-19776) 28d = 16000 (13965-16480) 29d = 13714 (11970-14125) 30d = 12000 (10473-12360) 31d = 10667 (9310-10986) 32d = 9600 (8379-9888) 33d = 8000 (6982-8240) 34d = 6857 (5985-7062) 35d = 6000 (5236-6180) 36d = 5333 (4655-5493) 37d = 4800 (4189-4944) 38d = 4000 (3491-4120) 39d = 3429 (2992-3531) 40d = 3000 (2618-3090) 41d-63d = Reserved
1	SASI_FS_RATE_NO_LIM	R/W	0b	Limit sampling rate to standard audio sample rates only. 0d = Standard audio rates with 1% tolerance supported using auto mode 1d = Standard audio rates with 5% tolerance supported using auto mode
0	RESERVED	R	0b	Reserved bit; Write only reset value

8.5.1.36 CLK_CFG2 Register (Address = 0x34) [Reset = 0x40]

CLK_CFG2 is shown in 表 8-63.

Return to the [Summary Table](#).

This register is the clock configuration register 2.

表 8-63. CLK_CFG2 Register Field Descriptions

Bit	Field	Type	Reset	Description
7	PLL_DIS	R/W	0b	Custom/Auto clock mode PLL setting. 0d = PLL is always enabled in custom clk mode/PLL is enabled based on DSP MIPS requirement in auto clock mode 1d = PLL is disabled
6	AUTO_PLL_FR_ALLOW	R/W	1b	Allow the PLL to operate in fractional mode of operation. 0d = PLL fractional mode disabled 1d = PLL fractional mode allowed
5	RESERVED	R/W	0b	Reserved bit; Write only reset value
4	RESERVED	R/W	0b	Reserved bit; Write only reset value
3-1	CLK_SRC_SEL[2:0]	R/W	000b	Input clock source select. 0d = Primary ASI BCLK is the input clock source 1d = CCLK synchronized with Primary ASI FSYNC is the input clock source 2d = Secondary ASI BCLK is the input clock source 3d = CCLK synchronized with Secondary ASI FSYNC is the input clock source 4d = Fixed CCLK frequency (used only in controller mode configuration) 5d = Internal oscillator clock is the input clock source 6d to 7d = Reserved
0	RATIO_CLK_EDGE	R/W	0b	Edge selection for clock source ratio detection. 0d = Use rising edge of clock source to check ratio with primary or secondary FSYNC 1d = Use falling edge of clock source to check ratio with primary or secondary FSYNC

8.5.1.37 CNT_CLK_CFG0 Register (Address = 0x35) [Reset = 0x00]

CNT_CLK_CFG0 is shown in [表 8-64](#).

Return to the [Summary Table](#).

This register is the controller mode clock configuration register 0.

表 8-64. CNT_CLK_CFG0 Register Field Descriptions

Bit	Field	Type	Reset	Description
7-6	PDM_CLK_CFG[1:0]	R/W	00b	PDM_CLK configuration. 0d = PDM_CLK is 2.8224 MHz or 3.072 MHz 1d = PDM_CLK is 1.4112 MHz or 1.536 MHz 2d = PDM_CLK is 705.6 kHz or 768 kHz 3d = PDM_CLK is 5.6448 MHz or 6.144 MHz
5-0	CCLK_FS_RATIO_MSB[5:0]	R/W	000000b	Most significant bits for selecting the ratio between CCLK and primary/secondary ASI FSYNC with which CCLK is synchronized. 0d = Auto detect the ratio (assumption is CCLK is synchronized with primary/secondary FSYNC) 1d to 16383d = Ratio as per configuration

8.5.1.38 CNT_CLK_CFG1 Register (Address = 0x36) [Reset = 0x00]

CNT_CLK_CFG1 is shown in [表 8-65](#).

Return to the [Summary Table](#).

This register is the controller mode clock configuration register 1.

表 8-65. CNT_CLK_CFG1 Register Field Descriptions

Bit	Field	Type	Reset	Description
7-0	CCLK_FS_RATIO_LSB[7:0]	R/W	00000000b	LSB's for selecting the ratio between CCLK and primary/secondary ASI FSYNC with which CCLK is synchronized. 0d = Auto detect the ratio (assumption is CCLK is synchronized with primary/secondary FSYNC) 1d to 16383d = Ratio as per configuration

8.5.1.39 CNT_CLK_CFG2 Register (Address = 0x37) [Reset = 0x20]

CNT_CLK_CFG2 is shown in 表 8-66.

Return to the [Summary Table](#).

This register is the controller mode clock configuration register 2.

表 8-66. CNT_CLK_CFG2 Register Field Descriptions

Bit	Field	Type	Reset	Description
7-5	CCLK_FREQ_SEL[2:0]	R/W	001b	These bits select the CCLK input frequency (used only in controller mode configuration). 0d = 12 MHz 1d = 12.288 MHz 2d = 13 MHz 3d = 16 MHz 4d = 19.2 MHz 5d = 19.68 MHz 6d = 24 MHz 7d = 24.576 MHz
4	PASI_CNT_CFG	R/W	0b	Primary ASI controller or target configuration 0d = Primary ASI in target configuration 1d = Primary ASI in controller configuration
3	SASI_CNT_CFG	R/W	0b	Secondary ASI controller or target configuration 0d = Secondary ASI in target configuration 1d = Secondary ASI in controller configuration
2	RESERVED	R/W	0b	Reserved bit; Write only reset value
1	RESERVED	R/W	0b	Reserved bit; Write only reset value
0	FS_MODE	R/W	0b	Sample rate setting (valid when the device is in controller mode). This is applicable for both PASI and SASI. 0d = sampling rate is a multiple (or submultiple) of 48 kHz 1d = sampling rate is a multiple (or submultiple) of 44.1 kHz

8.5.1.40 CNT_CLK_CFG3 Register (Address = 0x38) [Reset = 0x00]

CNT_CLK_CFG3 is shown in 表 8-67.

Return to the [Summary Table](#).

This register is the controller mode clock configuration register 3.

表 8-67. CNT_CLK_CFG3 Register Field Descriptions

Bit	Field	Type	Reset	Description
7	PASI_USE_INT_BCLK_F OR_FSYNC	R/W	0b	Use internal BCLK for FSYNC generation in PASI during controller mode configuration. 0d = Use external BCLK for FSYNC generation 1d = Use internal BCLK for FSYNC generation

表 8-67. CNT_CLK_CFG3 Register Field Descriptions (続き)

Bit	Field	Type	Reset	Description
6	PASI_INV_BCLK_FOR_FSYNC	R/W	0b	Invert PASI BCLK polarity only for PASI FSYNC generation in controller mode configuration. 0d = Do not invert PASI BCLK polarity for PASI FSYNC generation 1d = Invert PASI BCLK polarity for PASI FSYNC generation
5-0	PASI_BCLK_FS_RATIO_MSB[5:0]	R/W	000000b	MSB bits for primary ASI BCLK to FSYNC ratio in controller mode.

8.5.1.41 CNT_CLK_CFG4 Register (Address = 0x39) [Reset = 0x00]

CNT_CLK_CFG4 is shown in 表 8-68.

Return to the [Summary Table](#).

This register is the controller mode clock configuration register 4.

表 8-68. CNT_CLK_CFG4 Register Field Descriptions

Bit	Field	Type	Reset	Description
7-0	PASI_BCLK_FS_RATIO_LSB[7:0]	R/W	00000000b	LSB byte for primary ASI BCLK to FSYNC ratio in controller mode.

8.5.1.42 CNT_CLK_CFG5 Register (Address = 0x3A) [Reset = 0x00]

CNT_CLK_CFG5 is shown in 表 8-69.

Return to the [Summary Table](#).

This register is the controller mode clock configuration register 5.

表 8-69. CNT_CLK_CFG5 Register Field Descriptions

Bit	Field	Type	Reset	Description
7	SASI_USE_INT_BCLK_FOR_FSYNC	R/W	0b	Use internal BCLK for FSYNC generation in SASI during controller mode configuration. 0d = Use external BCLK for FSYNC generation 1d = Use internal BCLK for FSYNC generation
6	SASI_INV_BCLK_FOR_FSYNC	R/W	0b	Invert SASI BCLK polarity only for SASI FSYNC generation in controller mode configuration. 0d = Do not invert SASI BCLK polarity for SASI FSYNC generation 1d = Invert SASI BCLK polarity for SASI FSYNC generation
5-0	SASI_BCLK_FS_RATIO_MSB[5:0]	R/W	000000b	MSB bits for secondary ASI BCLK to FSYNC ratio in controller mode.

8.5.1.43 CNT_CLK_CFG6 Register (Address = 0x3B) [Reset = 0x00]

CNT_CLK_CFG6 is shown in 表 8-70.

Return to the [Summary Table](#).

This register is the controller mode clock configuration register 6.

表 8-70. CNT_CLK_CFG6 Register Field Descriptions

Bit	Field	Type	Reset	Description
7-0	SASI_BCLK_FS_RATIO_LSB[7:0]	R/W	00000000b	LSB byte for secondary ASI BCLK to FSYNC ratio in controller mode.

8.5.1.44 CLK_ERR_STS0 Register (Address = 0x3C) [Reset = 0x00]

CLK_ERR_STS0 is shown in 表 8-71.

Return to the [Summary Table](#).

This register is the clock error and status register 0.

表 8-71. CLK_ERR_STS0 Register Field Descriptions

Bit	Field	Type	Reset	Description
7	DSP_CLK_ERR	R	0b	Flag indicating ratio error between FSYNC and selected clock source. 0d = No ratio error 1d = Ratio error between primary or secondary ASI FSYNC and selected clock source
6	RESERVED	R	0b	Reserved bit; Write only reset value
5	RESERVED	R	0b	Reserved bit; Write only reset value
4	SRC_RATIO_ERR	R	0b	Flag indicating that SRC m:n ratio is unsupported. (not valid for custom m/n ratio config). 0d = m:n ratio supported 1d = Unsupported m:n ratio error
3	DEM_RATE_ERR	R	0b	Flag indicating that clock configuration does not allow valid DEM rate. 0d = No DEM clock rate error 1d = DEM clock rate error in selected clock configuration
2	PDM_CLK_ERR	R	0b	Flag indicating that clock configuration does not allow valid PDM clock generation. 0d = No PDM clock generation error 1d = PDM clock generation error in selected clock configuration
1	RESET_ON_CLK_STOP_DET_STS	R	0b	Flag indicating that audio clock source stopped for atleast 1ms. 0d = No audio clock source error 1d = Audio clock source stopped for atleast 1ms
0	RESERVED	R	0b	Reserved bit; Write only reset value

8.5.1.45 CLK_ERR_STS1 Register (Address = 0x3D) [Reset = 0x00]

CLK_ERR_STS1 is shown in 表 8-72.

Return to the [Summary Table](#).

This register is the clock error and status register 1.

表 8-72. CLK_ERR_STS1 Register Field Descriptions

Bit	Field	Type	Reset	Description
7	PASI_BCLK_FS_RATIO_ERR	R	0b	Flag indicating PASI bclk fsync ratio error. 0d = No PASI bclk fsync ratio error 1d = PASI bclk fsync ratio error in selected clock configuration
6	SASI_BCLK_FS_RATIO_ERR	R	0b	Flag indicating SASI bclk fsync ratio error. 0d = No SASI bclk fsync ratio error 1d = SASI bclk fsync ratio error in selected clock configuration
5	CCLK_FS_RATIO_ERR	R	0b	Flag indicating CCLK fsync ratio error. 0d = No CCLK fsync ratio error 1d = CCLK fsync ratio error
4	PASI_FS_ERR	R	0b	Flag indicating PASI FS rate change or halt error. 0d = No PASI FS error 1d = PASI FS rate change or halt detected
3	SASI_FS_ERR	R	0b	Flag indicating SASI FS rate change or halt error. 0d = No SASI FS error 1d = SASI FS rate change or halt detected

表 8-72. CLK_ERR_STS1 Register Field Descriptions (続き)

Bit	Field	Type	Reset	Description
2-0	RESERVED	R	000b	Reserved bits; Write only reset values

8.5.1.46 CLK_DET_STS0 Register (Address = 0x3E) [Reset = 0x00]

CLK_DET_STS0 is shown in 表 8-73.

Return to the [Summary Table](#).

This register is the clock ratio detection register 0.

表 8-73. CLK_DET_STS0 Register Field Descriptions

Bit	Field	Type	Reset	Description
7-2	PASI_SAMP_RATE_STS[5:0]	R	000000b	Primary ASI Sample rate detected status. 0d = Reserved 1d = 768000 (670320-791040) 2d = 614400 (536256-632832) 3d = 512000 (446880-527360) 4d = 438857 (383040-452022) 5d = 384000 (335160-395520) 6d = 341333 (297920-351573) 7d = 307200 (268128-316416) 8d = 256000 (223440-263680) 9d = 219429 (191520-226011) 10d = 192000 (167580-197760) 11d = 170667 (148960-175786) 12d = 153600 (134064-158208) 13d = 128000 (111720-131840) 14d = 109714 (95760-113005) 15d = 96000 (83790-98880) 16d = 85333 (74480-87893) 17d = 76800 (67032-79104) 18d = 64000 (55860-65920) 19d = 54857 (47880-56502) 20d = 48000 (41895-49440) 21d = 42667 (37240-43946) 22d = 38400 (33516-39552) 23d = 32000 (27930-32960) 24d = 27429 (23940-28251) 25d = 24000 (20947-24720) 26d = 21333 (18620-21973) 27d = 19200 (16758-19776) 28d = 16000 (13965-16480) 29d = 13714 (11970-14125) 30d = 12000 (10473-12360) 31d = 10667 (9310-10986) 32d = 9600 (8379-9888) 33d = 8000 (6982-8240) 34d = 6857 (5985-7062) 35d = 6000 (5236-6180) 36d = 5333 (4655-5493) 37d = 4800 (4189-4944) 38d = 4000 (3491-4120) 39d = 3429 (2992-3531) 40d = 3000 (2618-3090) 41d-63d = Reserved
1-0	PLL_MODE_STS[1:0]	R	00b	PLL usage status. 0d = PLL used in integer mode 1d = PLL used in fractional mode 2d = PLL not used 3d = Reserved

8.5.1.47 CLK_DET_STS1 Register (Address = 0x3F) [Reset = 0x00]

CLK_DET_STS1 is shown in [表 8-74](#).

Return to the [Summary Table](#).

This register is the clock ratio detection register 1.

表 8-74. CLK_DET_STS1 Register Field Descriptions

Bit	Field	Type	Reset	Description
7-2	SASI_SAMP_RATE_STS[5:0]	R	000000b	Secondary ASI Sample rate detected status. 0d = Reserved 1d = 768000 (670320-791040) 2d = 614400 (536256-632832) 3d = 512000 (446880-527360) 4d = 438857 (383040-452022) 5d = 384000 (335160-395520) 6d = 341333 (297920-351573) 7d = 307200 (268128-316416) 8d = 256000 (223440-263680) 9d = 219429 (191520-226011) 10d = 192000 (167580-197760) 11d = 170667 (148960-175786) 12d = 153600 (134064-158208) 13d = 128000 (111720-131840) 14d = 109714 (95760-113005) 15d = 96000 (83790-98880) 16d = 85333 (74480-87893) 17d = 76800 (67032-79104) 18d = 64000 (55860-65920) 19d = 54857 (47880-56502) 20d = 48000 (41895-49440) 21d = 42667 (37240-43946) 22d = 38400 (33516-39552) 23d = 32000 (27930-32960) 24d = 27429 (23940-28251) 25d = 24000 (20947-24720) 26d = 21333 (18620-21973) 27d = 19200 (16758-19776) 28d = 16000 (13965-16480) 29d = 13714 (11970-14125) 30d = 12000 (10473-12360) 31d = 10667 (9310-10986) 32d = 9600 (8379-9888) 33d = 8000 (6982-8240) 34d = 6857 (5985-7062) 35d = 6000 (5236-6180) 36d = 5333 (4655-5493) 37d = 4800 (4189-4944) 38d = 4000 (3491-4120) 39d = 3429 (2992-3531) 40d = 3000 (2618-3090) 41d-63d = Reserved
1-0	RESERVED	R	00b	Reserved bits; Write only reset values

8.5.1.48 CLK_DET_STS2 Register (Address = 0x40) [Reset = 0x00]

CLK_DET_STS2 is shown in [表 8-75](#).

Return to the [Summary Table](#).

This register is the clock ratio detection register 2.

表 8-75. CLK_DET_STS2 Register Field Descriptions

Bit	Field	Type	Reset	Description
7-6	RESERVED	R	00b	Reserved bits; Write only reset values
5-0	FS_CLKSRC_RATIO_DE T_MSB_STS[5:0]	R	000000b	MSB bits for primary ASI or secondary ASI FSYNC to clock source ratio detected.

8.5.1.49 CLK_DET_STS3 Register (Address = 0x41) [Reset = 0x00]

CLK_DET_STS3 is shown in 表 8-76.

Return to the [Summary Table](#).

This register is the clock ratio detection register 3.

表 8-76. CLK_DET_STS3 Register Field Descriptions

Bit	Field	Type	Reset	Description
7-0	FS_CLKSRC_RATIO_DE T_LSB_STS[7:0]	R	00000000b	LSB byte for primary ASI or secondary ASI FSYNC to clock source ratio detected.

8.5.1.50 INT_CFG Register (Address = 0x42) [Reset = 0x00]

INT_CFG is shown in 表 8-77.

Return to the [Summary Table](#).

This register is the interrupt configuration register.

表 8-77. INT_CFG Register Field Descriptions

Bit	Field	Type	Reset	Description
7	INT_POL	R/W	0b	Interrupt polarity. 0b = Active low (IRQZ) 1b = Active high (IRQ)
6-5	INT_EVENT[1:0]	R/W	00b	Interrupt event configuration. 0d = INT asserts on any unmasked latched interrupts event 1d = INT asserts on any unmasked live interrupts event 2d = INT asserts for 2 ms (typical) for every 4-ms (typical) duration on any unmasked latched interrupts event 3d = INT asserts for 2 ms (typical) one time on each pulse for any unmasked interrupts event
4-3	PD_ON_FLT_CFG[1:0]	R/W	00b	Powerdown configuration during fault for chx and micbias. 0d = Faults are not considered for power down 1d = Only unmasked faults are considered for power down 2d = All faults are considered for powerdown 3d = Reserved
2	LTCH_READ_CFG	R/W	0b	Interrupt latch registers readback configuration. 0b = All interrupts can be read through the LTCH registers 1b = Only unmasked interrupts can be read through the LTCH registers
1	PD_ON_FLT_RCV_CFG	R/W	0b	Configuration for Powerdown ADC channels on fault 0b = Auto recovery, ADC channels are re-powered up when fault goes away 1b = Manual recovery, ADC channels are not re-powered up when fault goes away
0	LTCH_CLR_ON_READ	R/W	0b	Cfgn for clearing LTCH register bits 0 = LTCH reg bits are cleared on reg read only if live status is zero 1 = LTCH reg bits are cleared on reg read irrespective of live status

8.5.1.51 ADC_DAC_MISC_CFG Register (Address = 0x4B) [Reset = 0x00]

ADC_DAC_MISC_CFG is shown in 表 8-78.

Return to the [Summary Table](#).

Option to Mute ADC Channel in Overload Recovery Phase

表 8-78. ADC_DAC_MISC_CFG Register Field Descriptions

Bit	Field	Type	Reset	Description
7	RESERVED	R/W	0b	Reserved bit; Write only reset value
6	RESERVED	R/W	0b	Reserved bit; Write only reset value
5	RESERVED	R/W	0b	Reserved bit; Write only reset value
4	ADC_CH1_MUTE_ON_OVRLD	R/W	0b	Mute ADC channel 1 while ADC1 is in Overload Recovery Phase 0b = Disable 1b = Enable
3	ADC_CH2_MUTE_ON_OVRLD	R/W	0b	Mute ADC channel 2 while ADC2 is in Overload Recovery Phase 0b = Disable 1b = Enable
2-0	RESERVED	R	000b	Reserved bits; Write only reset values

8.5.1.52 IADC_CFG Register (Address = 0x4C) [Reset = 0x5C]

IADC_CFG is shown in 表 8-79.

Return to the [Summary Table](#).

This register is the IADC configuration register.

表 8-79. IADC_CFG Register Field Descriptions

Bit	Field	Type	Reset	Description
7-6	IADC_NSkip_SEL[1:0]	R/W	01b	IADC NSkip configuration. 0d = 384 mod clks 1d = 576 mod clks 2d = 896 mod clks 3d = 1024 mod clks 4d = 2048 mod clks 5d = 4096 mod clks 6d-7d = Reserved
5-4	IADC_NRESET_SEL[1:0]	R/W	01b	IADC NRESET configuration. 0d = 50 mod clks 1d = 75 mod clks 2d = 100 mod clks 3d = 150 mod clks
3-2	IADC_OSR_SEL[1:0]	R/W	11b	IADC OSR select configuration. 0d = 32 1d = 64 2d = 96 3d = 128
1-0	RESERVED	R	00b	Reserved bits; Write only reset values

8.5.1.53 PWR_TUNE_CFG0 Register (Address = 0x4E) [Reset = 0x00]

PWR_TUNE_CFG0 is shown in 表 8-80.

Return to the [Summary Table](#).

This register is configuration register for power tune configuration.

表 8-80. PWR_TUNE_CFG0 Register Field Descriptions

Bit	Field	Type	Reset	Description
7	ADC_CLK_BY2_MODE	R/W	0b	ADC MOD CLK select configuration. 0d = MOD CLK 3MHz 1d = MOD CLK 1.5MHz
6	ADC_CIC_ORDER	R/W	0b	ADC CIC order configuratoin. 0d = 5th order CIC 1d = 4th order CIC
5	ADC_FIR_BYPASS	R/W	0b	ADC FIR bypass configuration. 0d = Bypass disable 1d = Bypass enable
4-3	RESERVED	R/W	00b	Reserved bits; Write only reset values
2	ADC_LOW_PWR_FILTER	R/W	0b	Low Power filter configuration for ADC 0d = Disable 1d = Enable
1-0	RESERVED	R	00b	Reserved bits; Write only reset values

8.5.1.54 ADC_CH1_CFG0 Register (Address = 0x50) [Reset = 0x00]

ADC_CH1_CFG0 is shown in 表 8-81.

Return to the [Summary Table](#).

This register is configuration register 0 for ADC channel 1.

表 8-81. ADC_CH1_CFG0 Register Field Descriptions

Bit	Field	Type	Reset	Description
7-6	ADC_CH1_INSRC[1:0]	R/W	00b	ADC Channel 1 input configuration. 0d = Analog differential input 1d = Analog single-ended input 2d = Analog single-ended mux INP1 input 3d = Analog single-ended mux INM1 input
5-4	ADC_CH1_IMP[1:0]	R/W	00b	ADC Channel 1 input impedance (applicable for the analog input). 0d = Typical 5-kΩ input impedance (For 4 Vrms case it will be 10-kΩ) 1d = Typical 10-kΩ input impedance 2d = Typical 40-kΩ input impedance 3d = Reserved
3-2	ADC_CH1_CM_TOL[1:0]	R/W	00b	ADC Channel 1 input coupling (applicable for the analog input). 0d = AC-coupled input with common mode variance tolerance supported 50 mVpp for single ended and 100 mVpp for differential configuration 1d = AC-coupled / DC-coupled input with common mode variance tolerance supported 500 mVpp for single ended and 1 Vpp for differential configuration 2d = AC-coupled / DC-coupled input with common mode variance tolerance supported rail to rail (supply to ground) 3d = Reserved
1	ADC_CH1_FULLSCALE_VAL	R/W	0b	ADC Channel 1 Fullscale value for VREF=2.75 V (applicable for the analog input). 0d = 2 Vrms differential (1 Vrms for single ended operation) 1d = 4 Vrms differential (2 Vrms for single ended operation)(For AC-coupled configuration external biasing is required for input common mode, this mode supported with common mode variance tolerance rail to rail) (only 2.75 VREF supported, only supported in audio band-width mode)

表 8-81. ADC_CH1_CFG0 Register Field Descriptions (続き)

Bit	Field	Type	Reset	Description
0	ADC_CH1_BW_MODE	R/W	0b	ADC Channel 1 band-width selection. coupling (applicable for the analog input). 0d = audio band-width (24 kHz mode) 1d = wide band-width (96 kHz mode) (Supported only for 40-kΩ input impedance case)

8.5.1.55 ADC_CH_CFG Register (Address = 0x51) [Reset = 0x00]

ADC_CH_CFG is shown in 表 8-82.

Return to the [Summary Table](#).

This register is configuration register 0 for ADC channel .

表 8-82. ADC_CH_CFG Register Field Descriptions

Bit	Field	Type	Reset	Description
7	IADC_EN	R/W	0b	IADC enable configuration. 0d = IADC disabled 1d = IADC enabled
6-5	IADC_MODE[1:0]	R/W	00b	IADC mode configuration. (for single channel mode channel select is controlled by ADC_INSR SE_MUX config) 0d = One-shot single channel 1d = One-shot multi channel 2d = Sequential single channel 3d = Sequential multi channel
4	IADC_CONVST_ONESHOT	R/W	0b	IADC conversion start one shot configuration. 0d = No conversion 1d = Start one shot conversion
3	IADC_STOP_SEQ_CONV	R/W	0b	IADC stop sequential conversion configuration. 0d = Sequential conversion running 1d = Stop sequential conversion
2	IADC_ONESHOT_CONV_DONE_STS	R	0b	IADC one shot conversion done configuration. 0d = Conversion not done 1d = One shot conversion done
1-0	RESERVED	R	00b	Reserved bits; Write only reset value

8.5.1.56 ADC_CH1_CFG2 Register (Address = 0x52) [Reset = 0xA1]

ADC_CH1_CFG2 is shown in 表 8-83.

Return to the [Summary Table](#).

This register is configuration register 2 for ADC channel 1.

表 8-83. ADC_CH1_CFG2 Register Field Descriptions

Bit	Field	Type	Reset	Description
7-0	ADC_CH1_DVOL[7:0]	R/W	10100001b	Channel 1 digital volume control. 0d = Digital volume is muted 1d = Digital volume control is set to -80 dB 2d = Digital volume control is set to -79.5 dB 3d to 160d = Digital volume control is set as per configuration 161d = Digital volume control is set to 0 dB 162d = Digital volume control is set to 0.5 dB 163d to 253d = Digital volume control is set as per configuration 254d = Digital volume control is set to 46.5 dB 255d = Digital volume control is set to 47 dB

8.5.1.57 ADC_CH1_CFG3 Register (Address = 0x53) [Reset = 0x80]

ADC_CH1_CFG3 is shown in [表 8-84](#).

Return to the [Summary Table](#).

This register is configuration register 3 for ADC channel 1.

表 8-84. ADC_CH1_CFG3 Register Field Descriptions

Bit	Field	Type	Reset	Description
7-4	ADC_CH1_FGAIN[3:0]	R/W	1000b	ADC channel 1 fine gain calibration. 0d = Fine gain is set to -0.8 dB 1d = Fine gain is set to -0.7 dB 2d = Fine gain is set to -0.6 dB 3d to 7d = Fine gain is set as per configuration 8d = Fine gain is set to 0 dB 9d = Fine gain is set to 0.1 dB 10d to 13d = Fine gain is set as per configuration 14d = Fine gain is set to 0.6 dB 15d = Fine gain is set to 0.7 dB
3-0	RESERVED	R	0000b	Reserved bits; Write only reset value

8.5.1.58 ADC_CH1_CFG4 Register (Address = 0x54) [Reset = 0x00]

ADC_CH1_CFG4 is shown in [表 8-85](#).

Return to the [Summary Table](#).

This register is configuration register 4 for ADC channel 1.

表 8-85. ADC_CH1_CFG4 Register Field Descriptions

Bit	Field	Type	Reset	Description
7-2	ADC_CH1_PCAL[5:0]	R/W	000000b	ADC channel 1 phase calibration with modulator clock resolution. 0d = No phase calibration 1d = Phase calibration delay is set to one cycle of the modulator clock 2d = Phase calibration delay is set to two cycles of the modulator clock 3d to 62d = Phase calibration delay as per configuration 63d = Phase calibration delay is set to 63 cycles of the modulator clock
1-0	PCAL_ANA_DIG_SEL[1:0]	R/W	00b	PCAL support configuration. 0d = Pcal for both Ana-Dig supported 1d = Pcal for only Ana 2d = Pcal for only Dig 3d = Reserved

8.5.1.59 ADC_CH2_CFG0 Register (Address = 0x55) [Reset = 0x00]

ADC_CH2_CFG0 is shown in [表 8-86](#).

Return to the [Summary Table](#).

This register is configuration register 0 for ADC channel 2.

表 8-86. ADC_CH2_CFG0 Register Field Descriptions

Bit	Field	Type	Reset	Description
7-6	ADC_CH2_INSRC[1:0]	R/W	00b	ADC Channel 2 input configuration. 0d = Analog differential input 1d = Analog single-ended input 2d = Analog single-ended mux IN2P input 3d = Analog single-ended mux IN2M input
5-4	ADC_CH2_IMP[1:0]	R/W	00b	ADC Channel 2 input impedance (applicable for the analog input). 0d = Typical 5-kΩ input impedance (For 4 Vrms case it will be 10-kΩ) 1d = Typical 10-kΩ input impedance 2d = Typical 40-kΩ input impedance 3d = Reserved
3-2	ADC_CH2_CM_TOL[1:0]	R/W	00b	ADC Channel 2 input coupling (applicable for the analog input). 0d = AC-coupled input with common mode variance tolerance supported 50 mVpp for single ended and 100 mVpp for differential configuration 1d = AC-coupled / DC-coupled input with common mode variance tolerance supported 500 mVpp for single ended and 1 Vpp for differential configuration 2d = AC-coupled / DC-coupled input with common mode variance tolerance supported rail to rail (supply to ground) 3d = Reserved
1	ADC_CH2_FULLSCALE_VAL	R/W	0b	ADC Channel 2 Fullscale value for VREF=2.75 V (applicable for the analog input). 0d = 2 Vrms differential (1 Vrms for single ended operation) 1d = 4 Vrms differential (2 Vrms for single ended operation)(For AC-coupled configuration external biasing is required for input common mode, this mode supported with common mode variance tolerance rail to rail) (only 2.75 VREF supported, only supported in audio band-width mode)
0	ADC_CH2_BW_MODE	R/W	0b	ADC Channel 2 band-width selection. coupling (applicable for the analog input). 0d = audio band-width (24 kHz mode) 1d = wide band-width (96 kHz mode) (Supported only for 40-kΩ input impedance case)

8.5.1.60 ADC_CH2_CFG2 Register (Address = 0x57) [Reset = 0xA1]

ADC_CH2_CFG2 is shown in 表 8-87.

Return to the [Summary Table](#).

This register is configuration register 2 for channel 2.

表 8-87. ADC_CH2_CFG2 Register Field Descriptions

Bit	Field	Type	Reset	Description
7-0	ADC_CH2_DVOL[7:0]	R/W	10100001b	Channel 1 digital volume control. 0d = Digital volume is muted 1d = Digital volume control is set to -80 dB 2d = Digital volume control is set to -79.5 dB 3d to 160d = Digital volume control is set as per configuration 161d = Digital volume control is set to 0 dB 162d = Digital volume control is set to 0.5 dB 163d to 253d = Digital volume control is set as per configuration 254d = Digital volume control is set to 46.5 dB 255d = Digital volume control is set to 47 dB

8.5.1.61 ADC_CH2_CFG3 Register (Address = 0x58) [Reset = 0x80]

ADC_CH2_CFG3 is shown in 表 8-88.

Return to the [Summary Table](#).

This register is configuration register 3 for ADC Channel 2.

表 8-88. ADC_CH2_CFG3 Register Field Descriptions

Bit	Field	Type	Reset	Description
7-4	ADC_CH2_FGAIN[3:0]	R/W	1000b	ADC Channel 2 fine gain calibration. 0d = Fine gain is set to -0.8 dB 1d = Fine gain is set to -0.7 dB 2d = Fine gain is set to -0.6 dB 3d to 7d = Fine gain is set as per configuration 8d = Fine gain is set to 0 dB 9d = Fine gain is set to 0.1 dB 10d to 13d = Fine gain is set as per configuration 14d = Fine gain is set to 0.6 dB 15d = Fine gain is set to 0.7 dB
3-0	RESERVED	R	0000b	Reserved bits; Write only reset value

8.5.1.62 ADC_CH2_CFG4 Register (Address = 0x59) [Reset = 0x00]

ADC_CH2_CFG4 is shown in [表 8-89](#).

Return to the [Summary Table](#).

This register is configuration register 4 for ADC Channel 2.

表 8-89. ADC_CH2_CFG4 Register Field Descriptions

Bit	Field	Type	Reset	Description
7-2	ADC_CH2_PCAL[5:0]	R/W	000000b	ADC Channel 2 phase calibration with modulator clock resolution. 0d = No phase calibration 1d = Phase calibration delay is set to one cycle of the modulator clock 2d = Phase calibration delay is set to two cycles of the modulator clock 3d to 62d = Phase calibration delay as per configuration 63d = Phase calibration delay is set to 63 cycles of the modulator clock
1-0	RESERVED	R	00b	Reserved bits; Write only reset value

8.5.1.63 ADC_CH3_CFG0 Register (Address = 0x5A) [Reset = 0x00]

ADC_CH3_CFG0 is shown in [表 8-90](#).

Return to the [Summary Table](#).

This register is configuration register 0 for ADC channel 3.

表 8-90. ADC_CH3_CFG0 Register Field Descriptions

Bit	Field	Type	Reset	Description
7	ADC_CH3_CLONE	R/W	0b	ADC Channel 3 input configuration. 0d = clone disabled 1d = Channel 3 Digital Filter Input is generated same as Channel 1 Digital Filter Input (Cloned Input)
6-0	RESERVED	R	0000000b	Reserved bits; Write only reset value

8.5.1.64 ADC_CH3_CFG2 Register (Address = 0x5B) [Reset = 0xA1]

ADC_CH3_CFG2 is shown in [表 8-91](#).

Return to the [Summary Table](#).

This register is configuration register 2 for ADC channel 3.

表 8-91. ADC_CH3_CFG2 Register Field Descriptions

Bit	Field	Type	Reset	Description
7-0	ADC_CH3_DVOL[7:0]	R/W	10100001b	Channel 3 digital volume control. 0d = Digital volume is muted 1d = Digital volume control is set to -80 dB 2d = Digital volume control is set to -79.5 dB 3d to 160d = Digital volume control is set as per configuration 161d = Digital volume control is set to 0 dB 162d = Digital volume control is set to 0.5 dB 163d to 253d = Digital volume control is set as per configuration 254d = Digital volume control is set to 46.5 dB 255d = Digital volume control is set to 47 dB

8.5.1.65 ADC_CH3_CFG3 Register (Address = 0x5C) [Reset = 0x80]

ADC_CH3_CFG3 is shown in [表 8-92](#).

Return to the [Summary Table](#).

This register is configuration register 3 for ADC channel 3.

表 8-92. ADC_CH3_CFG3 Register Field Descriptions

Bit	Field	Type	Reset	Description
7-4	ADC_CH3_FGAIN[3:0]	R/W	1000b	ADC channel 3 fine gain calibration. 0d = Fine gain is set to -0.8 dB 1d = Fine gain is set to -0.7 dB 2d = Fine gain is set to -0.6 dB 3d to 7d = Fine gain is set as per configuration 8d = Fine gain is set to 0 dB 9d = Fine gain is set to 0.1 dB 10d to 13d = Fine gain is set as per configuration 14d = Fine gain is set to 0.6 dB 15d = Fine gain is set to 0.7 dB
3-0	RESERVED	R	0000b	Reserved bits; Write only reset value

8.5.1.66 ADC_CH3_CFG4 Register (Address = 0x5D) [Reset = 0x00]

ADC_CH3_CFG4 is shown in [表 8-93](#).

Return to the [Summary Table](#).

This register is configuration register 4 for ADC channel 3.

表 8-93. ADC_CH3_CFG4 Register Field Descriptions

Bit	Field	Type	Reset	Description
7-2	ADC_CH3_PCAL[5:0]	R/W	000000b	ADC channel 3 phase calibration with modulator clock resolution. 0d = No phase calibration 1d = Phase calibration delay is set to one cycle of the modulator clock 2d = Phase calibration delay is set to two cycles of the modulator clock 3d to 62d = Phase calibration delay as per configuration 63d = Phase calibration delay is set to 63 cycles of the modulator clock
1-0	RESERVED	R	00b	Reserved bits; Write only reset value

8.5.1.67 ADC_CH4_CFG0 Register (Address = 0x5E) [Reset = 0x00]

ADC_CH4_CFG0 is shown in [表 8-94](#).

Return to the [Summary Table](#).

This register is configuration register 0 for ADC Channel 4.

表 8-94. ADC_CH4_CFG0 Register Field Descriptions

Bit	Field	Type	Reset	Description
7	ADC_CH4_CLONE	R/W	0b	ADC Channel 4 input configuration. 0d = clone disabled 1d = Channel 4 Digital Filter Input is generated same as Channel 2 Digital Filter Input (Cloned Input)
6-0	RESERVED	R	0000000b	Reserved bits; Write only reset value

8.5.1.68 ADC_CH4_CFG2 Register (Address = 0x5F) [Reset = 0xA1]

ADC_CH4_CFG2 is shown in [表 8-95](#).

Return to the [Summary Table](#).

This register is configuration register 2 for channel 4.

表 8-95. ADC_CH4_CFG2 Register Field Descriptions

Bit	Field	Type	Reset	Description
7-0	ADC_CH4_DVOL[7:0]	R/W	10100001b	Channel 4 digital volume control. 0d = Digital volume is muted 1d = Digital volume control is set to -80 dB 2d = Digital volume control is set to -79.5 dB 3d to 160d = Digital volume control is set as per configuration 161d = Digital volume control is set to 0 dB 162d = Digital volume control is set to 0.5 dB 163d to 253d = Digital volume control is set as per configuration 254d = Digital volume control is set to 46.5 dB 255d = Digital volume control is set to 47 dB

8.5.1.69 ADC_CH4_CFG3 Register (Address = 0x60) [Reset = 0x80]

ADC_CH4_CFG3 is shown in [表 8-96](#).

Return to the [Summary Table](#).

This register is configuration register 3 for ADC Channel 4.

表 8-96. ADC_CH4_CFG3 Register Field Descriptions

Bit	Field	Type	Reset	Description
7-4	ADC_CH4_FGAIN[3:0]	R/W	1000b	ADC Channel 4 fine gain calibration. 0d = Fine gain is set to -0.8 dB 1d = Fine gain is set to -0.7 dB 2d = Fine gain is set to -0.6 dB 3d to 7d = Fine gain is set as per configuration 8d = Fine gain is set to 0 dB 9d = Fine gain is set to 0.1 dB 10d to 13d = Fine gain is set as per configuration 14d = Fine gain is set to 0.6 dB 15d = Fine gain is set to 0.7 dB
3-0	RESERVED	R	0000b	Reserved bits; Write only reset value

8.5.1.70 ADC_CH4_CFG4 Register (Address = 0x61) [Reset = 0x00]

ADC_CH4_CFG4 is shown in 表 8-97.

Return to the [Summary Table](#).

This register is configuration register 4 for ADC Channel 4.

表 8-97. ADC_CH4_CFG4 Register Field Descriptions

Bit	Field	Type	Reset	Description
7-2	ADC_CH4_PCAL[5:0]	R/W	000000b	ADC Channel 4 phase calibration with modulator clock resolution. 0d = No phase calibration 1d = Phase calibration delay is set to one cycle of the modulator clock 2d = Phase calibration delay is set to two cycles of the modulator clock 3d to 62d = Phase calibration delay as per configuration 63d = Phase calibration delay is set to 63 cycles of the modulator clock
1-0	RESERVED	R	00b	Reserved bits; Write only reset value

8.5.1.71 ADC_CFG1 Register (Address = 0x62) [Reset = 0x00]

ADC_CFG1 is shown in 表 8-98.

Return to the [Summary Table](#).

This register is configuration register for ADC.

表 8-98. ADC_CFG1 Register Field Descriptions

Bit	Field	Type	Reset	Description
7-4	ADC_PINCM_TRIM[3:0]	R/W	0000b	Bit to tweak the Input common mode of the ADC channel in AC coupled mode, connects the following resistor from input pin to AVDD 0001 = 500k 0010 = 250k 0100 = 125k 1000 = 65k
3	ADC_QUANT_OFFSET_CAL_EN	R/W	0b	Quantizer offset calibration mode
2	ADC_DATA_INVERT	R/W	0b	Bit to Invert ADC Data
1-0	RESERVED	R	00b	Reserved bits; Write only reset value

8.5.1.72 DSP_CFG0 Register (Address = 0x72) [Reset = 0x18]

DSP_CFG0 is shown in 表 8-99.

Return to the [Summary Table](#).

This register is the digital signal processor (DSP) configuration register 0.

表 8-99. DSP_CFG0 Register Field Descriptions

Bit	Field	Type	Reset	Description
7-6	ADC_DSP_DECI_FILT[1:0]	R/W	00b	ADC channel decimation filter response. 0d = Linear phase 1d = Low latency 2d = Ultra-low latency 3d = Reserved; Don't use

表 8-99. DSP_CFG0 Register Field Descriptions (続き)

Bit	Field	Type	Reset	Description
5-4	ADC_DSP_HPF_SEL[1:0]	R/W	01b	ADC channel high-pass filter (HPF) selection. 0d = Programmable first-order IIR filter for a custom HPF with default coefficient values in P10_R120-127 and P11_R8-11 set as the all-pass filter 1d = HPF with a cutoff of $0.00002 \times f_S$ (1 Hz at $f_S = 48$ kHz) is selected 2d = HPF with a cutoff of $0.00025 \times f_S$ (12 Hz at $f_S = 48$ kHz) is selected 3d = HPF with a cutoff of $0.002 \times f_S$ (96 Hz at $f_S = 48$ kHz) is selected
3-2	ADC_DSP_BQ_CFG[1:0]	R/W	10b	Number of biquads per ADC channel configuration. 0d = No biquads per channel; biquads are all disabled 1d = 1 biquad per channel 2d = 2 biquads per channel 3d = 3 biquads per channel
1	ADC_DSP_DISABLE_SOFT_STEP	R/W	0b	ADC Soft-stepping disable during DVOL change, mute, and unmute. 0d = Soft-stepping enabled 1d = Soft-stepping disabled
0	ADC_DSP_DVOL_GANG	R/W	0b	DVOL control ganged across ADC channels. 0d = Each channel has its own DVOL CTRL settings as programmed in the ADC_CHx_DVOL bits 1d = All active channels must use the channel 1 DVOL setting (ADC_CH1_DVOL) irrespective of whether channel 1 is turned on or not

8.5.1.73 CH_EN Register (Address = 0x76) [Reset = 0xCC]

CH_EN is shown in 表 8-100.

Return to the [Summary Table](#).

This register is the channel enable configuration register.

表 8-100. CH_EN Register Field Descriptions

Bit	Field	Type	Reset	Description
7	IN_CH1_EN	R/W	1b	Input channel 1 enable setting. 0d = Input channel 1 is disabled 1d = Input channel 1 is enabled
6	IN_CH2_EN	R/W	1b	Input channel 2 enable setting. 0d = Input channel 2 is disabled 1d = Input channel 2 is enabled
5	IN_CH3_EN	R/W	0b	Input channel 3 enable setting. 0d = Input channel 3 is disabled 1d = Input channel 3 is enabled
4	IN_CH4_EN	R/W	0b	Input channel 4 enable setting. 0d = Input channel 4 is disabled 1d = Input channel 4 is enabled
3	RESERVED	R/W	1b	Reserved bit; Write only reset value
2	RESERVED	R/W	1b	Reserved bit; Write only reset value
1	RESERVED	R/W	0b	Reserved bit; Write only reset value
0	RESERVED	R/W	0b	Reserved bit; Write only reset value

8.5.1.74 DYN_PUPD_CFG Register (Address = 0x77) [Reset = 0x00]

DYN_PUPD_CFG is shown in 表 8-101.

Return to the [Summary Table](#).

This register is the power-up configuration register.

表 8-101. DYN_PUPD_CFG Register Field Descriptions

Bit	Field	Type	Reset	Description
7	ADC_DYN_PUPD_EN	R/W	0b	Dynamic channel power-up, power-down enable for record path. 0d = Channel power-up, power-down is not supported if any channel recording is on 1d = Channel can be powered up or down individually, even if channel recording is on
6	ADC_DYN_MAXCH_SEL	R/W	0b	Dynamic mode maximum channel select configuration for record path. 0d = Channel 1 and channel 2 are used with dynamic channel power-up, power-down feature enabled 1d = Channel 1 to channel 4 are used with dynamic channel power-up, power-down feature enabled
5	RESERVED	R/W	0b	Reserved bit; Write only reset value
4	RESERVED	R/W	0b	Reserved bit; Write only reset value
3	DYN_PUPD_ADC_PDM_DIFF_CLK	R/W	0b	Dynamic power-up power-down with different adc mod clock and pdm clock configuration. 0d = Same ADC MOD CLK and PDM CLK in dynamic pupd 1d = Different ADC MOD CLK and PDM CLK in dynamic pupd
2-0	RESERVED	R	000b	Reserved bits; Write only reset value

8.5.1.75 PWR_CFG Register (Address = 0x78) [Reset = 0x00]

PWR_CFG is shown in [表 8-102](#).

Return to the [Summary Table](#).

This register is the power-up configuration register.

表 8-102. PWR_CFG Register Field Descriptions

Bit	Field	Type	Reset	Description
7	ADC_PDZ	R/W	0b	Power control for ADC and PDM channels. 0d = Power down all ADC and PDM channels 1d = Power up all enabled ADC and PDM channels
6	RESERVED	R/W	0b	Reserved bit; Write only reset value
5	MICBIAS_PDZ	R/W	0b	Power control for MICBIAS. 0d = Power down MICBIAS 1d = Power up MICBIAS
4	RESERVED	R	0b	Reserved bit; Write only reset value
3	UAD_EN	R/W	0b	Enable ultrasound activity detection (UAD) algorithm. 0d = UAD is disabled 1d = UAD is enabled
2	VAD_EN	R/W	0b	Enable voice activity detection (VAD) algorithm. 0d = VAD is disabled 1d = VAD is enabled
1	RESERVED	R/W	0b	Reserved bit; Write only reset value
0	RESERVED	R	0b	Reserved bit; Write only reset value

8.5.1.76 DEV_STS0 Register (Address = 0x79) [Reset = 0x00]

DEV_STS0 is shown in [表 8-103](#).

Return to the [Summary Table](#).

This register is the device status value register 0.

表 8-103. DEV_STS0 Register Field Descriptions

Bit	Field	Type	Reset	Description
7	IN_CH1_STATUS	R	0b	ADC or PDM channel 1 power status. 0d = ADC or PDM channel is powered down 1d = ADC or PDM channel is powered up
6	IN_CH2_STATUS	R	0b	ADC or PDM channel 2 power status. 0d = ADC or PDM channel is powered down 1d = ADC or PDM channel is powered up
5	IN_CH3_STATUS	R	0b	ADC or PDM channel 1 power status. 0d = ADC or PDM channel is powered down 1d = ADC or PDM channel is powered up
4	IN_CH4_STATUS	R	0b	ADC or PDM channel 2 power status. 0d = ADC or PDM channel is powered down 1d = ADC or PDM channel is powered up
3	RESERVED	R	0b	Reserved bit; Write only reset value
2	RESERVED	R	0b	Reserved bit; Write only reset value
1	RESERVED	R	0b	Reserved bit; Write only reset value
0	RESERVED	R	0b	Reserved bit; Write only reset value

8.5.1.77 DEV_STS1 Register (Address = 0x7A) [Reset = 0x80]

DEV_STS1 is shown in [表 8-104](#).

Return to the [Summary Table](#).

This register is the device status value register 1.

表 8-104. DEV_STS1 Register Field Descriptions

Bit	Field	Type	Reset	Description
7-5	MODE_STS[2:0]	R	100b	Device mode status. 0-3d = Reserved 4d = Device is in sleep mode or software shutdown mode 5d = Reserved 6d = Device is in active mode with all record and playback channels turned off 7d = Device is in active mode with at least one record or playback channel turned on
4	PLL_STS	R	0b	PLL status. 0d = PLL is not enabled 1d = PLL is enabled
3	MICBIAS_STS	R	0b	MICBIAS status. 0d = MICBIAS is disabled 1d = MICBIAS is enabled
2	RESERVED	R	0b	Reserved bit; Write only reset value
1	CHx_PD_FLT_STS	R	0b	Status for PD on INxx Analog inputs faults 0d = No ADC Channel is Powered Down due to fault/s on Analog inputs INxx 1d = Some ADC Channel is Powered Down due to fault/s on Analog inputs INxx
0	ALL_CHx_PD_FLT_STS	R	0b	Status for PD on Micbias faults 0d = No ADC Channel is Powered Down due to fault/s related to Micbias 1d = All ADC Channels are Powered Down due to fault/s related to Micbias

8.5.1.78 I2C_CKSUM Register (Address = 0x7E) [Reset = 0x00]

I2C_CKSUM is shown in [表 8-105](#).

Return to the [Summary Table](#).

This register returns the I²C transactions checksum value.

表 8-105. I2C_CKSUM Register Field Descriptions

Bit	Field	Type	Reset	Description
7-0	I2C_CKSUM[7:0]	R/W	00000000b	These bits return the I ² C transactions checksum value. Writing to this register resets the checksum to the written value. This register is updated on writes to other registers on all pages.

8.5.2 TAA5212 Registers

表 8-106 lists the memory-mapped registers for the TAA5212 registers. All register offset addresses not listed in 表 8-106 should be considered as reserved locations and the register contents should not be modified.

表 8-106. TAA5212 Registers

Address	Acronym	Register Name	Reset Value	Section
0x0	PAGE_CFG	Device page register	0x00	PAGE_CFG Register (Address = 0x0) [Reset = 0x00]
0x3	DSP_CFG0		0x00	DSP_CFG0 Register (Address = 0x3) [Reset = 0x00]
0xD	CLK_CFG0		0x00	CLK_CFG0 Register (Address = 0xD) [Reset = 0x00]
0xE	CHANNEL_CFG1		0x00	CHANNEL_CFG1 Register (Address = 0xE) [Reset = 0x00]
0x17	SRC_CFG0	SRC configuration register 1	0x00	SRC_CFG0 Register (Address = 0x17) [Reset = 0x00]
0x18	SRC_CFG1	SRC configuration register 2	0x00	SRC_CFG1 Register (Address = 0x18) [Reset = 0x00]
0x1E	LPAD_CFG1	LPAD	0x20	LPAD_CFG1 Register (Address = 0x1E) [Reset = 0x20]
0x20	LPAD_CFG1	LPAD configuration register 1	0x00	LPAD_CFG1 Register (Address = 0x1E) [Reset = 0x20]
0x24	AGC_DRC_CFG	AGC_DRC configuration register 2	0x00	AGC_DRC_CFG Register (Address = 0x24) [Reset = 0x00]
0x2C	MIXER_CFG0	MISC configuration register 0	0x00	MIXER_CFG0 Register (Address = 0x2C) [Reset = 0x00]
0x2D	MISC_CFG0	MISC configuration register 0	0x00	MISC_CFG0 Register (Address = 0x2D) [Reset = 0x00]
0x2F	INT_MASK0	Interrupt Mask Register-0	0xFF	INT_MASK0 Register (Address = 0x2F) [Reset = 0xFF]
0x33	INT_MASK5	Interrupt Mask Register-3	0x30	INT_MASK5 Register (Address = 0x33) [Reset = 0x30]
0x34	INT_LTCH0	Latched Interrupt Readback Register-0	0x00	INT_LTCH0 Register (Address = 0x34) [Reset = 0x00]
0x35	CHx_LTCH	Summary of Diagnostics	0x00	CHx_LTCH Register (Address = 0x35) [Reset = 0x00]

表 8-106. TAA5212 Registers (続き)

Address	Acronym	Register Name	Reset Value	Section
0x38	ADC_CHx_OVRD		0x00	ADC_CHx_OVRD Register (Address = 0x38) [Reset = 0x00]
0x3B	INT_LTCH2	Latched Interrupt Readback Register-3	0x00	INT_LTCH2 Register (Address = 0x3B) [Reset = 0x00]
0x3C	INT_LIVE0	Live Interrupt Readback Register-0	0x00	INT_LIVE0 Register (Address = 0x3C) [Reset = 0x00]
0x3D	CHx_LIVE	Summary of Diagnostics	0x00	CHx_LIVE Register (Address = 0x3D) [Reset = 0x00]
0x43	INT_LIVE2	Latched Interrupt Readback Register-3	0x00	INT_LIVE2 Register (Address = 0x43) [Reset = 0x00]
0x4E	DIAG_CFG8		0xBA	DIAG_CFG8 Register (Address = 0x4E) [Reset = 0xBA]
0x4F	DIAG_CFG9		0x4B	DIAG_CFG9 Register (Address = 0x4F) [Reset = 0x4B]
0x55	DIAGDATA_CFG		0x00	DIAGDATA_CFG Register (Address = 0x55) [Reset = 0x00]
0x58	DIAG_MON_MSB_MBIAS		0x00	DIAG_MON_MSB_MBIAS Register (Address = 0x58) [Reset = 0x00]
0x59	DIAG_MON_LSB_MBIAS		0x01	DIAG_MON_LSB_MBIAS Register (Address = 0x59) [Reset = 0x01]
0x6A	DIAG_MON_MSB_TEMP		0x00	DIAG_MON_MSB_TEMP Register (Address = 0x6A) [Reset = 0x00]
0x6B	DIAG_MON_LSB_TEMP		0x0A	DIAG_MON_LSB_TEMP Register (Address = 0x6B) [Reset = 0x0A]
0x6C	DIAG_MON_MSB_MBIAS_LOAD		0x00	DIAG_MON_MSB_MBIAS_LOAD Register (Address = 0x6C) [Reset = 0x00]
0x6D	DIAG_MON_LSB_MBIAS_LOAD		0x0B	DIAG_MON_LSB_MBIAS_LOAD Register (Address = 0x6D) [Reset = 0x0B]
0x6E	DIAG_MON_MSB_AVDD		0x00	DIAG_MON_MSB_AVDD Register (Address = 0x6E) [Reset = 0x00]

表 8-106. TAA5212 Registers (続き)

Address	Acronym	Register Name	Reset Value	Section
0x6F	DIAG_MON_LSB_AVDD		0x0C	DIAG_MON_LSB_A VDD Register (Address = 0x6F) [Reset = 0x0C]
0x70	DIAG_MON_MSB_GPA		0x00	DIAG_MON_MSB_ GPA Register (Address = 0x70) [Reset = 0x00]
0x71	DIAG_MON_LSB_GPA		0x0D	DIAG_MON_LSB_G PA Register (Address = 0x71) [Reset = 0x0D]

8.5.2.1 PAGE_CFG Register (Address = 0x0) [Reset = 0x00]

PAGE_CFG is shown in 表 8-107.

Return to the [Summary Table](#).

The device memory map is divided into pages. This register sets the page.

表 8-107. PAGE_CFG Register Field Descriptions

Bit	Field	Type	Reset	Description
7-0	PAGE[7:0]	R/W	00000000b	These bits set the device page. 0d = Page 0 1d = Page 1 2d to 254d = Page 2 to page 254 respectively 255d = Page 255

8.5.2.2 DSP_CFG0 Register (Address = 0x3) [Reset = 0x00]

DSP_CFG0 is shown in 表 8-108.

Return to the [Summary Table](#).

表 8-108. DSP_CFG0 Register Field Descriptions

Bit	Field	Type	Reset	Description
7	RESERVED	R/W	0b	Reserved bit; Write only reset value
6	RESERVED	R/W	0b	Reserved bit; Write only reset value
5	RESERVED	R/W	0b	Reserved bit; Write only reset value
4	RESERVED	R	0b	Reserved bit; Write only reset value
3	RESERVED	R/W	0b	Reserved bit; Write only reset value
2	RESERVED	R/W	0b	Reserved bit; Write only reset value
1	DIS_DVOL_OTF_CHG	R/W	0b	Disable run-time changes to DVOL settings. 0d = Digital volume control changes supported while ADC is powered-on 1d = Digital volume control changes not supported while ADC is powered-on.
0	EN_BQ_OTF_CHG	R/W	0b	Enable run-time changes to Biquad settings. 0d = Disable on the fly biquad changes 1d = Enable on the fly biquad changes

8.5.2.3 CLK_CFG0 Register (Address = 0xD) [Reset = 0x0D]

CLK_CFG0 is shown in 表 8-109.

Return to the [Summary Table](#).

表 8-109. CLK_CFG0 Register Field Descriptions

Bit	Field	Type	Reset	Description
7	CNT_TGT_CFG_OVR_PASI	R/W	0b	ASI controller target Config Override Register 0d = controller-target Config as per PASI_CNT_CFG bit. 1d = Override the standard behavior of the PASI_CNT_CFG. In this case the clock auto detect feature is not available. PASI_CNT_CFG = 0 : BCLK is input but FSYNC is output. PASI_CNT_CFG = 1 : BCLK is output but FSYNC in input.
6	CNT_TGT_CFG_OVR_SASI	R/W	0b	ASI controller target Config Override Register 0d = controller-target Config as per SASI_CNT_CFG bit. 1d = Override the standard behavior of the SASI_CNT_CFG. In this case the clock auto detect feature is not available. SASI_CNT_CFG = 0 : BCLK is input but FSYNC is output. SASI_CNT_CFG = 1 : BCLK is output but FSYNC in input.
5	RESERVED	R	0b	Reserved bit; Write only reset value
4-3	RESERVED	R/W	00b	Reserved bits; Write only reset values
2	PASI_USE_INT_FSYNC	R/W	0b	For Primary use internal FSYNC in controller mode configuration. 0d = Use external FSYNC 1d = Use internal FSYNC
1	SASI_USE_INT_FSYNC	R/W	0b	For Secondary use internal FSYNC in controller mode configuration. 0d = Use external FSYNC 1d = Use internal FSYNC
0	RESERVED	R/W	0b	Reserved bit; Write only reset value

8.5.2.4 CHANNEL_CFG1 Register (Address = 0xE) [Reset = 0x00]

CHANNEL_CFG1 is shown in 表 8-110.

Return to the [Summary Table](#).

表 8-110. CHANNEL_CFG1 Register Field Descriptions

Bit	Field	Type	Reset	Description
7	FORCE_DYN_MODE_CUST_MAX_CH	R/W	0b	ADC Force dynamic mode custom max channel 0d = In Dynamicmode , Max channel is based on ADC_DYN_MAXCH_SEL 1d = In Dynamic mode, max channel is custom as DYN_MODE_CUST_MAX_CH
6-3	DYN_MODE_CUST_MAX_CH[3:0]	R/W	0000b	ADC Dynamic mode custom max channel configuration [3]->CH4_EN [2]->CH3_EN [1]->CH2_EN [0]->CH1_EN
2-0	RESERVED	R	000b	Reserved bits; Write only reset values

8.5.2.5 SRC_CFG0 Register (Address = 0x17) [Reset = 0x00]

SRC_CFG0 is shown in 表 8-111.

Return to the [Summary Table](#).

This register is configuration register 1 for SRC.

表 8-111. SRC_CFG0 Register Field Descriptions

Bit	Field	Type	Reset	Description
7	SRC_EN	R/W	0b	SRC enable config 0b = SRC disable 1b = SRC enable
6	DIS_AUTO_SRC_DET	R/W	0b	SRC auto detect config 0b = SRC auto detect enabled 1b = SRC auto detect disabled
5-0	RESERVED	R	000000b	Reserved bits; Write only reset value

8.5.2.6 SRC_CFG1 Register (Address = 0x18) [Reset = 0x00]

SRC_CFG1 is shown in 表 8-112.

Return to the [Summary Table](#).

This register is configuration register 2 for SRC.

表 8-112. SRC_CFG1 Register Field Descriptions

Bit	Field	Type	Reset	Description
7	MAIN_FS_CUSTOM_CFG	R/W	0b	Main Fs custom config 0b = Main Fs is auto inferred 1b = Main Fs need to be selected from MAIN_FS_SELECT_CFG
6	MAIN_FS_SELECT_CFG	R/W	0b	Main Fs select config 0b = PASI Fs shall be used as Main Fs 1b = SASI Fs shall be used as Main Fs
5-3	MAIN_AUX_RATIO_M_C USTOM_CFG[2:0]	R/W	000b	Main and Aux Fs Ratio m:n config 0d = m is auto inferred 1d = 1 2d = 2 3d = 3 4d = 4 5d = Reserved 6d = 6 7d = Reserved
2-0	MAIN_AUX_RATIO_N_C USTOM_CFG[2:0]	R/W	000b	Main and Aux Fs Ratio m:n config 0d = n is auto inferred 1d = 1 2d = 2 3d = 3 4d = 4 5d = Reserved 6d = 6 7d = Reserved

8.5.2.7 LPAD_CFG1 Register (Address = 0x1E) [Reset = 0x20]

LPAD_CFG1 is shown in 表 8-113.

Return to the [Summary Table](#).

Low Power Activity Detection. Voice activity detection or Ultrasonic Activity detection configuration register 1

表 8-113. LPAD_CFG1 Register Field Descriptions

Bit	Field	Type	Reset	Description
7-6	LPAD_MODE[1:0]	R/W	00b	Auto ADC power up / power down configuration selection. 0d = User initiated ADC power-up and ADC power-down 1d = VAD/UAD interrupt based ADC power up and ADC power down 2d = VAD/UAD interrupt based ADC power up but user initiated ADC power down Dont use
5-4	LPAD_CH_SEL[1:0]	R/W	10b	VAD channel select. 0d = Channel 1 is monitored for VAD/UAD activity 1d = Channel 2 is monitored for VAD/UAD activity 2d = Channel 3 is monitored for VAD/UAD activity 3d = Channel 4 is monitored for VAD/UAD activity
3	LPAD_SDOUT_INT_CFG	R/W	0b	SDOUT interrupt configuration. 0d = SDOUT pin is not enabled for interrupt function 1d = SDOUT pin is enabled to support interrupt output when channel data in not being recorded
2	RESERVED	R	0b	Reserved bit; Write only reset value
1	LPAD_PD_DET_EN	R/W	0b	Enable ASI output data during VAD/UAD activity. 0d = VAD/UAD processing is not enabled during ADC recording 1d = VAD/UAD processing is enabled during ADC recording and VAD interrupts are generated as configured
0	RESERVED	R/W	0b	Reserved bit; Write only reset value

8.5.2.8 AGC_DRC_CFG Register (Address = 0x24) [Reset = 0x00]

AGC_DRC_CFG is shown in [表 8-114](#).

Return to the [Summary Table](#).

This register is configuration register 2 for AGC_DRC.

表 8-114. AGC_DRC_CFG Register Field Descriptions

Bit	Field	Type	Reset	Description
7	AGC_CH1_EN	R/W	0b	AGC Channel 1 enable config 0d = disable 1d = enable
6	AGC_CH2_EN	R/W	0b	AGC Channel 2 enable config 0d = disable 1d = enable
5	AGC_CH3_EN	R/W	0b	AGC Channel 3 enable config 0d = disable 1d = enable
4	AGC_CH4_EN	R/W	0b	AGC Channel 4 enable config 0d = disable 1d = enable
3	DRC_CH1_EN	R/W	0b	DRC Channel 1 enable config 0d = disable 1d = enable
2	DRC_CH2_EN	R/W	0b	DRC Channel 2 enable config 0d = disable 1d = enable
1	DRC_CH3_EN	R/W	0b	DRC Channel 3 enable config 0d = disable 1d = enable
0	DRC_CH4_EN	R/W	0b	DRC Channel 4 enable config 0d = disable 1d = enable

8.5.2.9 MIXER_CFG0 Register (Address = 0x2C) [Reset = 0x00]

MIXER_CFG0 is shown in [表 8-115](#).

Return to the [Summary Table](#).

This register is the MISC configuration register 0.

表 8-115. MIXER_CFG0 Register Field Descriptions

Bit	Field	Type	Reset	Description
7	RESERVED	R/W	0b	Reserved bit; Write only reset value
6	EN_SIDE_CHAIN_MIXER	R/W	0b	Enable Side Chain Mixer 0b = Disabled 1b = Enabled
5	EN_ADC_CHANNEL_MIXER	R/W	0b	Enable ADC Channel Mixer 0b = Disabled 1b = Enabled
4	RESERVED	R/W	0b	Reserved bit; Write only reset value
3-0	RESERVED	R	0000b	Reserved bits; Write only reset values

8.5.2.10 MISC_CFG0 Register (Address = 0x2D) [Reset = 0x00]

MISC_CFG0 is shown in [表 8-116](#).

Return to the [Summary Table](#).

This register is the MISC configuration register 0.

表 8-116. MISC_CFG0 Register Field Descriptions

Bit	Field	Type	Reset	Description
7	RESERVED	R/W	0b	Reserved bit; Write only reset value
6	RESERVED	R/W	0b	Reserved bit; Write only reset value
5	RESERVED	R/W	0b	Reserved bit; Write only reset value
4	EN_DRC	R/W	0b	DRC enable config 0b = DRC disable 1b = DRC enable
3	RESERVED	R/W	0b	Reserved bit; Write only reset value
2	RESERVED	R/W	0b	Reserved bit; Write only reset value
1	DSP_VBAT_AVDD_SEL	R/W	0b	SAR data source select for DSP Limiter, BOP, DRC 0b = SAR VBAT data to DSP 1b = SAR AVDD data to DSP
0	RESERVED	R/W	0b	Reserved bit; Write only reset value

8.5.2.11 INT_MASK0 Register (Address = 0x2F) [Reset = 0xFF]

INT_MASK0 is shown in [表 8-117](#).

Return to the [Summary Table](#).

Interrupt masks.

表 8-117. INT_MASK0 Register Field Descriptions

Bit	Field	Type	Reset	Description
7	INT_MASK0	R/W	1b	Clock error interrupt mask. 0b = Don't Mask 1b = Mask

表 8-117. INT_MASK0 Register Field Descriptions (続き)

Bit	Field	Type	Reset	Description
6	INT_MASK0	R/W	1b	PLL Lock interrupt mask. 0b = Don't Mask 1b = Mask
5	RESERVED	R/W	1b	Reserved bit; Write only reset value
4	RESERVED	R/W	1b	Reserved bit; Write only reset value
3	RESERVED	R/W	1b	Reserved bit; Write only reset value
2	RESERVED	R/W	1b	Reserved bit; Write only reset value
1	RESERVED	R/W	1b	Reserved bit; Write only reset value
0	RESERVED	R/W	1b	Reserved bit; Write only reset value

8.5.2.12 INT_MASK5 Register (Address = 0x33) [Reset = 0x30]

INT_MASK5 is shown in 表 8-118.

Return to the [Summary Table](#).

Interrupt masks.

表 8-118. INT_MASK5 Register Field Descriptions

Bit	Field	Type	Reset	Description
7	INT_MASK5	R/W	0b	GPA up threshold fault mask. 0b = Don't Mask 1b = Mask
6	INT_MASK5	R/W	0b	GPA low threshold fault mask. 0b = Don't Mask 1b = Mask
5	INT_MASK5	R/W	1b	VAD power up detect interrupt mask. 0b = Don't Mask 1b = Mask
4	INT_MASK5	R/W	1b	VAD power down detect interrupt mask. 0b = Don't Mask 1b = Mask
3	RESERVED	R/W	0b	Reserved bit; Write only reset value
2	RESERVED	R/W	0b	Reserved bit; Write only reset value
1	RESERVED	R/W	0b	Reserved bit; Write only reset value
0	RESERVED	R/W	0b	Reserved bit; Write only reset value

8.5.2.13 INT_LTCH0 Register (Address = 0x34) [Reset = 0x00]

INT_LTCH0 is shown in 表 8-119.

Return to the [Summary Table](#).

Latched interrupt readback.

表 8-119. INT_LTCH0 Register Field Descriptions

Bit	Field	Type	Reset	Description
7	INT_LTCH0	R	0b	Interrupt due to clock error (self clearing bit). 0b = No interrupt 1b = Interrupt
6	INT_LTCH0	R	0b	Interrupt due to PLL Lock (self clearing bit) 0b = No interrupt 1b = Interrupt

表 8-119. INT_LTCH0 Register Field Descriptions (続き)

Bit	Field	Type	Reset	Description
5	RESERVED	R	0b	Reserved bit; Write only reset value
4	RESERVED	R	0b	Reserved bit; Write only reset value
3	RESERVED	R	0b	Reserved bit; Write only reset value
2	RESERVED	R	0b	Reserved bit; Write only reset value
1	RESERVED	R	0b	Reserved bit; Write only reset value
0	RESERVED	R	0b	Reserved bit; Write only reset value

8.5.2.14 CHx_LTCH Register (Address = 0x35) [Reset = 0x00]

CHx_LTCH is shown in 表 8-120.

Return to the [Summary Table](#).

Channel level Diagnostics Latched Status

表 8-120. CHx_LTCH Register Field Descriptions

Bit	Field	Type	Reset	Description
7	STS_CHx_LTCH	R	0b	Status of Input CH1_LTCH. 0b = No faults occurred in input channel 1 1b = Fault or Faults have occurred in input channel 1
6	STS_CHx_LTCH	R	0b	Status of Input CH2_LTCH. 0b = No faults occurred in input channel 2 1b = Fault or Faults have occurred in input channel 2
5	RESERVED	R	0b	Reserved bit; Write only reset value
4	RESERVED	R	0b	Reserved bit; Write only reset value
3	RESERVED	R	0b	Reserved bit; Write only reset value
2	RESERVED	R	0b	Reserved bit; Write only reset value
1	RESERVED	R	0b	Reserved bit; Write only reset value
0	RESERVED	R	0b	Reserved bit; Write only reset value

8.5.2.15 ADC_CHx_OVRLD Register (Address = 0x38) [Reset = 0x00]

ADC_CHx_OVRLD is shown in 表 8-121.

Return to the [Summary Table](#).

表 8-121. ADC_CHx_OVRLD Register Field Descriptions

Bit	Field	Type	Reset	Description
7	RESERVED	R	0b	Reserved bit; Write only reset value
6	RESERVED	R	0b	Reserved bit; Write only reset value
5	RESERVED	R	0b	Reserved bit; Write only reset value
4	RESERVED	R	0b	Reserved bit; Write only reset value
3	MASK_ADC_CH1_OVRLD_FLAG	R/W	0b	ADC CH1 OVRLD fault mask. 0b = Don't Mask 1b = Mask
2	MASK_ADC_CH2_OVRLD_FLAG	R/W	0b	ADC CH2 OVRLD fault mask. 0b = Don't Mask 1b = Mask
1-0	RESERVED	R	00b	Reserved bits; Write only reset value

8.5.2.16 INT_LTCH2 Register (Address = 0x3B) [Reset = 0x00]

INT_LTCH2 is shown in [表 8-122](#).

Return to the [Summary Table](#).

Latched interrupt readback.

表 8-122. INT_LTCH2 Register Field Descriptions

Bit	Field	Type	Reset	Description
7	INT_LTCH2	R	0b	Interrupt due to GPA up threshold fault (self clearing bit). 0b = No interrupt 1b = Interrupt
6	INT_LTCH2	R	0b	Interrupt due to GPA low threshold fault (self clearing bit). 0b = No interrupt 1b = Interrupt
5	INT_LTCH2	R	0b	Interrupt due to VAD power up detect (self clearing bit). 0b = No interrupt 1b = Interrupt
4	INT_LTCH2	R	0b	Interrupt due to VAD power down detect (self clearing bit). 0b = No interrupt 1b = Interrupt
3	RESERVED	R	0b	Reserved bit; Write only reset value
2	RESERVED	R	0b	Reserved bit; Write only reset value
1	RESERVED	R	0b	Reserved bit; Write only reset value
0	RESERVED	R	0b	Reserved bit; Write only reset value

8.5.2.17 INT_LIVE0 Register (Address = 0x3C) [Reset = 0x00]

INT_LIVE0 is shown in [表 8-123](#).

Return to the [Summary Table](#).

Latched interrupt readback.

表 8-123. INT_LIVE0 Register Field Descriptions

Bit	Field	Type	Reset	Description
7	INT_LIVE0	R	0b	Interrupt due to clock error . 0b = No interrupt 1b = Interrupt
6	INT_LIVE0	R	0b	Interrupt due to PLL Lock 0b = No interrupt 1b = Interrupt
5	RESERVED	R	0b	Reserved bit; Write only reset value
4	RESERVED	R	0b	Reserved bit; Write only reset value
3	RESERVED	R	0b	Reserved bit; Write only reset value
2	RESERVED	R	0b	Reserved bit; Write only reset value
1	RESERVED	R	0b	Reserved bit; Write only reset value
0	RESERVED	R	0b	Reserved bit; Write only reset value

8.5.2.18 CHx_LIVE Register (Address = 0x3D) [Reset = 0x00]

CHx_LIVE is shown in [表 8-124](#).

Return to the [Summary Table](#).

Channel level Diagnostics Live Status

表 8-124. CHx_LIVE Register Field Descriptions

Bit	Field	Type	Reset	Description
7	STS_CHx_LIVE	R	0b	Status of Input CH1_LIVE. 0b = No faults occurred in input channel 1 1b = Fault or Faults have occurred in input channel 1
6	STS_CHx_LIVE	R	0b	Status of Input CH2_LIVE. 0b = No faults occurred in input channel 2 1b = Fault or Faults have occurred in input channel 2
5	RESERVED	R	0b	Reserved bit; Write only reset value
4	RESERVED	R	0b	Reserved bit; Write only reset value
3	RESERVED	R	0b	Reserved bit; Write only reset value
2	RESERVED	R	0b	Reserved bit; Write only reset value
1	RESERVED	R	0b	Reserved bit; Write only reset value
0	RESERVED	R	0b	Reserved bit; Write only reset value

8.5.2.19 INT_LIVE2 Register (Address = 0x43) [Reset = 0x00]

INT_LIVE2 is shown in 表 8-125.

Return to the [Summary Table](#).

Live interrupt readback.

表 8-125. INT_LIVE2 Register Field Descriptions

Bit	Field	Type	Reset	Description
7	INT_LIVE2	R	0b	Interrupt due to GPA up threshold fault . 0b = No interrupt 1b = Interrupt
6	INT_LIVE2	R	0b	Interrupt due to GPA low threshold fault 0b = No interrupt 1b = Interrupt
5	INT_LIVE2	R	0b	Interrupt due to VAD power up detect . 0b = No interrupt 1b = Interrupt
4	INT_LIVE2	R	0b	Interrupt due to VAD power down detect . 0b = No interrupt 1b = Interrupt
3	RESERVED	R	0b	Reserved bit; Write only reset value
2	RESERVED	R	0b	Reserved bit; Write only reset value
1	RESERVED	R	0b	Reserved bit; Write only reset value
0	RESERVED	R	0b	Reserved bit; Write only reset value

8.5.2.20 DIAG_CFG8 Register (Address = 0x4E) [Reset = 0xBA]

DIAG_CFG8 is shown in 表 8-126.

Return to the [Summary Table](#).

表 8-126. DIAG_CFG8 Register Field Descriptions

Bit	Field	Type	Reset	Description
7-0	GPA_UP_THRS_FLT_TH RES[7:0]	R/W	10111010b	General Purpose Analog High Threshold Default = ~ 2.6V $nd = ((0.9 \times (N \times 16) / 4095) - 0.225) \times 6$ (V)

8.5.2.21 DIAG_CFG9 Register (Address = 0x4F) [Reset = 0x4B]

DIAG_CFG9 is shown in 表 8-127.

Return to the [Summary Table](#).

表 8-127. DIAG_CFG9 Register Field Descriptions

Bit	Field	Type	Reset	Description
7-0	GPA_LOW_THRS_FLT_T HRES[7:0]	R/W	01001011b	General Purpose Analog Low Threshold Default = ~ 0.2V $nd = ((0.9 \times (N \times 16) / 4095) - 0.225) \times 6$ (V)

8.5.2.22 DIAGDATA_CFG Register (Address = 0x55) [Reset = 0x00]

DIAGDATA_CFG is shown in 表 8-128.

Return to the [Summary Table](#).

表 8-128. DIAGDATA_CFG Register Field Descriptions

Bit	Field	Type	Reset	Description
7-4	RESERVED	R/W	0000b	Reserved bits; Write only reset values
3	IADC_DATA_IN_DIAG_REGS	R/W	0b	IADC channel data in diagnostics channel data registers 0b= Disabled 1b= Enabled
2	HOLD_IADC_DATA	R/W	0b	Hold IADC data update during register readback 0b= Data update is not held, Data register is continuously updated 1b= Data update is held, Data register readback can be done
1	OVRD_VBAT_TEMP_DATA	R/W	0b	Override VBAT and TEMP data 0b= Override Disabled 1b= Override Enabled
0	HOLD_SAR_DATA	R/W	0b	Hold SAR data update during register readback 0b= Data update is not held, Data register is continuously updated 1b= Data update is held, Data register readback can be done

8.5.2.23 DIAG_MON_MSB_MBIAS Register (Address = 0x58) [Reset = 0x00]

DIAG_MON_MSB_MBIAS is shown in 表 8-129.

Return to the [Summary Table](#).

表 8-129. DIAG_MON_MSB_MBIAS Register Field Descriptions

Bit	Field	Type	Reset	Description
7-0	DIAG_MON_MSB_MBIAS[7:0]	R	00000000b	Diagnostic SAR Monitor Data MSB Byte

8.5.2.24 DIAG_MON_LSB_MBIAS Register (Address = 0x59) [Reset = 0x01]

DIAG_MON_LSB_MBIAS is shown in 表 8-130.

Return to the [Summary Table](#).

表 8-130. DIAG_MON_LSB_MBIAS Register Field Descriptions

Bit	Field	Type	Reset	Description
7-4	DIAG_MON_LSB_MBIAS[3:0]	R	0000b	Diagnostic SAR Monitor Data LSB Nibble
3-0	Channel[3:0]	R	0001b	Channel ID

8.5.2.25 DIAG_MON_MSB_TEMP Register (Address = 0x6A) [Reset = 0x00]

DIAG_MON_MSB_TEMP is shown in [表 8-131](#).

Return to the [Summary Table](#).

表 8-131. DIAG_MON_MSB_TEMP Register Field Descriptions

Bit	Field	Type	Reset	Description
7-0	DIAG_MON_MSB_TEMP[7:0]	R	00000000b	Diagnostic SAR Monitor Data MSB Byte

8.5.2.26 DIAG_MON_LSB_TEMP Register (Address = 0x6B) [Reset = 0x0A]

DIAG_MON_LSB_TEMP is shown in [表 8-132](#).

Return to the [Summary Table](#).

表 8-132. DIAG_MON_LSB_TEMP Register Field Descriptions

Bit	Field	Type	Reset	Description
7-4	DIAG_MON_LSB_TEMP[3:0]	R	0000b	Diagnostic SAR Monitor Data LSB Nibble
3-0	Channel[3:0]	R	1010b	Channel ID

8.5.2.27 DIAG_MON_MSB_MBIAS_LOAD Register (Address = 0x6C) [Reset = 0x00]

DIAG_MON_MSB_MBIAS_LOAD is shown in [表 8-133](#).

Return to the [Summary Table](#).

表 8-133. DIAG_MON_MSB_MBIAS_LOAD Register Field Descriptions

Bit	Field	Type	Reset	Description
7-0	DIAG_MON_MSB_MBIAS_LOAD[7:0]	R	00000000b	Diagnostic SAR Monitor Data MSB Byte

8.5.2.28 DIAG_MON_LSB_MBIAS_LOAD Register (Address = 0x6D) [Reset = 0x0B]

DIAG_MON_LSB_MBIAS_LOAD is shown in [表 8-134](#).

Return to the [Summary Table](#).

表 8-134. DIAG_MON_LSB_MBIAS_LOAD Register Field Descriptions

Bit	Field	Type	Reset	Description
7-4	DIAG_MON_LSB_MBIAS_LOAD[3:0]	R	0000b	Diagnostic SAR Monitor Data LSB Nibble
3-0	Channel[3:0]	R	1011b	Channel ID

8.5.2.29 DIAG_MON_MSB_AVDD Register (Address = 0x6E) [Reset = 0x00]

DIAG_MON_MSB_AVDD is shown in [表 8-135](#).

Return to the [Summary Table](#).

表 8-135. DIAG_MON_MSB_AVDD Register Field Descriptions

Bit	Field	Type	Reset	Description
7-0	DIAG_MON_MSB_AVDD[7:0]	R	00000000b	Diagnostic SAR Monitor Data MSB Byte

8.5.2.30 DIAG_MON_LSB_AVDD Register (Address = 0x6F) [Reset = 0x0C]

DIAG_MON_LSB_AVDD is shown in [表 8-136](#).

Return to the [Summary Table](#).

表 8-136. DIAG_MON_LSB_AVDD Register Field Descriptions

Bit	Field	Type	Reset	Description
7-4	DIAG_MON_LSB_AVDD[3:0]	R	0000b	Diagnostic SAR Monitor Data LSB Nibble
3-0	Channel[3:0]	R	1100b	Channel ID

8.5.2.31 DIAG_MON_MSB_GPA Register (Address = 0x70) [Reset = 0x00]

DIAG_MON_MSB_GPA is shown in [表 8-137](#).

Return to the [Summary Table](#).

表 8-137. DIAG_MON_MSB_GPA Register Field Descriptions

Bit	Field	Type	Reset	Description
7-0	DIAG_MON_MSB_GPA[7:0]	R	00000000b	Diagnostic SAR Monitor Data MSB Byte

8.5.2.32 DIAG_MON_LSB_GPA Register (Address = 0x71) [Reset = 0x0D]

DIAG_MON_LSB_GPA is shown in [表 8-138](#).

Return to the [Summary Table](#).

表 8-138. DIAG_MON_LSB_GPA Register Field Descriptions

Bit	Field	Type	Reset	Description
7-4	DIAG_MON_LSB_GPA[3:0]	R	0000b	Diagnostic SAR Monitor Data LSB Nibble
3-0	Channel[3:0]	R	1101b	Channel ID

8.5.3 TAA5212 Registers

表 8-139 lists the memory-mapped registers for the TAA5212 registers. All register offset addresses not listed in 表 8-139 should be considered as reserved locations and the register contents should not be modified.

表 8-139. TAA5212 Registers

Address	Acronym	Register Name	Reset Value	Section
0x0	PAGE_CFG	Device page register	0x00	PAGE_CFG Register (Address = 0x0) [Reset = 0x00]
0x1A	SASI_CFG0	Secondary ASI configuration register 0	0x30	SASI_CFG0 Register (Address = 0x1A) [Reset = 0x30]
0x1B	SASI_TX_CFG0	SASI TX configuration register 0	0x00	SASI_TX_CFG0 Register (Address = 0x1B) [Reset = 0x00]
0x1C	SASI_TX_CFG1	SASI TX configuration register 1	0x00	SASI_TX_CFG1 Register (Address = 0x1C) [Reset = 0x00]
0x1D	SASI_TX_CFG2	SASI TX configuration register 2	0x00	SASI_TX_CFG2 Register (Address = 0x1D) [Reset = 0x00]
0x1E	SASI_TX_CH1_CFG	SASI TX Channel 1 configuration register	0x00	SASI_TX_CH1_CFG Register (Address = 0x1E) [Reset = 0x00]
0x1F	SASI_TX_CH2_CFG	SASI TX Channel 2 configuration register	0x01	SASI_TX_CH2_CFG Register (Address = 0x1F) [Reset = 0x01]
0x20	SASI_TX_CH3_CFG	SASI TX Channel 3 configuration register	0x02	SASI_TX_CH3_CFG Register (Address = 0x20) [Reset = 0x02]
0x21	SASI_TX_CH4_CFG	SASI TX Channel 4 configuration register	0x03	SASI_TX_CH4_CFG Register (Address = 0x21) [Reset = 0x03]
0x22	SASI_TX_CH5_CFG	SASI TX Channel 5 configuration register	0x04	SASI_TX_CH5_CFG Register (Address = 0x22) [Reset = 0x04]
0x23	SASI_TX_CH6_CFG	SASI TX Channel 6 configuration register	0x05	SASI_TX_CH6_CFG Register (Address = 0x23) [Reset = 0x05]
0x24	SASI_TX_CH7_CFG	SASI TX Channel 7 configuration register	0x06	SASI_TX_CH7_CFG Register (Address = 0x24) [Reset = 0x06]
0x26	SASI_RX_CFG0	SASI RX configuration register 0	0x00	SASI_RX_CFG0 Register (Address = 0x26) [Reset = 0x00]
0x32	CLK_CFG12	Clock configuration register 12	0x00	CLK_CFG12 Register (Address = 0x32) [Reset = 0x00]

表 8-139. TAA5212 Registers (続き)

Address	Acronym	Register Name	Reset Value	Section
0x33	CLK_CFG13		0x00	CLK_CFG13 Register (Address = 0x33) [Reset = 0x00]
0x34	CLK_CFG14	Clock configuration register 14	0x10	CLK_CFG14 Register (Address = 0x34) [Reset = 0x10]
0x35	CLK_CFG15	Clock configuration register 15	0x01	CLK_CFG15 Register (Address = 0x35) [Reset = 0x01]
0x36	CLK_CFG16	Clock configuration register 16	0x00	CLK_CFG16 Register (Address = 0x36) [Reset = 0x00]
0x37	CLK_CFG17	Clock configuration register 17	0x00	CLK_CFG17 Register (Address = 0x37) [Reset = 0x00]
0x38	CLK_CFG18	Clock configuration register 18	0x08	CLK_CFG18 Register (Address = 0x38) [Reset = 0x08]
0x39	CLK_CFG19	Clock configuration register 19	0x20	CLK_CFG19 Register (Address = 0x39) [Reset = 0x20]
0x3A	CLK_CFG20	Clock configuration register 20	0x04	CLK_CFG20 Register (Address = 0x3A) [Reset = 0x04]
0x3C	CLK_CFG22	Clock configuration register 18	0x01	CLK_CFG22 Register (Address = 0x3C) [Reset = 0x01]
0x3D	CLK_CFG23	Clock configuration register 18	0x01	CLK_CFG23 Register (Address = 0x3D) [Reset = 0x01]
0x3E	CLK_CFG24	Clock configuration register 21	0x01	CLK_CFG24 Register (Address = 0x3E) [Reset = 0x01]
0x44	CLK_CFG30		0x00	CLK_CFG30 Register (Address = 0x44) [Reset = 0x00]
0x45	CLK_CFG31		0x00	CLK_CFG31 Register (Address = 0x45) [Reset = 0x00]
0x46	CLKOUT_CFG1	CLKOUT configuration register 1	0x00	CLKOUT_CFG1 Register (Address = 0x46) [Reset = 0x00]
0x47	CLKOUT_CFG2	CLKOUT configuration register 2	0x01	CLKOUT_CFG2 Register (Address = 0x47) [Reset = 0x01]
0x49	SARCLK_CFG1	SAR clock configuration register 1	0x00	SARCLK_CFG1 Register (Address = 0x49) [Reset = 0x00]
0x5B	ADC_OVRD_FLAG		0x00	ADC_OVRD_FLAG Register (Address = 0x5B) [Reset = 0x00]

8.5.3.1 PAGE_CFG Register (Address = 0x0) [Reset = 0x00]

PAGE_CFG is shown in [表 8-140](#).

Return to the [Summary Table](#).

The device memory map is divided into pages. This register sets the page.

表 8-140. PAGE_CFG Register Field Descriptions

Bit	Field	Type	Reset	Description
7-0	PAGE[7:0]	R/W	00000000b	These bits set the device page. 0d = Page 0 1d = Page 1 2d to 254d = Page 2 to page 254 respectively 255d = Page 255

8.5.3.2 SASI_CFG0 Register (Address = 0x1A) [Reset = 0x30]

SASI_CFG0 is shown in [表 8-141](#).

Return to the [Summary Table](#).

This register is the ASI configuration register 0.

表 8-141. SASI_CFG0 Register Field Descriptions

Bit	Field	Type	Reset	Description
7-6	SASI_FORMAT[1:0]	R/W	00b	Secondary ASI protocol format. 0d = TDM mode 1d = I ² S mode 2d = LJ (left-justified) mode 3d = Reserved; Don't use
5-4	SASI_WLEN[1:0]	R/W	11b	Secondary ASI word or slot length. 0d = 16 bits (Recommended this setting to be used with 10-kΩ input impedance configuration) 1d = 20 bits 2d = 24 bits 3d = 32 bits
3	SASI_FSYNC_POL	R/W	0b	ASI FSYNC polarity (for SASI protocol only). 0d = Default polarity as per standard protocol 1d = Inverted polarity with respect to standard protocol
2	SASI_BCLK_POL	R/W	0b	ASI BCLK polarity (for SASI protocol only). 0d = Default polarity as per standard protocol 1d = Inverted polarity with respect to standard protocol
1	SASI_BUS_ERR	R/W	0b	ASI bus error detection. 0d = Enable bus error detection 1d = Disable bus error detection
0	SASI_BUS_ERR_RCOV	R/W	0b	ASI bus error auto resume. 0d = Enable auto resume after bus error recovery 1d = Disable auto resume after bus error recovery and remain powered down until host configures the device

8.5.3.3 SASI_TX_CFG0 Register (Address = 0x1B) [Reset = 0x00]

SASI_TX_CFG0 is shown in [表 8-142](#).

Return to the [Summary Table](#).

This register is the SASI TX configuration register 0.

表 8-142. SASI_TX_CFG0 Register Field Descriptions

Bit	Field	Type	Reset	Description
7	SASI_TX_EDGE	R/W	0b	Secondary ASI data output (on the primary and secondary data pin) transmit edge. 0d = Default edge as per the protocol configuration setting in SASI_BCLK_POL 1d = Inverted following edge (half cycle delay) with respect to the default edge setting
6	SASI_TX_FILL	R/W	0b	Secondary ASI data output (on the primary and secondary data pin) for any unused cycles 0d = Always transmit 0 for unused cycles 1d = Always use Hi-Z for unused cycles
5	SASI_TX_LSB	R/W	0b	Secondary ASI data output (on the primary and secondary data pin) for LSB transmissions. 0d = Transmit the LSB for a full cycle 1d = Transmit the LSB for the first half cycle and Hi-Z for the second half cycle
4-3	SASI_TX_KEEPER[1:0]	R/W	00b	Secondary ASI data output (on the primary and secondary data pin) bus keeper. 0d = Bus keeper is always disabled 1d = Bus keeper is always enabled 2d = Bus keeper is enabled during LSB transmissions only for one cycle 3d = Bus keeper is enabled during LSB transmissions only for one and half cycles
2	SASI_TX_USE_INT_FSYNC	R/W	0b	Secondary ASI uses internal FSYNC for output data generation in controller mode configuration as applicable. 0d = Use external FSYNC for ASI protocol data generation 1d = Use internal FSYNC for ASI protocol data generation
1	SASI_TX_USE_INT_BCLK	R/W	0b	Secondary ASI uses internal BCLK for output data generation in controller mode configuration. 0d = Use external BCLK for ASI protocol data generation 1d = Use internal BCLK for ASI protocol data generation
0	SASI_TDM_PULSE_WIDTH	R/W	0b	Secondary ASI fsync pulse width in TDM format. 0d = Fsync pulse is 1 bclk period wide 1d = Fsync pulse is 2 bclk period wide

8.5.3.4 SASI_TX_CFG1 Register (Address = 0x1C) [Reset = 0x00]

SASI_TX_CFG1 is shown in 表 8-143.

Return to the [Summary Table](#).

This register is the SASI TX configuration register 1.

表 8-143. SASI_TX_CFG1 Register Field Descriptions

Bit	Field	Type	Reset	Description
7-5	RESERVED	R	000b	Reserved bits; Write only reset value

表 8-143. SASI_TX_CFG1 Register Field Descriptions (続き)

Bit	Field	Type	Reset	Description
4-0	SASI_TX_OFFSET[4:0]	R/W	00000b	Secondary ASI output data MSB slot 0 offset (on the primary and secondary data pin). 0d = ASI data MSB location has no offset and is as per standard protocol 1d = ASI data MSB location (TDM mode is slot 0 or I ² S, LJ mode is the left and right slot 0) offset of one BCLK cycle with respect to standard protocol 2d = ASI data MSB location (TDM mode is slot 0 or I ² S, LJ mode is the left and right slot 0) offset of two BCLK cycles with respect to standard protocol 3d to 30d = ASI data MSB location (TDM mode is slot 0 or I ² S, LJ mode is the left and right slot 0) offset assigned as per configuration 31d = ASI data MSB location (TDM mode is slot 0 or I ² S, LJ mode is the left and right slot 0) offset of 31 BCLK cycles with respect to standard protocol

8.5.3.5 SASI_TX_CFG2 Register (Address = 0x1D) [Reset = 0x00]

SASI_TX_CFG2 is shown in 表 8-144.

Return to the [Summary Table](#).

This register is the SASI TX configuration register 2.

表 8-144. SASI_TX_CFG2 Register Field Descriptions

Bit	Field	Type	Reset	Description
7	SASI_TX_CH8_SEL	R/W	0b	Secondary ASI output channel 8 select. 0d = Secondary ASI channel 8 output is on DOUT 1d = Secondary ASI channel 8 output is on DOUT2
6	SASI_TX_CH7_SEL	R/W	0b	Secondary ASI output channel 7 select. 0d = Secondary ASI channel 7 output is on DOUT 1d = Secondary ASI channel 7 output is on DOUT2
5	SASI_TX_CH6_SEL	R/W	0b	Secondary ASI output channel 6 select. 0d = Secondary ASI channel 6 output is on DOUT 1d = Secondary ASI channel 6 output is on DOUT2
4	SASI_TX_CH5_SEL	R/W	0b	Secondary ASI output channel 5 select. 0d = Secondary ASI channel 5 output is on DOUT 1d = Secondary ASI channel 5 output is on DOUT2
3	SASI_TX_CH4_SEL	R/W	0b	Secondary ASI output channel 4 select. 0d = Secondary ASI channel 4 output is on DOUT 1d = Secondary ASI channel 4 output is on DOUT2
2	SASI_TX_CH3_SEL	R/W	0b	Secondary ASI output channel 3 select. 0d = Secondary ASI channel 3 output is on DOUT 1d = Secondary ASI channel 3 output is on DOUT2
1	SASI_TX_CH2_SEL	R/W	0b	Secondary ASI output channel 2 select. 0d = Secondary ASI channel 2 output is on DOUT 1d = Secondary ASI channel 2 output is on DOUT2
0	SASI_TX_CH1_SEL	R/W	0b	Secondary ASI output channel 1 select. 0d = Secondary ASI channel 1 output is on DOUT 1d = Secondary ASI channel 1 output is on DOUT2

8.5.3.6 SASI_TX_CH1_CFG Register (Address = 0x1E) [Reset = 0x00]

SASI_TX_CH1_CFG is shown in 表 8-145.

Return to the [Summary Table](#).

This register is the SASI TX Channel 1 configuration register.

表 8-145. SASI_TX_CH1_CFG Register Field Descriptions

Bit	Field	Type	Reset	Description
7-6	RESERVED	R	00b	Reserved bits; Write only reset value
5	SASI_TX_CH1_CFG	R/W	0b	Secondary ASI output channel 1 configuration. 0d = Secondary ASI channel 1 output is in a tri-state condition 1d = Secondary ASI channel 1 output corresponds to ADC Channel 1 data
4-0	SASI_TX_CH1_SLOT_NUM[4:0]	R/W	00000b	Secondary ASI output channel 1 slot assignment. 0d = TDM is slot 0 or I ² S, LJ is left slot 0 1d = TDM is slot 1 or I ² S, LJ is left slot 1 2d to 14d = Slot assigned as per configuration 15d = TDM is slot 15 or I ² S, LJ is left slot 15 16d = TDM is slot 16 or I ² S, LJ is right slot 0 17d = TDM is slot 17 or I ² S, LJ is right slot 1 18d to 30d = Slot assigned as per configuration 31d = TDM is slot 31 or I ² S, LJ is right slot 15

8.5.3.7 SASI_TX_CH2_CFG Register (Address = 0x1F) [Reset = 0x01]

SASI_TX_CH2_CFG is shown in [表 8-146](#).

Return to the [Summary Table](#).

This register is the SASI TX Channel 2 configuration register.

表 8-146. SASI_TX_CH2_CFG Register Field Descriptions

Bit	Field	Type	Reset	Description
7-6	RESERVED	R	00b	Reserved bits; Write only reset value
5	SASI_TX_CH2_CFG	R/W	0b	Secondary ASI output channel 2 configuration. 0d = Secondary ASI channel 2 output is in a tri-state condition 1d = Secondary ASI channel 2 output corresponds to ADC Channel 2 data
4-0	SASI_TX_CH2_SLOT_NUM[4:0]	R/W	00001b	Secondary ASI output channel 2 slot assignment. 0d = TDM is slot 0 or I ² S, LJ is left slot 0 1d = TDM is slot 1 or I ² S, LJ is left slot 1 2d to 14d = Slot assigned as per configuration 15d = TDM is slot 15 or I ² S, LJ is left slot 15 16d = TDM is slot 16 or I ² S, LJ is right slot 0 17d = TDM is slot 17 or I ² S, LJ is right slot 1 18d to 30d = Slot assigned as per configuration 31d = TDM is slot 31 or I ² S, LJ is right slot 15

8.5.3.8 SASI_TX_CH3_CFG Register (Address = 0x20) [Reset = 0x02]

SASI_TX_CH3_CFG is shown in [表 8-147](#).

Return to the [Summary Table](#).

This register is the SASI TX Channel 3 configuration register.

表 8-147. SASI_TX_CH3_CFG Register Field Descriptions

Bit	Field	Type	Reset	Description
7	RESERVED	R	0b	Reserved bit; Write only reset value

表 8-147. SASI_TX_CH3_CFG Register Field Descriptions (続き)

Bit	Field	Type	Reset	Description
6-5	SASI_TX_CH3_CFG[1:0]	R/W	00b	Secondary ASI output channel 3 configuration. 0d = Secondary ASI channel 3 output is in a tri-state condition 1d = Secondary ASI channel 3 output corresponds to ADC Channel 3 data 2d = Secondary ASI channel 3 output corresponds to VBAT data 3d = Reserved
4-0	SASI_TX_CH3_SLOT_NUM[4:0]	R/W	00010b	Secondary ASI output channel 3 slot assignment. 0d = TDM is slot 0 or I ² S, LJ is left slot 0 1d = TDM is slot 1 or I ² S, LJ is left slot 1 2d to 14d = Slot assigned as per configuration 15d = TDM is slot 15 or I ² S, LJ is left slot 15 16d = TDM is slot 16 or I ² S, LJ is right slot 0 17d = TDM is slot 17 or I ² S, LJ is right slot 1 18d to 30d = Slot assigned as per configuration 31d = TDM is slot 31 or I ² S, LJ is right slot 15

8.5.3.9 SASI_TX_CH4_CFG Register (Address = 0x21) [Reset = 0x03]

SASI_TX_CH4_CFG is shown in 表 8-148.

Return to the [Summary Table](#).

This register is the SASI TX Channel 4 configuration register.

表 8-148. SASI_TX_CH4_CFG Register Field Descriptions

Bit	Field	Type	Reset	Description
7	RESERVED	R	0b	Reserved bit; Write only reset value
6-5	SASI_TX_CH4_CFG[1:0]	R/W	00b	Secondary ASI output channel 4 configuration. 0d = Secondary ASI channel 4 output is in a tri-state condition 1d = Secondary ASI channel 4 output corresponds to ADC Channel 4 data 2d = Secondary ASI channel 4 output corresponds to TEMP data 3d = Reserved
4-0	SASI_TX_CH4_SLOT_NUM[4:0]	R/W	00011b	Secondary ASI output channel 4 slot assignment. 0d = TDM is slot 0 or I ² S, LJ is left slot 0 1d = TDM is slot 1 or I ² S, LJ is left slot 1 2d to 14d = Slot assigned as per configuration 15d = TDM is slot 15 or I ² S, LJ is left slot 15 16d = TDM is slot 16 or I ² S, LJ is right slot 0 17d = TDM is slot 17 or I ² S, LJ is right slot 1 18d to 30d = Slot assigned as per configuration 31d = TDM is slot 31 or I ² S, LJ is right slot 15

8.5.3.10 SASI_TX_CH5_CFG Register (Address = 0x22) [Reset = 0x04]

SASI_TX_CH5_CFG is shown in 表 8-149.

Return to the [Summary Table](#).

This register is the SASI TX Channel 5 configuration register.

表 8-149. SASI_TX_CH5_CFG Register Field Descriptions

Bit	Field	Type	Reset	Description
7	RESERVED	R	0b	Reserved bit; Write only reset value

表 8-149. SASI_TX_CH5_CFG Register Field Descriptions (続き)

Bit	Field	Type	Reset	Description
6-5	SASI_TX_CH5_CFG[1:0]	R/W	00b	Secondary ASI output channel 5 configuration. 0d = Secondary ASI channel 5 output is in a tri-state condition 1d = Secondary ASI channel 5 output corresponds to ASI Input Channel 1 loopback data Dont use Dont use
4-0	SASI_TX_CH5_SLOT_NUM[4:0]	R/W	00100b	Secondary ASI output channel 5 slot assignment. 0d = TDM is slot 0 or I ² S, LJ is left slot 0 1d = TDM is slot 1 or I ² S, LJ is left slot 1 2d to 14d = Slot assigned as per configuration 15d = TDM is slot 15 or I ² S, LJ is left slot 15 16d = TDM is slot 16 or I ² S, LJ is right slot 0 17d = TDM is slot 17 or I ² S, LJ is right slot 1 18d to 30d = Slot assigned as per configuration 31d = TDM is slot 31 or I ² S, LJ is right slot 15

8.5.3.11 SASI_TX_CH6_CFG Register (Address = 0x23) [Reset = 0x05]

SASI_TX_CH6_CFG is shown in 表 8-150.

Return to the [Summary Table](#).

This register is the SASI TX Channel 6 configuration register.

表 8-150. SASI_TX_CH6_CFG Register Field Descriptions

Bit	Field	Type	Reset	Description
7	RESERVED	R	0b	Reserved bit; Write only reset value
6-5	SASI_TX_CH6_CFG[1:0]	R/W	00b	Secondary ASI output channel 6 configuration. 0d = Secondary ASI channel 6 output is in a tri-state condition 1d = Secondary ASI channel 6 output corresponds to ASI Input Channel 2 loopback data Dont use Dont use
4-0	SASI_TX_CH6_SLOT_NUM[4:0]	R/W	00101b	Secondary ASI output channel 6 slot assignment. 0d = TDM is slot 0 or I ² S, LJ is left slot 0 1d = TDM is slot 1 or I ² S, LJ is left slot 1 2d to 14d = Slot assigned as per configuration 15d = TDM is slot 15 or I ² S, LJ is left slot 15 16d = TDM is slot 16 or I ² S, LJ is right slot 0 17d = TDM is slot 17 or I ² S, LJ is right slot 1 18d to 30d = Slot assigned as per configuration 31d = TDM is slot 31 or I ² S, LJ is right slot 15

8.5.3.12 SASI_TX_CH7_CFG Register (Address = 0x24) [Reset = 0x06]

SASI_TX_CH7_CFG is shown in 表 8-151.

Return to the [Summary Table](#).

This register is the SASI TX Channel 7 configuration register.

表 8-151. SASI_TX_CH7_CFG Register Field Descriptions

Bit	Field	Type	Reset	Description
7	RESERVED	R	0b	Reserved bit; Write only reset value

表 8-151. SASI_TX_CH7_CFG Register Field Descriptions (続き)

Bit	Field	Type	Reset	Description
6-5	SASI_TX_CH7_CFG[1:0]	R/W	00b	Secondary ASI output channel 7 configuration. 0d = Secondary ASI channel 7 output is in a tri-state condition 1d = Secondary ASI channel 7 output corresponds to {VBAT_WLby2, TEMP_WLby2} Dont use Dont use
4-0	SASI_TX_CH7_SLOT_NUM[4:0]	R/W	00110b	Secondary ASI output channel 7 slot assignment. 0d = TDM is slot 0 or I ² S, LJ is left slot 0 1d = TDM is slot 1 or I ² S, LJ is left slot 1 2d to 14d = Slot assigned as per configuration 15d = TDM is slot 15 or I ² S, LJ is left slot 15 16d = TDM is slot 16 or I ² S, LJ is right slot 0 17d = TDM is slot 17 or I ² S, LJ is right slot 1 18d to 30d = Slot assigned as per configuration 31d = TDM is slot 31 or I ² S, LJ is right slot 15

8.5.3.13 SASI_RX_CFG0 Register (Address = 0x26) [Reset = 0x00]

SASI_RX_CFG0 is shown in 表 8-152.

Return to the [Summary Table](#).

This register is the SASI RX configuration register 0.

表 8-152. SASI_RX_CFG0 Register Field Descriptions

Bit	Field	Type	Reset	Description
7	SASI_RX_EDGE	R/W	0b	Secondary ASI data input (on the primary and secondary data pin) receive edge. 0d = Default edge as per the protocol configuration setting in bit 2 (BCLK_POL) 1d = Inverted following edge (half cycle delay) with respect to the default edge setting
6	SASI_RX_USE_INT_FSYNC	R/W	0b	Secondary ASI uses internal FSYNC for input data latching in controller mode configuration as applicable. 0d = Use external FSYNC for ASI protocol data latching 1d = Use internal FSYNC for ASI protocol data latching
5	SASI_RX_USE_INT_BCLK	R/W	0b	Secondary ASI uses internal BCLK for input data latching in controller mode configuration. 0d = Use external BCLK for ASI protocol data latching 1d = Use internal BCLK for ASI protocol data latching
4-0	SASI_RX_OFFSET[4:0]	R/W	00000b	Secondary ASI data input MSB slot 0 offset (on the primary and secondary data pin). 0d = ASI data MSB location has no offset and is as per standard protocol 1d = ASI data MSB location (TDM mode is slot 0 or I ² S, LJ mode is the left and right slot 0) offset of one BCLK cycle with respect to standard protocol 2d = ASI data MSB location (TDM mode is slot 0 or I ² S, LJ mode is the left and right slot 0) offset of two BCLK cycles with respect to standard protocol 3d to 30d = ASI data MSB location (TDM mode is slot 0 or I ² S, LJ mode is the left and right slot 0) offset assigned as per configuration 31d = ASI data MSB location (TDM mode is slot 0 or I ² S, LJ mode is the left and right slot 0) offset of 31 BCLK cycles with respect to standard protocol

8.5.3.14 CLK_CFG12 Register (Address = 0x32) [Reset = 0x00]

CLK_CFG12 is shown in 表 8-153.

Return to the [Summary Table](#).

This register is the clock configuration register 12.

表 8-153. CLK_CFG12 Register Field Descriptions

Bit	Field	Type	Reset	Description
7-6	PDIV_CLKSRC_SEL[1:0]	R/W	00b	Source clock selection for PLL PDIV Divider. 0d = PLL_PDIV_IN_CLK is Primary ASI BCLK 1d = PLL_PDIV_IN_CLK is Secondary ASI BCLK 2d = PLL_PDIV_IN_CLK is CCLK 3d = PLL_PDIV_IN_CLK is internal Oscillator Clock
5-3	PASI_BCLK_DIV_CLK_SEL[2:0]	R/W	000b	Primary ASI BCLK divider clock source selection. 0d = Primary ASI BCLK divider clock source is PLL output 1d = Reserved 2d = Primary ASI BCLK divider clock source is secondary ASI BCLK 3d = Primary ASI BCLK divider clock source is CCLK 4d = Primary ASI BCLK divider clock source is internal oscillator clock 5d = Primary ASI BCLK divider clock source is DSP clock 6d to 7d = Reserved
2-0	RESERVED	R	000b	Reserved bits; Write only reset value

8.5.3.15 CLK_CFG13 Register (Address = 0x33) [Reset = 0x00]

CLK_CFG13 is shown in 表 8-154.

Return to the [Summary Table](#).

表 8-154. CLK_CFG13 Register Field Descriptions

Bit	Field	Type	Reset	Description
7	RESERVED	R	0b	Reserved bit; Write only reset value
6-4	SASI_BCLK_DIV_CLK_SEL[2:0]	R/W	000b	Secondary ASI BCLK divider clock source selection. 0d = Secondary ASI BCLK divider clock source is PLL output 1d = Secondary ASI BCLK divider clock source is primary ASI BCLK 2d = Reserved 3d = Secondary ASI BCLK divider clock source is CCLK 4d = Secondary ASI BCLK divider clock source is internal oscillator clock 5d = Secondary ASI BCLK divider clock source is DSP clock 6d to 7d = Reserved
3-0	RESERVED	R	0000b	Reserved bits; Write only reset value

8.5.3.16 CLK_CFG14 Register (Address = 0x34) [Reset = 0x10]

CLK_CFG14 is shown in 表 8-155.

Return to the [Summary Table](#).

This register is the clock configuration register 14.

表 8-155. CLK_CFG14 Register Field Descriptions

Bit	Field	Type	Reset	Description
7-6	DIG_NM_DIV_CLK_SRC_SEL[1:0]	R/W	00b	Source clock selection for DIG NMDIV CLK clock. 0d = DIG NM divider input clock is Primary ASI BCLK 1d = DIG NM divider input clock is Secondary ASI BCLK 2d = DIG NM divider input clock is CCLK 3d = DIG NM divider input clock is internal oscillator clock
5-4	ANA_NM_DIV_CLK_SRC_SEL[1:0]	R/W	01b	Source clock selection for NMDIV CLK clock. 0d = NM divider input clock is PLL Output 1d = NM divider input clock is PLL Output 2d = NM divider input clock is DIG NM Divider Clock Source 3d = NM divider input clock is Primary ASI BCLK (Low Jitter Path)
3-2	RESERVED	R/W	00b	Reserved bits; Write only reset values
1-0	RESERVED	R/W	00b	Reserved bits; Write only reset values

8.5.3.17 CLK_CFG15 Register (Address = 0x35) [Reset = 0x01]

CLK_CFG15 is shown in 表 8-156.

Return to the [Summary Table](#).

This register is the clock configuration register 15.

表 8-156. CLK_CFG15 Register Field Descriptions

Bit	Field	Type	Reset	Description
7-0	PLL_PDIV[7:0]	R/W	00000001b	PLL pre-scaler P-divider value (Don't care when auto detection is enabled) 0d = PLL PDIV value is 256 1d = PLL PDIV value is 1 2d = PLL PDIV value is 2 3d to 254d = PLL PDIV value is as per configuration 255d = PLL PDIV value is 255

8.5.3.18 CLK_CFG16 Register (Address = 0x36) [Reset = 0x00]

CLK_CFG16 is shown in 表 8-157.

Return to the [Summary Table](#).

This register is the clock configuration register 16.

表 8-157. CLK_CFG16 Register Field Descriptions

Bit	Field	Type	Reset	Description
7	PLL_JMUL_MSB	R/W	0b	PLL integer portion J-multiplier value MSB bit. (Don't care when auto detection is enabled)
6	PLL_DIV_CLK_DIV_BY_2	R/W	0b	PLL DIV clock divide by 2 configuration 0d = No divide/2 inside PLL 1d = PLL does a divide/2
5-0	PLL_DMUL_MSB[5:0]	R/W	000000b	PLL fractional portion D-multiplier value MSB bits. (Don't care when auto detection is enabled)

8.5.3.19 CLK_CFG17 Register (Address = 0x37) [Reset = 0x00]

CLK_CFG17 is shown in 表 8-158.

Return to the [Summary Table](#).

This register is the clock configuration register 17.

表 8-158. CLK_CFG17 Register Field Descriptions

Bit	Field	Type	Reset	Description
7-0	PLL_DMUL_LSB[7:0]	R/W	00000000b	PLL fractional portion D-multiplier value LSB byte. Above D-multiplier value MSB bits (PLL_DMUL_MSB) along with this LSB byte (PLL_DMUL_LSB) is concatenated to determine final D-multiplier value. (Don't care when auto detection is enabled) 0d = PLL DMUL value is 0 1d = PLL DMUL value is 1 2d = PLL DMUL value is 2 3d to 9998d = PLL JMUL value is as per configuration 9999d = PLL JMUL value is 9999 10000d to 16383d = Reserved; Don't use

8.5.3.20 CLK_CFG18 Register (Address = 0x38) [Reset = 0x08]

CLK_CFG18 is shown in 表 8-159.

Return to the [Summary Table](#).

This register is the clock configuration register 18.

表 8-159. CLK_CFG18 Register Field Descriptions

Bit	Field	Type	Reset	Description
7-0	PLL_JMUL_LSB[7:0]	R/W	00001000b	PLL integer portion J-multiplier value LSB byte. Above J-multiplier value MSB bit (PLL_JMUL_MSB) along with this LSB byte (PLL_JMUL_LSB) is concatenated to determine final J-multiplier value. (Don't care when auto detection is enabled) 0d = Reserved; Don't use 1d = PLL JMUL value is 1 2d = PLL JMUL value is 2 3d to 510d = PLL JMUL value is as per configuration 511d = PLL JMUL value is 511

8.5.3.21 CLK_CFG19 Register (Address = 0x39) [Reset = 0x20]

CLK_CFG19 is shown in 表 8-160.

Return to the [Summary Table](#).

This register is the clock configuration register 19.

表 8-160. CLK_CFG19 Register Field Descriptions

Bit	Field	Type	Reset	Description
7-5	NDIV[2:0]	R/W	001b	NDIV divider value. (Don't care when auto detection is enabled) 0d = NDIV value is 8 1d = NDIV value is 1 2d = NDIV value is 2 3d to 6d = NDIV value is as per configuration 7d = NDIV value is 7
4-2	PDM_DIV[2:0]	R/W	000b	PDM divider value. (Don't care when auto detection is enabled) 0d = PDM_DIV value is 1 1d = PDM_DIV value is 2 2d = PDM_DIV value is 4 3d = PDM_DIV value is 8 4d = PDM_DIV value is 16 5d-7d Reserved
1-0	RESERVED	R/W	00b	Reserved bits; Write only reset values

8.5.3.22 CLK_CFG20 Register (Address = 0x3A) [Reset = 0x04]

CLK_CFG20 is shown in 表 8-161.

Return to the [Summary Table](#).

This register is the clock configuration register 20.

表 8-161. CLK_CFG20 Register Field Descriptions

Bit	Field	Type	Reset	Description
7-2	MDIV[5:0]	R/W	000001b	MDIV divider value. (Don't care when auto detection is enabled) 0d = MDIV value is 64 1d = MDIV value is 1 2d = MDIV value is 2 3d to 62d = MDIV value is as per configuration 63d = MDIV value is 63
1-0	DIG_ADC_MODCLK_DIV[1:0]	R/W	00b	ADC modulator clock divider value. (Don't care when auto detection is enabled) 0d = DIG_ADC_MODCLK_DIV value is 1 1d = DIG_ADC_MODCLK_DIV value is 2 2d = DIG_ADC_MODCLK_DIV value is 4 3d = Reserved

8.5.3.23 CLK_CFG22 Register (Address = 0x3C) [Reset = 0x01]

CLK_CFG22 is shown in 表 8-162.

Return to the [Summary Table](#).

This register is the clock configuration register 18.

表 8-162. CLK_CFG22 Register Field Descriptions

Bit	Field	Type	Reset	Description
7-0	PASI_BDIV_LSB[7:0]	R/W	00000001b	Secondary ASI BCLK divider value. (Don't care when auto detection is enabled) 0d = SASI BCLK divider value is 512 1d = SASI BCLK divider value is 1 2d = SASI BCLK divider value is 2 3d to 62d = SASI BCLK divider value is as per configuration 63d = SASI BCLK divider value is 511

8.5.3.24 CLK_CFG23 Register (Address = 0x3D) [Reset = 0x01]

CLK_CFG23 is shown in 表 8-163.

Return to the [Summary Table](#).

This register is the clock configuration register 18.

表 8-163. CLK_CFG23 Register Field Descriptions

Bit	Field	Type	Reset	Description
7-0	SASI_BDIV_LSB[7:0]	R/W	00000001b	Secondary ASI BCLK divider value. (Don't care when auto detection is enabled) 0d = SASI BCLK divider value is 512 1d = SASI BCLK divider value is 1 2d = SASI BCLK divider value is 2 3d to 62d = SASI BCLK divider value is as per configuration 63d = SASI BCLK divider value is 511

8.5.3.25 CLK_CFG24 Register (Address = 0x3E) [Reset = 0x01]

CLK_CFG24 is shown in 表 8-164.

Return to the [Summary Table](#).

This register is the clock configuration register 21.

表 8-164. CLK_CFG24 Register Field Descriptions

Bit	Field	Type	Reset	Description
7-6	RESERVED	R	00b	Reserved bits; Write only reset value
5-0	ANA_NM_DIV[5:0]	R/W	000001b	Analog N-M DIV divider value. (Don't care when auto detection is enabled) 0d = ANA_NM_DIV value is 64 1d = ANA_NM_DIV value is 1 2d = ANA_NM_DIV value is 2 3d to 62d = ANA_NM_DIV value is as per configuration 63d = NDIV value is 63

8.5.3.26 CLK_CFG30 Register (Address = 0x44) [Reset = 0x00]

CLK_CFG30 is shown in 表 8-165.

Return to the [Summary Table](#).

表 8-165. CLK_CFG30 Register Field Descriptions

Bit	Field	Type	Reset	Description
7-3	RESERVED	R	00000b	Reserved bits; Write only reset value
2	NDIV_EN	R/W	0b	NDIV divider enable 0d = divider disabled 1d = divider enabled
1	MDIV_EN	R/W	0b	MDIV divider enable 0d = divider disabled 1d = divider enabled
0	PDM_DIV_EN	R/W	0b	PDM divider enable 0d = divider disabled 1d = divider enabled

8.5.3.27 CLK_CFG31 Register (Address = 0x45) [Reset = 0x00]

CLK_CFG31 is shown in 表 8-166.

Return to the [Summary Table](#).

表 8-166. CLK_CFG31 Register Field Descriptions

Bit	Field	Type	Reset	Description
7	RESERVED	R/W	0b	Reserved bit; Write only reset value
6	DIG_ADC_MODCLK_DIV_EN	R/W	0b	ADC MODCLK divider enable 0d = divider disabled 1d = divider enabled
5	RESERVED	R/W	0b	Reserved bit; Write only reset value
4	RESERVED	R/W	0b	Reserved bit; Write only reset value
3	PASI_BDIV_EN	R/W	0b	PASI BDIV divider enable 0d = divider disabled 1d = divider enabled
2	SASI_BDIV_EN	R/W	0b	SASI BDIV divider enable 0d = divider disabled 1d = divider enabled

表 8-166. CLK_CFG31 Register Field Descriptions (続き)

Bit	Field	Type	Reset	Description
1	PASI_FSYNC_DIV_EN	R/W	0b	PASI FSYNC DIV divider enable 0d = divider disabled 1d = divider enabled
0	SASI_FSYNC_DIV_EN	R/W	0b	SASI FSYNC DIV divider enable 0d = divider disabled 1d = divider enabled

8.5.3.28 CLKOUT_CFG1 Register (Address = 0x46) [Reset = 0x00]

CLKOUT_CFG1 is shown in 表 8-167.

Return to the [Summary Table](#).

This register is the CLKOUT configuration register 1.

表 8-167. CLKOUT_CFG1 Register Field Descriptions

Bit	Field	Type	Reset	Description
7-3	RESERVED	R	00000b	Reserved bits; Write only reset value
2-0	CLKOUT_CLK_SEL[2:0]	R/W	000b	General Purpose CLKOUT divider clock source selection. 0d = Source clock is PLL output 1d = Source clock is primary ASI BCLK 2d = Source clock is secondary ASI BCLK 3d = Source clock is CCLK 4d = Source clock is internal oscillator clock 5d = Source clock is DSP clock 6d to 7d = Reserved

8.5.3.29 CLKOUT_CFG2 Register (Address = 0x47) [Reset = 0x01]

CLKOUT_CFG2 is shown in 表 8-168.

Return to the [Summary Table](#).

This register is the CLKOUT configuration register 2.

表 8-168. CLKOUT_CFG2 Register Field Descriptions

Bit	Field	Type	Reset	Description
7	CLKOUT_DIV_EN	R/W	0b	CLKOUT divider enable. 0d = CLKOUT divider disabled 1d = CLKOUT divider enabled
6-0	CLKOUT_DIV[6:0]	R/W	0000001b	CLKOUT DIV divider value. 0d = CLKOUT_DIV value is 128 1d = CLKOUT_DIV value is 1 2d = CLKOUT_DIV value is 2 3d to 126d = CLKOUT_DIV value is as per configuration 127d = CLKOUT_DIV value is 127

8.5.3.30 SARCLK_CFG1 Register (Address = 0x49) [Reset = 0x00]

SARCLK_CFG1 is shown in 表 8-169.

Return to the [Summary Table](#).

This register is the SAR clock configuration register 1

表 8-169. SARCLK_CFG1 Register Field Descriptions

Bit	Field	Type	Reset	Description
7-6	SAR_CLK_FREQ_SEL[1:0]	R/W	00b	SAR clock frequency mode 0d = SAR clock frequency is ~6MHz 1d = SAR clock frequency is ~3MHz 2d = SAR clock frequency is ~1.5MHz 3d = SAR clock frequency is ~12MHz (valid only when SAR clock is generated directly using internal oscillator clock)
5	SAR_CLK_SRC_AUTO_DISABLE	R/W	0b	SAR divider source clock auto selection disable 0d = SAR divider source clock auto-selection based on clock detection scheme 1d = SAR divider source clock auto-selection disabled and selected based on BST_CLK_SRC_SEL
4	SAR_CLK_SRC_MANUAL_SELECT	R/W	0b	SAR clock source manual selection (don't care in auto mode) 0d = SAR clock generated based on Audio clock available for ADC/DAC 1d = SAR clock generated based on internal oscillator clock
3	SAR_CLK_EN_AUTO_DISABLE	R/W	0b	SAR divider source clock auto selection disable 0d = SAR divider auto-enabled 1d = SAR divider enabled/disabled based on manual control using BST_CLK_EN
2	SAR_CLK_MANUAL_EN	R/W	0b	SAR divider manual enable (don't care in auto mode) 0d = SAR divider disabled 1d = SAR divider enabled
1-0	SAR_CLK_MANUAL_DIV[1:0]	R/W	00b	SAR divider value (don't care in auto mode) 0d = SAR divider value is 1 1d = SAR divider value is 2 2d = SAR divider value is 4 3d = SAR divider value is 8

8.5.3.31 ADC_OVRD_FLAG Register (Address = 0x5B) [Reset = 0x00]

ADC_OVRD_FLAG is shown in 表 8-170.

Return to the [Summary Table](#).

表 8-170. ADC_OVRD_FLAG Register Field Descriptions

Bit	Field	Type	Reset	Description
7	ADC_CH1_OVRD_LTCH	R	0b	ADC CH1 OVRD fault (self clearing bit). 0b = No ADC CH1 OVRD fault 1b = ADC CH1 OVRD fault
6	ADC_CH2_OVRD_LTCH	R	0b	ADC CH2 OVRD fault (self clearing bit). 0b = No ADC CH2 OVRD fault 1b = ADC CH2 OVRD fault
5	ADC_CH1_OVRD_LIVE	R	0b	ADC CH1 OVRD fault (self clearing bit). 0b = No ADC CH1 OVRD fault 1b = ADC CH1 OVRD fault
4	ADC_CH2_OVRD_LIVE	R	0b	ADC CH2 OVRD fault (self clearing bit). 0b = No ADC CH2 OVRD fault 1b = ADC CH2 OVRD fault
3-0	RESERVED	R	0000b	Reserved bits; Write only reset value

8.6 Feature Description

8.7 Device Functional Modes

9 Application and Implementation

注

Information in the following applications sections is not part of the TI component specification, and TI does not warrant its accuracy or completeness. TI's customers are responsible for determining suitability of components for their purposes, as well as validating and testing their design implementation to confirm system functionality.

9.1 Application Information

The TAA5212 is a stereo, high-performance audio ADC that supports sample rates of up to 768 kHz. The device supports up to a total of 4 microphones for simultaneous recording which can be selected from up to 2 analog microphones or 4 digital pulse density modulation (PDM) microphones.

Communication to the TAA5212 for configuration of the control registers is supported using an I²C or SPI interface. The device supports a highly flexible, audio serial interface (TDM, I²S, and LJ) to transmit audio data seamlessly in the system across devices.

9.2 Typical Application

9.2.1 Application

Figure 9-1 shows a typical configuration of the TAA5212 for an application using two analog ECM microphones for simultaneous recording with an I²C control interface and a time-division multiplexing (TDM) audio data target interface. For best distortion performance, use input AC-coupling capacitors with a low-voltage coefficient.

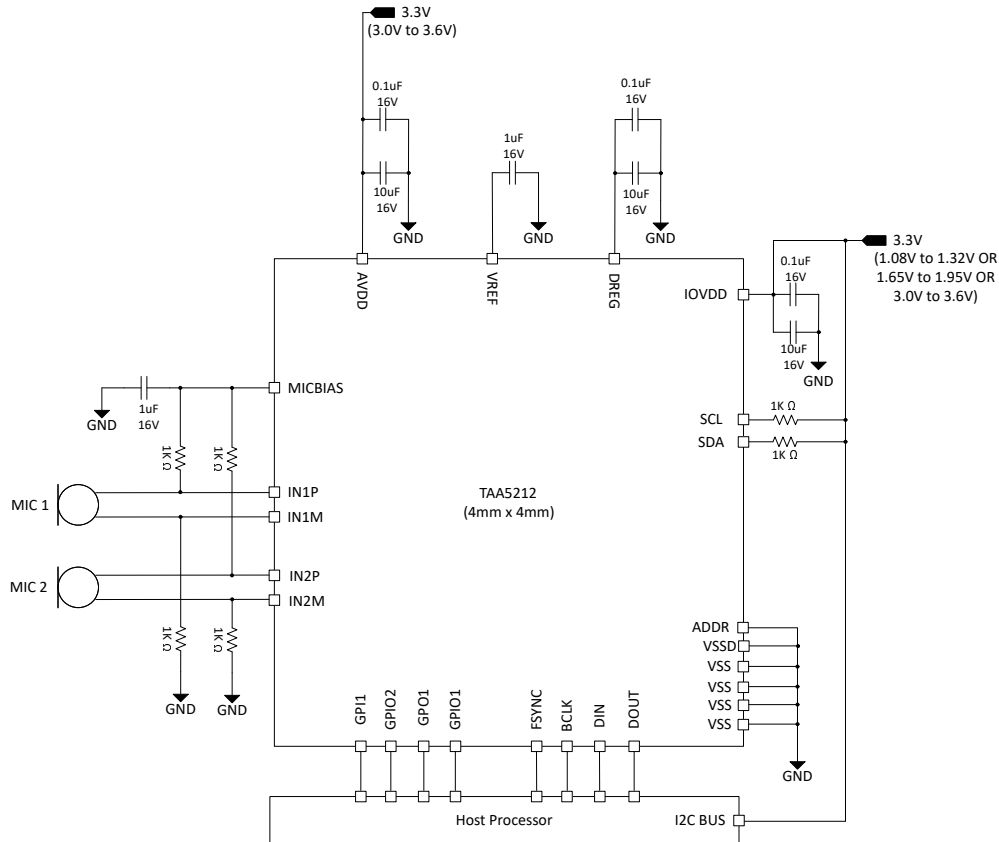

Figure 9-1. Stereo Microphone Block Diagram

9.2.2 Design Requirements

表 9-1 lists the design parameters for this application.

表 9-1. Design Parameters

PARAMETER	VALUE
AVDD	3.3 V
IOVDD	1.2 V or 1.8 V or 3.3 V
AVDD supply current consumption	TBD
IOVDD supply current consumption	TBD
Maximum MICBIAS current	5 mA

9.2.3 Detailed Design Procedure

This section describes the necessary steps to configure the TAA5212 for this specific application. The following steps provide a sequence of items that must be executed in the time between powering the device up and reading data from the device or transitioning from one mode to another mode of operation.

1. Apply power to the device:
 - a. Power up the IOVDD and AVDD power supplies
 - b. Wait for at least 1ms to allow the device to initialize the internal registers.
 - c. The device now goes into sleep mode (low-power mode < 10 μ A)
2. Transition from sleep mode to active mode whenever required for the operation:
 - a. Wake up the device by writing to P0_R2 to disable sleep mode
 - b. Wait for at least 1 ms to allow the device to complete the internal wake-up sequence
 - c. Override the default configuration registers or programmable coefficients value as required (this step is optional)
 - d. Enable all desired input channels by writing to P0_R118
 - e. Enable all desired audio serial interface input/output channels by writing to P0_R30 to P0_R37 for ADC
 - f. Power-up the ADC and MICBIAS by writing to P0_R120
 - g. Apply FSYNC and BCLK with the desired output sample rates and the BCLK to FSYNC ratio

This specific step can be done at any point in the sequence after step a.

See the [セクション 8.3.3](#) section for supported sample rates and the BCLK to FSYNC ratio.

- h. The device recording data is now sent to the host processor using the TDM audio serial data bus and playback data from TDM is now played on the lineout
3. Transition from active mode to sleep mode (again) as required in the system for low-power operation:
 - a. Enter sleep mode by writing to P0_R2 to enable sleep mode
 - b. Wait at least 6 ms (when FSYNC = 48 kHz) for the volume to ramp down and for all blocks to power down
 - c. Read P0_R122 to check the device shutdown and sleep mode status
 - d. If the device P0_R122_D[7:5] status bit is 3'b100 then stop FSYNC and BCLK in the system
 - e. The device now goes into sleep mode (low-power mode < 10 μ A) and retains all register values
4. Transition from sleep mode to active mode (again) as required for the recording operation:
 - a. Wake up the device by writing to P0_R2 to disable sleep mode
 - b. Wait at least 1 ms to allow the device to complete the internal wake-up sequence
 - c. Apply FSYNC and BCLK with the desired output sample rates and the BCLK to FSYNC ratio
 - d. The device recording data is now sent to the host processor using the TDM audio serial data bus and playback data from TDM is now played on the lineout
5. Repeat step 4 and step 5 as required for mode transitions

9.2.4 Application Performance Plots

図 9-2.

9.2.5 What to Do and What Not to Do

図 9-3.

10 Power Supply Recommendations

The power-supply sequence between the IOVDD and AVDD rails can be applied in any order. However, after all supplies are stable, then only initiate the I²C or SPI transactions to initialize the device.

For the supply power-up requirement, t_1 , t_2 must be at least 2 ms to allow the device to initialize the internal registers. See the [セクション 8.4](#) section for details on how the device operates in various modes after the device power supplies are settled to the recommended operating voltage levels. For the supply power-down requirement, t_4 , t_5 and t_6 must be at least 10 ms. This timing (as shown in [図 10-1](#)) allows the device to ramp down the volume on the record data, power down the analog and digital blocks, and put the device into shutdown mode. The device can also be immediately put into shutdown mode by ramping down power supplies, but doing so causes an abrupt shutdown.



図 10-1. Power-Supply Sequencing Requirement Timing Diagram

Make sure that the supply ramp rate is slower than 0.1V/ μ s and that the wait time between a power-down and a power-up event is at least 100 ms. For supply ramp rate slower than 0.1 V/ms, host device must apply a software reset as first transaction before doing any device configuration. Make sure all digital input pins are at valid input levels and not toggling during supply sequencing.

The TAA5212 supports a single AVDD supply operation by integrating an on-chip digital regulator, DREG, and an analog regulator, AREG.

11 Layout

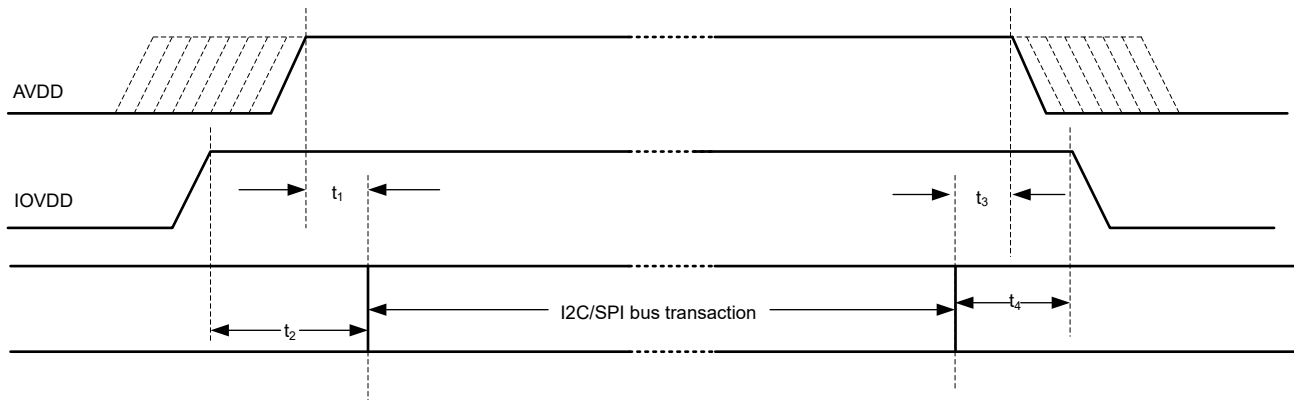
11.1 Layout Guidelines

11.2 Layout Example

☒ 11-1.

12 Device and Documentation Support

TI offers an extensive line of development tools. Tools and software to evaluate the performance of the device, generate code, and develop solutions are listed below.

12.1 Documentation Support

12.1.1 Related Documentation

12.2 ドキュメントの更新通知を受け取る方法

ドキュメントの更新についての通知を受け取るには、www.tij.co.jp のデバイス製品フォルダを開いてください。[通知] をクリックして登録すると、変更されたすべての製品情報に関するダイジェストを毎週受け取ることができます。変更の詳細については、改訂されたドキュメントに含まれている改訂履歴をご覧ください。

12.3 サポート・リソース

テキサス・インスツルメンツ E2E™ サポート・フォーラムは、エンジニアが検証済みの回答と設計に関するヒントをエキスパートから迅速かつ直接得ることができる場所です。既存の回答を検索したり、独自の質問をしたりすることで、設計に必要な支援を迅速に得ることができます。

リンクされているコンテンツは、各寄稿者により「現状のまま」提供されるものです。これらはテキサス・インスツルメンツの仕様を構成するものではなく、必ずしもテキサス・インスツルメンツの見解を反映したものではありません。テキサス・インスツルメンツの[使用条件](#)を参照してください。

12.4 Trademarks

テキサス・インスツルメンツ E2E™ is a trademark of Texas Instruments.
すべての商標は、それぞれの所有者に帰属します。

12.5 静電気放電に関する注意事項



この IC は、ESD によって破損する可能性があります。テキサス・インスツルメンツは、IC を取り扱う際には常に適切な注意を払うことを推奨します。正しい取り扱いおよび設置手順に従わない場合、デバイスを破損するおそれがあります。

ESD による破損は、わずかな性能低下からデバイスの完全な故障まで多岐にわたります。精密な IC の場合、パラメータがわずかに変化するだけで公表されている仕様から外れる可能性があるため、破損が発生しやすくなっています。

12.6 用語集

[テキサス・インスツルメンツ用語集](#) この用語集には、用語や略語の一覧および定義が記載されています。

PACKAGING INFORMATION

Orderable Device	Status (1)	Package Type	Package Drawing	Pins	Package Qty	Eco Plan (2)	Lead finish/ Ball material (6)	MSL Peak Temp (3)	Op Temp (°C)	Device Marking (4/5)	Samples
XTAA5212IRGER	ACTIVE	VQFN	RGE	24	3000	TBD	Call TI	Call TI	-40 to 125		Samples

(1) The marketing status values are defined as follows:

ACTIVE: Product device recommended for new designs.

LIFEBUY: TI has announced that the device will be discontinued, and a lifetime-buy period is in effect.

NRND: Not recommended for new designs. Device is in production to support existing customers, but TI does not recommend using this part in a new design.

PREVIEW: Device has been announced but is not in production. Samples may or may not be available.

OBSELETE: TI has discontinued the production of the device.

(2) **RoHS:** TI defines "RoHS" to mean semiconductor products that are compliant with the current EU RoHS requirements for all 10 RoHS substances, including the requirement that RoHS substance do not exceed 0.1% by weight in homogeneous materials. Where designed to be soldered at high temperatures, "RoHS" products are suitable for use in specified lead-free processes. TI may reference these types of products as "Pb-Free".

RoHS Exempt: TI defines "RoHS Exempt" to mean products that contain lead but are compliant with EU RoHS pursuant to a specific EU RoHS exemption.

Green: TI defines "Green" to mean the content of Chlorine (Cl) and Bromine (Br) based flame retardants meet JS709B low halogen requirements of <=1000ppm threshold. Antimony trioxide based flame retardants must also meet the <=1000ppm threshold requirement.

(3) MSL, Peak Temp. - The Moisture Sensitivity Level rating according to the JEDEC industry standard classifications, and peak solder temperature.

(4) There may be additional marking, which relates to the logo, the lot trace code information, or the environmental category on the device.

(5) Multiple Device Markings will be inside parentheses. Only one Device Marking contained in parentheses and separated by a "-" will appear on a device. If a line is indented then it is a continuation of the previous line and the two combined represent the entire Device Marking for that device.

(6) Lead finish/Ball material - Orderable Devices may have multiple material finish options. Finish options are separated by a vertical ruled line. Lead finish/Ball material values may wrap to two lines if the finish value exceeds the maximum column width.

Important Information and Disclaimer:The information provided on this page represents TI's knowledge and belief as of the date that it is provided. TI bases its knowledge and belief on information provided by third parties, and makes no representation or warranty as to the accuracy of such information. Efforts are underway to better integrate information from third parties. TI has taken and continues to take reasonable steps to provide representative and accurate information but may not have conducted destructive testing or chemical analysis on incoming materials and chemicals. TI and TI suppliers consider certain information to be proprietary, and thus CAS numbers and other limited information may not be available for release.

In no event shall TI's liability arising out of such information exceed the total purchase price of the TI part(s) at issue in this document sold by TI to Customer on an annual basis.

RGE 24

GENERIC PACKAGE VIEW

VQFN - 1 mm max height

PLASTIC QUAD FLATPACK - NO LEAD



Images above are just a representation of the package family, actual package may vary.
Refer to the product data sheet for package details.

4204104/H

重要なお知らせと免責事項

TI は、技術データと信頼性データ (データシートを含みます)、設計リソース (リファレンス・デザインを含みます)、アプリケーションや設計に関する各種アドバイス、Web ツール、安全性情報、その他のリソースを、欠陥が存在する可能性のある「現状のまま」提供しており、商品性および特定目的に対する適合性の黙示保証、第三者の知的財産権の非侵害保証を含むいかなる保証も、明示的または黙示的にかかわらず拒否します。

これらのリソースは、TI 製品を使用する設計の経験を積んだ開発者への提供を意図したものです。(1) お客様のアプリケーションに適した TI 製品の選定、(2) お客様のアプリケーションの設計、検証、試験、(3) お客様のアプリケーションに該当する各種規格や、その他のあらゆる安全性、セキュリティ、規制、または他の要件への確実な適合に関する責任を、お客様のみが単独で負うものとし、

上記の各種リソースは、予告なく変更される可能性があります。これらのリソースは、リソースで説明されている TI 製品を使用するアプリケーションの開発の目的でのみ、TI はその使用をお客様に許諾します。これらのリソースに関して、他の目的で複製することや掲載することは禁止されています。TI や第三者の知的財産権のライセンスが付与されている訳ではありません。お客様は、これらのリソースを自身で使用した結果発生するあらゆる申し立て、損害、費用、損失、責任について、TI およびその代理人を完全に補償するものとし、TI は一切の責任を拒否します。

TI の製品は、[TI の販売条件](#)、または [ti.com](#) やかかる TI 製品の関連資料などのいずれかを通じて提供する適用可能な条項の下で提供されています。TI がこれらのリソースを提供することは、適用される TI の保証または他の保証の放棄の拡大や変更を意味するものではありません。

お客様がいかなる追加条項または代替条項を提案した場合でも、TI はそれらに異議を唱え、拒否します。

郵送先住所 : Texas Instruments, Post Office Box 655303, Dallas, Texas 75265
Copyright © 2024, Texas Instruments Incorporated