

# TAD5112 106dB ダイナミックレンジのステレオ オーディオ DAC

## 1 特長

- DAC 性能 :
  - DAC からライン出力までのダイナミックレンジ : 106dB
  - DAC から HP 出力までのダイナミックレンジ : 102dB
  - THD+N : -95dB
- ヘッドフォン / ライン出力出力電圧 :
  - 差動、 $2V_{RMS}$  フルスケール
  - シングルエンド、 $1V_{RMS}$  フルスケール
- DAC サンプルレート ( $f_s$ ) = 8KHz ~ 768KHz
- アナログ入力から出力へのバイパス
- バッテリ保護
- 信号歪みリミッタ
- サーマル フォールドバック
- 低レイテンシ フィルタ選択
- プログラム可能な HPF およびバイクワッド フィルタ
- I<sup>2</sup>C & SPI 制御インターフェイス
- オーディオシリアルインターフェイス
  - フォーマット : TDM、I<sup>2</sup>S、左揃え
  - ワード長 : 16、20、24 または 32 ビット
- プログラム可能な PLL による柔軟なクロック供給
- 低消費電力モード
  - 再生時の未定 mW
- 単電源動作 1.8V または 3.3V
- I/O 電源動作 : 1.2V、1.8V、または 3.3V

## 2 アプリケーション

- テレマティクス制御ユニット
- 車載用ヘッドユニット
- デジタル コックピット処理装置
- 後部座席用エンターテインメント
- 再構成可能インストルメント クラスタ

## 3 概要

TAD5112 はステレオ  $2V_{RMS}$  DAC です。TAD5112 は、差動とシングルエンドの両方の入力および出力をサポートしています。DAC 出力は、ライン出力とヘッドフォン負荷のいずれかに構成できます。TAD5112 は、最大未定 mW のヘッドフォン負荷を駆動できます。TAD5112 は、プログラム可能なチャンネルゲイン、デジタル音量制御、低ジッタの位相ロックループ (PLL)、プログラム可能なハイパスフィルタ (HPF)、プログラム可能な EQ およびバイクワッドフィルタ、低レイテンシのフィルタモードを内蔵しており、最高 768kHz のサンプルレートに対応できます。TAD5112 はアナログ入力から出力へのバイパス オプションをサポートしています。アナログ入力とデジタル入力からのデータをデバイス内部で混合することもできます。TAD5112 は時分割多重化 (TDM)、I<sup>2</sup>S、左揃え (LJ) オーディオフォーマットに対応しており、I<sup>2</sup>C または SPI で制御できます。これらの高性能な機能を搭載し、単一電源で動作するため、TAD5112 はスペースの制約が厳しいオーディオアプリケーションに最適です。

### 製品情報

部品番号	パッケージ <sup>(1)</sup>	本体サイズ (公称)
TAD5112	WQFN(28)	4mm × 4mm、 0.5mm ピッチ

- (1) 利用可能なパッケージについては、このデータシートの末尾にある注文情報を参照してください。

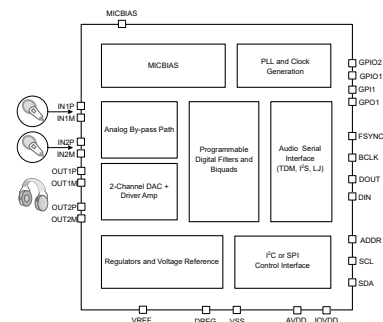

概略ブロック図



## Table of Contents

<b>1 特長</b> .....	1	7.1 Overview.....	14
<b>2 アプリケーション</b> .....	1	7.2 Functional Block Diagram.....	14
<b>3 概要</b> .....	1	7.3 Feature Description.....	15
<b>4 Revision History</b> .....	2	7.4 Device Functional Modes.....	38
<b>5 Pin Configuration and Functions</b> .....	3	7.5 Register Maps.....	38
<b>6 Specifications</b> .....	5	<b>8 Application and Implementation</b> .....	130
6.1 Absolute Maximum Ratings.....	5	8.1 Application Information.....	130
6.2 ESD Ratings.....	5	8.2 Typical Application.....	130
6.3 Recommended Operating Conditions.....	5	<b>9 Power Supply Recommendations</b> .....	132
6.4 Thermal Information.....	6	<b>10 Device and Documentation Support</b> .....	133
6.5 Electrical Characteristics.....	6	10.1 Documentation Support.....	133
6.6 Timing Requirements: I <sup>2</sup> C Interface.....	11	10.2 ドキュメントの更新通知を受け取る方法.....	133
6.7 Switching Characteristics: I <sup>2</sup> C Interface.....	12	10.3 サポート・リソース.....	133
6.8 Timing Requirements: SPI Interface.....	12	10.4 Trademarks.....	133
6.9 Switching Characteristics: SPI Interface.....	12	10.5 静電気放電に関する注意事項.....	133
6.10 Timing Requirements: TDM, I <sup>2</sup> S or LJ Interface.....	12	10.6 用語集.....	133
6.11 Switching Characteristics: TDM, I <sup>2</sup> S or LJ Interface.....	13	<b>11 Mechanical, Packaging, and Orderable   Information</b> .....	133
<b>7 Detailed Description</b> .....	14	11.1 Tape and Reel Information.....	135

## 4 Revision History

資料番号末尾の英字は改訂を表しています。その改訂履歴は英語版に準じています。

DATE	REVISION	NOTES
December 2023	*	Initial Release

## 5 Pin Configuration and Functions



図 5-1. 28-Pin QFN With Exposed Thermal Pad, Top View

表 5-1. Pin Functions

PIN		TYPE <sup>(1)</sup>	DESCRIPTION
NAME	NO.		
DREG	1	Digital Supply	Digital on-chip regulator output voltage for digital supply (1.5 V, nominal)
BCLK	2	Digital I/O	Audio serial data interface bus bit clock
FSYNC	3	Digital I/O	Audio serial data interface bus frame synchronization signal
DOUT	4	Digital I/O	Audio serial data interface bus output
DIN	5	Digital Input	Audio serial data interface bus input
IOVDD	6	Digital Supply	Digital I/O power supply (1.8 V or 3.3 V, nominal)
VSS	A2	Ground	Ground Pin. Short directly to board Ground Plane.
SCL	7	Digital Input	Clock for I <sup>2</sup> C Control Interface
SDA	8	Digital Input	Data for I <sup>2</sup> C Control Interface
GPIO1	9	Digital I/O	General-purpose digital input/output 0 (multipurpose functions such as daisy-chain input, audio data output, PLL input clock source, interrupt, and so forth)
GPIO2	10	Digital I/O	General-purpose digital input/output 1 (multipurpose functions such as daisy-chain input, audio data output, PLL input clock source, interrupt, and so forth)
GPO1	11	Digital Output	General-purpose digital output 1 (multipurpose functions such as audio data output, interrupt, and so forth)
GPI1	12	Digital Input	General-purpose digital input 1 (multipurpose functions such as daisy-chain input, PLL input clock source, and so forth)

表 5-1. Pin Functions (続き)

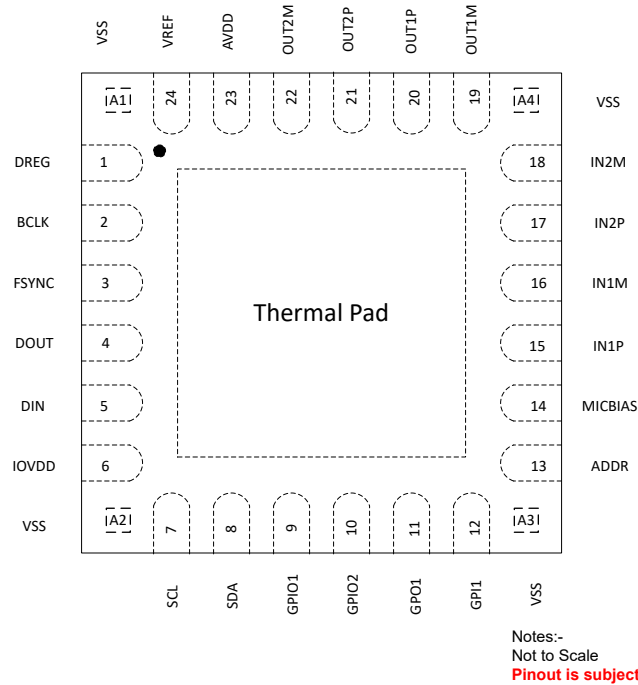
PIN		TYPE <sup>(1)</sup>	DESCRIPTION
NAME	NO.		
VSS	A3	Ground	Ground Pin. Short directly to board Ground Plane.
ADDR	13	Analog Input	I2C Address
MICBIAS	14	Analog	MICBIAS Output (Programmable output upto 3V)
IN1P	15	Analog Input	Analog Input 1P Pin
IN1M	16	Analog Input	Analog Input 1M Pin
IN2P	17	Analog Input	Analog Input 2P Pin
IN2M	18	Analog Input	Analog Input 2M Pin
VSS	A4	Ground	Ground Pin. Short directly to board Ground Plane.
OUT1M	19	Analog Output	Analog Output 1M Pin
OUT1P	20	Analog Output	Analog Output 1P Pin
OUT2P	21	Analog Output	Analog Output 2P Pin
OUT2M	22	Analog Output	Analog Output 2M Pin
AVDD	23	Analog Supply	Analog power (3.3 V, nominal)
VREF	24	Analog	Analog reference voltage filter output
VSS	A1	Ground	Ground Pin. Short directly to board Ground Plane.

(1) I = Input, O = Output, I/O = Input or Output, G = Ground, P = Power.

## 6 Specifications

### 6.1 Absolute Maximum Ratings

over the operating ambient temperature range (unless otherwise noted)<sup>(1)</sup>

		MIN	MAX	UNIT
Supply voltage	AVDD to AVSS	-0.3	3.9	V
Supply voltage	IOVDD to VSS (thermal pad)	-0.3	3.9	V
Ground voltage differences	AVSS to VSS (thermal pad)	-0.3	0.3	V
Analog input voltage	Analog input pins voltage to AVSS	-0.3	5.656	V
Digital input voltage	Digital input pins voltage to VSS (thermal pad)	-0.3	IOVDD + 0.3	V
Temperature	Functional ambient, T <sub>A</sub>	-55	125	°C
	Operating ambient, T <sub>A</sub>	-40	125	
	Junction, T <sub>J</sub>	-40	150	
	Storage, T <sub>stg</sub>	-65	150	

- (1) Stresses beyond those listed under *Absolute Maximum Ratings* may cause permanent damage to the device. These are stress ratings only, which do not imply functional operation of the device at these or any other conditions beyond those indicated under *Recommended Operating Conditions*. Exposure to absolute-maximum-rated conditions for extended periods may affect device reliability.

### 6.2 ESD Ratings

			VALUE	UNIT
V <sub>(ESD)</sub>	Electrostatic discharge	Human-body model (HBM), per AEC Q100-002 <sup>(1)</sup>	±2000	V
V <sub>(ESD)</sub>	Electrostatic discharge	Charged-device model (CDM), per AEC Q100-011	±500	

- (1) AEC Q100-002 indicates that HBM stressing shall be in accordance with the ANSI/ESDA/JEDEC JS-001 specification.

### 6.3 Recommended Operating Conditions

		MIN	NOM	MAX	UNIT	
<b>POWER</b>						
AVDD <sup>(1)</sup>	Analog supply voltage to AVSS AVDD-3.3V Operation		3.0	3.3	3.6	V
AVDD <sup>(1)</sup>	Analog supply voltage to AVSS - AVDD 1.8V operation		1.65	1.8	1.95	V
IOVDD	IO supply voltage to VSS (thermal pad) - IOVDD 3.3-V operation		3.0	3.3	3.6	V
	IO supply voltage to VSS (thermal pad) - IOVDD 1.8-V operation		1.65	1.8	1.95	
IOVDD	IO supply voltage to VSS (thermal pad) - IOVDD 1.2-V operation		1.08	1.2	1.32	V
<b>INPUTS</b>						
INxx	Analog input pins voltage to AVSS for line in bypass path	Analog input pins voltage to AVSS for line in bypass path		0	5.6	V
INxx	Analog input pins voltage to AVSS for microphone bypass path		0.1	MICBIAS - 0.1		V
	Digital input pins voltage to VSS (thermal pad)		0	IOVDD		V
ADDR	ADDR pin w.r.t AVSS		0	AVDD		V
<b>TEMPERATURE</b>						
T <sub>A</sub>	Operating ambient temperature		-40		125	°C

		MIN	NOM	MAX	UNIT
<b>OTHERS</b>					
	GPIOx or GPIx (used as CCLK input) clock frequency			36.864 <sup>(2)</sup>	MHz
C <sub>b</sub>	SCL and SDA bus capacitance for I <sup>2</sup> C interface supports standard-mode and fast-mode			400	pF
	SCL and SDA bus capacitance for I <sup>2</sup> C interface supports fast-mode plus			550	
C <sub>L</sub>	Digital output load capacitance		20	50	pF

- (1) AVSS and VSS (thermal pad); all ground pins must be tied together and must not differ in voltage by more than 0.2 V.  
 (2) MCLK input rise time (V<sub>IL</sub> to V<sub>IH</sub>) and fall time (V<sub>IH</sub> to V<sub>IL</sub>) must be less than 5 ns. For better audio noise performance, MCLK input must be used with low jitter.

## 6.4 Thermal Information

THERMAL METRIC <sup>(1)</sup>		TAD5112-Q1	UNIT
		RGE (VQFN)	
		24 PINS	
R <sub>θJA</sub>	Junction-to-ambient thermal resistance	38.4	°C/W
R <sub>θJC(top)</sub>	Junction-to-case (top) thermal resistance	26.3	°C/W
R <sub>θJB</sub>	Junction-to-board thermal resistance	15.9	°C/W
ψ <sub>JT</sub>	Junction-to-top characterization parameter	0.5	°C/W
ψ <sub>JB</sub>	Junction-to-board characterization parameter	15.8	°C/W
R <sub>θJC(bot)</sub>	Junction-to-case (bottom) thermal resistance	13.8	°C/W

- (1) For more information about traditional and new thermal metrics, see the [spra953](#) application report.

## 6.5 Electrical Characteristics

at T<sub>A</sub> = 25°C, AVDD = 3.3 V, IOVDD = 3.3 V, f<sub>IN</sub> = 1-kHz sinusoidal signal, f<sub>S</sub> = 48 kHz, 32-bit audio data, BCLK = 256 × f<sub>S</sub>, TDM target mode and PLL on (unless otherwise noted)

PARAMETER	TEST CONDITIONS	MIN	NOM	MAX	UNIT
<b>DAC Performance for Line Output/Head Phone Playback</b>					
Full Scale Output Voltage	Differential output between OUTxP and OUTxM, AVDD=3.3V		2		V <sub>RMS</sub>
	Differential Output between OUTxP and OUTxM, AVDD=1.8V		1		
	Single-ended Output, AVDD=3.3V		1		
	Single-ended Output, AVDD=1.8V		0.5		
	Pseudo Differential Output between OUTxP and OUTxM, AVDD=3.3V		1		
	Pseudo Differential Output between OUTxP and OUTxM, AVDD=1.8V		0.5		

at  $T_A = 25^\circ\text{C}$ ,  $AVDD = 3.3\text{ V}$ ,  $IOVDD = 3.3\text{ V}$ ,  $f_{IN} = 1\text{-kHz}$  sinusoidal signal,  $f_S = 48\text{ kHz}$ , 32-bit audio data,  $BCLK = 256 \times f_S$ , TDM target mode and PLL on (unless otherwise noted)

PARAMETER		TEST CONDITIONS	MIN	NOM	MAX	UNIT
SNR	Signal-to-noise ratio, A-weighted <sup>(1)</sup> <sup>(2)</sup>	Differential Output, 0dBFS Signal, AVDD=3.3V		106		dB
		Single Ended Output, 0dBFS Signal, AVDD=3.3V		97		
		Pseudo Differential Output, 0dBFS Signal, AVDD=3.3V		96		
		Differential Output, 0dBFS Signal, AVDD=1.8V		100		
		Single Ended Output, 0dBFS Signal, AVDD=1.8V		91		
		Pseudo Differential Output, 0dBFS Signal, AVDD=1.8V		90		
		Differential Output, 0dBFS Signal, AVDD=3.3V, 0dBFS Signal, Power Tune Mode		98		
		Single Ended Output, 0dBFS Signal, AVDD=3.3V, Power Tune Mode		88		
		Pseudo Differential Output, 0dBFS Signal, AVDD=3.3V, Power Tune Mode		87		
		Differential Output, 0dBFS Signal, AVDD=1.8V, Power Tune Mode		96		
		Single Ended Output, 0dBFS Signal, AVDD=1.8V, Power Tune Mode		83		
Pseudo Differential Output, 0dBFS Signal, AVDD=1.8V, Power Tune Mode		82				
DR	Dynamic range, A-weighted <sup>(2)</sup>	Differential Output, -60dBFS Signal, AVDD=3.3V		106		dB
		Single Ended Output, -60dBFS Signal, AVDD=3.3V		97		
		Pseudo Differential Output, -60dBFS Signal, AVDD=3.3V		96		
		Differential Output, -60dBFS Signal, AVDD=1.8V		100		
		Single Ended Output, -60dBFS Signal, AVDD=1.8V		91		
		Pseudo Differential Output, -60dBFS Signal, AVDD=1.8V		90		
		Differential Output, -60dBFS Signal, AVDD=3.3V, 0dBFS Signal, Power Tune Mode		98		
		Single Ended Output, -60dBFS Signal, AVDD=3.3V, Power Tune Mode		88		
		Pseudo Differential Output, -60dBFS Signal, AVDD=3.3V, Power Tune Mode		87		
		Differential Output, -60dBFS Signal, AVDD=1.8V, Power Tune Mode		94		
		Single Ended Output, -60dBFS Signal, AVDD=1.8V, Power Tune Mode		83		
Pseudo Differential Output, -60dBFS Signal, AVDD=1.8V, Power Tune Mode		82				
THD+N	Total harmonic distortion <sup>(2)</sup>			-95		dB
	Head Phone Load Range			16		$\Omega$
	Line Out Load Range		600			$\Omega$
	Channel gain control range	Programmable 1-dB steps	-6		12	dB
<b>Analog Bypass to Line Out/Head Phone Amplifier</b>						

at  $T_A = 25^\circ\text{C}$ ,  $AVDD = 3.3\text{ V}$ ,  $IOVDD = 3.3\text{ V}$ ,  $f_{IN} = 1\text{-kHz}$  sinusoidal signal,  $f_S = 48\text{ kHz}$ , 32-bit audio data,  $BCLK = 256 \times f_S$ , TDM target mode and PLL on (unless otherwise noted)

PARAMETER		TEST CONDITIONS		MIN	NOM	MAX	UNIT
Input impedance		Differential input, between INxP and INxM		8.8		k $\Omega$	
		Single-ended input, between INxP and INxM		4.4			
		Differential input, between INxP and INxM, 40k Mode		40k			
		Single-ended input, between INxP and INxM, 40k Mode		20k			
Single Ended Full Scale Output	AVDD=3.3V	AVDD=3.3V	1		Vrms		
Differential Full Scale Output	AVDD=3.3V		2		Vrms		
	AVDD=1.8V		1		Vrms		
Gain Error			0.1		dB		
Noise, A-Weighted	Idle Channel, AC Coupled Input Shorted to Ground, Fully Differential output		4.5		$\mu\text{V}_{\text{RMS}}$		
Noise, A-Weighted	Idle Channel, AC Coupled Input Shorted to Ground, Single Ended output		6.3		$\mu\text{V}_{\text{RMS}}$		
SNR	Signal-to-noise ratio, A-weighted <sup>(1) (2)</sup>	Idle Channel, AC Coupled Input Shorted to Ground, Fully Differential output, AVDD=3.3V		113		dB	
SNR	Signal-to-noise ratio, A-weighted <sup>(1) (2)</sup>	Idle Channel, AC Coupled Input Shorted to Ground, Single Ended output, AVDD=3.3V		104		dB	
THD+N	Total harmonic distortion <sup>(2)</sup>	IN1 differential AC-coupled input selected and -1-dB full-scale AC signal input, 0-dB channel gain				dB	
<b>DAC Channel OTHER PARAMETERS</b>							
	Output Offset	0 Input, Fully Differential Output		0.2		mV	
	Output Offset	0 Input, Pseudo Differential Output		0.4		mV	
	Output Common Mode	Common Mode Level for OUTxP and OUTxM AVDD=1.8V (Register Configurable)		0.9		V	
	Output Common Mode	Common Mode Level for OUTxP and OUTxM AVDD=3.3V (Register Configurable)		1.66		V	
	Common Mode Error	DC Error in Common Mode Voltage		$\pm 10$		mV	
	Digital volume control range	Programmable 0.5-dB steps		-120	42	dB	
	Output Signal Bandwidth	Upto 192KSPS FS Rate		0.46		FS	
		>192KSPS		100		kHz	
	Input data sample rate	Programmable		3.675	768	kHz	
	Input data sample word length	Programmable		16	32	Bits	
	Digital high-pass filter cutoff frequency	First-order IIR filter with programmable coefficients, -3-dB point (default setting)		2		Hz	
	Interchannel isolation			-134		dB	
	Interchannel gain mismatch			0.1		dB	
	Interchannel phase mismatch	1-kHz sinusoidal signal		0.01		Degrees	
PSRR	Power-supply rejection ratio	100-mV <sub>pp</sub> , 1-kHz sinusoidal signal on AVDD, differential input selected, 0-dB channel gain		100		dB	
	Mute Attenuation			-130		dB	
P <sub>out</sub>	Output Power Delivery	Single ended/Pseudo Differential R <sub>L</sub> =16 Ohms, THD+N<1%		62.5		mW	
<b>MICROPHONE BIAS</b>							



at  $T_A = 25^\circ\text{C}$ ,  $AVDD = 3.3\text{ V}$ ,  $IOVDD = 3.3\text{ V}$ ,  $f_{IN} = 1\text{-kHz}$  sinusoidal signal,  $f_S = 48\text{ kHz}$ , 32-bit audio data,  $BCLK = 256 \times f_S$ , TDM target mode and PLL on (unless otherwise noted)

PARAMETER		TEST CONDITIONS		MIN	NOM	MAX	UNIT
	MICBIAS noise	BW = 20 Hz to 20 kHz, A-weighted, 1- $\mu\text{F}$ capacitor between MICBIAS and AVSS			2		$\mu\text{V}_{\text{RMS}}$
	MICBIAS voltage	Bypass to AVDD			AVDD		V
	MICBIAS voltage	AVDD=1.8V			1.375		V
	MICBIAS voltage	AVDD=3.3V			2.75		V
<b>DIGITAL I/O</b>							
$V_{IL(\text{SHDNZ})}$	Low-level digital input logic voltage threshold	SHDNZ pin		-0.3		$0.25 \times IOVDD$	V
$V_{IH(\text{SHDNZ})}$	High-level digital input logic voltage threshold	SHDNZ pin		$0.75 \times IOVDD$		$IOVDD + 0.3$	V
$V_{IL}$	Low-level digital input logic voltage threshold	All digital pins except SDA and SCL, IOVDD 1.8-V operation		-0.3		$0.35 \times IOVDD$	V
		All digital pins except SDA and SCL, IOVDD 3.3-V operation		-0.3		0.8	
$V_{IH}$	High-level digital input logic voltage threshold	All digital pins except SDA and SCL, IOVDD 1.8-V operation		$0.65 \times IOVDD$		$IOVDD + 0.3$	V
		All digital pins except SDA and SCL, IOVDD 3.3-V operation		2		$IOVDD + 0.3$	
$V_{OL}$	Low-level digital output voltage	All digital pins except SDA and SCL, $I_{OL} = -2\text{ mA}$ , IOVDD 1.8-V operation				0.45	V
		All digital pins except SDA and SCL, $I_{OL} = -2\text{ mA}$ , IOVDD 3.3-V operation				0.4	
$V_{OH}$	High-level digital output voltage	All digital pins except SDA and SCL, $I_{OH} = 2\text{ mA}$ , IOVDD 1.8-V operation		$IOVDD - 0.45$			V
		All digital pins except SDA and SCL, $I_{OH} = 2\text{ mA}$ , IOVDD 3.3-V operation		2.4			
$V_{IL(I2C)}$	Low-level digital input logic voltage threshold	SDA and SCL		-0.5		$0.3 \times IOVDD$	V
$V_{IH(I2C)}$	High-level digital input logic voltage threshold	SDA and SCL		$0.7 \times IOVDD$		$IOVDD + 0.5$	V
$V_{OL1(I2C)}$	Low-level digital output voltage	SDA, $I_{OL(I2C)} = -3\text{ mA}$ , $IOVDD > 2\text{ V}$				0.4	V
$V_{OL2(I2C)}$	Low-level digital output voltage	SDA, $I_{OL(I2C)} = -2\text{ mA}$ , $IOVDD \leq 2\text{ V}$				$0.2 \times IOVDD$	V
$I_{OL(I2C)}$	Low-level digital output current	SDA, $V_{OL(I2C)} = 0.4\text{ V}$ , standard-mode or fast-mode		3			mA
		SDA, $V_{OL(I2C)} = 0.4\text{ V}$ , fast-mode plus		20			
$I_{IL}$	Input logic-low leakage for digital inputs	All digital pins, input = 0 V		-5	0.1	5	$\mu\text{A}$
$I_{IH}$	Input logic-high leakage for digital inputs	All digital pins, input = IOVDD		-5	0.1	5	$\mu\text{A}$
$C_{IN}$	Input capacitance for digital inputs	All digital pins			5		pF
$R_{PD}$	Pulldown resistance for digital I/O pins when asserted on				20		k $\Omega$
<b>TYPICAL SUPPLY CURRENT CONSUMPTION</b>							
$I_{AVDD}$	Current consumption in sleep mode (software shutdown mode)	All device external clocks stopped		TBD			$\mu\text{A}$
$I_{IOVDD}$				1			

at  $T_A = 25^\circ\text{C}$ ,  $AVDD = 3.3\text{ V}$ ,  $IOVDD = 3.3\text{ V}$ ,  $f_{IN} = 1\text{-kHz}$  sinusoidal signal,  $f_S = 48\text{ kHz}$ , 32-bit audio data,  $BCLK = 256 \times f_S$ , TDM target mode and PLL on (unless otherwise noted)

PARAMETER		TEST CONDITIONS	MIN	NOM	MAX	UNIT
$I_{AVDD}$	Current consumption with DAC to HP 2-channel operation at $f_S$ 16-kHz, MICBIAS off, PLL on, $BCLK = 512 \times f_S$		TBD			mA
$I_{IOVDD}$			0.2			
$I_{AVDD}$	Current consumption with DAC to HP 2-channel operation at $f_S$ 48-kHz, MICBIAS off, PLL off, $BCLK = 512 \times f_S$		TBD			mA
$I_{IOVDD}$			TBD			

- (1) Ratio of output level with 1-kHz full-scale sine-wave input, to the output level with the AC signal input shorted to ground, measured A-weighted over a 20-Hz to 20-kHz bandwidth using an audio analyzer.
- (2) All performance measurements done with 20-kHz low-pass filter and, where noted, A-weighted filter. Failure to use such a filter can result in higher THD and lower SNR and dynamic range readings than shown in the Electrical Characteristics. The low-pass filter removes out-of-band noise, which, although not audible, can affect dynamic specification values.

## 6.6 Timing Requirements: I<sup>2</sup>C Interface

at T<sub>A</sub> = 25°C, IOVDD = 3.3 V or 1.8 V (unless otherwise noted); see TBD for timing diagram

		MIN	NOM	MAX	UNIT
<b>STANDARD-MODE</b>					
f <sub>SCL</sub>	SCL clock frequency	0		100	kHz
t <sub>HD,STA</sub>	Hold time (repeated) START condition. After this period, the first clock pulse is generated.	4			μs
t <sub>LOW</sub>	Low period of the SCL clock	4.7			μs
t <sub>HIGH</sub>	High period of the SCL clock	4			μs
t <sub>SU,STA</sub>	Setup time for a repeated START condition	4.7			μs
t <sub>HD,DAT</sub>	Data hold time	0		3.45	μs
t <sub>SU,DAT</sub>	Data setup time	250			ns
t <sub>r</sub>	SDA and SCL rise time			1000	ns
t <sub>f</sub>	SDA and SCL fall time			300	ns
t <sub>SU,STO</sub>	Setup time for STOP condition	4			μs
t <sub>BUF</sub>	Bus free time between a STOP and START condition	4.7			μs
<b>FAST-MODE</b>					
f <sub>SCL</sub>	SCL clock frequency	0		400	kHz
t <sub>HD,STA</sub>	Hold time (repeated) START condition. After this period, the first clock pulse is generated.	0.6			μs
t <sub>LOW</sub>	Low period of the SCL clock	1.3			μs
t <sub>HIGH</sub>	High period of the SCL clock	0.6			μs
t <sub>SU,STA</sub>	Setup time for a repeated START condition	0.6			μs
t <sub>HD,DAT</sub>	Data hold time	0		0.9	μs
t <sub>SU,DAT</sub>	Data setup time	100			ns
t <sub>r</sub>	SDA and SCL rise time	20		300	ns
t <sub>f</sub>	SDA and SCL fall time		20 × (IOVDD / 5.5 V)	300	ns
t <sub>SU,STO</sub>	Setup time for STOP condition	0.6			μs
t <sub>BUF</sub>	Bus free time between a STOP and START condition	1.3			μs
<b>FAST-MODE PLUS</b>					
f <sub>SCL</sub>	SCL clock frequency	0		1000	kHz
t <sub>HD,STA</sub>	Hold time (repeated) START condition. After this period, the first clock pulse is generated.	0.26			μs
t <sub>LOW</sub>	Low period of the SCL clock	0.5			μs
t <sub>HIGH</sub>	High period of the SCL clock	0.26			μs
t <sub>SU,STA</sub>	Setup time for a repeated START condition	0.26			μs
t <sub>HD,DAT</sub>	Data hold time	0			μs
t <sub>SU,DAT</sub>	Data setup time	50			ns
t <sub>r</sub>	SDA and SCL Rise Time			120	ns
t <sub>f</sub>	SDA and SCL Fall Time		20 × (IOVDD / 5.5 V)	120	ns
t <sub>SU,STO</sub>	Setup time for STOP condition	0.26			μs
t <sub>BUF</sub>	Bus free time between a STOP and START condition	0.5			μs

## 6.7 Switching Characteristics: I<sup>2</sup>C Interface

 at T<sub>A</sub> = 25°C, IOVDD = 3.3 V or 1.8 V (unless otherwise noted); see TBD for timing diagram

PARAMETER		TEST CONDITIONS	MIN	TYP	MAX	UNIT
t <sub>d</sub> (SDA)	SCL to SDA delay	Standard-mode	200		1250	ns
		Fast-mode	200		850	ns
		Fast-mode plus			400	ns

## 6.8 Timing Requirements: SPI Interface

 at T<sub>A</sub> = 25°C, IOVDD = 3.3 V or 1.8 V and 20-pF load on all outputs (unless otherwise noted); see TBD for timing diagram

PARAMETER		TEST CONDITIONS	MIN	NOM	MAX	UNIT
t <sub>(SCLK)</sub>	SCLK period		40			ns
t <sub>H</sub> (SCLK)	SCLK high pulse duration		18			ns
t <sub>L</sub> (SCLK)	SCLK low pulse duration		18			ns
t <sub>LEAD</sub>	Enable lead time		16			ns
t <sub>TRAIL</sub>	Enable trail time		16			ns
t <sub>DSEQ</sub>	Sequential transfer delay		20			ns
t <sub>SU</sub> (MOSI)	MOSI data setup time		8			ns
t <sub>HLD</sub> (MOSI)	MOSI data hold time		8			ns
t <sub>r</sub> (SCLK)	SCLK rise time	10% - 90% rise time			6	ns
t <sub>f</sub> (SCLK)	SCLK fall time	90% - 10% fall time			6	ns

## 6.9 Switching Characteristics: SPI Interface

 at T<sub>A</sub> = 25°C, IOVDD = 3.3 V or 1.8 V and 20-pF load on all outputs (unless otherwise noted); see for timing diagram

PARAMETER		TEST CONDITIONS	MIN	TYP	MAX	UNIT
t <sub>a</sub> (MISO)	MISO access time	IOVDD = 1.8 V			18	ns
		IOVDD = 3.3 V			14	
t <sub>d</sub> (MISO)	SCLK to MISO delay	50% of SCLK to 50% of MISO, IOVDD = 1.8 V			19	ns
		50% of SCLK to 50% of MISO, IOVDD = 3.3 V			15	
t <sub>dis</sub> (MISO)	MISO disable time	IOVDD = 1.8 V			18	ns
		IOVDD = 3.3 V			14	

## 6.10 Timing Requirements: TDM, I<sup>2</sup>S or LJ Interface

 at T<sub>A</sub> = 25°C, IOVDD = 3.3 V or 1.8 V and 20-pF load on all outputs (unless otherwise noted); see for timing diagram

PARAMETER		TEST CONDITIONS	MIN	NOM	MAX	UNIT
t <sub>(BCLK)</sub>	BCLK period		40			ns
t <sub>H</sub> (BCLK)	BCLK high pulse duration <sup>(1)</sup>		18			ns
t <sub>L</sub> (BCLK)	BCLK low pulse duration <sup>(1)</sup>		18			ns
t <sub>SU</sub> (FSYNC)	FSYNC setup time		8			ns
t <sub>HLD</sub> (FSYNC)	FSYNC hold time		8			ns
t <sub>r</sub> (BCLK)	BCLK rise time	10% - 90% rise time			10	ns
t <sub>f</sub> (BCLK)	BCLK fall time	90% - 10% fall time			10	ns

- (1) The BCLK minimum high or low pulse duration must be higher than 25 ns (to meet the timing specifications), if the SDOUT data line is latched on the opposite BCLK edge polarity than the edge used by the device to transmit SDOUT data.

## 6.11 Switching Characteristics: TDM, I<sup>2</sup>S or LJ Interface

at T<sub>A</sub> = 25°C, IOVDD = 3.3 V or 1.8 V and 20-pF load on all outputs (unless otherwise noted); see TBD for timing diagram

PARAMETER	TEST CONDITIONS	MIN	TYP	MAX	UNIT
t <sub>d(SDOUT-BCLK)</sub>	BCLK to SDOUT delay	50% of BCLK to 50% of SDOUT, IOVDD = 1.8 V		18	ns
		50% of BCLK to 50% of SDOUT, IOVDD = 3.3 V		14	
t <sub>d(SDOUT-FSYNC)</sub>	FSYNC to SDOUT delay in TDM or LJ mode (for MSB data with TX_OFFSET = 0)	50% of FSYNC to 50% of SDOUT, IOVDD = 1.8 V		18	ns
		50% of FSYNC to 50% of SDOUT, IOVDD = 3.3 V		14	
f <sub>(BCLK)</sub>	BCLK output clock frequency; master mode <sup>(1)</sup>			24.576	MHz
t <sub>H(BCLK)</sub>	BCLK high pulse duration; master mode	IOVDD = 1.8 V		14	ns
		IOVDD = 3.3 V		14	
t <sub>L(BCLK)</sub>	BCLK low pulse duration; master mode	IOVDD = 1.8 V		14	ns
		IOVDD = 3.3 V		14	
t <sub>d(FSYNC)</sub>	BCLK to FSYNC delay; master mode	50% of BCLK to 50% of FSYNC, IOVDD = 1.8 V		18	ns
		50% of BCLK to 50% of FSYNC, IOVDD = 3.3 V		14	
t <sub>r(BCLK)</sub>	BCLK rise time; master mode	10% - 90% rise time, IOVDD = 1.8 V		10	ns
		10% - 90% rise time, IOVDD = 3.3 V		10	
t <sub>f(BCLK)</sub>	BCLK fall time; master mode	90% - 10% fall time, IOVDD = 1.8 V		8	ns
		90% - 10% fall time, IOVDD = 3.3 V		8	

(1) The BCLK output clock frequency must be lower than 18.5 MHz (to meet the timing specifications), if the SDOUT data line is latched on the opposite BCLK edge polarity than the edge used by the device to transmit SDOUT data.

## 7 Detailed Description

### 7.1 Overview

The TAD5112 is from a scalable family of devices. As with the extended family of devices, the TAD5112 consists of a high-performance, low-power, flexible audio digital-to-analog converter (DAC) with extensive feature integration. This device is intended for automotive applications such as telematics control unit, hands-free in-vehicle communication, emergency call, and multimedia applications. This device integrates a host of features that reduce cost, board space, and power consumption in space-constrained automotive sub-system designs. Package, performance, and device-compatible configuration registers make this device well suited for scalable system designs.

The TAD5112 consists of the following blocks:

- Low-noise programmable microphone bias output
- 2-channel, multibit, high-performance delta-sigma ( $\Delta\Sigma$ ) DACs
- Configurable single-ended, differential or pseudo-differential audio outputs
- Over Current Diagnostics and Protection for MICBIAS and analog outputs
- Automatic gain controller (AGC)
- Advanced Thermal foldback and protection
- Advanced Battery guard and distortion limiter
- Programmable interpolation filters with linear-phase or low-latency filter
- Programmable channel gain, volume control, and biquad filters for each channel
- Programmable phase and gain calibration with fine resolution for each channel
- Programmable high-pass filter (HPF) and digital channel mixer
- Integrated low-jitter, phase-locked loop (PLL) supporting a wide range of system clocks
- Integrated digital and analog voltage regulators to support single-supply operation

Communication to the TAD5112 for configuring the control registers is supported using an I<sup>2</sup>C and SPI interface. The device supports a highly flexible audio serial interface [time-division multiplexing (TDM), I<sup>2</sup>S, or left-justified (LJ)] to transmit audio data seamlessly in the system across devices.

### 7.2 Functional Block Diagram



図 7-1.

## 7.3 Feature Description

### 7.3.1 Serial Interfaces

This device has two serial interfaces: control and audio data. The control serial interface is used for device configuration. The audio data serial interface is used for transmitting audio data to the host device.

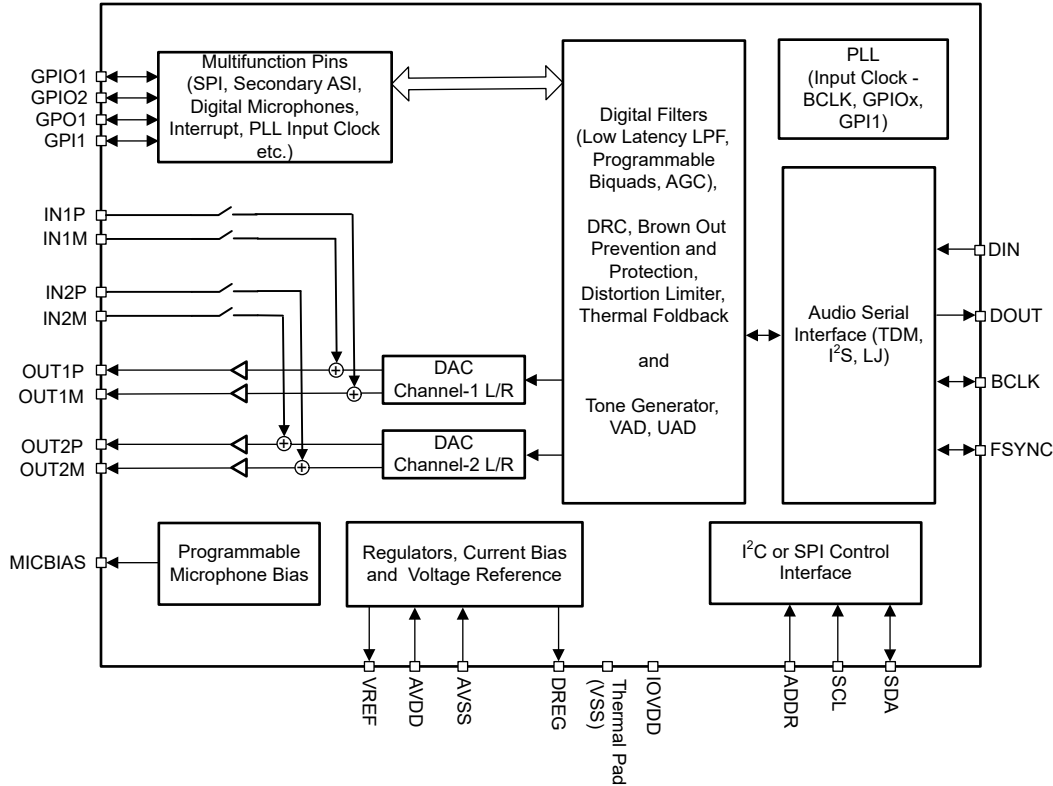
#### 7.3.1.1 Control Serial Interfaces

The device contains configuration registers and programmable coefficients that can be set to the desired values for a specific system and application use. All these registers can be accessed using either I<sup>2</sup>C or SPI communication to the device. For more information, see the [セクション 7.5](#) section.

#### 7.3.1.2 Audio Serial Interfaces

Digital audio data flows between the host processor and the TAD5112 on the digital audio serial interface (ASI), or audio bus. This highly flexible ASI bus includes a TDM mode for multichannel operation, support for I<sup>2</sup>S or left-justified protocols format, programmable data length options, very flexible controller-target configurability for bus clock lines and the ability to communicate with multiple devices within a system directly.

The TAD5112 supports up to two ASI Interfaces. Secondary ASI Clock and Data Pins can be configured by setting GPIO's. Frame Sync of two ASI's must be synchronous. See the for more details on Secondary ASI.

The bus protocol TDM, I<sup>2</sup>S, or left-justified (LJ) format can be selected for primary ASI by using the PASI\_FORMAT[1:0], P0\_R26\_D[7:6] register bits. As shown in 表 7-1 and 表 7-2, these modes are all most significant byte (MSB)-first, pulse code modulation (PCM) data format, with the output channel data word-length programmable as 16, 20, 24, or 32 bits by configuring the PASI\_WLEN[1:0], P0\_R26\_D[5:4] register bits.

**表 7-1. Primary Audio Serial Interface Format**

P0_R26_D[7:6] : PASI_FORMAT[1:0]	PRIMARY AUDIO SERIAL INTERFACE FORMAT
00 (default)	Time division multiplexing (TDM) mode
01	Inter IC sound (I <sup>2</sup> S) mode
10	Left-justified (LJ) mode
11	Reserved (do not use this setting)

**表 7-2. Primary Audio Serial Interface Data Word-Length**

P0_R7_D[5:4] : PASI_WLEN[1:0]	PRIMARY AUDIO OUTPUT CHANNEL DATA WORD-LENGTH
00	Data word-length set to 16 bits
01	Data word-length set to 20 bits
10	Data word-length set to 24 bits
11 (default)	Data word-length set to 32 bits

The frame sync pin, FSYNC, is used in this audio bus protocol to define the beginning of a frame and has the same frequency as the output data sample rates. The bit clock pin, BCLK, is used to clock out the digital audio data across the serial bus. The number of bit-clock cycles in a frame must accommodate multiple device active output channels with the programmed data word length.

A frame consists of multiple time-division channel slots (up to 32) to allow all input/output channel audio data transmissions to complete on the audio bus by a device or multiple devices sharing the same audio bus. The device supports up to eight input channels and eight output channels that can be configured on primary ASI bus to place their audio data on bus slot 0 to slot 31. 表 7-3 lists the output channel-1 slot configuration settings. In I<sup>2</sup>S and LJ mode, the slots are divided into two sets, left-channel slots and right-channel slots, as described in the セクション 7.3.1.2.2 and セクション 7.3.1.2.3 sections.

**表 7-3. Output Channel-1 Slot Assignment Settings**

P0_R30_D[4:0] : PASI_TX_CH1_SLOT[4:0]	OUTPUT CHANNEL 1 SLOT ASSIGNMENT
0 0000 = 0d (default)	Slot 0 for TDM or left slot 0 for I <sup>2</sup> S, LJ.
0 0001 = 1d	Slot 1 for TDM or left slot 1 for LJ.
...	...
0 1111 = 15d	Slot 15 for TDM or left slot 15 for LJ.
1 0000 = 32d	Slot 16 for TDM or right slot 0 for I <sup>2</sup> S, LJ.
...	...
1 1110 = 30d	Slot 30 for TDM or right slot 14 for LJ.
1 1111 = 31d	Slot 31 for TDM or right slot 15 for LJ.

Similarly, the slot assignment setting for output channel 2 to channel 8 can be done using the PASI\_TX\_CH2\_SLOT (P0\_R31) to PASI\_TX\_CH8\_SLOT (P0\_R37) registers and for input channel 1 to channel 8 by using the PASI\_RX\_CH1\_SLOT (P0\_R40) to PAS\_RX\_CH8\_SLOT (P0\_R47), respectively.

The slot word length is the same as the primary ASI channel word length set for the device. The output channel data word length must be set to the same value for all TAD5112 devices if all devices share the same ASI bus in a system. The maximum number of slots possible for the ASI bus in a system is limited by the available bus bandwidth, which depends upon the BCLK frequency, output data sample rate used, and the channel data word length configured.



The device also includes a feature that offsets the start of the slot data transfer with respect to the frame sync by up to 31 cycles of the bit clock. Offset can be configured independently for input and output data paths. 表 7-4 and 表 7-5 lists the programmable offset configuration settings for transmission and receive paths respectively.

**表 7-4. Programmable Offset Settings for the ASI Slot Start for transmission**

P0_R28_D[4:0] : PASI_TX_OFFSET[4:0]	PROGRAMMABLE OFFSET SETTING FOR SLOT DATA TRANSMISSION START
0 0000 = 0d (default)	The device follows the standard protocol timing without any offset.
0 0001 = 1d	Slot start is offset by one BCLK cycle, as compared to standard protocol timing. For I <sup>2</sup> S or LJ, the left and right slot start is offset by one BCLK cycle, as compared to standard protocol timing.
.....	.....
1 1110 = 30d	Slot start is offset by 30 BCLK cycles, as compared to standard protocol timing. For I <sup>2</sup> S or LJ, the left and right slot start is offset by 30 BCLK cycles, as compared to standard protocol timing.
1 1111 = 31d	Slot start is offset by 31 BCLK cycles, as compared to standard protocol timing. For I <sup>2</sup> S or LJ, the left and right slot start is offset by 31 BCLK cycles, as compared to standard protocol timing.

**表 7-5. Programmable Offset Settings for the ASI Slot Start for Receive**

P0_R38_D[4:0] : PASI_RX_OFFSET[4:0]	PROGRAMMABLE OFFSET SETTING FOR SLOT DATA RECEIVE START
0 0000 = 0d (default)	The device follows the standard protocol timing without any offset.
0 0001 = 1d	Slot start is offset by one BCLK cycle, as compared to standard protocol timing. For I <sup>2</sup> S or LJ, the left and right slot start is offset by one BCLK cycle, as compared to standard protocol timing.
.....	.....
1 1110 = 30d	Slot start is offset by 30 BCLK cycles, as compared to standard protocol timing. For I <sup>2</sup> S or LJ, the left and right slot start is offset by 30 BCLK cycles, as compared to standard protocol timing.
1 1111 = 31d	Slot start is offset by 31 BCLK cycles, as compared to standard protocol timing. For I <sup>2</sup> S or LJ, the left and right slot start is offset by 31 BCLK cycles, as compared to standard protocol timing.

The device also features the ability to invert the polarity of the frame sync pin, FSYNC, used to transfer the audio data as compared to the default FSYNC polarity used in standard protocol timing. This feature can be set using the PASI\_FSYNC\_POL, P0\_R26\_D3 register bit. Similarly, the device can invert the polarity of the bit clock pin, BCLK, which can be set using the PASI\_BCLK\_POL, P0\_R26\_D2 register bit.

In addition, the word clock and bit clock can be independently configured in either Controller or Target mode, for flexible connectivity to a wide variety of processors. The word clock is used to define the beginning of a frame, and may be programmed as either a pulse or a square-wave signal. The frequency of this clock corresponds to the maximum of the selected DAC channels sampling frequencies.

#### 7.3.1.2.1 Time Division Multiplexed Audio (TDM) Interface

In TDM mode, also known as DSP mode, the rising edge of FSYNC starts the data transfer with the slot 0 data first. Immediately after the slot 0 data transmission, the remaining slot data are transmitted in order. FSYNC and each data bit (except the MSB of slot 0 when TX\_OFFSET equals 0) is transmitted on the rising edge of BCLK. 図 7-2 to 図 7-5 illustrate the protocol timing for TDM operation with various configurations.



図 7-2. TDM Mode Standard Protocol Timing (PASI\_TX\_OFFSET = 0)



図 7-3. TDM Mode Protocol Timing (PASI\_TX\_OFFSET = 2)

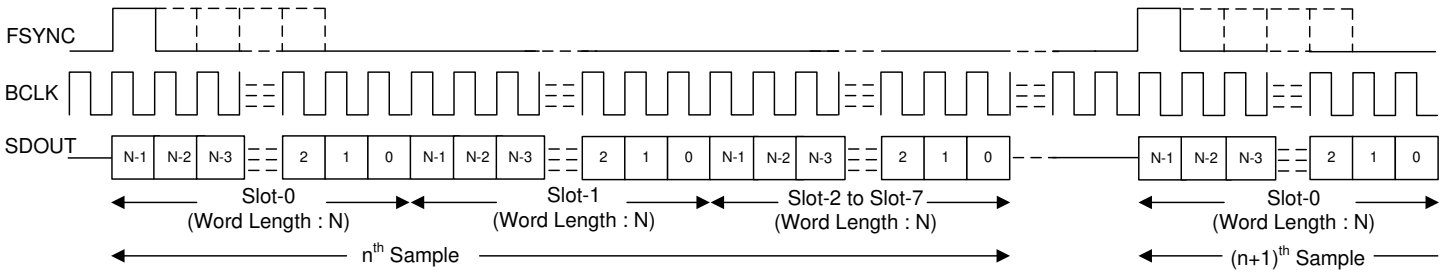

図 7-4. TDM Mode Protocol Timing (No Idle BCLK Cycles, PASI\_TX\_OFFSET = 2)

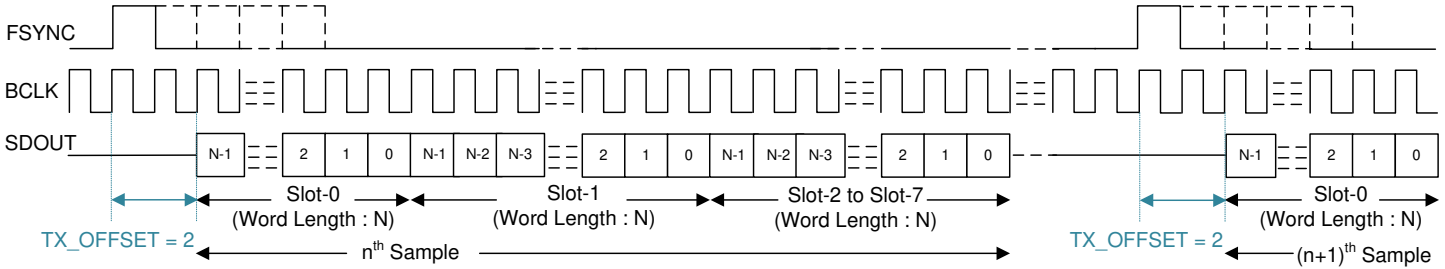

図 7-5. TDM Mode Protocol Timing (PASI\_TX\_OFFSET = 0 and PASI\_BCLK\_POL = 1)

For proper operation of the audio bus in TDM mode, the number of bit clocks per frame must be greater than or equal to the number of active output channels times the programmed word length of the output channel data. The device supports FSYNC as a pulse with a 1-cycle-wide bit clock, but also supports multiples as well. For a higher BCLK frequency operation, using TDM mode with a PASI\_TX\_OFFSET value higher than 0 is recommended.

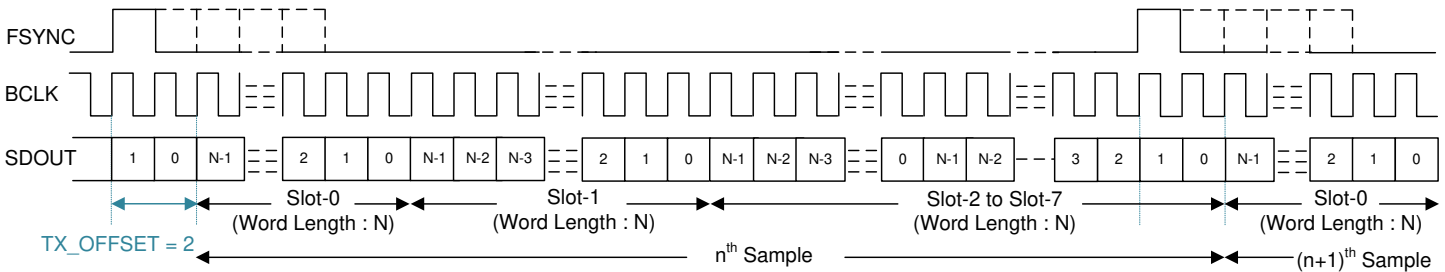
### 7.3.1.2.2 Inter IC Sound (I<sup>2</sup>S) Interface

The standard I<sup>2</sup>S protocol is defined for only two channels: left and right. The device extends the same protocol timing for multichannel operation. In I<sup>2</sup>S mode, the MSB of the left slot 0 is transmitted on the falling edge of BCLK in the second cycle after the falling edge of FSYNC. Immediately after the left slot 0 data transmission, the remaining left slot data are transmitted in order. The MSB of the right slot 0 is transmitted on the falling edge of

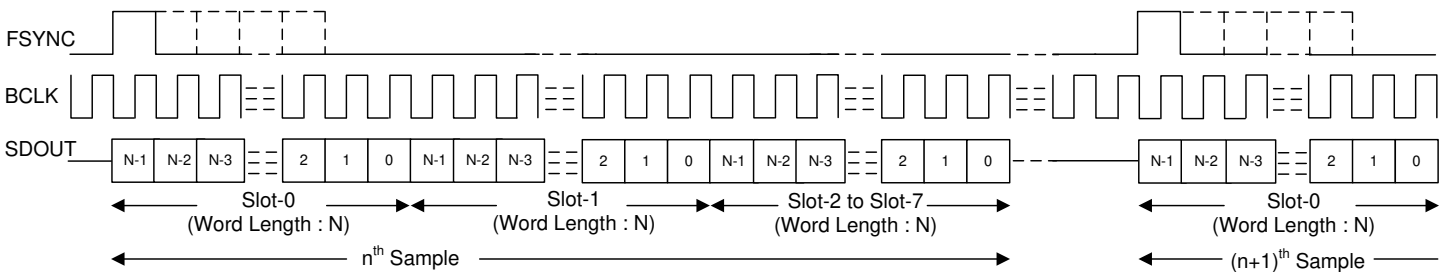
ADVANCE INFORMATION

BCLK in the second cycle after the *rising* edge of FSYNC. Immediately after the right slot 0 data transmission, the remaining right slot data are transmitted in order. FSYNC and each data bit is transmitted on the falling edge of BCLK. 7-6 to 7-9 illustrate the protocol timing for I<sup>2</sup>S operation with various configurations.

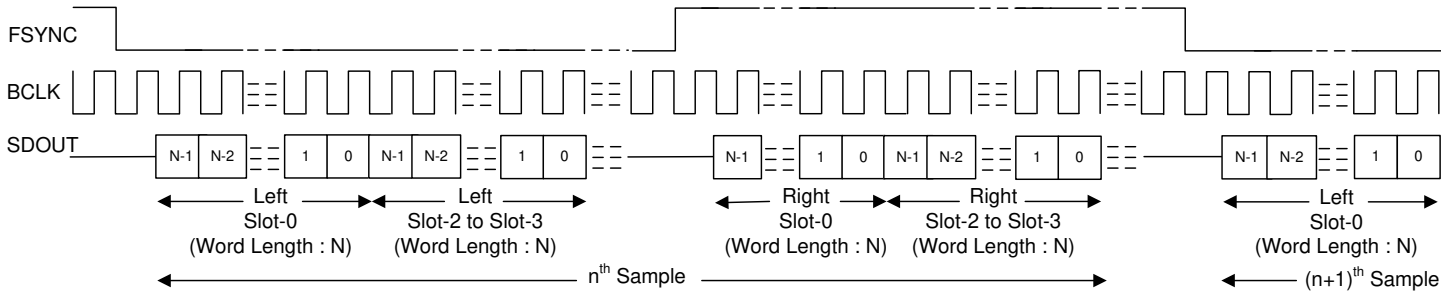

7-6. I<sup>2</sup>S Mode Standard Protocol Timing (PASI\_TX\_OFFSET = 0)

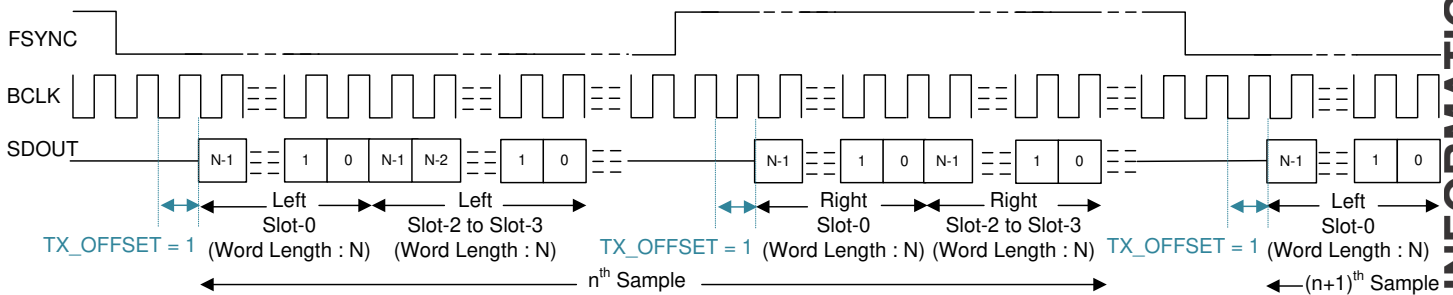

7-7. I<sup>2</sup>S Protocol Timing (PASI\_TX\_OFFSET = 1)

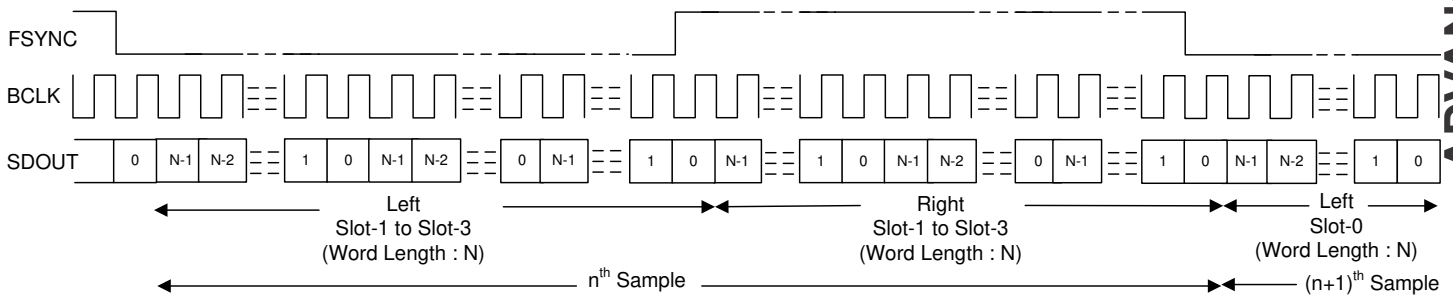

7-8. I<sup>2</sup>S Protocol Timing (No Idle BCLK Cycles, PASI\_TX\_OFFSET = 0)

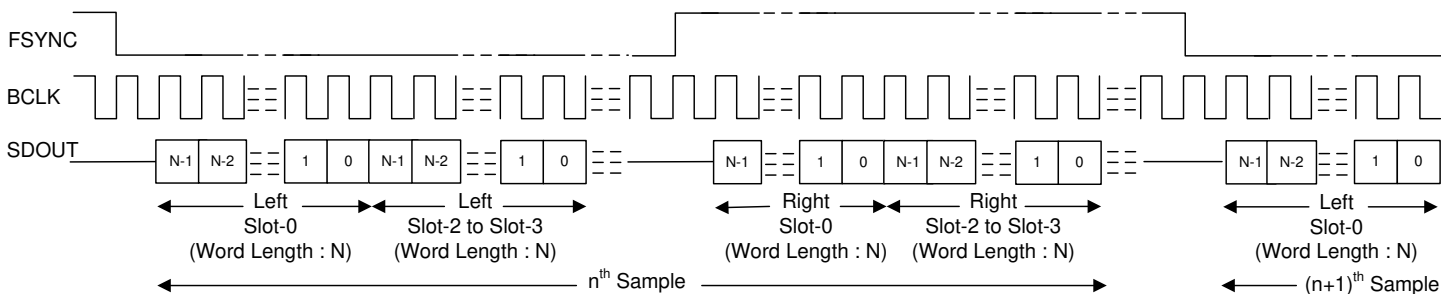



7-9. I<sup>2</sup>S Protocol Timing (PASI\_TX\_OFFSET = 0 and PASI\_BCLK\_POL = 1)

For proper operation of the audio bus in I<sup>2</sup>S mode, the number of bit clocks per frame must be greater than or equal to the number of active output channels (including left and right slots) times the programmed word length of the output channel data. The device FSYNC low pulse must be a number of BCLK cycles wide that is greater than or equal to the number of active left slots times the data word length configured. Similarly, the FSYNC high

ADVANCE INFORMATION

pulse must be a number of BCLK cycles wide that is greater than or equal to the number of active right slots times the data word length configured.

### 7.3.1.2.3 Left-Justified (LJ) Interface

The standard LJ protocol is defined for only two channels: left and right. The device extends the same protocol timing for multichannel operation. In LJ mode, the MSB of the left slot 0 is transmitted in the same BCLK cycle after the *rising* edge of FSYNC. Each subsequent data bit is transmitted on the falling edge of BCLK. Immediately after the left slot 0 data transmission, the remaining left slot data are transmitted in order. The MSB of the right slot 0 is transmitted in the same BCLK cycle after the *falling* edge of FSYNC. Each subsequent data bit is transmitted on the falling edge of BCLK. Immediately after the right slot 0 data transmission, the remaining right slot data are transmitted in order. FSYNC is transmitted on the falling edge of BCLK.  7-10 to  7-13 illustrate the protocol timing for LJ operation with various configurations.

ADVANCE INFORMATION

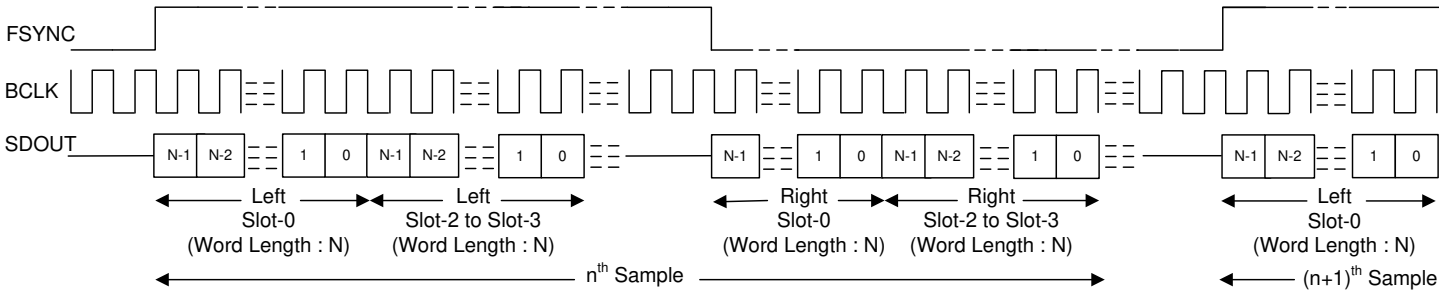

 7-10. LJ Mode Standard Protocol Timing (TX\_OFFSET = 0)

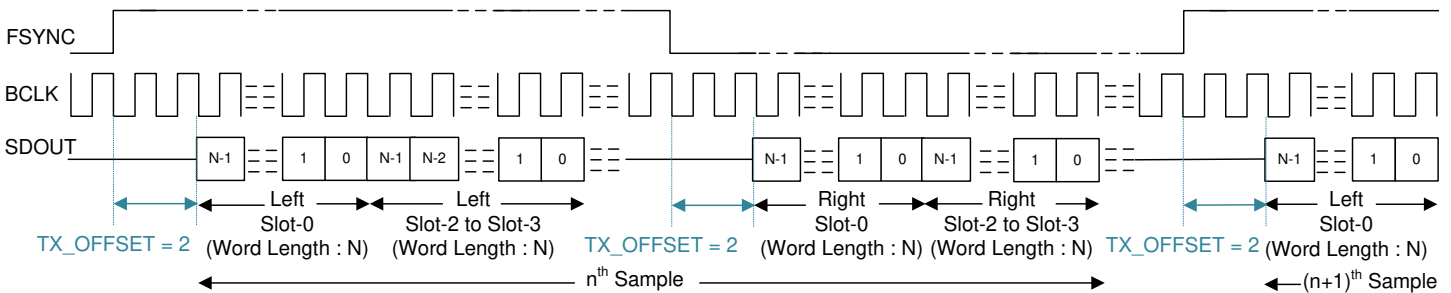

 7-11. LJ Protocol Timing (TX\_OFFSET = 2)

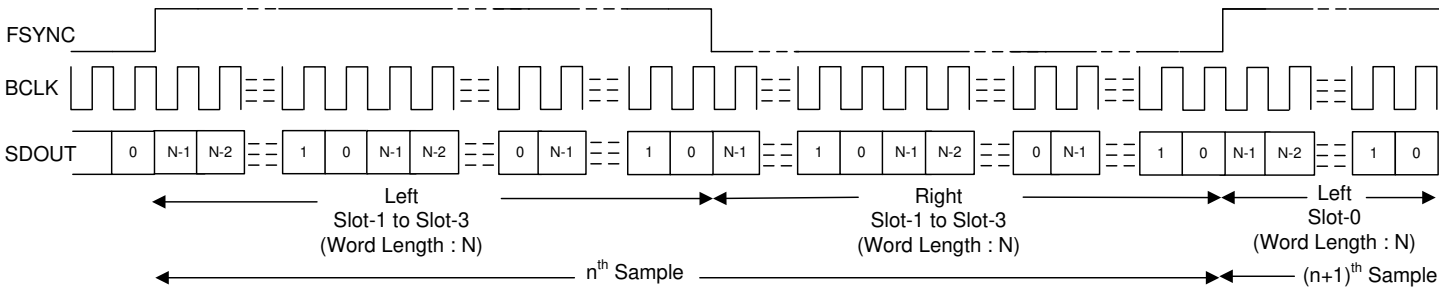

 7-12. LJ Protocol Timing (No Idle BCLK Cycles, TX\_OFFSET = 0)

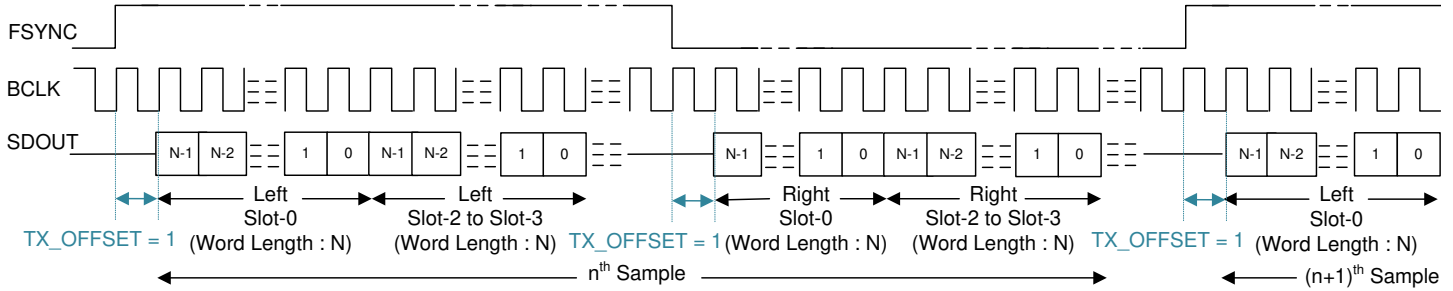

Figure 7-13. LJ Protocol Timing (TX\_OFFSET = 1 and BCLK\_POL = 1)

For proper operation of the audio bus in LJ mode, the number of bit clocks per frame must be greater than or equal to the number of active output channels (including left and right slots) times the programmed word length of the output channel data. The device FSYNC high pulse must be a number of BCLK cycles wide that is greater than or equal to the number of active left slots times the data word length configured. Similarly, the FSYNC low pulse must be number of BCLK cycles wide that is greater than or equal to the number of active right slots times the data word length configured. For a higher BCLK frequency operation, using LJ mode with a TX\_OFFSET value higher than 0 is recommended.

### 7.3.1.3 Using Multiple Devices With Shared Buses

The device has many supported features and flexible options that can be used in the system to seamlessly connect multiple TAD5112 devices by sharing a single common I<sup>2</sup>C or SPI control bus and an audio serial interface bus. This architecture enables multiple applications to be applied to a system that require a microphone or speaker array for beam-forming operation, audio conferencing, noise cancellation, and so forth. Figure 7-14 shows a diagram of multiple TAD5112 devices in a configuration where the control and audio data buses are shared.

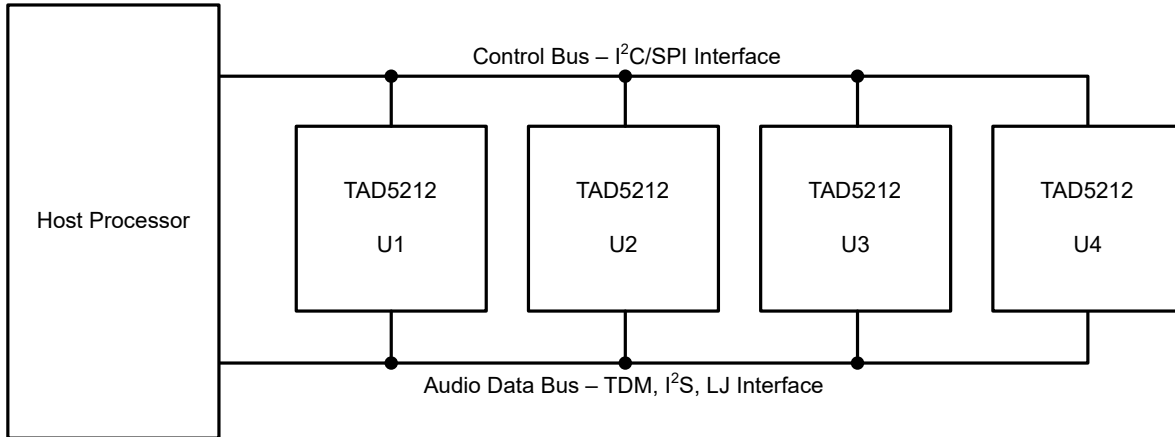

Figure 7-14. Multiple TAD5112 Devices With Shared Control and Audio Data Buses

The TAD5112 consists of the following features to enable seamless connection and interaction of multiple devices using a shared bus:

- Supports up to four pin-programmable I<sup>2</sup>C target addresses
- I<sup>2</sup>C broadcast simultaneously writes to (or triggers) all TAD5112 devices
- Supports up to 32 configuration input/output channel slots for the audio serial interface
- Tri-state feature (with enable and disable) for the unused audio data slots of the device
- Supports a bus-holder feature (with enable and disable) to keep the last driven value on the audio bus
- The GPIOx, GPI1 or GPO1 pin can be configured as a secondary input/output data lane or as a secondary audio serial interface
- The GPIOx, GPI1 or GPO1 pin can be used in a daisy-chain configuration of multiple TAD5112 devices

- Supports one BCLK cycle data latching timing to relax the timing requirement for the high-speed interface
- Programmable controller and target options for both primary and secondary audio serial interface
- Ability to synchronize the multiple devices for the simultaneous sampling requirement across devices
- Inter Channel Gain Alignment(ICGA) feature to align the DAC Channel gain across devices.

See the [Multiple TAC5x1x Devices With a Shared TDM and I<sup>2</sup>C/SPI Bus application report](#) for further details.

### 7.3.1.4 Phase-Locked Loop (PLL) and Clock Generation

The device has a smart auto-configuration block to generate all necessary internal clocks required for the DAC modulators and the digital filter engine used for signal processing. This configuration is done by monitoring the frequency of the FSYNC and BCLK signal on the audio buses.

The device supports the various data sample rates (of the FSYNC signal frequency) and the BCLK to FSYNC ratio to configure all clock dividers, including the PLL configuration, internally without host programming. 表 7-6 and 表 7-7 list the supported FSYNC and BCLK frequencies.

**表 7-6. Supported FSYNC (Multiples or Submultiples of 48 kHz) and BCLK Frequencies**

BCLK TO FSYNC RATIO	BCLK (MHz)								
	FSYNC (8 kHz)	FSYNC (16 kHz)	FSYNC (24 kHz)	FSYNC (32 kHz)	FSYNC (48 kHz)	FSYNC (96 kHz)	FSYNC (192 kHz)	FSYNC (384 kHz)	FSYNC (768 kHz)
16	Reserved	0.256	0.384	0.512	0.768	1.536	3.072	6.144	12.288
24	Reserved	0.384	0.576	0.768	1.152	2.304	4.608	9.216	18.432
32	0.256	0.512	0.768	1.024	1.536	3.072	6.144	12.288	24.576
48	0.384	0.768	1.152	1.536	2.304	4.608	9.216	18.432	Reserved
64	0.512	1.024	1.536	2.048	3.072	6.144	12.288	24.576	Reserved
96	0.768	1.536	2.304	3.072	4.608	9.216	18.432	Reserved	Reserved
128	1.024	2.048	3.072	4.096	6.144	12.288	24.576	Reserved	Reserved
192	1.536	3.072	4.608	6.144	9.216	18.432	Reserved	Reserved	Reserved
256	2.048	4.096	6.144	8.192	12.288	24.576	Reserved	Reserved	Reserved
384	3.072	6.144	9.216	12.288	18.432	Reserved	Reserved	Reserved	Reserved
512	4.096	8.192	12.288	16.384	24.576	Reserved	Reserved	Reserved	Reserved
1024	8.192	16.384	24.576	Reserved	Reserved	Reserved	Reserved	Reserved	Reserved
2048	16.384	Reserved	Reserved	Reserved	Reserved	Reserved	Reserved	Reserved	Reserved

**表 7-7. Supported FSYNC (Multiples or Submultiples of 44.1 kHz) and BCLK Frequencies**

BCLK TO FSYNC RATIO	BCLK (MHz)								
	FSYNC (7.35 kHz)	FSYNC (14.7 kHz)	FSYNC (22.05 kHz)	FSYNC (29.4 kHz)	FSYNC (44.1 kHz)	FSYNC (88.2 kHz)	FSYNC (176.4 kHz)	FSYNC (352.8 kHz)	FSYNC (705.6 kHz)
16	Reserved	Reserved	0.3528	0.4704	0.7056	1.4112	2.8224	5.6448	11.2896
24	Reserved	0.3528	0.5292	0.7056	1.0584	2.1168	4.2336	8.4672	16.9344
32	Reserved	0.4704	0.7056	0.9408	1.4112	2.8224	5.6448	11.2896	22.5792
48	0.3528	0.7056	1.0584	1.4112	2.1168	4.2336	8.4672	16.9344	Reserved
64	0.4704	0.9408	1.4112	1.8816	2.8224	5.6448	11.2896	22.5792	Reserved
96	0.7056	1.4112	2.1168	2.8224	4.2336	8.4672	16.9344	Reserved	Reserved
128	0.9408	1.8816	2.8224	3.7632	5.6448	11.2896	22.5792	Reserved	Reserved
192	1.4112	2.8224	4.2336	5.6448	8.4672	16.9344	Reserved	Reserved	Reserved
256	1.8816	3.7632	5.6448	7.5264	11.2896	22.5792	Reserved	Reserved	Reserved
384	2.8224	5.6448	8.4672	11.2896	16.9344	Reserved	Reserved	Reserved	Reserved
512	3.7632	7.5264	11.2896	15.0528	22.5792	Reserved	Reserved	Reserved	Reserved
1024	7.5264	15.0528	22.5792	Reserved	Reserved	Reserved	Reserved	Reserved	Reserved
2048	15.0528	Reserved	Reserved	Reserved	Reserved	Reserved	Reserved	Reserved	Reserved

The TAD5112 also supports non-Audio sample rates beyond those listed in prior tables. Refer to [Configuring Non-Audio Sample Rates for TAC5x1x devices](#) for more details.

The TAD5112 sample rate can be configured using registers CLK\_DET0 (P0\_R62) and CLK\_DET1 (P0\_R63) for primary and secondary ASI respectively. These registers also capture the device auto detect result for

the FSYNC frequency in auto detection mode. The registers CLK\_DET2 (P0\_R64) and CLK\_DET3 (P0\_R65) capture the BCLK to FSYNC ratio detected of the device. If the device finds any unsupported combinations of FSYNC frequency and BCLK to FSYNC ratios, the device generates an ASI clock-error interrupt and mutes all the channels accordingly.

The TAD5112 also supports enabling channels while DAC channels are already in operation. This requires a pre-configuration before power to describe maximum number of channels which can be enabled while in operation to ensure proper clock generation and use. This can be configured by using register DYN\_PUPD\_CFG (P0\_R119). DAC\_DYN\_PUPD\_EN bits can be used to independently enable DAC Channels dynamic power up. Number of channels can be configured using DAC\_DYN\_MAXCH\_SEL bits.

The device uses an integrated, low-jitter, phase-locked loop (PLL) to generate internal clocks required for the modulators and digital filter engine, as well as other control blocks. The device also supports an option to use BCLK, GPIOx, or the GPI1 pin (as CCLK) as the audio clock source without using the PLL to reduce power consumption. However, the DAC performance may degrade based on jitter from the external clock source, and some processing features may not be supported if the external audio clock source frequency is not high enough. Therefore, TI recommends using the PLL for high-performance applications. More details and information on how to configure and use the device in low-power mode without using the PLL are discussed in the [TAC5x1x Power Consumption Matrix Across Various Usage Scenarios application report](#).

The device also supports an audio bus controller mode operation using the GPIOx or GPI1 pin (as CCLK) as the reference input clock source and supports various flexible options and a wide variety of system clocks. More details and information on controller mode configuration and operation are discussed in the [Configuring and Operating TAC5x1x as an Audio Bus Controller application report](#).

The audio bus clock error detection and auto-detect feature automatically generates all internal clocks, but can be disabled using the IGNORE\_CLK\_ERR (P0\_R4\_D6) and CUSTOM\_CLK\_CFG (P0\_R50\_D0) register bits, respectively. In the system, this disable feature can be used to support custom clock frequencies that are not covered by the auto detect scheme. For such application use cases, care must be taken to ensure that the multiple clock dividers are all configured appropriately. Therefore, TI recommends using the PPC3 GUI for device configuration settings; for more details see the [TAC5212EVM-PDK Evaluation module user's guide](#) and the [PurePath™ console graphical development suite](#).

### 7.3.1.5 Output Channel Configurations

The device consists of two pairs of analog output pins (OUTxP and OUTxM) that can be configured as differential inputs or single-ended outputs for playback channel. The device supports simultaneous playback of up to four channels single-ended output or up to two channel differential output using the high-performance multichannel DAC. 表 7-8 shows the input source selection for the playback channels.

**表 7-8. Input Source Selection for the Playback Channel**

P0_R100_D[7:5] : OUT1x_SRC[2:0]	OUT1P/OUT1M Source Selection
000 (default)	Output driver disabled
001	DAC signal chain
010	Analog bypass signal chain
011	Mixing of DAC and analog bypass signal chains
100	OUT1P for DAC and OUT1M for analog bypass signal chain
101	OUT1P for analog bypass and OUT1M for DAC signal chain.
11x	Reserved. Do not use this setting.

Similarly, the input source selection setting for output channel 2 can be configured using the OUT2x\_SRC[2:0] (P0\_R107\_D[7:5]) register bits.

The TAD5112 supports up to 2 channel differential output, up to 2 channel pseudo-differential output and up to 4 channel single-ended output. Each of the output channels can be independently configured for differential or single-ended output.



表 7-9 shows the configuration modes for the output pins

表 7-9. Output Pin Configuration for the Playback Channel

P0_R100_D[4:2] : OUT1x_CFG[2:0]	OUT1P/OUT1M Pin Configuration
000 (default)	OUT1P/OUT1M as a differential pair
001	OUT1P and OUT1M as independent single-ended outputs
010	Mono Single Ended output on OUT1P only
011	Mono Single Ended output on OUT1M only
100	Pseudo differential output with OUT1P as signal and OUT1M as VCOM
101	Pseudo differential output with OUT1P as signal, OUT1M as VCOM and OUT2M as VCOM sense.
110	Pseudo differential output with OUT1M as signal and OUT1P as VCOM
111	Reserved. Do not use this setting.

Similarly, the output pin configuration for output channel 2 can be done using the OUT2x\_CFG[2:0] (P0\_R107\_D[4:2]) register bits.

The TAD5112 can support a variety of load including headphone, lineout and receiver amplifiers. Load drive configurations are available for each pin independently. OUT1P\_DRIVE[1:0] (OUT1x\_CFG[7:6]) configures the load drive capability for OUT1P pin. OUT1M\_DRIVE[1:0], OUT2P\_DRIVE[1:0], OUT2M\_DRIVE[1:0] are the output drive control for OUT1M, OUT2P and OUT2M respectively.

### 7.3.1.6 Reference Voltage

All audio data converters require a DC reference voltage. The TAD5112 achieves low-noise performance by internally generating a low-noise reference voltage. This reference voltage is generated using a band-gap circuit with high PSRR performance. This audio converter reference voltage must be filtered externally using a minimum 1- $\mu$ F capacitor connected from the VREF pin to analog ground (VSS).

The value of this reference voltage can be configured using the P0\_R77\_D[1:0] register bits and must be set to an appropriate value based on the desired full-scale input for the device and the AVDD supply voltage available in the system. The default VREF value is set to 2.75 V, which in turn supports a 2- $V_{RMS}$  differential full-scale input to the device. The required minimum AVDD voltage for this mode is 3 V. 表 7-10 lists the various VREF settings supported along with required AVDD range and the supported full-scale input signal for that configuration.

表 7-10. VREF Programmable Settings

P0_R77_D[1:0] : VREF[1:0]	VREF OUTPUT VOLTAGE	DIFFERENTIAL FULL-SCALE INPUT SUPPORTED	SINGLE-ENDED FULL-SCALE INPUT SUPPORTED	AVDD RANGE REQUIREMENT
00 (default)	2.75 V	2 $V_{RMS}$ (4 $V_{RMS}$ supported in high swing mode)	1 $V_{RMS}$	3 V to 3.6 V
01	2.5 V	1.818 $V_{RMS}$	0.909 $V_{RMS}$	2.8 V to 3.6 V
10	1.375 V	1 $V_{RMS}$	0.5 $V_{RMS}$	1.7 V to 1.9 V
11	Reserved	Reserved	Reserved	Reserved

To achieve low-power consumption, this audio reference block is powered down as described in the [セクション 7.4](#) section. When exiting sleep mode, the audio reference block is powered up using the internal fast-charge scheme and the VREF pin settles to its steady-state voltage after the settling time (a function of the decoupling capacitor on the VREF pin). This time is approximately equal to 3.5 ms when using a 1- $\mu$ F decoupling capacitor. If a higher-value decoupling capacitor is used on the VREF pin, the fast-charge setting must be reconfigured using the VREF\_QCHG (P0\_R2\_D[4:3]) register bits, which support options of 3.5 ms (default), 10 ms, 50 ms, or 100 ms.

### 7.3.1.7 Programmable Microphone Bias

The device integrates a built-in, low-noise microphone bias pin that can be used in the system for biasing electret-condenser microphones or providing the supply to the MEMS analog or digital microphone. The integrated bias amplifier supports up to 10 mA of load current that can be used for multiple microphones and is designed to provide a combination of high PSRR, low noise, and programmable bias voltages to allow the biasing to be fine tuned for specific microphone combinations.

When using this MICBIAS pin for biasing or supplying to multiple microphones, avoid any common impedance on the board layout for the MICBIAS connection to minimize coupling across microphones. 表 7-11 shows the available microphone bias programmable options.

表 7-11. MICBIAS Programmable Settings

P0_R77_D[3:2] : MICBIAS_VAL[1:0]	P0_R77_D[1:0] : VREF_FSCALE[1:0]	MICBIAS OUTPUT VOLTAGE
00 (default)	00 (default)	2.75 V (same as the VREF output)
	01	2.5 V (same as the VREF output)
	10	1.375 V (same as the VREF output)
	11	Reserved (do not use these settings)
01	00 (default)	1.375 V (0.5 times the VREF output)
	01	1.250 V (0.5 times the VREF output)
	10 or 11	Reserved (do not use these settings)
10	XX	Reserved (do not use these settings)
11	XX	Same as AVDD

The microphone bias output can be powered on or powered off (default) by configuring the MICBIAS\_PDZ, P0\_R120\_D5 register bit. Additionally, the device provides an option to configure the GPIO1 or GPIx pin to directly control the microphone bias output powering on or off. This feature is useful to control the microphone directly without engaging the host for I<sup>2</sup>C or SPI communication. The MICBIAS\_PDZ, P0\_R120\_D5 register bit value is ignored if the GPIO1 or GPIx pin is configured to set the microphone bias on or off.

### 7.3.1.8 Signal-Chain Processing

The TAD5112 signal chain is comprised of very-low-noise, high-performance, and low-power analog blocks and highly flexible and programmable digital processing blocks. The high performance and flexibility combined with a compact package makes the TAD5112 optimized for a variety of end-equipments and applications that require multichannel audio playback. [セクション 7.3.1.8.1](#) describe key components in DAC signal chain further.

### 7.3.1.8.1 DAC Signal-Chain

Figure 7-15 shows the key components of the playback signal chain.

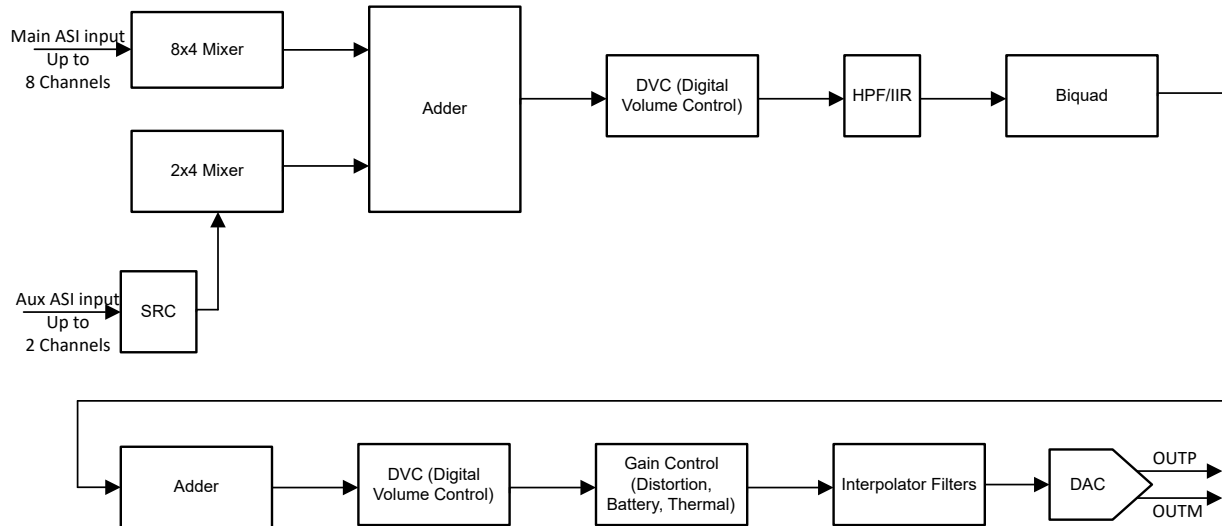

Figure 7-15. DAC Signal-Chain Processing Flowchart

The DAC signal chain offers a highly flexible low noise playback path for low noise and high-fidelity audio applications. This low-noise and low-distortion, multibit, delta-sigma DAC enables the TAD5112 to achieve 106dB dynamic range in a very low power. Moreover, the DAC architecture has inherent antialias filtering with a high rejection of out-of-band frequency noise around multiple modulator frequency components. Therefore, the device prevents noise from aliasing into the audio band. Further on in the signal chain, an integrated, high-performance multistage digital interpolation filter sharply cuts off any out-of-band frequency noise with high stop-band attenuation.

The signal chain also consists of various highly programmable digital processing blocks such as biquad filters, phase calibration, gain calibration, high-pass filter, digital summer or mixer, synchronous sample rate converter, distortion limiter, thermal foldback, brownout prevention and volume control. The details on these processing blocks are discussed further in this section. The device also supports up to four channel single-ended output modes and an analog bypass option from analog input to DAC output.

The output channels for playback can be enabled or disabled by using the CH\_EN (P0\_R118) register, and the input channels for the audio serial interface can be enabled or disabled by using the PASI\_RX\_CHx\_CFG or SASI\_RX\_CHx\_CFG bits. The device supports simultaneous power-up and power-down of all active channels for simultaneous playback. However, based on the application needs, if some channels must be powered-up or powered-down dynamically when the other channel playback is on, then that use case is supported by setting the DYN\_PUPD\_CFG register.

The device supports multiple data mixing options where up to 8 Input Channels from Main ASI, 2 Input Channels from Aux ASI, and tone generator can be mixed with flexible gain options for each path before playback on DAC output. By default, these mixers are disabled and channels are configured for only one channel data. Mixers can be configured by setting ASI\_DIN\_Mixers in Page 17.

The device supports an output signal bandwidth up to 100 kHz, which allows the high-frequency non-audio signal to be played by using a 216-kHz (or higher) sample rate. Wide band mode can be enabled or disabled by using DAC\_CHx\_BW\_Mode bit.

For sample rates of 48 kHz or lower, the device supports all features and various programmable processing blocks. However, for sample rates higher than 48 kHz, there are limitations in the number of simultaneous channel recording and playback supported and the number of biquad filters and such. See the [TAC5212 Sampling Rates and Programmable Processing Blocks Supported application report](#) for further details.

### 7.3.1.8.1.1 Programmable Channel Gain and Digital Volume Control

The device has an independent programmable channel gain setting for each output channel that can be set to the appropriate value based on the maximum input signal expected in the system, This can be done by configuring OUT1x\_LVL\_CTRL and OUT2x\_LVL\_CTRL bits. Coarse gain configuration from -6dB to +24dB is available with these controls in steps of 6dB. .

The device has a programmable digital volume control with a range from -100 dB to 27 dB in steps of 0.5 dB with the option to mute the channel recording. The digital volume control value can be changed dynamically while the DAC channel is powered-up and playing. During volume control changes, the soft ramp-up or ramp-down volume feature is used internally to avoid any audible artifacts. Soft-stepping can be entirely disabled using the DAC\_DSP\_DISABLE\_SOFT\_STEP (P0\_R115\_D1) register bit.

The digital volume control setting is independently available for each of the 4 single ended output channels. In case of 2 Channel Differential DAC, Only settings for DAC\_CH1A and DAC\_CH2A are applicable. The device also supports an option to gang-up the volume control setting for all channels together using the channel 1A digital volume control setting, regardless if channel 1A is powered up or powered down. This gang-up can be enabled using the DAC\_DSP\_DVOL\_GANG (P0\_R115\_D0) register bit.

表 7-12 shows the programmable options available for the digital volume control.

表 7-12. Digital Volume Control (DVC) Programmable Settings

P0_R103_D[7:0] : DAC_CH1A_DVOL[7:0]	DVC SETTING FOR OUTPUT CHANNEL 1A
0000 0000 = 0d	Output channel 1 DVC is set to mute
0000 0001 = 1d	Output channel 1 DVC is set to -100 dB
0000 0010 = 2d	Output channel 1 DVC is set to -99.5 dB
0000 0011 = 3d	Output channel 1 DVC is set to -99 dB
...	...
1100 1000 = 200d	Output channel 1 DVC is set to -0.5 dB
1100 1001 = 201d (default)	Output channel 1 DVC is set to 0 dB
1100 1010 = 202d	Output channel 1 DVC is set to 0.5 dB
...	...
1111 1101 = 253d	Output channel 1 DVC is set to 26 dB
1111 1110 = 254d	Output channel 1 DVC is set to 26.5 dB
1111 1111 = 255d	Output channel 1 DVC is set to 27 dB

Similarly, the digital volume control setting for output channel 1B,2A and 2B can be configured using the CH1B\_DVOL (P0\_R103) to CH2B\_DVOL (P0\_R112) register bits, respectively.

The internal digital processing engine soft ramps up the volume from a muted level to the programmed volume level when the channel is powered up, and the internal digital processing engine soft ramps down the volume from a programmed volume to mute when the channel is powered down. This soft-stepping of volume is done to prevent abruptly powering up and powering down the playback channel which can cause audible artifacts. This feature can also be entirely disabled using the DAC\_DSP\_DISABLE\_SOFT\_STEP (P0\_R115\_D1) register bit.

### 7.3.1.8.1.2 Programmable Channel Gain Calibration

Along with the digital volume control, this device also provides programmable channel gain calibration. The gain of each channel can be finely calibrated or adjusted in steps of 0.1 dB for a range of -0.8-dB to 0.7-dB gain error. This adjustment is useful when trying to match the gain across channels resulting from transducer sensitivity and load impedance mismatch. This feature, in combination with the regular digital volume control, allows the gains across all channels to be matched for a wide gain error range with a resolution of 0.1 dB. 表 7-13 shows the programmable options available for the channel gain calibration.

**表 7-13. DAC Channel Gain Calibration Programmable Settings**

P0_R104_D[7:4] : DAC_CH1A_FGAIN[3:0]	CHANNEL GAIN CALIBRATION SETTING FOR INPUT CHANNEL 1A
0000 = 0d	Input channel 1 gain calibration is set to -0.8 dB
0001 = 1d	Input channel 1 gain calibration is set to -0.7 dB
...	...
1000 = 8d (default)	Input channel 1 gain calibration is set to 0 dB
...	...
1110 = 14d	Input channel 1 gain calibration is set to 0.6 dB
1111 = 15d	Input channel 1 gain calibration is set to 0.7 dB

Similarly, the channel gain calibration setting for input channel 1B,2A and 2B can be configured using the DAC\_CH1B\_CFG1 (P0\_R106), DAC\_CH2A\_CFG1 (P0\_R111), and DAC\_CH2B\_CFG1 (P0\_R113) register bits, respectively.

**7.3.1.8.1.3 Programmable Digital High-Pass Filter**

To remove the DC offset component and attenuate the undesired low-frequency noise content in the record data, the device supports a programmable high-pass filter (HPF). The HPF is not a channel-independent filter setting but is globally applicable for all DAC channels. This HPF is constructed using the first-order infinite impulse response (IIR) filter, and is efficient enough to filter out possible DC components of the signal. 表 7-14 shows the predefined -3-dB cutoff frequencies available that can be set by using the DAC\_DSP\_HPF\_SEL[1:0] register bits of P0\_R115. Additionally, to achieve a custom -3-dB cutoff frequency for a specific application, the device also allows the first-order IIR filter coefficients to be programmed when the DAC\_DSP\_HPF\_SEL[1:0] register bits are set to 2'b00. 図 7-16 illustrates a frequency response plot for the HPF filter.

**表 7-14. HPF Programmable Settings**

P0_R115_D[5:4] : DAC_DSP_HPF_SEL[1:0]	-3-dB CUTOFF FREQUENCY SETTING	-3-dB CUTOFF FREQUENCY AT 16-kHz SAMPLE RATE	-3-dB CUTOFF FREQUENCY AT 48-kHz SAMPLE RATE
00	Programmable 1st-order IIR filter	Programmable 1st-order IIR filter	Programmable 1st-order IIR filter
01 (default)	$0.00002 \times f_s$	0.25 Hz	1 Hz
10	$0.00025 \times f_s$	4 Hz	12 Hz
11	$0.002 \times f_s$	32 Hz	96 Hz

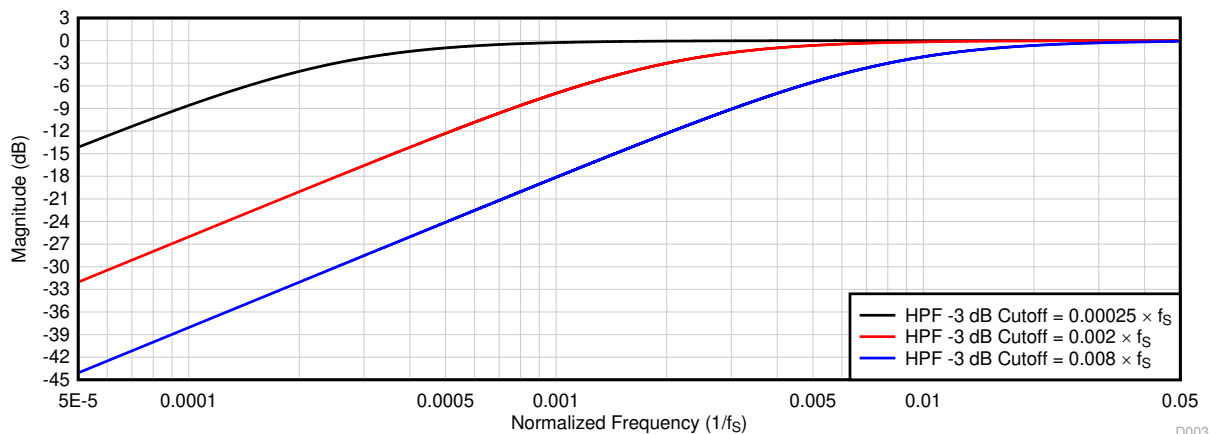

**図 7-16. HPF Filter Frequency Response Plot**

D003

式 1 gives the transfer function for the first-order programmable IIR filter:

$$H(z) = \frac{N_0 + N_1 z^{-1}}{2^{31} - D_1 z^{-1}} \quad (1)$$

The frequency response for this first-order programmable IIR filter with default coefficients is flat at a gain of 0 dB (all-pass filter). The host device can override the frequency response by programming the IIR coefficients in 表 7-15 to achieve the desired frequency response for high-pass filtering or any other desired filtering. If DAC\_DSP\_HP\_SEL[1:0] are set to 2'b00, the host device must write these coefficients values for the desired frequency response before powering-up any DAC channel for playback. 表 7-15 shows the filter coefficients for the first-order IIR filter.

表 7-15. 1st-Order IIR Filter Coefficients

FILTER	FILTER COEFFICIENT	DEFAULT COEFFICIENT VALUE	COEFFICIENT REGISTER MAPPING
Programmable 1st-order IIR filter (can be allocated to HPF or any other desired filter)	N <sub>0</sub>	0x7FFFFFFF	P17_R120-R124
	N <sub>1</sub>	0x00000000	P17_R125-R128
	D <sub>1</sub>	0x00000000	P18_R8-R11

### 7.3.1.8.1.4 Programmable Digital Biquad Filters

The device supports up to 12 programmable digital biquad filters available for DAC signal chain limited to 3/channel. These highly efficient filters achieve the desired frequency response. The TAD5112 also supports on the fly programmable Biquad filters for two channel playback use case. In digital signal processing, a digital biquad filter is a second-order, recursive linear filter with two poles and two zeros. 式 2 gives the transfer function of each biquad filter:

$$H(z) = \frac{N_0 + 2N_1 z^{-1} + N_2 z^{-2}}{2^{31} - 2D_1 z^{-1} - D_2 z^{-2}} \quad (2)$$

The frequency response for the biquad filter section with default coefficients is flat at a gain of 0 dB (all-pass filter). The host device can override the frequency response by programming the biquad coefficients to achieve the desired frequency response for a low-pass, high-pass, or any other desired frequency shaping. As described in 表 7-16, these biquad filters can be allocated for each output channel based on the DAC\_DSP\_BQ\_CFG[1:0] register setting of P0\_R115. By setting DAC\_DSP\_BQ\_CFG[1:0] to 2'b00, the biquad filtering for all playback channels are disabled and the host device can choose this setting if no additional filtering is required for the system application. See the [TAC5212 Programmable Biquad Filter Configuration and Applications application report](#) for further details.

表 7-16. Biquad Filter Allocation to the Output Channel

PROGRAMMABLE BIQUAD FILTER	RECORD OUTPUT CHANNEL ALLOCATION USING P0_R115_D[3:2] REGISTER SETTING		
	DAC_DSP_BQ_CFG[1:0] = 2'b01 (1 Biquad per Channel)	DAC_DSP_BQ_CFG[1:0] = 2'b10 (Default) (2 Biquads per Channel)	DAC_DSP_BQ_CFG[1:0] = 2'b11 (3 Biquads per Channel)
Biquad filter 1	Allocated to output channel 1	Allocated to output channel 1	Allocated to output channel 1
Biquad filter 2	Allocated to output channel 2	Allocated to output channel 2	Allocated to output channel 2
Biquad filter 3	Allocated to output channel 3	Allocated to output channel 3	Allocated to output channel 3
Biquad filter 4	Allocated to output channel 4	Allocated to output channel 4	Allocated to output channel 4
Biquad filter 5	Not used	Allocated to output channel 1	Allocated to output channel 1
Biquad filter 6	Not used	Allocated to output channel 2	Allocated to output channel 2
Biquad filter 7	Not used	Allocated to output channel 3	Allocated to output channel 3
Biquad filter 8	Not used	Allocated to output channel 4	Allocated to output channel 4
Biquad filter 9	Not used	Not used	Allocated to output channel 1
Biquad filter 10	Not used	Not used	Allocated to output channel 2

**表 7-16. Biquad Filter Allocation to the Output Channel (続き)**

PROGRAMMABLE BIQUAD FILTER	RECORD OUTPUT CHANNEL ALLOCATION USING P0_R115_D[3:2] REGISTER SETTING		
	DAC_DSP_BQ_CFG[1:0] = 2'b01 (1 Biquad per Channel)	DAC_DSP_BQ_CFG[1:0] = 2'b10 (Default) (2 Biquads per Channel)	DAC_DSP_BQ_CFG[1:0] = 2'b11 (3 Biquads per Channel)
Biquad filter 11	Not used	Not used	Allocated to output channel 3
Biquad filter 12	Not used	Not used	Allocated to output channel 4

表 7-17 shows the biquad filter coefficients mapping to the register space.

**表 7-17. Biquad Filter Coefficients Register Mapping**

PROGRAMMABLE BIQUAD FILTER	BIQUAD FILTER COEFFICIENTS REGISTER MAPPING	PROGRAMMABLE BIQUAD FILTER	BIQUAD FILTER COEFFICIENTS REGISTER MAPPING
Biquad filter 1	P16_R8-R27	Biquad filter 7	P17_R8-R27
Biquad filter 2	P16_R28-R47	Biquad filter 8	P17_R28-R47
Biquad filter 3	P16_R48-R67	Biquad filter 9	P17_R48-R67
Biquad filter 4	P16_R68-R87	Biquad filter 10	P17_R68-R87
Biquad filter 5	P16_R88-R107	Biquad filter 11	P17_R88-R107
Biquad filter 6	P16_R108-R127	Biquad filter 12	P17_R108-R127

#### 7.3.1.8.1.5 Programmable Digital Mixer

The device supports a fully programmable mixer feature that can mix the various input channels with their custom programmable scale factor to generate the final output channels.



### 7.3.1.8.1.6 Configurable Digital Interpolation Filters

The device playback channel includes a high dynamic range, built-in digital interpolation filter to process the input data stream to generate digital data stream for multibit delta-sigma ( $\Delta\Sigma$ ) modulator. The interpolation filter can be chosen from four different types, depending on the required frequency response, group delay, power consumption, and phase linearity requirements for the target application. The selection of the interpolation filter option can be done by configuring the DAC\_DSP\_INTX\_FILT, P0\_R115\_D[7:6] register bits. Low power filter can be configured by setting DAC\_LOW\_PWR\_FILT, P0\_R79\_D2 bit. [表 7-18](#) shows the configuration register setting for the decimation filter mode selection for the record channel.

**表 7-18. Interpolation Filter Mode Selection for the Playback Channel**

P0_R79_D2 : DAC_LOW_PWR_FILT	P0_R115_D[7:6] : DAC_DSP_INTX_FILT[1:0]	INTERPOLATION FILTER MODE SELECTION
0	00 (default)	Linear phase filters are used for the interpolation
0	01	Low latency filters are used for the interpolation
0	10	Ultra-low latency filters are used for the interpolation
0	11	Reserved (do not use this setting)
1	x	Low power filters are used for the interpolation

#### 7.3.1.8.1.6.1 Linear Phase Filters

The linear phase interpolation filters are the default filters set by the device and can be used for all applications that require a perfect linear phase with zero-phase deviation within the pass-band specification of the filter. The filter performance specifications and various plots for all supported output sampling rates are listed in this section.

**7.3.1.8.1.6.1.1 Sampling Rate: 16 kHz or 14.7 kHz**

図 7-17 and 図 7-18 respectively show the magnitude response and the pass-band ripple for a interpolation filter with a sampling rate of 16 kHz or 14.7 kHz. 表 7-19 lists the specifications for a interpolation filter with an 16-kHz or 14.7-kHz sampling rate.



図 7-17. Linear Phase Interpolation Filter Magnitude Response



図 7-18. Linear Phase Interpolation Filter Pass-Band Ripple

**表 7-19. Linear Phase Interpolation Filter Specifications**

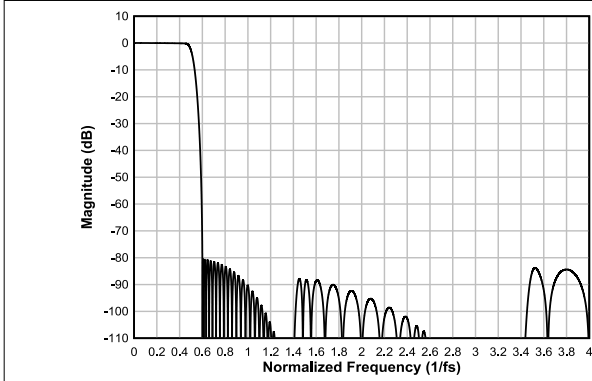
PARAMETER	TEST CONDITIONS	MIN	TYP	MAX	UNIT
Pass-band ripple	Frequency range is 0 to $0.454 \times f_S$	-0.17		0.03	dB
Stop-band attenuation	Frequency range is $0.6 \times f_S$ to $4 \times f_S$	80.4			
	Frequency range is $4 \times f_S$ to $7.43 \times f_S$	86.9			
Group delay or latency	Frequency range is 0 to $0.454 \times f_S$		16.0		$1/f_S$

**7.3.1.8.1.6.1.2 Sampling Rate: 24 kHz or 22.05 kHz**

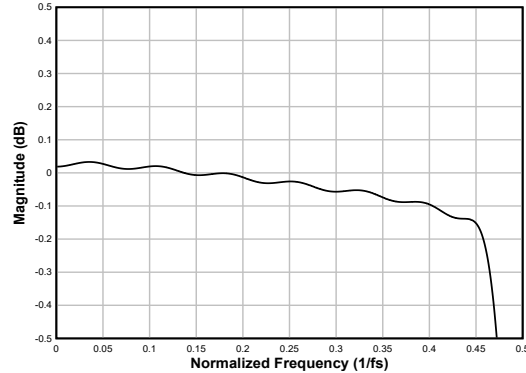
図 7-19 and 図 7-20 respectively show the magnitude response and the pass-band ripple for a interpolation filter with a sampling rate of 24 kHz or 22.05 kHz. 表 7-20 lists the specifications for a interpolation filter with an 24-kHz or 22.05-kHz sampling rate.



図 7-19. Linear Phase Interpolation Filter Magnitude Response



図 7-20. Linear Phase Interpolation Filter Pass-Band Ripple

**表 7-20. Linear Phase Interpolation Filter Specifications**

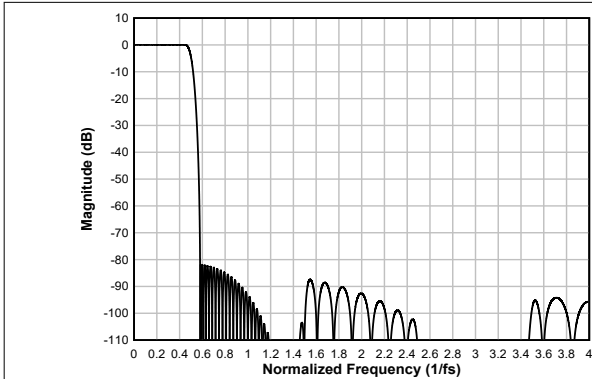
PARAMETER	TEST CONDITIONS	MIN	TYP	MAX	UNIT
Pass-band ripple	Frequency range is 0 to $0.454 \times f_S$	-0.05		0.03	dB
Stop-band attenuation	Frequency range is $0.58 \times f_S$ to $4 \times f_S$	81.9			
	Frequency range is $4 \times f_S$ to $15.42 \times f_S$	87.6			

表 7-20. Linear Phase Interpolation Filter Specifications (続き)

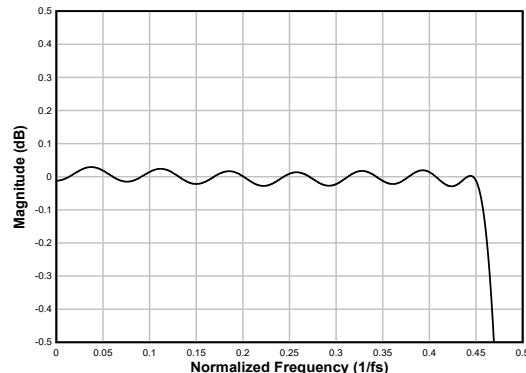
PARAMETER	TEST CONDITIONS	MIN	TYP	MAX	UNIT
Group delay or latency	Frequency range is 0 to $0.454 \times f_S$		17.6		$1/f_S$

7.3.1.8.1.6.1.3 Sampling Rate: 32 kHz or 29.4 kHz

図 7-21 and 図 7-22 respectively show the magnitude response and the pass-band ripple for a interpolation filter with a sampling rate of 32 kHz or 29.4 kHz. 表 7-21 lists the specifications for a interpolation filter with an 32-kHz or 29.4-kHz sampling rate.



表 7-21. Linear Phase Interpolation Filter Specifications

PARAMETER	TEST CONDITIONS	MIN	TYP	MAX	UNIT
Pass-band ripple	Frequency range is 0 to $0.454 \times f_S$	-0.05		0.03	dB
Stop-band attenuation	Frequency range is $0.586 \times f_S$ to $4 \times f_S$	81.9			dB
	Frequency range is $4 \times f_S$ to $15.42 \times f_S$	87.6			
Group delay or latency	Frequency range is 0 to $0.454 \times f_S$		17.6		$1/f_S$

7.3.1.8.1.6.1.4 Sampling Rate: 48 kHz or 44.1 kHz

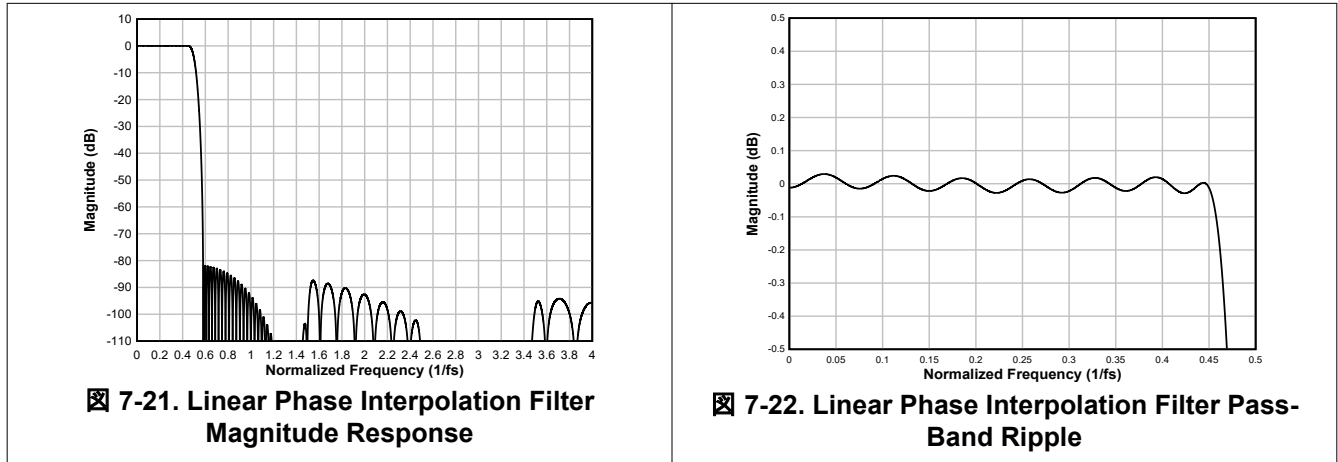
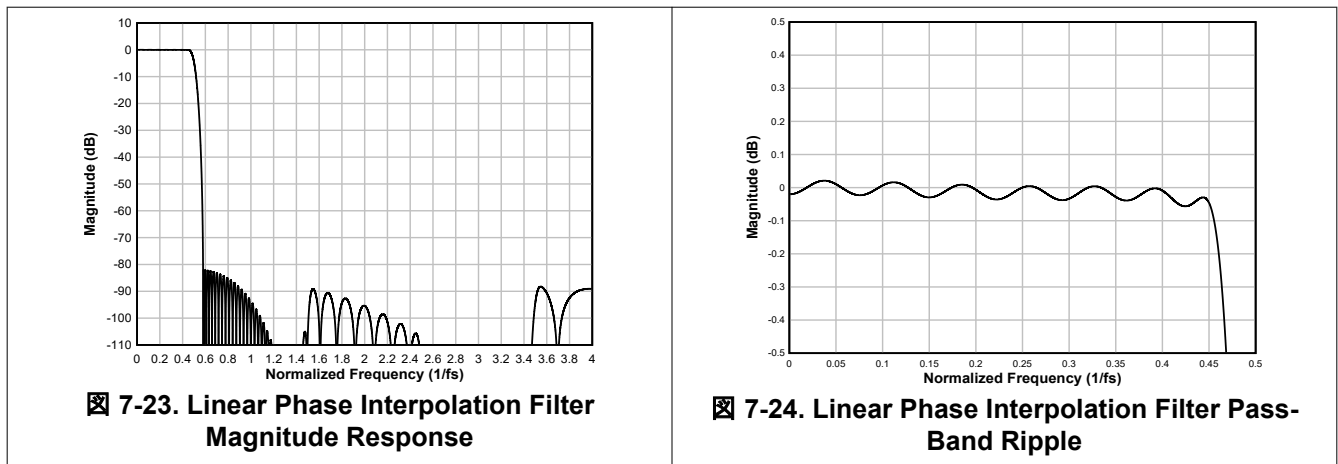

図 7-23 and 図 7-24 respectively show the magnitude response and the pass-band ripple for a interpolation filter with a sampling rate of 48 kHz or 44.1 kHz. 表 7-22 lists the specifications for a interpolation filter with an 48-kHz or 44.1-kHz sampling rate.



**表 7-22. Linear Phase Interpolation Filter Specifications**

PARAMETER	TEST CONDITIONS	MIN	TYP	MAX	UNIT
Pass-band ripple	Frequency range is 0 to $0.454 \times f_S$	-0.08		0.02	dB
Stop-band attenuation	Frequency range is $0.585 \times f_S$ to $4 \times f_S$	82.0			dB
	Frequency range is $4 \times f_S$ to $7.42 \times f_S$ onwards	89.0			
Group delay or latency	Frequency range is 0 to $0.454 \times f_S$		17.3		$1/f_S$

**7.3.1.8.1.6.1.5 Sampling Rate: 96 kHz or 88.2 kHz**

 7-25 and  7-26 respectively show the magnitude response and the pass-band ripple for a interpolation filter with a sampling rate of 96 kHz or 88.2 kHz. 表 7-23 lists the specifications for a interpolation filter with an 96-kHz or 88.2-kHz sampling rate.

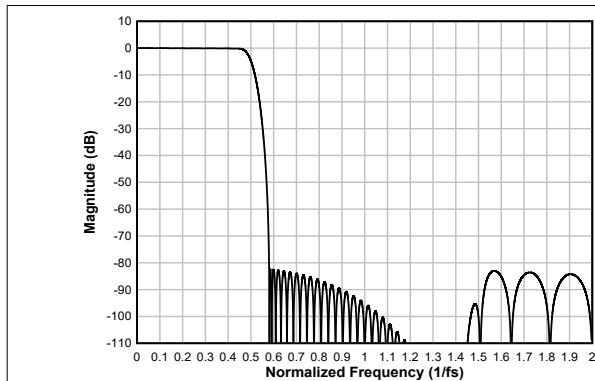

 7-25. Linear Phase Interpolation Filter Magnitude Response

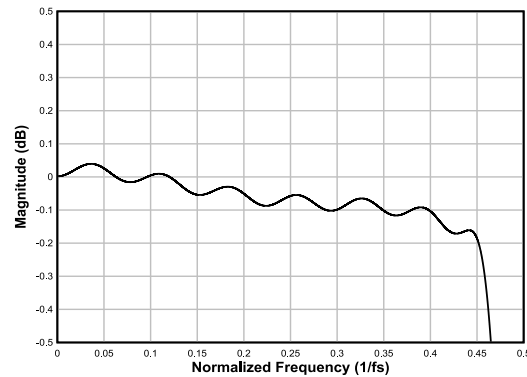



 7-26. Linear Phase Interpolation Filter Pass-Band Ripple

**表 7-23. Linear Phase Interpolation Filter Specifications**

PARAMETER	TEST CONDITIONS	MIN	TYP	MAX	UNIT
Pass-band ripple	Frequency range is 0 to $0.452 \times f_S$	-0.2		0.04	dB
Stop-band attenuation	Frequency range is $0.58 \times f_S$ to $3.42 \times f_S$	82.4			dB
Group delay or latency	Frequency range is 0 to $0.454 \times f_S$		16.7		$1/f_S$

**7.3.1.8.1.6.1.6 Sampling Rate: 384 kHz or 352.8 kHz**

 7-27 and  7-28 respectively show the magnitude response and the pass-band ripple for a interpolation filter with a sampling rate of 384 kHz or 352.8 kHz. 表 7-24 lists the specifications for a interpolation filter with an 384-kHz or 352.8-kHz sampling rate.



図 7-27. Linear Phase Interpolation Filter Magnitude Response



図 7-28. Linear Phase Interpolation Filter Pass-Band Ripple

表 7-24. Linear Phase Interpolation Filter Specifications

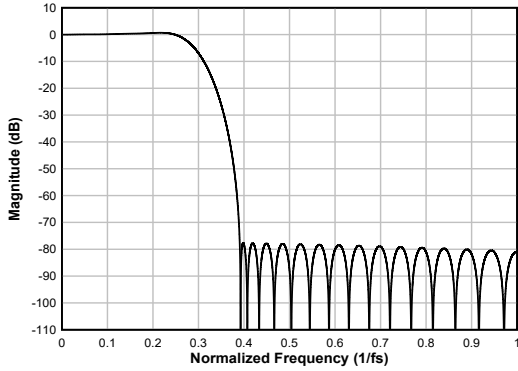
PARAMETER	TEST CONDITIONS	MIN	TYP	MAX	UNIT
Pass-band ripple	Frequency range is 0 to $0.245 \times f_s$	-0.03		0.67	dB
Stop-band attenuation	Frequency range is $0.391 \times f_s$ to $1.61 \times f_s$	77.6			dB
Group delay or latency	Frequency range is 0 to $0.212 \times f_s$		10.7		$1/f_s$

### 7.3.1.9 Interrupts, Status, and Digital I/O Pin Multiplexing

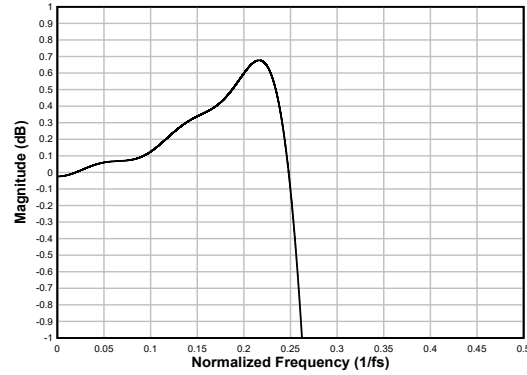
Certain events in the device may require host processor intervention and can be used to trigger interrupts to the host processor. One such event is an audio serial interface (ASI) bus error. The device powers down the record channels if any faults are detected with the ASI bus error clocks, such as:

- Invalid FSYNC frequency
- Invalid SBCLK to FSYNC ratio
- Long pauses of the SBCLK or FSYNC clocks

When an ASI bus clock error is detected, the device shuts down all the record and playback channels as quickly as possible. After all ASI bus clock errors are resolved, the device volume ramps back to its previous state to recover the audio. During an ASI bus clock error, the internal interrupt request (IRQ) interrupt signal asserts low if the clock error interrupt mask register bit INT\_MASK0[7] (P1\_R47\_D7) is set low. The clock fault is also available for readback in the latched fault status register bit INT\_LTCH0 (P1\_R52), which is a read-only register. Reading the latched fault status register, INT\_LTCH0, clears all latched fault status. The device can be additionally configured to route the internal IRQ interrupt signal on the GPIOx or GPO1 pins and also can be configured as open-drain outputs so that these pins can be wire-ANDed to the open-drain interrupt outputs of other devices.

The IRQ interrupt signal can either be configured as active low or active high polarity by setting the INT\_POL (P0\_R66\_D7) register bit. This signal can also be configured as a single pulse or a series of pulses by programming the INT\_EVENT[1:0] (P0\_R66\_D[6:5]) register bits. If the interrupts are configured as a series of pulses, the events trigger the start of pulses that stop when the latched fault status register is read to determine the cause of the interrupt.

The device also supports read-only live-status registers to determine if the channels are powered up or down and if the device is in sleep mode or not. These status registers are located in the DEV\_STS0 (P0\_R121) and DEV\_STS1 (P0\_R122) register bits.

The device has a multifunctional GPIO1 pin that can be configured for a desired specific function. 表 7-25 lists all possible allocations of these multifunctional pins for the various features.

**表 7-25. Multifunction Pin Assignments**

ROW	PIN FUNCTION	GPIO1	GPIO2	GPO1	GPI1
—	—	GPIO1_CFG	GPO2_CFG	GPO1_CFG	GPI1_CFG
—	—	P0_R10[7:4]	P0_R11[7:4]	P0_R12[7:4]	P0_R13[1]
A	Pin disabled	S <sup>(1)</sup>	S (default)	S (default)	S (default)
B	General-purpose output (GPO)	S	S	S	NS
C	Interrupt output (IRQ)	S (default)	S	S	NS
D	PDM clock output (PDMCLK)	S	S	S	NS
E	MiCBIAS on/off input (BIASEN)	S	S	NS	S
F	General-purpose input (GPI)	S	S	NS	S
G	Controller clock input (CCLK)	S	S	S	S
H	ASI daisy-chain input	S	S	NS	S
I	ASI DOUT	S	S	S	NS
J	ASI BCLK	S	S	S	S
K	ASI FSYNC	S	S	S	S
L	General Purpose Clock Out	S	S	S	NS
M	ASI daisy-chain output	S	S	S	NS

(1) S means the feature mentioned in this row is *supported* for the respective GPIO1, GPOx, or GPIx pin mentioned in this column.

Each GPOx or GPIOx pin can be independently set for the desired drive configurations setting using the GPIOx\_DRV[2:0] or GPO1\_DRV[2:0] register bits. 表 7-26 lists the drive configuration settings.

**表 7-26. GPIO or GPOx Pins Drive Configuration Settings**

P0_R10_D[2:0] : GPIO1_DRV[2:0]	GPIO OUTPUT DRIVE CONFIGURATION SETTINGS FOR GPIO1
000	The GPIO1 pin is set to high impedance (floated)
001	The GPIO1 pin is set to be driven active low or active high
010 (default)	The GPIO1 pin is set to be driven active low or weak high (on-chip pullup)
011	The GPIO1 pin is set to be driven active low or Hi-Z (floated)
100	The GPIO1 pin is set to be driven weak low (on-chip pulldown) or active high
101	The GPIO1 pin is set to be driven Hi-Z (floated) or active high
110 and 111	Reserved (do not use these settings)

Similarly, the GPO1 pin can be configured using the GPO1\_DRV(P0\_R12) register bits.

When configured as a general-purpose output (GPO), the GPIOx or GPO1 pin values can be driven by writing the GPO\_GPI\_VAL (P0\_R14) registers. The GPIO\_MON bits (P0\_R14\_D[3:1]) can be used to readback the status of the GPIOx or GPI1 pin when configured as a general-purpose input (GPI).

## 7.4 Device Functional Modes

### 7.5 Register Maps

This section describes the control registers for the device in detail. All these registers are eight bits in width and allocated to device configuration and programmable coefficients settings. These registers are mapped internally using a page scheme that can be controlled using either I<sup>2</sup>C or SPI communication to the device. Each page contains 128 bytes of registers. All device configuration registers are stored in page 0, page 1 and page 3. Page 0 is the default page setting at power up (and after a software reset). The device current page can be switch to a new desired page by using the PAGE[7:0] bits located in register 0 of every page.

Do not read from or write to reserved pages or reserved registers. Write only default values for the reserved bits in the valid registers.

The procedure for register access across pages is:

- Select page N (write data N to register 0 regardless of the current page number)
- Read or write data from or to valid registers in page N

- Select the new page  $M$  (write data  $M$  to register 0 regardless of the current page number)
- Read or write data from or to valid registers in page  $M$
- Repeat as needed

## 7.5.1 TAD5212\_P0 Registers

表 7-27 lists the memory-mapped registers for the TAD5212\_P0 registers. All register offset addresses not listed in 表 7-27 should be considered as reserved locations and the register contents should not be modified.

表 7-27. TAD5212\_P0 Registers

Address	Acronym	Register Name	Reset Value	Section
0x0	PAGE_CFG	Device page register	0x00	PAGE_CFG Register (Address = 0x0) [Reset = 0x00]
0x1	SW_RESET	Software reset register	0x00	SW_RESET Register (Address = 0x1) [Reset = 0x00]
0x2	VREF_CFG		0x00	VREF_CFG Register (Address = 0x2) [Reset = 0x00]
0x3	AVDD_IOVDD_STS		0x00	AVDD_IOVDD_STS Register (Address = 0x3) [Reset = 0x00]
0x4	MISC_CFG		0x00	MISC_CFG Register (Address = 0x4) [Reset = 0x00]
0x5	MISC_CFG1		0x15	MISC_CFG1 Register (Address = 0x5) [Reset = 0x15]
0x6	DAC_CFG_A0	DAC DEPOP configuration register	0x55	DAC_CFG_A0 Register (Address = 0x6) [Reset = 0x55]
0x7	MISC_CFG0	Misc. configuration register	0x00	MISC_CFG0 Register (Address = 0x7) [Reset = 0x00]
0xA	GPIO1_CFG0	GPIO1 configuration register 0	0x32	GPIO1_CFG0 Register (Address = 0xA) [Reset = 0x32]
0xB	GPIO2_CFG0	GPIO2 configuration register 0	0x00	GPIO2_CFG0 Register (Address = 0xB) [Reset = 0x00]
0xC	GPO1_CFG0	GPO1 configuration register 0	0x00	GPO1_CFG0 Register (Address = 0xC) [Reset = 0x00]
0xD	GPI_CFG	GPI1 configuration register 0	0x00	GPI_CFG Register (Address = 0xD) [Reset = 0x00]
0xE	GPO_GPI_VAL	GPIO, GPO output value register	0x00	GPO_GPI_VAL Register (Address = 0xE) [Reset = 0x00]
0xF	INTF_CFG0	Interface configuration register 0	0x00	INTF_CFG0 Register (Address = 0xF) [Reset = 0x00]
0x10	INTF_CFG1	Interface configuration register 1	0x52	INTF_CFG1 Register (Address = 0x10) [Reset = 0x52]
0x11	INTF_CFG2	Interface configuration register 2	0x80	INTF_CFG2 Register (Address = 0x11) [Reset = 0x80]
0x12	INTF_CFG3	Interface configuration register 3	0x00	INTF_CFG3 Register (Address = 0x12) [Reset = 0x00]



**表 7-27. TAD5212\_P0 Registers (続き)**

Address	Acronym	Register Name	Reset Value	Section
0x14	INTF_CFG5	Interface configuration register 4	0x00	INTF_CFG5 Register (Address = 0x14) [Reset = 0x00]
0x18	ASI_CFG0	ASI configuration register 0	0x40	ASI_CFG0 Register (Address = 0x18) [Reset = 0x40]
0x19	ASI_CFG1	ASI configuration register 1	0x00	ASI_CFG1 Register (Address = 0x19) [Reset = 0x00]
0x1A	PASI_CFG0	Primary ASI configuration register 0	0x30	PASI_CFG0 Register (Address = 0x1A) [Reset = 0x30]
0x1B	PASI_TX_CFG0	PASI TX configuration register 0	0x00	PASI_TX_CFG0 Register (Address = 0x1B) [Reset = 0x00]
0x1C	PASI_TX_CFG1	PASI TX configuration register 1	0x00	PASI_TX_CFG1 Register (Address = 0x1C) [Reset = 0x00]
0x1D	PASI_TX_CFG2	PASI TX configuration register 2	0x00	PASI_TX_CFG2 Register (Address = 0x1D) [Reset = 0x00]
0x20	PASI_TX_CH3_CFG	PASI TX Channel 3 configuration register	0x02	PASI_TX_CH3_CFG Register (Address = 0x20) [Reset = 0x02]
0x21	PASI_TX_CH4_CFG	PASI TX Channel 4 configuration register	0x03	PASI_TX_CH4_CFG Register (Address = 0x21) [Reset = 0x03]
0x22	PASI_TX_CH5_CFG	PASI TX Channel 5 configuration register	0x04	PASI_TX_CH5_CFG Register (Address = 0x22) [Reset = 0x04]
0x23	PASI_TX_CH6_CFG	PASI TX Channel 6 configuration register	0x05	PASI_TX_CH6_CFG Register (Address = 0x23) [Reset = 0x05]
0x24	PASI_TX_CH7_CFG	PASI TX Channel 7 configuration register	0x06	PASI_TX_CH7_CFG Register (Address = 0x24) [Reset = 0x06]
0x25	PASI_TX_CH8_CFG	PASI TX Channel 8 configuration register	0x07	PASI_TX_CH8_CFG Register (Address = 0x25) [Reset = 0x07]
0x26	PASI_RX_CFG0	PASI RX configuration register 0	0x00	PASI_RX_CFG0 Register (Address = 0x26) [Reset = 0x00]
0x27	PASI_RX_CFG1	PASI RX configuration register 1	0x00	PASI_RX_CFG1 Register (Address = 0x27) [Reset = 0x00]
0x28	PASI_RX_CH1_CFG	PASI RX Channel 1 configuration register	0x20	PASI_RX_CH1_CFG Register (Address = 0x28) [Reset = 0x20]
0x29	PASI_RX_CH2_CFG	PASI RX Channel 2 configuration register	0x21	PASI_RX_CH2_CFG Register (Address = 0x29) [Reset = 0x21]

表 7-27. TAD5212\_P0 Registers (続き)

Address	Acronym	Register Name	Reset Value	Section
0x2A	PASI_RX_CH3_CFG	PASI RX Channel 3 configuration register	0x02	<a href="#">PASI_RX_CH3_CFG Register (Address = 0x2A) [Reset = 0x02]</a>
0x2B	PASI_RX_CH4_CFG	PASI RX Channel 4 configuration register	0x03	<a href="#">PASI_RX_CH4_CFG Register (Address = 0x2B) [Reset = 0x03]</a>
0x2C	PASI_RX_CH5_CFG	PASI RX Channel 5 configuration register	0x04	<a href="#">PASI_RX_CH5_CFG Register (Address = 0x2C) [Reset = 0x04]</a>
0x2D	PASI_RX_CH6_CFG	PASI RX Channel 6 configuration register	0x05	<a href="#">PASI_RX_CH6_CFG Register (Address = 0x2D) [Reset = 0x05]</a>
0x2E	PASI_RX_CH7_CFG	PASI RX Channel 7 configuration register	0x06	<a href="#">PASI_RX_CH7_CFG Register (Address = 0x2E) [Reset = 0x06]</a>
0x2F	PASI_RX_CH8_CFG	PASI RX Channel 8 configuration register	0x07	<a href="#">PASI_RX_CH8_CFG Register (Address = 0x2F) [Reset = 0x07]</a>
0x32	CLK_CFG0	Clock configuration register 0	0x00	<a href="#">CLK_CFG0 Register (Address = 0x32) [Reset = 0x00]</a>
0x33	CLK_CFG1	Clock configuration register 1	0x00	<a href="#">CLK_CFG1 Register (Address = 0x33) [Reset = 0x00]</a>
0x34	CLK_CFG2	Clock configuration register 2	0x40	<a href="#">CLK_CFG2 Register (Address = 0x34) [Reset = 0x40]</a>
0x35	CNT_CLK_CFG0	controller mode clock configuration register 0	0x00	<a href="#">CNT_CLK_CFG0 Register (Address = 0x35) [Reset = 0x00]</a>
0x36	CNT_CLK_CFG1	controller mode clock configuration register 1	0x00	<a href="#">CNT_CLK_CFG1 Register (Address = 0x36) [Reset = 0x00]</a>
0x37	CNT_CLK_CFG2	controller mode clock configuration register 2	0x20	<a href="#">CNT_CLK_CFG2 Register (Address = 0x37) [Reset = 0x20]</a>
0x38	CNT_CLK_CFG3	controller mode clock configuration register 3	0x00	<a href="#">CNT_CLK_CFG3 Register (Address = 0x38) [Reset = 0x00]</a>
0x39	CNT_CLK_CFG4	controller mode clock configuration register 4	0x00	<a href="#">CNT_CLK_CFG4 Register (Address = 0x39) [Reset = 0x00]</a>
0x3A	CNT_CLK_CFG5	controller mode clock configuration register 5	0x00	<a href="#">CNT_CLK_CFG5 Register (Address = 0x3A) [Reset = 0x00]</a>
0x3B	CNT_CLK_CFG6	controller mode clock configuration register 6	0x00	<a href="#">CNT_CLK_CFG6 Register (Address = 0x3B) [Reset = 0x00]</a>

ADVANCE INFORMATION

**表 7-27. TAD5212\_P0 Registers (続き)**

Address	Acronym	Register Name	Reset Value	Section
0x3C	CLK_ERR_STS0	Clock error and status register 0	0x00	<a href="#">CLK_ERR_STS0 Register (Address = 0x3C) [Reset = 0x00]</a>
0x3D	CLK_ERR_STS1	Clock error and status register 1	0x00	<a href="#">CLK_ERR_STS1 Register (Address = 0x3D) [Reset = 0x00]</a>
0x3E	CLK_DET_STS0	Clock ratio detection register 0	0x00	<a href="#">CLK_DET_STS0 Register (Address = 0x3E) [Reset = 0x00]</a>
0x3F	CLK_DET_STS1	Clock ratio detection register 1	0x00	<a href="#">CLK_DET_STS1 Register (Address = 0x3F) [Reset = 0x00]</a>
0x40	CLK_DET_STS2	Clock ratio detection register 2	0x00	<a href="#">CLK_DET_STS2 Register (Address = 0x40) [Reset = 0x00]</a>
0x41	CLK_DET_STS3	Clock ratio detection register 3	0x00	<a href="#">CLK_DET_STS3 Register (Address = 0x41) [Reset = 0x00]</a>
0x42	INT_CFG	Interrupt configuration register	0x00	<a href="#">INT_CFG Register (Address = 0x42) [Reset = 0x00]</a>
0x43	DAC_FLT_CFG	Interrupt configuration register	0x50	<a href="#">DAC_FLT_CFG Register (Address = 0x43) [Reset = 0x50]</a>
0x4F	PWR_TUNE_CFG1	Power tune configuration register 1	0x00	<a href="#">PWR_TUNE_CFG1 Register (Address = 0x4F) [Reset = 0x00]</a>
0x64	OUT1x_CFG0	Channel OUT1x configuration register 0	0x20	<a href="#">OUT1x_CFG0 Register (Address = 0x64) [Reset = 0x20]</a>
0x65	OUT1x_CFG1	Channel OUT1x configuration register 1	0x20	<a href="#">OUT1x_CFG1 Register (Address = 0x65) [Reset = 0x20]</a>
0x66	OUT1x_CFG2	Channel OUT2x configuration register 2	0x20	<a href="#">OUT1x_CFG2 Register (Address = 0x66) [Reset = 0x20]</a>
0x67	DAC_CH1A_CFG0	DAC Channel 1A configuration register 0	0xC9	<a href="#">DAC_CH1A_CFG0 Register (Address = 0x67) [Reset = 0xC9]</a>
0x68	DAC_CH1A_CFG1	DAC Channel 1A configuration register 1	0x80	<a href="#">DAC_CH1A_CFG1 Register (Address = 0x68) [Reset = 0x80]</a>
0x69	DAC_CH1B_CFG0	DAC Channel 1B configuration register 0	0xC9	<a href="#">DAC_CH1B_CFG0 Register (Address = 0x69) [Reset = 0xC9]</a>
0x6A	DAC_CH1B_CFG1	DAC Channel 1B configuration register 1	0x80	<a href="#">DAC_CH1B_CFG1 Register (Address = 0x6A) [Reset = 0x80]</a>
0x6B	OUT2x_CFG0	Channel OUT2x configuration register 0	0x20	<a href="#">OUT2x_CFG0 Register (Address = 0x6B) [Reset = 0x20]</a>

表 7-27. TAD5212\_P0 Registers (続き)

Address	Acronym	Register Name	Reset Value	Section
0x6C	OUT2x_CFG1	Channel OUT2x configuration register 1	0x20	<a href="#">OUT2x_CFG1 Register (Address = 0x6C) [Reset = 0x20]</a>
0x6D	OUT2x_CFG2	Channel OUT2x configuration register 2	0x20	<a href="#">OUT2x_CFG2 Register (Address = 0x6D) [Reset = 0x20]</a>
0x6E	DAC_CH2A_CFG0	DAC Channel 2A configuration register 0	0xC9	<a href="#">DAC_CH2A_CFG0 Register (Address = 0x6E) [Reset = 0xC9]</a>
0x6F	DAC_CH2A_CFG1	DAC Channel 2A configuration register 1	0x80	<a href="#">DAC_CH2A_CFG1 Register (Address = 0x6F) [Reset = 0x80]</a>
0x70	DAC_CH2B_CFG0	DAC Channel 2B configuration register 0	0xC9	<a href="#">DAC_CH2B_CFG0 Register (Address = 0x70) [Reset = 0xC9]</a>
0x71	DAC_CH2B_CFG1	DAC Channel 2B configuration register 1	0x80	<a href="#">DAC_CH2B_CFG1 Register (Address = 0x71) [Reset = 0x80]</a>
0x73	DSP_CFG1	DSP configuration register 0	0x18	<a href="#">DSP_CFG1 Register (Address = 0x73) [Reset = 0x18]</a>
0x76	CH_EN	Channel enable configuration register	0xCC	<a href="#">CH_EN Register (Address = 0x76) [Reset = 0xCC]</a>
0x77	DYN_PUPD_CFG	Power up configuration register	0x00	<a href="#">DYN_PUPD_CFG Register (Address = 0x77) [Reset = 0x00]</a>
0x78	PWR_CFG	Power up configuration register	0x00	<a href="#">PWR_CFG Register (Address = 0x78) [Reset = 0x00]</a>
0x79	DEV_STS0	Device status value register 0	0x00	<a href="#">DEV_STS0 Register (Address = 0x79) [Reset = 0x00]</a>
0x7A	DEV_STS1	Device status value register 1	0x80	<a href="#">DEV_STS1 Register (Address = 0x7A) [Reset = 0x80]</a>
0x7E	I2C_CKSUM	I <sup>2</sup> C checksum register	0x00	<a href="#">I2C_CKSUM Register (Address = 0x7E) [Reset = 0x00]</a>

### 7.5.1.1 PAGE\_CFG Register (Address = 0x0) [Reset = 0x00]

PAGE\_CFG is shown in [表 7-28](#).

Return to the [Summary Table](#).

The device memory map is divided into pages. This register sets the page.

**表 7-28. PAGE\_CFG Register Field Descriptions**

Bit	Field	Type	Reset	Description
7-0	PAGE[7:0]	R/W	00000000b	These bits set the device page. 0d = Page 0 1d = Page 1 2d to 254d = Page 2 to page 254 respectively 255d = Page 255

### 7.5.1.2 SW\_RESET Register (Address = 0x1) [Reset = 0x00]

SW\_RESET is shown in [表 7-29](#).

Return to the [Summary Table](#).

This register is the software reset register. Asserting a software reset places all register values in their default power-on-reset (POR) state.

**表 7-29. SW\_RESET Register Field Descriptions**

Bit	Field	Type	Reset	Description
7-1	RESERVED	R	0000000b	Reserved bits; Write only reset value
0	SW_RESET	R/W	0b	Software reset. This bit is self clearing. 0d = Do not reset 1d = Reset all registers to their reset values

### 7.5.1.3 VREF\_CFG Register (Address = 0x2) [Reset = 0x00]

VREF\_CFG is shown in [表 7-30](#).

Return to the [Summary Table](#).

**表 7-30. VREF\_CFG Register Field Descriptions**

Bit	Field	Type	Reset	Description
7-6	RESERVED	R/W	00b	Reserved bits; Write only reset values
5-4	VREF_QCHG[1:0]	R/W	00b	The duration of the quick-charge for the VREF external capacitor is set using an internal series impedance of 200 Ω. 0d = VREF quick-charge duration of 3.5 ms (typical) 1d = VREF quick-charge duration of 10 ms (typical) 2d = VREF quick-charge duration of 50 ms (typical) 3d = VREF quick-charge duration of 100 ms (typical)
3	SLEEP_EXIT_VREF_EN	R/W	0b	Sleep mode exit configuration 0d = Only DREG Enabled 1d = DREG and VREF enabled
2	AVDD_MODE	R/W	0b	AVDD mode configuration. 0d = Internal AREG regulator is used (Should be used for AVDD > 2V) 1d = AVDD 1.8V used directly for AREG (Strictly use this setting for AVDD 1.7V-1.9V)
1	IOVDD_IO_MODE	R/W	0b	IOVDD mode configuration. 0d = IOVDD at 3.3V / 1.8V / 1.2V (speed limitation applicable for 1.8V and 1.2V) 1d = IOVDD at 1.8V / 1.2V only (no speed limitation - Strictly don't use this setting for IOVDD > 2V).
0	SLEEP_ENZ	R/W	0b	Sleep mode setting. 0d = Device is in sleep mode 1d = Device is not in sleep mode

#### 7.5.1.4 AVDD\_IOVDD\_STS Register (Address = 0x3) [Reset = 0x00]

AVDD\_IOVDD\_STS is shown in 表 7-31.

Return to the [Summary Table](#).

表 7-31. AVDD\_IOVDD\_STS Register Field Descriptions

Bit	Field	Type	Reset	Description
7	AVDD_MODE_STS	R	0b	AVDD mode status flag register. 0d = AVDD_MODE as per configured 1d = AVDD > 2V (AVDD_MODE forced to 0d)
6	IOVDD_IO_MODE_STS	R	0b	IOVDD mode status flag register. 0d = IOVDD_MODE as per configured 1d = IOVDD > 2V (IOVDD_IO_MODE forced to 0d)
5-2	RESERVED	R	0000b	Reserved bits; Write only reset values
1	BRWNOUT_SHDN_STS	R	0b	Brwnout shutdown status 0d = No brwnout shutdown 1d = Brwnout shutdown
0	BRWNOUT_SHDN_EXIT_SLEEP	R/W	0b	Brwnout shutdown sleep exit config 0d = Stay in sleep mode 1d = Exit sleep mode

#### 7.5.1.5 MISC\_CFG Register (Address = 0x4) [Reset = 0x00]

MISC\_CFG is shown in 表 7-32.

Return to the [Summary Table](#).

表 7-32. MISC\_CFG Register Field Descriptions

Bit	Field	Type	Reset	Description
7	RESERVED	R/W	0b	Reserved bit; Write only reset value
6	IGNORE_CLK_ERR	R/W	0b	Clock error detection action 0b = Shutdown on Clock error 1b = Ignore Clock error
5	RESERVED	R/W	0b	Reserved bit; Write only reset value
4	RESERVED	R/W	0b	Reserved bit; Write only reset value
3	RESERVED	R/W	0b	Reserved bit; Write only reset value
2	RESERVED	R/W	0b	Reserved bit; Write only reset value
1	I2C_BRDCAST_EN	R/W	0b	I <sup>2</sup> C broadcast addressing setting. 0d = I <sup>2</sup> C broadcast mode disabled 1d = I <sup>2</sup> C broadcast mode enabled; the I <sup>2</sup> C target address is fixed with pin-controlled LSB bits as '0'
0	RESERVED	R/W	0b	Reserved bit; Write only reset value

#### 7.5.1.6 MISC\_CFG1 Register (Address = 0x5) [Reset = 0x15]

MISC\_CFG1 is shown in 表 7-33.

Return to the [Summary Table](#).

表 7-33. MISC\_CFG1 Register Field Descriptions

Bit	Field	Type	Reset	Description
7-6	INCAP_QCHG[1:0]	R/W	00b	The duration of the quick-charge for the external AC-coupling capacitor is set using an internal series impedance of 800 Ω. 0d = INxP, INxM quick-charge duration of 2.5 ms (typical) 1d = INxP, INxM quick-charge duration of 12.5 ms (typical) 2d = INxP, INxM quick-charge duration of 25 ms (typical) 3d = INxP, INxM quick-charge duration of 50 ms (typical)

表 7-33. MISC\_CFG1 Register Field Descriptions (続き)

Bit	Field	Type	Reset	Description
5-4	SHDN_CFG[1:0]	R/W	01b	Shutdown configuration. 0d = DREG is powered down immediately after IOVDD is deasserted 1d = DREG remains active to enable a clean shut down until a time-out(DREG_KA_TIME) is reached; after the time-out period, DREG is forced to power off 2d = DREG remains active until the device cleanly shuts down 3d = Reserved; Don't use
3-2	DREG_KA_TIME[1:0]	R/W	01b	These bits set how long DREG remains active after IOVDD is deasserted. 0d = DREG remains active for 30 ms (typical) 1d = DREG remains active for 25 ms (typical) 2d = DREG remains active for 10 ms (typical) 3d = DREG remains active for 5 ms (typical)
1-0	RESERVED	R/W	01b	Reserved bits; Write only reset values

### 7.5.1.7 DAC\_CFG\_A0 Register (Address = 0x6) [Reset = 0x55]

DAC\_CFG\_A0 is shown in 表 7-34.

Return to the [Summary Table](#).

This register configures the device DAC DEPOP

表 7-34. DAC\_CFG\_A0 Register Field Descriptions

Bit	Field	Type	Reset	Description
7-4	RSERIES_DE_POP[3:0]	R/W	0101b	HP Amp series resistor select config. 0d = Open 1d = 1K 2d = 2.5K 3d = 0.715k 4d = 10K 5d = 0.91k 6d = 2K 7d = 0.667k 8d = 20K Dont use Dont use Dont use Dont use Dont use Dont use Dont use
3-0	PWR_UP_TIME_DE_PO P[3:0]	R/W	0101b	HP Amp external cap charging time config. 0d = 2ms 1d = 4ms 2d = 8ms 3d = 16ms 4d = 50ms 5d = 100ms 6d = 250ms 7d = 500ms 8d = 1s 9d = 5s 10d-15d = Reserved

### 7.5.1.8 MISC\_CFG0 Register (Address = 0x7) [Reset = 0x00]

MISC\_CFG0 is shown in 表 7-35.

Return to the [Summary Table](#).

This register configures the device Misc.

**表 7-35. MISC\_CFG0 Register Field Descriptions**

Bit	Field	Type	Reset	Description
7	DAC_ST_W_CAP_DIS	R/W	0b	DAC start with dc blocking capacitor discharge sequence. 0d = disable 1d = enable
6	DAC_DLYD_PWRUP	R/W	0b	DAC power up delayed config. 0d = disable 1d = enable (Delay power-up by based on DAC_DLYD_PWRUP_TIME config)
5	DAC_DLYD_PWRUP_TIME	R/W	0b	DAC power up delayed time config. 0d = 128ms 1d = 512ms
4	HW_RESET_ON_CLK_S TOP_EN	R/W	0b	Assertion of Hard Reset when clock selected by CLK_SRC_SEL is not available for 2ms config 0d = disable 1d = enable
3-0	RESERVED	R	0000b	Reserved bits; Write only reset values

#### 7.5.1.9 GPIO1\_CFG0 Register (Address = 0xA) [Reset = 0x32]

GPIO1\_CFG0 is shown in [表 7-36](#).

Return to the [Summary Table](#).

This register is the GPIO1 configuration register 0.

**表 7-36. GPIO1\_CFG0 Register Field Descriptions**

Bit	Field	Type	Reset	Description
7-4	GPIO1_CFG[3:0]	R/W	0011b	GPIO1 configuration. 0d = GPIO1 is disabled 1d = GPIO1 is configured as a general-purpose input (GPI) or any other input function 2d = GPIO1 is configured as a general-purpose output (GPO) 3d = GPIO1 is configured as a chip interrupt output (IRQ) 4d = GPIO1 is configured as a PDM clock output (PDMCLK) 5d = GPIO1 is configured as primary ASI DOUT 6d = GPIO1 is configured as primary ASI DOUT2 7d = GPIO1 is configured as secondary ASI DOUT 8d = GPIO1 is configured as secondary ASI DOUT2 9d = GPIO1 is configured as secondary ASI BCLK output 10d = GPIO1 is configured as secondary ASI FSYNC output 11d = GPIO1 is configured as general purpose CLKOUT 12d = GPIO1 is configured as PASI DOUT and SASI DOUT muxed 13d = GPIO1 is configured as DAISY_OUT for DIN Daisy 14d to 15d = Reserved
3	RESERVED	R	0b	Reserved bit; Write only reset value
2-0	GPIO1_DRV[2:0]	R/W	010b	GPIO1 output drive configuration. (Not valid if GPIO1_CFG configured as I <sup>2</sup> S out) 0d = Hi-Z output 1d = Drive active low and active high 2d = Drive active low and weak high 3d = Drive active low and Hi-Z 4d = Drive weak low and active high 5d = Drive Hi-Z and active high 6d to 7d = Reserved; Don't use



### 7.5.1.10 GPIO2\_CFG0 Register (Address = 0xB) [Reset = 0x00]

GPIO2\_CFG0 is shown in [表 7-37](#).

Return to the [Summary Table](#).

This register is the GPIO2 configuration register 0.

**表 7-37. GPIO2\_CFG0 Register Field Descriptions**

Bit	Field	Type	Reset	Description
7-4	GPIO2_CFG[3:0]	R/W	0000b	GPIO2 configuration. 0d = GPIO2 is disabled 1d = GPIO2 is configured as a general-purpose input (GPI) or any other input function 2d = GPIO2 is configured as a general-purpose output (GPO) 3d = GPIO2 is configured as a chip interrupt output (IRQ) 4d = GPIO2 is configured as a PDM clock output (PDMCLK) 5d = GPIO2 is configured as primary ASI DOUT 6d = GPIO2 is configured as primary ASI DOUT2 7d = GPIO2 is configured as secondary ASI DOUT 8d = GPIO2 is configured as secondary ASI DOUT2 9d = GPIO2 is configured as secondary ASI BCLK output 10d = GPIO2 is configured as secondary ASI FSYNC output 11d = GPIO2 is configured as general purpose CLKOUT 12d = GPIO2 is configured as PASI DOUT and SASI DOUT muxed 13d = GPIO2 is configured as DAISY_OUT for DIN Daisy 14d to 15d = Reserved
3	RESERVED	R	0b	Reserved bit; Write only reset value
2-0	GPIO2_DRV[2:0]	R/W	000b	GPIO2 output drive configuration. (Not valid if GPIO2_CFG configured as I <sup>2</sup> S out) 0d = Hi-Z output 1d = Drive active low and active high 2d = Drive active low and weak high 3d = Drive active low and Hi-Z 4d = Drive weak low and active high 5d = Drive Hi-Z and active high 6d to 7d = Reserved; Don't use

### 7.5.1.11 GPO1\_CFG0 Register (Address = 0xC) [Reset = 0x00]

GPO1\_CFG0 is shown in [表 7-38](#).

Return to the [Summary Table](#).

This register is the GPO1 configuration register 0.

**表 7-38. GPO1\_CFG0 Register Field Descriptions**

Bit	Field	Type	Reset	Description
7-4	GPO1_CFG[3:0]	R/W	0000b	GPO1 configuration. (For SPI mode, this pin act as DO and the below configuration settings are not applicable) 0d = GPO1 is disabled 1d = Reserved 2d = GPO1 is configured as a general-purpose output (GPO) 3d = GPO1 is configured as a chip interrupt output (IRQ) 4d = GPO1 is configured as a PDM clock output (PDMCLK) 5d = GPO1 is configured as primary ASI DOUT 6d = GPO1 is configured as primary ASI DOUT2 7d = GPO1 is configured as secondary ASI DOUT 8d = GPO1 is configured as secondary ASI DOUT2 9d = GPO1 is configured as secondary ASI BCLK output 10d = GPO1 is configured as secondary ASI FSYNC output 11d = GPO1 is configured as general purpose CLKOUT 12d = GPO1 is configured as PASI DOUT and SASI DOUT muxed 13d = GPO1 is configured as DAISY_OUT for DIN Daisy 14d to 15d = Reserved
3	RESERVED	R/W	0b	Reserved bit; Write only reset value
2-0	GPO1_DRV[2:0]	R/W	000b	GPO1 output drive configuration. (Not valid if GPO1_CFG configured as I <sup>2</sup> S out) 0d = Hi-Z output 1d = Drive active low and active high 2d = Drive active low and weak high 3d = Drive active low and Hi-Z 4d = Drive weak low and active high 5d = Drive Hi-Z and active high 6d to 7d = Reserved; Don't use

**7.5.1.12 GPI\_CFG Register (Address = 0xD) [Reset = 0x00]**

GPI\_CFG is shown in [表 7-39](#).

Return to the [Summary Table](#).

This register is the GPI1 configuration register 0.

**表 7-39. GPI\_CFG Register Field Descriptions**

Bit	Field	Type	Reset	Description
7-2	RESERVED	R	000000b	Reserved bits; Write only reset values
1	GPI1_CFG	R/W	0b	GPI1 configuration.(For SPI mode, this pin act as CSZ and the below configuration settings are not applicable) 0d = GPI1 is disabled 1d = GPI1 is configured as a general-purpose input (GPI) or any other input function
0	RESERVED	R/W	0b	Reserved bit; Write only reset value

**7.5.1.13 GPO\_GPI\_VAL Register (Address = 0xE) [Reset = 0x00]**

GPO\_GPI\_VAL is shown in [表 7-40](#).

Return to the [Summary Table](#).

This register is the GPIO and GPO output value register.

**表 7-40. GPO\_GPI\_VAL Register Field Descriptions**

Bit	Field	Type	Reset	Description
7	GPIO1_VAL	R/W	0b	GPIO1 output value when configured as a GPO. 0d = Drive the output with a value of 0 1d = Drive the output with a value of 1

表 7-40. GPO\_GPI\_VAL Register Field Descriptions (続き)

Bit	Field	Type	Reset	Description
6	GPIO2_VAL	R/W	0b	GPIO2 output value when configured as a GPO. 0d = Drive the output with a value of 0 1d = Drive the output with a value of 1
5	GPO1_VAL	R/W	0b	GPO1 output value when configured as a GPO. 0d = Drive the output with a value of 0 1d = Drive the output with a value of 1
4	RESERVED	R	0b	Reserved bit; Write only reset value
3	GPIO1_MON	R	0b	GPIO1 monitor value when configured as a GPI. 0d = Input monitor value 0 1d = Input monitor value 1
2	GPIO2_MON	R	0b	GPIO2 monitor value when configured as a GPI. 0d = Input monitor value 0 1d = Input monitor value 1
1	GPI1_MON	R	0b	GPI1 monitor value when configured as a GPI. 0d = Input monitor value 0 1d = Input monitor value 1
0	RESERVED	R	0b	Reserved bit; Write only reset value

#### 7.5.1.14 INTF\_CFG0 Register (Address = 0xF) [Reset = 0x00]

INTF\_CFG0 is shown in 表 7-41.

Return to the [Summary Table](#).

This register is the interface configuration register 0.

表 7-41. INTF\_CFG0 Register Field Descriptions

Bit	Field	Type	Reset	Description
7	RESERVED	R	0b	Reserved bit; Write only reset value
6-5	CCLK_SEL[1:0]	R/W	00b	CCLK select configuration. 0d = CCLK is disabled 1d = GPIO1 2d = GPIO2 3d = GPI1
4-2	PASI_DIN2_SEL[2:0]	R/W	000b	Primary ASI DIN2 select configuration. 0d = Primary ASI DIN2 is disabled 1d = GPIO1 2d = GPIO2 3d = GPI1 4d = DOUT 5d = Primary ASI DIN 6d to 7d = Reserved
1	PASI_BCLK_SEL	R/W	0b	Primary ASI BCLK select configuration. 0d = Primary ASI BCLK is BCLK 1d = Primary ASI BCLK is Secondary ASI BCLK
0	PASI_FSYNC_SEL	R/W	0b	Primary ASI FSYNC select configuration. 0d = Primary ASI FSYNC is FSYNC 1d = Primary ASI FSYNC is Secondary ASI FSYNC

#### 7.5.1.15 INTF\_CFG1 Register (Address = 0x10) [Reset = 0x52]

INTF\_CFG1 is shown in 表 7-42.

Return to the [Summary Table](#).

This register is the interface configuration register 1.

表 7-42. INTF\_CFG1 Register Field Descriptions

Bit	Field	Type	Reset	Description
7-4	DOUT_SEL[3:0]	R/W	0101b	DOUT select configuration. 0d = DOUT is disabled 1d = DOUT is configured as input 2d = DOUT is configured as a general-purpose output (GPO) 3d = DOUT is configured as a chip interrupt output (IRQ) 4d = DOUT is configured as a PDM clock output (PDMCLK) 5d = DOUT is configured as primary ASI DOUT 6d = DOUT is configured as primary ASI DOUT2 7d = DOUT is configured as secondary ASI DOUT 8d = DOUT is configured as secondary ASI DOUT2 9d = DOUT is configured as secondary ASI BCLK output 10d = DOUT is configured as secondary ASI FSYNC output 11d = DOUT is configured as general purpose CLKOUT 12d = DOUT is configured as PASI DOUT and SASI DOUT muxed 13d = DOUT is configured as DAISY_OUT for DIN Daisy 14d = DOUT is configured as DIN(LOOPBACK) 15d = Reserved
3	DOUT_VAL	R/W	0b	DOUT output value when configured as a GPO. 0d = Drive the output with a value of 0 1d = Drive the output with a value of 1
2-0	DOUT_DRV[2:0]	R/W	010b	DOUT output drive configuration. 0d = Hi-Z output 1d = Drive active low and active high 2d = Drive active low and weak high 3d = Drive active low and Hi-Z 4d = Drive weak low and active high 5d = Drive Hi-Z and active high 6d to 7d = Reserved; Don't use

7.5.1.16 INTF\_CFG2 Register (Address = 0x11) [Reset = 0x80]

INTF\_CFG2 is shown in 表 7-43.

Return to the [Summary Table](#).

This register is the interface configuration register 2.

表 7-43. INTF\_CFG2 Register Field Descriptions

Bit	Field	Type	Reset	Description
7	PASI_DIN_EN	R/W	1b	Primary ASI DIN enable configuration. 0d = Primary ASI DIN is disabled 1d = Primary ASI DIN is enabled
6-4	SASI_FSYNC_SEL[2:0]	R/W	000b	Secondary ASI FSYNC select configuration. 0d = Secondary ASI disabled 1d = GPIO1 2d = GPIO2 3d = GPI1 4d = Reserved 5d = Primary ASI FSYNC 6d to 7d = Reserved
3-1	SASI_BCLK_SEL[2:0]	R/W	000b	Secondary ASI BCLK select configuration. 0d = Secondary ASI disabled 1d = GPIO1 2d = GPIO2 3d = GPI1 4d = Reserved 5d = Primary ASI BCLK 6d to 7d = Reserved
0	RESERVED	R	0b	Reserved bit; Write only reset value

### 7.5.1.17 INTF\_CFG3 Register (Address = 0x12) [Reset = 0x00]

INTF\_CFG3 is shown in 表 7-44.

Return to the [Summary Table](#).

This register is the interface configuration register 3.

表 7-44. INTF\_CFG3 Register Field Descriptions

Bit	Field	Type	Reset	Description
7-5	SASI_DIN_SEL[2:0]	R/W	000b	Secondary ASI DIN select configuration. 0d = Secondary ASI DIN is disabled 1d = GPIO1 2d = GPIO2 3d = GPI1 4d = DOUT 5d = Primary ASI DIN 6d to 7d = Reserved
4-2	SASI_DIN2_SEL[2:0]	R/W	000b	Secondary ASI DIN2 select configuration. 0d = Secondary ASI DIN2 is disabled 1d = GPIO1 2d = GPIO2 3d = GPI1 4d = DOUT 5d = Primary ASI DIN 6d to 7d = Reserved
1-0	RESERVED	R	00b	Reserved bits; Write only reset values

### 7.5.1.18 INTF\_CFG5 Register (Address = 0x14) [Reset = 0x00]

INTF\_CFG5 is shown in 表 7-45.

Return to the [Summary Table](#).

This register is the interface configuration register 4.

表 7-45. INTF\_CFG5 Register Field Descriptions

Bit	Field	Type	Reset	Description
7	RESERVED	R/W	0b	Reserved bit; Write only reset value
6	RESERVED	R/W	0b	Reserved bit; Write only reset value
5-4	RESERVED	R/W	00b	Reserved bits; Write only reset values
3-2	PD_DAC_GPIO[1:0]	R/W	00b	Power down DAC using GPIO select configuration.(DAC powered down if any one of the PD_DAC_GPIO/DAC_PDZ is configured power down) 0d = Power down DAC using GPIO is disabled 1d = Power down DAC using GPIO1 2d = Power down DAC using GPIO2 3d = Power down DAC using GPI1
1	PLIM_GPIO	R/W	0b	PLIM using GPIO1 configuration. 0d = PLIM using GPIO1 is disabled 1d = PLIM using GPIO1
0	GPA_GPIO	R/W	0b	GPA using GPIO1 configuration. 0d = GPA using GPIO1 is disabled 1d = GPA using GPIO1

### 7.5.1.19 ASI\_CFG0 Register (Address = 0x18) [Reset = 0x40]

ASI\_CFG0 is shown in 表 7-46.

Return to the [Summary Table](#).

This register is the ASI configuration register 0.

**表 7-46. ASI\_CFG0 Register Field Descriptions**

Bit	Field	Type	Reset	Description
7	PASI_DIS	R/W	0b	Disable or enable primary ASI (PASI). 0d = Primary ASI enabled 1d = Primary ASI disabled
6	SASI_DIS	R/W	1b	Disable or enable secondary ASI (SASI). 0d = Secondary ASI enabled 1d = Secondary ASI disabled
5	SASI_CFG_GANG	R/W	0b	All configurations of secondary ASI ganged with primary ASI. 0d = Secondary ASI has independent configurations 1d = Secondary ASI configurations same as primary ASI
4-3	DAISY_EN[1:0]	R/W	00b	Daisy chain feature enable (only 1 ASI with 1 DOUT AND DIN available) 0d = Daisy chain disabled 1d = PASI daisy chain enabled (Secondary ASI not available) 2d = SASI daisy chain enabled (Primary ASI not available) 3d = Reserved; Don't use
2-0	DAISY_IN_SEL[2:0]	R/W	000b	Daisy input select configuration. 0d = Daisy input disabled 1d = GPIO1 2d = GPIO2 3d = GPI1 4d = Reserved 5d = DIN 6d to 7d = Reserved

**7.5.1.20 ASI\_CFG1 Register (Address = 0x19) [Reset = 0x00]**

ASI\_CFG1 is shown in [表 7-47](#).

Return to the [Summary Table](#).

This register is the ASI configuration register 1.

**表 7-47. ASI\_CFG1 Register Field Descriptions**

Bit	Field	Type	Reset	Description
7-6	ASI_DOUT_CFG[1:0]	R/W	00b	ASI data output configuration. 0d = 1 data output for Primary ASI and 1 data output for Secondary ASI 1d = 2 data outputs for Primary ASI 2d = 2 data outputs for Secondary ASI 3d = Reserved; Don't use
5-4	ASI_DIN_CFG[1:0]	R/W	00b	ASI data input configuration. 0d = 1 data input for Primary ASI and 1 data input for Secondary ASI 1d = 2 data inputs for Primary ASI 2d = 2 data inputs for Secondary ASI 3d = Reserved; Don't use
3	DAISY_DIR	R/W	0b	Daisy direction configuration. 0d = ASI DOUT daisy 1d = ASI DIN daisy
2	RESERVED	R/W	0b	Reserved bit; Write only reset value
1	RESERVED	R/W	0b	Reserved bit; Write only reset value
0	RESERVED	R	0b	Reserved bit; Write only reset value

### 7.5.1.21 PASI\_CFG0 Register (Address = 0x1A) [Reset = 0x30]

PASI\_CFG0 is shown in 表 7-48.

Return to the [Summary Table](#).

This register is the ASI configuration register 0.

表 7-48. PASI\_CFG0 Register Field Descriptions

Bit	Field	Type	Reset	Description
7-6	PASI_FORMAT[1:0]	R/W	00b	Primary ASI protocol format. 0d = TDM mode 1d = I <sup>2</sup> S mode 2d = LJ (left-justified) mode 3d = Reserved; Don't use
5-4	PASI_WLEN[1:0]	R/W	11b	Primary ASI word or slot length. 0d = 16 bits (Recommended: This setting to be used with 10-kΩ input impedance configuration) 1d = 20 bits 2d = 24 bits 3d = 32 bits
3	PASI_FSYNC_POL	R/W	0b	ASI FSYNC polarity (for PASI protocol only). 0d = Default polarity as per standard protocol 1d = Inverted polarity with respect to standard protocol
2	PASI_BCLK_POL	R/W	0b	ASI BCLK polarity (for PASI protocol only). 0d = Default polarity as per standard protocol 1d = Inverted polarity with respect to standard protocol
1	PASI_BUS_ERR	R/W	0b	ASI bus error detection. 0d = Enable bus error detection 1d = Disable bus error detection
0	PASI_BUS_ERR_RCOV	R/W	0b	ASI bus error auto resume. 0d = Enable auto resume after bus error recovery 1d = Disable auto resume after bus error recovery and remain powered down until host configures the device

### 7.5.1.22 PASI\_TX\_CFG0 Register (Address = 0x1B) [Reset = 0x00]

PASI\_TX\_CFG0 is shown in 表 7-49.

Return to the [Summary Table](#).

This register is the PASI TX configuration register 0.

表 7-49. PASI\_TX\_CFG0 Register Field Descriptions

Bit	Field	Type	Reset	Description
7	PASI_TX_EDGE	R/W	0b	Primary ASI data output (on the primary and secondary data pin) transmit edge. 0d = Default edge as per the protocol configuration setting in PASI_BCLK_POL 1d = Inverted following edge (half cycle delay) with respect to the default edge setting
6	PASI_TX_FILL	R/W	0b	Primary ASI data output (on the primary and secondary data pin) for any unused cycles 0d = Always transmit 0 for unused cycles 1d = Always use Hi-Z for unused cycles
5	PASI_TX_LSB	R/W	0b	Primary ASI data output (on the primary and secondary data pin) for LSB transmissions. 0d = Transmit the LSB for a full cycle 1d = Transmit the LSB for the first half cycle and Hi-Z for the second half cycle

**表 7-49. PASI\_TX\_CFG0 Register Field Descriptions (続き)**

Bit	Field	Type	Reset	Description
4-3	PASI_TX_KEEPER[1:0]	R/W	00b	Primary ASI data output (on the primary and secondary data pin) bus keeper. 0d = Bus keeper is always disabled 1d = Bus keeper is always enabled 2d = Bus keeper is enabled during LSB transmissions only for one cycle 3d = Bus keeper is enabled during LSB transmissions only for one and half cycles
2	PASI_TX_USE_INT_FSYNC	R/W	0b	Primary ASI uses internal FSYNC for output data generation in Controller mode configuration as applicable. 0d = Use external FSYNC for ASI protocol data generation 1d = Use internal FSYNC for ASI protocol data generation
1	PASI_TX_USE_INT_BCLK	R/W	0b	Primary ASI uses internal BCLK for output data generation in Controller mode configuration. 0d = Use external BCLK for ASI protocol data generation 1d = Use internal BCLK for ASI protocol data generation
0	PASI_TDM_PULSE_WIDTH	R/W	0b	Primary ASI fsync pulse width in TDM format. (Valid for Controller mode) 0d = Fsync pulse is 1 bclk period wide 1d = Fsync pulse is 2 bclk period wide

**7.5.1.23 PASI\_TX\_CFG1 Register (Address = 0x1C) [Reset = 0x00]**

PASI\_TX\_CFG1 is shown in [表 7-50](#).

Return to the [Summary Table](#).

This register is the PASI TX configuration register 1.

**表 7-50. PASI\_TX\_CFG1 Register Field Descriptions**

Bit	Field	Type	Reset	Description
7-5	RESERVED	R	000b	Reserved bits; Write only reset values
4-0	PASI_TX_OFFSET[4:0]	R/W	00000b	Primary ASI output data MSB slot 0 offset (on the primary and secondary data pin). 0d = ASI data MSB location has no offset and is as per standard protocol 1d = ASI data MSB location (TDM mode is slot 0 or I <sup>2</sup> S, LJ mode is the left and right slot 0) offset of one BCLK cycle with respect to standard protocol 2d = ASI data MSB location (TDM mode is slot 0 or I <sup>2</sup> S, LJ mode is the left and right slot 0) offset of two BCLK cycles with respect to standard protocol 3d to 30d = ASI data MSB location (TDM mode is slot 0 or I <sup>2</sup> S, LJ mode is the left and right slot 0) offset assigned as per configuration 31d = ASI data MSB location (TDM mode is slot 0 or I <sup>2</sup> S, LJ mode is the left and right slot 0) offset of 31 BCLK cycles with respect to standard protocol

**7.5.1.24 PASI\_TX\_CFG2 Register (Address = 0x1D) [Reset = 0x00]**

PASI\_TX\_CFG2 is shown in [表 7-51](#).

Return to the [Summary Table](#).

This register is the PASI TX configuration register 2.



表 7-51. PASI\_TX\_CFG2 Register Field Descriptions

Bit	Field	Type	Reset	Description
7	PASI_TX_CH8_SEL	R/W	0b	Primary ASI output channel 8 select. 0d = Primary ASI channel 8 output is on DOUT 1d = Primary ASI channel 8 output is on DOUT2
6	PASI_TX_CH7_SEL	R/W	0b	Primary ASI output channel 7 select. 0d = Primary ASI channel 7 output is on DOUT 1d = Primary ASI channel 7 output is on DOUT2
5	PASI_TX_CH6_SEL	R/W	0b	Primary ASI output channel 6 select. 0d = Primary ASI channel 6 output is on DOUT 1d = Primary ASI channel 6 output is on DOUT2
4	PASI_TX_CH5_SEL	R/W	0b	Primary ASI output channel 5 select. 0d = Primary ASI channel 5 output is on DOUT 1d = Primary ASI channel 5 output is on DOUT2
3	PASI_TX_CH4_SEL	R/W	0b	Primary ASI output channel 4 select. 0d = Primary ASI channel 4 output is on DOUT 1d = Primary ASI channel 4 output is on DOUT2
2	PASI_TX_CH3_SEL	R/W	0b	Primary ASI output channel 3 select. 0d = Primary ASI channel 3 output is on DOUT 1d = Primary ASI channel 3 output is on DOUT2
1	PASI_TX_CH2_SEL	R/W	0b	Primary ASI output channel 2 select. 0d = Primary ASI channel 2 output is on DOUT 1d = Primary ASI channel 2 output is on DOUT2
0	PASI_TX_CH1_SEL	R/W	0b	Primary ASI output channel 1 select. 0d = Primary ASI channel 1 output is on DOUT 1d = Primary ASI channel 1 output is on DOUT2

#### 7.5.1.25 PASI\_TX\_CH3\_CFG Register (Address = 0x20) [Reset = 0x02]

PASI\_TX\_CH3\_CFG is shown in [表 7-52](#).

Return to the [Summary Table](#).

This register is the PASI TX Channel 3 configuration register.

表 7-52. PASI\_TX\_CH3\_CFG Register Field Descriptions

Bit	Field	Type	Reset	Description
7	RESERVED	R	0b	Reserved bit; Write only reset value
6-5	PASI_TX_CH3_CFG[1:0]	R/W	00b	Primary ASI output channel 3 configuration. 0d = Primary ASI channel 3 output is in a tri-state condition Dont use 2d = Primary ASI channel 3 output corresponds to VBAT data Dont use
4-0	PASI_TX_CH3_SLOT_NUM[4:0]	R/W	00010b	Primary ASI output channel 3 slot assignment. 0d = TDM is slot 0 or I <sup>2</sup> S, LJ is left slot 0 1d = TDM is slot 1 or I <sup>2</sup> S, LJ is left slot 1 2d to 14d = Slot assigned as per configuration 15d = TDM is slot 15 or I <sup>2</sup> S, LJ is left slot 15 16d = TDM is slot 16 or I <sup>2</sup> S, LJ is right slot 0 17d = TDM is slot 17 or I <sup>2</sup> S, LJ is right slot 1 18d to 30d = Slot assigned as per configuration 31d = TDM is slot 31 or I <sup>2</sup> S, LJ is right slot 15

#### 7.5.1.26 PASI\_TX\_CH4\_CFG Register (Address = 0x21) [Reset = 0x03]

PASI\_TX\_CH4\_CFG is shown in [表 7-53](#).

Return to the [Summary Table](#).

This register is the PASI TX Channel 4 configuration register.

**表 7-53. PASI\_TX\_CH4\_CFG Register Field Descriptions**

Bit	Field	Type	Reset	Description
7	RESERVED	R	0b	Reserved bit; Write only reset value
6-5	PASI_TX_CH4_CFG[1:0]	R/W	00b	Primary ASI output channel 4 configuration. 0d = Primary ASI channel 4 output is in a tri-state condition Dont use 2d = Primary ASI channel 4 output corresponds to TEMP data 3d = Reserved
4-0	PASI_TX_CH4_SLOT_NUM[4:0]	R/W	00011b	Primary ASI output channel 4 slot assignment. 0d = TDM is slot 0 or I <sup>2</sup> S, LJ is left slot 0 1d = TDM is slot 1 or I <sup>2</sup> S, LJ is left slot 1 2d to 14d = Slot assigned as per configuration 15d = TDM is slot 15 or I <sup>2</sup> S, LJ is left slot 15 16d = TDM is slot 16 or I <sup>2</sup> S, LJ is right slot 0 17d = TDM is slot 17 or I <sup>2</sup> S, LJ is right slot 1 18d to 30d = Slot assigned as per configuration 31d = TDM is slot 31 or I <sup>2</sup> S, LJ is right slot 15

**7.5.1.27 PASI\_TX\_CH5\_CFG Register (Address = 0x22) [Reset = 0x04]**

PASI\_TX\_CH5\_CFG is shown in [表 7-54](#).

Return to the [Summary Table](#).

This register is the PASI TX Channel 5 configuration register.

**表 7-54. PASI\_TX\_CH5\_CFG Register Field Descriptions**

Bit	Field	Type	Reset	Description
7	RESERVED	R	0b	Reserved bit; Write only reset value
6-5	PASI_TX_CH5_CFG[1:0]	R/W	00b	Primary ASI output channel 5 configuration. 0d = Primary ASI channel 5 output is in a tri-state condition 1d = Primary ASI channel 5 output corresponds to ASI Input Channel 1 loopback data 2d = Primary ASI channel 5 output corresponds to echo reference Channel 1 data 3d = Reserved
4-0	PASI_TX_CH5_SLOT_NUM[4:0]	R/W	00100b	Primary ASI output channel 5 slot assignment. 0d = TDM is slot 0 or I <sup>2</sup> S, LJ is left slot 0 1d = TDM is slot 1 or I <sup>2</sup> S, LJ is left slot 1 2d to 14d = Slot assigned as per configuration 15d = TDM is slot 15 or I <sup>2</sup> S, LJ is left slot 15 16d = TDM is slot 16 or I <sup>2</sup> S, LJ is right slot 0 17d = TDM is slot 17 or I <sup>2</sup> S, LJ is right slot 1 18d to 30d = Slot assigned as per configuration 31d = TDM is slot 31 or I <sup>2</sup> S, LJ is right slot 15

**7.5.1.28 PASI\_TX\_CH6\_CFG Register (Address = 0x23) [Reset = 0x05]**

PASI\_TX\_CH6\_CFG is shown in [表 7-55](#).

Return to the [Summary Table](#).

This register is the PASI TX Channel 6 configuration register.

**表 7-55. PASI\_TX\_CH6\_CFG Register Field Descriptions**

Bit	Field	Type	Reset	Description
7	RESERVED	R	0b	Reserved bit; Write only reset value

表 7-55. PASI\_TX\_CH6\_CFG Register Field Descriptions (続き)

Bit	Field	Type	Reset	Description
6-5	PASI_TX_CH6_CFG[1:0]	R/W	00b	Primary ASI output channel 6 configuration. 0d = Primary ASI channel 6 output is in a tri-state condition 1d = Primary ASI channel 6 output corresponds to ASI Input Channel 2 loopback data 2d = Primary ASI channel 6 output corresponds to echo reference Channel 2 data 3d = Reserved
4-0	PASI_TX_CH6_SLOT_NUM[4:0]	R/W	00101b	Primary ASI output channel 6 slot assignment. 0d = TDM is slot 0 or I <sup>2</sup> S, LJ is left slot 0 1d = TDM is slot 1 or I <sup>2</sup> S, LJ is left slot 1 2d to 14d = Slot assigned as per configuration 15d = TDM is slot 15 or I <sup>2</sup> S, LJ is left slot 15 16d = TDM is slot 16 or I <sup>2</sup> S, LJ is right slot 0 17d = TDM is slot 17 or I <sup>2</sup> S, LJ is right slot 1 18d to 30d = Slot assigned as per configuration 31d = TDM is slot 31 or I <sup>2</sup> S, LJ is right slot 15

#### 7.5.1.29 PASI\_TX\_CH7\_CFG Register (Address = 0x24) [Reset = 0x06]

PASI\_TX\_CH7\_CFG is shown in 表 7-56.

Return to the [Summary Table](#).

This register is the PASI TX Channel 7 configuration register.

表 7-56. PASI\_TX\_CH7\_CFG Register Field Descriptions

Bit	Field	Type	Reset	Description
7	RESERVED	R	0b	Reserved bit; Write only reset value
6-5	PASI_TX_CH7_CFG[1:0]	R/W	00b	Primary ASI output channel 7 configuration. 0d = Primary ASI channel 7 output is in a tri-state condition 1d = Primary ASI channel 7 output corresponds to {VBAT_WLby2, TEMP_WLby2} 2d = Primary ASI channel 7 output corresponds to {echo_ref_ch1, echo_ref_ch2} 3d = Reserved
4-0	PASI_TX_CH7_SLOT_NUM[4:0]	R/W	00110b	Primary ASI output channel 7 slot assignment. 0d = TDM is slot 0 or I <sup>2</sup> S, LJ is left slot 0 1d = TDM is slot 1 or I <sup>2</sup> S, LJ is left slot 1 2d to 14d = Slot assigned as per configuration 15d = TDM is slot 15 or I <sup>2</sup> S, LJ is left slot 15 16d = TDM is slot 16 or I <sup>2</sup> S, LJ is right slot 0 17d = TDM is slot 17 or I <sup>2</sup> S, LJ is right slot 1 18d to 30d = Slot assigned as per configuration 31d = TDM is slot 31 or I <sup>2</sup> S, LJ is right slot 15

#### 7.5.1.30 PASI\_TX\_CH8\_CFG Register (Address = 0x25) [Reset = 0x07]

PASI\_TX\_CH8\_CFG is shown in 表 7-57.

Return to the [Summary Table](#).

This register is the PASI TX Channel 8 configuration register.

表 7-57. PASI\_TX\_CH8\_CFG Register Field Descriptions

Bit	Field	Type	Reset	Description
7-6	RESERVED	R	00b	Reserved bits; Write only reset values
5	PASI_TX_CH8_CFG	R/W	0b	Primary ASI output channel 8 configuration. 0d = Primary ASI channel 8 output is in a tri-state condition 1d = Primary ASI channel 8 output corresponds to ICLA data

表 7-57. PASI\_TX\_CH8\_CFG Register Field Descriptions (続き)

Bit	Field	Type	Reset	Description
4-0	PASI_TX_CH8_SLOT_NUM[4:0]	R/W	00111b	Primary ASI output channel 8 slot assignment. 0d = TDM is slot 0 or I <sup>2</sup> S, LJ is left slot 0 1d = TDM is slot 1 or I <sup>2</sup> S, LJ is left slot 1 2d to 14d = Slot assigned as per configuration 15d = TDM is slot 15 or I <sup>2</sup> S, LJ is left slot 15 16d = TDM is slot 16 or I <sup>2</sup> S, LJ is right slot 0 17d = TDM is slot 17 or I <sup>2</sup> S, LJ is right slot 1 18d to 30d = Slot assigned as per configuration 31d = TDM is slot 31 or I <sup>2</sup> S, LJ is right slot 15

### 7.5.1.31 PASI\_RX\_CFG0 Register (Address = 0x26) [Reset = 0x00]

PASI\_RX\_CFG0 is shown in 表 7-58.

Return to the [Summary Table](#).

This register is the PASI RX configuration register 0.

表 7-58. PASI\_RX\_CFG0 Register Field Descriptions

Bit	Field	Type	Reset	Description
7	PASI_RX_EDGE	R/W	0b	Primary ASI data input (on the primary and secondary data pin) receive edge. 0d = Default edge as per the protocol configuration setting in PASI_BCLK_POL 1d = Inverted following edge (half cycle delay) with respect to the default edge setting
6	PASI_RX_USE_INT_FSYNC	R/W	0b	Primary ASI uses internal FSYNC for input data latching in Controller mode configuration as applicable. 0d = Use external FSYNC for ASI protocol data latching 1d = Use internal FSYNC for ASI protocol data latching
5	PASI_RX_USE_INT_BCLK	R/W	0b	Primary ASI uses internal BCLK for input data latching in Controller mode configuration. 0d = Use external BCLK for ASI protocol data latching 1d = Use internal BCLK for ASI protocol data latching
4-0	PASI_RX_OFFSET[4:0]	R/W	00000b	Primary ASI data input MSB slot 0 offset (on the primary and secondary data pin). 0d = ASI data MSB location has no offset and is as per standard protocol 1d = ASI data MSB location (TDM mode is slot 0 or I <sup>2</sup> S, LJ mode is the left and right slot 0) offset of one BCLK cycle with respect to standard protocol 2d = ASI data MSB location (TDM mode is slot 0 or I <sup>2</sup> S, LJ mode is the left and right slot 0) offset of two BCLK cycles with respect to standard protocol 3d to 30d = ASI data MSB location (TDM mode is slot 0 or I <sup>2</sup> S, LJ mode is the left and right slot 0) offset assigned as per configuration 31d = ASI data MSB location (TDM mode is slot 0 or I <sup>2</sup> S, LJ mode is the left and right slot 0) offset of 31 BCLK cycles with respect to standard protocol

### 7.5.1.32 PASI\_RX\_CFG1 Register (Address = 0x27) [Reset = 0x00]

PASI\_RX\_CFG1 is shown in 表 7-59.

Return to the [Summary Table](#).

This register is the PASI RX configuration register 1.

表 7-59. PASI\_RX\_CFG1 Register Field Descriptions

Bit	Field	Type	Reset	Description
7	PASI_RX_CH8_SEL	R/W	0b	Primary ASI input channel 8 select. 0d = Primary ASI channel 8 input is on DIN 1d = Primary ASI channel 8 input is on DIN2
6	PASI_RX_CH7_SEL	R/W	0b	Primary ASI input channel 7 select. 0d = Primary ASI channel 7 input is on DIN 1d = Primary ASI channel 7 input is on DIN2
5	PASI_RX_CH6_SEL	R/W	0b	Primary ASI input channel 6 select. 0d = Primary ASI channel 6 input is on DIN 1d = Primary ASI channel 6 input is on DIN2
4	PASI_RX_CH5_SEL	R/W	0b	Primary ASI input channel 5 select. 0d = Primary ASI channel 5 input is on DIN 1d = Primary ASI channel 5 input is on DIN2
3	PASI_RX_CH4_SEL	R/W	0b	Primary ASI input channel 4 select. 0d = Primary ASI channel 4 input is on DIN 1d = Primary ASI channel 4 input is on DIN2
2	PASI_RX_CH3_SEL	R/W	0b	Primary ASI input channel 3 select. 0d = Primary ASI channel 3 input is on DIN 1d = Primary ASI channel 3 input is on DIN2
1	PASI_RX_CH2_SEL	R/W	0b	Primary ASI input channel 2 select. 0d = Primary ASI channel 2 input is on DIN 1d = Primary ASI channel 2 input is on DIN2
0	PASI_RX_CH1_SEL	R/W	0b	Primary ASI input channel 1 select. 0d = Primary ASI channel 1 input is on DIN 1d = Primary ASI channel 1 input is on DIN2

### 7.5.1.33 PASI\_RX\_CH1\_CFG Register (Address = 0x28) [Reset = 0x20]

PASI\_RX\_CH1\_CFG is shown in [表 7-60](#).

Return to the [Summary Table](#).

This register is the PASI RX Channel 1 configuration register.

表 7-60. PASI\_RX\_CH1\_CFG Register Field Descriptions

Bit	Field	Type	Reset	Description
7-6	RESERVED	R	00b	Reserved bits; Write only reset values
5	PASI_RX_CH1_CFG	R/W	1b	Primary ASI input channel 1 configuration. 0d = Primary ASI channel 1 input is disabled 1d = Primary ASI channel 1 input corresponds to DAC Channel 1 data
4-0	PASI_RX_CH1_SLOT_NUM[4:0]	R/W	00000b	Primary ASI input channel 1 slot assignment. 0d = TDM is slot 0 or I <sup>2</sup> S, LJ is left slot 0 1d = TDM is slot 1 or I <sup>2</sup> S, LJ is left slot 1 2d to 14d = Slot assigned as per configuration 15d = TDM is slot 15 or I <sup>2</sup> S, LJ is left slot 15 16d = TDM is slot 16 or I <sup>2</sup> S, LJ is right slot 0 17d = TDM is slot 17 or I <sup>2</sup> S, LJ is right slot 1 18d to 30d = Slot assigned as per configuration 31d = TDM is slot 31 or I <sup>2</sup> S, LJ is right slot 15

### 7.5.1.34 PASI\_RX\_CH2\_CFG Register (Address = 0x29) [Reset = 0x21]

PASI\_RX\_CH2\_CFG is shown in [表 7-61](#).

Return to the [Summary Table](#).

This register is the PASI RX Channel 2 configuration register.

表 7-61. PASI\_RX\_CH2\_CFG Register Field Descriptions

Bit	Field	Type	Reset	Description
7-6	RESERVED	R	00b	Reserved bits; Write only reset values
5	PASI_RX_CH2_CFG	R/W	1b	Primary ASI input channel 2 configuration. 0d = Primary ASI channel 2 input is disabled 1d = Primary ASI channel 2 input corresponds to DAC Channel 2 data
4-0	PASI_RX_CH2_SLOT_NUM[4:0]	R/W	00001b	Primary ASI input channel 2 slot assignment. 0d = TDM is slot 0 or I <sup>2</sup> S, LJ is left slot 0 1d = TDM is slot 1 or I <sup>2</sup> S, LJ is left slot 1 2d to 14d = Slot assigned as per configuration 15d = TDM is slot 15 or I <sup>2</sup> S, LJ is left slot 15 16d = TDM is slot 16 or I <sup>2</sup> S, LJ is right slot 0 17d = TDM is slot 17 or I <sup>2</sup> S, LJ is right slot 1 18d to 30d = Slot assigned as per configuration 31d = TDM is slot 31 or I <sup>2</sup> S, LJ is right slot 15

### 7.5.1.35 PASI\_RX\_CH3\_CFG Register (Address = 0x2A) [Reset = 0x02]

PASI\_RX\_CH3\_CFG is shown in 表 7-62.

Return to the [Summary Table](#).

This register is the PASI RX Channel 3 configuration register.

表 7-62. PASI\_RX\_CH3\_CFG Register Field Descriptions

Bit	Field	Type	Reset	Description
7-6	RESERVED	R	00b	Reserved bits; Write only reset values
5	PASI_RX_CH3_CFG	R/W	0b	Primary ASI input channel 3 configuration. 0d = Primary ASI channel 3 input is disabled 1d = Primary ASI channel 3 input corresponds to DAC Channel 3 data
4-0	PASI_RX_CH3_SLOT_NUM[4:0]	R/W	00010b	Primary ASI input channel 3 slot assignment. 0d = TDM is slot 0 or I <sup>2</sup> S, LJ is left slot 0 1d = TDM is slot 1 or I <sup>2</sup> S, LJ is left slot 1 2d to 14d = Slot assigned as per configuration 15d = TDM is slot 15 or I <sup>2</sup> S, LJ is left slot 15 16d = TDM is slot 16 or I <sup>2</sup> S, LJ is right slot 0 17d = TDM is slot 17 or I <sup>2</sup> S, LJ is right slot 1 18d to 30d = Slot assigned as per configuration 31d = TDM is slot 31 or I <sup>2</sup> S, LJ is right slot 15

### 7.5.1.36 PASI\_RX\_CH4\_CFG Register (Address = 0x2B) [Reset = 0x03]

PASI\_RX\_CH4\_CFG is shown in 表 7-63.

Return to the [Summary Table](#).

This register is the PASI RX Channel 4 configuration register.

表 7-63. PASI\_RX\_CH4\_CFG Register Field Descriptions

Bit	Field	Type	Reset	Description
7-6	RESERVED	R	00b	Reserved bits; Write only reset values
5	PASI_RX_CH4_CFG	R/W	0b	Primary ASI input channel 4 configuration. 0d = Primary ASI channel 4 input is disabled 1d = Primary ASI channel 4 input corresponds to DAC Channel 4 data

表 7-63. PASI\_RX\_CH4\_CFG Register Field Descriptions (続き)

Bit	Field	Type	Reset	Description
4-0	PASI_RX_CH4_SLOT_NUM[4:0]	R/W	00011b	Primary ASI input channel 4 slot assignment. 0d = TDM is slot 0 or I <sup>2</sup> S, LJ is left slot 0 1d = TDM is slot 1 or I <sup>2</sup> S, LJ is left slot 1 2d to 14d = Slot assigned as per configuration 15d = TDM is slot 15 or I <sup>2</sup> S, LJ is left slot 15 16d = TDM is slot 16 or I <sup>2</sup> S, LJ is right slot 0 17d = TDM is slot 17 or I <sup>2</sup> S, LJ is right slot 1 18d to 30d = Slot assigned as per configuration 31d = TDM is slot 31 or I <sup>2</sup> S, LJ is right slot 15

### 7.5.1.37 PASI\_RX\_CH5\_CFG Register (Address = 0x2C) [Reset = 0x04]

PASI\_RX\_CH5\_CFG is shown in 表 7-64.

Return to the [Summary Table](#).

This register is the PASI RX Channel 5 configuration register.

表 7-64. PASI\_RX\_CH5\_CFG Register Field Descriptions

Bit	Field	Type	Reset	Description
7	RESERVED	R	0b	Reserved bit; Write only reset value
6-5	PASI_RX_CH5_CFG[1:0]	R/W	00b	Primary ASI input channel 5 configuration. 0d = Primary ASI channel 5 input is disabled 1d = Primary ASI channel 5 input corresponds to DAC Channel 5 data 2d = Primary ASI channel 5 input corresponds to ADC Channel 1 output loopback 3d = Reserved
4-0	PASI_RX_CH5_SLOT_NUM[4:0]	R/W	00100b	Primary ASI input channel 5 slot assignment. 0d = TDM is slot 0 or I <sup>2</sup> S, LJ is left slot 0 1d = TDM is slot 1 or I <sup>2</sup> S, LJ is left slot 1 2d to 14d = Slot assigned as per configuration 15d = TDM is slot 15 or I <sup>2</sup> S, LJ is left slot 15 16d = TDM is slot 16 or I <sup>2</sup> S, LJ is right slot 0 17d = TDM is slot 17 or I <sup>2</sup> S, LJ is right slot 1 18d to 30d = Slot assigned as per configuration 31d = TDM is slot 31 or I <sup>2</sup> S, LJ is right slot 15

### 7.5.1.38 PASI\_RX\_CH6\_CFG Register (Address = 0x2D) [Reset = 0x05]

PASI\_RX\_CH6\_CFG is shown in 表 7-65.

Return to the [Summary Table](#).

This register is the PASI RX Channel 6 configuration register.

表 7-65. PASI\_RX\_CH6\_CFG Register Field Descriptions

Bit	Field	Type	Reset	Description
7	RESERVED	R	0b	Reserved bit; Write only reset value
6-5	PASI_RX_CH6_CFG[1:0]	R/W	00b	Primary ASI input channel 6 configuration. 0d = Primary ASI channel 6 input is disabled 1d = Primary ASI channel 6 input corresponds to DAC Channel 6 data 2d = Primary ASI channel 6 input corresponds to ADC Channel 2 output loopback 3d = Primary ASI channel 6 input corresponds to ICLA device 1 data

表 7-65. PASI\_RX\_CH6\_CFG Register Field Descriptions (続き)

Bit	Field	Type	Reset	Description
4-0	PASI_RX_CH6_SLOT_NUM[4:0]	R/W	00101b	Primary ASI input channel 6 slot assignment. 0d = TDM is slot 0 or I <sup>2</sup> S, LJ is left slot 0 1d = TDM is slot 1 or I <sup>2</sup> S, LJ is left slot 1 2d to 14d = Slot assigned as per configuration 15d = TDM is slot 15 or I <sup>2</sup> S, LJ is left slot 15 16d = TDM is slot 16 or I <sup>2</sup> S, LJ is right slot 0 17d = TDM is slot 17 or I <sup>2</sup> S, LJ is right slot 1 18d to 30d = Slot assigned as per configuration 31d = TDM is slot 31 or I <sup>2</sup> S, LJ is right slot 15

### 7.5.1.39 PASI\_RX\_CH7\_CFG Register (Address = 0x2E) [Reset = 0x06]

PASI\_RX\_CH7\_CFG is shown in 表 7-66.

Return to the [Summary Table](#).

This register is the PASI RX Channel 7 configuration register.

表 7-66. PASI\_RX\_CH7\_CFG Register Field Descriptions

Bit	Field	Type	Reset	Description
7	RESERVED	R	0b	Reserved bit; Write only reset value
6-5	PASI_RX_CH7_CFG[1:0]	R/W	00b	Primary ASI input channel 7 configuration. 0d = Primary ASI channel 7 input is disabled 1d = Primary ASI channel 7 input corresponds to DAC Channel 7 data 2d = Primary ASI channel 7 input corresponds to ADC Channel 3 output loopback 3d = Primary ASI channel 7 input corresponds to ICLA device 2 data
4-0	PASI_RX_CH7_SLOT_NUM[4:0]	R/W	00110b	Primary ASI input channel 7 slot assignment. 0d = TDM is slot 0 or I <sup>2</sup> S, LJ is left slot 0 1d = TDM is slot 1 or I <sup>2</sup> S, LJ is left slot 1 2d to 14d = Slot assigned as per configuration 15d = TDM is slot 15 or I <sup>2</sup> S, LJ is left slot 15 16d = TDM is slot 16 or I <sup>2</sup> S, LJ is right slot 0 17d = TDM is slot 17 or I <sup>2</sup> S, LJ is right slot 1 18d to 30d = Slot assigned as per configuration 31d = TDM is slot 31 or I <sup>2</sup> S, LJ is right slot 15

### 7.5.1.40 PASI\_RX\_CH8\_CFG Register (Address = 0x2F) [Reset = 0x07]

PASI\_RX\_CH8\_CFG is shown in 表 7-67.

Return to the [Summary Table](#).

This register is the PASI RX Channel 8 configuration register.

表 7-67. PASI\_RX\_CH8\_CFG Register Field Descriptions

Bit	Field	Type	Reset	Description
7	RESERVED	R	0b	Reserved bit; Write only reset value
6-5	PASI_RX_CH8_CFG[1:0]	R/W	00b	Primary ASI input channel 8 configuration. 0d = Primary ASI channel 8 input is disabled 1d = Primary ASI channel 8 input corresponds to DAC Channel 8 data 2d = Primary ASI channel 8 input corresponds to ADC Channel 4 output loopback 3d = Primary ASI channel 8 input corresponds to ICLA device 3 data



表 7-67. PASI\_RX\_CH8\_CFG Register Field Descriptions (続き)

Bit	Field	Type	Reset	Description
4-0	PASI_RX_CH8_SLOT_NUM[4:0]	R/W	00111b	Primary ASI input channel 8 slot assignment. 0d = TDM is slot 0 or I <sup>2</sup> S, LJ is left slot 0 1d = TDM is slot 1 or I <sup>2</sup> S, LJ is left slot 1 2d to 14d = Slot assigned as per configuration 15d = TDM is slot 15 or I <sup>2</sup> S, LJ is left slot 15 16d = TDM is slot 16 or I <sup>2</sup> S, LJ is right slot 0 17d = TDM is slot 17 or I <sup>2</sup> S, LJ is right slot 1 18d to 30d = Slot assigned as per configuration 31d = TDM is slot 31 or I <sup>2</sup> S, LJ is right slot 15

#### 7.5.1.41 CLK\_CFG0 Register (Address = 0x32) [Reset = 0x00]

CLK\_CFG0 is shown in 表 7-68.

Return to the [Summary Table](#).

This register is the clock configuration register 0.

表 7-68. CLK\_CFG0 Register Field Descriptions

Bit	Field	Type	Reset	Description
7-2	PASI_SAMP_RATE[5:0]	R/W	000000b	Primary ASI sample rate configuration. -Typical (Allowed Range) 0d = Primary ASI sampling rate auto detected in the device 1d = 768000 (670320-791040) 2d = 614400 (536256-632832) 3d = 512000 (446880-527360) 4d = 438857 (383040-452022) 5d = 384000 (335160-395520) 6d = 341333 (297920-351573) 7d = 307200 (268128-316416) 8d = 256000 (223440-263680) 9d = 219429 (191520-226011) 10d = 192000 (167580-197760) 11d = 170667 (148960-175786) 12d = 153600 (134064-158208) 13d = 128000 (111720-131840) 14d = 109714 (95760-113005) 15d = 96000 (83790-98880) 16d = 85333 (74480-87893) 17d = 76800 (67032-79104) 18d = 64000 (55860-65920) 19d = 54857 (47880-56502) 20d = 48000 (41895-49440) 21d = 42667 (37240-43946) 22d = 38400 (33516-39552) 23d = 32000 (27930-32960) 24d = 27429 (23940-28251) 25d = 24000 (20947-24720) 26d = 21333 (18620-21973) 27d = 19200 (16758-19776) 28d = 16000 (13965-16480) 29d = 13714 (11970-14125) 30d = 12000 (10473-12360) 31d = 10667 (9310-10986) 32d = 9600 (8379-9888) 33d = 8000 (6982-8240) 34d = 6857 (5985-7062) 35d = 6000 (5236-6180) 36d = 5333 (4655-5493) 37d = 4800 (4189-4944) 38d = 4000 (3491-4120) 39d = 3429 (2992-3531) 40d = 3000 (2618-3090) 41d-63d = Reserved

表 7-68. CLK\_CFG0 Register Field Descriptions (続き)

Bit	Field	Type	Reset	Description
1	PASI_FS_RATE_NO_LIM	R/W	0b	Limit sampling rate to standard audio sample rates only. 0d = Standard audio rates with 1% tolerance supported using auto mode 1d = Standard audio rates with 5% tolerance supported using auto mode
0	CUSTOM_CLK_CFG	R/W	0b	Custom clock configuration enable, all dividers and mux selects need to be manually configured. 0d = Auto clock configuration 1d = Custom clock configuration

#### 7.5.1.42 CLK\_CFG1 Register (Address = 0x33) [Reset = 0x00]

CLK\_CFG1 is shown in [表 7-69](#).

Return to the [Summary Table](#).

This register is the clock configuration register 1.

表 7-69. CLK\_CFG1 Register Field Descriptions

Bit	Field	Type	Reset	Description
7-2	SASI_SAMP_RATE[5:0]	R/W	000000b	Secondary ASI sample rate configuration. -Typical (Range) 0d = Secondary ASI sampling rate auto detected in the device 1d = 768000 (670320-791040) 2d = 614400 (536256-632832) 3d = 512000 (446880-527360) 4d = 438857 (383040-452022) 5d = 384000 (335160-395520) 6d = 341333 (297920-351573) 7d = 307200 (268128-316416) 8d = 256000 (223440-263680) 9d = 219429 (191520-226011) 10d = 192000 (167580-197760) 11d = 170667 (148960-175786) 12d = 153600 (134064-158208) 13d = 128000 (111720-131840) 14d = 109714 (95760-113005) 15d = 96000 (83790-98880) 16d = 85333 (74480-87893) 17d = 76800 (67032-79104) 18d = 64000 (55860-65920) 19d = 54857 (47880-56502) 20d = 48000 (41895-49440) 21d = 42667 (37240-43946) 22d = 38400 (33516-39552) 23d = 32000 (27930-32960) 24d = 27429 (23940-28251) 25d = 24000 (20947-24720) 26d = 21333 (18620-21973) 27d = 19200 (16758-19776) 28d = 16000 (13965-16480) 29d = 13714 (11970-14125) 30d = 12000 (10473-12360) 31d = 10667 (9310-10986) 32d = 9600 (8379-9888) 33d = 8000 (6982-8240) 34d = 6857 (5985-7062) 35d = 6000 (5236-6180) 36d = 5333 (4655-5493) 37d = 4800 (4189-4944) 38d = 4000 (3491-4120) 39d = 3429 (2992-3531) 40d = 3000 (2618-3090) 41d-63d = Reserved
1	SASI_FS_RATE_NO_LIM	R/W	0b	Limit sampling rate to standard audio sample rates only. 0d = Standard audio rates with 1% tolerance supported using auto mode 1d = Standard audio rates with 5% tolerance supported using auto mode
0	RESERVED	R	0b	Reserved bit; Write only reset value

### 7.5.1.43 CLK\_CFG2 Register (Address = 0x34) [Reset = 0x40]

CLK\_CFG2 is shown in 表 7-70.

Return to the [Summary Table](#).

This register is the clock configuration register 2.

**表 7-70. CLK\_CFG2 Register Field Descriptions**

Bit	Field	Type	Reset	Description
7	PLL_DIS	R/W	0b	Custom/Auto clock mode PLL setting. 0d = PLL is always enabled in custom clk mode/PLL is enabled based on DSP MIPS requirement in auto clock mode 1d = PLL is disabled
6	AUTO_PLL_FR_ALLOW	R/W	1b	Allow the PLL to operate in fractional mode of operation. 0d = PLL fractional mode disabled 1d = PLL fractional mode allowed
5	RESERVED	R/W	0b	Reserved bit; Write only reset value
4	RESERVED	R/W	0b	Reserved bit; Write only reset value
3-1	CLK_SRC_SEL[2:0]	R/W	000b	Input clock source select. 0d = Primary ASI BCLK is the input clock source 1d = CCLK synchronized with Primary ASI FSYNC is the input clock source 2d = Secondary ASI BCLK is the input clock source 3d = CCLK synchronized with Secondary ASI FSYNC is the input clock source 4d = Fixed CCLK frequency (used only in controller mode configuration) 5d = Internal oscillator clock is the input clock source 6d to 7d = Reserved
0	RATIO_CLK_EDGE	R/W	0b	Edge selection for clock source ratio detection. 0d = Use rising edge of clock source to check ratio with primary or secondary FSYNC 1d = Use falling edge of clock source to check ratio with primary or secondary FSYNC

**7.5.1.44 CNT\_CLK\_CFG0 Register (Address = 0x35) [Reset = 0x00]**

CNT\_CLK\_CFG0 is shown in [表 7-71](#).

Return to the [Summary Table](#).

This register is the controller mode clock configuration register 0.

**表 7-71. CNT\_CLK\_CFG0 Register Field Descriptions**

Bit	Field	Type	Reset	Description
7-6	RESERVED	R/W	00b	Reserved bits; Write only reset values
5-0	CCLK_FS_RATIO_MSB[5:0]	R/W	000000b	Most significant bits for selecting the ratio between CCLK and primary/secondary ASI FSYNC with which CCLK is synchronized. 0d = Auto detect the ratio (assumption is CCLK is synchronized with primary/secondary FSYNC) 1d to 16383d = Ratio as per configuration

**7.5.1.45 CNT\_CLK\_CFG1 Register (Address = 0x36) [Reset = 0x00]**

CNT\_CLK\_CFG1 is shown in [表 7-72](#).

Return to the [Summary Table](#).

This register is the controller mode clock configuration register 1.

表 7-72. CNT\_CLK\_CFG1 Register Field Descriptions

Bit	Field	Type	Reset	Description
7-0	CCLK_FS_RATIO_LSB[7:0]	R/W	00000000b	LSB's for selecting the ratio between CCLK and primary/secondary ASI FSYNC with which CCLK is synchronized. 0d = Auto detect the ratio (assumption is CCLK is synchronized with primary/secondary FSYNC) 1d to 16383d = Ratio as per configuration

#### 7.5.1.46 CNT\_CLK\_CFG2 Register (Address = 0x37) [Reset = 0x20]

CNT\_CLK\_CFG2 is shown in 表 7-73.

Return to the [Summary Table](#).

This register is the controller mode clock configuration register 2.

表 7-73. CNT\_CLK\_CFG2 Register Field Descriptions

Bit	Field	Type	Reset	Description
7-5	CCLK_FREQ_SEL[2:0]	R/W	001b	These bits select the CCLK input frequency (used only in controller mode configuration). 0d = 12 MHz 1d = 12.288 MHz 2d = 13 MHz 3d = 16 MHz 4d = 19.2 MHz 5d = 19.68 MHz 6d = 24 MHz 7d = 24.576 MHz
4	PASI_CNT_CFG	R/W	0b	Primary ASI controller or target configuration 0d = Primary ASI in target configuration 1d = Primary ASI in controller configuration
3	SASI_CNT_CFG	R/W	0b	Secondary ASI controller or target configuration 0d = Secondary ASI in target configuration 1d = Secondary ASI in controller configuration
2	RESERVED	R/W	0b	Reserved bit; Write only reset value
1	RESERVED	R/W	0b	Reserved bit; Write only reset value
0	FS_MODE	R/W	0b	Sample rate setting (valid when the device is in controller mode). This is applicable for both PASI and SASI. 0d = sampling rate is a multiple (or submultiple) of 48 kHz 1d = sampling rate is a multiple (or submultiple) of 44.1 kHz

#### 7.5.1.47 CNT\_CLK\_CFG3 Register (Address = 0x38) [Reset = 0x00]

CNT\_CLK\_CFG3 is shown in 表 7-74.

Return to the [Summary Table](#).

This register is the controller mode clock configuration register 3.

表 7-74. CNT\_CLK\_CFG3 Register Field Descriptions

Bit	Field	Type	Reset	Description
7	PASI_USE_INT_BCLK_F OR_FSYNC	R/W	0b	Use internal BCLK for FSYNC generation in PASI during controller mode configuration. 0d = Use external BCLK for FSYNC generation 1d = Use internal BCLK for FSYNC generation
6	PASI_INV_BCLK_FOR_F SYNC	R/W	0b	Invert PASI BCLK polarity only for PASI FSYNC generation in controller mode configuration. 0d = Do not invert PASI BCLK polarity for PASI FSYNC generation 1d = Invert PASI BCLK polarity for PASI FSYNC generation

**表 7-74. CNT\_CLK\_CFG3 Register Field Descriptions (続き)**

Bit	Field	Type	Reset	Description
5-0	PASI_BCLK_FS_RATIO_MSB[5:0]	R/W	000000b	MSB bits for primary ASI BCLK to FSYNC ratio in controller mode.

**7.5.1.48 CNT\_CLK\_CFG4 Register (Address = 0x39) [Reset = 0x00]**

CNT\_CLK\_CFG4 is shown in [表 7-75](#).

Return to the [Summary Table](#).

This register is the controller mode clock configuration register 4.

**表 7-75. CNT\_CLK\_CFG4 Register Field Descriptions**

Bit	Field	Type	Reset	Description
7-0	PASI_BCLK_FS_RATIO_LSB[7:0]	R/W	00000000b	LSB byte for primary ASI BCLK to FSYNC ratio in controller mode.

**7.5.1.49 CNT\_CLK\_CFG5 Register (Address = 0x3A) [Reset = 0x00]**

CNT\_CLK\_CFG5 is shown in [表 7-76](#).

Return to the [Summary Table](#).

This register is the controller mode clock configuration register 5.

**表 7-76. CNT\_CLK\_CFG5 Register Field Descriptions**

Bit	Field	Type	Reset	Description
7	SASI_USE_INT_BCLK_FOR_FSYNC	R/W	0b	Use internal BCLK for FSYNC generation in SASI during controller mode configuration. 0d = Use external BCLK for FSYNC generation 1d = Use internal BCLK for FSYNC generation
6	SASI_INV_BCLK_FOR_FSYNC	R/W	0b	Invert SASI BCLK polarity only for SASI FSYNC generation in controller mode configuration. 0d = Do not invert SASI BCLK polarity for SASI FSYNC generation 1d = Invert SASI BCLK polarity for SASI FSYNC generation
5-0	SASI_BCLK_FS_RATIO_MSB[5:0]	R/W	000000b	MSB bits for secondary ASI BCLK to FSYNC ratio in controller mode.

**7.5.1.50 CNT\_CLK\_CFG6 Register (Address = 0x3B) [Reset = 0x00]**

CNT\_CLK\_CFG6 is shown in [表 7-77](#).

Return to the [Summary Table](#).

This register is the controller mode clock configuration register 6.

**表 7-77. CNT\_CLK\_CFG6 Register Field Descriptions**

Bit	Field	Type	Reset	Description
7-0	SASI_BCLK_FS_RATIO_LSB[7:0]	R/W	00000000b	LSB byte for secondary ASI BCLK to FSYNC ratio in controller mode.

**7.5.1.51 CLK\_ERR\_STS0 Register (Address = 0x3C) [Reset = 0x00]**

CLK\_ERR\_STS0 is shown in [表 7-78](#).

Return to the [Summary Table](#).

This register is the clock error and status register 0.

表 7-78. CLK\_ERR\_STS0 Register Field Descriptions

Bit	Field	Type	Reset	Description
7	DSP_CLK_ERR	R	0b	Flag indicating ratio error between FSYNC and selected clock source. 0d = No ratio error 1d = Ratio error between primary or secondary ASI FSYNC and selected clock source
6	RESERVED	R	0b	Reserved bit; Write only reset value
5	RESERVED	R	0b	Reserved bit; Write only reset value
4	SRC_RATIO_ERR	R	0b	Flag indicating that SRC m:n ratio is unsupported. (not valid for custom m/n ratio config). 0d = m:n ratio supported 1d = Unsupported m:n ratio error
3	DEM_RATE_ERR	R	0b	Flag indicating that clock configuration does not allow valid DEM rate. 0d = No DEM clock rate error 1d = DEM clock rate error in selected clock configuration
2	PDM_CLK_ERR	R	0b	Flag indicating that clock configuration does not allow valid PDM clock generation. 0d = No PDM clock generation error 1d = PDM clock generation error in selected clock configuration
1	RESET_ON_CLK_STOP_DET_STS	R	0b	Flag indicating that audio clock source stopped for atleast 1ms. 0d = No audio clock source error 1d = Audio clock source stopped for atleast 1ms
0	RESERVED	R	0b	Reserved bit; Write only reset value

#### 7.5.1.52 CLK\_ERR\_STS1 Register (Address = 0x3D) [Reset = 0x00]

CLK\_ERR\_STS1 is shown in 表 7-79.

Return to the [Summary Table](#).

This register is the clock error and status register 1.

表 7-79. CLK\_ERR\_STS1 Register Field Descriptions

Bit	Field	Type	Reset	Description
7	PASI_BCLK_FS_RATIO_ERR	R	0b	Flag indicating PASI bclk fsync ratio error. 0d = No PASI bclk fsync ratio error 1d = PASI bclk fsync ratio error in selected clock configuration
6	SASI_BCLK_FS_RATIO_ERR	R	0b	Flag indicating SASI bclk fsync ratio error. 0d = No SASI bclk fsync ratio error 1d = SASI bclk fsync ratio error in selected clock configuration
5	CCLK_FS_RATIO_ERR	R	0b	Flag indicating CCLK fsync ratio error. 0d = No CCLK fsync ratio error 1d = CCLK fsync ratio error
4	PASI_FS_ERR	R	0b	Flag indicating PASI FS rate change or halt error. 0d = No PASI FS error 1d = PASI FS rate change or halt detected
3	SASI_FS_ERR	R	0b	Flag indicating SASI FS rate change or halt error. 0d = No SASI FS error 1d = SASI FS rate change or halt detected
2-0	RESERVED	R	000b	Reserved bits; Write only reset values

### 7.5.1.53 CLK\_DET\_STS0 Register (Address = 0x3E) [Reset = 0x00]

CLK\_DET\_STS0 is shown in [表 7-80](#).

Return to the [Summary Table](#).

This register is the clock ratio detection register 0.

**表 7-80. CLK\_DET\_STS0 Register Field Descriptions**

Bit	Field	Type	Reset	Description
7-2	PASI_SAMP_RATE_STS[5:0]	R	000000b	Primary ASI Sample rate detected status. 0d = Reserved 1d = 768000 (670320-791040) 2d = 614400 (536256-632832) 3d = 512000 (446880-527360) 4d = 438857 (383040-452022) 5d = 384000 (335160-395520) 6d = 341333 (297920-351573) 7d = 307200 (268128-316416) 8d = 256000 (223440-263680) 9d = 219429 (191520-226011) 10d = 192000 (167580-197760) 11d = 170667 (148960-175786) 12d = 153600 (134064-158208) 13d = 128000 (111720-131840) 14d = 109714 (95760-113005) 15d = 96000 (83790-98880) 16d = 85333 (74480-87893) 17d = 76800 (67032-79104) 18d = 64000 (55860-65920) 19d = 54857 (47880-56502) 20d = 48000 (41895-49440) 21d = 42667 (37240-43946) 22d = 38400 (33516-39552) 23d = 32000 (27930-32960) 24d = 27429 (23940-28251) 25d = 24000 (20947-24720) 26d = 21333 (18620-21973) 27d = 19200 (16758-19776) 28d = 16000 (13965-16480) 29d = 13714 (11970-14125) 30d = 12000 (10473-12360) 31d = 10667 (9310-10986) 32d = 9600 (8379-9888) 33d = 8000 (6982-8240) 34d = 6857 (5985-7062) 35d = 6000 (5236-6180) 36d = 5333 (4655-5493) 37d = 4800 (4189-4944) 38d = 4000 (3491-4120) 39d = 3429 (2992-3531) 40d = 3000 (2618-3090) 41d-63d = Reserved
1-0	PLL_MODE_STS[1:0]	R	00b	PLL usage status. 0d = PLL used in integer mode 1d = PLL used in fractional mode 2d = PLL not used 3d = Reserved

### 7.5.1.54 CLK\_DET\_STS1 Register (Address = 0x3F) [Reset = 0x00]

CLK\_DET\_STS1 is shown in [表 7-81](#).

Return to the [Summary Table](#).



This register is the clock ratio detection register 1.

表 7-81. CLK\_DET\_STS1 Register Field Descriptions

Bit	Field	Type	Reset	Description
7-2	SASI_SAMP_RATE_STS[5:0]	R	000000b	Secondary ASI Sample rate detected status. 0d = Reserved 1d = 768000 (670320-791040) 2d = 614400 (536256-632832) 3d = 512000 (446880-527360) 4d = 438857 (383040-452022) 5d = 384000 (335160-395520) 6d = 341333 (297920-351573) 7d = 307200 (268128-316416) 8d = 256000 (223440-263680) 9d = 219429 (191520-226011) 10d = 192000 (167580-197760) 11d = 170667 (148960-175786) 12d = 153600 (134064-158208) 13d = 128000 (111720-131840) 14d = 109714 (95760-113005) 15d = 96000 (83790-98880) 16d = 85333 (74480-87893) 17d = 76800 (67032-79104) 18d = 64000 (55860-65920) 19d = 54857 (47880-56502) 20d = 48000 (41895-49440) 21d = 42667 (37240-43946) 22d = 38400 (33516-39552) 23d = 32000 (27930-32960) 24d = 27429 (23940-28251) 25d = 24000 (20947-24720) 26d = 21333 (18620-21973) 27d = 19200 (16758-19776) 28d = 16000 (13965-16480) 29d = 13714 (11970-14125) 30d = 12000 (10473-12360) 31d = 10667 (9310-10986) 32d = 9600 (8379-9888) 33d = 8000 (6982-8240) 34d = 6857 (5985-7062) 35d = 6000 (5236-6180) 36d = 5333 (4655-5493) 37d = 4800 (4189-4944) 38d = 4000 (3491-4120) 39d = 3429 (2992-3531) 40d = 3000 (2618-3090) 41d-63d = Reserved
1-0	RESERVED	R	00b	Reserved bits; Write only reset values

### 7.5.1.55 CLK\_DET\_STS2 Register (Address = 0x40) [Reset = 0x00]

CLK\_DET\_STS2 is shown in 表 7-82.

Return to the [Summary Table](#).

This register is the clock ratio detection register 2.

表 7-82. CLK\_DET\_STS2 Register Field Descriptions

Bit	Field	Type	Reset	Description
7-6	RESERVED	R	00b	Reserved bits; Write only reset values
5-0	FS_CLKSRC_RATIO_DE T_MSB_STS[5:0]	R	000000b	MSB bits for primary ASI or secondary ASI FSYNC to clock source ratio detected.

### 7.5.1.56 CLK\_DET\_STS3 Register (Address = 0x41) [Reset = 0x00]

CLK\_DET\_STS3 is shown in [表 7-83](#).

Return to the [Summary Table](#).

This register is the clock ratio detection register 3.

**表 7-83. CLK\_DET\_STS3 Register Field Descriptions**

Bit	Field	Type	Reset	Description
7-0	FS_CLKSRC_RATIO_DETECT_LSB_STS[7:0]	R	00000000b	LSB byte for primary ASI or secondary ASI FSYNC to clock source ratio detected.

### 7.5.1.57 INT\_CFG Register (Address = 0x42) [Reset = 0x00]

INT\_CFG is shown in [表 7-84](#).

Return to the [Summary Table](#).

This register is the interrupt configuration register.

**表 7-84. INT\_CFG Register Field Descriptions**

Bit	Field	Type	Reset	Description
7	INT_POL	R/W	0b	Interrupt polarity. 0b = Active low (IRQZ) 1b = Active high (IRQ)
6-5	INT_EVENT[1:0]	R/W	00b	Interrupt event configuration. 0d = INT asserts on any unmasked latched interrupts event 1d = INT asserts on any unmasked live interrupts event 2d = INT asserts for 2 ms (typical) for every 4-ms (typical) duration on any unmasked latched interrupts event 3d = INT asserts for 2 ms (typical) one time on each pulse for any unmasked interrupts event
4-3	PD_ON_FLT_CFG[1:0]	R/W	00b	Powerdown configuration during fault for chx and micbias. 0d = Faults are not considered for power down 1d = Only unmasked faults are considered for power down 2d = All faults are considered for powerdown 3d = Reserved
2	LTCH_READ_CFG	R/W	0b	Interrupt latch registers readback configuration. 0b = All interrupts can be read through the LTCH registers 1b = Only unmasked interrupts can be read through the LTCH registers
1	PD_ON_FLT_RCV_CFG	R/W	0b	Configuration for Powerdown ADC channels on fault 0b = Auto recovery, ADC channels are re-powered up when fault goes away 1b = Manual recovery, ADC channels are not re-powered up when fault goes away
0	LTCH_CLR_ON_READ	R/W	0b	Cfgn for clearing LTCH register bits 0 = LTCH reg bits are cleared on reg read only if live status is zero 1 = LTCH reg bits are cleared on reg read irrespective of live status

### 7.5.1.58 DAC\_FLT\_CFG Register (Address = 0x43) [Reset = 0x50]

DAC\_FLT\_CFG is shown in [表 7-85](#).

Return to the [Summary Table](#).

This register is the interrupt configuration register.

表 7-85. DAC\_FLT\_CFG Register Field Descriptions

Bit	Field	Type	Reset	Description
7	RESERVED	R	0b	Reserved bit; Write only reset value
6-5	DAC_PD_ON_FLT_CFG[1:0]	R/W	10b	Powerdown configuration during fault for DAC . 0d = Faults are not considered for power down 1d = Only unmasked faults are considered for power down 2d = All faults are considered for powerdown 3d = Reserved
4	DAC_PD_ON_FLT_RCV_CFG	R/W	1b	Configuration for Powerdown DAC channels on fault 0b = Auto recovery, DAC channels are re-powered up when fault goes away 1b = Manual recovery, DAC channels are not re-powered up when fault goes away
3	OUT_CHx_PD_FLT_STS	R	0b	Status for PD on OUTxx faults 0d = No DAC Channel is Powered Down due to fault/s 1d = Some DAC Channel is Powered Down due to fault/s
2	DAC_DIS_PD_W_PU	R/W	0b	Disable power down on DRVR VG fault while powering up DAC 0b = Power down DAC on DRVR VG fault while power up 1b = Disable power down DAC on DRVR VG fault while power up
1	DAC_FLT_DET_DIS	R/W	0b	DAC vg_fault/sc_fault detect config 0b = enable 1b = disable
0	AREG_SC_FLAG_DET_DIS	R/W	0b	AREG short circuit detect config 0b = enable 1b = disable

#### 7.5.1.59 PWR\_TUNE\_CFG1 Register (Address = 0x4F) [Reset = 0x00]

PWR\_TUNE\_CFG1 is shown in 表 7-86.

Return to the [Summary Table](#).

This register is configuration register for power tune configuration.

表 7-86. PWR\_TUNE\_CFG1 Register Field Descriptions

Bit	Field	Type	Reset	Description
7	DAC_CLK_BY2_MODE	R/W	0b	DAC MOD CLK select configuration. 0d = MOD CLK 3MHz 1d = MOD CLK 1.5MHz
6	RESERVED	R/W	0b	Reserved bit; Write only reset value
5	DAC_FIR_SEG_BYPASS	R/W	0b	DAC FIR and segmenter bypass configuration. 0d = Bypass disable 1d = Bypass enable
4-3	RESERVED	R/W	00b	Reserved bits; Write only reset values
2	DAC_LOW_PWR_FILT	R/W	0b	Low Power Filter configuration for DAC 0d = Disable 1d = Enable
1	DAC_POWER_SCAL	R/W	0b	DAC IREF select configuration. 0d = Vref/R 1d = Vref/2R
0	RESERVED	R	0b	Reserved bit; Write only reset value

#### 7.5.1.60 OUT1x\_CFG0 Register (Address = 0x64) [Reset = 0x20]

OUT1x\_CFG0 is shown in 表 7-87.

Return to the [Summary Table](#).

This register is configuration register 0 for Channel OUT1x.

**表 7-87. OUT1x\_CFG0 Register Field Descriptions**

Bit	Field	Type	Reset	Description
7-5	OUT1x_SRC[2:0]	R/W	001b	OUT1x Source Configuration. 0d = Output driver disabled 1d = Input from DAC signal chain 2d = Input from Analog bypass path 3d = Input from both DAC signal chain and Analog bypass path 4d = Independent input from both DAC signal chain and Analog bypass path (DAC -> OUT1P , IN1P -> OUT1M) 5d = Independent input from both DAC signal chain and Analog bypass path (IN1M -> OUT1P, DAC -> OUT1M) 6d-7d = Reserved; Don't use
4-2	OUT1x_CFG[2:0]	R/W	000b	OUT1x DAC / Analog Bypass Routing Configuration. (Don't use if OUT1x_SRC configured 4d or 5d) 0d = Differential (DAC1AP + DAC1BP / IN1M -> OUT1P ; DAC1AM + DAC1BM / IN1P -> OUT1M) 1d = Stereo single-ended (DAC1A / IN1M -> OUT1P ; DAC1B / IN1P -> OUT1M) 2d = Mono single-ended with output at OUT1P only (DAC1A + DAC1B / IN1M-> OUT1P) 3d = Mono single-ended with output at OUT1M only (DAC1A + DAC1B / IN1P -> OUT1M) 4d = Pseudo differential with OUT1M as VCOM (DAC1A, DAC1B / IN1M -> OUT1P, VCOM -> OUT1M) 5d = Pseudo differential with OUT1M as VCOM and OUT2M for external sensing (DAC1A, DAC1B / IN1M -> OUT1P, VCOM -> OUT1M) 6d = Pseudo differential with OUT1P as VCOM (IN1P -> OUT1M, VCOM -> OUT1P) 7d = Reserved; Don't use
1	OUT1x_VCOM	R/W	0b	Channel OUT1x VCOM configuration. 0d = 0.6 * Vref (for 1.375V VREF mode alone as 0.654*Vref) 1d = AVDD by 2
0	OUT1x_LP_MODE	R/W	0b	Low power mode of OUT1x channel. (only valid for OUT1x_SRC configured as DAC signal chain) (not valid for OUT1x_CFG configured as Stereo SE) 0d = Low power mode is disabled (3 dB higher perf) 1d = Low power mode is enabled

ADVANCE INFORMATION

**7.5.1.61 OUT1x\_CFG1 Register (Address = 0x65) [Reset = 0x20]**

OUT1x\_CFG1 is shown in [表 7-88](#).

Return to the [Summary Table](#).

This register is configuration register 1 for Channel OUT1x.

**表 7-88. OUT1x\_CFG1 Register Field Descriptions**

Bit	Field	Type	Reset	Description
7-6	OUT1P_DRIVE[1:0]	R/W	00b	Channel OUT1P drive configuration. 0d = Line out driver with minimum 300 Ω impedance 1d = Headphone driver with minimum 4 Ω impedance 2d = 4 Ω 3d = FD Receiver/Debug

表 7-88. OUT1x\_CFG1 Register Field Descriptions (続き)

Bit	Field	Type	Reset	Description
5-3	OUT1P_LVL_CTRL[2:0]	R/W	100b	Channel OUT1P level control configuration. 0d = 24 dB (only for DAC sigchain SE) 1d = 18 dB (only for DAC sigchain) 2d = 12 dB (DAC sigchain -> RFB 80K if RIN=20k configured) 3d = 6 dB (DAC sigchain -> RFB 40K if RIN=20k configured) 4d = 0 dB (DAC sigchain -> RFB 20K if RIN=20k configured) 5d = -6 dB (DAC sigchain -> RFB 10K if RIN=20k configured) 6d = -12 dB (available for Rin 4.4-kΩ only) 7d = Reserved; Don't use
2	AIN1M_BYP_IMP	R/W	0b	AIN1M Analog Bypass input impedance. 0d = 4.4-kΩ 1d = 20-kΩ
1	AIN1x_BYP_CFG	R/W	0b	IN1x Analog Bypass input config. 0d = FD / Pseudo Diff 1d = SE
0	DAC_CH1_BW_MODE	R/W	0b	DAC Channel 1 band-width selection. 0d = audio band-width (24 kHz mode) 1d = wide band-width (96 kHz mode)

### 7.5.1.62 OUT1x\_CFG2 Register (Address = 0x66) [Reset = 0x20]

OUT1x\_CFG2 is shown in 表 7-89.

Return to the [Summary Table](#).

This register is configuration register 2 for Channel OUT2x.

表 7-89. OUT1x\_CFG2 Register Field Descriptions

Bit	Field	Type	Reset	Description
7-6	OUT1M_DRIVE[1:0]	R/W	00b	Channel OUT1M drive configuration. 0d = Line out driver with minimum 300 Ω impedance 1d = Headphone driver with minimum 4 Ω impedance 2d = 4 Ω 3d = FD Receiver/Debug
5-3	OUT1M_LVL_CTRL[2:0]	R/W	100b	Channel OUT1M level control configuration. 0d = 24 dB (only for DAC sigchain SE) 1d = 18 dB (only for DAC sigchain) 2d = 12 dB (DAC sigchain -> RFB 80K if RIN=20k configured) 3d = 6 dB (DAC sigchain -> RFB 40K if RIN=20k configured) 4d = 0 dB (DAC sigchain -> RFB 20K if RIN=20k configured) 5d = -6 dB (DAC sigchain -> RFB 10K if RIN=20k configured) 6d = -12 dB (available for Rin 4.4-kΩ only) 7d = Reserved; Don't use
2	AIN1P_BYP_IMP	R/W	0b	AIN1P Analog Bypass input impedance. 0d = 4.4-kΩ 1d = 20-kΩ
1	DAC_CH1_FULLSCALE_VAL	R/W	0b	DAC Channel 1 Fullscale value for VREF=2.75 V (applicable for the analog input). 0d = 2 Vrms differential ( 1 Vrms for single ended operation) 1d = 4 Vrms differential ( 2 Vrms for single ended operation) (For AC-coupled configuration external biasing is required for input common mode, this mode supported with common mode variance tolerance rail to rail) (only 2.75 VREF supported, only supported in audio band-width mode)

表 7-89. OUT1x\_CFG2 Register Field Descriptions (続き)

Bit	Field	Type	Reset	Description
0	DAC_CH1_CM_TOL	R/W	0b	DAC Channel 1 input coupling (applicable for the analog input). 0d = AC-coupled input with common mode variance tolerance supported 50 mVpp for single ended and 100 mVpp for differential configuration 1d = AC-coupled / DC-coupled input with common mode variance tolerance supported rail to rail (supply to ground)

#### 7.5.1.63 DAC\_CH1A\_CFG0 Register (Address = 0x67) [Reset = 0xC9]

DAC\_CH1A\_CFG0 is shown in [表 7-90](#).

Return to the [Summary Table](#).

This register is configuration register 0 for DAC channel 1A.

表 7-90. DAC\_CH1A\_CFG0 Register Field Descriptions

Bit	Field	Type	Reset	Description
7-0	DAC_CH1A_DVOL[7:0]	R/W	11001001b	Channel 1A digital volume control. 0d = Digital Volume is muted 1d = Digital Volume Control set to -100 dB 2d = Digital Volume Control set to -99.5 dB 3d to 200d = Digital Volume Control set to as per configuration 201d = Digital Volume Control set to 0 dB 202d = Digital Volume Control set to +0.5 dB 203d to 253d = Digital Volume Control set to as per configuration 254d = Digital Volume Control set to +26.5 dB 255d = Digital Volume Control set to +27 dB

#### 7.5.1.64 DAC\_CH1A\_CFG1 Register (Address = 0x68) [Reset = 0x80]

DAC\_CH1A\_CFG1 is shown in [表 7-91](#).

Return to the [Summary Table](#).

This register is configuration register 1 for DAC channel 1A.

表 7-91. DAC\_CH1A\_CFG1 Register Field Descriptions

Bit	Field	Type	Reset	Description
7-4	DAC_CH1A_FGAIN[3:0]	R/W	1000b	DAC channel 1A fine gain calibration. 0d = Fine gain is set to -0.8 dB 1d = Fine gain is set to -0.7 dB 2d = Fine gain is set to -0.6 dB 3d to 7d = Fine gain is set as per configuration 8d = Fine gain is set to 0 dB 9d = Fine gain is set to 0.1 dB 10d to 13d = Fine gain is set as per configuration 14d = Fine gain is set to 0.6 dB 15d = Fine gain is set to 0.7 dB
3-0	RESERVED	R	0000b	Reserved bits; Write only reset value

#### 7.5.1.65 DAC\_CH1B\_CFG0 Register (Address = 0x69) [Reset = 0xC9]

DAC\_CH1B\_CFG0 is shown in [表 7-92](#).

Return to the [Summary Table](#).

This register is configuration register 0 for DAC channel 1B.

表 7-92. DAC\_CH1B\_CFG0 Register Field Descriptions

Bit	Field	Type	Reset	Description
7-0	DAC_CH1B_DVOL[7:0]	R/W	11001001b	Channel 1B digital volume control. 0d = Digital Volume is muted 1d = Digital Volume Control set to -100 dB 2d = Digital Volume Control set to -99.5 dB 3d to 200d = Digital Volume Control set to as per configuration 201d = Digital Volume Control set to 0 dB 202d = Digital Volume Control set to +0.5 dB 203d to 253d = Digital Volume Control set to as per configuration 254d = Digital Volume Control set to +26.5 dB 255d = Digital Volume Control set to +27 dB

#### 7.5.1.66 DAC\_CH1B\_CFG1 Register (Address = 0x6A) [Reset = 0x80]

DAC\_CH1B\_CFG1 is shown in 表 7-93.

Return to the [Summary Table](#).

This register is configuration register 1 for DAC channel 1B.

表 7-93. DAC\_CH1B\_CFG1 Register Field Descriptions

Bit	Field	Type	Reset	Description
7-4	DAC_CH1B_FGAIN[3:0]	R/W	1000b	DAC channel 1B fine gain calibration. 0d = Fine gain is set to -0.8 dB 1d = Fine gain is set to -0.7 dB 2d = Fine gain is set to -0.6 dB 3d to 7d = Fine gain is set as per configuration 8d = Fine gain is set to 0 dB 9d = Fine gain is set to 0.1 dB 10d to 13d = Fine gain is set as per configuration 14d = Fine gain is set to 0.6 dB 15d = Fine gain is set to 0.7 dB
3-0	RESERVED	R	0000b	Reserved bits; Write only reset value

#### 7.5.1.67 OUT2x\_CFG0 Register (Address = 0x6B) [Reset = 0x20]

OUT2x\_CFG0 is shown in 表 7-94.

Return to the [Summary Table](#).

This register is configuration register 0 for Channel OUT2x.

表 7-94. OUT2x\_CFG0 Register Field Descriptions

Bit	Field	Type	Reset	Description
7-5	OUT2x_SRC[2:0]	R/W	001b	OUT2x Source Configuration. 0d = Output driver disabled 1d = Input from DAC signal chain 2d = Input from Analog bypass path 3d = Input from both DAC signal chain and Analog bypass path 4d = Independent input from both DAC signal chain and Analog bypass path (DAC -> OUT2P, IN2P -> OUT2M) 5d = Independent input from both DAC signal chain and Analog bypass path (IN2M -> OUT2P, DAC -> OUT2M) 6d-7d = Reserved; Don't use

表 7-94. OUT2x\_CFG0 Register Field Descriptions (続き)

Bit	Field	Type	Reset	Description
4-2	OUT2x_CFG[2:0]	R/W	000b	OUT2x DAC / Analog Bypass Routing Configuration. (Don't use if OUT1x_SRC configured 4d or 5d) 0d = Differential (DAC2AP + DAC2BP / IN2M -> OUT2P ; DAC2AM + DAC2BM / IN2P -> OUT2M) 1d = Stereo single-ended (DAC2A / IN2M -> OUT2P ; DAC2B / IN2P -> OUT2M) 2d = Mono single-ended with output at OUT2P only (DAC2A + DAC2B / IN2M-> OUT2P) 3d = Mono single-ended with output at OUT2M only (DAC2A + DAC2B / IN2P -> OUT2M) 4d = Pseudo differential with OUT2M as VCOM (DAC2A, DAC2B / IN2M -> OUT2P, VCOM -> OUT2M) 5d =Reserved; Don't use 6d = Pseudo differential with OUT2P as VCOM (IN2P -> OUT2M, VCOM -> OUT2P) 7d = Reserved; Don't use
1	OUT2x_VCOM	R/W	0b	Channel OUT2x VCOM configuration. 0d = 0.6 * Vref (for 1.375V VREF mode alone as 0.654*Vref) 2d = AVDD by 2
0	OUT2x_LP_MODE	R/W	0b	Low power mode of OUT2x channel. (only valid for OUT2x_SRC configured as DAC signal chain) (not valid for OUT2x_CFG configured as Stereo SE) 0d = Low power mode is disabled (3 dB higher perf) 1d = Low power mode is enabled

7.5.1.68 OUT2x\_CFG1 Register (Address = 0x6C) [Reset = 0x20]

OUT2x\_CFG1 is shown in 表 7-95.

Return to the [Summary Table](#).

This register is configuration register 1 for Channel OUT2x.

表 7-95. OUT2x\_CFG1 Register Field Descriptions

Bit	Field	Type	Reset	Description
7-6	OUT2P_DRIVE[1:0]	R/W	00b	Channel OUT2P drive configuration. 0d = Line out driver with minimum 300 Ω impedance 1d = Headphone driver with minimum 4 Ω impedance 2d = 4 Ω 3d = FD Receiver/Debug
5-3	OUT2P_LVL_CTRL[2:0]	R/W	100b	Channel OUT2P level control configuration 0d = 24 dB (only for DAC sigchain SE) 1d = 18 dB (only for DAC sigchain) 2d = 12 dB (DAC sigchain -> RFB 80K if RIN=20k configured) 3d = 6 dB (DAC sigchain -> RFB 40K if RIN=20k configured) 4d = 0 dB (DAC sigchain -> RFB 20K if RIN=20k configured) 5d = -6 dB (DAC sigchain -> RFB 10K if RIN=20k configured) 6d = -12 dB (available for Rin 4.4-kΩ only) 7d = Reserved; Don't use
2	AIN2M_BYP_IMP	R/W	0b	AIN2M Analog Bypass input impedance. 0d = 4.4-kΩ 1d = 20-kΩ
1	AIN2x_BYP_CFG	R/W	0b	IN2x Analog Bypass input config. 0d = FD / Pseudo Diff 1d = SE
0	DAC_CH2_BW_MODE	R/W	0b	DAC Channel 2 band-width selection. 0d = audio band-width (24 kHz mode) 1d = wide band-width (96 kHz mode)



### 7.5.1.69 OUT2x\_CFG2 Register (Address = 0x6D) [Reset = 0x20]

OUT2x\_CFG2 is shown in 表 7-96.

Return to the [Summary Table](#).

This register is configuration register 2 for Channel OUT2x.

表 7-96. OUT2x\_CFG2 Register Field Descriptions

Bit	Field	Type	Reset	Description
7-6	OUT2M_DRIVE[1:0]	R/W	00b	Channel OUT2M drive configuration. 0d = Line out driver with minimum 300 Ω impedance 1d = Headphone driver with minimum 4 Ω impedance 2d = 4 Ω 3d = FD Receiver/Debug
5-3	OUT2M_LVL_CTRL[2:0]	R/W	100b	Channel OUT2M level control configuration. 0d = 24 dB (only for DAC sigchain SE) 1d = 18 dB (only for DAC sigchain) 2d = 12 dB (DAC sigchain -> RFB 80K if RIN=20k configured) 3d = 6 dB (DAC sigchain -> RFB 40K if RIN=20k configured) 4d = 0 dB (DAC sigchain -> RFB 20K if RIN=20k configured) 5d = -6 dB (DAC sigchain -> RFB 10K if RIN=20k configured) 6d = -12 dB (available for Rin 4.4-kΩ only) 7d = Reserved; Don't use
2	AIN2P_BYP_IMP	R/W	0b	AIN2P Analog Bypass input impedance. 0d = 4.4-kΩ 1d = 20-kΩ
1	DAC_CH2_FULLSCALE_VAL	R/W	0b	DAC Channel 2 Fullscale value for VREF=2.75 V (applicable for the analog input). 0d = 2 Vrms differential ( 1 Vrms for single ended operation) 1d = 4 Vrms differential ( 2 Vrms for single ended operation) (For AC-coupled configuration external biasing is required for input common mode, this mode supported with common mode variance tolerance rail to rail) (only 2.75 VREF supported, only supported in audio bandwidth mode)
0	DAC_CH2_CM_TOL	R/W	0b	DAC Channel 2 input coupling (applicable for the analog input). 0d = AC-coupled input with common mode variance tolerance supported 50 mVpp for single ended and 100 mVpp for differential configuration 1d = AC-coupled / DC-coupled input with common mode variance tolerance supported rail to rail (supply to ground)

### 7.5.1.70 DAC\_CH2A\_CFG0 Register (Address = 0x6E) [Reset = 0xC9]

DAC\_CH2A\_CFG0 is shown in 表 7-97.

Return to the [Summary Table](#).

This register is configuration register 0 for DAC channel 2A.

表 7-97. DAC\_CH2A\_CFG0 Register Field Descriptions

Bit	Field	Type	Reset	Description
7-0	DAC_CH2A_DVOL[7:0]	R/W	11001001b	Channel 2A digital volume control. 0d = Digital Volume is muted 1d = Digital Volume Control set to -100 dB 2d = Digital Volume Control set to -99.5 dB 3d to 200d = Digital Volume Control set to as per configuration 201d = Digital Volume Control set to 0 dB 202d = Digital Volume Control set to +0.5 dB 203d to 253d = Digital Volume Control set to as per configuration 254d = Digital Volume Control set to +26.5 dB 255d = Digital Volume Control set to +27 dB

### 7.5.1.71 DAC\_CH2A\_CFG1 Register (Address = 0x6F) [Reset = 0x80]

DAC\_CH2A\_CFG1 is shown in [表 7-98](#).

Return to the [Summary Table](#).

This register is configuration register 1 for DAC channel 2A.

**表 7-98. DAC\_CH2A\_CFG1 Register Field Descriptions**

Bit	Field	Type	Reset	Description
7-4	DAC_CH2A_FGAIN[3:0]	R/W	1000b	DAC channel 2A fine gain calibration. 0d = Fine gain is set to -0.8 dB 1d = Fine gain is set to -0.7 dB 2d = Fine gain is set to -0.6 dB 3d to 7d = Fine gain is set as per configuration 8d = Fine gain is set to 0 dB 9d = Fine gain is set to 0.1 dB 10d to 13d = Fine gain is set as per configuration 14d = Fine gain is set to 0.6 dB 15d = Fine gain is set to 0.7 dB
3-0	RESERVED	R	0000b	Reserved bits; Write only reset value

### 7.5.1.72 DAC\_CH2B\_CFG0 Register (Address = 0x70) [Reset = 0xC9]

DAC\_CH2B\_CFG0 is shown in [表 7-99](#).

Return to the [Summary Table](#).

This register is configuration register 0 for DAC channel 2B.

**表 7-99. DAC\_CH2B\_CFG0 Register Field Descriptions**

Bit	Field	Type	Reset	Description
7-0	DAC_CH2B_DVOL[7:0]	R/W	11001001b	Channel 2B digital volume control. 0d = Digital Volume is muted 1d = Digital Volume Control set to -100 dB 2d = Digital Volume Control set to -99.5 dB 3d to 200d = Digital Volume Control set to as per configuration 201d = Digital Volume Control set to 0 dB 202d = Digital Volume Control set to +0.5 dB 203d to 253d = Digital Volume Control set to as per configuration 254d = Digital Volume Control set to +26.5 dB 255d = Digital Volume Control set to +27 dB

### 7.5.1.73 DAC\_CH2B\_CFG1 Register (Address = 0x71) [Reset = 0x80]

DAC\_CH2B\_CFG1 is shown in [表 7-100](#).

Return to the [Summary Table](#).

This register is configuration register 1 for DAC channel 2B.

**表 7-100. DAC\_CH2B\_CFG1 Register Field Descriptions**

Bit	Field	Type	Reset	Description
7-4	DAC_CH2B_FGAIN[3:0]	R/W	1000b	DAC channel 2B fine gain calibration. 0d = Fine gain is set to -0.8 dB 1d = Fine gain is set to -0.7 dB 2d = Fine gain is set to -0.6 dB 3d to 7d = Fine gain is set as per configuration 8d = Fine gain is set to 0 dB 9d = Fine gain is set to 0.1 dB 10d to 13d = Fine gain is set as per configuration 14d = Fine gain is set to 0.6 dB 15d = Fine gain is set to 0.7 dB

表 7-100. DAC\_CH2B\_CFG1 Register Field Descriptions (続き)

Bit	Field	Type	Reset	Description
3-0	RESERVED	R	0000b	Reserved bits; Write only reset value

#### 7.5.1.74 DSP\_CFG1 Register (Address = 0x73) [Reset = 0x18]

DSP\_CFG1 is shown in 表 7-101.

Return to the [Summary Table](#).

This register is the digital signal processor (DSP) configuration register 0.

表 7-101. DSP\_CFG1 Register Field Descriptions

Bit	Field	Type	Reset	Description
7-6	DAC_DSP_INTX_FILT[1:0]	R/W	00b	DAC channel decimation filter response. 0d = Linear phase 1d = Low latency 2d = Ultra-low latency 3d = Reserved; Don't use
5-4	DAC_DSP_HPF_SEL[1:0]	R/W	01b	DAC channel high-pass filter (HPF) selection. 0d = Programmable first-order IIR filter for a custom HPF with default coefficient values in P17_R120-127 and P18_R8-11 set as the all-pass filter 1d = HPF with a cutoff of $0.00002 \times f_S$ (1 Hz at $f_S = 48$ kHz) is selected 2d = HPF with a cutoff of $0.00025 \times f_S$ (12 Hz at $f_S = 48$ kHz) is selected 3d = HPF with a cutoff of $0.002 \times f_S$ (96 Hz at $f_S = 48$ kHz) is selected
3-2	DAC_DSP_BQ_CFG[1:0]	R/W	10b	Number of biquads per DAC channel configuration. 0d = No biquads per channel; biquads are all disabled 1d = 1 biquad per channel 2d = 2 biquads per channel 3d = 3 biquads per channel
1	DAC_DSP_DISABLE_SOFT_STEP	R/W	0b	DAC Soft-stepping disable during DVOL change, mute, and unmute. 0d = Soft-stepping enabled 1d = Soft-stepping disabled
0	DAC_DSP_DVOL_GANG	R/W	0b	DVOL control ganged across DAC channels. 0d = Each DAC channel has its own DVOL CTRL settings as programmed in the DAC_CHx_DVOL bits 1d = All active channels must use the channel 1 DVOL setting (DAC_CH1_DVOL) irrespective of whether channel 1 is turned on or not

#### 7.5.1.75 CH\_EN Register (Address = 0x76) [Reset = 0xCC]

CH\_EN is shown in 表 7-102.

Return to the [Summary Table](#).

This register is the channel enable configuration register.

表 7-102. CH\_EN Register Field Descriptions

Bit	Field	Type	Reset	Description
7	RESERVED	R/W	1b	Reserved bit; Write only reset value
6	RESERVED	R/W	1b	Reserved bit; Write only reset value
5	RESERVED	R/W	0b	Reserved bit; Write only reset value
4	RESERVED	R/W	0b	Reserved bit; Write only reset value

**表 7-102. CH\_EN Register Field Descriptions (続き)**

Bit	Field	Type	Reset	Description
3	OUT_CH1_EN	R/W	1b	Output channel 1 enable setting. 0d = Output channel 1 is disabled 1d = Output channel 1 is enabled
2	OUT_CH2_EN	R/W	1b	Output channel 2 enable setting. 0d = Output channel 2 is disabled 1d = Output channel 2 is enabled
1	OUT_CH3_EN	R/W	0b	Output channel 3 enable setting. 0d = Output channel 3 is disabled 1d = Output channel 3 is enabled
0	OUT_CH4_EN	R/W	0b	Output channel 4 enable setting. 0d = Output channel 4 is disabled 1d = Output channel 4 is enabled

**7.5.1.76 DYN\_PUPD\_CFG Register (Address = 0x77) [Reset = 0x00]**

DYN\_PUPD\_CFG is shown in [表 7-103](#).

Return to the [Summary Table](#).

This register is the power-up configuration register.

**表 7-103. DYN\_PUPD\_CFG Register Field Descriptions**

Bit	Field	Type	Reset	Description
7	RESERVED	R/W	0b	Reserved bit; Write only reset value
6	RESERVED	R/W	0b	Reserved bit; Write only reset value
5	DAC_DYN_PUPD_EN	R/W	0b	Dynamic channel power-up, power-down enable for playback path. 0d = Channel power-up, power-down is not supported if any channel playback is on 1d = Channel can be powered up or down individually, even if channel playback is on
4	DAC_DYN_MAXCH_SEL	R/W	0b	Dynamic mode maximum channel select configuration for playback path. 0d = Channel 1 and channel 2 are used with dynamic channel power-up, power-down feature enabled 1d = Channel 1 to channel 4 are used with dynamic channel power-up, power-down feature enabled
3	RESERVED	R/W	0b	Reserved bit; Write only reset value
2-0	RESERVED	R	000b	Reserved bits; Write only reset value

**7.5.1.77 PWR\_CFG Register (Address = 0x78) [Reset = 0x00]**

PWR\_CFG is shown in [表 7-104](#).

Return to the [Summary Table](#).

This register is the power-up configuration register.

**表 7-104. PWR\_CFG Register Field Descriptions**

Bit	Field	Type	Reset	Description
7	RESERVED	R/W	0b	Reserved bit; Write only reset value
6	DAC_PDZ	R/W	0b	Power control for DAC channels. 0d = Power down all DAC channels 1d = Power up all enabled DAC channels
5	RESERVED	R/W	0b	Reserved bit; Write only reset value
4	RESERVED	R	0b	Reserved bit; Write only reset value

表 7-104. PWR\_CFG Register Field Descriptions (続き)

Bit	Field	Type	Reset	Description
3	RESERVED	R/W	0b	Reserved bit; Write only reset value
2	RESERVED	R/W	0b	Reserved bit; Write only reset value
1	UAG_EN	R/W	0b	Enable ultrasound activity detection (UAG) algorithm. 0d = UAG is disabled 1d = UAG is enabled
0	RESERVED	R	0b	Reserved bit; Write only reset value

### 7.5.1.78 DEV\_STS0 Register (Address = 0x79) [Reset = 0x00]

DEV\_STS0 is shown in 表 7-105.

Return to the [Summary Table](#).

This register is the device status value register 0.

表 7-105. DEV\_STS0 Register Field Descriptions

Bit	Field	Type	Reset	Description
7	RESERVED	R	0b	Reserved bit; Write only reset value
6	RESERVED	R	0b	Reserved bit; Write only reset value
5	RESERVED	R	0b	Reserved bit; Write only reset value
4	RESERVED	R	0b	Reserved bit; Write only reset value
3	OUT_CH1_STATUS	R	0b	DAC channel 1 power status. 0d = DAC channel is powered down 1d = DAC channel is powered up
2	OUT_CH2_STATUS	R	0b	DAC channel 2 power status. 0d = DAC channel is powered down 1d = DAC channel is powered up
1	OUT_CH3_STATUS	R	0b	DAC channel 3 power status. 0d = DAC channel is powered down 1d = DAC channel is powered up
0	OUT_CH4_STATUS	R	0b	DAC channel 4 power status. 0d = DAC channel is powered down 1d = DAC channel is powered up

### 7.5.1.79 DEV\_STS1 Register (Address = 0x7A) [Reset = 0x80]

DEV\_STS1 is shown in 表 7-106.

Return to the [Summary Table](#).

This register is the device status value register 1.

表 7-106. DEV\_STS1 Register Field Descriptions

Bit	Field	Type	Reset	Description
7-5	MODE_STS[2:0]	R	100b	Device mode status. 0-3d = Reserved 4d = Device is in sleep mode or software shutdown mode 5d = Reserved 6d = Device is in active mode with all record and playback channels turned off 7d = Device is in active mode with at least one record or playback channel turned on
4	PLL_STS	R	0b	PLL status. 0d = PLL is not enabled 1d = PLL is enabled

表 7-106. DEV\_STS1 Register Field Descriptions (続き)

Bit	Field	Type	Reset	Description
3	RESERVED	R	0b	Reserved bit; Write only reset value
2	RESERVED	R	0b	Reserved bit; Write only reset value
1	RESERVED	R	0b	Reserved bit; Write only reset value
0	RESERVED	R	0b	Reserved bit; Write only reset value

#### 7.5.1.80 I2C\_CKSUM Register (Address = 0x7E) [Reset = 0x00]

I2C\_CKSUM is shown in [表 7-107](#).

Return to the [Summary Table](#).

This register returns the I<sup>2</sup>C transactions checksum value.

表 7-107. I2C\_CKSUM Register Field Descriptions

Bit	Field	Type	Reset	Description
7-0	I2C_CKSUM[7:0]	R/W	00000000b	These bits return the I <sup>2</sup> C transactions checksum value. Writing to this register resets the checksum to the written value. This register is updated on writes to other registers on all pages.

## 7.5.2 TAD5212\_P1 Registers

表 7-108 lists the memory-mapped registers for the TAD5212\_P1 registers. All register offset addresses not listed in 表 7-108 should be considered as reserved locations and the register contents should not be modified.

**表 7-108. TAD5212\_P1 Registers**

Address	Acronym	Register Name	Reset Value	Section
0x0	PAGE_CFG	Device page register	0x00	<a href="#">PAGE_CFG Register (Address = 0x0) [Reset = 0x00]</a>
0x3	DSP_CFG0		0x00	<a href="#">DSP_CFG0 Register (Address = 0x3) [Reset = 0x00]</a>
0xD	CLK_CFG0		0x00	<a href="#">CLK_CFG0 Register (Address = 0xD) [Reset = 0x00]</a>
0xF	CHANNEL_CFG2		0x00	<a href="#">CHANNEL_CFG2 Register (Address = 0xF) [Reset = 0x00]</a>
0x17	SRC_CFG0	SRC configuration register 1	0x00	<a href="#">SRC_CFG0 Register (Address = 0x17) [Reset = 0x00]</a>
0x18	SRC_CFG1	SRC configuration register 2	0x00	<a href="#">SRC_CFG1 Register (Address = 0x18) [Reset = 0x00]</a>
0x19	JACK_DET_CFG0	JACK DET configuration register 0	0x00	<a href="#">JACK_DET_CFG0 Register (Address = 0x19) [Reset = 0x00]</a>
0x1A	JACK_DET_CFG1	JACK DET configuration register 1	0x00	<a href="#">JACK_DET_CFG1 Register (Address = 0x1A) [Reset = 0x00]</a>
0x1B	JACK_DET_CFG2	JACK DET configuration register 2	0x00	<a href="#">JACK_DET_CFG2 Register (Address = 0x1B) [Reset = 0x00]</a>
0x1C	JACK_DET_CFG3	JACK DET configuration register 3	0x00	<a href="#">JACK_DET_CFG3 Register (Address = 0x1C) [Reset = 0x00]</a>
0x1F	LPSG_CFG1	LPSG	0x80	<a href="#">LPSG_CFG1 Register (Address = 0x1F) [Reset = 0x80]</a>
0x20	LPSG_CFG1	LPSG configuration register 1	0x00	<a href="#">LPSG_CFG1 Register (Address = 0x1F) [Reset = 0x80]</a>
0x23	LIMITER_CFG	Limiter configuration register 2	0x00	<a href="#">LIMITER_CFG Register (Address = 0x23) [Reset = 0x00]</a>
0x2B	PLIM_CFG0	PLIM configuration register 0	0x00	<a href="#">PLIM_CFG0 Register (Address = 0x2B) [Reset = 0x00]</a>
0x2C	MIXER_CFG0	MISC configuration register 0	0x00	<a href="#">MIXER_CFG0 Register (Address = 0x2C) [Reset = 0x00]</a>

表 7-108. TAD5212\_P1 Registers (続き)

Address	Acronym	Register Name	Reset Value	Section
0x2D	MISC_CFG0	MISC configuration register 0	0x00	MISC_CFG0 Register (Address = 0x2D) [Reset = 0x00]
0x2E	BRWNOUT		0xBF	BRWNOUT Register (Address = 0x2E) [Reset = 0xBF]
0x2F	INT_MASK0	Interrupt Mask Register-0	0xFF	INT_MASK0 Register (Address = 0x2F) [Reset = 0xFF]
0x32	INT_MASK4	Interrupt Mask Register-3	0x00	INT_MASK4 Register (Address = 0x32) [Reset = 0x00]
0x33	INT_MASK5	Interrupt Mask Register-3	0x30	INT_MASK5 Register (Address = 0x33) [Reset = 0x30]
0x34	INT_LTCH0	Latched Interrupt Readback Register-0	0x00	INT_LTCH0 Register (Address = 0x34) [Reset = 0x00]
0x35	CHx_LTCH	Summary of Diagnostics	0x00	CHx_LTCH Register (Address = 0x35) [Reset = 0x00]
0x38	OUT_CH1_LTCH		0x00	OUT_CH1_LTCH Register (Address = 0x38) [Reset = 0x00]
0x39	OUT_CH2_LTCH		0x00	OUT_CH2_LTCH Register (Address = 0x39) [Reset = 0x00]
0x3A	INT_LTCH1	Latched Interrupt Readback Register-0	0x00	INT_LTCH1 Register (Address = 0x3A) [Reset = 0x00]
0x3B	INT_LTCH2	Latched Interrupt Readback Register-3	0x00	INT_LTCH2 Register (Address = 0x3B) [Reset = 0x00]
0x3C	INT_LIVE0	Live Interrupt Readback Register-0	0x00	INT_LIVE0 Register (Address = 0x3C) [Reset = 0x00]
0x3D	CHx_LIVE	Summary of Diagnostics	0x00	CHx_LIVE Register (Address = 0x3D) [Reset = 0x00]
0x40	OUT_CH1_LIVE		0x00	OUT_CH1_LIVE Register (Address = 0x40) [Reset = 0x00]
0x41	OUT_CH2_LIVE		0x00	OUT_CH2_LIVE Register (Address = 0x41) [Reset = 0x00]
0x42	INT_LIVE1	Latched Interrupt Readback Register-0	0x00	INT_LIVE1 Register (Address = 0x42) [Reset = 0x00]
0x43	INT_LIVE2	Latched Interrupt Readback Register-3	0x00	INT_LIVE2 Register (Address = 0x43) [Reset = 0x00]
0x4E	DIAG_CFG8		0xBA	DIAG_CFG8 Register (Address = 0x4E) [Reset = 0xBA]



**表 7-108. TAD5212\_P1 Registers (続き)**

Address	Acronym	Register Name	Reset Value	Section
0x4F	DIAG_CFG9		0x4B	DIAG_CFG9 Register (Address = 0x4F) [Reset = 0x4B]
0x54	DIAG_CFG14		0x48	DIAG_CFG14 Register (Address = 0x54) [Reset = 0x48]
0x55	DIAGDATA_CFG		0x00	DIAGDATA_CFG Register (Address = 0x55) [Reset = 0x00]
0x62	DIAG_MON_MSB_OUT1P		0x00	DIAG_MON_MSB_OUT1P Register (Address = 0x62) [Reset = 0x00]
0x63	DIAG_MON_LSB_OUT1P		0x06	DIAG_MON_LSB_OUT1P Register (Address = 0x63) [Reset = 0x06]
0x64	DIAG_MON_MSB_OUT1M		0x00	DIAG_MON_MSB_OUT1M Register (Address = 0x64) [Reset = 0x00]
0x65	DIAG_MON_LSB_OUT1M		0x07	DIAG_MON_LSB_OUT1M Register (Address = 0x65) [Reset = 0x07]
0x66	DIAG_MON_MSB_OUT2P		0x00	DIAG_MON_MSB_OUT2P Register (Address = 0x66) [Reset = 0x00]
0x67	DIAG_MON_LSB_OUT2P		0x08	DIAG_MON_LSB_OUT2P Register (Address = 0x67) [Reset = 0x08]
0x68	DIAG_MON_MSB_OUT2M		0x00	DIAG_MON_MSB_OUT2M Register (Address = 0x68) [Reset = 0x00]
0x69	DIAG_MON_LSB_OUT2M		0x09	DIAG_MON_LSB_OUT2M Register (Address = 0x69) [Reset = 0x09]
0x6A	DIAG_MON_MSB_TEMP		0x00	DIAG_MON_MSB_TEMP Register (Address = 0x6A) [Reset = 0x00]
0x6B	DIAG_MON_LSB_TEMP		0x0A	DIAG_MON_LSB_TEMP Register (Address = 0x6B) [Reset = 0x0A]
0x6E	DIAG_MON_MSB_AVDD		0x00	DIAG_MON_MSB_AVDD Register (Address = 0x6E) [Reset = 0x00]
0x6F	DIAG_MON_LSB_AVDD		0x0C	DIAG_MON_LSB_AVDD Register (Address = 0x6F) [Reset = 0x0C]

表 7-108. TAD5212\_P1 Registers (続き)

Address	Acronym	Register Name	Reset Value	Section
0x70	DIAG_MON_MSB_GPA		0x00	DIAG_MON_MSB_GPA Register (Address = 0x70) [Reset = 0x00]
0x71	DIAG_MON_LSB_GPA		0x0D	DIAG_MON_LSB_GPA Register (Address = 0x71) [Reset = 0x0D]

### 7.5.2.1 PAGE\_CFG Register (Address = 0x0) [Reset = 0x00]

PAGE\_CFG is shown in 表 7-109.

Return to the [Summary Table](#).

The device memory map is divided into pages. This register sets the page.

表 7-109. PAGE\_CFG Register Field Descriptions

Bit	Field	Type	Reset	Description
7-0	PAGE[7:0]	R/W	00000000b	These bits set the device page. 0d = Page 0 1d = Page 1 2d to 254d = Page 2 to page 254 respectively 255d = Page 255

### 7.5.2.2 DSP\_CFG0 Register (Address = 0x3) [Reset = 0x00]

DSP\_CFG0 is shown in 表 7-110.

Return to the [Summary Table](#).

表 7-110. DSP\_CFG0 Register Field Descriptions

Bit	Field	Type	Reset	Description
7	RESERVED	R/W	0b	Reserved bit; Write only reset value
6	RESERVED	R/W	0b	Reserved bit; Write only reset value
5	RESERVED	R/W	0b	Reserved bit; Write only reset value
4	RESERVED	R	0b	Reserved bit; Write only reset value
3	RESERVED	R/W	0b	Reserved bit; Write only reset value
2	RESERVED	R/W	0b	Reserved bit; Write only reset value
1	DIS_DVOL_OTF_CHG	R/W	0b	Disable run-time changes to DVOL settings. 0d = Digital volume control changes supported while ADC is powered-on 1d = Digital volume control changes not supported while ADC is powered-on.
0	EN_BQ_OTF_CHG	R/W	0b	Enable run-time changes to Biquad settings. 0d = Disable on the fly biquad changes 1d = Enable on the fly biquad changes

### 7.5.2.3 CLK\_CFG0 Register (Address = 0xD) [Reset = 0x00]

CLK\_CFG0 is shown in 表 7-111.

Return to the [Summary Table](#).

表 7-111. CLK\_CFG0 Register Field Descriptions

Bit	Field	Type	Reset	Description
7	CNT_TGT_CFG_OVR_PASI	R/W	0b	ASI controller target Config Override Register 0d = controller-target Config as per PASI_CNT_CFG bit. 1d = Override the standard behavior of the PASI_CNT_CFG. In this case the clock auto detect feature is not available. PASI_CNT_CFG = 0 : BCLK is input but FSYNC is output. PASI_CNT_CFG = 1 : BCLK is output but FSYNC in input.
6	CNT_TGT_CFG_OVR_SASI	R/W	0b	ASI controller target Config Override Register 0d = controller-target Config as per SASI_CNT_CFG bit. 1d = Override the standard behavior of the SASI_CNT_CFG. In this case the clock auto detect feature is not available. SASI_CNT_CFG = 0 : BCLK is input but FSYNC is output. SASI_CNT_CFG = 1 : BCLK is output but FSYNC in input.
5	RESERVED	R	0b	Reserved bit; Write only reset value
4-3	RESERVED	R/W	00b	Reserved bits; Write only reset values
2	PASI_USE_INT_FSYNC	R/W	0b	For Primary use internal FSYNC in controller mode configuration. 0d = Use external FSYNC 1d = Use internal FSYNC
1	SASI_USE_INT_FSYNC	R/W	0b	For Secondary use internal FSYNC in controller mode configuration. 0d = Use external FSYNC 1d = Use internal FSYNC
0	RESERVED	R/W	0b	Reserved bit; Write only reset value

#### 7.5.2.4 CHANNEL\_CFG2 Register (Address = 0xF) [Reset = 0x00]

CHANNEL\_CFG2 is shown in 表 7-112.

Return to the [Summary Table](#).

表 7-112. CHANNEL\_CFG2 Register Field Descriptions

Bit	Field	Type	Reset	Description
7	DAC_FORCE_DYN_MODE_CUST_MAX_CH	R/W	0b	DAC Force dynamic mode custom max channel 0d = In Dynamic, Max channel is based on DAC_DYN_MAXCH_SEL 1d = In Dynamic mode, max channel is custom as per DAC_DYN_MODE_CUST_MAX_CH
6-3	DAC_DYN_MODE_CUST_MAX_CH[3:0]	R/W	0000b	DAC Dynamic mode custom max channel configuration ([3]->CH4_EN, [2]->CH3_EN, [1]->CH2_EN, [0]->CH1_EN) [3]->CH4_EN [2]->CH3_EN [1]->CH2_EN [0]->CH1_EN
2-0	RESERVED	R	000b	Reserved bits; Write only reset values

#### 7.5.2.5 SRC\_CFG0 Register (Address = 0x17) [Reset = 0x00]

SRC\_CFG0 is shown in 表 7-113.

Return to the [Summary Table](#).

This register is configuration register 1 for SRC.

表 7-113. SRC\_CFG0 Register Field Descriptions

Bit	Field	Type	Reset	Description
7	SRC_EN	R/W	0b	SRC enable config 0b = SRC disable 1b = SRC enable

**表 7-113. SRC\_CFG0 Register Field Descriptions (続き)**

Bit	Field	Type	Reset	Description
6	DIS_AUTO_SRC_DET	R/W	0b	SRC auto detect config 0b = SRC auto detect enabled 1b = SRC auto detect disabled
5-0	RESERVED	R	000000b	Reserved bits; Write only reset value

**7.5.2.6 SRC\_CFG1 Register (Address = 0x18) [Reset = 0x00]**

SRC\_CFG1 is shown in [表 7-114](#).

Return to the [Summary Table](#).

This register is configuration register 2 for SRC.

**表 7-114. SRC\_CFG1 Register Field Descriptions**

Bit	Field	Type	Reset	Description
7	MAIN_FS_CUSTOM_CFG	R/W	0b	Main Fs custom config 0b = Main Fs is auto inferred 1b = Main Fs need to be selected from MAIN_FS_SELECT_CFG
6	MAIN_FS_SELECT_CFG	R/W	0b	Main Fs select config 0b = PASI Fs shall be used as Main Fs 1b = SASI Fs shall be used as Main Fs
5-3	MAIN_AUX_RATIO_M_C USTOM_CFG[2:0]	R/W	000b	Main and Aux Fs Ratio m:n config 0d = m is auto inferred 1d = 1 2d = 2 3d = 3 4d = 4 5d = Reserved 6d = 6 7d = Reserved
2-0	MAIN_AUX_RATIO_N_C USTOM_CFG[2:0]	R/W	000b	Main and Aux Fs Ratio m:n config 0d = n is auto inferred 1d = 1 2d = 2 3d = 3 4d = 4 5d = Reserved 6d = 6 7d = Reserved

**7.5.2.7 JACK\_DET\_CFG0 Register (Address = 0x19) [Reset = 0x00]**

JACK\_DET\_CFG0 is shown in [表 7-115](#).

Return to the [Summary Table](#).

This register is the JACK DET configuration register 0.

**表 7-115. JACK\_DET\_CFG0 Register Field Descriptions**

Bit	Field	Type	Reset	Description
7-6	JACK_DET_MONITOR_F REQ[1:0]	R/W	00b	Headset Detection Pulse Frequency 0d = 0.5 Hz 1d = 1 Hz 2d = 7.5 Hz 3d = 15 Hz
5	JACK_DET_PULSE_WID TH	R/W	0b	Detector Pulse High Width 0d = 4ms (MICBIAS PIN Cap = 1 uF) 1d = 32ms (MICBIAS PIN Cap = 10 uF)

表 7-115. JACK\_DET\_CFG0 Register Field Descriptions (続き)

Bit	Field	Type	Reset	Description
4	RESERVED	R/W	0b	Reserved bit; Write only reset value
3	RESERVED	R/W	0b	Reserved bit; Write only reset value
2-1	HPDET_CLOCK_SEL[1:0]	R/W	00b	Headphone Detection Clock Timeperiod Select 0d = 1ms 1d = 2ms 2d = 4ms 3d = Reserved
0	RESERVED	R/W	0b	Reserved bit; Write only reset value

### 7.5.2.8 JACK\_DET\_CFG1 Register (Address = 0x1A) [Reset = 0x00]

JACK\_DET\_CFG1 is shown in 表 7-116.

Return to the [Summary Table](#).

This register is the JACK DET configuration register 1.

表 7-116. JACK\_DET\_CFG1 Register Field Descriptions

Bit	Field	Type	Reset	Description
7	RESERVED	R/W	0b	Reserved bit; Write only reset value
6	JACK_DET_COMP_CTRL 2	R/W	0b	Hook Press Threshold Control in Fixed External Resistance case, controls the choice of Lowest Microphone impedance to be supported or Highest Hook button Impedance to be supported 0d = Minimum Microphone resistance supported, R_Mic = 800 Ωs and Max Hook button impedance supported, R_Hook = 320 Ωs for AC coupled Headphones R26<3> = 0 (else, when R26<3> = 1, R_hook = 150 Ωs) 1d = Max Hook button impedance supported, R_hook = 680 Ωs and Minimum Microphone resistance supported, R_Mic = 1350 Ωs for AC coupled Headphones R26<3> = 0 (else, when R26<3> = 1, R_Mic = 1750 Ωs)
5-4	JACK_DET_COMP_CTRL 3[1:0]	R/W	00b	Hook Pressed Jack Insertion support, valid only for External Resistor Type P0_R25_D4 = 0 else Don't care. 0d = supports minimum Hook button impedance of 150 Ωs for Hook Pressed Jack Insertion detection 1d = supports minimum Hook button impedance of 100 Ωs for Hook Pressed Jack Insertion detection 2d = supports minimum Hook button impedance of 50 Ωs for Hook Pressed Jack Insertion detection 3d = Reserved
3	HPDET_COUPLING	R/W	0b	Headphone detect coupling 0d = AC coupled 1d = DC coupled
2	HPDET_USE_2x_CURR	R/W	0b	Headset detect current sel config 0d = 2x current for headphone detection disabled 1d = 2x current for headphone detection enabled
1	JACK_DET_EN	R/W	0b	Headset Detection Enable 0d = Headset Detection Disabled 1d = Headset Detection Enabled
0	RESERVED	R	0b	Reserved bit; Write only reset value

### 7.5.2.9 JACK\_DET\_CFG2 Register (Address = 0x1B) [Reset = 0x00]

JACK\_DET\_CFG2 is shown in 表 7-117.

Return to the [Summary Table](#).

This register is the JACK DET configuration register 2.

**表 7-117. JACK\_DET\_CFG2 Register Field Descriptions**

Bit	Field	Type	Reset	Description
7	RESERVED	R	0b	Reserved bit; Write only reset value
6	HPDET_DEB	R/W	0b	Headphone Detection Debounce Programmability 0d = No Debounce 1d = Debounce of 3 detections
5-3	JACK_DET_DEB_INSERT[2:0]	R/W	000b	Headset Insert Detection Debounce Programmability 0d = Debounce Time = 16ms 1d = Debounce Time = 32ms 2d = Debounce Time = 64ms 3d = Debounce Time = 128ms 4d = Debounce Time = 256ms 5d = Debounce Time = 512ms 6d = Reserved. Do not use 7d = No Debounce
2	JACK_DET_DEB_REMOVE_VAL	R/W	0b	Headset Removal Detection Debounce Programmability 0d = Debounce of 5 detections 1d = Debounce of 3 detections
1-0	JACK_DET_DEB_HOOK_PRESS[1:0]	R/W	00b	Hook Press Debounce config 0d = No Debounce 1d = No Debounce 2d = Debounce of 2 detections 3d = Debounce of 3 detections

**7.5.2.10 JACK\_DET\_CFG3 Register (Address = 0x1C) [Reset = 0x00]**

JACK\_DET\_CFG3 is shown in [表 7-118](#).

Return to the [Summary Table](#).

This register is the JACK DET configuration register 3.

**表 7-118. JACK\_DET\_CFG3 Register Field Descriptions**

Bit	Field	Type	Reset	Description
7-6	JACK_TYPE_FLAG[1:0]	R	00b	Headset Jack type flag 0d = Jack is not inserted 1d = Jack is inserted without Microphone 2d = Reserved. Do not use 3d = Jack is inserted with Microphone
5-4	HEADSET_TYPE_DET[1:0]	R	00b	Headset type 0d = Headset is not inserted 1d = Jack is inserted with mono-HS (RIGHT) 2d = Jack is inserted with mono-HS (LEFT) 3d = Jack is inserted with stereo-HS
3-0	RESERVED	R	0000b	Reserved bits; Write only reset value

**7.5.2.11 LPSG\_CFG1 Register (Address = 0x1F) [Reset = 0x80]**

LPSG\_CFG1 is shown in [表 7-119](#).

Return to the [Summary Table](#).

Low Power Signal Generation configuration register 1

表 7-119. LPSG\_CFG1 Register Field Descriptions

Bit	Field	Type	Reset	Description
7-6	LPSG_CH_SEL[1:0]	R/W	10b	LPSG channel select.- UAG 0d = UAG activity is generated on channel 1 1d = UAG activity is generated on channel 2 2d = UAG activity is generated on channel 3 3d = UAG activity is generated on channel 4
5	RESERVED	R/W	0b	Reserved bit; Write only reset value
4-0	RESERVED	R	00000b	Reserved bits; Write only reset values

### 7.5.2.12 LIMITER\_CFG Register (Address = 0x23) [Reset = 0x00]

LIMITER\_CFG is shown in 表 7-120.

Return to the [Summary Table](#).

This register is configuration register 2 for Limiter.

表 7-120. LIMITER\_CFG Register Field Descriptions

Bit	Field	Type	Reset	Description
7-6	LIMITER_INP_SEL[1:0]	R/W	00b	Limiter input select config 0d = max(dacin_ch0, dacin_ch1) 1d = dacin_ch1 2d = dacin_ch0 3d = avg(dacin_ch0, dacin_ch1)
5-4	LIMITER_OUT_SEL[1:0]	R/W	00b	Limiter output select config 0d = applied on both 1d = dacin_ch1 2d = dacin_ch0 3d = applied none
3-0	RESERVED	R	0000b	Reserved bits; Write only reset values

### 7.5.2.13 PLIM\_CFG0 Register (Address = 0x2B) [Reset = 0x00]

PLIM\_CFG0 is shown in 表 7-121.

Return to the [Summary Table](#).

This register is configuration register 0 for PLIM.

表 7-121. PLIM\_CFG0 Register Field Descriptions

Bit	Field	Type	Reset	Description
7	EN_PLIM	R/W	0b	Enable PLIM 0d = Disable 1d = Enable
6-4	PLIM_ATTN_VAL[2:0]	R/W	000b	PLIM attenuation factor 0d = 0dB 1d = -6dB 2d = -12dB 3d = -18dB 4d = -24dB 5d = -30dB 6d = -36dB 7d = -42dB
3	PLIM_BY_SAR_GPA	R/W	0b	PLIM attenuation value source 0d = Plimit attenuation based on GPIO and reg_plimi_attn_val 1d = Plimit attenuation based on GPA Analog voltage. LUT will map SAR ADC data to Attenuation factor

表 7-121. PLIM\_CFG0 Register Field Descriptions (続き)

Bit	Field	Type	Reset	Description
2	PLIM_RECOVERY	R/W	0b	PLIM attenuation recovery 0d = Plimit func doesn't recover. It stays at same attenuation level or can apply more attenuation if required 1d = Plimit func recovers (reduces the attenuation) if "gpio_val=0" or "sar_adc_gpa" data suggest that Battery Voltage has recovered then we can reduce the attenuation being applied
1-0	RESERVED	R	00b	Reserved bits; Write only reset value

#### 7.5.2.14 MIXER\_CFG0 Register (Address = 0x2C) [Reset = 0x00]

MIXER\_CFG0 is shown in 表 7-122.

Return to the [Summary Table](#).

This register is the MISC configuration register 0.

表 7-122. MIXER\_CFG0 Register Field Descriptions

Bit	Field	Type	Reset	Description
7	EN_DAC_ASI_MIXER	R/W	0b	Enable DAC ASI Mixer 0b = Disabled 1b = Enabled
6	EN_SIDE_CHAIN_MIXER	R/W	0b	Enable Side Chain Mixer 0b = Disabled 1b = Enabled
5	RESERVED	R/W	0b	Reserved bit; Write only reset value
4	EN_LOOPBACK_MIXER	R/W	0b	Enable Loopback Mixer 0b = Disabled 1b = Enabled
3-0	RESERVED	R	0000b	Reserved bits; Write only reset value

#### 7.5.2.15 MISC\_CFG0 Register (Address = 0x2D) [Reset = 0x00]

MISC\_CFG0 is shown in 表 7-123.

Return to the [Summary Table](#).

This register is the MISC configuration register 0.

表 7-123. MISC\_CFG0 Register Field Descriptions

Bit	Field	Type	Reset	Description
7	EN_DISTORTION	R/W	0b	Distortion Limiter enable config 0b = Distortion Limiter disable 1b = Distortion Limiter enable
6	EN_BOP	R/W	0b	BOP enable config 0b = BOP disable 1b = BOP enable
5	EN_THERMAL_FOLDBACK	R/W	0b	Thermal Foldback enable config 0b = Thermal Foldback disable 1b = Thermal Foldback enable
4	EN_DRC	R/W	0b	DRC enable config 0b = DRC disable 1b = DRC enable
3	DAC_SIGNAL_GENERATOR_1_ENABLE	R/W	0b	DAC signal generator 1 enable config 0b = Signal generator disabled 1b = Signal generator enabled



**表 7-123. MISC\_CFG0 Register Field Descriptions (続き)**

Bit	Field	Type	Reset	Description
2	DAC_SIGNAL_GENERATOR_2_ENABLE	R/W	0b	DAC signal generator 2 enable config 0b = Signal generator disabled 1b = Signal generator enabled
1	DSP_VBAT_AVDD_SEL	R/W	0b	SAR data source select for DSP Limiter, BOP, DRC 0b = SAR VBAT data to DSP 1b = SAR AVDD data to DSP
0	BRWNOUT_EN	R/W	0b	Brownout enable config 0b = Brownout disable 1b = Brownout enable

#### 7.5.2.16 BRWNOUT Register (Address = 0x2E) [Reset = 0xBF]

BRWNOUT is shown in [表 7-124](#).

Return to the [Summary Table](#).

**表 7-124. BRWNOUT Register Field Descriptions**

Bit	Field	Type	Reset	Description
7-0	BRWNOUT_THRS[7:0]	R/W	10111111b	Threshold for brownout shutdown (IF P1_R45_D1->DSP_VBAT_AVDD_SEL=1) Default = 7.8V (~2.7V) $N_d = ((0.9 \times (N \times 16) / 4095) - 0.211764) \times 17$ (V) $((0.9 \times (N \times 16) / 4095) - 0.225) \times 6$ (V)

#### 7.5.2.17 INT\_MASK0 Register (Address = 0x2F) [Reset = 0xFF]

INT\_MASK0 is shown in [表 7-125](#).

Return to the [Summary Table](#).

Interrupt masks.

**表 7-125. INT\_MASK0 Register Field Descriptions**

Bit	Field	Type	Reset	Description
7	INT_MASK0	R/W	1b	Clock error interrupt mask. 0b = Don't Mask 1b = Mask
6	INT_MASK0	R/W	1b	PLL Lock interrupt mask. 0b = Don't Mask 1b = Mask
5	RESERVED	R/W	1b	Reserved bit; Write only reset value
4	RESERVED	R/W	1b	Reserved bit; Write only reset value
3	RESERVED	R/W	1b	Reserved bit; Write only reset value
2	RESERVED	R/W	1b	Reserved bit; Write only reset value
1	RESERVED	R/W	1b	Reserved bit; Write only reset value
0	RESERVED	R/W	1b	Reserved bit; Write only reset value

#### 7.5.2.18 INT\_MASK4 Register (Address = 0x32) [Reset = 0x00]

INT\_MASK4 is shown in [表 7-126](#).

Return to the [Summary Table](#).

Interrupt masks.

**表 7-126. INT\_MASK4 Register Field Descriptions**

Bit	Field	Type	Reset	Description
7	RESERVED	R/W	0b	Reserved bit; Write only reset value
6	RESERVED	R/W	0b	Reserved bit; Write only reset value
5	INT_MASK4	R/W	0b	OUT Short Circuit Fault Interrupt Mask. 0b = Don't Mask 1b = Mask
4	INT_MASK4	R/W	0b	DRVR Virtual Ground Fault Interrupt Mask. 0b = Don't Mask 1b = Mask
3	INT_MASK4	R/W	0b	Headset insert detection interrupt mask. 0b = Don't Mask 1b = Mask
2	INT_MASK4	R/W	0b	Headset remove detection interrupt mask. 0b = Don't Mask 1b = Mask
1	INT_MASK4	R/W	0b	Headset detection hook(button) interrupt mask. 0b = Don't Mask 1b = Mask
0	RESERVED	R/W	0b	Reserved bit; Write only reset value

**7.5.2.19 INT\_MASK5 Register (Address = 0x33) [Reset = 0x30]**

INT\_MASK5 is shown in [表 7-127](#).

Return to the [Summary Table](#).

Interrupt masks.

**表 7-127. INT\_MASK5 Register Field Descriptions**

Bit	Field	Type	Reset	Description
7	INT_MASK5	R/W	0b	GPA up threshold fault mask. 0b = Don't Mask 1b = Mask
6	INT_MASK5	R/W	0b	GPA low threshold fault mask. 0b = Don't Mask 1b = Mask
5	RESERVED	R/W	1b	Reserved bit; Write only reset value
4	RESERVED	R/W	1b	Reserved bit; Write only reset value
3	RESERVED	R/W	0b	Reserved bit; Write only reset value
2	RESERVED	R/W	0b	Reserved bit; Write only reset value
1	RESERVED	R/W	0b	Reserved bit; Write only reset value
0	RESERVED	R/W	0b	Reserved bit; Write only reset value

**7.5.2.20 INT\_LTCH0 Register (Address = 0x34) [Reset = 0x00]**

INT\_LTCH0 is shown in [表 7-128](#).

Return to the [Summary Table](#).

Latched interrupt readback.

表 7-128. INT\_LTCH0 Register Field Descriptions

Bit	Field	Type	Reset	Description
7	INT_LTCH0	R	0b	Interrupt due to clock error (self clearing bit). 0b = No interrupt 1b = Interrupt
6	INT_LTCH0	R	0b	Interrupt due to PLL Lock (self clearing bit) 0b = No interrupt 1b = Interrupt
5	RESERVED	R	0b	Reserved bit; Write only reset value
4	RESERVED	R	0b	Reserved bit; Write only reset value
3	RESERVED	R	0b	Reserved bit; Write only reset value
2	RESERVED	R	0b	Reserved bit; Write only reset value
1	RESERVED	R	0b	Reserved bit; Write only reset value
0	RESERVED	R	0b	Reserved bit; Write only reset value

### 7.5.2.21 CHx\_LTCH Register (Address = 0x35) [Reset = 0x00]

CHx\_LTCH is shown in 表 7-129.

Return to the [Summary Table](#).

Channel level Diagnostics Latched Status

表 7-129. CHx\_LTCH Register Field Descriptions

Bit	Field	Type	Reset	Description
7	RESERVED	R	0b	Reserved bit; Write only reset value
6	RESERVED	R	0b	Reserved bit; Write only reset value
5	STS_CHx_LTCH	R	0b	Status of Output CH1_LTCH. 0b = No faults occurred in output channel 1 1b = Fault or Faults have occurred in output channel 1
4	STS_CHx_LTCH	R	0b	Status of Output CH2_LTCH. 0b = No faults occurred in output channel 2 1b = Fault or Faults have occurred in output channel 2
3	RESERVED	R	0b	Reserved bit; Write only reset value
2	RESERVED	R	0b	Reserved bit; Write only reset value
1	RESERVED	R	0b	Reserved bit; Write only reset value
0	RESERVED	R	0b	Reserved bit; Write only reset value

### 7.5.2.22 OUT\_CH1\_LTCH Register (Address = 0x38) [Reset = 0x00]

OUT\_CH1\_LTCH is shown in 表 7-130.

Return to the [Summary Table](#).

表 7-130. OUT\_CH1\_LTCH Register Field Descriptions

Bit	Field	Type	Reset	Description
7	OUT_CH1_LTCH	R	0b	OUT1P Short Circuit Fault (self clearing bit). 0b = No short circuit fault 1b = Short circuit fault
6	OUT_CH1_LTCH	R	0b	OUT1M Short Circuit Fault (self clearing bit). 0b = No short circuit fault 1b = Short circuit fault
5	OUT_CH1_LTCH	R	0b	Channel 1 DRVRP Virtual Ground Fault (self clearing bit). 0b = No virtual ground fault 1b = Virtual ground fault

**表 7-130. OUT\_CH1\_LTCH Register Field Descriptions (続き)**

Bit	Field	Type	Reset	Description
4	OUT_CH1_LTCH	R	0b	Channel 1 DRVRM Virtual Ground Fault (self clearing bit). 0b = No virtual ground fault 1b = Virtual ground fault
3	RESERVED	R/W	0b	Reserved bit; Write only reset value
2	RESERVED	R/W	0b	Reserved bit; Write only reset value
1-0	RESERVED	R	00b	Reserved bits; Write only reset value

**7.5.2.23 OUT\_CH2\_LTCH Register (Address = 0x39) [Reset = 0x00]**

OUT\_CH2\_LTCH is shown in [表 7-131](#).

Return to the [Summary Table](#).

**表 7-131. OUT\_CH2\_LTCH Register Field Descriptions**

Bit	Field	Type	Reset	Description
7	OUT_CH2_LTCH	R	0b	OUT2P Short Circuit Fault (self clearing bit). 0b = No short circuit fault 1b = Short circuit fault
6	OUT_CH2_LTCH	R	0b	OUT2M Short Circuit Fault (self clearing bit). 0b = No short circuit fault 1b = Short circuit fault
5	OUT_CH2_LTCH	R	0b	Channel 2 DRVRP Virtual Ground Fault (self clearing bit). 0b = No virtual ground fault 1b = Virtual ground fault
4	OUT_CH2_LTCH	R	0b	Channel 2 DRVRM Virtual Ground Fault (self clearing bit). 0b = No virtual ground fault 1b = Virtual ground fault
3-2	RESERVED	R	00b	Reserved bits; Write only reset value
1	MASK_AREG_SC_FLAG	R/W	0b	AREG SC fault mask. 0b = Don't Mask 1b = Mask
0	AREG_SC_FLAG_LTCH	R	0b	AREG SC fault (self clearing bit). 0b = No AREG short circuit fault 1b = AREG short circuit fault

**7.5.2.24 INT\_LTCH1 Register (Address = 0x3A) [Reset = 0x00]**

INT\_LTCH1 is shown in [表 7-132](#).

Return to the [Summary Table](#).

Latched interrupt readback.

**表 7-132. INT\_LTCH1 Register Field Descriptions**

Bit	Field	Type	Reset	Description
7	RESERVED	R	0b	Reserved bit; Write only reset value
6	RESERVED	R	0b	Reserved bit; Write only reset value
5	RESERVED	R	0b	Reserved bit; Write only reset value
4	RESERVED	R	0b	Reserved bit; Write only reset value
3	INT_LTCH1	R	0b	Interrupt due to Headset Insert Detection (self clearing bit). 0b = No interrupt 1b = Interrupt

**表 7-132. INT\_LTCH1 Register Field Descriptions (続き)**

Bit	Field	Type	Reset	Description
2	INT_LTCH1	R	0b	Interrupt due to Headset Remove Detection (self clearing bit). 0b = No interrupt 1b = Interrupt
1	INT_LTCH1	R	0b	Interrupt due to Headset hook(button) (self clearing bit). 0b = No interrupt 1b = Interrupt
0	RESERVED	R	0b	Reserved bit; Write only reset value

#### 7.5.2.25 INT\_LTCH2 Register (Address = 0x3B) [Reset = 0x00]

INT\_LTCH2 is shown in [表 7-133](#).

Return to the [Summary Table](#).

Latched interrupt readback.

**表 7-133. INT\_LTCH2 Register Field Descriptions**

Bit	Field	Type	Reset	Description
7	INT_LTCH2	R	0b	Interrupt due to GPA up threshold fault (self clearing bit). 0b = No interrupt 1b = Interrupt
6	INT_LTCH2	R	0b	Interrupt due to GPA low threshold fault (self clearing bit). 0b = No interrupt 1b = Interrupt
5	RESERVED	R	0b	Reserved bit; Write only reset value
4	RESERVED	R	0b	Reserved bit; Write only reset value
3	RESERVED	R	0b	Reserved bit; Write only reset value
2	RESERVED	R	0b	Reserved bit; Write only reset value
1	RESERVED	R	0b	Reserved bit; Write only reset value
0	RESERVED	R	0b	Reserved bit; Write only reset value

#### 7.5.2.26 INT\_LIVE0 Register (Address = 0x3C) [Reset = 0x00]

INT\_LIVE0 is shown in [表 7-134](#).

Return to the [Summary Table](#).

Latched interrupt readback.

**表 7-134. INT\_LIVE0 Register Field Descriptions**

Bit	Field	Type	Reset	Description
7	INT_LIVE0	R	0b	Interrupt due to clock error . 0b = No interrupt 1b = Interrupt
6	INT_LIVE0	R	0b	Interrupt due to PLL Lock 0b = No interrupt 1b = Interrupt
5	RESERVED	R	0b	Reserved bit; Write only reset value
4	RESERVED	R	0b	Reserved bit; Write only reset value
3	RESERVED	R	0b	Reserved bit; Write only reset value
2	RESERVED	R	0b	Reserved bit; Write only reset value
1	RESERVED	R	0b	Reserved bit; Write only reset value

表 7-134. INT\_LIVE0 Register Field Descriptions (続き)

Bit	Field	Type	Reset	Description
0	RESERVED	R	0b	Reserved bit; Write only reset value

### 7.5.2.27 CHx\_LIVE Register (Address = 0x3D) [Reset = 0x00]

CHx\_LIVE is shown in [表 7-135](#).

Return to the [Summary Table](#).

Channel level Diagnostics Live Status

表 7-135. CHx\_LIVE Register Field Descriptions

Bit	Field	Type	Reset	Description
7	RESERVED	R	0b	Reserved bit; Write only reset value
6	RESERVED	R	0b	Reserved bit; Write only reset value
5	STS_CHx_LIVE	R	0b	Status of Output CH1_LIVE. 0b = No faults occurred in output channel 1 1b = Fault or Faults have occurred in output channel 1
4	STS_CHx_LIVE	R	0b	Status of Output CH2_LIVE. 0b = No faults occurred in output channel 2 1b = Fault or Faults have occurred in output channel 2
3	RESERVED	R	0b	Reserved bit; Write only reset value
2	RESERVED	R	0b	Reserved bit; Write only reset value
1	RESERVED	R	0b	Reserved bit; Write only reset value
0	RESERVED	R	0b	Reserved bit; Write only reset value

### 7.5.2.28 OUT\_CH1\_LIVE Register (Address = 0x40) [Reset = 0x00]

OUT\_CH1\_LIVE is shown in [表 7-136](#).

Return to the [Summary Table](#).

表 7-136. OUT\_CH1\_LIVE Register Field Descriptions

Bit	Field	Type	Reset	Description
7	OUT_CH1_LIVE	R	0b	OUT1P Short Circuit Fault . 0b = No short circuit fault 1b = Short circuit fault
6	OUT_CH1_LIVE	R	0b	OUT1M Short Circuit Fault . 0b = No short circuit fault 1b = Short circuit fault
5	OUT_CH1_LIVE	R	0b	Channel 1 DRVRP Virtual Ground Fault . 0b = No virtual ground fault 1b = Virtual ground fault
4	OUT_CH1_LIVE	R	0b	Channel 1 DRVRM Virtual Ground Fault . 0b = No virtual ground fault 1b = Virtual ground fault
3-0	RESERVED	R	0000b	Reserved bits; Write only reset value

### 7.5.2.29 OUT\_CH2\_LIVE Register (Address = 0x41) [Reset = 0x00]

OUT\_CH2\_LIVE is shown in [表 7-137](#).

Return to the [Summary Table](#).

**表 7-137. OUT\_CH2\_LIVE Register Field Descriptions**

Bit	Field	Type	Reset	Description
7	OUT_CH2_LIVE	R	0b	OUT2P Short Circuit Fault . 0b = No short circuit fault 1b = Short circuit fault
6	OUT_CH2_LIVE	R	0b	OUT2M Short Circuit Fault . 0b = No short circuit fault 1b = Short circuit fault
5	OUT_CH2_LIVE	R	0b	Channel 2 DRVRP Virtual Ground Fault . 0b = No virtual ground fault 1b = Virtual ground fault
4	OUT_CH2_LIVE	R	0b	Channel 2 DRVRM Virtual Ground Fault . 0b = No virtual ground fault 1b = Virtual ground fault
3-1	RESERVED	R	000b	Reserved bits; Write only reset value
0	AREG_SC_FLAG_LIVE	R	0b	AREG SC fault . 0b = No AREG short circuit fault 1b = AREG short circuit fault

### 7.5.2.30 INT\_LIVE1 Register (Address = 0x42) [Reset = 0x00]

INT\_LIVE1 is shown in [表 7-138](#).

Return to the [Summary Table](#).

Live interrupt readback.

**表 7-138. INT\_LIVE1 Register Field Descriptions**

Bit	Field	Type	Reset	Description
7	RESERVED	R	0b	Reserved bit; Write only reset value
6	RESERVED	R	0b	Reserved bit; Write only reset value
5	RESERVED	R	0b	Reserved bit; Write only reset value
4	RESERVED	R	0b	Reserved bit; Write only reset value
3	INT_LIVE1	R	0b	Interrupt due to Headset Insert Detection . 0b = No interrupt 1b = Interrupt
2	INT_LIVE1	R	0b	Interrupt due to Headset Remove Detection . 0b = No interrupt 1b = Interrupt
2	INT_LIVE1	R	0b	Interrupt due to Headset hook(button) . 0b = No interrupt 1b = Interrupt
1	RESERVED	R	0b	Reserved bit; Write only reset value
0	RESERVED	R	0b	

### 7.5.2.31 INT\_LIVE2 Register (Address = 0x43) [Reset = 0x00]

INT\_LIVE2 is shown in [表 7-139](#).

Return to the [Summary Table](#).

Live interrupt readback.

表 7-139. INT\_LIVE2 Register Field Descriptions

Bit	Field	Type	Reset	Description
7	INT_LIVE2	R	0b	Interrupt due to GPA up threshold fault . 0b = No interrupt 1b = Interrupt
6	INT_LIVE2	R	0b	Interrupt due to GPA low threshold fault 0b = No interrupt 1b = Interrupt
5	RESERVED	R	0b	Reserved bit; Write only reset value
4	RESERVED	R	0b	Reserved bit; Write only reset value
3	RESERVED	R	0b	Reserved bit; Write only reset value
2	RESERVED	R	0b	Reserved bit; Write only reset value
1	RESERVED	R	0b	Reserved bit; Write only reset value
0	RESERVED	R	0b	Reserved bit; Write only reset value

## 7.5.2.32 DIAG\_CFG8 Register (Address = 0x4E) [Reset = 0xBA]

DIAG\_CFG8 is shown in 表 7-140.

Return to the [Summary Table](#).

表 7-140. DIAG\_CFG8 Register Field Descriptions

Bit	Field	Type	Reset	Description
7-0	GPA_UP_THRS_FLT_TH RES[7:0]	R/W	10111010b	General Purpose Analog High Threshold Default = ~ 2.6V $nd = ((0.9 \times (N \times 16) / 4095) - 0.225) \times 6$ (V)

## 7.5.2.33 DIAG\_CFG9 Register (Address = 0x4F) [Reset = 0x4B]

DIAG\_CFG9 is shown in 表 7-141.

Return to the [Summary Table](#).

表 7-141. DIAG\_CFG9 Register Field Descriptions

Bit	Field	Type	Reset	Description
7-0	GPA_LOW_THRS_FLT_T HRES[7:0]	R/W	01001011b	General Purpose Analog Low Threshold Default = ~ 0.2V $nd = ((0.9 \times (N \times 16) / 4095) - 0.225) \times 6$ (V)

## 7.5.2.34 DIAG\_CFG14 Register (Address = 0x54) [Reset = 0x48]

DIAG\_CFG14 is shown in 表 7-142.

Return to the [Summary Table](#).

表 7-142. DIAG\_CFG14 Register Field Descriptions

Bit	Field	Type	Reset	Description
7	RESERVED	R	0b	Reserved bit; Write only reset value
6-5	AVDD_FILT_SEL[1:0]	R/W	10b	AVDD filter select 0d = 3.5MHz 1d = 200kHz 2d = 100kHz 3d = No filter
4	RESERVED	R/W	0b	Reserved bit; Write only reset value



表 7-142. DIAG\_CFG14 Register Field Descriptions (続き)

Bit	Field	Type	Reset	Description
3-2	VBAT_FILT_SEL[1:0]	R/W	10b	VBAT filter select 0d = 3.5MHz 1d = 200kHz 2d = 100kHz 3d = No filter
1	RESERVED	R/W	0b	Reserved bit; Write only reset value
0	RESERVED	R/W	0b	Reserved bit; Write only reset value

### 7.5.2.35 DIAGDATA\_CFG Register (Address = 0x55) [Reset = 0x00]

DIAGDATA\_CFG is shown in 表 7-143.

Return to the [Summary Table](#).

表 7-143. DIAGDATA\_CFG Register Field Descriptions

Bit	Field	Type	Reset	Description
7-4	RESERVED	R/W	0000b	Reserved bits; Write only reset values
3	RESERVED	R/W	0b	Reserved bit; Write only reset value
2	RESERVED	R/W	0b	Reserved bit; Write only reset value
1	OVRD_VBAT_TEMP_DATA	R/W	0b	Override VBAT and TEMP data 0b= Override Disabled 1b= Override Enabled
0	HOLD_SAR_DATA	R/W	0b	Hold SAR data update during register readback 0b= Data update is not held, Data register is continuously updated 1b= Data update is held, Data register readback can be done

### 7.5.2.36 DIAG\_MON\_MSB\_OUT1P Register (Address = 0x62) [Reset = 0x00]

DIAG\_MON\_MSB\_OUT1P is shown in 表 7-144.

Return to the [Summary Table](#).

表 7-144. DIAG\_MON\_MSB\_OUT1P Register Field Descriptions

Bit	Field	Type	Reset	Description
7-0	DIAG_MON_MSB_OUT_CH1P[7:0]	R	00000000b	Diagnostic SAR Monitor Data MSB Byte

### 7.5.2.37 DIAG\_MON\_LSB\_OUT1P Register (Address = 0x63) [Reset = 0x06]

DIAG\_MON\_LSB\_OUT1P is shown in 表 7-145.

Return to the [Summary Table](#).

表 7-145. DIAG\_MON\_LSB\_OUT1P Register Field Descriptions

Bit	Field	Type	Reset	Description
7-4	DIAG_MON_LSB_OUT_C_H1P[3:0]	R	0000b	Diagnostic SAR Monitor Data LSB Nibble
3-0	Channel[3:0]	R	0110b	Channel ID

### 7.5.2.38 DIAG\_MON\_MSB\_OUT1M Register (Address = 0x64) [Reset = 0x00]

DIAG\_MON\_MSB\_OUT1M is shown in 表 7-146.

Return to the [Summary Table](#).

**表 7-146. DIAG\_MON\_MSB\_OUT1M Register Field Descriptions**

Bit	Field	Type	Reset	Description
7-0	DIAG_MON_MSB_OUT_CH1N[7:0]	R	00000000b	Diagnostic SAR Monitor Data MSB Byte

#### 7.5.2.39 DIAG\_MON\_LSB\_OUT1M Register (Address = 0x65) [Reset = 0x07]

DIAG\_MON\_LSB\_OUT1M is shown in [表 7-147](#).

Return to the [Summary Table](#).

**表 7-147. DIAG\_MON\_LSB\_OUT1M Register Field Descriptions**

Bit	Field	Type	Reset	Description
7-4	DIAG_MON_LSB_OUT_C H1N[3:0]	R	0000b	Diagnostic SAR Monitor Data LSB Nibble
3-0	Channel[3:0]	R	0111b	Channel ID

#### 7.5.2.40 DIAG\_MON\_MSB\_OUT2P Register (Address = 0x66) [Reset = 0x00]

DIAG\_MON\_MSB\_OUT2P is shown in [表 7-148](#).

Return to the [Summary Table](#).

**表 7-148. DIAG\_MON\_MSB\_OUT2P Register Field Descriptions**

Bit	Field	Type	Reset	Description
7-0	DIAG_MON_MSB_OUT_CH2P[7:0]	R	00000000b	Diagnostic SAR Monitor Data MSB Byte

#### 7.5.2.41 DIAG\_MON\_LSB\_OUT2P Register (Address = 0x67) [Reset = 0x08]

DIAG\_MON\_LSB\_OUT2P is shown in [表 7-149](#).

Return to the [Summary Table](#).

**表 7-149. DIAG\_MON\_LSB\_OUT2P Register Field Descriptions**

Bit	Field	Type	Reset	Description
7-4	DIAG_MON_LSB_OUT_C H2P[3:0]	R	0000b	Diagnostic SAR Monitor Data LSB Nibble
3-0	Channel[3:0]	R	1000b	Channel ID

#### 7.5.2.42 DIAG\_MON\_MSB\_OUT2M Register (Address = 0x68) [Reset = 0x00]

DIAG\_MON\_MSB\_OUT2M is shown in [表 7-150](#).

Return to the [Summary Table](#).

**表 7-150. DIAG\_MON\_MSB\_OUT2M Register Field Descriptions**

Bit	Field	Type	Reset	Description
7-0	DIAG_MON_MSB_OUT_CH2N[7:0]	R	00000000b	Diagnostic SAR Monitor Data MSB Byte

#### 7.5.2.43 DIAG\_MON\_LSB\_OUT2M Register (Address = 0x69) [Reset = 0x09]

DIAG\_MON\_LSB\_OUT2M is shown in [表 7-151](#).

Return to the [Summary Table](#).

**表 7-151. DIAG\_MON\_LSB\_OUT2M Register Field Descriptions**

Bit	Field	Type	Reset	Description
7-4	DIAG_MON_LSB_OUT_C H2N[3:0]	R	0000b	Diagnostic SAR Monitor Data LSB Nibble
3-0	Channel[3:0]	R	1001b	Channel ID

#### 7.5.2.44 DIAG\_MON\_MSB\_TEMP Register (Address = 0x6A) [Reset = 0x00]

DIAG\_MON\_MSB\_TEMP is shown in [表 7-152](#).

Return to the [Summary Table](#).

**表 7-152. DIAG\_MON\_MSB\_TEMP Register Field Descriptions**

Bit	Field	Type	Reset	Description
7-0	DIAG_MON_MSB_TEMP[ 7:0]	R	00000000b	Diagnostic SAR Monitor Data MSB Byte

#### 7.5.2.45 DIAG\_MON\_LSB\_TEMP Register (Address = 0x6B) [Reset = 0x0A]

DIAG\_MON\_LSB\_TEMP is shown in [表 7-153](#).

Return to the [Summary Table](#).

**表 7-153. DIAG\_MON\_LSB\_TEMP Register Field Descriptions**

Bit	Field	Type	Reset	Description
7-4	DIAG_MON_LSB_TEMP[ 3:0]	R	0000b	Diagnostic SAR Monitor Data LSB Nibble
3-0	Channel[3:0]	R	1010b	Channel ID

#### 7.5.2.46 DIAG\_MON\_MSB\_AVDD Register (Address = 0x6E) [Reset = 0x00]

DIAG\_MON\_MSB\_AVDD is shown in [表 7-154](#).

Return to the [Summary Table](#).

**表 7-154. DIAG\_MON\_MSB\_AVDD Register Field Descriptions**

Bit	Field	Type	Reset	Description
7-0	DIAG_MON_MSB_AVDD[ 7:0]	R	00000000b	Diagnostic SAR Monitor Data MSB Byte

#### 7.5.2.47 DIAG\_MON\_LSB\_AVDD Register (Address = 0x6F) [Reset = 0x0C]

DIAG\_MON\_LSB\_AVDD is shown in [表 7-155](#).

Return to the [Summary Table](#).

**表 7-155. DIAG\_MON\_LSB\_AVDD Register Field Descriptions**

Bit	Field	Type	Reset	Description
7-4	DIAG_MON_LSB_AVDD[3 :0]	R	0000b	Diagnostic SAR Monitor Data LSB Nibble

表 7-155. DIAG\_MON\_LSB\_AVDD Register Field Descriptions (続き)

Bit	Field	Type	Reset	Description
3-0	Channel[3:0]	R	1100b	Channel ID

#### 7.5.2.48 DIAG\_MON\_MSB\_GPA Register (Address = 0x70) [Reset = 0x00]

DIAG\_MON\_MSB\_GPA is shown in [表 7-156](#).

Return to the [Summary Table](#).

表 7-156. DIAG\_MON\_MSB\_GPA Register Field Descriptions

Bit	Field	Type	Reset	Description
7-0	DIAG_MON_MSB_GPA[7:0]	R	00000000b	Diagnostic SAR Monitor Data MSB Byte

#### 7.5.2.49 DIAG\_MON\_LSB\_GPA Register (Address = 0x71) [Reset = 0x0D]

DIAG\_MON\_LSB\_GPA is shown in [表 7-157](#).

Return to the [Summary Table](#).

表 7-157. DIAG\_MON\_LSB\_GPA Register Field Descriptions

Bit	Field	Type	Reset	Description
7-4	DIAG_MON_LSB_GPA[3:0]	R	0000b	Diagnostic SAR Monitor Data LSB Nibble
3-0	Channel[3:0]	R	1101b	Channel ID

### 7.5.3 TAD5212\_P3 Registers

表 7-158 lists the memory-mapped registers for the TAD5212\_P3 registers. All register offset addresses not listed in 表 7-158 should be considered as reserved locations and the register contents should not be modified.

**表 7-158. TAD5212\_P3 Registers**

Address	Acronym	Register Name	Reset Value	Section
0x0	PAGE_CFG	Device page register	0x00	PAGE_CFG Register (Address = 0x0) [Reset = 0x00]
0x1A	SASI_CFG0	Secondary ASI configuration register 0	0x30	SASI_CFG0 Register (Address = 0x1A) [Reset = 0x30]
0x1B	SASI_TX_CFG0	SASI TX configuration register 0	0x00	SASI_TX_CFG0 Register (Address = 0x1B) [Reset = 0x00]
0x1C	SASI_TX_CFG1	SASI TX configuration register 1	0x00	SASI_TX_CFG1 Register (Address = 0x1C) [Reset = 0x00]
0x1D	SASI_TX_CFG2	SASI TX configuration register 2	0x00	SASI_TX_CFG2 Register (Address = 0x1D) [Reset = 0x00]
0x20	SASI_TX_CH3_CFG	SASI TX Channel 3 configuration register	0x02	SASI_TX_CH3_CFG Register (Address = 0x20) [Reset = 0x02]
0x21	SASI_TX_CH4_CFG	SASI TX Channel 4 configuration register	0x03	SASI_TX_CH4_CFG Register (Address = 0x21) [Reset = 0x03]
0x22	SASI_TX_CH5_CFG	SASI TX Channel 5 configuration register	0x04	SASI_TX_CH5_CFG Register (Address = 0x22) [Reset = 0x04]
0x23	SASI_TX_CH6_CFG	SASI TX Channel 6 configuration register	0x05	SASI_TX_CH6_CFG Register (Address = 0x23) [Reset = 0x05]
0x24	SASI_TX_CH7_CFG	SASI TX Channel 7 configuration register	0x06	SASI_TX_CH7_CFG Register (Address = 0x24) [Reset = 0x06]
0x25	SASI_TX_CH8_CFG	SASI TX Channel 8 configuration register	0x07	SASI_TX_CH8_CFG Register (Address = 0x25) [Reset = 0x07]
0x26	SASI_RX_CFG0	SASI RX configuration register 0	0x00	SASI_RX_CFG0 Register (Address = 0x26) [Reset = 0x00]
0x27	SASI_RX_CFG1	SASI RX configuration register 1	0x00	SASI_RX_CFG1 Register (Address = 0x27) [Reset = 0x00]
0x28	SASI_RX_CH1_CFG	SASI RX Channel 1 configuration register	0x00	SASI_RX_CH1_CFG Register (Address = 0x28) [Reset = 0x00]

表 7-158. TAD5212\_P3 Registers (続き)

Address	Acronym	Register Name	Reset Value	Section
0x29	SASI_RX_CH2_CFG	SASI RX Channel 2 configuration register	0x01	SASI_RX_CH2_CFG Register (Address = 0x29) [Reset = 0x01]
0x2A	SASI_RX_CH3_CFG	SASI RX Channel 3 configuration register	0x02	SASI_RX_CH3_CFG Register (Address = 0x2A) [Reset = 0x02]
0x2B	SASI_RX_CH4_CFG	SASI RX Channel 4 configuration register	0x03	SASI_RX_CH4_CFG Register (Address = 0x2B) [Reset = 0x03]
0x2C	SASI_RX_CH5_CFG	SASI RX Channel 5 configuration register	0x04	SASI_RX_CH5_CFG Register (Address = 0x2C) [Reset = 0x04]
0x2D	SASI_RX_CH6_CFG	SASI RX Channel 6 configuration register	0x05	SASI_RX_CH6_CFG Register (Address = 0x2D) [Reset = 0x05]
0x2E	SASI_RX_CH7_CFG	SASI RX Channel 7 configuration register	0x06	SASI_RX_CH7_CFG Register (Address = 0x2E) [Reset = 0x06]
0x2F	SASI_RX_CH8_CFG	SASI RX Channel 8 configuration register	0x07	SASI_RX_CH8_CFG Register (Address = 0x2F) [Reset = 0x07]
0x32	CLK_CFG12	Clock configuration register 12	0x00	CLK_CFG12 Register (Address = 0x32) [Reset = 0x00]
0x33	CLK_CFG13	Clock configuration register 13	0x00	CLK_CFG13 Register (Address = 0x33) [Reset = 0x00]
0x34	CLK_CFG14	Clock configuration register 14	0x10	CLK_CFG14 Register (Address = 0x34) [Reset = 0x10]
0x35	CLK_CFG15	Clock configuration register 15	0x01	CLK_CFG15 Register (Address = 0x35) [Reset = 0x01]
0x36	CLK_CFG16	Clock configuration register 16	0x00	CLK_CFG16 Register (Address = 0x36) [Reset = 0x00]
0x37	CLK_CFG17	Clock configuration register 17	0x00	CLK_CFG17 Register (Address = 0x37) [Reset = 0x00]
0x38	CLK_CFG18	Clock configuration register 18	0x08	CLK_CFG18 Register (Address = 0x38) [Reset = 0x08]
0x39	CLK_CFG19	Clock configuration register 19	0x20	CLK_CFG19 Register (Address = 0x39) [Reset = 0x20]
0x3A	CLK_CFG20	Clock configuration register 20	0x04	CLK_CFG20 Register (Address = 0x3A) [Reset = 0x04]

表 7-158. TAD5212\_P3 Registers (続き)

Address	Acronym	Register Name	Reset Value	Section
0x3B	CLK_CFG21	Clock configuration register 21	0x00	<a href="#">CLK_CFG21 Register (Address = 0x3B) [Reset = 0x00]</a>
0x3C	CLK_CFG22	Clock configuration register 18	0x01	<a href="#">CLK_CFG22 Register (Address = 0x3C) [Reset = 0x01]</a>
0x3D	CLK_CFG23	Clock configuration register 18	0x01	<a href="#">CLK_CFG23 Register (Address = 0x3D) [Reset = 0x01]</a>
0x3E	CLK_CFG24	Clock configuration register 21	0x01	<a href="#">CLK_CFG24 Register (Address = 0x3E) [Reset = 0x01]</a>
0x44	CLK_CFG30		0x00	<a href="#">CLK_CFG30 Register (Address = 0x44) [Reset = 0x00]</a>
0x45	CLK_CFG31		0x00	<a href="#">CLK_CFG31 Register (Address = 0x45) [Reset = 0x00]</a>
0x46	CLKOUT_CFG1	CLKOUT configuration register 1	0x00	<a href="#">CLKOUT_CFG1 Register (Address = 0x46) [Reset = 0x00]</a>
0x47	CLKOUT_CFG2	CLKOUT configuration register 2	0x01	<a href="#">CLKOUT_CFG2 Register (Address = 0x47) [Reset = 0x01]</a>
0x49	SARCLK_CFG1	SAR clock configuration register 1	0x00	<a href="#">SARCLK_CFG1 Register (Address = 0x49) [Reset = 0x00]</a>

### 7.5.3.1 PAGE\_CFG Register (Address = 0x0) [Reset = 0x00]

PAGE\_CFG is shown in [表 7-159](#).

Return to the [Summary Table](#).

The device memory map is divided into pages. This register sets the page.

表 7-159. PAGE\_CFG Register Field Descriptions

Bit	Field	Type	Reset	Description
7-0	PAGE[7:0]	R/W	00000000b	These bits set the device page. 0d = Page 0 1d = Page 1 2d to 254d = Page 2 to page 254 respectively 255d = Page 255

### 7.5.3.2 SASI\_CFG0 Register (Address = 0x1A) [Reset = 0x30]

SASI\_CFG0 is shown in [表 7-160](#).

Return to the [Summary Table](#).

This register is the ASI configuration register 0.

表 7-160. SASI\_CFG0 Register Field Descriptions

Bit	Field	Type	Reset	Description
7-6	SASI_FORMAT[1:0]	R/W	00b	Secondary ASI protocol format. 0d = TDM mode 1d = I <sup>2</sup> S mode 2d = LJ (left-justified) mode 3d = Reserved; Don't use
5-4	SASI_WLEN[1:0]	R/W	11b	Secondary ASI word or slot length. 0d = 16 bits (Recommended this setting to be used with 10-kΩ input impedance configuration) 1d = 20 bits 2d = 24 bits 3d = 32 bits
3	SASI_FSYNC_POL	R/W	0b	ASI FSYNC polarity (for SASI protocol only). 0d = Default polarity as per standard protocol 1d = Inverted polarity with respect to standard protocol
2	SASI_BCLK_POL	R/W	0b	ASI BCLK polarity (for SASI protocol only). 0d = Default polarity as per standard protocol 1d = Inverted polarity with respect to standard protocol
1	SASI_BUS_ERR	R/W	0b	ASI bus error detection. 0d = Enable bus error detection 1d = Disable bus error detection
0	SASI_BUS_ERR_RCOV	R/W	0b	ASI bus error auto resume. 0d = Enable auto resume after bus error recovery 1d = Disable auto resume after bus error recovery and remain powered down until host configures the device

### 7.5.3.3 SASI\_TX\_CFG0 Register (Address = 0x1B) [Reset = 0x00]

SASI\_TX\_CFG0 is shown in 表 7-161.

Return to the [Summary Table](#).

This register is the SASI TX configuration register 0.

表 7-161. SASI\_TX\_CFG0 Register Field Descriptions

Bit	Field	Type	Reset	Description
7	SASI_TX_EDGE	R/W	0b	Secondary ASI data output (on the primary and secondary data pin) transmit edge. 0d = Default edge as per the protocol configuration setting in SASI_BCLK_POL 1d = Inverted following edge (half cycle delay) with respect to the default edge setting
6	SASI_TX_FILL	R/W	0b	Secondary ASI data output (on the primary and secondary data pin) for any unused cycles 0d = Always transmit 0 for unused cycles 1d = Always use Hi-Z for unused cycles
5	SASI_TX_LSB	R/W	0b	Secondary ASI data output (on the primary and secondary data pin) for LSB transmissions. 0d = Transmit the LSB for a full cycle 1d = Transmit the LSB for the first half cycle and Hi-Z for the second half cycle
4-3	SASI_TX_KEEPER[1:0]	R/W	00b	Secondary ASI data output (on the primary and secondary data pin) bus keeper. 0d = Bus keeper is always disabled 1d = Bus keeper is always enabled 2d = Bus keeper is enabled during LSB transmissions only for one cycle 3d = Bus keeper is enabled during LSB transmissions only for one and half cycles



表 7-161. SASI\_TX\_CFG0 Register Field Descriptions (続き)

Bit	Field	Type	Reset	Description
2	SASI_TX_USE_INT_FSYNC	R/W	0b	Secondary ASI uses internal FSYNC for output data generation in controller mode configuration as applicable. 0d = Use external FSYNC for ASI protocol data generation 1d = Use internal FSYNC for ASI protocol data generation
1	SASI_TX_USE_INT_BCLK	R/W	0b	Secondary ASI uses internal BCLK for output data generation in controller mode configuration. 0d = Use external BCLK for ASI protocol data generation 1d = Use internal BCLK for ASI protocol data generation
0	SASI_TDM_PULSE_WIDTH	R/W	0b	Secondary ASI fsync pulse width in TDM format. 0d = Fsync pulse is 1 bclk period wide 1d = Fsync pulse is 2 bclk period wide

#### 7.5.3.4 SASI\_TX\_CFG1 Register (Address = 0x1C) [Reset = 0x00]

SASI\_TX\_CFG1 is shown in 表 7-162.

Return to the [Summary Table](#).

This register is the SASI TX configuration register 1.

表 7-162. SASI\_TX\_CFG1 Register Field Descriptions

Bit	Field	Type	Reset	Description
7-5	RESERVED	R	000b	Reserved bits; Write only reset value
4-0	SASI_TX_OFFSET[4:0]	R/W	00000b	Secondary ASI output data MSB slot 0 offset (on the primary and secondary data pin). 0d = ASI data MSB location has no offset and is as per standard protocol 1d = ASI data MSB location (TDM mode is slot 0 or I <sup>2</sup> S, LJ mode is the left and right slot 0) offset of one BCLK cycle with respect to standard protocol 2d = ASI data MSB location (TDM mode is slot 0 or I <sup>2</sup> S, LJ mode is the left and right slot 0) offset of two BCLK cycles with respect to standard protocol 3d to 30d = ASI data MSB location (TDM mode is slot 0 or I <sup>2</sup> S, LJ mode is the left and right slot 0) offset assigned as per configuration 31d = ASI data MSB location (TDM mode is slot 0 or I <sup>2</sup> S, LJ mode is the left and right slot 0) offset of 31 BCLK cycles with respect to standard protocol

#### 7.5.3.5 SASI\_TX\_CFG2 Register (Address = 0x1D) [Reset = 0x00]

SASI\_TX\_CFG2 is shown in 表 7-163.

Return to the [Summary Table](#).

This register is the SASI TX configuration register 2.

表 7-163. SASI\_TX\_CFG2 Register Field Descriptions

Bit	Field	Type	Reset	Description
7	SASI_TX_CH8_SEL	R/W	0b	Secondary ASI output channel 8 select. 0d = Secondary ASI channel 8 output is on DOUT 1d = Secondary ASI channel 8 output is on DOUT2
6	SASI_TX_CH7_SEL	R/W	0b	Secondary ASI output channel 7 select. 0d = Secondary ASI channel 7 output is on DOUT 1d = Secondary ASI channel 7 output is on DOUT2
5	SASI_TX_CH6_SEL	R/W	0b	Secondary ASI output channel 6 select. 0d = Secondary ASI channel 6 output is on DOUT 1d = Secondary ASI channel 6 output is on DOUT2

表 7-163. SASI\_TX\_CFG2 Register Field Descriptions (続き)

Bit	Field	Type	Reset	Description
4	SASI_TX_CH5_SEL	R/W	0b	Secondary ASI output channel 5 select. 0d = Secondary ASI channel 5 output is on DOUT 1d = Secondary ASI channel 5 output is on DOUT2
3	SASI_TX_CH4_SEL	R/W	0b	Secondary ASI output channel 4 select. 0d = Secondary ASI channel 4 output is on DOUT 1d = Secondary ASI channel 4 output is on DOUT2
2	SASI_TX_CH3_SEL	R/W	0b	Secondary ASI output channel 3 select. 0d = Secondary ASI channel 3 output is on DOUT 1d = Secondary ASI channel 3 output is on DOUT2
1	RESERVED	R/W	0b	Reserved bit; Write only reset value
0	RESERVED	R/W	0b	Reserved bit; Write only reset value

### 7.5.3.6 SASI\_TX\_CH3\_CFG Register (Address = 0x20) [Reset = 0x02]

SASI\_TX\_CH3\_CFG is shown in 表 7-164.

Return to the [Summary Table](#).

This register is the SASI TX Channel 3 configuration register.

表 7-164. SASI\_TX\_CH3\_CFG Register Field Descriptions

Bit	Field	Type	Reset	Description
7	RESERVED	R	0b	Reserved bit; Write only reset value
6-5	SASI_TX_CH3_CFG[1:0]	R/W	00b	Secondary ASI output channel 3 configuration. 0d = Secondary ASI channel 3 output is in a tri-state condition Dont use 2d = Secondary ASI channel 3 output corresponds to VBAT data 3d = Reserved
4-0	SASI_TX_CH3_SLOT_NUM[4:0]	R/W	00010b	Secondary ASI output channel 3 slot assignment. 0d = TDM is slot 0 or I <sup>2</sup> S, LJ is left slot 0 1d = TDM is slot 1 or I <sup>2</sup> S, LJ is left slot 1 2d to 14d = Slot assigned as per configuration 15d = TDM is slot 15 or I <sup>2</sup> S, LJ is left slot 15 16d = TDM is slot 16 or I <sup>2</sup> S, LJ is right slot 0 17d = TDM is slot 17 or I <sup>2</sup> S, LJ is right slot 1 18d to 30d = Slot assigned as per configuration 31d = TDM is slot 31 or I <sup>2</sup> S, LJ is right slot 15

### 7.5.3.7 SASI\_TX\_CH4\_CFG Register (Address = 0x21) [Reset = 0x03]

SASI\_TX\_CH4\_CFG is shown in 表 7-165.

Return to the [Summary Table](#).

This register is the SASI TX Channel 4 configuration register.

表 7-165. SASI\_TX\_CH4\_CFG Register Field Descriptions

Bit	Field	Type	Reset	Description
7	RESERVED	R	0b	Reserved bit; Write only reset value
6-5	SASI_TX_CH4_CFG[1:0]	R/W	00b	Secondary ASI output channel 4 configuration. 0d = Secondary ASI channel 4 output is in a tri-state condition Dont use 2d = Secondary ASI channel 4 output corresponds to TEMP data 3d = Reserved

表 7-165. SASI\_TX\_CH4\_CFG Register Field Descriptions (続き)

Bit	Field	Type	Reset	Description
4-0	SASI_TX_CH4_SLOT_NUM[4:0]	R/W	00011b	Secondary ASI output channel 4 slot assignment. 0d = TDM is slot 0 or I <sup>2</sup> S, LJ is left slot 0 1d = TDM is slot 1 or I <sup>2</sup> S, LJ is left slot 1 2d to 14d = Slot assigned as per configuration 15d = TDM is slot 15 or I <sup>2</sup> S, LJ is left slot 15 16d = TDM is slot 16 or I <sup>2</sup> S, LJ is right slot 0 17d = TDM is slot 17 or I <sup>2</sup> S, LJ is right slot 1 18d to 30d = Slot assigned as per configuration 31d = TDM is slot 31 or I <sup>2</sup> S, LJ is right slot 15

### 7.5.3.8 SASI\_TX\_CH5\_CFG Register (Address = 0x22) [Reset = 0x04]

SASI\_TX\_CH5\_CFG is shown in 表 7-166.

Return to the [Summary Table](#).

This register is the SASI TX Channel 5 configuration register.

表 7-166. SASI\_TX\_CH5\_CFG Register Field Descriptions

Bit	Field	Type	Reset	Description
7	RESERVED	R	0b	Reserved bit; Write only reset value
6-5	SASI_TX_CH5_CFG[1:0]	R/W	00b	Secondary ASI output channel 5 configuration. 0d = Secondary ASI channel 5 output is in a tri-state condition 1d = Secondary ASI channel 5 output corresponds to ASI Input Channel 1 loopback data 2d = Secondary ASI channel 5 output corresponds to echo reference channel 1 data 3d = Reserved
4-0	SASI_TX_CH5_SLOT_NUM[4:0]	R/W	00100b	Secondary ASI output channel 5 slot assignment. 0d = TDM is slot 0 or I <sup>2</sup> S, LJ is left slot 0 1d = TDM is slot 1 or I <sup>2</sup> S, LJ is left slot 1 2d to 14d = Slot assigned as per configuration 15d = TDM is slot 15 or I <sup>2</sup> S, LJ is left slot 15 16d = TDM is slot 16 or I <sup>2</sup> S, LJ is right slot 0 17d = TDM is slot 17 or I <sup>2</sup> S, LJ is right slot 1 18d to 30d = Slot assigned as per configuration 31d = TDM is slot 31 or I <sup>2</sup> S, LJ is right slot 15

### 7.5.3.9 SASI\_TX\_CH6\_CFG Register (Address = 0x23) [Reset = 0x05]

SASI\_TX\_CH6\_CFG is shown in 表 7-167.

Return to the [Summary Table](#).

This register is the SASI TX Channel 6 configuration register.

表 7-167. SASI\_TX\_CH6\_CFG Register Field Descriptions

Bit	Field	Type	Reset	Description
7	RESERVED	R	0b	Reserved bit; Write only reset value
6-5	SASI_TX_CH6_CFG[1:0]	R/W	00b	Secondary ASI output channel 6 configuration. 0d = Secondary ASI channel 6 output is in a tri-state condition 1d = Secondary ASI channel 6 output corresponds to ASI Input Channel 2 loopback data 2d = Secondary ASI channel 6 output corresponds to echo reference channel 2 data 3d = Reserved

**表 7-167. SASI\_TX\_CH6\_CFG Register Field Descriptions (続き)**

Bit	Field	Type	Reset	Description
4-0	SASI_TX_CH6_SLOT_NUM[4:0]	R/W	00101b	Secondary ASI output channel 6 slot assignment. 0d = TDM is slot 0 or I <sup>2</sup> S, LJ is left slot 0 1d = TDM is slot 1 or I <sup>2</sup> S, LJ is left slot 1 2d to 14d = Slot assigned as per configuration 15d = TDM is slot 15 or I <sup>2</sup> S, LJ is left slot 15 16d = TDM is slot 16 or I <sup>2</sup> S, LJ is right slot 0 17d = TDM is slot 17 or I <sup>2</sup> S, LJ is right slot 1 18d to 30d = Slot assigned as per configuration 31d = TDM is slot 31 or I <sup>2</sup> S, LJ is right slot 15

### 7.5.3.10 SASI\_TX\_CH7\_CFG Register (Address = 0x24) [Reset = 0x06]

SASI\_TX\_CH7\_CFG is shown in [表 7-168](#).

Return to the [Summary Table](#).

This register is the SASI TX Channel 7 configuration register.

**表 7-168. SASI\_TX\_CH7\_CFG Register Field Descriptions**

Bit	Field	Type	Reset	Description
7	RESERVED	R	0b	Reserved bit; Write only reset value
6-5	SASI_TX_CH7_CFG[1:0]	R/W	00b	Secondary ASI output channel 7 configuration. 0d = Secondary ASI channel 7 output is in a tri-state condition 1d = Secondary ASI channel 7 output corresponds to {VBAT_WLby2, TEMP_WLby2} 2d = Secondary ASI channel 7 output corresponds to {echo_ref_ch1_wlby2, echo_ref_ch2_wlby2} 3d = Reserved
4-0	SASI_TX_CH7_SLOT_NUM[4:0]	R/W	00110b	Secondary ASI output channel 7 slot assignment. 0d = TDM is slot 0 or I <sup>2</sup> S, LJ is left slot 0 1d = TDM is slot 1 or I <sup>2</sup> S, LJ is left slot 1 2d to 14d = Slot assigned as per configuration 15d = TDM is slot 15 or I <sup>2</sup> S, LJ is left slot 15 16d = TDM is slot 16 or I <sup>2</sup> S, LJ is right slot 0 17d = TDM is slot 17 or I <sup>2</sup> S, LJ is right slot 1 18d to 30d = Slot assigned as per configuration 31d = TDM is slot 31 or I <sup>2</sup> S, LJ is right slot 15

### 7.5.3.11 SASI\_TX\_CH8\_CFG Register (Address = 0x25) [Reset = 0x07]

SASI\_TX\_CH8\_CFG is shown in [表 7-169](#).

Return to the [Summary Table](#).

This register is the SASI TX Channel 8 configuration register.

**表 7-169. SASI\_TX\_CH8\_CFG Register Field Descriptions**

Bit	Field	Type	Reset	Description
7-6	RESERVED	R	00b	Reserved bits; Write only reset value
5	SASI_TX_CH8_CFG	R/W	0b	Secondary ASI output channel 8 configuration. 0d = Secondary ASI channel 8 output is in a tri-state condition 1d = Secondary ASI channel 8 output corresponds to ICLA data

表 7-169. SASI\_TX\_CH8\_CFG Register Field Descriptions (続き)

Bit	Field	Type	Reset	Description
4-0	SASI_TX_CH8_SLOT_NUM[4:0]	R/W	00111b	Secondary ASI output channel 8 slot assignment. 0d = TDM is slot 0 or I <sup>2</sup> S, LJ is left slot 0 1d = TDM is slot 1 or I <sup>2</sup> S, LJ is left slot 1 2d to 14d = Slot assigned as per configuration 15d = TDM is slot 15 or I <sup>2</sup> S, LJ is left slot 15 16d = TDM is slot 16 or I <sup>2</sup> S, LJ is right slot 0 17d = TDM is slot 17 or I <sup>2</sup> S, LJ is right slot 1 18d to 30d = Slot assigned as per configuration 31d = TDM is slot 31 or I <sup>2</sup> S, LJ is right slot 15

### 7.5.3.12 SASI\_RX\_CFG0 Register (Address = 0x26) [Reset = 0x00]

SASI\_RX\_CFG0 is shown in 表 7-170.

Return to the [Summary Table](#).

This register is the SASI RX configuration register 0.

表 7-170. SASI\_RX\_CFG0 Register Field Descriptions

Bit	Field	Type	Reset	Description
7	SASI_RX_EDGE	R/W	0b	Secondary ASI data input (on the primary and secondary data pin) receive edge. 0d = Default edge as per the protocol configuration setting in bit 2 (BCLK_POL) 1d = Inverted following edge (half cycle delay) with respect to the default edge setting
6	SASI_RX_USE_INT_FSYNC	R/W	0b	Secondary ASI uses internal FSYNC for input data latching in controller mode configuration as applicable. 0d = Use external FSYNC for ASI protocol data latching 1d = Use internal FSYNC for ASI protocol data latching
5	SASI_RX_USE_INT_BCLK	R/W	0b	Secondary ASI uses internal BCLK for input data latching in controller mode configuration. 0d = Use external BCLK for ASI protocol data latching 1d = Use internal BCLK for ASI protocol data latching
4-0	SASI_RX_OFFSET[4:0]	R/W	00000b	Secondary ASI data input MSB slot 0 offset (on the primary and secondary data pin). 0d = ASI data MSB location has no offset and is as per standard protocol 1d = ASI data MSB location (TDM mode is slot 0 or I <sup>2</sup> S, LJ mode is the left and right slot 0) offset of one BCLK cycle with respect to standard protocol 2d = ASI data MSB location (TDM mode is slot 0 or I <sup>2</sup> S, LJ mode is the left and right slot 0) offset of two BCLK cycles with respect to standard protocol 3d to 30d = ASI data MSB location (TDM mode is slot 0 or I <sup>2</sup> S, LJ mode is the left and right slot 0) offset assigned as per configuration 31d = ASI data MSB location (TDM mode is slot 0 or I <sup>2</sup> S, LJ mode is the left and right slot 0) offset of 31 BCLK cycles with respect to standard protocol

### 7.5.3.13 SASI\_RX\_CFG1 Register (Address = 0x27) [Reset = 0x00]

SASI\_RX\_CFG1 is shown in 表 7-171.

Return to the [Summary Table](#).

This register is the SASI RX configuration register 1.

**表 7-171. SASI\_RX\_CFG1 Register Field Descriptions**

Bit	Field	Type	Reset	Description
7	SASI_RX_CH8_SEL	R/W	0b	Secondary ASI input channel 8 select. 0d = Secondary ASI channel 8 input is on DIN 1d = Secondary ASI channel 8 input is on DIN2
6	SASI_RX_CH7_SEL	R/W	0b	Secondary ASI input channel 7 select. 0d = Secondary ASI channel 7 input is on DIN 1d = Secondary ASI channel 7 input is on DIN2
5	SASI_RX_CH6_SEL	R/W	0b	Secondary ASI input channel 6 select. 0d = Secondary ASI channel 6 input is on DIN 1d = Secondary ASI channel 6 input is on DIN2
4	SASI_RX_CH5_SEL	R/W	0b	Secondary ASI input channel 5 select. 0d = Secondary ASI channel 5 input is on DIN 1d = Secondary ASI channel 5 input is on DIN2
3	SASI_RX_CH4_SEL	R/W	0b	Secondary ASI input channel 4 select. 0d = Secondary ASI channel 4 input is on DIN 1d = Secondary ASI channel 4 input is on DIN2
2	SASI_RX_CH3_SEL	R/W	0b	Secondary ASI input channel 3 select. 0d = Secondary ASI channel 3 input is on DIN 1d = Secondary ASI channel 3 input is on DIN2
1	SASI_RX_CH2_SEL	R/W	0b	Secondary ASI input channel 2 select. 0d = Secondary ASI channel 2 input is on DIN 1d = Secondary ASI channel 2 input is on DIN2
0	SASI_RX_CH1_SEL	R/W	0b	Secondary ASI input channel 1 select. 0d = Secondary ASI channel 1 input is on DIN 1d = Secondary ASI channel 1 input is on DIN2

**7.5.3.14 SASI\_RX\_CH1\_CFG Register (Address = 0x28) [Reset = 0x00]**

SASI\_RX\_CH1\_CFG is shown in [表 7-172](#).

Return to the [Summary Table](#).

This register is the SASI RX Channel 1 configuration register.

**表 7-172. SASI\_RX\_CH1\_CFG Register Field Descriptions**

Bit	Field	Type	Reset	Description
7-6	RESERVED	R	00b	Reserved bits; Write only reset value
5	SASI_RX_CH1_CFG	R/W	0b	Secondary ASI input channel 1 configuration. 0d = Secondary ASI channel 1 input is disabled 1d = Secondary ASI channel 1 input corresponds to DAC Channel 1 data
4-0	SASI_RX_CH1_SLOT_NUM[4:0]	R/W	00000b	Secondary ASI input channel 1 slot assignment. 0d = TDM is slot 0 or I <sup>2</sup> S, LJ is left slot 0 1d = TDM is slot 1 or I <sup>2</sup> S, LJ is left slot 1 2d to 14d = Slot assigned as per configuration 15d = TDM is slot 15 or I <sup>2</sup> S, LJ is left slot 15 16d = TDM is slot 16 or I <sup>2</sup> S, LJ is right slot 0 17d = TDM is slot 17 or I <sup>2</sup> S, LJ is right slot 1 18d to 30d = Slot assigned as per configuration 31d = TDM is slot 31 or I <sup>2</sup> S, LJ is right slot 15

**7.5.3.15 SASI\_RX\_CH2\_CFG Register (Address = 0x29) [Reset = 0x01]**

SASI\_RX\_CH2\_CFG is shown in [表 7-173](#).

Return to the [Summary Table](#).

This register is the SASI RX Channel 2 configuration register.

表 7-173. SASI\_RX\_CH2\_CFG Register Field Descriptions

Bit	Field	Type	Reset	Description
7-6	RESERVED	R	00b	Reserved bits; Write only reset value
5	SASI_RX_CH2_CFG	R/W	0b	Secondary ASI input channel 2 configuration. 0d = Secondary ASI channel 2 input is disabled 1d = Secondary ASI channel 2 input corresponds to DAC Channel 2 data
4-0	SASI_RX_CH2_SLOT_NUM[4:0]	R/W	00001b	Secondary ASI input channel 2 slot assignment. 0d = TDM is slot 0 or I <sup>2</sup> S, LJ is left slot 0 1d = TDM is slot 1 or I <sup>2</sup> S, LJ is left slot 1 2d to 14d = Slot assigned as per configuration 15d = TDM is slot 15 or I <sup>2</sup> S, LJ is left slot 15 16d = TDM is slot 16 or I <sup>2</sup> S, LJ is right slot 0 17d = TDM is slot 17 or I <sup>2</sup> S, LJ is right slot 1 18d to 30d = Slot assigned as per configuration 31d = TDM is slot 31 or I <sup>2</sup> S, LJ is right slot 15

### 7.5.3.16 SASI\_RX\_CH3\_CFG Register (Address = 0x2A) [Reset = 0x02]

SASI\_RX\_CH3\_CFG is shown in 表 7-174.

Return to the [Summary Table](#).

This register is the SASI RX Channel 3 configuration register.

表 7-174. SASI\_RX\_CH3\_CFG Register Field Descriptions

Bit	Field	Type	Reset	Description
7-6	RESERVED	R	00b	Reserved bits; Write only reset value
5	SASI_RX_CH3_CFG	R/W	0b	Secondary ASI input channel 3 configuration. 0d = Secondary ASI channel 3 input is disabled 1d = Secondary ASI channel 3 input corresponds to DAC Channel 3 data
4-0	SASI_RX_CH3_SLOT_NUM[4:0]	R/W	00010b	Secondary ASI input channel 3 slot assignment. 0d = TDM is slot 0 or I <sup>2</sup> S, LJ is left slot 0 1d = TDM is slot 1 or I <sup>2</sup> S, LJ is left slot 1 2d to 14d = Slot assigned as per configuration 15d = TDM is slot 15 or I <sup>2</sup> S, LJ is left slot 15 16d = TDM is slot 16 or I <sup>2</sup> S, LJ is right slot 0 17d = TDM is slot 17 or I <sup>2</sup> S, LJ is right slot 1 18d to 30d = Slot assigned as per configuration 31d = TDM is slot 31 or I <sup>2</sup> S, LJ is right slot 15

### 7.5.3.17 SASI\_RX\_CH4\_CFG Register (Address = 0x2B) [Reset = 0x03]

SASI\_RX\_CH4\_CFG is shown in 表 7-175.

Return to the [Summary Table](#).

This register is the SASI RX Channel 4 configuration register.

表 7-175. SASI\_RX\_CH4\_CFG Register Field Descriptions

Bit	Field	Type	Reset	Description
7-6	RESERVED	R	00b	Reserved bits; Write only reset value
5	SASI_RX_CH4_CFG	R/W	0b	Secondary ASI input channel 4 configuration. 0d = Secondary ASI channel 4 input is disabled 1d = Secondary ASI channel 4 input corresponds to DAC Channel 4 data

**表 7-175. SASI\_RX\_CH4\_CFG Register Field Descriptions (続き)**

Bit	Field	Type	Reset	Description
4-0	SASI_RX_CH4_SLOT_NUM[4:0]	R/W	00011b	Secondary ASI input channel 4 slot assignment. 0d = TDM is slot 0 or I <sup>2</sup> S, LJ is left slot 0 1d = TDM is slot 1 or I <sup>2</sup> S, LJ is left slot 1 2d to 14d = Slot assigned as per configuration 15d = TDM is slot 15 or I <sup>2</sup> S, LJ is left slot 15 16d = TDM is slot 16 or I <sup>2</sup> S, LJ is right slot 0 17d = TDM is slot 17 or I <sup>2</sup> S, LJ is right slot 1 18d to 30d = Slot assigned as per configuration 31d = TDM is slot 31 or I <sup>2</sup> S, LJ is right slot 15

**7.5.3.18 SASI\_RX\_CH5\_CFG Register (Address = 0x2C) [Reset = 0x04]**

SASI\_RX\_CH5\_CFG is shown in [表 7-176](#).

Return to the [Summary Table](#).

This register is the SASI RX Channel 5 configuration register.

**表 7-176. SASI\_RX\_CH5\_CFG Register Field Descriptions**

Bit	Field	Type	Reset	Description
7	RESERVED	R	0b	Reserved bit; Write only reset value
6-5	SASI_RX_CH5_CFG[1:0]	R/W	00b	Secondary ASI input channel 5 configuration. 0d = Secondary ASI channel 5 input is disabled 1d = Secondary ASI channel 5 input corresponds to DAC Channel 5 data 2d = Secondary ASI channel 5 input corresponds to ADC Channel 1 output loopback 3d = Reserved
4-0	SASI_RX_CH5_SLOT_NUM[4:0]	R/W	00100b	Secondary ASI input channel 5 slot assignment. 0d = TDM is slot 0 or I <sup>2</sup> S, LJ is left slot 0 1d = TDM is slot 1 or I <sup>2</sup> S, LJ is left slot 1 2d to 14d = Slot assigned as per configuration 15d = TDM is slot 15 or I <sup>2</sup> S, LJ is left slot 15 16d = TDM is slot 16 or I <sup>2</sup> S, LJ is right slot 0 17d = TDM is slot 17 or I <sup>2</sup> S, LJ is right slot 1 18d to 30d = Slot assigned as per configuration 31d = TDM is slot 31 or I <sup>2</sup> S, LJ is right slot 15

**7.5.3.19 SASI\_RX\_CH6\_CFG Register (Address = 0x2D) [Reset = 0x05]**

SASI\_RX\_CH6\_CFG is shown in [表 7-177](#).

Return to the [Summary Table](#).

This register is the SASI RX Channel 6 configuration register.

**表 7-177. SASI\_RX\_CH6\_CFG Register Field Descriptions**

Bit	Field	Type	Reset	Description
7	RESERVED	R	0b	Reserved bit; Write only reset value
6-5	SASI_RX_CH6_CFG[1:0]	R/W	00b	Secondary ASI input channel 6 configuration. 0d = Secondary ASI channel 6 input is disabled 1d = Secondary ASI channel 6 input corresponds to DAC Channel 6 data 2d = Secondary ASI channel 6 input corresponds to ADC Channel 2 output loopback 3d = Secondary ASI channel 6 input corresponds to ICLA device 1 data



表 7-177. SASI\_RX\_CH6\_CFG Register Field Descriptions (続き)

Bit	Field	Type	Reset	Description
4-0	SASI_RX_CH6_SLOT_NUM[4:0]	R/W	00101b	Secondary ASI input channel 6 slot assignment. 0d = TDM is slot 0 or I <sup>2</sup> S, LJ is left slot 0 1d = TDM is slot 1 or I <sup>2</sup> S, LJ is left slot 1 2d to 14d = Slot assigned as per configuration 15d = TDM is slot 15 or I <sup>2</sup> S, LJ is left slot 15 16d = TDM is slot 16 or I <sup>2</sup> S, LJ is right slot 0 17d = TDM is slot 17 or I <sup>2</sup> S, LJ is right slot 1 18d to 30d = Slot assigned as per configuration 31d = TDM is slot 31 or I <sup>2</sup> S, LJ is right slot 15

### 7.5.3.20 SASI\_RX\_CH7\_CFG Register (Address = 0x2E) [Reset = 0x06]

SASI\_RX\_CH7\_CFG is shown in 表 7-178.

Return to the [Summary Table](#).

This register is the SASI RX Channel 7 configuration register.

表 7-178. SASI\_RX\_CH7\_CFG Register Field Descriptions

Bit	Field	Type	Reset	Description
7	RESERVED	R	0b	Reserved bit; Write only reset value
6-5	SASI_RX_CH7_CFG[1:0]	R/W	00b	Secondary ASI input channel 7 configuration. 0d = Secondary ASI channel 7 input is disabled 1d = Secondary ASI channel 7 input corresponds to DAC Channel 7 data 2d = Secondary ASI channel 7 input corresponds to ADC Channel 3 output loopback 3d = Secondary ASI channel 7 input corresponds to ICLA device 2 data
4-0	SASI_RX_CH7_SLOT_NUM[4:0]	R/W	00110b	Secondary ASI input channel 7 slot assignment. 0d = TDM is slot 0 or I <sup>2</sup> S, LJ is left slot 0 1d = TDM is slot 1 or I <sup>2</sup> S, LJ is left slot 1 2d to 14d = Slot assigned as per configuration 15d = TDM is slot 15 or I <sup>2</sup> S, LJ is left slot 15 16d = TDM is slot 16 or I <sup>2</sup> S, LJ is right slot 0 17d = TDM is slot 17 or I <sup>2</sup> S, LJ is right slot 1 18d to 30d = Slot assigned as per configuration 31d = TDM is slot 31 or I <sup>2</sup> S, LJ is right slot 15

### 7.5.3.21 SASI\_RX\_CH8\_CFG Register (Address = 0x2F) [Reset = 0x07]

SASI\_RX\_CH8\_CFG is shown in 表 7-179.

Return to the [Summary Table](#).

This register is the SASI RX Channel 8 configuration register.

表 7-179. SASI\_RX\_CH8\_CFG Register Field Descriptions

Bit	Field	Type	Reset	Description
7	RESERVED	R	0b	Reserved bit; Write only reset value
6-5	SASI_RX_CH8_CFG[1:0]	R/W	00b	Secondary ASI input channel 8 configuration. 0d = Secondary ASI channel 8 input is disabled 1d = Secondary ASI channel 8 input corresponds to DAC Channel 8 data 2d = Secondary ASI channel 8 input corresponds to ADC Channel 4 output loopback 3d = Secondary ASI channel 8 input corresponds to ICLA device 3 data

**表 7-179. SASI\_RX\_CH8\_CFG Register Field Descriptions (続き)**

Bit	Field	Type	Reset	Description
4-0	SASI_RX_CH8_SLOT_NUM[4:0]	R/W	00111b	Secondary ASI input channel 8 slot assignment. 0d = TDM is slot 0 or I <sup>2</sup> S, LJ is left slot 0 1d = TDM is slot 1 or I <sup>2</sup> S, LJ is left slot 1 2d to 14d = Slot assigned as per configuration 15d = TDM is slot 15 or I <sup>2</sup> S, LJ is left slot 15 16d = TDM is slot 16 or I <sup>2</sup> S, LJ is right slot 0 17d = TDM is slot 17 or I <sup>2</sup> S, LJ is right slot 1 18d to 30d = Slot assigned as per configuration 31d = TDM is slot 31 or I <sup>2</sup> S, LJ is right slot 15

### 7.5.3.22 CLK\_CFG12 Register (Address = 0x32) [Reset = 0x00]

CLK\_CFG12 is shown in 表 7-180.

Return to the [Summary Table](#).

This register is the clock configuration register 12.

**表 7-180. CLK\_CFG12 Register Field Descriptions**

Bit	Field	Type	Reset	Description
7-6	PDIV_CLKSRC_SEL[1:0]	R/W	00b	Source clock selection for PLL PDIV Divider. 0d = PLL_PDIV_IN_CLK is Primary ASI BCLK 1d = PLL_PDIV_IN_CLK is Secondary ASI BCLK 2d = PLL_PDIV_IN_CLK is CCLK 3d = PLL_PDIV_IN_CLK is internal Oscillator Clock
5-3	PASI_BCLK_DIV_CLK_SEL[2:0]	R/W	000b	Primary ASI BCLK divider clock source selection. 0d = Primary ASI BCLK divider clock source is PLL output 1d = Reserved 2d = Primary ASI BCLK divider clock source is secondary ASI BCLK 3d = Primary ASI BCLK divider clock source is CCLK 4d = Primary ASI BCLK divider clock source is internal oscillator clock 5d = Primary ASI BCLK divider clock source is DSP clock 6d to 7d = Reserved
2-0	RESERVED	R	000b	Reserved bits; Write only reset value

### 7.5.3.23 CLK\_CFG13 Register (Address = 0x33) [Reset = 0x00]

CLK\_CFG13 is shown in 表 7-181.

Return to the [Summary Table](#).

**表 7-181. CLK\_CFG13 Register Field Descriptions**

Bit	Field	Type	Reset	Description
7	RESERVED	R	0b	Reserved bit; Write only reset value
6-4	SASI_BCLK_DIV_CLK_SEL[2:0]	R/W	000b	Secondary ASI BCLK divider clock source selection. 0d = Secondary ASI BCLK divider clock source is PLL output 1d = Secondary ASI BCLK divider clock source is primary ASI BCLK 2d = Reserved 3d = Secondary ASI BCLK divider clock source is CCLK 4d = Secondary ASI BCLK divider clock source is internal oscillator clock 5d = Secondary ASI BCLK divider clock source is DSP clock 6d to 7d = Reserved
3-0	RESERVED	R	0000b	Reserved bits; Write only reset value

### 7.5.3.24 CLK\_CFG14 Register (Address = 0x34) [Reset = 0x10]

CLK\_CFG14 is shown in 表 7-182.

Return to the [Summary Table](#).

This register is the clock configuration register 14.

表 7-182. CLK\_CFG14 Register Field Descriptions

Bit	Field	Type	Reset	Description
7-6	DIG_NM_DIV_CLK_SRC_SEL[1:0]	R/W	00b	Source clock selection for DIG NMDIV CLK clock. 0d = DIG NM divider input clock is Primary ASI BCLK 1d = DIG NM divider input clock is Secondary ASI BCLK 2d = DIG NM divider input clock is CCLK 3d = DIG NM divider input clock is internal oscillator clock
5-4	ANA_NM_DIV_CLK_SRC_SEL[1:0]	R/W	01b	Source clock selection for NMDIV CLK clock. 0d = NM divider input clock is PLL Output 1d = NM divider input clock is PLL Output 2d = NM divider input clock is DIG NM Divider Clock Source 3d = NM divider input clock is Primary ASI BCLK (Low Jitter Path)
3-2	RESERVED	R/W	00b	Reserved bits; Write only reset values
1-0	RESERVED	R/W	00b	Reserved bits; Write only reset values

### 7.5.3.25 CLK\_CFG15 Register (Address = 0x35) [Reset = 0x01]

CLK\_CFG15 is shown in 表 7-183.

Return to the [Summary Table](#).

This register is the clock configuration register 15.

表 7-183. CLK\_CFG15 Register Field Descriptions

Bit	Field	Type	Reset	Description
7-0	PLL_PDIV[7:0]	R/W	00000001b	PLL pre-scaler P-divider value (Don't care when auto detection is enabled) 0d = PLL PDIV value is 256 1d = PLL PDIV value is 1 2d = PLL PDIV value is 2 3d to 254d = PLL PDIV value is as per configuration 255d = PLL PDIV value is 255

### 7.5.3.26 CLK\_CFG16 Register (Address = 0x36) [Reset = 0x00]

CLK\_CFG16 is shown in 表 7-184.

Return to the [Summary Table](#).

This register is the clock configuration register 16.

表 7-184. CLK\_CFG16 Register Field Descriptions

Bit	Field	Type	Reset	Description
7	PLL_JMUL_MSB	R/W	0b	PLL integer portion J-multiplier value MSB bit. (Don't care when auto detection is enabled)
6	PLL_DIV_CLK_DIV_BY_2	R/W	0b	PLL DIV clock divide by 2 configuration 0d = No divide/2 inside PLL 1d = PLL does a divide/2
5-0	PLL_DMUL_MSB[5:0]	R/W	000000b	PLL fractional portion D-multiplier value MSB bits. (Don't care when auto detection is enabled)

### 7.5.3.27 CLK\_CFG17 Register (Address = 0x37) [Reset = 0x00]

CLK\_CFG17 is shown in [表 7-185](#).

Return to the [Summary Table](#).

This register is the clock configuration register 17.

**表 7-185. CLK\_CFG17 Register Field Descriptions**

Bit	Field	Type	Reset	Description
7-0	PLL_DMUL_LSB[7:0]	R/W	00000000b	PLL fractional portion D-multiplier value LSB byte. Above D-multiplier value MSB bits (PLL_DMUL_MSB) along with this LSB byte (PLL_DMUL_LSB) is concatenated to determine final D-multiplier value. (Don't care when auto detection is enabled) 0d = PLL DMUL value is 0 1d = PLL DMUL value is 1 2d = PLL DMUL value is 2 3d to 9998d = PLL JMUL value is as per configuration 9999d = PLL JMUL value is 9999 10000d to 16383d = Reserved; Don't use

### 7.5.3.28 CLK\_CFG18 Register (Address = 0x38) [Reset = 0x08]

CLK\_CFG18 is shown in [表 7-186](#).

Return to the [Summary Table](#).

This register is the clock configuration register 18.

**表 7-186. CLK\_CFG18 Register Field Descriptions**

Bit	Field	Type	Reset	Description
7-0	PLL_JMUL_LSB[7:0]	R/W	00001000b	PLL integer portion J-multiplier value LSB byte. Above J-multiplier value MSB bit (PLL_JMUL_MSB) along with this LSB byte (PLL_JMUL_LSB) is concatenated to determine final J-multiplier value. (Don't care when auto detection is enabled) 0d = Reserved; Don't use 1d = PLL JMUL value is 1 2d = PLL JMUL value is 2 3d to 510d = PLL JMUL value is as per configuration 511d = PLL JMUL value is 511

### 7.5.3.29 CLK\_CFG19 Register (Address = 0x39) [Reset = 0x20]

CLK\_CFG19 is shown in [表 7-187](#).

Return to the [Summary Table](#).

This register is the clock configuration register 19.

**表 7-187. CLK\_CFG19 Register Field Descriptions**

Bit	Field	Type	Reset	Description
7-5	NDIV[2:0]	R/W	001b	NDIV divider value. (Don't care when auto detection is enabled) 0d = NDIV value is 8 1d = NDIV value is 1 2d = NDIV value is 2 3d to 6d = NDIV value is as per configuration 7d = NDIV value is 7

表 7-187. CLK\_CFG19 Register Field Descriptions (続き)

Bit	Field	Type	Reset	Description
4-2	PDM_DIV[2:0]	R/W	000b	PDM divider value. (Don't care when auto detection is enabled) 0d = PDM_DIV value is 1 1d = PDM_DIV value is 2 2d = PDM_DIV value is 4 3d = PDM_DIV value is 8 4d = PDM_DIV value is 16 5d-7d Reserved
1-0	RESERVED	R/W	00b	Reserved bits; Write only reset values

### 7.5.3.30 CLK\_CFG20 Register (Address = 0x3A) [Reset = 0x04]

CLK\_CFG20 is shown in [表 7-188](#).

Return to the [Summary Table](#).

This register is the clock configuration register 20.

表 7-188. CLK\_CFG20 Register Field Descriptions

Bit	Field	Type	Reset	Description
7-2	MDIV[5:0]	R/W	000001b	MDIV divider value. (Don't care when auto detection is enabled) 0d = MDIV value is 64 1d = MDIV value is 1 2d = MDIV value is 2 3d to 62d = MDIV value is as per configuration 63d = MDIV value is 63
1-0	RESERVED	R/W	00b	Reserved bits; Write only reset values

### 7.5.3.31 CLK\_CFG21 Register (Address = 0x3B) [Reset = 0x00]

CLK\_CFG21 is shown in [表 7-189](#).

Return to the [Summary Table](#).

This register is the clock configuration register 21.

表 7-189. CLK\_CFG21 Register Field Descriptions

Bit	Field	Type	Reset	Description
7-6	RESERVED	R/W	00b	Reserved bits; Write only reset values
5-4	DIG_DAC_MODCLK_DIV[1:0]	R/W	00b	DAC modulator clock divider value. (Don't care when auto detection is enabled) 0d = DIG_DAC_MODCLK_DIV value is 1 1d = DIG_DAC_MODCLK_DIV value is 2 2d = DIG_DAC_MODCLK_DIV value is 4 3d = Reserved
3	RESERVED	R/W	0b	Reserved bit; Write only reset value
2	PASI_BDIV_MSB	R/W	0b	Primary ASI BCLK divider value MSB bit. (Don't care when auto detection is enabled)
1	SASI_BDIV_MSB	R/W	0b	Secondary ASI BCLK divider value MSB bit. (Don't care when auto detection is enabled)
0	RESERVED	R	0b	Reserved bit; Write only reset value

### 7.5.3.32 CLK\_CFG22 Register (Address = 0x3C) [Reset = 0x01]

CLK\_CFG22 is shown in [表 7-190](#).

Return to the [Summary Table](#).

This register is the clock configuration register 18.

**表 7-190. CLK\_CFG22 Register Field Descriptions**

Bit	Field	Type	Reset	Description
7-0	PASI_BDIV_LSB[7:0]	R/W	00000001b	Secondary ASI BCLK divider value. (Don't care when auto detection is enabled) 0d = SASI BCLK divider value is 512 1d = SASI BCLK divider value is 1 2d = SASI BCLK divider value is 2 3d to 62d = SASI BCLK divider value is as per configuration 63d = SASI BCLK divider value is 511

### 7.5.3.33 CLK\_CFG23 Register (Address = 0x3D) [Reset = 0x01]

CLK\_CFG23 is shown in [表 7-191](#).

Return to the [Summary Table](#).

This register is the clock configuration register 18.

**表 7-191. CLK\_CFG23 Register Field Descriptions**

Bit	Field	Type	Reset	Description
7-0	SASI_BDIV_LSB[7:0]	R/W	00000001b	Secondary ASI BCLK divider value. (Don't care when auto detection is enabled) 0d = SASI BCLK divider value is 512 1d = SASI BCLK divider value is 1 2d = SASI BCLK divider value is 2 3d to 62d = SASI BCLK divider value is as per configuration 63d = SASI BCLK divider value is 511

### 7.5.3.34 CLK\_CFG24 Register (Address = 0x3E) [Reset = 0x01]

CLK\_CFG24 is shown in [表 7-192](#).

Return to the [Summary Table](#).

This register is the clock configuration register 21.

**表 7-192. CLK\_CFG24 Register Field Descriptions**

Bit	Field	Type	Reset	Description
7-6	RESERVED	R	00b	Reserved bits; Write only reset value
5-0	ANA_NM_DIV[5:0]	R/W	000001b	Analog N-M DIV divider value. (Don't care when auto detection is enabled) 0d = ANA_NM_DIV value is 64 1d = ANA_NM_DIV value is 1 2d = ANA_NM_DIV value is 2 3d to 62d = ANA_NM_DIV value is as per configuration 63d = NDIV value is 63

### 7.5.3.35 CLK\_CFG30 Register (Address = 0x44) [Reset = 0x00]

CLK\_CFG30 is shown in [表 7-193](#).

Return to the [Summary Table](#).

**表 7-193. CLK\_CFG30 Register Field Descriptions**

Bit	Field	Type	Reset	Description
7-3	RESERVED	R	00000b	Reserved bits; Write only reset value
2	NDIV_EN	R/W	0b	NDIV divider enable 0d = divider disabled 1d = divider enabled
1	MDIV_EN	R/W	0b	MDIV divider enable 0d = divider disabled 1d = divider enabled
0	PDM_DIV_EN	R/W	0b	PDM divider enable 0d = divider disabled 1d = divider enabled

### 7.5.3.36 CLK\_CFG31 Register (Address = 0x45) [Reset = 0x00]

CLK\_CFG31 is shown in [表 7-194](#).

Return to the [Summary Table](#).

**表 7-194. CLK\_CFG31 Register Field Descriptions**

Bit	Field	Type	Reset	Description
7	RESERVED	R/W	0b	Reserved bit; Write only reset value
6	RESERVED	R/W	0b	Reserved bit; Write only reset value
5	RESERVED	R/W	0b	Reserved bit; Write only reset value
4	DIG_DAC_MODCLK_DIV_EN	R/W	0b	DAC MODCLK divider enable 0d = divider disabled 1d = divider enabled
3	PASI_BDIV_EN	R/W	0b	PASI BDIV divider enable 0d = divider disabled 1d = divider enabled
2	SASI_BDIV_EN	R/W	0b	SASI BDIV divider enable 0d = divider disabled 1d = divider enabled
1	PASI_FSYNC_DIV_EN	R/W	0b	PASI FSYNC DIV divider enable 0d = divider disabled 1d = divider enabled
0	SASI_FSYNC_DIV_EN	R/W	0b	SASI FSYNC DIV divider enable 0d = divider disabled 1d = divider enabled

### 7.5.3.37 CLKOUT\_CFG1 Register (Address = 0x46) [Reset = 0x00]

CLKOUT\_CFG1 is shown in [表 7-195](#).

Return to the [Summary Table](#).

This register is the CLKOUT configuration register 1.

**表 7-195. CLKOUT\_CFG1 Register Field Descriptions**

Bit	Field	Type	Reset	Description
7-3	RESERVED	R	00000b	Reserved bits; Write only reset value

**表 7-195. CLKOUT\_CFG1 Register Field Descriptions (続き)**

Bit	Field	Type	Reset	Description
2-0	CLKOUT_CLK_SEL[2:0]	R/W	000b	General Purpose CLKOUT divider clock source selection. 0d = Source clock is PLL output 1d = Source clock is primary ASI BCLK 2d = Source clock is secondary ASI BCLK 3d = Source clock is CCLK 4d = Source clock is internal oscillator clock 5d = Source clock is DSP clock 6d to 7d = Reserved

**7.5.3.38 CLKOUT\_CFG2 Register (Address = 0x47) [Reset = 0x01]**

CLKOUT\_CFG2 is shown in [表 7-196](#).

Return to the [Summary Table](#).

This register is the CLKOUT configuration register 2.

**表 7-196. CLKOUT\_CFG2 Register Field Descriptions**

Bit	Field	Type	Reset	Description
7	CLKOUT_DIV_EN	R/W	0b	CLKOUT divider enable. 0d = CLKOUT divider disabled 1d = CLKOUT divider enabled
6-0	CLKOUT_DIV[6:0]	R/W	0000001b	CLKOUT DIV divider value. 0d = CLKOUT_DIV value is 128 1d = CLKOUT_DIV value is 1 2d = CLKOUT_DIV value is 2 3d to 126d = CLKOUT_DIV value is as per configuration 127d = CLKOUT_DIV value is 127

**7.5.3.39 SARCLK\_CFG1 Register (Address = 0x49) [Reset = 0x00]**

SARCLK\_CFG1 is shown in [表 7-197](#).

Return to the [Summary Table](#).

This register is the SAR clock configuration register 1

**表 7-197. SARCLK\_CFG1 Register Field Descriptions**

Bit	Field	Type	Reset	Description
7-6	SAR_CLK_FREQ_SEL[1:0]	R/W	00b	SAR clock frequency mode 0d = SAR clock frequency is ~6MHz 1d = SAR clock frequency is ~3MHz 2d = SAR clock frequency is ~1.5MHz 3d = SAR clock frequency is ~12MHz (valid only when SAR clock is generated directly using internal oscillator clock)
5	SAR_CLK_SRC_AUTO_DISABLE	R/W	0b	SAR divider source clock auto selection disable 0d = SAR divider source clock auto-selection based on clock detection scheme 1d = SAR divider source clock auto-selection disabled and selected based on BST_CLK_SRC_SEL
4	SAR_CLK_SRC_MANUAL_SEL	R/W	0b	SAR clock source manual selection (don't care in auto mode) 0d = SAR clock generated based on Audio clock available for ADC/DAC 1d = SAR clock generated based on internal oscillator clock
3	SAR_CLK_EN_AUTO_DISABLE	R/W	0b	SAR divider source clock auto selection disable 0d = SAR divider auto-enabled 1d = SAR divider enabled/disabled based on manual control using BST_CLK_EN



**表 7-197. SARCLK\_CFG1 Register Field Descriptions (続き)**

Bit	Field	Type	Reset	Description
2	SAR_CLK_MANUAL_EN	R/W	0b	SAR divider manual enable (don't care in auto mode) 0d = SAR divider disabled 1d = SAR divider enabled
1-0	SAR_CLK_MANUAL_DIV[1:0]	R/W	00b	SAR divider value (don't care in auto mode) 0d = SAR divider value is 1 1d = SAR divider value is 2 2d = SAR divider value is 4 3d = SAR divider value is 8

## 8 Application and Implementation

### 注

Information in the following applications sections is not part of the TI component specification, and TI does not warrant its accuracy or completeness. TI's customers are responsible for determining suitability of components for their purposes, as well as validating and testing their design implementation to confirm system functionality.

### 8.1 Application Information

The TAD5112 is a stereo, high-performance audio DAC that supports sample rates of up to 768 kHz. The device supports up to 4 channel simultaneous playback which can be configured as a 2 channel differential or psuedo differential output or up to 4 channel single-ended output with options for headphone and lineout drive capabilities.

Communication to the TAD5112 for configuration of the control registers is supported using an I<sup>2</sup>C or SPI interface. The device supports a highly flexible, audio serial interface (TDM, I<sup>2</sup>S, and LJ) to transmit audio data seamlessly in the system across devices.

### 8.2 Typical Application

#### 8.2.1 Application

Figure 8-1 shows a typical configuration of the TAD5112 for an application using two channel lineout operation with an I<sup>2</sup>C control interface and a time-division multiplexing (TDM) audio data target interface.

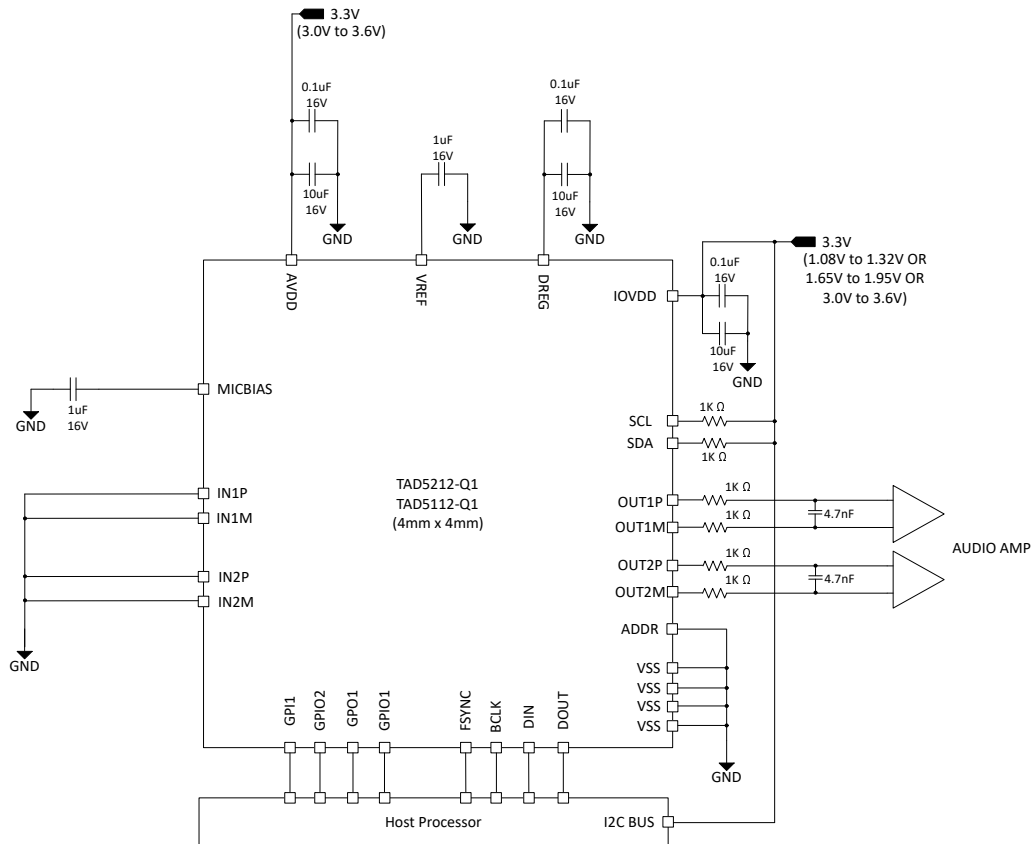

Figure 8-1. Stereo Lineout Block Diagram

## 8.2.2 Design Requirements

表 8-1 lists the design parameters for this application.

**表 8-1. Design Parameters**

PARAMETER	VALUE
AVDD	3.3V
IOVDD	1.2V or 1.8V or 3.3V
AVDD supply current consumption	TBD
IOVDD supply current consumption	TBD
Maximum MICBIAS current	5mA
Load on OUT1M, OUT1P, OUT2M, OUT2P	>600 ohms

## 8.2.3 Detailed Design Procedure

This section describes the necessary steps to configure the TAD5112 for this specific application. The following steps provide a sequence of items that must be executed in the time between powering the device up and reading data from the device or transitioning from one mode to another mode of operation.

1. Apply power to the device:
  - a. Power up the IOVDD and AVDD power supplies
  - b. Wait for at least 1ms to allow the device to initialize the internal registers.
  - c. The device now goes into sleep mode (low-power mode < 10  $\mu$ A)
2. Transition from sleep mode to active mode whenever required for the operation:
  - a. Wake up the device by writing to P0\_R2 to disable sleep mode
  - b. Wait for at least 1 ms to allow the device to complete the internal wake-up sequence
  - c. Override the default configuration registers or programmable coefficients value as required (this step is optional)
  - d. Enable all desired audio serial interface input/output channels by writing to P0\_R40 to P0\_R47 for DAC
  - e. Power-up the DAC by writing to P0\_R120
  - f. Apply FSYNC and BCLK with the desired output sample rates and the BCLK to FSYNC ratio  
 This specific step can be done at any point in the sequence after step a.  
 See the [セクション 7.3.1.4](#) section for supported sample rates and the BCLK to FSYNC ratio.
  - g. The device recording data is now sent to the host processor using the TDM audio serial data bus and playback data from TDM is now played on the lineout
3. Transition from active mode to sleep mode (again) as required in the system for low-power operation:
  - a. Enter sleep mode by writing to P0\_R2 to enable sleep mode
  - b. Wait at least 6 ms (when FSYNC = 48 kHz) for the volume to ramp down and for all blocks to power down
  - c. Read P0\_R122 to check the device shutdown and sleep mode status
  - d. If the device P0\_R122\_D[7:5] status bit is 3'b100 then stop FSYNC and BCLK in the system
  - e. The device now goes into sleep mode (low-power mode < 10  $\mu$ A) and retains all register values
4. Transition from sleep mode to active mode (again) as required for the recording operation:
  - a. Wake up the device by writing to P0\_R2 to disable sleep mode
  - b. Wait at least 1 ms to allow the device to complete the internal wake-up sequence
  - c. Apply FSYNC and BCLK with the desired output sample rates and the BCLK to FSYNC ratio
  - d. The device recording data is now sent to the host processor using the TDM audio serial data bus and playback data from TDM is now played on the lineout
5. Repeat step 4 and step 5 as required for mode transitions

## 9 Power Supply Recommendations

The power-supply sequence between the IOVDD and AVDD rails can be applied in any order. However, after all supplies are stable, then only initiate the I<sup>2</sup>C or SPI transactions to initialize the device.

For the supply power-up requirement,  $t_1$ ,  $t_2$  must be at least 2 ms to allow the device to initialize the internal registers. See the [セクション 7.4](#) section for details on how the device operates in various modes after the device power supplies are settled to the recommended operating voltage levels. For the supply power-down requirement,  $t_3$ ,  $t_4$  must be at least 10 ms. This timing (as shown in [図 9-1](#)) allows the device to ramp down the volume on the playback data, power down the analog and digital blocks, and put the device into shutdown mode. The device can also be immediately put into shutdown mode by ramping down power supplies, but doing so causes an abrupt shutdown.

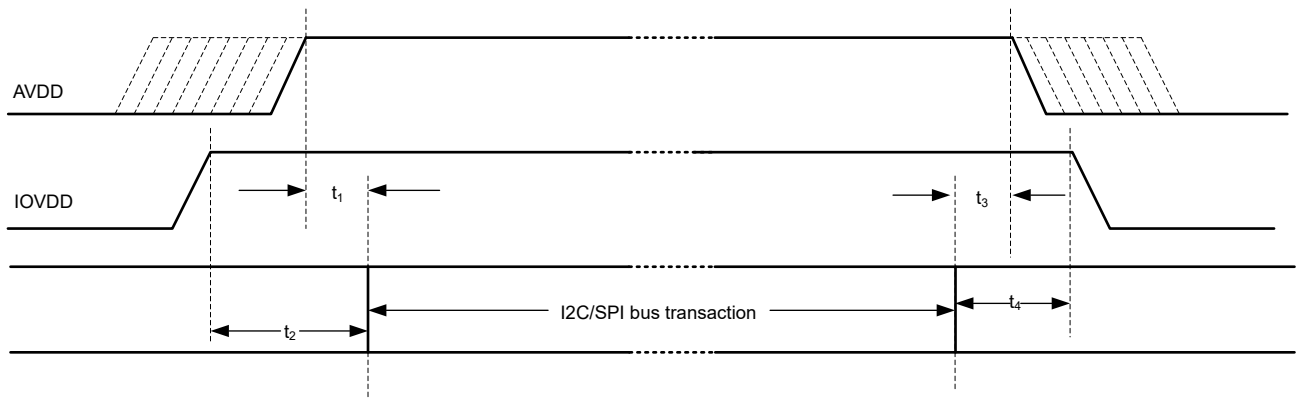

**図 9-1. Power-Supply Sequencing Requirement Timing Diagram**

Make sure that the supply ramp rate is slower than 0.1V/ $\mu$ s and that the wait time between a power-down and a power-up event is at least 100 ms. For supply ramp rate slower than 0.1 V/ms, host device must apply a software reset as first transaction before doing any device configuration. Make sure all digital input pins are at valid input levels and not toggling during supply sequencing.

The TAD5112 supports a single AVDD supply operation by integrating an on-chip digital regulator, DREG, and an analog regulator, AREG.

## 10 Device and Documentation Support

TI offers an extensive line of development tools. Tools and software to evaluate the performance of the device, generate code, and develop solutions are listed below.

### 10.1 Documentation Support

#### 10.1.1 Related Documentation

### 10.2 ドキュメントの更新通知を受け取る方法

ドキュメントの更新についての通知を受け取るには、[www.tij.co.jp](http://www.tij.co.jp) のデバイス製品フォルダを開いてください。[\[通知\]](#) をクリックして登録すると、変更されたすべての製品情報に関するダイジェストを毎週受け取ることができます。変更の詳細については、改訂されたドキュメントに含まれている改訂履歴をご覧ください。

### 10.3 サポート・リソース

[テキサス・インスツルメンツ E2E™ サポート・フォーラム](#) は、エンジニアが検証済みの回答と設計に関するヒントをエキスパートから迅速かつ直接得ることができる場所です。既存の回答を検索したり、独自の質問をしたりすることで、設計に必要な支援を迅速に得ることができます。

リンクされているコンテンツは、各寄稿者により「現状のまま」提供されるものです。これらはテキサス・インスツルメンツの仕様を構成するものではなく、必ずしもテキサス・インスツルメンツの見解を反映したものではありません。テキサス・インスツルメンツの[使用条件](#)を参照してください。

### 10.4 Trademarks

テキサス・インスツルメンツ E2E™ is a trademark of Texas Instruments.  
すべての商標は、それぞれの所有者に帰属します。

### 10.5 静電気放電に関する注意事項



この IC は、ESD によって破損する可能性があります。テキサス・インスツルメンツは、IC を取り扱う際には常に適切な注意を払うことを推奨します。正しい取り扱いおよび設置手順に従わない場合、デバイスを破損するおそれがあります。

ESD による破損は、わずかな性能低下からデバイスの完全な故障まで多岐にわたります。精密な IC の場合、パラメータがわずかに変化するだけで公表されている仕様から外れる可能性があるため、破損が発生しやすくなっています。

### 10.6 用語集

[テキサス・インスツルメンツ用語集](#) この用語集には、用語や略語の一覧および定義が記載されています。

## 11 Mechanical, Packaging, and Orderable Information

The following pages include mechanical, packaging, and orderable information. This information is the most current data available for the designated devices. This data is subject to change without notice and revision of this document. For browser-based versions of this data sheet, refer to the left-hand navigation.

ADVANCE INFORMATION

### 11.1 Tape and Reel Information

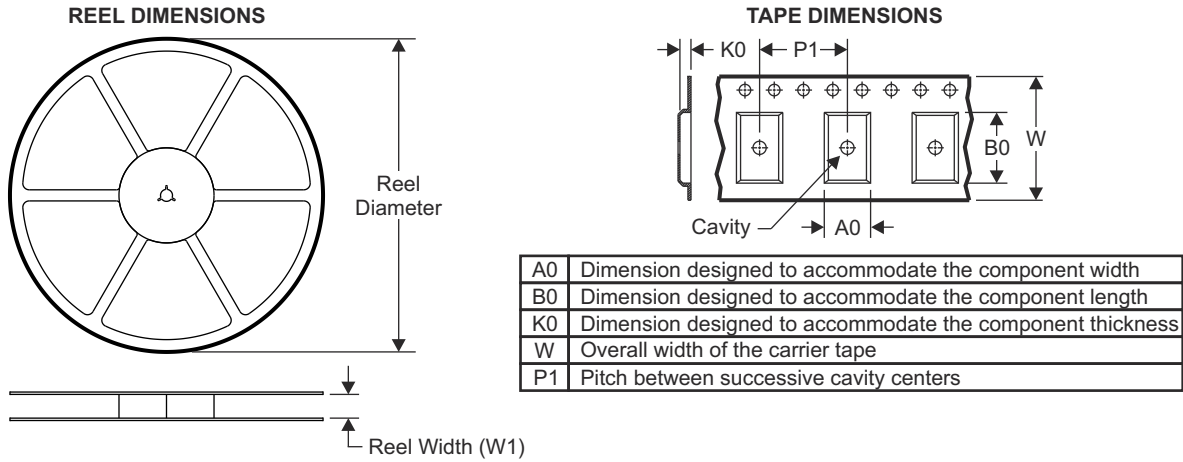

#### QUADRANT ASSIGNMENTS FOR PIN 1 ORIENTATION IN TAPE

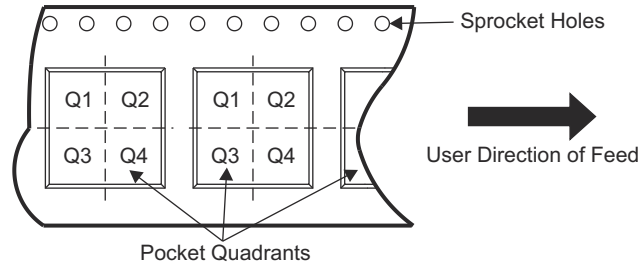

Device	Package Type	Package Drawing	Pins	SPQ	Reel Diameter (mm)	Reel Width W1 (mm)	A0 (mm)	B0 (mm)	K0 (mm)	P1 (mm)	W (mm)	Pin1 Quadrant
XTAD5112IRGER	VQFN	RGE	24	3000	330.0	12.4	4.25	4.25	1.15	8.0	12.0	Q1

ADVANCE INFORMATION

TAPE AND REEL BOX DIMENSIONS



Device	Package Type	Package Drawing	Pins	SPQ	Length (mm)	Width (mm)	Height (mm)
XTAD5112IRGER	VQFN	RGE	24	3000	367.0	367.0	35.0

ADVANCE INFORMATION



**RGE0024R**

**PACKAGE OUTLINE**

**VQFN - 1 mm max height**

PLASTIC QUAD FLATPACK-NO LEAD

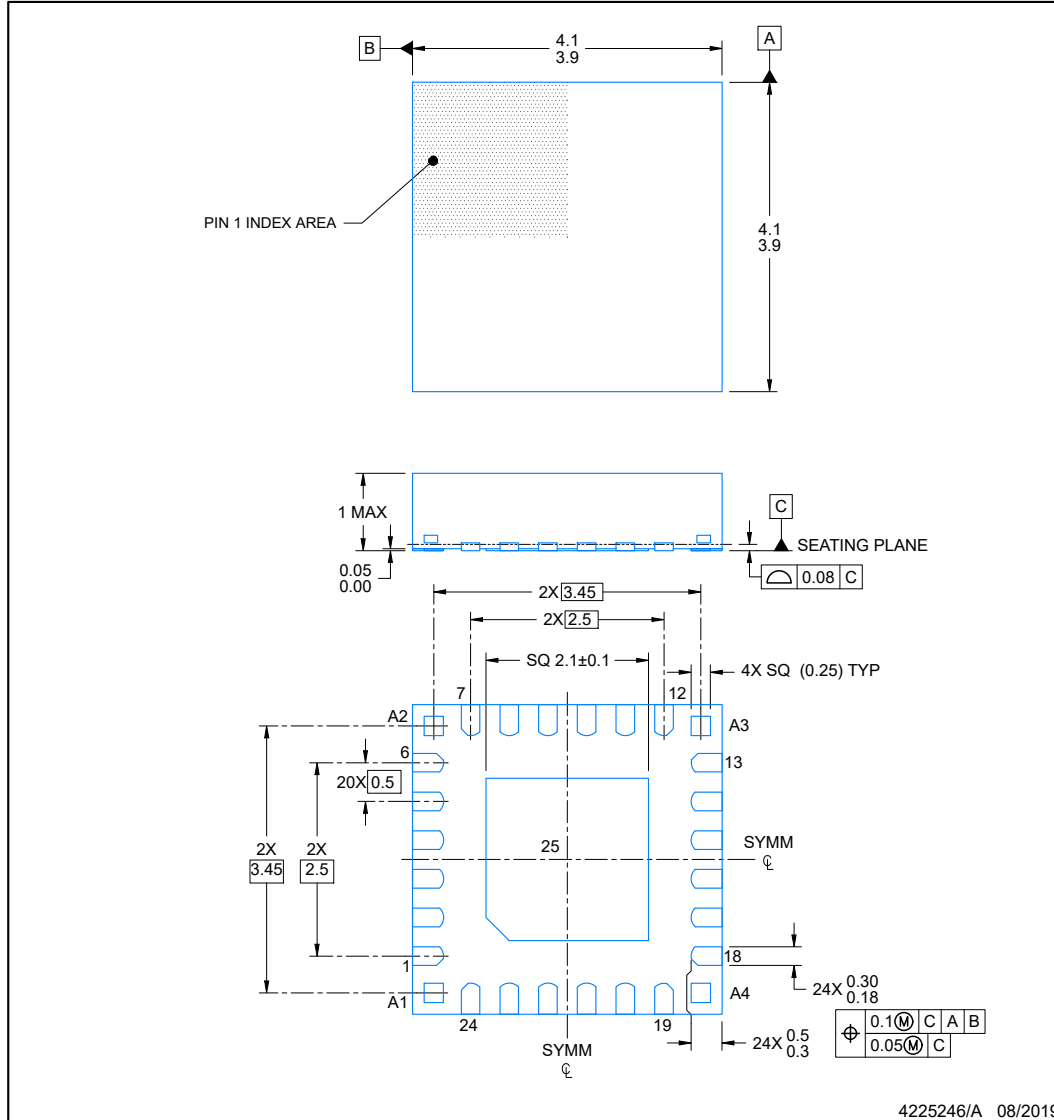

NOTES:

1. All linear dimensions are in millimeters. Any dimensions in parenthesis are for reference only. Dimensioning and tolerancing per ASME Y14.5M.
2. This drawing is subject to change without notice.
3. The package thermal pad must be soldered to the printed circuit board for optimal thermal and mechanical performance.

**EXAMPLE BOARD LAYOUT**  
**VQFN - 1 mm max height**

**RGE0024R**

PLASTIC QUAD FLATPACK-NO LEAD

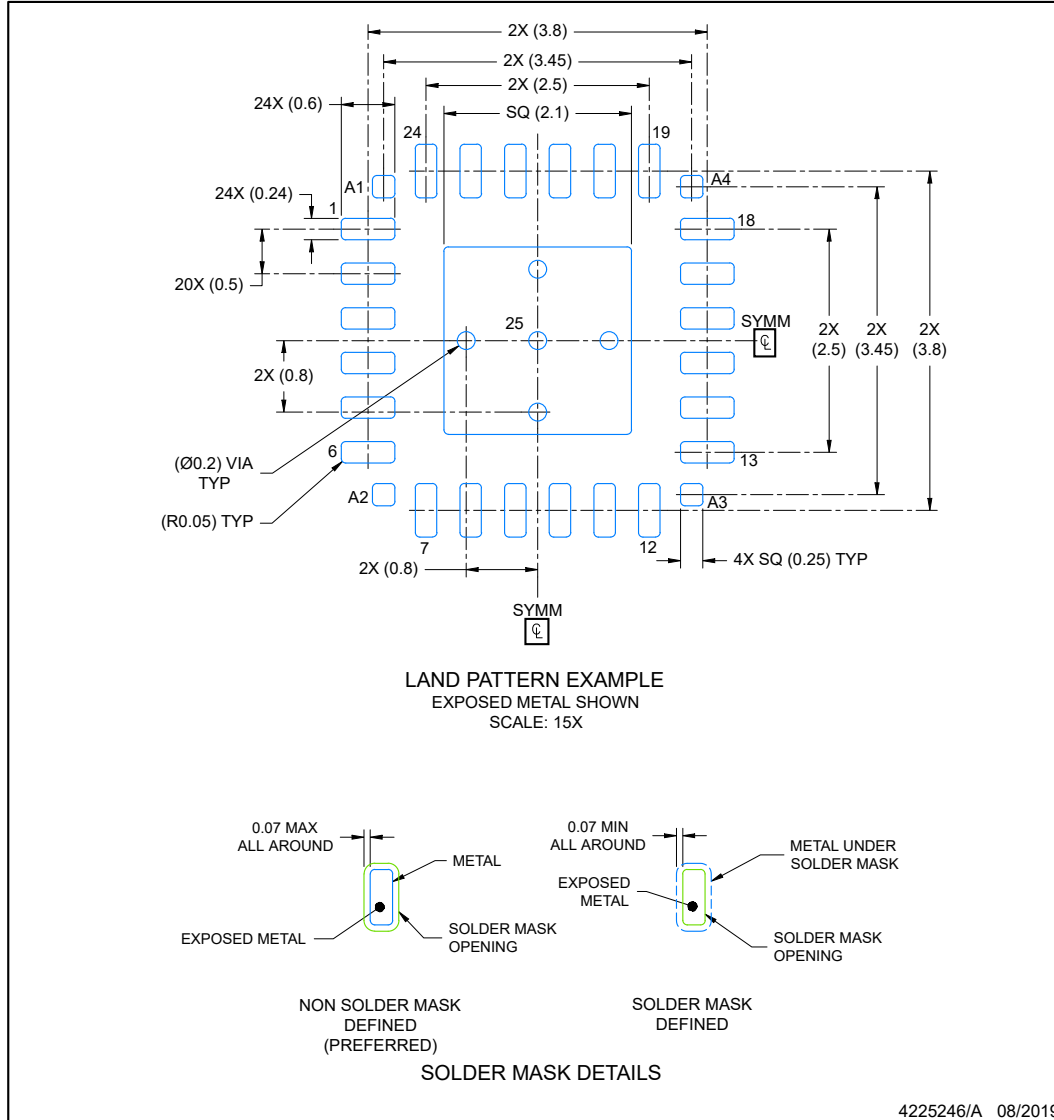

NOTES: (continued)

4. This package is designed to be soldered to a thermal pad on the board. For more information, see Texas Instruments literature number SLUA271 ([www.ti.com/lit/slua271](http://www.ti.com/lit/slua271)).
5. Vias are optional depending on application, refer to device data sheet. If any vias are implemented, refer to their locations shown on this view. It is recommended that vias under paste be filled, plugged or tented.

## EXAMPLE STENCIL DESIGN

**RGE0024R**

**VQFN - 1 mm max height**

PLASTIC QUAD FLATPACK-NO LEAD

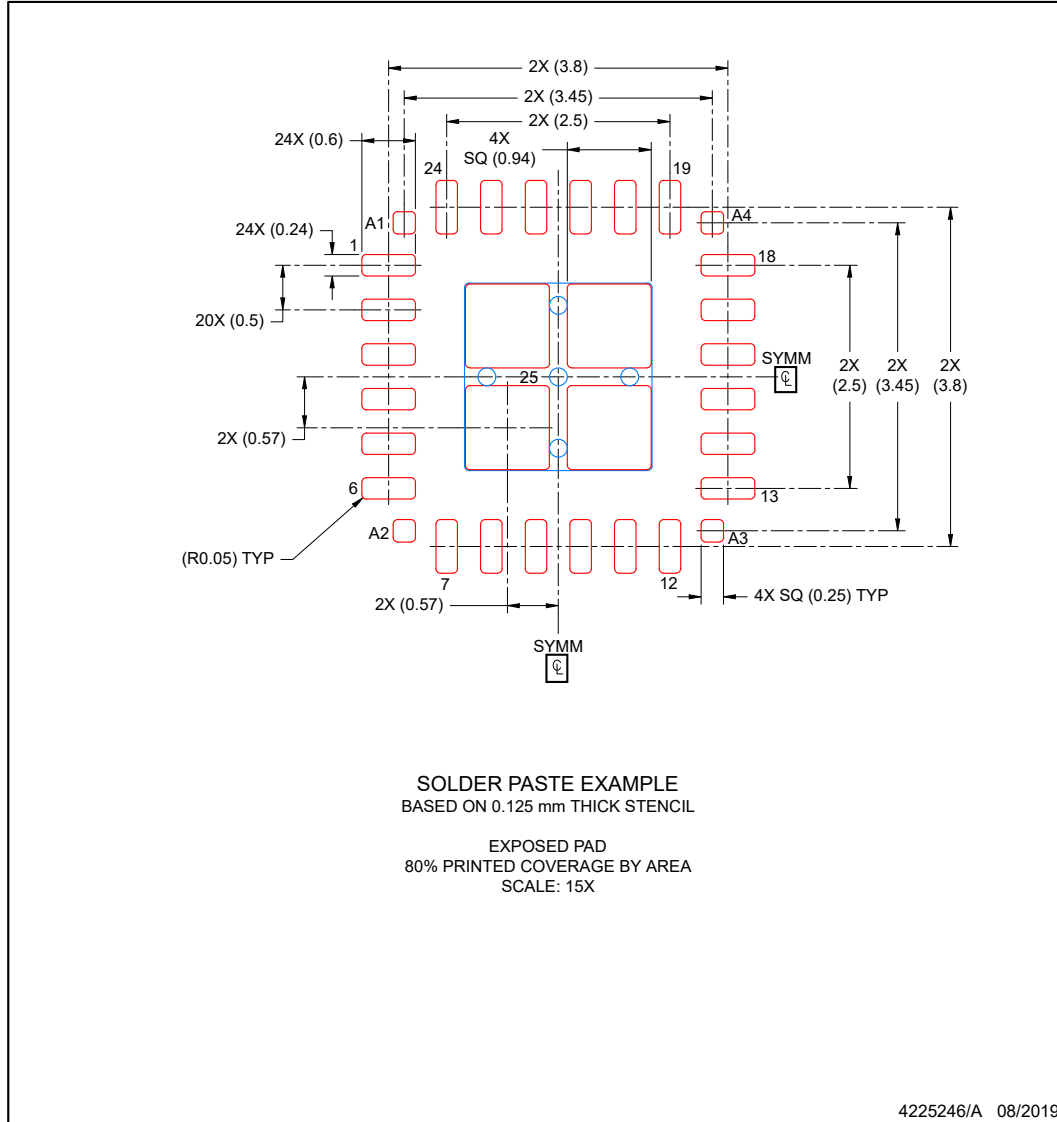

NOTES: (continued)

6. Laser cutting apertures with trapezoidal walls and rounded corners may offer better paste release. IPC-7525 may have alternate design recommendations.

ADVANCE INFORMATION

**PACKAGING INFORMATION**

Orderable Device	Status (1)	Package Type	Package Drawing	Pins	Package Qty	Eco Plan (2)	Lead finish/ Ball material (6)	MSL Peak Temp (3)	Op Temp (°C)	Device Marking (4/5)	Samples
XTAD5112IRGER	ACTIVE	VQFN	RGE	24	3000	TBD	Call TI	Call TI	-40 to 125		Samples

(1) The marketing status values are defined as follows:

**ACTIVE:** Product device recommended for new designs.

**LIFEBUY:** TI has announced that the device will be discontinued, and a lifetime-buy period is in effect.

**NRND:** Not recommended for new designs. Device is in production to support existing customers, but TI does not recommend using this part in a new design.

**PREVIEW:** Device has been announced but is not in production. Samples may or may not be available.

**OBSELETE:** TI has discontinued the production of the device.

(2) **RoHS:** TI defines "RoHS" to mean semiconductor products that are compliant with the current EU RoHS requirements for all 10 RoHS substances, including the requirement that RoHS substance do not exceed 0.1% by weight in homogeneous materials. Where designed to be soldered at high temperatures, "RoHS" products are suitable for use in specified lead-free processes. TI may reference these types of products as "Pb-Free".

**RoHS Exempt:** TI defines "RoHS Exempt" to mean products that contain lead but are compliant with EU RoHS pursuant to a specific EU RoHS exemption.

**Green:** TI defines "Green" to mean the content of Chlorine (Cl) and Bromine (Br) based flame retardants meet JS709B low halogen requirements of <=1000ppm threshold. Antimony trioxide based flame retardants must also meet the <=1000ppm threshold requirement.

(3) MSL, Peak Temp. - The Moisture Sensitivity Level rating according to the JEDEC industry standard classifications, and peak solder temperature.

(4) There may be additional marking, which relates to the logo, the lot trace code information, or the environmental category on the device.

(5) Multiple Device Markings will be inside parentheses. Only one Device Marking contained in parentheses and separated by a "-" will appear on a device. If a line is indented then it is a continuation of the previous line and the two combined represent the entire Device Marking for that device.

(6) Lead finish/Ball material - Orderable Devices may have multiple material finish options. Finish options are separated by a vertical ruled line. Lead finish/Ball material values may wrap to two lines if the finish value exceeds the maximum column width.

**Important Information and Disclaimer:**The information provided on this page represents TI's knowledge and belief as of the date that it is provided. TI bases its knowledge and belief on information provided by third parties, and makes no representation or warranty as to the accuracy of such information. Efforts are underway to better integrate information from third parties. TI has taken and continues to take reasonable steps to provide representative and accurate information but may not have conducted destructive testing or chemical analysis on incoming materials and chemicals. TI and TI suppliers consider certain information to be proprietary, and thus CAS numbers and other limited information may not be available for release.

In no event shall TI's liability arising out of such information exceed the total purchase price of the TI part(s) at issue in this document sold by TI to Customer on an annual basis.

**RGE 24**

**GENERIC PACKAGE VIEW**

**VQFN - 1 mm max height**

PLASTIC QUAD FLATPACK - NO LEAD



Images above are just a representation of the package family, actual package may vary.  
Refer to the product data sheet for package details.

4204104/H

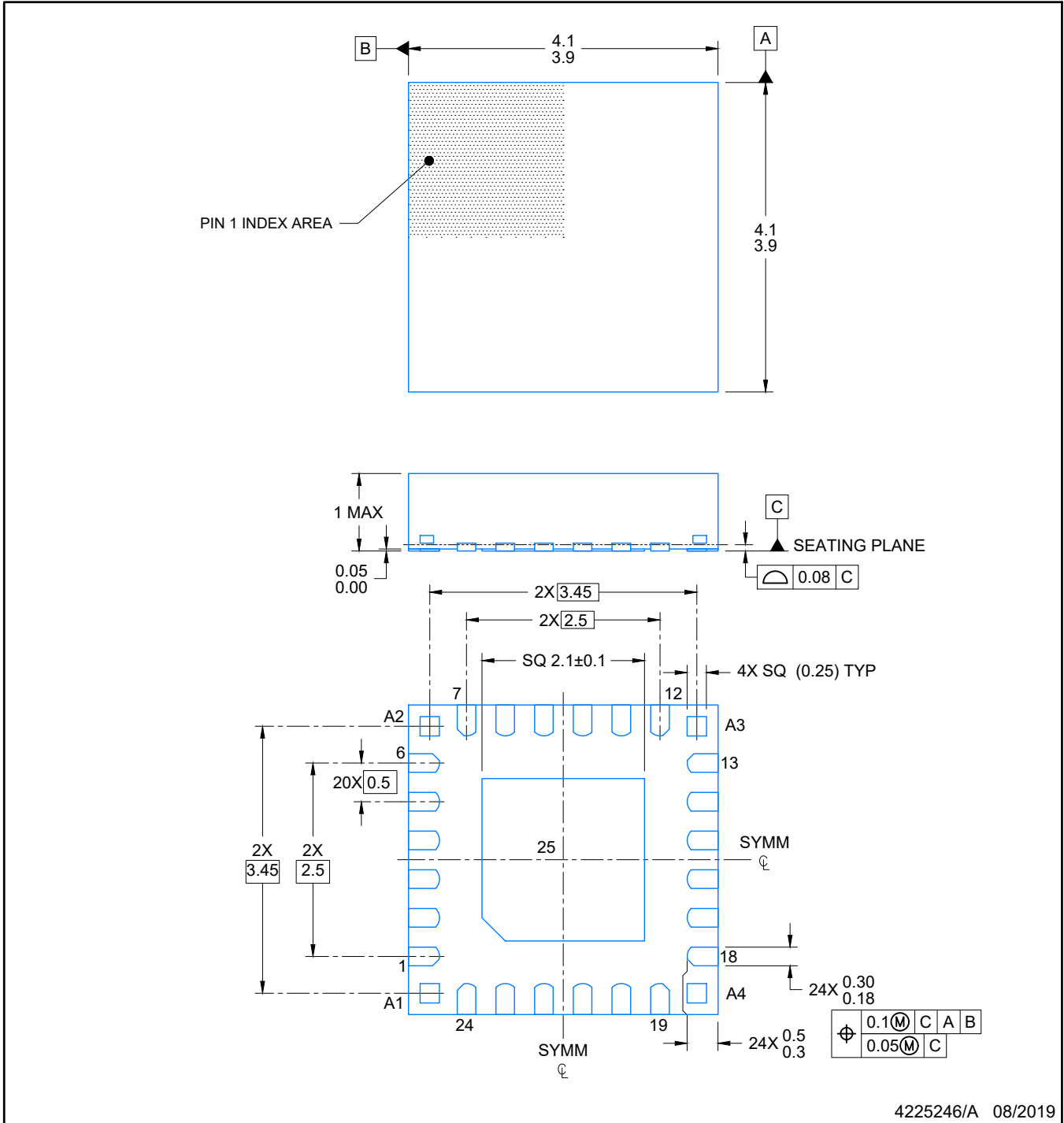

NOTES:

1. All linear dimensions are in millimeters. Any dimensions in parenthesis are for reference only. Dimensioning and tolerancing per ASME Y14.5M.
2. This drawing is subject to change without notice.
3. The package thermal pad must be soldered to the printed circuit board for optimal thermal and mechanical performance.

# EXAMPLE BOARD LAYOUT

RGE0024R

VQFN - 1 mm max height

PLASTIC QUAD FLATPACK-NO LEAD

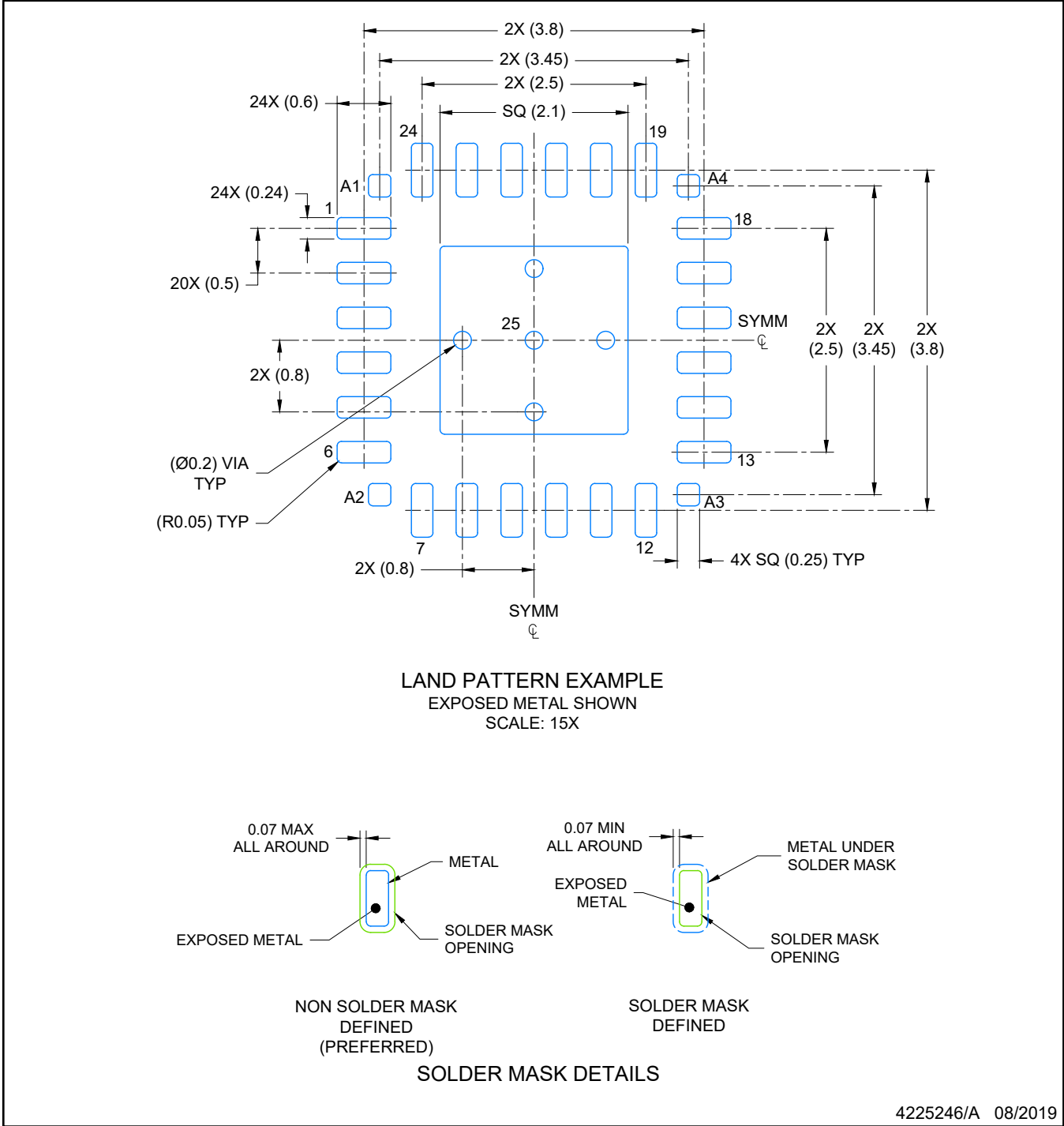

NOTES: (continued)

4. This package is designed to be soldered to a thermal pad on the board. For more information, see Texas Instruments literature number SLUA271 ([www.ti.com/lit/slua271](http://www.ti.com/lit/slua271)).
5. Vias are optional depending on application, refer to device data sheet. If any vias are implemented, refer to their locations shown on this view. It is recommended that vias under paste be filled, plugged or tented.

# EXAMPLE STENCIL DESIGN

VQFN - 1 mm max height

RGE0024R

PLASTIC QUAD FLATPACK-NO LEAD

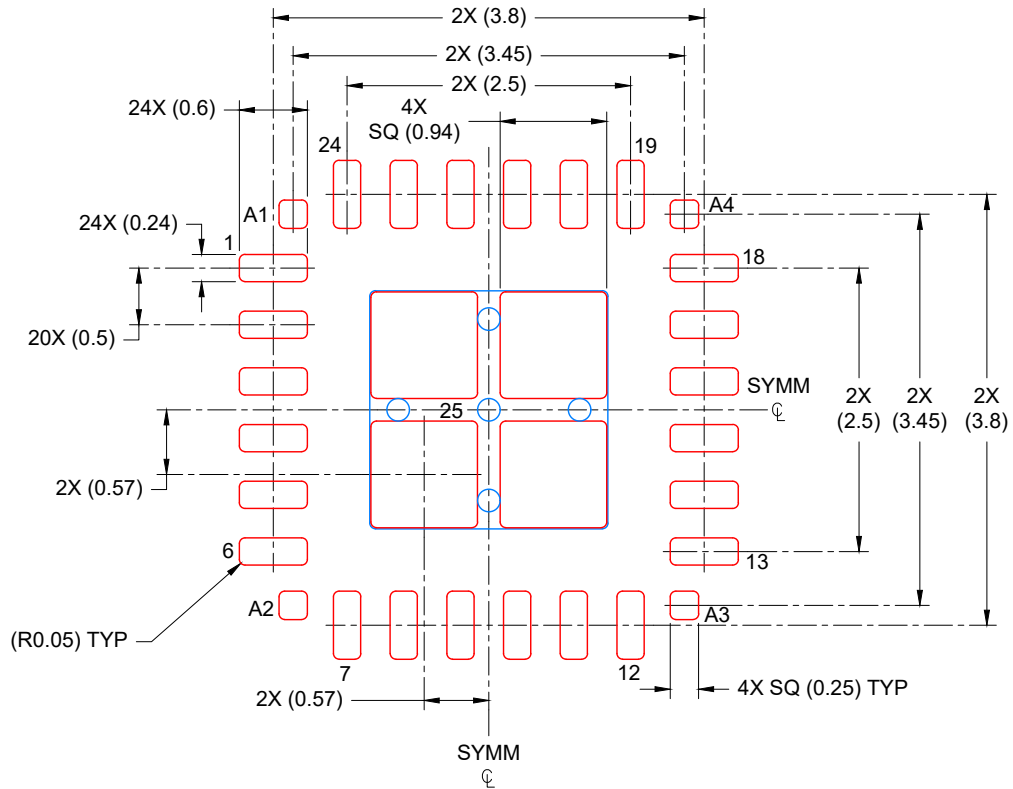

SOLDER PASTE EXAMPLE  
BASED ON 0.125 mm THICK STENCIL

EXPOSED PAD  
80% PRINTED COVERAGE BY AREA  
SCALE: 15X

4225246/A 08/2019

NOTES: (continued)

6. Laser cutting apertures with trapezoidal walls and rounded corners may offer better paste release. IPC-7525 may have alternate design recommendations.



## 重要なお知らせと免責事項

TI は、技術データと信頼性データ（データシートを含みます）、設計リソース（リファレンス・デザインを含みます）、アプリケーションや設計に関する各種アドバイス、Web ツール、安全性情報、その他のリソースを、欠陥が存在する可能性のある「現状のまま」提供しており、商品性および特定目的に対する適合性の黙示保証、第三者の知的財産権の非侵害保証を含むいかなる保証も、明示的または黙示的にかかわらず拒否します。

これらのリソースは、TI 製品を使用する設計の経験を積んだ開発者への提供を意図したものです。(1) お客様のアプリケーションに適した TI 製品の選定、(2) お客様のアプリケーションの設計、検証、試験、(3) お客様のアプリケーションに該当する各種規格や、その他のあらゆる安全性、セキュリティ、規制、または他の要件への確実な適合に関する責任を、お客様のみが単独で負うものとし、

上記の各種リソースは、予告なく変更される可能性があります。これらのリソースは、リソースで説明されている TI 製品を使用するアプリケーションの開発の目的でのみ、TI はその使用をお客様に許諾します。これらのリソースに関して、他の目的で複製することや掲載することは禁止されています。TI や第三者の知的財産権のライセンスが付与されている訳ではありません。お客様は、これらのリソースを自身で使用した結果発生するあらゆる申し立て、損害、費用、損失、責任について、TI およびその代理人を完全に補償するものとし、TI は一切の責任を拒否します。

TI の製品は、[TI の販売条件](#)、または [ti.com](#) やかかる TI 製品の関連資料などのいずれかを通じて提供する適用可能な条項の下で提供されています。TI がこれらのリソースを提供することは、適用される TI の保証または他の保証の放棄の拡大や変更を意味するものではありません。

お客様がいかなる追加条項または代替条項を提案した場合でも、TI はそれらに異議を唱え、拒否します。

郵送先住所：Texas Instruments, Post Office Box 655303, Dallas, Texas 75265  
Copyright © 2024, Texas Instruments Incorporated