

THVD24xxV 柔軟な I/O 電源に対応した、IEC ESD 対応、 $\pm 70V$ 故障保護機能搭載、3V~5.5V RS-485 トランシーバ

1 特長

- TIA/EIA-485A および TIA/EIA-422B 規格の要件に適合またはそれを上回る性能
- 3V~5.5V の入力電源電圧
- 5V 電源で 2.1V を超える差動出力により PROFIBUS に準拠
- ロジック信号インターフェイス用の 1.65V~5.5V 電源
- SLR ピンで選択可能なデータレート:
 - THVD2410V, THVD2412V: 250kbps, 1Mbps
 - THVD2450V, THVD2452V: 20Mbps, 50Mbps
- バス I/O 保護
 - DC $\pm 70V$ バス フォルト
 - $\pm 16kV$ HBM ESD
 - 半二重デバイス: $\pm 15kV$ IEC 61000-4-2 接触および気中放電
 - 全二重デバイス: $\pm 8kV$ IEC 61000-4-2 接触および気中放電
 - $\pm 4kV$ IEC 61000-4-4 高速過渡バースト
- 2 つの速度グレードに対応する半二重および全二重デバイス
- 拡張周囲温度範囲: $-40^{\circ}C \sim 125^{\circ}C$
- 広い動作同相範囲: $\pm 25V$
- レシーバのヒステリシスを大きくすることでノイズ耐性を確保
- 低消費電力
 - 小さいシャットダウン時消費電流: $< 5\mu A$
 - 動作中の静止電流: $< 5.3mA$
- グリッチなしの電源オン / オフによるホット プラグイン機能
- 開放、短絡、アイドル バスのフェイルセーフ
- サーマル シャットダウン
- $-7V \sim 12V$ の同相範囲で 1/8 ユニット負荷 (最大 256 のバス ノード)
- 基板面積を削減できる小型 3mm x 3mm VSON パッケージ、またはドロップイン互換の 14-SOIC パッケージ

2 アプリケーション

- モーター・ドライブ
- ファクトリ・オートメーション / 制御
- HVAC システム
- ビル・オートメーション
- グリッド・インフラストラクチャ
- 電気メーター
- プロセス分析
- ビデオ監視

3 概要

THVD24xxV は、1.65V~5.5V のロジック信号インターフェイス用電源と 3V~5.5V のバス側電源を使用する、 $\pm 70V$ 障害保護機能付き半二重および全二重 RS-422/RS-485 トランシーバです。これらのデバイスはスルーレート選択機能を備えています。このスルーレート選択機能を使うと、SLR ピンの設定に基づいて 2 つの最大速度でこれらのデバイスを使うことができます。

IEC ESD 保護機能を内蔵しているため、システムレベルの外部保護部品は不要です。入力同相範囲が $\pm 25V$ と広いため、長いケーブルを使用する場合やグラウンド ループ電圧が大きい場合でもデータ通信の信頼性を高めることができます。250mV の大きなレシーバ ヒステリシスにより、高いノイズ除去性能を実現します。また、レシーバのフェイルセーフ機能により、入力が開放または短絡した場合、出力が確実に論理 High に固定されます。

パッケージ情報

部品番号	パッケージ (1)	パッケージ サイズ (2)
THVD2450V THVD2410V	VSON (10)	3mm x 3mm
THVD2412V THVD2452V	SOIC (14)	8.65mm x 3.91mm

- (1) 詳細については、[セクション 11](#) を参照してください。
- (2) パッケージ サイズ (長さ x 幅) は公称値であり、該当する場合はピンも含まれます。

表 3-1. 製品情報

部品番号	二重	最大データレート
THVD2410V	半	SLR = High, 250kbps
THVD2412V	フル	SLR = Low, 1Mbps
THVD2450V	半	SLR = High, 20Mbps
THVD2452V	フル	SLR = Low, 50Mbps

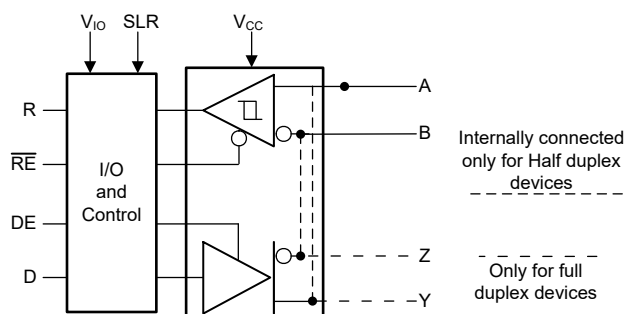

概略回路図



Table of Contents

1 特長	1	7.1 Overview.....	19
2 アプリケーション	1	7.2 Functional Block Diagrams.....	19
3 概要	1	7.3 Feature Description.....	19
4 Pin Configuration and Functions	3	7.4 Device Functional Modes.....	20
5 Specifications	5	8 Application and Implementation	22
5.1 Absolute Maximum Ratings.....	5	8.1 Application Information.....	22
5.2 ESD Ratings	5	8.2 Typical Application.....	22
5.3 ESD Ratings [IEC].....	5	8.3 Power Supply Recommendations.....	28
5.4 Recommended Operating Conditions.....	6	8.4 Layout.....	28
5.5 Thermal Information.....	6	9 Device and Documentation Support	29
5.6 Power Dissipation.....	7	9.1 Device Support.....	29
5.7 Electrical Characteristics.....	8	9.2 ドキュメントの更新通知を受け取る方法.....	29
5.8 Switching Characteristics_250 kbps.....	10	9.3 サポート・リソース.....	29
5.9 Switching Characteristics_1 Mbps.....	11	9.4 商標.....	29
5.10 Switching Characteristics_20 Mbps.....	12	9.5 静電気放電に関する注意事項.....	29
5.11 Switching Characteristics_50 Mbps.....	13	9.6 用語集.....	29
5.12 Typical Characteristics.....	14	10 Revision History	29
6 Parameter Measurement Information	17	11 Mechanical, Packaging, and Orderable Information	29
7 Detailed Description	19		

4 Pin Configuration and Functions



図 4-1. THVD2410V, THVD2450V
10-Pin DRC Package (VSON)
Top View

表 4-1. Pin Functions

NO.	NAME	TYPE	DESCRIPTION
1	V _{IO}	Logic Supply	Supply for logic I/O signals (R, RE, D, DE, and SLR)
2	R	Digital Output	Receive data output
3	DE	Digital Input	Driver enable input; integrated pull-down
4	RE	Digital Input	Receiver enable input; integrated pull-up
5	D	Digital Input	Transmission data input; integrated pull-up
6	GND	Reference Potential	Local device ground
7	SLR	Digital Input	Slew rate select. For THVD2410V: Low = 1 Mbps, High = 250 kbps. Defaults to 1 Mbps if SLR is left floating. For THVD2450V: Low = 50 Mbps, High = 20 Mbps. Defaults to 50 Mbps if left floating.
8	A	Bus I/O	RS 485 bus I/O, A
9	B	Bus I/O	RS 485 bus I/O, B
10	V _{CC}	Bus Supply	Bus supply
	Thermal Pad	--	Connect to GND for optimal thermal performance

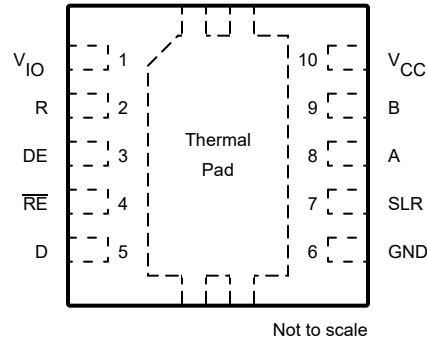
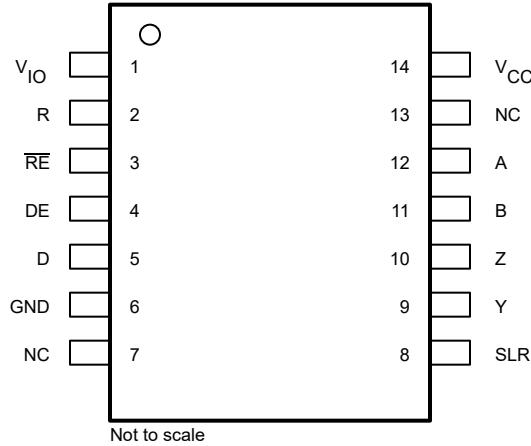

**図 4-2. THVD2412V, THVD2452V
 14-Pin SOIC Package (D)
 Top View**

表 4-2. Pin functions

NO.	NAME	TYPE	DESCRIPTION
1	V _{IO}	Logic supply	1.65 V to 5.5 V supply for logic I/O signals (R, RE, D, DE and SLR)
2	R	Digital output	Receive data output
3	RE	Digital input	Receiver enable input; integrated pull-up
4	DE	Digital input	Driver enable input; integrated pull-down
5	D	Digital input	Transmission data input; integrated pull-up
6	GND	Reference potential	Local device ground
7	NC	No connect	Not connected internally
8	SLR	Digital input	Slew rate select. For THVD2412V: Low = 1 Mbps, High = 250 kbps. Defaults to 1 Mbps if SLR is left floating. For THVD2452V: Low = 50 Mbps, High = 20 Mbps. Defaults to 50 Mbps if left floating.
9	Y	Bus output	RS 485 driver non-inverting output
10	Z	Bus output	RS 485 driver inverting output
11	B	Bus input	RS 485 receiver inverting input
12	A	Bus input	RS 485 receiver non-inverting input
13	NC	No connect	Not connected internally
14	V _{CC}	Bus supply	3 V to 5.5 V bus supply

5 Specifications

5.1 Absolute Maximum Ratings

over operating free-air temperature range (unless otherwise noted) ⁽¹⁾⁽²⁾

		MIN	MAX	UNIT
Logic supply voltage	V_{IO}	-0.5	$V_{CC} + 0.2$	V
Bus supply voltage	V_{CC}	-0.5	6.5	V
Bus voltage	Range at any bus pin as differential or common-mode with respect to GND	-70	70	V
Input voltage	Range at any logic pin (D, DE, SLR or \overline{RE})	-0.3	$V_{IO} + 0.2$	V
Receiver output current	I_O	-24	24	mA
Storage temperature	T_{stg}	-65	170	°C

- Operation outside the Absolute Maximum Ratings may cause permanent device damage. Absolute Maximum Ratings do not imply functional operation of the device at these or any other conditions beyond those listed under Recommended Operating Conditions. If used outside the Recommended Operating Conditions but within the Absolute Maximum Ratings, the device may not be fully functional, and this may affect device reliability, functionality, performance, and shorten the device lifetime.
- All voltage values, except differential I/O bus voltages, are with respect to ground terminal.

5.2 ESD Ratings

			VALUE	UNIT	
$V_{(ESD)}$	Electrostatic discharge	Human-body model (HBM), per ANSI/ESDA/ JEDEC JS-001 ⁽¹⁾	Bus terminals and GND	±16,000	V
			All pins except bus terminals and GND	±4,000	V
		Charged-device model (CDM), per JEDEC specification JESD22-C101 ⁽²⁾	±1,500	V	

- JEDEC document JEP155 states that 500-V HBM allows safe manufacturing with a standard ESD control process.
- JEDEC document JEP157 states that 250-V CDM allows safe manufacturing with a standard ESD control process.

5.3 ESD Ratings [IEC]

				VALUE	UNIT
$V_{(ESD)}$	Electrostatic discharge, Half duplex devices THVD2410V/ 2450V ⁽¹⁾	Contact discharge, per IEC 61000-4-2	Bus terminals and GND	±15,000	V
		Air-gap discharge, per IEC 61000-4-2	Bus terminals and GND	±15,000	
$V_{(ESD)}$	Electrostatic discharge, Full duplex devices THVD2412V/ 2452V	Contact discharge, per IEC 61000-4-2	Bus terminals and GND	±8,000	V
		Air-gap discharge, per IEC 61000-4-2	Bus terminals and GND	±8,000	
$V_{(EFT)}$	Electrical fast transient	Per IEC 61000-4-4	Bus terminals	±4,000	V

- For optimised IEC ESD performance, it is recommended to have series resistor ($\geq 50 \Omega$) on all logic inputs to minimize transient currents going into or out of the logic pins.

5.4 Recommended Operating Conditions

over operating free-air temperature range (unless otherwise noted)

		MIN	NOM	MAX	UNIT
V _{CC}	Supply voltage	3		5.5	V
V _{IO}	I/O supply voltage	1.65		V _{CC}	V
V _I	Input voltage at any bus terminal (separately or common mode) ⁽¹⁾	-25		25	V
V _{IH}	High-level input voltage (driver, driver enable, receiver enable and slew rate select inputs)	0.7*V _{IO}		V _{IO}	V
V _{IL}	Low-level input voltage (driver, driver enable, receiver enable and slew rate select inputs)	0		0.3*V _{IO}	V
V _{ID}	Differential input voltage bus pins	-25		25	V
I _O	Output current, driver	-60		60	mA
I _{OR}	Output current, receiver		V _{IO} = 1.8 V or 2.5 V	4	mA
I _{OR}	Output current, receiver		V _{IO} = 3.3 V or 5 V	8	mA
R _L	Differential load resistance	54	60		Ω
1/t _{UI}	Signaling rate	THVD2410V, THVD2412V with SLR = V _{IO}		250	kbps
		THVD2410V, THVD2412V with SLR = GND or floating		1	Mbps
		THVD2450V, THVD2452V with SLR = V _{IO}		20	Mbps
		THVD2450V, THVD2452V with SLR = GND or floating		50	Mbps
T _A	Operating ambient temperature	-40		125	°C
T _J	Junction temperature	-40		150	°C

(1) The algebraic convention, in which the least positive (most negative) limit is designated as minimum is used in this data sheet.

5.5 Thermal Information

THERMAL METRIC ⁽¹⁾		THVD2410V THVD2450V	THVD2412V THVD2452V	UNIT
		DRC (VSON)	D (SOIC)	
		10 PINS	14 PINS	
R _{θJA}	Junction-to-ambient thermal resistance	46.7	87.5	°C/W
R _{θJC(top)}	Junction-to-case (top) thermal resistance	47.7	41.8	°C/W
R _{θJB}	Junction-to-board thermal resistance	19.1	43.7	°C/W
ψ _{JT}	Junction-to-top characterization parameter	0.7	8.1	°C/W
ψ _{JB}	Junction-to-board characterization parameter	19.1	43.3	°C/W
R _{θJC(bot)}	Junction-to-case (bottom) thermal resistance	4.6	N/A	°C/W

(1) For more information about traditional and new thermal metrics, see the [Semiconductor and IC Package Thermal Metrics](#) application report.

5.6 Power Dissipation

PARAMETER		TEST CONDITIONS		VALUE	UNIT	
P _D	Driver and receiver enabled, loopback for full duplex devices (A connected to Y, B connected to Z) V _{CC} = 5.5 V, T _A = 125 °C, square wave at 50% duty cycle	Unterminated R _L = 300 Ω, C _L = 50 pF (driver)	THVD2410V, THVD2412V	250 kbps	160	mW
			THVD2410V, THVD2412V	1Mbps	250	
			THVD2450V, THVD2452V	20Mbps	310	
			THVD2450V, THVD2452V	50 Mbps	630	
		RS-422 load R _L = 100 Ω, C _L = 50 pF (driver)	THVD2410V, THVD2412V	250 kbps	170	mW
			THVD2410V, THVD2412V	1Mbps	250	
			THVD2450V, THVD2452V	20Mbps	290	
			THVD2450V, THVD2452V	50 Mbps	570	
		RS-485 load R _L = 54 Ω, C _L = 50 pF (driver)	THVD2410V, THVD2412V	250 kbps	220	mW
			THVD2410V, THVD2412V	1Mbps	280	
			THVD2450V, THVD2452V	20Mbps	325	
			THVD2450V, THVD2452V	50 Mbps	560	

5.7 Electrical Characteristics

over operating free-air temperature range (unless otherwise noted). All typical values are at 25°C and supply voltage of $V_{CC} = 5\text{ V}$, $V_{IO} = 3.3\text{ V}$, unless otherwise noted. ⁽¹⁾

PARAMETER		TEST CONDITIONS	MIN	TYP	MAX	UNIT		
Driver								
$ V_{OD} $	Driver differential output voltage magnitude	$R_L = 60\ \Omega$, $-25\text{ V} \leq V_{\text{test}} \leq 25\text{ V}$ (See 6-1)	1.5	3.3		V		
		$R_L = 60\ \Omega$, $-25\text{ V} \leq V_{\text{test}} \leq 25\text{ V}$, $4.5\text{ V} \leq V_{CC} \leq 5.5\text{ V}$ (See 6-1)	2.1	3.3		V		
		$R_L = 100\ \Omega$ (See 6-2)	2	4		V		
		$R_L = 54\ \Omega$ (See 6-2)	1.5	3.5		V		
$\Delta V_{OD} $	Change in differential output voltage	$R_L = 54\ \Omega$ or $100\ \Omega$ (See 6-2)	-50		50	mV		
V_{OC}	Common-mode output voltage	$R_L = 54\ \Omega$ or $100\ \Omega$ (See 6-2)	1	$V_{CC}/2$	3	V		
$\Delta V_{OC(SS)}$	Change in steady-state common-mode output voltage	$R_L = 54\ \Omega$ or $100\ \Omega$ (See 6-2)	-50		50	mV		
I_{OS}	Short-circuit output current	$DE = V_{IO}$, $-70\text{ V} \leq (V_A \text{ or } V_B) \leq 70\text{ V}$, or A shorted to B (A,B are driver terminals for half duplex, Y/Z are for full duplex)	-250		250	mA		
Receiver								
I_I	Bus input current	$DE = 0\text{ V}$, V_{CC} and $V_{IO} = 0\text{ V}$ or 5.5 V	$V_I = 12\text{ V}$	90	125	μA		
			$V_I = 25\text{ V}$	200	250	μA		
			$V_I = -7\text{ V}$	-100	-80	μA		
			$V_I = -25\text{ V}$	-350	-220	μA		
V_{TH+}	Positive-going input threshold voltage ⁽²⁾	Over common-mode range of $\pm 25\text{ V}$	THVD2410V, THVD2450V		40	125	200	mV
V_{TH-}	Negative-going input threshold voltage ⁽²⁾	Over common-mode range of $\pm 25\text{ V}$	THVD2410V, THVD2450V		-200	-125	-40	mV
V_{TH+}	Positive-going input threshold voltage ⁽²⁾	Over common-mode range of $\pm 25\text{ V}$	THVD2412V, THVD2452V		20	125	200	mV
V_{TH-}	Negative-going input threshold voltage ⁽²⁾	Over common-mode range of $\pm 25\text{ V}$	THVD2412V, THVD2452V		-200	-125	-20	mV
V_{HYS}	Input hysteresis	Over common-mode range of $\pm 25\text{ V}$		250		mV		
V_{TH_FSH}	Input fail-safe threshold	Over common-mode range of $\pm 25\text{ V}$	THVD2410V, THVD2450V		-40		40	mV
V_{TH_FSH}	Input fail-safe threshold	Over common-mode range of $\pm 25\text{ V}$	THVD2412V, THVD2452V		-20		20	mV
$C_{A,B}$	Input differential capacitance	Measured between A and B, $f = 1\text{ MHz}$		50		pF		
V_{OH}	Output high voltage	$I_{OH} = -8\text{ mA}$, $V_{IO} = 3\text{ to }3.6\text{ V}$ or $4.5\text{ V to }5.5\text{ V}$	$V_{IO} - 0.4$	$V_{IO} - 0.2$		V		
V_{OL}	Output low voltage	$I_{OL} = 8\text{ mA}$, $V_{IO} = 3\text{ to }3.6\text{ V}$ or $4.5\text{ V to }5.5\text{ V}$		0.2	0.4	V		
V_{OH}	Output high voltage	$I_{OH} = -4\text{ mA}$, $V_{IO} = 1.65\text{ to }1.95\text{ V}$ or $2.25\text{ V to }2.75\text{ V}$	$V_{IO} - 0.4$	$V_{IO} - 0.2$		V		
V_{OL}	Output low voltage	$I_{OL} = 4\text{ mA}$, $V_{IO} = 1.65\text{ to }1.95\text{ V}$ or $2.25\text{ V to }2.75\text{ V}$		0.2	0.4	V		
I_{OZ}	Output high-impedance current, R pin	$V_O = 0\text{ V}$ or V_{IO} , $RE = V_{IO}$	-1		1	μA		
Logic								
I_{IN}	Input current (DE, SLR)	$1.65\text{ V} \leq V_{IO} \leq 5.5\text{ V}$, $0\text{ V} \leq V_{IN} \leq V_{IO}$			5	μA		
I_{IN}	Input current (D, RE)	$1.65\text{ V} \leq V_{IO} \leq 5.5\text{ V}$, $0\text{ V} \leq V_{IN} \leq V_{IO}$	-5			μA		
Thermal Protection								
T_{SHDN}	Thermal shutdown threshold	Temperature rising	150	180		°C		
T_{HYS}	Thermal shutdown hysteresis			10		°C		
Supply								
UV_{VCC} (rising)	Rising under-voltage threshold on V_{CC}			2.3	2.6	V		

5.7 Electrical Characteristics (続き)

over operating free-air temperature range (unless otherwise noted). All typical values are at 25°C and supply voltage of $V_{CC} = 5\text{ V}$, $V_{IO} = 3.3\text{ V}$, unless otherwise noted. ⁽¹⁾

PARAMETER		TEST CONDITIONS		MIN	TYP	MAX	UNIT
UV_{VCC} (falling)	Falling under-voltage threshold on V_{CC}			1.95	2.2		V
$UV_{VCC(hys)}$	Hysteresis on under-voltage of V_{CC}				170		mV
UV_{VIO} (rising)	Rising under-voltage threshold on V_{IO}				1.4	1.6	V
UV_{VIO} (falling)	Falling under-voltage threshold on V_{IO}			1.2	1.3		V
$UV_{VIO(hys)}$	Hysteresis on under-voltage of V_{IO}				120		mV
I_{CC}	Supply current (quiescent), $V_{CC} = 4.5\text{ V to }5.5\text{ V}$	Driver and receiver enabled	$\overline{RE} = 0\text{ V}$, $DE = V_{IO}$, No load		3.5	5.3	mA
		Driver enabled, receiver disabled	$\overline{RE} = V_{IO}$, $DE = V_{IO}$, No load		2.5	4.2	mA
		Driver disabled, receiver enabled	$\overline{RE} = 0\text{ V}$, $DE = 0\text{ V}$, No load		1.8	2.4	mA
		Driver and receiver disabled	$\overline{RE} = V_{IO}$, $DE = 0\text{ V}$, $D = \text{open}$, No load		0.1	1.2	μA
I_{CC}	Supply current (quiescent), $V_{CC} = 3\text{ V to }3.6\text{ V}$	Driver and receiver enabled	$\overline{RE} = 0\text{ V}$, $DE = V_{IO}$, No load		3	4.1	mA
		Driver enabled, receiver disabled	$\overline{RE} = V_{IO}$, $DE = V_{IO}$, No load		2	3	mA
		Driver disabled, receiver enabled	$\overline{RE} = 0\text{ V}$, $DE = 0\text{ V}$, No load		1.6	2.2	mA
		Driver and receiver disabled	$\overline{RE} = V_{IO}$, $DE = 0\text{ V}$, $D = \text{open}$, No load		0.1	1	μA
I_{IO}	Logic supply current (quiescent), $V_{IO} = 3\text{ to }3.6\text{ V}$	Driver disabled, Receiver enabled, $SLR = \text{GND}$	$DE = 0\text{ V}$, $\overline{RE} = 0\text{ V}$, No load		4.5	8.4	μA
		Driver disabled, Receiver enabled, $SLR = V_{IO}$	$DE = 0\text{ V}$, $\overline{RE} = 0\text{ V}$, No load		3.3	8.4	μA
		Driver disabled, Receiver disabled, $SLR = \text{GND}$	$DE = 0\text{ V}$, $\overline{RE} = V_{IO}$, No load		0.1	1	μA
		Driver disabled, Receiver disabled, $SLR = V_{IO}$	$DE = 0\text{ V}$, $\overline{RE} = V_{IO}$, No load		1.8	4	μA

- (1) A, B are driver output and receiver input terminals for Half duplex devices; A/B are Receiver input, Y/Z are driver output terminals for Full duplex devices
(2) Under any specific conditions, V_{TH+} is specified to be at least V_{HYS} higher than V_{TH-} .

5.8 Switching Characteristics_250 kbps

250-kbps (THVD2410V, THVD2412V with SLR = V_{IO}) over recommended operating conditions. All typical values are at 25°C and supply voltage of $V_{CC} = 5\text{ V}$, $V_{IO} = 3.3\text{ V}$, unless otherwise noted. (1)

PARAMETER		TEST CONDITIONS		MIN	TYP	MAX	UNIT
Driver							
t_r, t_f	Differential output rise/fall time	$R_L = 54\ \Omega, C_L = 50\text{ pF}$ See 6-3	$V_{CC} = 3\text{ to }3.6\text{ V}$, Typical at 3.3V	450	560	1200	ns
			$V_{CC} = 4.5\text{ to }5.5\text{ V}$, Typical at 5 V	500	625	1200	ns
t_{PHL}, t_{PLH}	Propagation delay		$V_{CC} = 3\text{ to }3.6\text{ V}$, Typical at 3.3V		500	720	ns
			$V_{CC} = 4.5\text{ to }5.5\text{ V}$, Typical at 5 V		540	770	ns
$t_{SK(P)}$	Pulse skew, $ t_{PHL} - t_{PLH} $		$V_{CC} = 3\text{ to }3.6\text{ V}$, Typical at 3.3V		10	70	ns
			$V_{CC} = 4.5\text{ to }5.5\text{ V}$, Typical at 5 V		10	70	ns
t_{PHZ}, t_{PLZ}	Disable time	$\overline{RE} = X$		40	75	ns	
t_{PZH}, t_{PZL}	Enable time	$\overline{RE} = 0\text{ V}$	See 6-4 and 6-5	70	280	ns	
		$\overline{RE} = V_{IO}$		2.5	4.5	μs	
t_{SHDN}	Time to shutdown	$\overline{RE} = V_{IO}$		50	500	ns	
Receiver							
t_r, t_f	Output rise/fall time	$C_L = 15\text{ pF}$	See 6-6		7	20	ns
t_{PHL}, t_{PLH}	Propagation delay				800	1270	ns
$t_{SK(P)}$	Pulse skew, $ t_{PHL} - t_{PLH} $				5	45	ns
t_{PHZ}, t_{PLZ}	Disable time	$DE = X$		30	40	ns	
$t_{PZH(1)}$	Enable time	$V_{IO} = 3\text{ V to }3.6\text{ V}; DE = V_{IO}$	See 6-7		90	120	ns
		$V_{IO} = 1.65\text{ V to }1.95\text{ V}; DE = V_{IO}$			100	130	ns
$t_{PZL(1)}$		$V_{IO} = 3\text{ V to }3.6\text{ V}; DE = V_{IO}$			900	1320	ns
		$V_{IO} = 1.65\text{ V to }1.95\text{ V}; DE = V_{IO}$			900	1320	ns
$t_{PZH(2)}, t_{PZL(2)}$	Enable time	$DE = 0\text{ V}$	See 6-8	3.3	5.4	μs	
$t_{D(OFS)}$	Delay to enter fail-safe operation	$C_L = 15\text{ pF}$	See 6-9	7	11	18	μs
$t_{D(FSO)}$	Delay to exit fail-safe operation			540	800	1260	ns
t_{SHDN}	Time to shutdown	$DE = 0\text{ V}$	See 6-8	50	500	ns	

- (1) A, B are driver output and receiver input terminals for Half duplex devices; A/B are Receiver input, Y/Z are driver output terminals for Full duplex device

5.9 Switching Characteristics_1 Mbps

1Mbps (THVD2410V, THVD2412V with SLR = 0) over recommended operating conditions. All typical values are at 25°C and supply voltage of $V_{CC} = 5\text{ V}$, $V_{IO} = 3.3\text{ V}$, unless otherwise noted. (1)

PARAMETER		TEST CONDITIONS		MIN	TYP	MAX	UNIT	
Driver								
t_r, t_f	Differential output rise/fall time	$R_L = 54\ \Omega, C_L = 50\ \text{pF}$ See 6-3	$V_{CC} = 3\text{ to }3.6\text{ V}$, Typical at 3.3 V	125	150	300	ns	
			$V_{CC} = 4.5\text{ to }5.5\text{ V}$, Typical at 5 V	130	160	300	ns	
t_{PHL}, t_{PLH}	Propagation delay		$V_{CC} = 3\text{ to }3.6\text{ V}$, Typical at 3.3 V		160	240	ns	
			$V_{CC} = 4.5\text{ to }5.5\text{ V}$, Typical at 5 V		185	280	ns	
$t_{SK(P)}$	Pulse skew, $ t_{PHL} - t_{PLH} $		$V_{CC} = 3\text{ to }3.6\text{ V}$, Typical at 3.3 V		2	20	ns	
			$V_{CC} = 4.5\text{ to }5.5\text{ V}$, Typical at 5 V		2	15	ns	
t_{PHZ}, t_{PLZ}	Disable time	$RE = X$			40	95	ns	
t_{PZH}, t_{PZL}	Enable time	$RE = 0\text{ V}$			90	275	ns	
		$RE = V_{IO}$	See 6-4 and 6-5		3	4.6	μs	
t_{SHDN}	Time to shutdown	$RE = V_{IO}$		50		500	ns	
Receiver								
t_r, t_f	Output rise/fall time	$C_L = 15\ \text{pF}$	See 6-6		7	15	ns	
t_{PHL}, t_{PLH}	Propagation delay				50	85	ns	
$t_{SK(P)}$	Pulse skew, $ t_{PHL} - t_{PLH} $				4	12.5	ns	
t_{PHZ}, t_{PLZ}	Disable time	$DE = X$			30	40	ns	
$t_{PZH(1)}, t_{PZL(1)}$	Enable time	$V_{IO} = 3\text{ V to }3.6\text{ V}; DE = V_{IO}$	See 6-7		90	120	ns	
		$V_{IO} = 1.65\text{ V to }1.95\text{ V}; DE = V_{IO}$			90	130	ns	
$t_{PZH(2)}, t_{PZL(2)}$	Enable time	$DE = 0\text{ V}$	See 6-8		3	4.5	μs	
$t_{D(OFS)}$	Delay to enter fail-safe operation	$C_L = 15\ \text{pF}$	See 6-9		7	10	18	μs
$t_{D(FSO)}$	Delay to exit fail-safe operation				27	40	60	ns
t_{SHDN}	Time to shutdown	$DE = 0\text{ V}$	See 6-8		50		500	ns

(1) A, B are driver output and receiver input terminals for Half duplex devices; A/B are Receiver input, Y/Z are driver output terminals for Full duplex device

5.10 Switching Characteristics_20 Mbps

20-Mbps (THVD2450V, THVD2452V with SLR = V_{IO}) over recommended operating conditions. All typical values are at 25°C and supply voltage of V_{CC} = 5 V, V_{IO} = 3.3 V, unless otherwise noted. ⁽¹⁾

PARAMETER		TEST CONDITIONS		MIN	TYP	MAX	UNIT
Driver							
t _r , t _f	Differential output rise/fall time	R _L = 54 Ω, C _L = 50 pF See 6-3	V _{CC} = 3 to 3.6 V, Typical at 3.3 V	4	8	15	ns
			V _{CC} = 4.5 to 5.5 V, Typical at 5 V	4	7	15	ns
t _{PHL} , t _{PLH}	Propagation delay		V _{CC} = 3 to 3.6 V, Typical at 3.3 V	6	12	30	ns
			V _{CC} = 4.5 to 5.5 V, Typical at 5 V	4	9	26	ns
t _{SK(P)}	Pulse skew, t _{PHL} – t _{PLH}		V _{CC} = 3 to 3.6 V, Typical at 3.3 V		1	3	ns
			V _{CC} = 4.5 to 5.5 V, Typical at 5 V		1	3	ns
t _{PHZ} , t _{PLZ}	Disable time	RE = X			17	35	ns
t _{PZH} , t _{PZL}	Enable time	RE = 0 V	See 6-4 and 6-5		14	39	ns
		RE = V _{IO}			3	4.5	μs
t _{SHDN}	Time to shutdown	RE = V _{IO}		50		500	ns
Receiver							
t _r , t _f	Output rise/fall time	C _L = 15 pF	See 6-6		1.5	6	ns
t _{PHL} , t _{PLH}	Propagation delay	V _{IO} = 3 V to 3.6 V		25	33	58	ns
		V _{IO} = 1.65 V to 1.95 V		25	35	60	ns
t _{SK(P)}	Pulse skew, t _{PHL} – t _{PLH}	C _L = 15 pF		0.5	5	ns	
t _{PHZ} , t _{PLZ}	Disable time	DE = X		12	25	ns	
t _{PZH(1)} , t _{PZL(1)}	Enable time	DE = V _{IO}	See 6-7		50	82	ns
t _{PZH(2)} , t _{PZL(2)}	Enable time	DE = 0 V	See 6-8		2.8	5	μs
t _{D(OFS)}	Delay to enter fail-safe operation	C _L = 15 pF	See 6-9	7	10	18	μs
t _{D(FSO)}	Delay to exit fail-safe operation			19	32	50	ns
t _{SHDN}	Time to shutdown	DE = 0 V	See 6-8	50		500	ns

(1) A, B are driver output and receiver input terminals for Half duplex devices; A/B are Receiver input, Y/Z are driver output terminals for Full duplex device

5.11 Switching Characteristics_50 Mbps

50-Mbps (THVD2450V, THVD2452V with SLR = 0) over recommended operating conditions. All typical values are at 25°C and supply voltage of $V_{CC} = 5\text{ V}$, $V_{IO} = 3.3\text{ V}$, unless otherwise noted. (1)

PARAMETER		TEST CONDITIONS		MIN	TYP	MAX	UNIT	
Driver								
t_r, t_f	Differential output rise/fall time	$R_L = 54\ \Omega, C_L = 50\text{ pF}$ See 6-3	$V_{CC} = 3\text{ to }3.6\text{ V}$, Typical at 3.3 V	1	5	7	ns	
			$V_{CC} = 4.5\text{ to }5.5\text{ V}$, Typical at 5 V	1	5	6	ns	
t_{PHL}, t_{PLH}	Propagation delay		$V_{IO} = 3\text{ V to }3.6\text{ V}$, $V_{CC} = 3\text{ to }3.6\text{ V}$, Typical at 3.3 V	5	11	19	ns	
			$V_{IO} = 1.65\text{ V to }1.95\text{ V}$, $V_{CC} = 3\text{ to }3.6\text{ V}$, Typical at 3.3 V	7	12	22	ns	
			$V_{IO} = 3\text{ V to }3.6\text{ V}$, $V_{CC} = 4.5\text{ to }5.5\text{ V}$, Typical at 5 V	4	8	15	ns	
			$V_{IO} = 1.65\text{ V to }1.95\text{ V}$, $V_{CC} = 4.5\text{ to }5.5\text{ V}$, Typical at 5 V	6	10	19	ns	
$t_{SK(P)}$	Pulse skew, $ t_{PHL} - t_{PLH} $	$V_{CC} = 3\text{ to }3.6\text{ V}$, Typical at 3.3 V		1	3	ns		
		$V_{CC} = 4.5\text{ to }5.5\text{ V}$, Typical at 5 V		1	3	ns		
t_{PHZ}, t_{PLZ}	Disable time	$RE = X$			14	30	ns	
t_{PZH}, t_{PZL}	Enable time	$RE = 0\text{ V}$; $V_{IO} = 1.65\text{ V to }1.95\text{ V}$, 2.25 V to 2.75 V	See 6-4 and 6-5		20	35	ns	
		$RE = 0\text{ V}$; $V_{IO} = 3\text{ V to }V_{CC}\text{ V}$			15	32	ns	
		$RE = V_{IO}$			2.5	4.5	μs	
t_{SHDN}	Time to shutdown	$RE = V_{IO}$		50		500	ns	
Receiver								
t_r, t_f	Output rise/fall time	$C_L = 15\text{ pF}$	See 6-6		1.5	6	ns	
t_{PHL}, t_{PLH}	Propagation delay		$V_{IO} = 3\text{ V to }3.6\text{ V}$, See 6-6	25	33	58	ns	
t_{PHL}, t_{PLH}	Propagation delay		$V_{IO} = 1.65\text{ V to }1.95\text{ V}$, See 6-6	25	35	60	ns	
$t_{SK(P)}$	Pulse skew, $ t_{PHL} - t_{PLH} $	$C_L = 15\text{ pF}$	See 6-6		0.5	5	ns	
t_{PHZ}, t_{PLZ}	Disable time	$DE = X$			12	25	ns	
$t_{PZH(1)}, t_{PZL(1)}$	Enable time	$DE = V_{IO}$	$V_{IO} = 1.65\text{ V to }1.95\text{ V}$, See 6-7		50	82	ns	
			$V_{IO} = 3\text{ V to }3.6\text{ V}$, See 6-7		50	75	ns	
$t_{PZH(2)}, t_{PZL(2)}$	Enable time	$DE = 0\text{ V}$	See 6-8		2.8	5	μs	
$t_{D(OFS)}$	Delay to enter fail-safe operation	$C_L = 15\text{ pF}$	See 6-9		7	10	18	μs
$t_{D(FSO)}$	Delay to exit fail-safe operation				19	32	50	ns
t_{SHDN}	Time to shutdown	$DE = 0\text{ V}$	See 6-8		50		500	ns

(1) A, B are driver output and receiver input terminals for Half duplex devices; A/B are Receiver input, Y/Z are driver output terminals for Full duplex device

5.12 Typical Characteristics



图 5-1. Driver Output Voltage vs Driver Output Current



图 5-2. Driver Differential Output voltage vs Driver Output Current

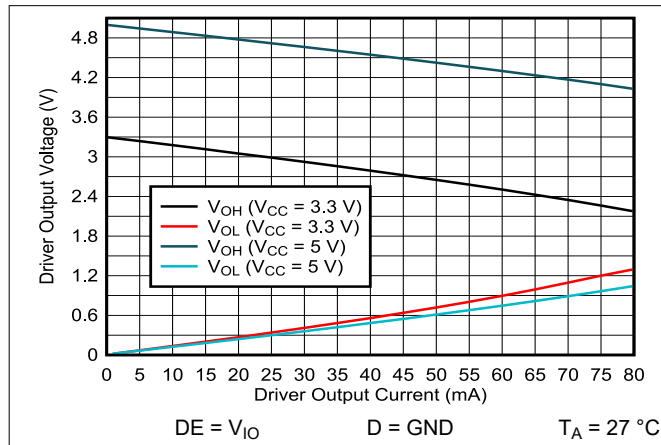

图 5-3. Supply Current vs Supply Voltage

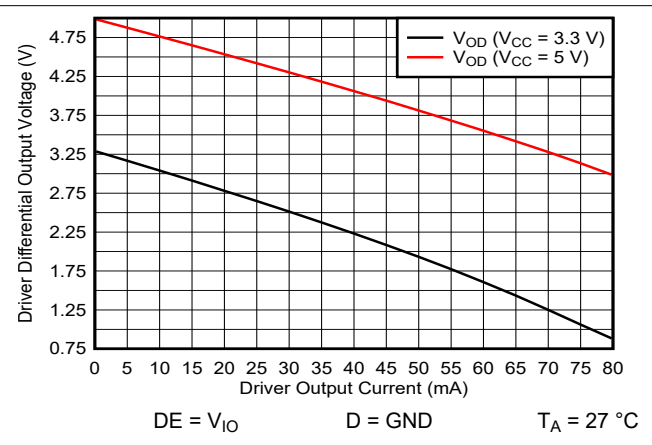

图 5-4. Driver differential output voltage vs Temperature

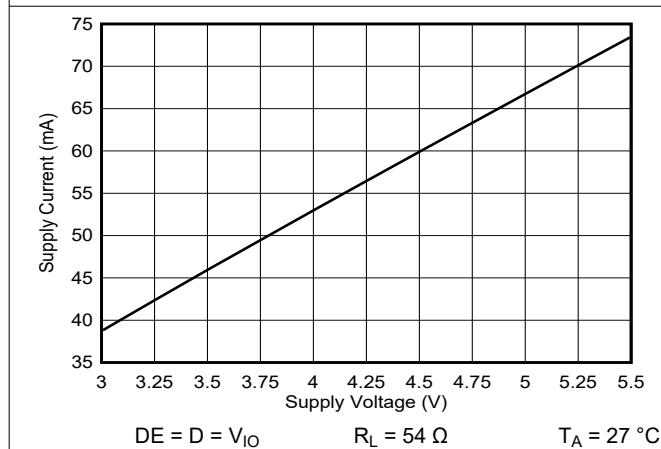

图 5-5. THVD2410V 250kbps Driver rise or fall time vs Temperature

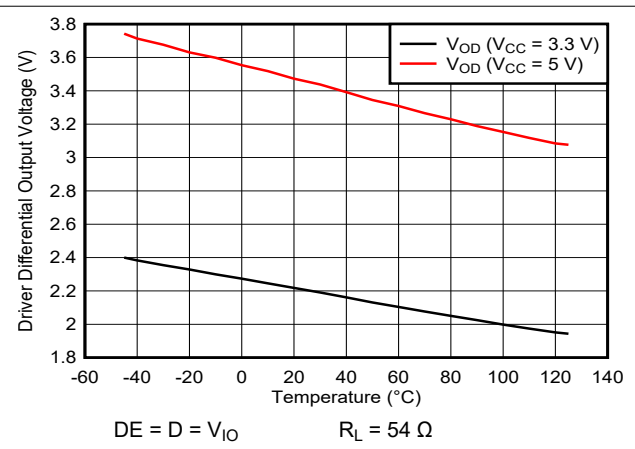

图 5-6. THVD2410V 250kbps Driver propagation delay vs Temperature

5.12 Typical Characteristics (continued)

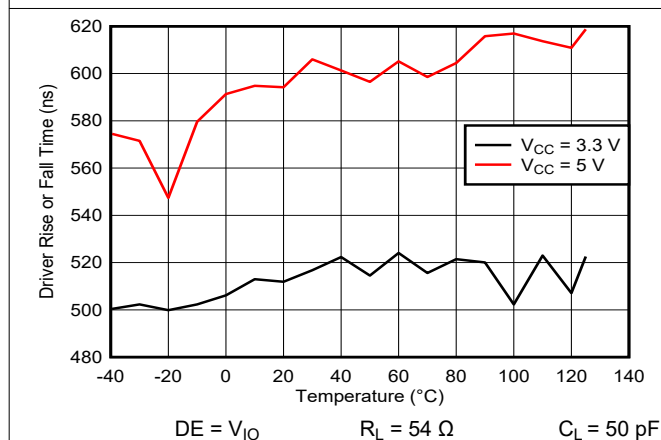

图 5-7. THVD2410V 1Mbps Driver rise or fall time vs Temperature

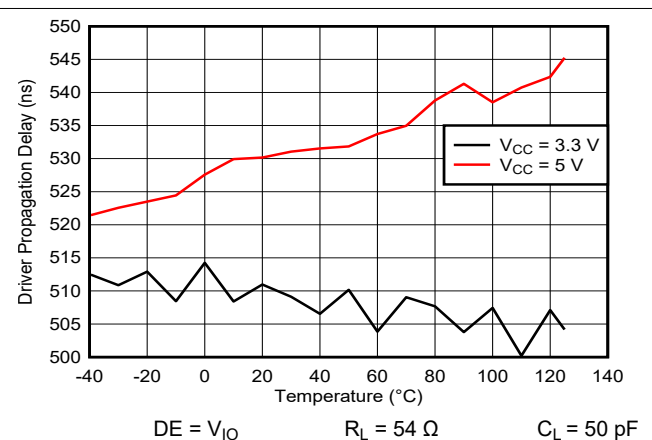

图 5-8. THVD2410V 1Mbps Driver propagation delay vs Temperature

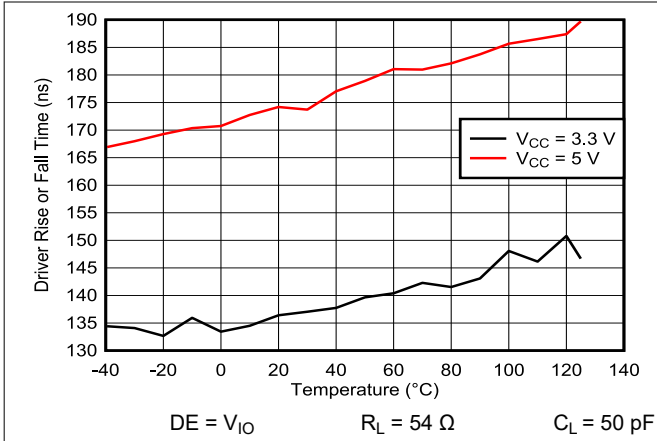

图 5-9. THVD2450V 20Mbps Driver rise or fall time vs Temperature

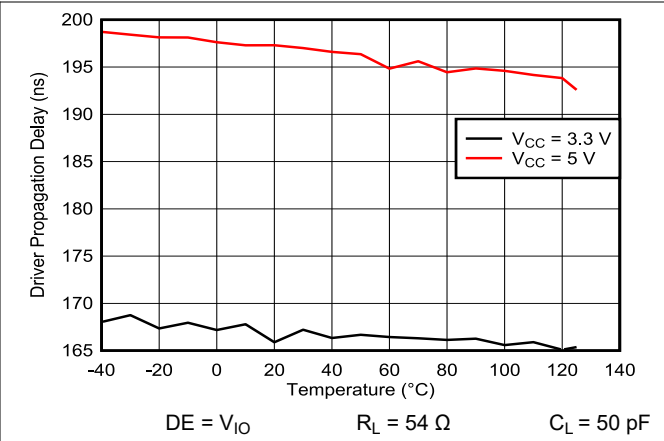

图 5-10. THVD2450V 20Mbps Driver propagation delay vs Temperature

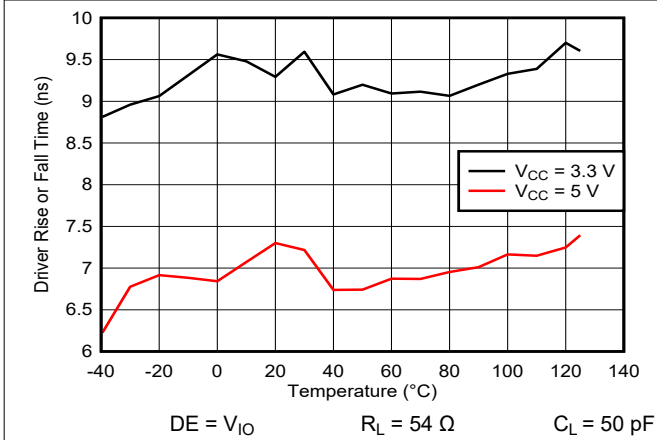

图 5-11. THVD2450V 50Mbps Driver rise or fall time vs Temperature

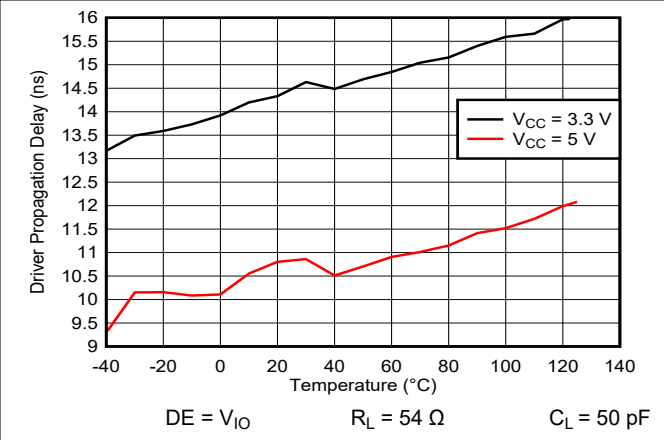

图 5-12. THVD2450V 50Mbps Driver propagation delay vs Temperature

5.12 Typical Characteristics (continued)

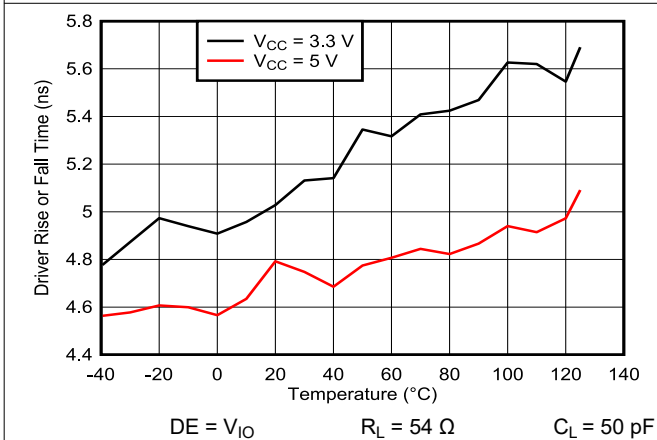

6 Parameter Measurement Information

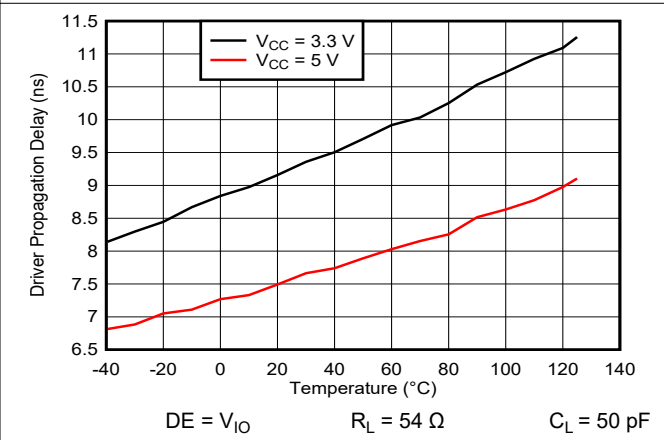
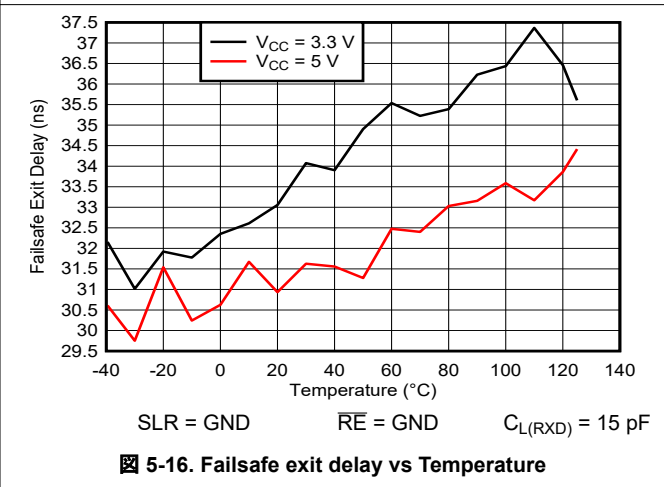
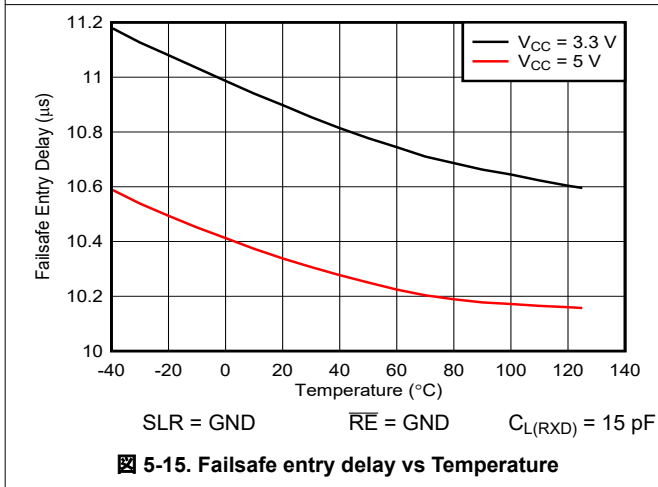
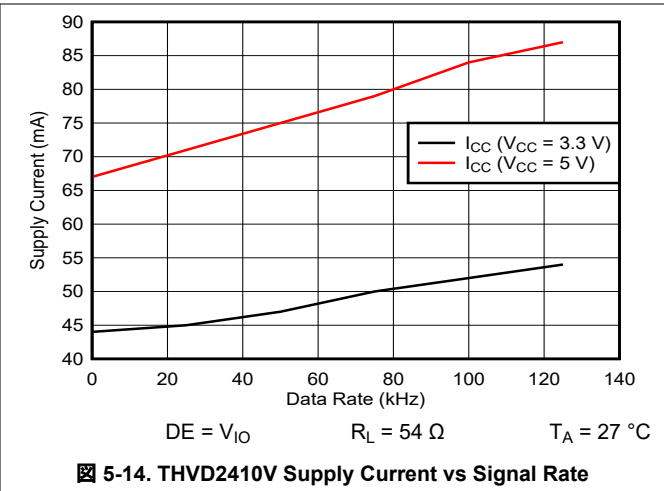
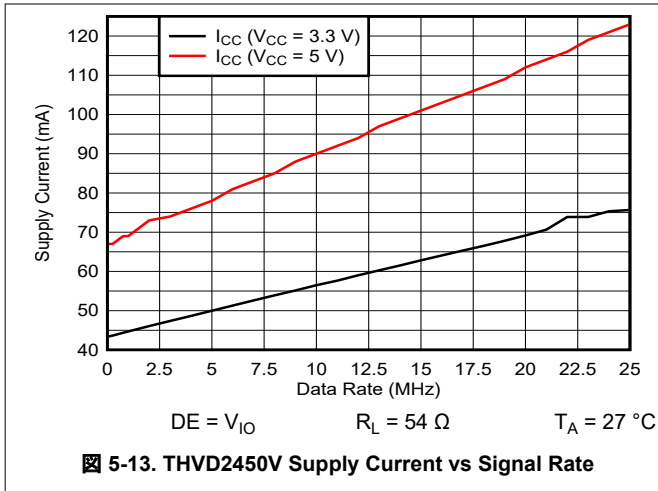
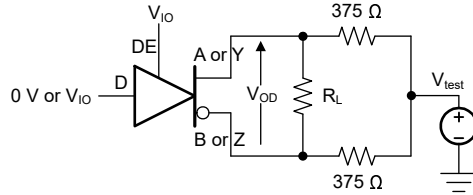

Figure 6-1. Measurement of Driver Differential Output Voltage With Common-Mode Load

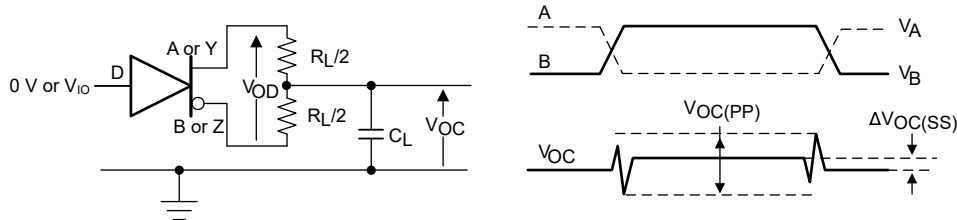

Figure 6-2. Measurement of Driver Differential and Common-Mode Output With RS-485 Load

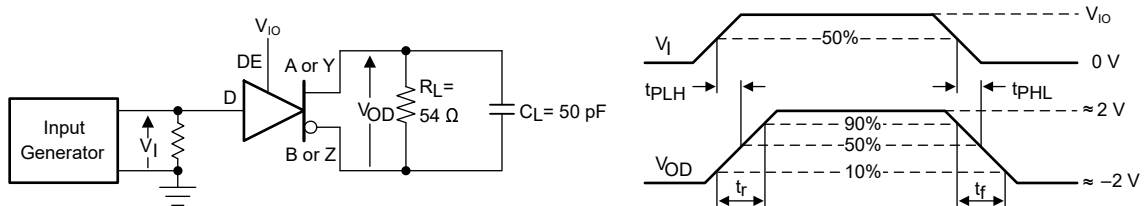

Figure 6-3. Measurement of Driver Differential Output Rise and Fall Times and Propagation Delays

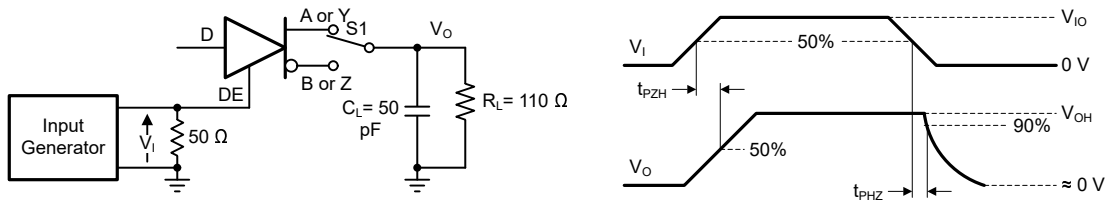

Figure 6-4. Measurement of Driver Enable and Disable Times With Active High Output and Pull-Down Load

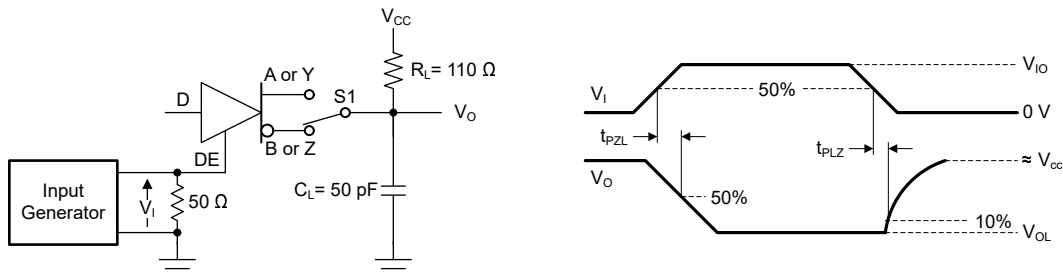

Figure 6-5. Measurement of Driver Enable and Disable Times With Active Low Output and Pull-up Load

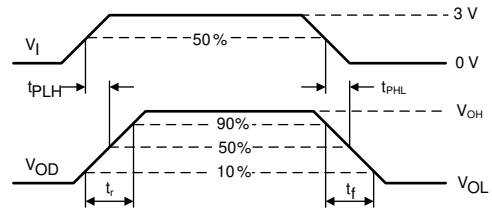
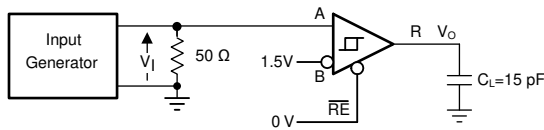

Figure 6-6. Measurement of Receiver Output Rise and Fall Times and Propagation Delays

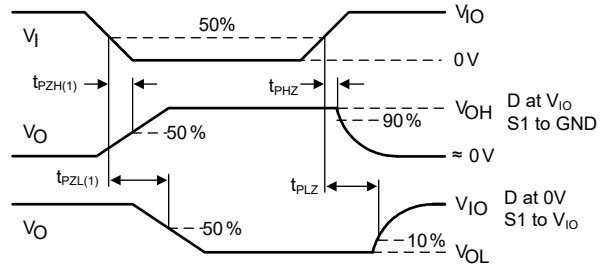
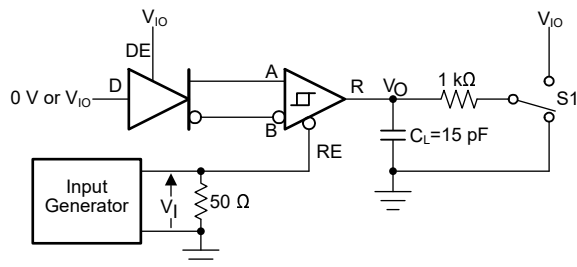

Figure 6-7. Measurement of Receiver Enable/Disable Times With Driver Enabled

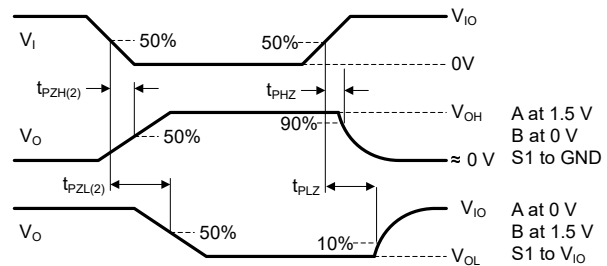
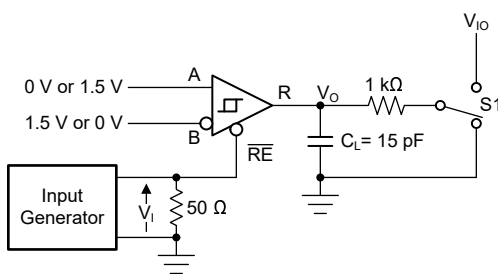

Figure 6-8. Measurement of Receiver Enable Times With Driver Disabled

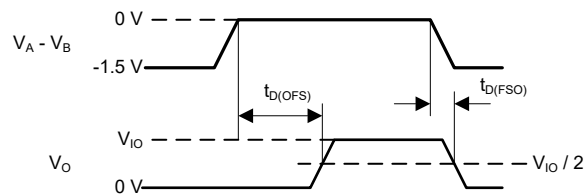
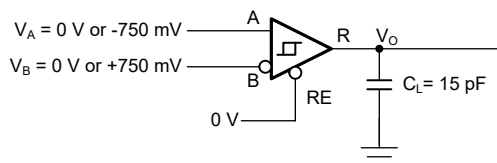

Figure 6-9. Measurement of Fail-Safe Delay

7 Detailed Description

7.1 Overview

THVD24xxV are $\pm 70\text{V}$ bus fault-protected, $\pm 25\text{V}$ common-mode voltage range capable half and full-duplex RS-485 transceivers. The devices have active-high driver enable and active-low receiver enable logic. Each device has SLR pin which allows it to be used for two different maximum speed settings. This is beneficial as customers can qualify one device and use it in two different end-applications. The devices also have flexible I/O supply pin V_{IO} which enables digital interface voltage range, from 1.65V to 5.5V, different from bus voltage supply 3V to 5.5V.

7.2 Functional Block Diagrams

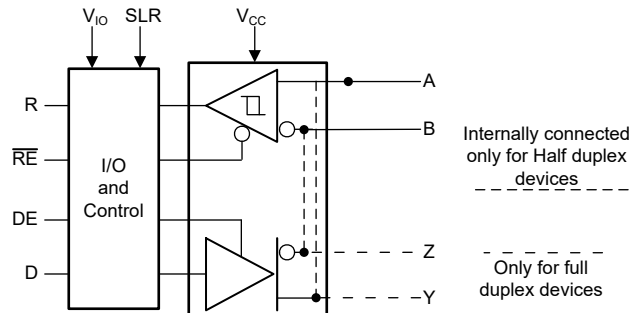

7-1. THVD2410 and THVD2450 Block Diagram

7.3 Feature Description

7.3.1 $\pm 70\text{ V}$ Fault Protection

THVD24xxV transceivers have extended bus fault protection compared to standard RS-485 devices. Transceivers that operate in rugged industrial environments are often exposed to voltage transients greater than the -7 V to $+12\text{ V}$ defined by the TIA/EIA-485A standard. To protect against such conditions, the generic RS-485 devices with lower absolute maximum ratings requires expensive external protection components. To simplify system design and reduce overall system cost, THVD24xxV devices are protected up to $\pm 70\text{ V}$ without the need for any external components.

7.3.2 Integrated IEC ESD and EFT Protection

Internal ESD protection circuits protect the transceivers against electrostatic discharges (ESD) according to IEC 61000-4-2 of up to $\pm 15\text{ kV}$ contact and air discharge (for half-duplex devices) and up to $\pm 8\text{ kV}$ contact and air discharge (for full-duplex devices). Bus structures also protect against electrical fast transients (EFT) according to IEC 61000-4-4 for up to $\pm 4\text{ kV}$. With careful system design, integrated bus structures can enable EFT Criterion A at the system level (minimum to no data loss when transient noise is present).

7.3.3 Driver Overvoltage and Overcurrent Protection

The THVD24xxV drivers are protected against any DC supply shorts in the range of -70 V to $+70\text{ V}$. The devices internally limit the short circuit current to $\pm 250\text{ mA}$ in order to comply with the TIA/EIA-485A standard. In addition, a fold-back current limiting circuit further reduces the driver short circuit current to less than $\pm 5\text{ mA}$ if the output fault voltage exceeds $|\pm 25\text{ V}|$.

All devices feature thermal shutdown protection that disables the driver and the receiver if the junction temperature exceeds the T_{SHDN} threshold due to excessive power dissipation.

7.3.4 Enhanced Receiver Noise Immunity

The differential receivers of THVD24xxV feature fully symmetric thresholds to maintain duty cycle of the signal even with small input amplitudes. In addition, 250 mV (typical) hysteresis provides noise immunity. When the device is in slew rate limited mode of 250 kbps , typical 700 ns of glitch filter in receiver signal chain prevents high frequency noise pulses from the bus to appear on R pin.

7.3.5 Receiver Fail-Safe Operation

The receivers are fail-safe to invalid bus states caused by the following:

- Open bus conditions, such as a disconnected connector
- Shorted bus conditions, such as cable damage shorting the twisted-pair together
- Idle bus conditions that occur when no driver on the bus is actively driving

In any of these cases, the receiver outputs a fail-safe logic high state if the input amplitude stays for longer than $t_{D(OFS)}$ at less than $|V_{TH_FSH}|$.

7.3.6 Low-Power Shutdown Mode

Driving \overline{DE} low and \overline{RE} high for longer than 500 ns puts the devices into the shutdown mode. If either \overline{DE} goes high or \overline{RE} goes low, the counters reset. The devices does not enter the shutdown mode if the enable pins are in disable state for less than 50 ns. This feature prevents the devices from accidentally going into shutdown mode due to skew between \overline{DE} and \overline{RE} .

7.4 Device Functional Modes

When the driver enable pin, \overline{DE} , is logic high (H), the differential outputs A/Y and B/Z follow the logic states at data input D. A logic high at D causes A/Y to turn high and B/Z to turn low. In this case, the differential output voltage defined as $V_{OD} = V_A - V_B$ is positive. When D is low (L), the output states reverse: B/Z turns high, A/Y becomes low, and V_{OD} is negative.

When \overline{DE} is low, both outputs turn high-impedance. In this condition the logic state at D is irrelevant (X). The \overline{DE} pin has an internal pull-down resistor to ground; thus, when left open the driver is disabled ($Z =$ high-impedance) by default. The D pin has an internal pull-up resistor to V_{IO} ; thus, when left open while the driver is enabled, output A/Y turns high and B/Z turns low.

表 7-1. Driver Function Table

INPUT	ENABLE	OUTPUTS		FUNCTION
D	\overline{DE}	A/Y	B/Z	
H	H	H	L	Actively drive bus high
L	H	L	H	Actively drive bus low
X	L	Z	Z	Driver disabled
X	OPEN	Z	Z	Driver disabled by default
OPEN	H	H	L	Actively drive bus high by default

When the receiver enable pin, \overline{RE} , is logic low, the receiver is enabled. When the differential input voltage defined as $V_{ID} = V_A - V_B$ is higher than the positive input threshold, V_{TH+} , the receiver output, R, turns high. When V_{ID} is lower than the negative input threshold, V_{TH-} , the receiver output, R, turns low. If V_{ID} is between V_{TH+} and V_{TH-} the output is indeterminate.

When \overline{RE} is logic high or left open, the receiver output is high-impedance and the magnitude and polarity of V_{ID} are irrelevant. Internal biasing of the receiver inputs causes the output to go failsafe-high when the transceiver is disconnected from the bus (open-circuit), the bus lines are shorted to one another (short-circuit), or the bus is not actively driven (idle bus).

表 7-2. Receiver Function Table

DIFFERENTIAL INPUT	ENABLE	OUTPUT	FUNCTION
$V_{ID} = V_A - V_B$	\overline{RE}	R	
$V_{TH+} < V_{ID}$	L	H	Receive valid bus high
$V_{TH-} < V_{ID} < V_{TH+}$	L	?	Indeterminate bus state
$V_{ID} < V_{TH-}$	L	L	Receive valid bus low
X	H	Z	Receiver disabled
X	OPEN	Z	Receiver disabled by default
Open-circuit bus	L	H	Fail-safe high output
Short-circuit bus	L	H	Fail-safe high output
Idle (terminated) bus	L	H	Fail-safe high output

表 7-3 shows SLR (slew rate select) pin functionality. SLR has intergated pull-down, so the device remains in higher speed mode until SLR is pulled high which limits the slew rate and puts the device in slower speed mode.

表 7-3. SLR pin control

Device	Functionality w.r.t SLR pin
THVD2410V, THVD2412V	SLR = Low or floating: Both transmitter (TX) and receiver (RX) maximum speed is 1 Mbps SLR = High: Both TX and RX maximum speed is limited to 250 kbps
THVD2450V, THVD2452V	SLR = Low or floating: Both transmitter (TX) and receiver (RX) maximum speed is 50 Mbps SLR = High: Both TX and RX maximum speed is limited to 20 Mbps

Table shows the device behavior in undervoltage scenarios:

表 7-4. Supply Function Table

V_{CC}	V_{IO}	Driver Output	Receiver Output
$> UV_{VCC}(\text{rising})$	$> UV_{VIO}(\text{rising})$	Determined by DE and D inputs	Determined by \overline{RE} and A-B
$< UV_{VCC}(\text{falling})$	$> UV_{VIO}(\text{rising})$	High impedance	High impedance
$> UV_{VCC}(\text{rising})$	$< UV_{VIO}(\text{falling})$	High impedance	High impedance
$< UV_{VCC}(\text{falling})$	$< UV_{VIO}(\text{falling})$	High impedance	High impedance

8 Application and Implementation

注

Information in the following applications sections is not part of the TI component specification, and TI does not warrant its accuracy or completeness. TI's customers are responsible for determining suitability of components for their purposes. Customers should validate and test their design implementation to confirm system functionality.

8.1 Application Information

THVD24xxV are fault-protected, half- and full-duplex RS-485 transceivers commonly used for asynchronous data transmissions. For these devices, the driver and receiver enable pins allow for the configuration of different operating modes.

8.2 Typical Application

An RS-485 bus consists of multiple transceivers connecting in parallel to a bus cable. To eliminate line reflections, each cable end is terminated with a termination resistor, R_T , whose value matches the characteristic impedance, Z_0 , of the cable. This method, known as parallel termination, generally allows for higher data rates over longer cable length.



図 8-1. Typical RS-485 Network With Half-Duplex Transceivers



図 8-2. Typical RS-485 Network with Full-Duplex transceivers

8.2.1 Design Requirements

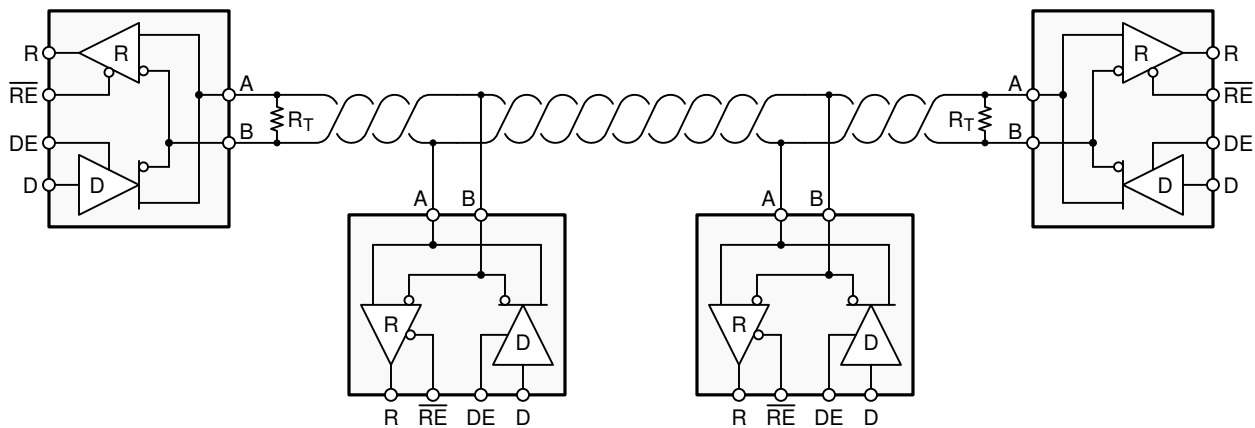
RS-485 is a robust electrical standard suitable for long-distance networking that may be used in a wide range of applications with varying requirements, such as distance, data rate, and number of nodes.

8.2.1.1 Data Rate and Bus Length

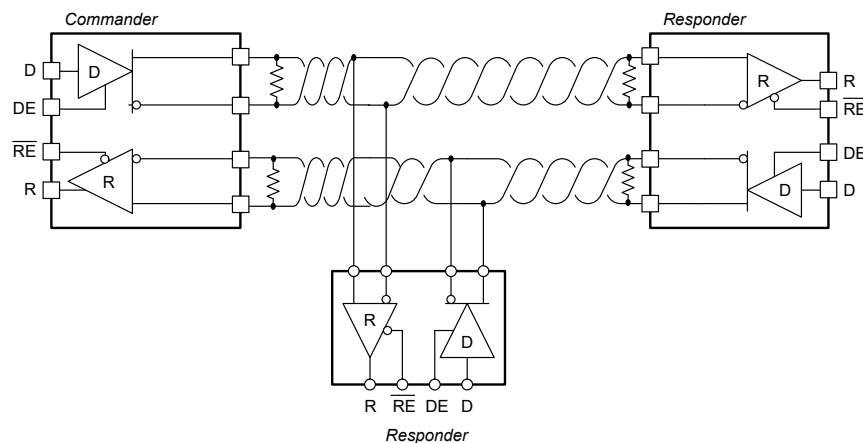
There is an inverse relationship between data rate and cable length, which means the higher the data rate, the shorter the cable length; and conversely, the lower the data rate, the longer the cable length. While most RS-485 systems use data rates between 10 kbps and 100 kbps, some applications require data rates up to 250 kbps at distances of 4000 feet and longer. Longer distances are possible by allowing for small signal jitter of up to 5 or 10%.

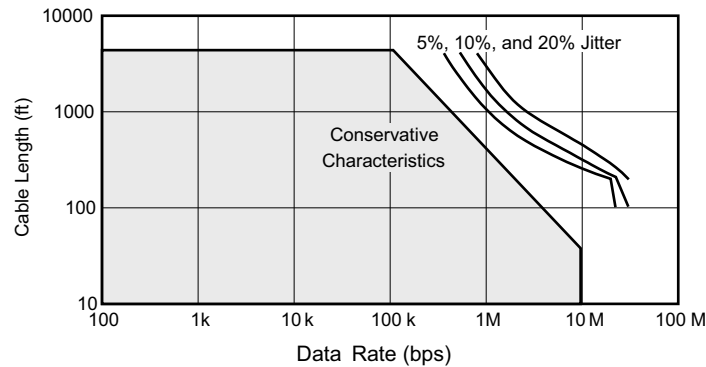

FIG 8-3. Cable Length vs Data Rate Characteristic

Even higher data rates are achievable (that is, 50 Mbps for the THVD24xxV) in cases where the interconnect is short enough (or has suitably low attenuation at signal frequencies) to not degrade the data.

8.2.1.2 Stub Length

When connecting a node to the bus, the distance between the transceiver inputs and the cable trunk, known as the stub, should be as short as possible. Stubs present a non-terminated piece of bus line which can introduce reflections of varying phase as the length of the stub increases. As a general guideline, the electrical length, or round-trip delay, of a stub should be less than one-tenth of the rise time of the driver, thus giving a maximum physical stub length as shown in 式 1.

$$L_{(\text{STUB})} \leq 0.1 \times t_r \times v \times c \quad (1)$$

where

- t_r is the 10/90 rise time of the driver
- c is the speed of light (3×10^8 m/s)
- v is the signal velocity of the cable or trace as a factor of c

8.2.1.3 Bus Loading

The RS-485 standard specifies that a compliant driver must be able to drive 32 unit loads (UL), where 1 unit load represents a load impedance of approximately 12 k Ω . Because the THVD24xxV devices consist of 1/8 UL transceivers, connecting up to 256 receivers to the bus is possible for a limited common mode range of - 7 V to 12 V.

8.2.1.4 Transient Protection

The bus pins of the THVD24xxV transceivers include on-chip ESD protection against ± 16 -kV HBM and ± 15 -kV IEC 61000-4-2 contact discharge for half-duplex devices ± 8 -kV for full-duplex devices. The International Electrotechnical Commission (IEC) ESD test is far more severe than the HBM ESD test. The 50% higher charge capacitance, $C_{(S)}$, and 78% lower discharge resistance, $R_{(D)}$, of the IEC model produce significantly higher discharge currents than the HBM model. As stated in the IEC 61000-4-2 standard, contact discharge is the preferred transient protection test method.

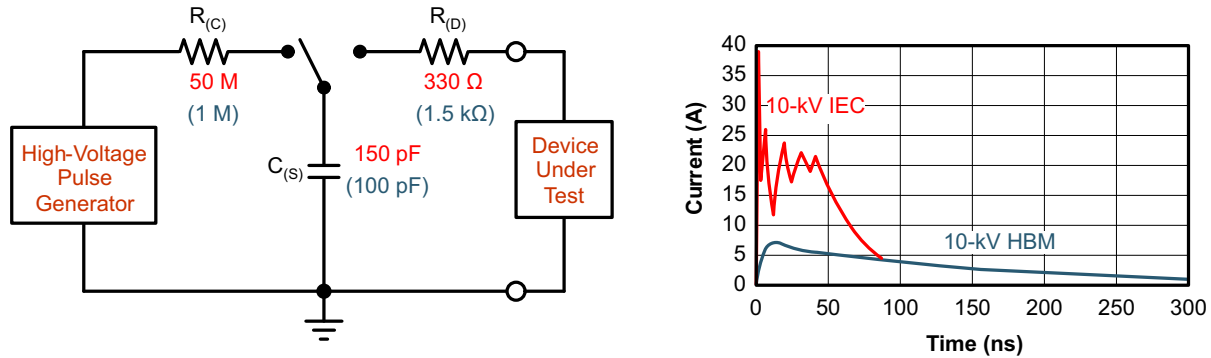

Figure 8-4. HBM and IEC ESD Models and Currents in Comparison (HBM Values in Parenthesis)

The on-chip implementation of IEC ESD protection significantly increases the robustness of equipment. Common discharge events occur because of human contact with connectors and cables. Designers may choose to implement protection against longer duration transients, typically referred to as surge transients.

EFTs are generally caused by relay-contact bounce or the interruption of inductive loads. Surge transients often result from lightning strikes (direct strike or an indirect strike which induce voltages and currents), or the switching of power systems, including load changes and short circuit switching. These transients are often encountered in industrial environments, such as factory automation and power-grid systems.

Figure 8-5 compares the pulse-power of the EFT and surge transients with the power caused by an IEC ESD transient. The left side of the diagram shows the relative pulse-power for a 0.5-kV surge transient and 4-kV EFT transient, both of which exceeds the 10-kV ESD transient visible in the lower-left corner. 500-V surge transients are representative of events that may occur in factory environments in industrial and process automation.

The right side of the diagram shows the pulse power of a 6-kV surge transient, relative to the same 0.5-kV surge transient. 6-kV surge transients are may occur in power generation and power-grid systems.

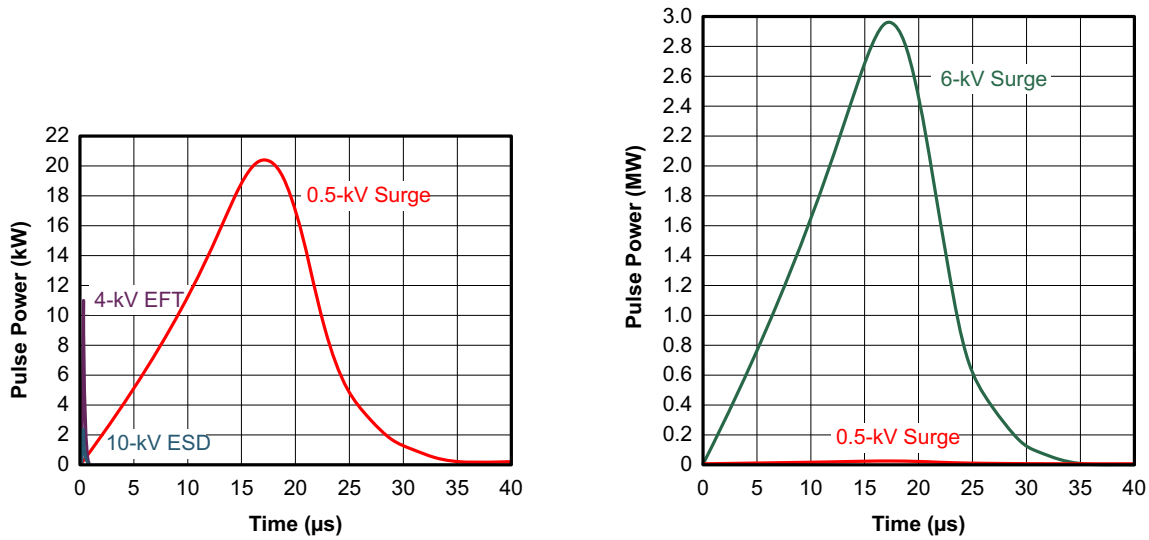

Figure 8-5. Power Comparison of ESD, EFT, and Surge Transients

For surge transients, high-energy content is characterized by long pulse duration and slow decaying pulse power. The electrical energy of a transient that is dumped into the internal protection cells of a transceiver is converted into thermal energy, which heats and destroys the protection cells, thus destroying the transceiver. Figure 8-6 shows the large differences in transient energies for single ESD, EFT, surge transients, and an EFT pulse train that is commonly applied during compliance testing.

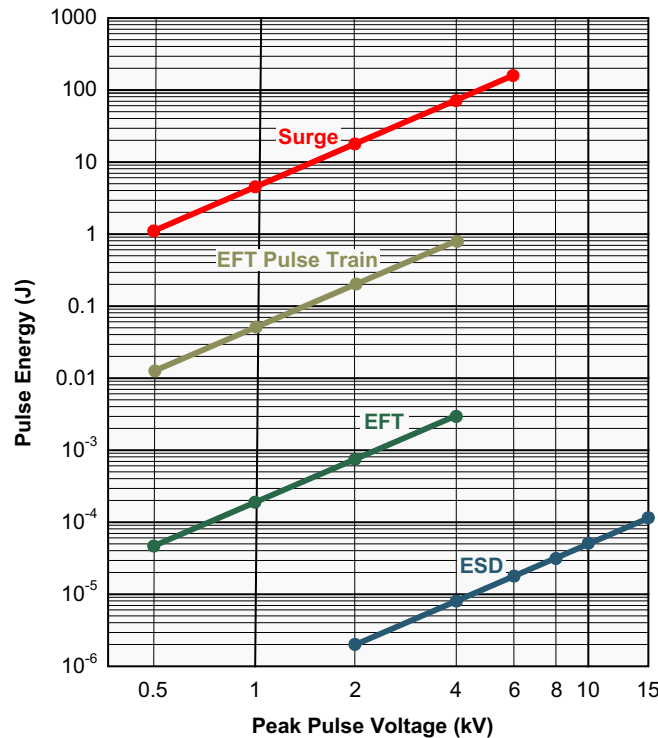
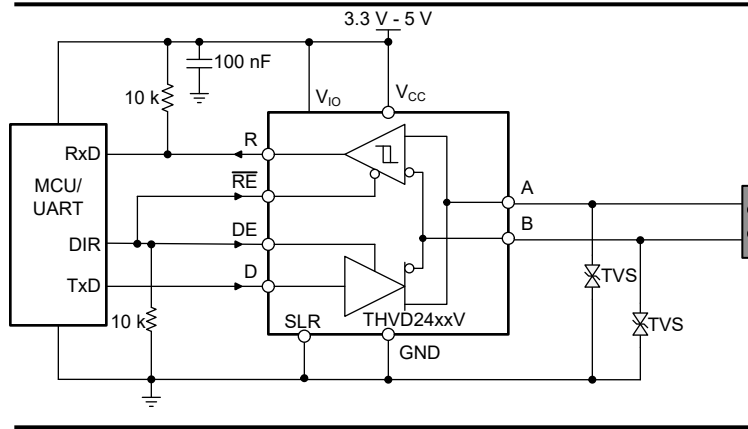

Figure 8-6. Comparison of Transient Energies

8.2.2 Detailed Design Procedure

☒ 8-7 suggests a protection circuit against 1kV surge (IEC 61000-4-5) transients. 表 8-1 shows the associated bill of materials. SMAJ30CA TVS diodes are rated to operate up to 30V. This makes sure the protection diodes do not conduct if a direct RS-485 bus shorts to 24V DC industrial power rail.



☒ 8-7. Transient Protection Against Surge Transients for Half-Duplex Devices

表 8-1. Components List

DEVICE	FUNCTION	ORDER NUMBER	MANUFACTURER ⁽¹⁾
XCVR	RS-485 transceiver	THVD2410V or THVD2450V	TI
TVS	Bidirectional 400W transient suppressor	SMAJ30CA	Littelfuse

(1) See [Third-Party Products](#)

8.2.3 Application Curves

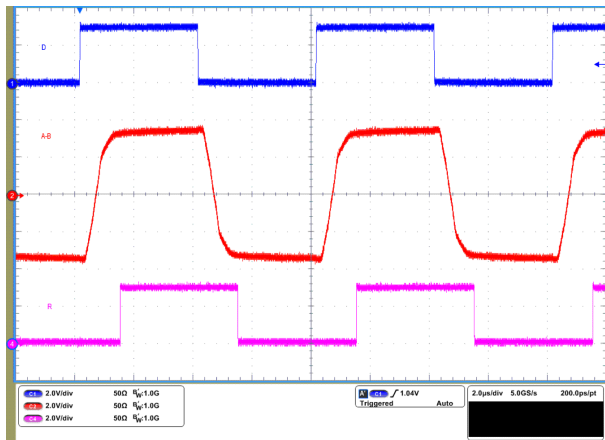

50% duty square wave on D pin at 250 kbps
SLR = V_{IO} $R_L = 54 \Omega$ DE = V_{IO}

8-8. THVD2410V Waveforms at $V_{CC} = 5 V$

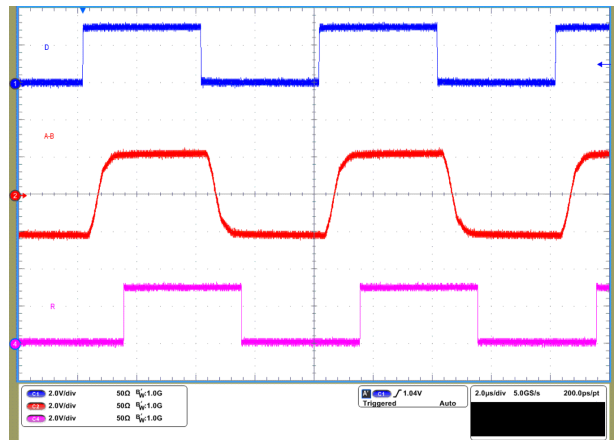

50% duty square wave on D pin at 250 kbps
SLR = V_{IO} $R_L = 54 \Omega$ DE = V_{IO}

8-9. THVD2410V Waveforms at $V_{CC} = 3.3 V$

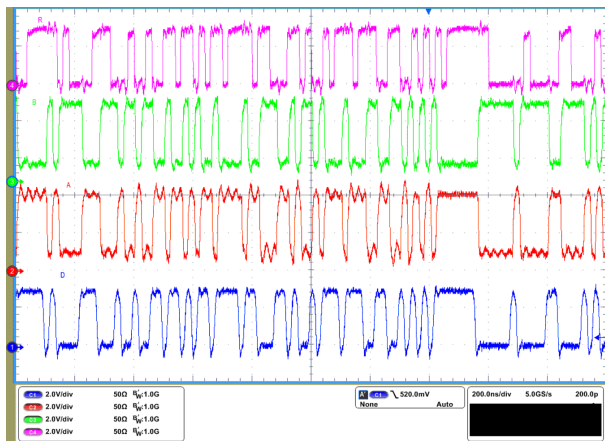

Random (PRBS7) data on D pin at 50 Mbps
SLR = GND $R_L = 54 \Omega$ DE = V_{IO}

8-10. THVD2450V Waveforms at $V_{CC} = 5 V$

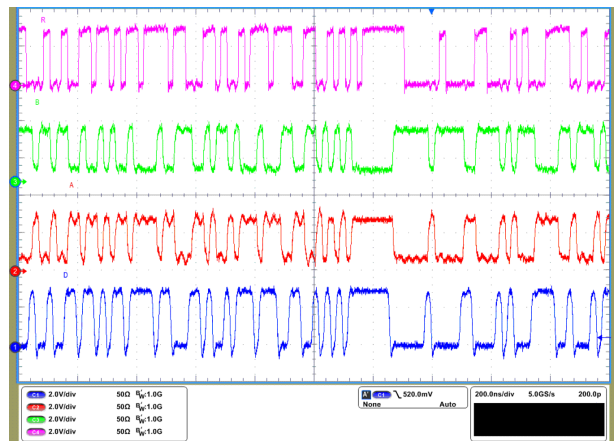

Random (PRBS7) data on D pin at 50 Mbps
SLR = GND $R_L = 54 \Omega$ DE = V_{IO}

8-11. THVD2450V Waveforms at $V_{CC} = 3.3 V$

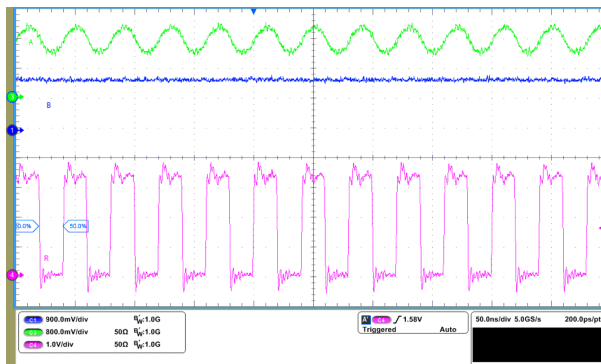

A pin given $\pm 200\text{mV } V_{ID}$ with DC offset of 1.5 V
 $\overline{RE} = \text{GND}$ B pin at 1.5 V

8-12. THVD2450V Receiver Waveform with $\pm 200 \text{ mV } V_{ID}$

8.3 Power Supply Recommendations

For reliable operation at all data rates and supply voltages, each supply should be decoupled with a minimum of 100nF ceramic capacitor located as close to the supply pins as possible. This helps to reduce supply voltage ripple present on the outputs of switched-mode power supplies and also helps to compensate for the resistance and inductance of the PCB power planes.

8.4 Layout

8.4.1 Layout Guidelines

Robust and reliable bus node design often requires the use of external transient protection devices in order to protect against surge transients that may occur in industrial environments. Since these transients have a wide frequency bandwidth (from approximately 3MHz to 300MHz), high-frequency layout techniques should be applied during PCB design.

1. Place the protection circuitry close to the bus connector to prevent noise transients from propagating across the board.
2. Use V_{CC} and ground planes to provide low inductance. Note that high-frequency currents tend to follow the path of least impedance and not the path of least resistance.
3. Design the protection components into the direction of the signal path. Do not force the transient currents to divert from the signal path to reach the protection device.
4. Apply 100nF to 220nF decoupling capacitors as close as possible to the V_{CC} and V_{IO} pins of transceiver, UART and/or controller ICs on the board.
5. Use at least two vias for V_{CC} and ground connections of decoupling capacitors and protection devices to minimize effective via inductance.
6. Use 1k Ω to 10k Ω pull-up and pull-down resistors for enable/SLR lines to limit noise currents in these lines during transient events.
7. Insert pulse-proof resistors into the A/Y and B/Z bus lines if the TVS clamping voltage is higher than the specified maximum voltage of the transceiver bus pins. These resistors limit the residual clamping current into the transceiver and prevent it from latching up.

8.4.2 Layout Example



図 8-13. Half-Duplex Layout Example

9 Device and Documentation Support

9.1 Device Support

9.1.1 サード・パーティ製品に関する免責事項

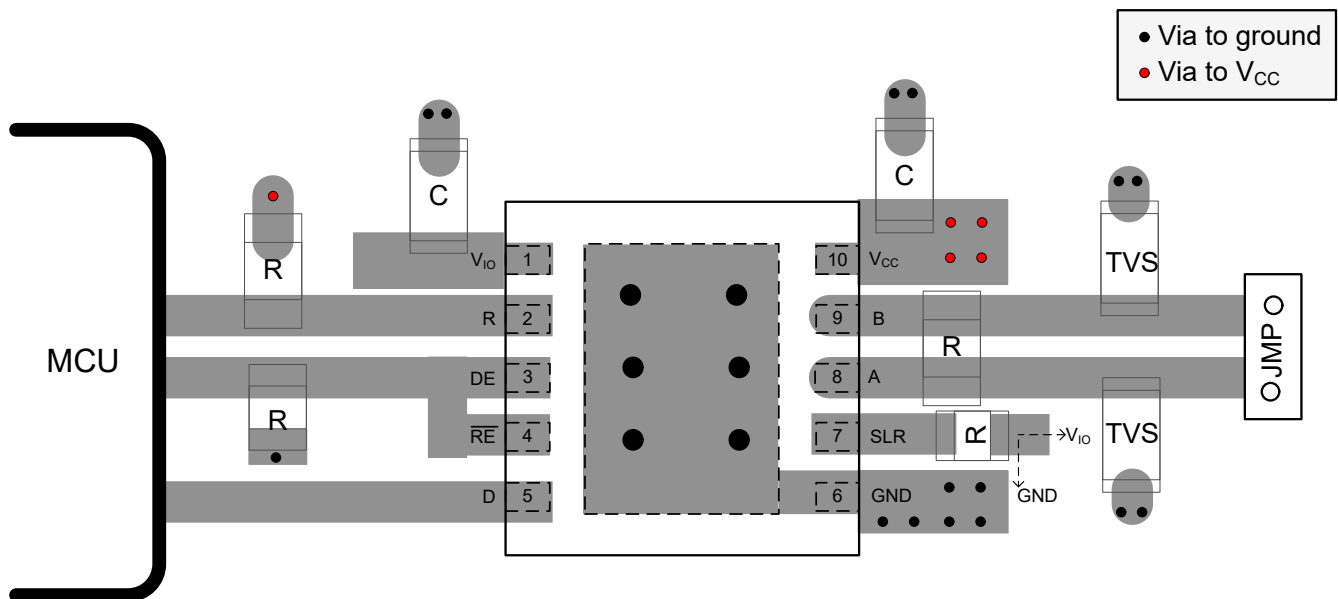
サード・パーティ製品またはサービスに関するテキサス・インスツルメンツの出版物は、単独またはテキサス・インスツルメンツの製品、サービスと一緒に提供される場合に関係なく、サード・パーティ製品またはサービスの適合性に関する是認、サード・パーティ製品またはサービスの是認の表明を意味するものではありません。

9.2 ドキュメントの更新通知を受け取る方法

ドキュメントの更新についての通知を受け取るには、www.tij.co.jp のデバイス製品フォルダを開いてください。[通知] をクリックして登録すると、変更されたすべての製品情報に関するダイジェストを毎週受け取ることができます。変更の詳細については、改訂されたドキュメントに含まれている改訂履歴をご覧ください。

9.3 サポート・リソース

テキサス・インスツルメンツ E2E™ サポート・フォーラムは、エンジニアが検証済みの回答と設計に関するヒントをエキスパートから迅速かつ直接得ることができる場所です。既存の回答を検索したり、独自の質問をしたりすることで、設計に必要な支援を迅速に得ることができます。

リンクされているコンテンツは、各寄稿者により「現状のまま」提供されるものです。これらはテキサス・インスツルメンツの仕様を構成するものではなく、必ずしもテキサス・インスツルメンツの見解を反映したものではありません。テキサス・インスツルメンツの使用条件を参照してください。

9.4 商標

テキサス・インスツルメンツ E2E™ is a trademark of Texas Instruments.

すべての商標は、それぞれの所有者に帰属します。

9.5 静電気放電に関する注意事項



この IC は、ESD によって破損する可能性があります。テキサス・インスツルメンツは、IC を取り扱う際には常に適切な注意を払うことを推奨します。正しい取り扱いおよび設置手順に従わない場合、デバイスを破損するおそれがあります。

ESD による破損は、わずかな性能低下からデバイスの完全な故障まで多岐にわたります。精密な IC の場合、パラメータがわずかに変化するだけで公表されている仕様から外れる可能性があるため、破損が発生しやすくなっています。

9.6 用語集

テキサス・インスツルメンツ用語集 この用語集には、用語や略語の一覧および定義が記載されています。

10 Revision History

Changes from Revision A (February 2023) to Revision B (March 2024)	Page
「製品情報」表の THVD2412V および THVD2452V から「製品プレビュー」の注を削除.....	1
Changed output A and B to: A/Y and B/Z in the <i>Device Functional Modes</i>	20

Changes from Revision * (December 2022) to Revision A (February 2023)	Page
「パッケージ情報」表の THVD2410V から「製品プレビュー」の注を削除.....	1

11 Mechanical, Packaging, and Orderable Information

The following pages include mechanical, packaging, and orderable information. This information is the most current data available for the designated devices. This data is subject to change without notice and revision of this document. For browser-based versions of this data sheet, refer to the left-hand navigation.

重要なお知らせと免責事項

テキサス・インスツルメンツは、技術データと信頼性データ(データシートを含みます)、設計リソース(リファレンス デザインを含みます)、アプリケーションや設計に関する各種アドバイス、Web ツール、安全性情報、その他のリソースを、欠陥が存在する可能性のある「現状のまま」提供しており、商品性および特定目的に対する適合性の黙示保証、第三者の知的財産権の非侵害保証を含むいかなる保証も、明示的または黙示的にかかわらず拒否します。

これらのリソースは、テキサス・インスツルメンツ製品を使用する設計の経験を積んだ開発者への提供を意図したものです。(1) お客様のアプリケーションに適したテキサス・インスツルメンツ製品の選定、(2) お客様のアプリケーションの設計、検証、試験、(3) お客様のアプリケーションに該当する各種規格や、その他のあらゆる安全性、セキュリティ、規制、または他の要件への確実な適合に関する責任を、お客様のみが単独で負うものとします。

上記の各種リソースは、予告なく変更される可能性があります。これらのリソースは、リソースで説明されているテキサス・インスツルメンツ製品を使用するアプリケーションの開発の目的でのみ、テキサス・インスツルメンツはその使用をお客様に許諾します。これらのリソースに関して、他の目的で複製することや掲載することは禁止されています。テキサス・インスツルメンツや第三者の知的財産権のライセンスが付与されている訳ではありません。お客様は、これらのリソースを自身で使用した結果発生するあらゆる申し立て、損害、費用、損失、責任について、テキサス・インスツルメンツおよびその代理人を完全に補償するものとし、テキサス・インスツルメンツは一切の責任を拒否します。

テキサス・インスツルメンツの製品は、[テキサス・インスツルメンツの販売条件](#)、または [ti.com](https://www.ti.com) やかかるテキサス・インスツルメンツ製品の関連資料などのいずれかを通じて提供する適用可能な条項の下で提供されています。テキサス・インスツルメンツがこれらのリソースを提供することは、適用されるテキサス・インスツルメンツの保証または他の保証の放棄の拡大や変更を意味するものではありません。

お客様がいかなる追加条項または代替条項を提案した場合でも、テキサス・インスツルメンツはそれらに異議を唱え、拒否します。

郵送先住所: Texas Instruments, Post Office Box 655303, Dallas, Texas 75265
Copyright © 2024, Texas Instruments Incorporated

PACKAGING INFORMATION

Orderable Device	Status (1)	Package Type	Package Drawing	Pins	Package Qty	Eco Plan (2)	Lead finish/ Ball material (6)	MSL Peak Temp (3)	Op Temp (°C)	Device Marking (4/5)	Samples
THVD2410VDRRCR	ACTIVE	VSON	DRC	10	5000	RoHS & Green	NIPDAU	Level-1-260C-UNLIM	-40 to 125	2410	Samples
THVD2412VDR	ACTIVE	SOIC	D	14	2500	RoHS & Green	NIPDAU	Level-1-260C-UNLIM	-40 to 125	T2412V	Samples
THVD2450VDRRCR	ACTIVE	VSON	DRC	10	5000	RoHS & Green	NIPDAU	Level-1-260C-UNLIM	-40 to 125	2450	Samples
THVD2452VDR	ACTIVE	SOIC	D	14	2500	RoHS & Green	NIPDAU	Level-1-260C-UNLIM	-40 to 125	T2452V	Samples

(1) The marketing status values are defined as follows:

ACTIVE: Product device recommended for new designs.

LIFEBUY: TI has announced that the device will be discontinued, and a lifetime-buy period is in effect.

NRND: Not recommended for new designs. Device is in production to support existing customers, but TI does not recommend using this part in a new design.

PREVIEW: Device has been announced but is not in production. Samples may or may not be available.

OBSELETE: TI has discontinued the production of the device.

(2) **RoHS:** TI defines "RoHS" to mean semiconductor products that are compliant with the current EU RoHS requirements for all 10 RoHS substances, including the requirement that RoHS substance do not exceed 0.1% by weight in homogeneous materials. Where designed to be soldered at high temperatures, "RoHS" products are suitable for use in specified lead-free processes. TI may reference these types of products as "Pb-Free".

RoHS Exempt: TI defines "RoHS Exempt" to mean products that contain lead but are compliant with EU RoHS pursuant to a specific EU RoHS exemption.

Green: TI defines "Green" to mean the content of Chlorine (Cl) and Bromine (Br) based flame retardants meet JS709B low halogen requirements of <=1000ppm threshold. Antimony trioxide based flame retardants must also meet the <=1000ppm threshold requirement.

(3) MSL, Peak Temp. - The Moisture Sensitivity Level rating according to the JEDEC industry standard classifications, and peak solder temperature.

(4) There may be additional marking, which relates to the logo, the lot trace code information, or the environmental category on the device.

(5) Multiple Device Markings will be inside parentheses. Only one Device Marking contained in parentheses and separated by a "-" will appear on a device. If a line is indented then it is a continuation of the previous line and the two combined represent the entire Device Marking for that device.

(6) Lead finish/Ball material - Orderable Devices may have multiple material finish options. Finish options are separated by a vertical ruled line. Lead finish/Ball material values may wrap to two lines if the finish value exceeds the maximum column width.

Important Information and Disclaimer:The information provided on this page represents TI's knowledge and belief as of the date that it is provided. TI bases its knowledge and belief on information provided by third parties, and makes no representation or warranty as to the accuracy of such information. Efforts are underway to better integrate information from third parties. TI has taken and

continues to take reasonable steps to provide representative and accurate information but may not have conducted destructive testing or chemical analysis on incoming materials and chemicals. TI and TI suppliers consider certain information to be proprietary, and thus CAS numbers and other limited information may not be available for release.

In no event shall TI's liability arising out of such information exceed the total purchase price of the TI part(s) at issue in this document sold by TI to Customer on an annual basis.

TAPE AND REEL INFORMATION

QUADRANT ASSIGNMENTS FOR PIN 1 ORIENTATION IN TAPE

*All dimensions are nominal

Device	Package Type	Package Drawing	Pins	SPQ	Reel Diameter (mm)	Reel Width W1 (mm)	A0 (mm)	B0 (mm)	K0 (mm)	P1 (mm)	W (mm)	Pin1 Quadrant
THVD2410VDRCR	VSON	DRC	10	5000	330.0	12.4	3.3	3.3	1.1	8.0	12.0	Q2
THVD2412VDR	SOIC	D	14	2500	330.0	16.4	6.5	9.0	2.1	8.0	16.0	Q1
THVD2450VDRCR	VSON	DRC	10	5000	330.0	12.4	3.3	3.3	1.1	8.0	12.0	Q2
THVD2452VDR	SOIC	D	14	2500	330.0	16.4	6.5	9.0	2.1	8.0	16.0	Q1

TAPE AND REEL BOX DIMENSIONS

*All dimensions are nominal

Device	Package Type	Package Drawing	Pins	SPQ	Length (mm)	Width (mm)	Height (mm)
THVD2410VDRCR	VSON	DRC	10	5000	367.0	367.0	35.0
THVD2412VDR	SOIC	D	14	2500	353.0	353.0	32.0
THVD2450VDRCR	VSON	DRC	10	5000	367.0	367.0	35.0
THVD2452VDR	SOIC	D	14	2500	353.0	353.0	32.0

D (R-PDSO-G14)

PLASTIC SMALL OUTLINE



- NOTES:
- A. All linear dimensions are in inches (millimeters).
 - B. This drawing is subject to change without notice.
 - $\triangle C$ Body length does not include mold flash, protrusions, or gate burrs. Mold flash, protrusions, or gate burrs shall not exceed 0.006 (0,15) each side.
 - $\triangle D$ Body width does not include interlead flash. Interlead flash shall not exceed 0.017 (0,43) each side.
 - E. Reference JEDEC MS-012 variation AB.

D (R-PDSO-G14)

PLASTIC SMALL OUTLINE



4211283-3/E 08/12

- NOTES:
- All linear dimensions are in millimeters.
 - This drawing is subject to change without notice.
 - Publication IPC-7351 is recommended for alternate designs.
 - Laser cutting apertures with trapezoidal walls and also rounding corners will offer better paste release. Customers should contact their board assembly site for stencil design recommendations. Refer to IPC-7525 for other stencil recommendations.
 - Customers should contact their board fabrication site for solder mask tolerances between and around signal pads.

GENERIC PACKAGE VIEW

DRC 10

VSON - 1 mm max height

3 x 3, 0.5 mm pitch

PLASTIC SMALL OUTLINE - NO LEAD

This image is a representation of the package family, actual package may vary.
Refer to the product data sheet for package details.

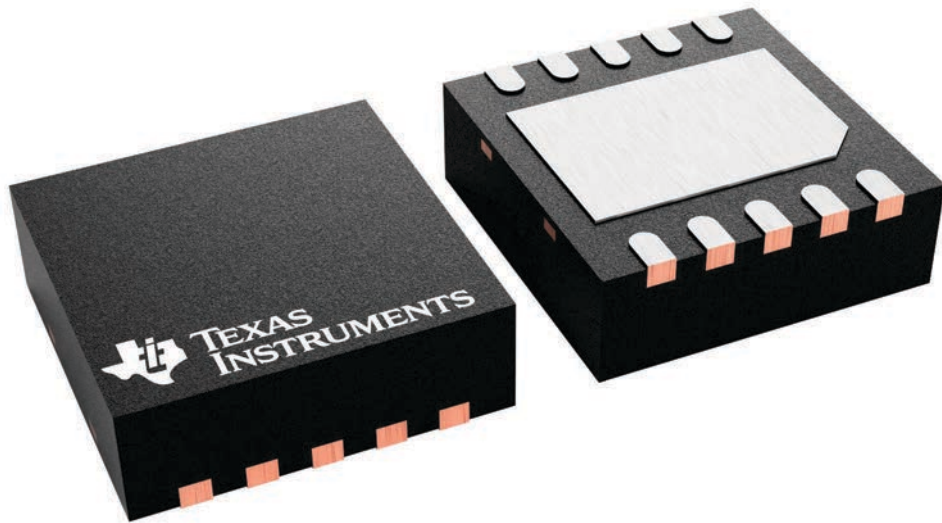

4226193/A

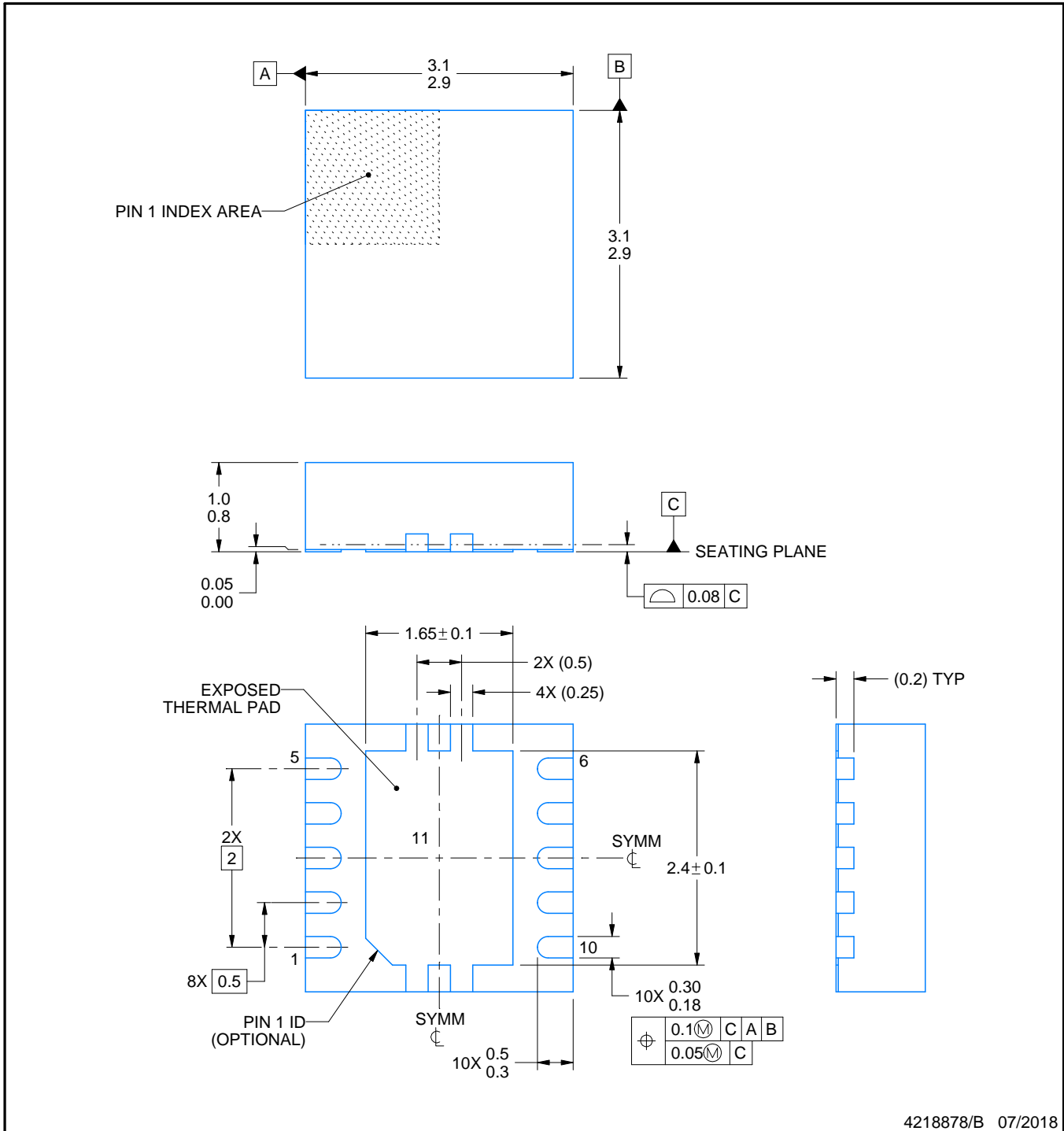

4218878/B 07/2018

NOTES:

1. All linear dimensions are in millimeters. Any dimensions in parenthesis are for reference only. Dimensioning and tolerancing per ASME Y14.5M.
2. This drawing is subject to change without notice.
3. The package thermal pad must be soldered to the printed circuit board for optimal thermal and mechanical performance.

EXAMPLE BOARD LAYOUT

DRC0010J

VSON - 1 mm max height

PLASTIC SMALL OUTLINE - NO LEAD



LAND PATTERN EXAMPLE
EXPOSED METAL SHOWN
SCALE:20X



SOLDER MASK DETAILS

4218878/B 07/2018

NOTES: (continued)

4. This package is designed to be soldered to a thermal pad on the board. For more information, see Texas Instruments literature number SLUA271 (www.ti.com/lit/sluea271).
5. Vias are optional depending on application, refer to device data sheet. If any vias are implemented, refer to their locations shown on this view. It is recommended that vias under paste be filled, plugged or tented.

EXAMPLE STENCIL DESIGN

DRC0010J

VSON - 1 mm max height

PLASTIC SMALL OUTLINE - NO LEAD



SOLDER PASTE EXAMPLE
BASED ON 0.125 mm THICK STENCIL

EXPOSED PAD 11:
80% PRINTED SOLDER COVERAGE BY AREA
SCALE:25X

4218878/B 07/2018

NOTES: (continued)

6. Laser cutting apertures with trapezoidal walls and rounded corners may offer better paste release. IPC-7525 may have alternate design recommendations.

重要なお知らせと免責事項

TI は、技術データと信頼性データ (データシートを含みます)、設計リソース (リファレンス・デザインを含みます)、アプリケーションや設計に関する各種アドバイス、Web ツール、安全性情報、その他のリソースを、欠陥が存在する可能性のある「現状のまま」提供しており、商品性および特定目的に対する適合性の黙示保証、第三者の知的財産権の非侵害保証を含むいかなる保証も、明示的または黙示的にかかわらず拒否します。

これらのリソースは、TI 製品を使用する設計の経験を積んだ開発者への提供を意図したものです。(1) お客様のアプリケーションに適した TI 製品の選定、(2) お客様のアプリケーションの設計、検証、試験、(3) お客様のアプリケーションに該当する各種規格や、その他のあらゆる安全性、セキュリティ、規制、または他の要件への確実な適合に関する責任を、お客様のみが単独で負うものとし、

上記の各種リソースは、予告なく変更される可能性があります。これらのリソースは、リソースで説明されている TI 製品を使用するアプリケーションの開発の目的でのみ、TI はその使用をお客様に許諾します。これらのリソースに関して、他の目的で複製することや掲載することは禁止されています。TI や第三者の知的財産権のライセンスが付与されている訳ではありません。お客様は、これらのリソースを自身で使用した結果発生するあらゆる申し立て、損害、費用、損失、責任について、TI およびその代理人を完全に補償するものとし、TI は一切の責任を拒否します。

TI の製品は、[TI の販売条件](#)、または [ti.com](#) やかかる TI 製品の関連資料などのいずれかを通じて提供する適用可能な条項の下で提供されています。TI がこれらのリソースを提供することは、適用される TI の保証または他の保証の放棄の拡大や変更を意味するものではありません。

お客様がいかなる追加条項または代替条項を提案した場合でも、TI はそれらに異議を唱え、拒否します。

郵送先住所 : Texas Instruments, Post Office Box 655303, Dallas, Texas 75265
Copyright © 2024, Texas Instruments Incorporated