

## LOW-DROPOUT FIXED-VOLTAGE REGULATORS

 Check for Samples: [TL760M33-Q1](#)

### FEATURES

- Qualified for Automotive Applications
- $\pm 3\%$  Output Voltage Variation Across Load and Temperature
- Load-Dump Protection
- 500-mV Maximum Dropout Voltage at 500 mA
- Fixed 3.3-V Output
- Internal Thermal-Overload Protection
- Internal Overvoltage Protection
- Customer-Specific Configuration Control Can Be Supported Along With Major-Change Approval

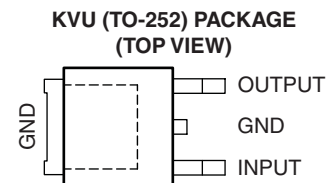
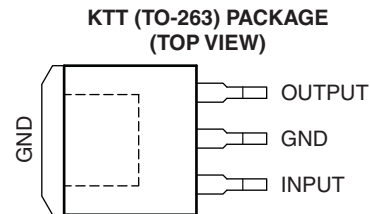

### DESCRIPTION/ORDERING INFORMATION

The TL760M33-Q1 low-dropout regulator offers a variety of fixed-voltage options that offer a maximum continuous input voltage of 26 V. Utilizing a pnp pass element, this regulator is capable of sourcing 500 mA of current, with a specified maximum dropout of 500 mV, making the TL760M33-Q1 ideal for low-voltage applications. Additionally, the TL760M33-Q1 regulator offers very tight output accuracy of  $\pm 3\%$  across operating load and temperature ranges. Other convenient features the regulators provide are internal overcurrent limiting, thermal-overload protection, and overvoltage protection. The TL760M33-Q1 is load-dump protected to its maximum operating condition of 45 V. Stability has been optimized for typical automotive applications and low-cost capacitors.

#### ORDERING INFORMATION<sup>(1)</sup>

$T_A$	$V_O$ (TYP)	PACKAGE <sup>(2)</sup>		ORDERABLE PART NUMBER	TOP-SIDE MARKING
-40°C to 125°C	3.3 V	TO-263 – KTT	Reel of 500	TL760M33QKTTRQ1	TL760M33Q1
		TO-252 – KVU	Reel of 2500	TL760M33QKVURQ1	760M33Q1

(1) For the most current package and ordering information, see the Package Option Addendum at the end of this document, or see the TI web site at [www.ti.com](http://www.ti.com).

(2) Package drawings, thermal data, and symbolization are available at [www.ti.com/packaging](http://www.ti.com/packaging).



Please be aware that an important notice concerning availability, standard warranty, and use in critical applications of Texas Instruments semiconductor products and disclaimers thereto appears at the end of this data sheet.

# TL760M33-Q1

SGLS284I – OCTOBER 2005 – REVISED DECEMBER 2010

www.ti.com

## ABSOLUTE MAXIMUM RATINGS<sup>(1)</sup>

over operating virtual junction temperature range (unless otherwise noted)

V <sub>I</sub>	Maximum input voltage	45 V
T <sub>J</sub>	Operating virtual junction temperature	150°C
T <sub>stg</sub>	Storage temperature range	–65°C to 150°C

(1) Stresses beyond those listed under *absolute maximum ratings* may cause permanent damage to the device. These are stress ratings only, and functional operation of the device at these or any other conditions beyond those indicated under *recommended operating conditions* is not implied. Exposure to absolute-maximum-rated conditions for extended periods may affect device reliability.

## PACKAGE THERMAL DATA<sup>(1)</sup>

PACKAGE	BOARD	θ <sub>JA</sub>
TO-252 (KVU)	High K, JESD 51-5	30.3°C/W
TO-263 (KTT)	High K, JESD 51-5	26.9°C/W

(1) Maximum power dissipation is a function of T<sub>J(max)</sub>, θ<sub>JA</sub>, and T<sub>A</sub>. The maximum allowable power dissipation at any allowable ambient temperature is P<sub>D</sub> = (T<sub>J(max)</sub> – T<sub>A</sub>)/θ<sub>JA</sub>. Operating at the absolute maximum T<sub>J</sub> of 150°C can impact reliability.

## THERMAL RESISTANCE

1-oz copper, one-layer PCB

THERMAL RESISTANCE	VALUE
R <sub>JA</sub>	55°C/W (area = 240 mm <sup>2</sup> )
R <sub>JC</sub>	5.5°C/W from FET to tab
R <sub>JC</sub>	0.1°C/W from die center to tab

## RECOMMENDED OPERATING CONDITIONS

	MIN	MAX	UNIT
V <sub>I</sub> Input voltage	3.8	26	V
I <sub>O</sub> Output current	0	500	mA
T <sub>J</sub> Operating virtual-junction temperature	–40	150	°C

## ELECTRICAL CHARACTERISTICS

V<sub>I</sub> = 6 V, I<sub>O</sub> = 500 mA, T<sub>J</sub> = –40°C to 150°C (unless otherwise noted)

PARAMETER	TEST CONDITIONS <sup>(1)</sup>	MIN	TYP	MAX	UNIT
V <sub>O</sub> Output voltage	I <sub>O</sub> = 5 mA to 500 mA, V <sub>I</sub> = 3.8 V to 26 V, T <sub>J</sub> = 125°C	3.2	3.3	3.4	V
	T <sub>J</sub> = 150°C, I <sub>O</sub> = 5 mA to 300 mA, V <sub>I</sub> = 3.8 V to 26 V	3.2	3.3	3.4	
I <sub>Q</sub> Current consumption, I <sub>Q</sub> = I <sub>I</sub> – I <sub>O</sub>	V <sub>I</sub> = 6 V	I <sub>O</sub> = 250 mA		8	mA
		I <sub>O</sub> = 500 mA		20	
Line regulation	V <sub>I</sub> = 3.8 V to 28 V		10	25	mV
PSRR Power-supply ripple rejection	f = 100 Hz, V <sub>ripple</sub> = 0.5 V <sub>PP</sub> , V <sub>I</sub> = 6 V		62		dB
Load regulation	I <sub>O</sub> = 5 mA to 500 mA		5	30	mV
V <sub>DO</sub> Dropout voltage <sup>(2)</sup>	I <sub>O</sub> = 250 mA			400	mV
	I <sub>O</sub> = 500 mA			500	

(1) Pulse-testing techniques are used to maintain the virtual junction temperature as close to the ambient temperature as possible. Thermal effects must be taken into account separately. All characteristics are measured with a 0.1-μF capacitor across the input and a 22-μF tantalum capacitor, with equivalent series resistance of 1.5 Ω on the output.

(2) Measured when the output voltage, V<sub>O</sub>, has dropped 100 mV from the nominal value obtained when V<sub>I</sub> = 6 V

### COMPENSATION-CAPACITOR SELECTION INFORMATION

The TL760M is a low-dropout regulator. This means that the capacitance loading is important to the performance of the regulator because it is a vital part of the control loop. The capacitor value and the equivalent series resistance (ESR) both affect the control loop and must be defined for the load range. Figure 1 can be used to establish the capacitance value and ESR range for the best regulator performance.

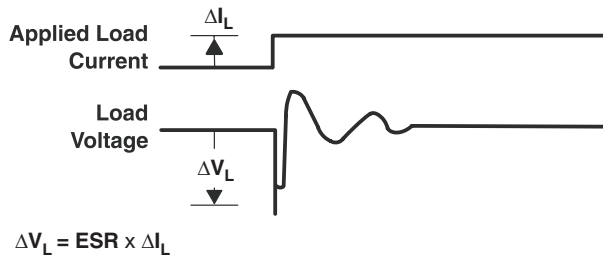
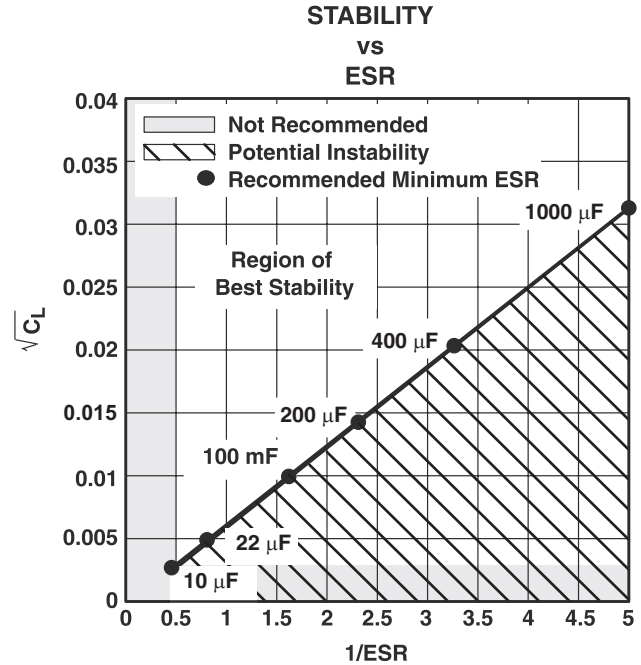
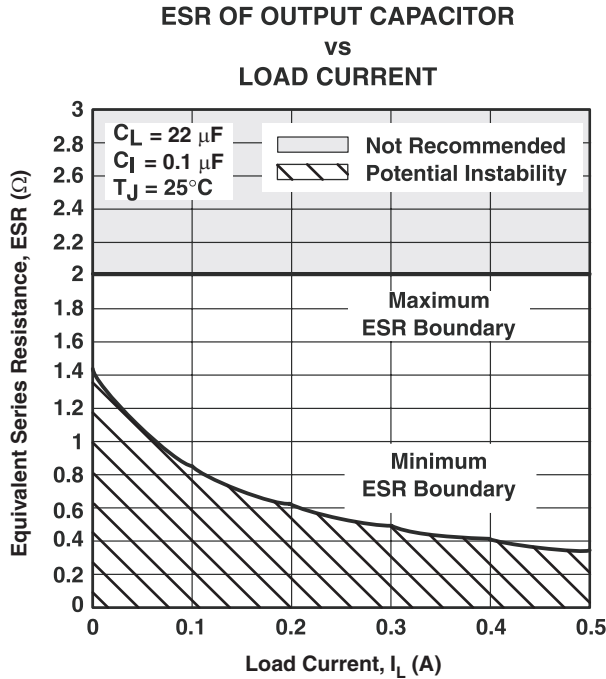

Figure 1.

Figure 2.

### TYPICAL APPLICATION SCHEMATIC

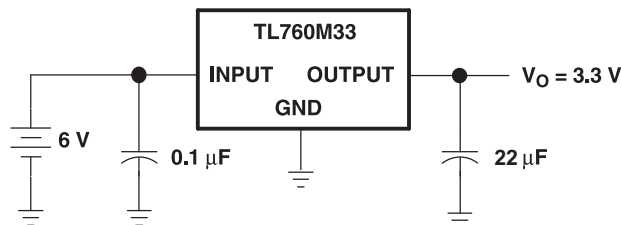

Figure 3.

**TYPICAL CHARACTERISTICS**

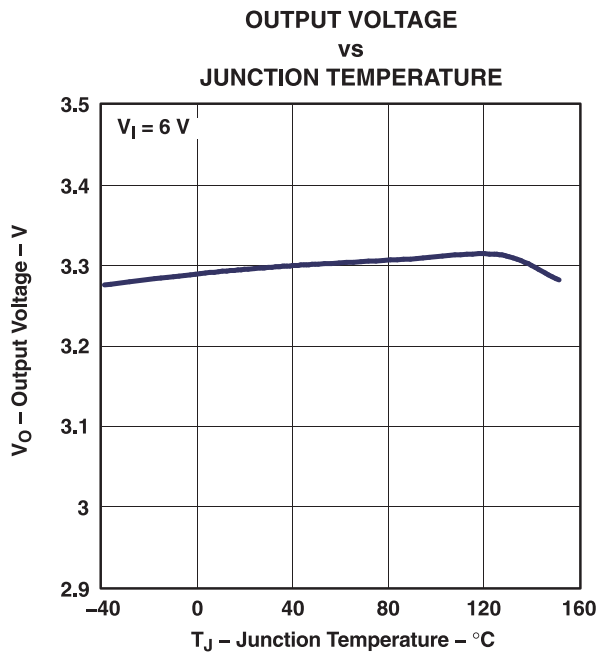

Figure 4.

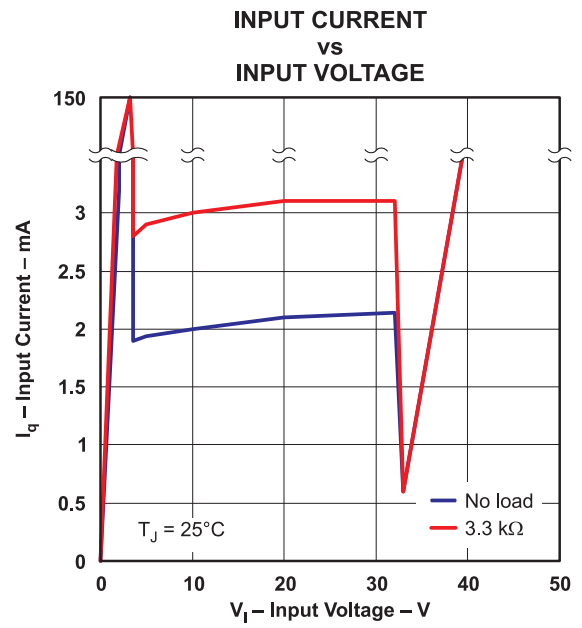

Figure 5.

**PACKAGING INFORMATION**

Orderable Device	Status (1)	Package Type	Package Drawing	Pins	Package Qty	Eco Plan (2)	Lead finish/ Ball material (6)	MSL Peak Temp (3)	Op Temp (°C)	Device Marking (4/5)	Samples
TL760M33QKTTRQ1	ACTIVE	DDPAK/ TO-263	KTT	3	500	RoHS & Green	SN	Level-3-245C-168 HR	-40 to 125	TL760M33Q1	<a href="#">Samples</a>
TL760M33QKVURQ1	ACTIVE	TO-252	KVU	3	2500	RoHS & Green	SN	Level-3-260C-168 HR	-40 to 125	760M33Q1	<a href="#">Samples</a>

(1) The marketing status values are defined as follows:

**ACTIVE:** Product device recommended for new designs.

**LIFEBUY:** TI has announced that the device will be discontinued, and a lifetime-buy period is in effect.

**NRND:** Not recommended for new designs. Device is in production to support existing customers, but TI does not recommend using this part in a new design.

**PREVIEW:** Device has been announced but is not in production. Samples may or may not be available.

**OBSELETE:** TI has discontinued the production of the device.

(2) **RoHS:** TI defines "RoHS" to mean semiconductor products that are compliant with the current EU RoHS requirements for all 10 RoHS substances, including the requirement that RoHS substance do not exceed 0.1% by weight in homogeneous materials. Where designed to be soldered at high temperatures, "RoHS" products are suitable for use in specified lead-free processes. TI may reference these types of products as "Pb-Free".

**RoHS Exempt:** TI defines "RoHS Exempt" to mean products that contain lead but are compliant with EU RoHS pursuant to a specific EU RoHS exemption.

**Green:** TI defines "Green" to mean the content of Chlorine (Cl) and Bromine (Br) based flame retardants meet JS709B low halogen requirements of <=1000ppm threshold. Antimony trioxide based flame retardants must also meet the <=1000ppm threshold requirement.

(3) MSL, Peak Temp. - The Moisture Sensitivity Level rating according to the JEDEC industry standard classifications, and peak solder temperature.

(4) There may be additional marking, which relates to the logo, the lot trace code information, or the environmental category on the device.

(5) Multiple Device Markings will be inside parentheses. Only one Device Marking contained in parentheses and separated by a "-" will appear on a device. If a line is indented then it is a continuation of the previous line and the two combined represent the entire Device Marking for that device.

(6) Lead finish/Ball material - Orderable Devices may have multiple material finish options. Finish options are separated by a vertical ruled line. Lead finish/Ball material values may wrap to two lines if the finish value exceeds the maximum column width.

**Important Information and Disclaimer:**The information provided on this page represents TI's knowledge and belief as of the date that it is provided. TI bases its knowledge and belief on information provided by third parties, and makes no representation or warranty as to the accuracy of such information. Efforts are underway to better integrate information from third parties. TI has taken and continues to take reasonable steps to provide representative and accurate information but may not have conducted destructive testing or chemical analysis on incoming materials and chemicals. TI and TI suppliers consider certain information to be proprietary, and thus CAS numbers and other limited information may not be available for release.

In no event shall TI's liability arising out of such information exceed the total purchase price of the TI part(s) at issue in this document sold by TI to Customer on an annual basis.



## TAPE AND REEL INFORMATION



### QUADRANT ASSIGNMENTS FOR PIN 1 ORIENTATION IN TAPE



\*All dimensions are nominal

Device	Package Type	Package Drawing	Pins	SPQ	Reel Diameter (mm)	Reel Width W1 (mm)	A0 (mm)	B0 (mm)	K0 (mm)	P1 (mm)	W (mm)	Pin1 Quadrant
TL760M33QKVURQ1	TO-252	KVU	3	2500	330.0	16.4	6.9	10.5	2.7	8.0	16.0	Q2

TAPE AND REEL BOX DIMENSIONS



\*All dimensions are nominal

Device	Package Type	Package Drawing	Pins	SPQ	Length (mm)	Width (mm)	Height (mm)
TL760M33QKVURQ1	TO-252	KVU	3	2500	340.0	340.0	38.0



## GENERIC PACKAGE VIEW

**KVU 3**

**TO-252 - 2.52 mm max height**

TRANSISTOR OUTLINE

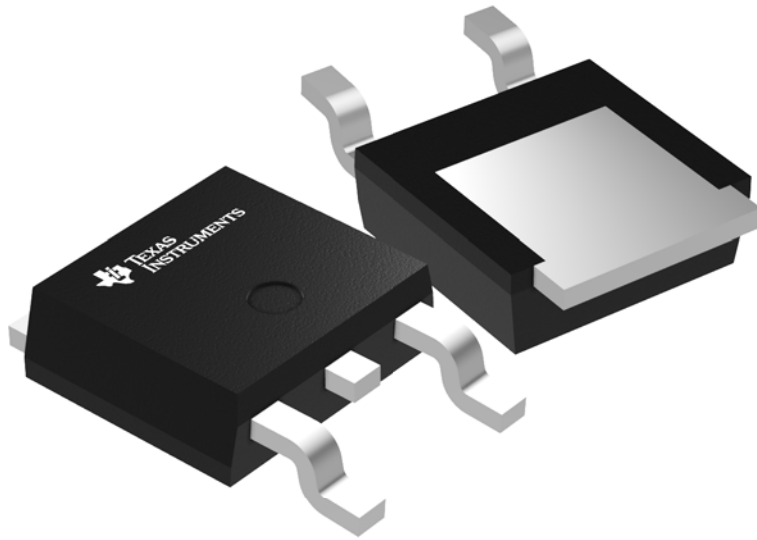

Images above are just a representation of the package family, actual package may vary.  
Refer to the product data sheet for package details.

4205521-2/E



# PACKAGE OUTLINE

## KVVU0003A

### TO-252 - 2.52 mm max height

TO-252

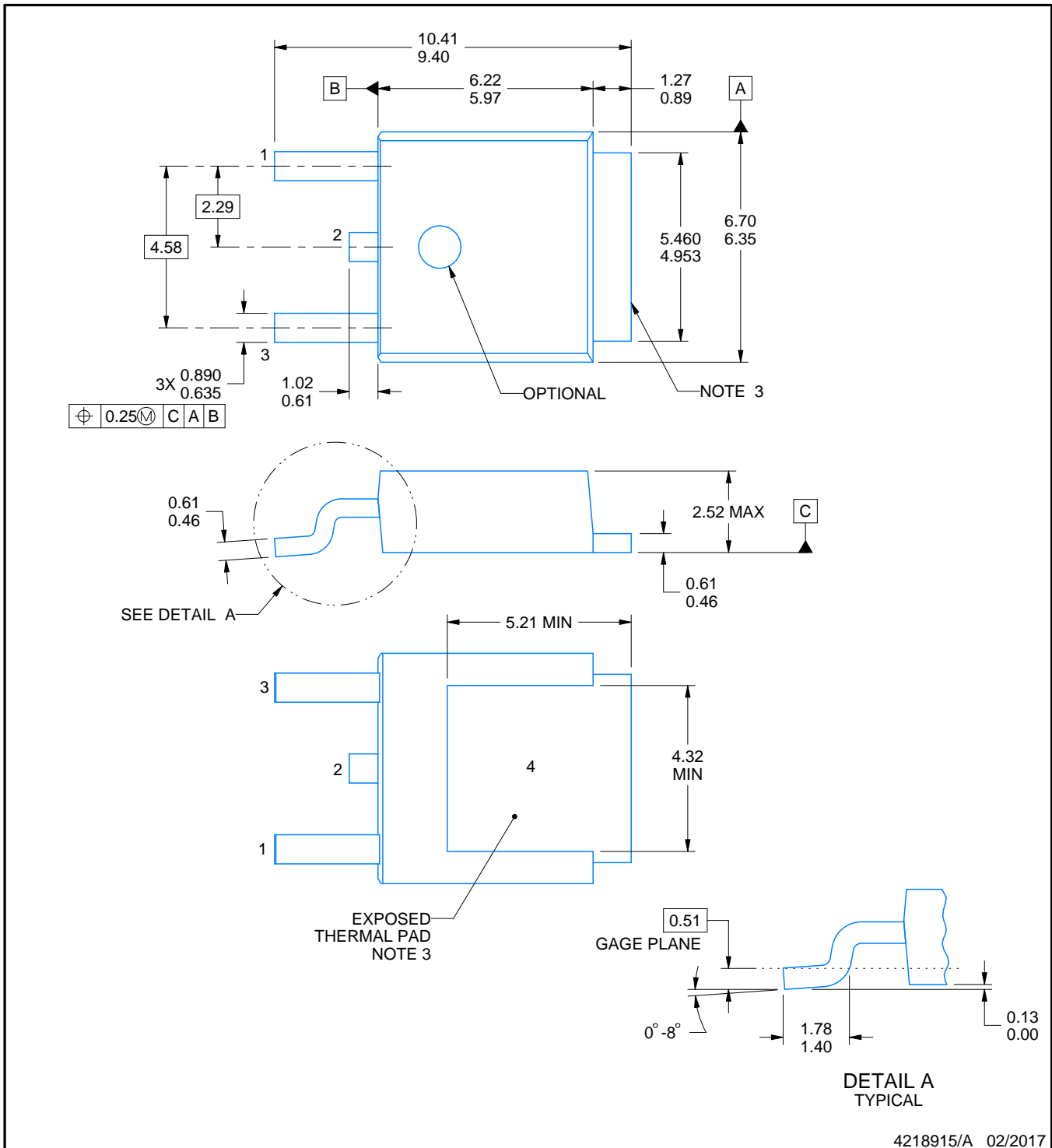

#### NOTES:

1. All linear dimensions are in millimeters. Any dimensions in parenthesis are for reference only. Dimensioning and tolerancing per ASME Y14.5M.
2. This drawing is subject to change without notice.
3. Shape may vary per different assembly sites.
4. Reference JEDEC registration TO-252.

# EXAMPLE BOARD LAYOUT

KVU0003A

TO-252 - 2.52 mm max height

TO-252

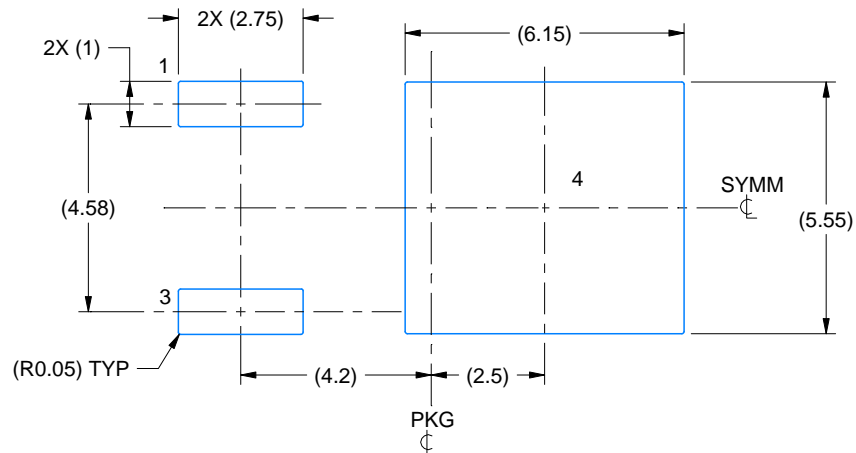

LAND PATTERN EXAMPLE  
EXPOSED METAL SHOWN  
SCALE:6X

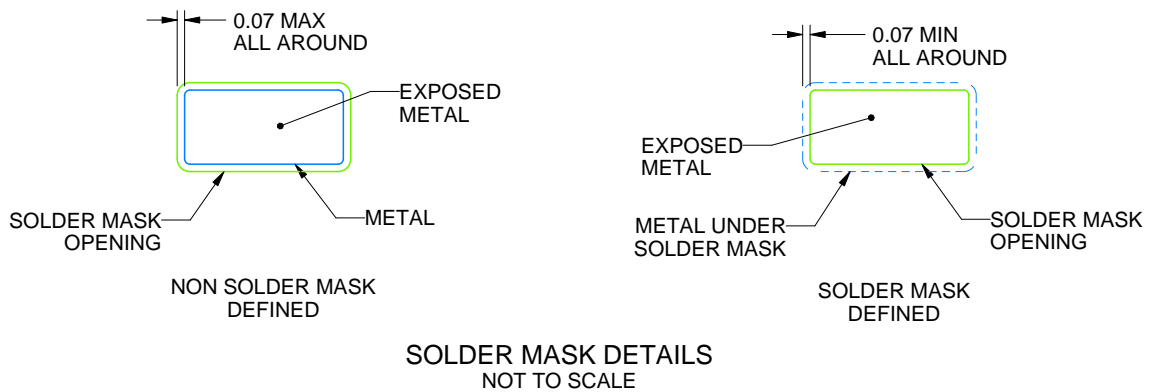

4218915/A 02/2017

NOTES: (continued)

5. This package is designed to be soldered to a thermal pad on the board. For more information, see Texas Instruments literature numbers SLMA002 ([www.ti.com/lit/slm002](http://www.ti.com/lit/slm002)) and SLMA004 ([www.ti.com/lit/slma004](http://www.ti.com/lit/slma004)).
6. Vias are optional depending on application, refer to device data sheet. It is recommended that vias under paste be filled, plugged or tented.

# EXAMPLE STENCIL DESIGN

KVU0003A

TO-252 - 2.52 mm max height

TO-252

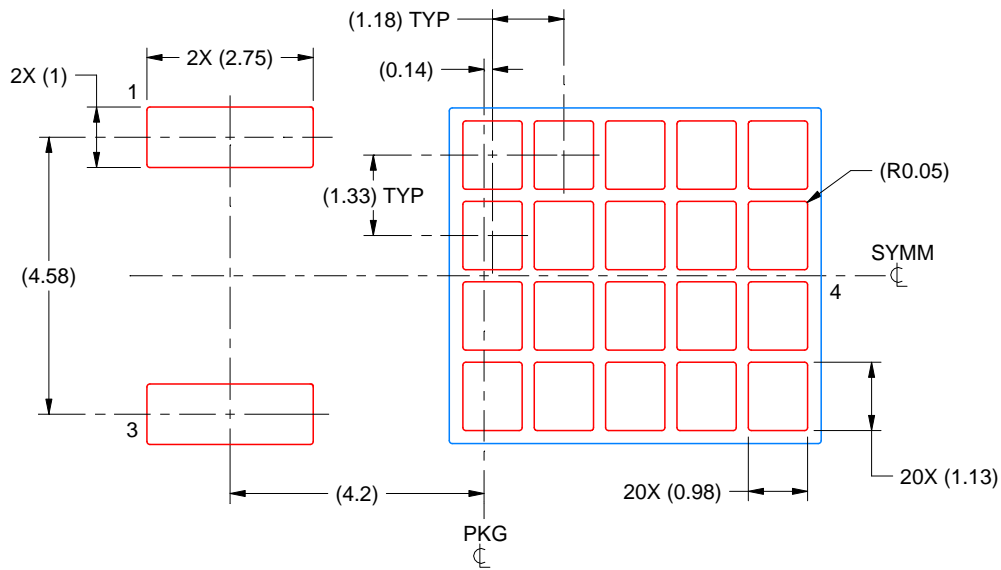

SOLDER PASTE EXAMPLE  
BASED ON 0.125 mm THICK STENCIL

EXPOSED PAD  
65% PRINTED SOLDER COVERAGE BY AREA  
SCALE:8X

4218915/A 02/2017

NOTES: (continued)

7. Laser cutting apertures with trapezoidal walls and rounded corners may offer better paste release. IPC-7525 may have alternate design recommendations.
8. Board assembly site may have different recommendations for stencil design.

KTT (R-PSFM-G3)

PLASTIC FLANGE-MOUNT PACKAGE

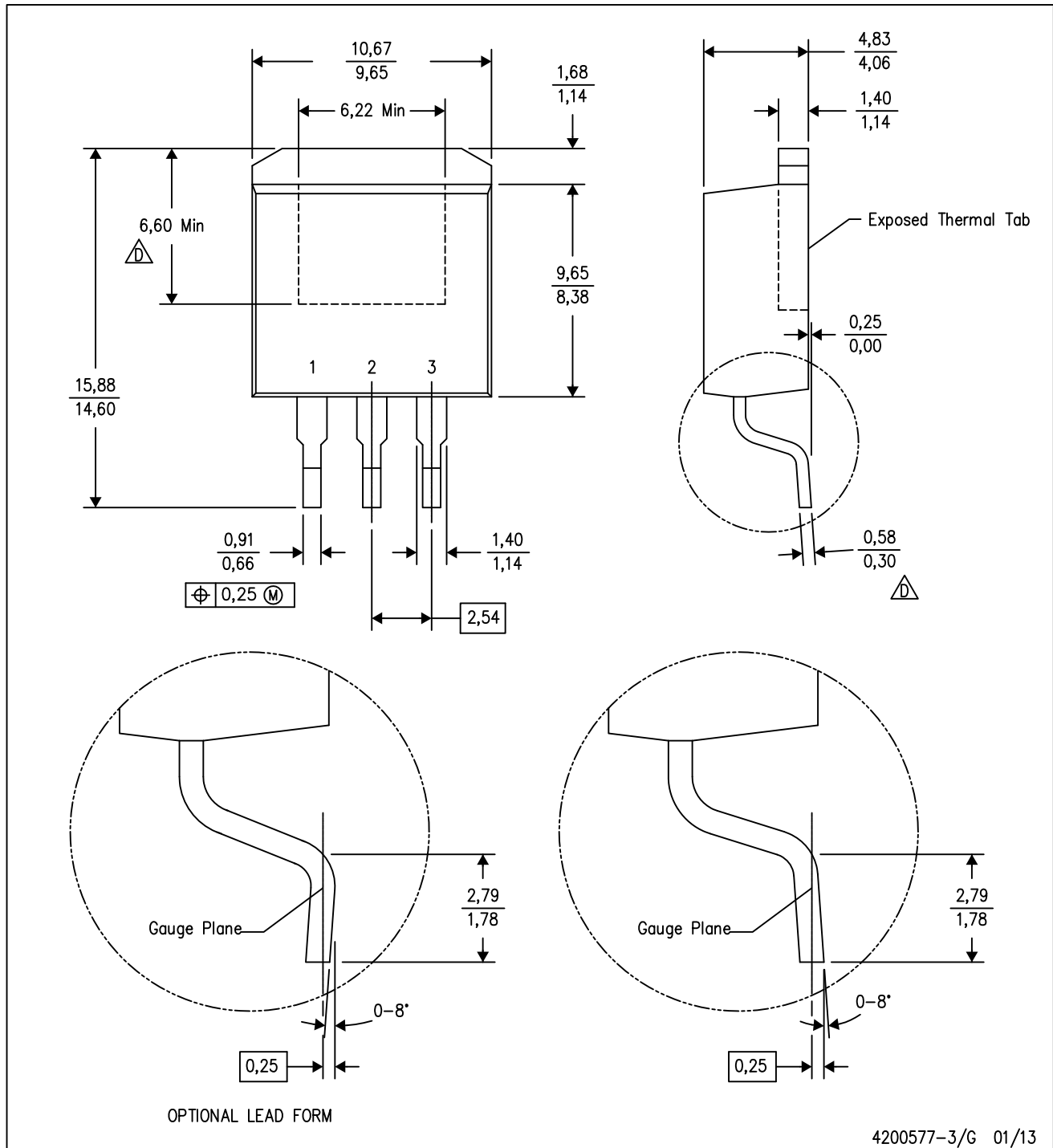

- NOTES:
- A. All linear dimensions are in millimeters.
  - B. This drawing is subject to change without notice.
  - C. Body dimensions do not include mold flash or protrusion. Mold flash or protrusion not to exceed 0.005 (0,13) per side.
- △ Falls within JEDEC TO-263 variation AA, except minimum lead thickness and minimum exposed pad length.

KTT (R-PSFM-G3)

PLASTIC FLANGE-MOUNT PACKAGE

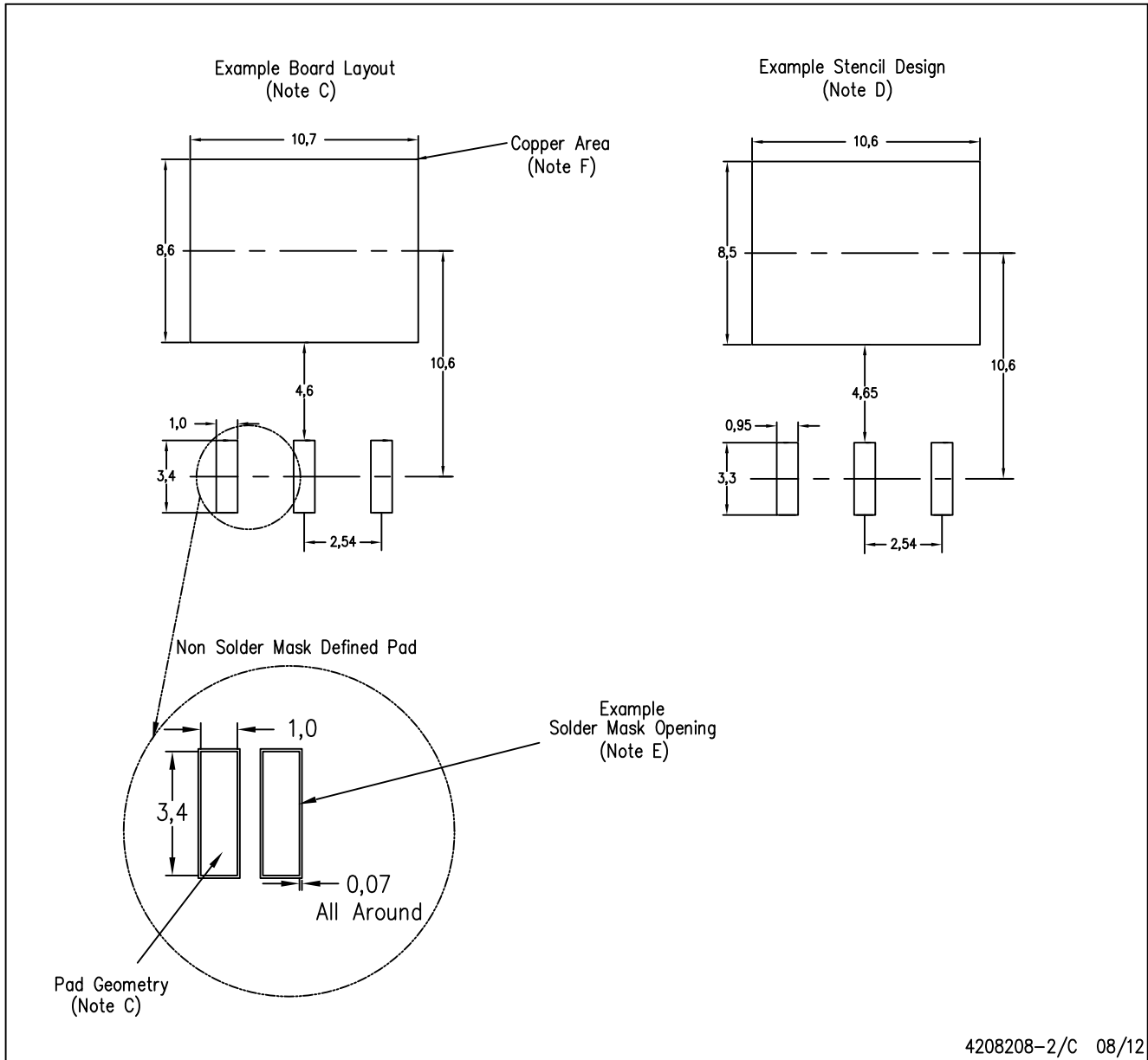

4208208-2/C 08/12

- NOTES:
- All linear dimensions are in millimeters.
  - This drawing is subject to change without notice.
  - Publication IPC-SM-782 is recommended for alternate designs.
  - Laser cutting apertures with trapezoidal walls and also rounding corners will offer better paste release. Customers should contact their board assembly site for stencil design recommendations. Refer to IPC-7525.
  - Customers should contact their board fabrication site for solder mask tolerances between and around signal pads.
  - This package is designed to be soldered to a thermal pad on the board. Refer to the Product Datasheet for specific thermal information, via requirements, and recommended thermal pad size. For thermal pad sizes larger than shown a solder mask defined pad is recommended in order to maintain the solderable pad geometry while increasing copper area.

## IMPORTANT NOTICE AND DISCLAIMER

TI PROVIDES TECHNICAL AND RELIABILITY DATA (INCLUDING DATA SHEETS), DESIGN RESOURCES (INCLUDING REFERENCE DESIGNS), APPLICATION OR OTHER DESIGN ADVICE, WEB TOOLS, SAFETY INFORMATION, AND OTHER RESOURCES "AS IS" AND WITH ALL FAULTS, AND DISCLAIMS ALL WARRANTIES, EXPRESS AND IMPLIED, INCLUDING WITHOUT LIMITATION ANY IMPLIED WARRANTIES OF MERCHANTABILITY, FITNESS FOR A PARTICULAR PURPOSE OR NON-INFRINGEMENT OF THIRD PARTY INTELLECTUAL PROPERTY RIGHTS.

These resources are intended for skilled developers designing with TI products. You are solely responsible for (1) selecting the appropriate TI products for your application, (2) designing, validating and testing your application, and (3) ensuring your application meets applicable standards, and any other safety, security, regulatory or other requirements.

These resources are subject to change without notice. TI grants you permission to use these resources only for development of an application that uses the TI products described in the resource. Other reproduction and display of these resources is prohibited. No license is granted to any other TI intellectual property right or to any third party intellectual property right. TI disclaims responsibility for, and you will fully indemnify TI and its representatives against, any claims, damages, costs, losses, and liabilities arising out of your use of these resources.

TI's products are provided subject to [TI's Terms of Sale](#) or other applicable terms available either on [ti.com](https://www.ti.com) or provided in conjunction with such TI products. TI's provision of these resources does not expand or otherwise alter TI's applicable warranties or warranty disclaimers for TI products.

TI objects to and rejects any additional or different terms you may have proposed.

Mailing Address: Texas Instruments, Post Office Box 655303, Dallas, Texas 75265  
Copyright © 2024, Texas Instruments Incorporated